



REGULATOR

00 Series.....	P1
01 Series.....	P2-10
02 Series.....	P11-14
03 Series.....	P15-27
04 Series.....	P28-44
05 Series.....	P45-55
06 Series.....	P56-72
07 Series.....	P73-75
08 Series.....	P76-86
09 Series.....	P87
10/11/12 Series.....	P88-90
14 Series.....	P91-92

RECTIFIER

BHP Series	P 93-122
DC Series	P123-131
FD Series.....	P132-135
HI Series.....	P136-161
ISK Series	P162-163
LA Series.....	P164-166
ZLB Series	P167-168
LUS Series	P169-171
MG Series	P172-178
MIA/MIP Series.....	P179-214
MOP Series	P215-217
NPD Series.....	P218-231
VAL Series	P232-250

DIODE

DIODES Series	P251-260
---------------------	----------

PLASTIC PARTS

BRUSH HOLDERS	P261-263
CAPACITORS	P264-265
PLASTIC COVERS.....	P266-270
TERMINAL BLOCKS	P271-273

Catalog#	Page	Catalog#	Page	Catalog#	Page	Catalog#	Page	Catalog#	Page
00-001	1	01-057	9	03-029	17	03-058	22	04-014	29
00-002	1	01-058	9	03-016	17	03-059	23	04-015	30
00-003	1	01-059	9	03-016S	17	03-059S	23	04-020	30
00-005	1	01-060	9	03-017	17	03-060	23	04-022	30
01-001	2	01-061	9	03-017S	17	03-064	23	04-023	30
01-002	2	01-062	10	03-018	17	03-065	23	04-064	30
01-004	2	01-063	10	03-018S	17	03-066	23	04-024	30
01-015	2	01-064	10	03-019	17	03-068	24	04-025	31
01-005	2	01-066	10	03-021	18	03-069	24	04-026	31
01-007	2	02-001	11	03-021S	18	03-073	24	04-027	31
01-008	2	02-002	11	03-022	18	03-074	24	04-028	31
01-010	3	02-003	11	03-0091	18	03-076	24	04-031	31
01-011	3	02-004	11	03-023	18	03-076S	24	04-035	32
01-022	3	02-005	11	03-061	18	03-077	25	04-039	32
01-030	3	02-006	12	03-024	18	03-077S	25	04-042	32
01-013	3	02-007	12	03-025	18	03-079	25	04-043	32
01-014	3	02-008	12	03-027	19	03-010	25	04-045	32
01-016	3	02-009	12	03-027S	19	03-046	25	04-048	33
01-018	4	02-010	12	03-028	19	03-080	25	04-066	33
01-019	4	02-011	13	03-028S	19	03-026	25	04-051	33
01-020	4	02-012	13	03-030	19	03-020	25	04-053	33
01-021	4	02-013	13	03-032	19	03-081	25	04-063	33
01-023	4	02-014	13	03-031	19	03-082	25	04-054	33
01-048	4	02-016	13	03-033	19	03-083	26	04-055	33
01-025	5	02-017	14	03-034	20	03-084	26	04-056	33
01-026	5	02-018	14	03-034S	20	03-085	26	04-057	34
01-027	5	03-001	15	03-035	20	03-088	26	04-058	34
01-031	5	03-004	15	03-035S	20	03-089	26	04-067	34
01-032	5	03-004S	15	03-036	20	03-090	27	04-069	34
01-033	6	03-005	15	03-038	20	03-091	27	04-071	34
01-034	6	03-047	15	03-038S	20	03-092	27	04-072	35
01-037	6	03-007	15	03-039	20	03-094	27	04-078	35
01-038	6	03-054	15	03-037	20	04-001	28	04-080	35
01-039	6	03-008	15	03-040	21	04-110	28	04-034	35
01-042	7	03-008S	15	03-041	21	04-002	28	04-081	35
01-046	7	03-009	16	03-042	21	04-003	28	04-082	36
01-047	7	03-011	16	03-044	21	04-041	28	04-104	36
01-049	7	03-055	16	03-043	21	04-006	28	04-084	36
01-050	7	03-012	16	03-045	21	04-008	29	04-083	36
01-051	8	03-012S	16	03-048	22	04-009	29	04-085A	36
01-052	8	03-013	16	03-051	22	04-052	29	04-0851	36
01-053	8	03-056	16	03-052	22	04-010	29	04-086	37
01-054	8	03-014	16	03-052S	22	04-032	29	04-087	37
01-055	8	03-015	17	03-053	22	04-011	29	04-088	37

Catalog# Page	Catalog# Page	Catalog# Page	Catalog# Page	Catalog# Page
04-095.....37	05-004.....45	05-060.....51	06-031.....59	06-088.....66
04-089.....37	05-007.....45	05-063.....52	06-032.....59	06-090.....67
04-092.....37	05-032.....45	05-065.....52	06-034.....60	06-092.....67
04-096.....38	05-008.....46	05-066.....52	06-035.....60	06-093.....67
04-109.....38	05-059.....46	05-076.....52	06-036.....60	06-095.....67
04-097.....38	05-009.....46	05-083.....52	06-037.....60	06-096.....67
04-099.....38	05-089.....46	05-084.....53	06-039.....60	06-097.....68
04-100.....38	05-010.....46	05-088.....53	06-041.....61	06-098.....68
04-103.....38	05-048.....46	05-091.....53	06-043.....61	06-100.....68
04-106.....39	05-011.....46	05-095.....53	06-044.....61	06-101.....68
04-107.....39	05-056.....46	05-096.....53	06-046.....61	06-102.....68
04-108.....39	05-012.....46	05-097.....53	06-045.....61	06-107.....69
04-112.....39	05-044.....46	05-099.....54	06-049.....61	06-108.....69
04-114.....39	05-013.....47	05-100.....54	06-050.....62	06-109.....69
04-115.....40	05-014.....47	05-101.....54	06-063.....62	06-110.....69
04-116.....40	05-015.....47	05-103.....54	06-051.....62	06-111.....69
04-117.....40	05-047.....47	05-107.....54	06-052.....62	06-112.....70
04-118.....40	05-016.....47	05-109.....55	06-053.....62	06-113.....70
04-119.....40	05-042.....47	05-110.....55	06-055.....62	06-114.....70
04-121.....41	05-017.....47	05-111.....55	06-056.....63	06-115.....70
04-122.....41	05-020.....48	05-112.....55	06-059.....63	06-116.....70
04-124.....41	05-021.....48	05-113.....55	06-060.....63	06-117.....71
04-125.....41	05-023.....48	06-001.....56	06-089.....63	06-118.....71
04-126.....41	05-022.....48	06-002.....56	06-065.....63	06-119.....71
04-128.....42	05-025.....48	06-003.....56	06-066.....63	06-120.....71
04-130.....42	05-018.....48	06-004.....56	06-067.....64	06-121.....71
04-131.....42	05-026.....49	06-006.....56	06-068.....64	06-122.....72
04-133.....42	05-027.....49	06-008.....57	06-069.....64	06-125.....72
04-134.....42	05-034.....49	06-009.....57	06-070.....64	06-134.....72
04-136.....43	05-028.....49	06-064.....57	06-079.....64	07-001.....73
04-140.....43	05-067.....49	06-011.....57	06-072.....64	07-005.....73
04-141.....43	05-030.....49	06-013.....57	06-073.....65	07-006.....73
04-142.....43	05-035.....49	06-105.....57	06-074.....65	07-014.....73
04-143.....43	05-036.....50	06-014.....57	06-075.....65	07-023.....73
04-144.....44	05-037.....50	06-016.....58	06-078.....65	07-015.....73
04-145.....44	05-043.....50	06-018.....58	06-084.....65	07-017.....74
04-146.....44	05-040.....50	06-019.....58	06-080.....65	07-017S.....74
04-147.....44	05-041.....50	06-026.....58	06-081.....66	07-019.....74
04-150.....44	05-046.....50	06-020.....58	06-082.....66	07-020.....74
05-001.....45	05-052.....51	06-027.....58	06-094.....66	07-020S.....74
05-002.....45	05-053.....51	06-028.....59	06-103.....66	07-021.....74
05-003.....45	05-054.....51	06-029.....59	06-085.....66	07-022.....74
05-024.....45	05-055.....51	06-030.....59	06-086.....66	07-024.....75

Catalog#	Page	Catalog#	Page	Catalog#	Page	Catalog#	Page	Catalog#	Page
07-027	75	08-048	82	12-010	89	BHP11201	093	BHP12220	098
07-032	75	08-049	82	12-011	90	BHP11203	093	BHP12220-1	098
07-029	75	08-051	83	12-012	90	BHP11204	093	BHP12226	098
07-034	75	08-052	83	12-016	90	BHP11202B	093	BHP12228A	099
07-034S	75	08-053	83	14-001	91	BHP11202	093	BHP9001	099
07-037	75	08-054	83	14-002	91	BHP11205	093	BHP9002	099
08-001	76	08-055	83	14-003	91	BHP11205-2	093	BHP9003	099
08-004	76	08-057	84	14-004	91	BHP11206	093	BHP9005	099
08-006	76	08-058	84	14-006	91	BHP11206-1	093	BHP9006	100
08-007	76	08-060	84	14-010	92	BHP11207	093	BHP11401	100
08-008	76	08-061	84	14-015	92	BHP11209	094	BHP11401HD	100
08-009	77	08-063	84	14-016	92	BHP11209-1	094	BHP11402	100
08-010	77	08-064	85			BHP11210B	094	BHP11402HD	100
08-012	77	08-065	85			BHP11211	094	BHP11409	100
08-037	77	08-066	85			BHP11211-1	094	BHP11409HD	100
08-014	77	08-068	85			BHP11213	094	BHP11403	100
08-015	77	08-069	85			BHP11214	094	BHP11403HD	100
08-016	78	08-070	86			BHP11215	095	BHP11403B	100
08-017	78	08-073	86			BHP11215-1	095	BHP11404	100
08-028	78	08-074	86			BHP12201	095	BHP11404HD	100
08-018	78	08-075	86			BHP12201-1	095	BHP11406	101
08-019	78	08-076	86			BHP12201B	095	BHP11406HD	101
08-020	78	09-001	87			BHP12202	095	BHP11411	101
08-021	79	09-009	87			BHP12202-1	095	BHP11411HD	101
08-022	79	09-002	87			BHP12204	095	BHP11412	101
08-023	79	09-003	87			BHP12205	095	BHP11412HD	101
08-024	79	09-012	87			BHP12206	096	BHP11431	101
08-025	79	09-019	87			BHP12207	096	BHP11413	101
08-026	80	09-013	87			BHP12208	096	BHP11413HD	101
08-027	80	09-020	87			BHP12208B	096	BHP11413A	101
08-034	80	09-007	87			BHP12208-1	096	BHP11414	101
08-031	80	10-001	88			BHP12208B-1	096	BHP11414HD	101
08-032	80	10-003	88			BHP12209	096	BHP11415	102
08-033	80	11-001	88			BHP12210	097	BHP11415HD	102
08-035	81	11-002	88			BHP12211B	097	BHP11416	102
08-036	81	12-001	88			BHP12212	097	BHP11416HD	102
08-042	81	12-002	89			BHP12213B	097	BHP11416A	102
08-038	81	12-003	89			BHP12215	097	BHP11417	102
08-039	81	12-008	89			BHP12215B	097	BHP11417HD	102
08-040	81	12-009	89			BHP12216	098	BHP11418	102
08-043	82	12-005	89			BHP12216-1	098	BHP11418HD	102
08-044	82	12-006	89			BHP12218	098	BHP11419	102
08-045	82	12-007	89			BHP12219	098	BHP11419HD	102

Catalog# Page	Catalog# Page	Catalog# Page	Catalog# Page	Catalog# Page
BHP11420.....103	BHP12504.....108	BHP12030.....113	BHP12076.....118	DCE1004.....125
BHP11420HD...103	BHP12504A.....108	BHP12030HD...113	BHP12080HD...118	DC5070.....125
BHP11421.....103	BHP12505B.....108	BHP12031.....113	BHP12081A.....119	DC5072.....125
BHP11421HD...103	BHP12506.....108	BHP12067.....113	BHP12083HD...119	DC5075.....125
BHP11421A.....103	BHP12509.....109	BHP120109.....113	BHP12086.....119	DC5185.....125
BHP11422.....103	BHP12510.....109	BHP12032.....113	BHP12094.....119	DC5185HD.....125
BHP11422HD...103	BHP12511.....109	BHP12033.....113	BHP12095.....119	DC5185-1.....125
BHP11424.....103	BHP12511A.....109	BHP12034.....114	BHP12099.....120	DC5170.....126
BHP11424HD...103	BHP12511B.....109	BHP12052.....114	BHP120100.....120	DC5172.....126
BHP11425.....103	BHP12517.....109	BHP12035HD...114	BHP120133A.....120	DC5190.....126
BHP11426A.....104	BHP12519.....109	BHP12036B.....114	BHP120101B...120	DC5191.....126
BHP11426.....104	BHP14501.....110	BHP12036BHD...114	BHP120120B...120	DC5192.....126
BHP11426-1...104	BHP14501B.....110	BHP12037.....114	BHP120135A...120	DC5193.....126
BHP11426-2...104	BHP14502.....110	BHP12040.....114	BHP120136A...121	DC5184.....126
BHP11426A-1...104	BHP14502B.....110	BHP12038B.....114	BHP120137A...121	DC5184-1.....126
BHP11427.....104	BHP14507.....110	BHP12039B.....114	BHP120104HD...121	DC5184HD.....126
BHP11427A.....104	BHP14507B.....110	BHP12041.....115	BHP12801.....121	DC5085.....126
BHP11428A.....104	BHP14508A1...110	BHP12077.....115	BHP12804.....121	DC5180.....126
BHP11432A.....104	BHP12015.....110	BHP12042.....115	BHP12805.....122	DC5181.....127
BHP11430A.....104	BHP12016B.....111	BHP12043.....115	BHP12806.....122	DC5181B.....127
BHP11433A.....104	BHP12069B.....111	BHP12075.....115	BHP12807.....122	DC5181AP.....127
BHP11446.....104	BHP12017.....111	BHP12044HD...115	BHP12811.....122	DC5181AHDP...127
BHP11435.....105	BHP12027.....111	BHP12046HD...115	BHP12815A.....122	DC5181BP.....127
BHP11440.....105	BHP12048.....111	BHP12051HD...115	DC5164.....123	DC5181BHDP...127
BHP11445A.....105	BHP12019.....111	BHP12053.....116	DC5163.....123	DC5182.....127
BHP121001.....105	BHP12019-1...111	BHP12055.....116	DC5302.....123	DC5183.....127
BHP121002.....105	BHP12019B.....111	BHP12066.....116	DC5301.....123	DC5187.....127
BHP121004.....106	BHP12020.....111	BHP12056.....116	DC5164D.....123	DC5188.....127
BHP121005.....106	BHP12020B.....111	BHP12054HD...116	DC5163D.....123	DC5188B.....127
BHP121006.....106	BHP12021.....111	BHP12057.....116	DC5302D.....123	DC5189.....127
BHP121015.....106	BHP12024.....111	BHP12059.....116	DC5301D.....123	DC5187P.....128
BHP121007.....106	BHP12022.....112	BHP12062.....117	DC5164-2D.....123	DC5281P.....128
BHP121008.....106	BHP12022HD...112	BHP12060B.....117	DC5263D.....031	DC1101.....128
BHP121009.....107	BHP12023.....112	BHP12063.....117	DC5300.....124	DC1105.....128
BHP121010.....107	BHP12025.....112	BHP120103.....117	DC5304.....124	DC1102.....128
BHP121011.....107	BHP12025B.....112	BHP12064HD...117	DCE5170.....124	DC1122A.....128
BHP121012.....107	BHP12025-1...112	BHP12064B.....117	DCE5173.....124	DC1103.....129
BHP121013.....107	BHP12049HD...112	BHP12065HD...117	DCE5171.....124	DC1124A.....129
BHP121013A...107	BHP12025-2...112	BHP12070.....117	DCE5177.....124	DC1670.....129
BHP121013B...107	BHP12047HD...112	BHP12072.....118	DCE5175.....124	DC1867.....129
BHP12501.....108	BHP12026HD...113	BHP12073.....118	DCE5179.....125	DC4100.....129
BHP12501-1.....108	BHP12026B.....113	BHP12073HD...118	DCE5178.....125	DC4108.....130
BHP12503.....108	BHP12092B...113	BHP12074.....118	DCE1003.....125	DC9410.....130

Catalog# Page	Catalog# Page	Catalog# Page	Catalog# Page	Catalog# Page
DC9411.....130	HI10002Fg.....137	HI13201.....142	HI11407A-161...147	HI11302A-1ZT...153
DC6100.....130	HI10003F.....137	HI10301.....142	HI11408.....148	HI11303AZT...153
DC6100HD.....130	HI10003Fg.....137	HI10302.....143	HI11408A.....148	HI11303AZT-2..153
DC6101.....130	HI10004F.....137	HI10303.....143	HI11409.....148	HI11305AZT...153
DC6102.....130	HI10004Fg.....137	HI10304.....143	HI11409A.....148	HI11305AZT-1..153
DC6103.....130	HI10013FE.....137	HI10305.....143	HI11416.....148	HI11305AZT-2..153
DC6103HD.....130	HI10014FE.....137	HI10306.....143	HI11410.....148	HI11306ZT.....154
DC6104.....131	HI10015.....137	HI10310.....143	HI11410A.....148	HI11307ZT.....154
DC6104B.....131	HI11101F.....138	HI10307.....144	HI11419.....148	HI11308BZT...154
DC6106.....131	HI11101Fg.....138	HI10308.....144	HI11411.....148	HI11308BZT-1..154
DC6109A.....131	HI11101.....138	HI10309.....144	HI11412.....148	HI11308B-1ZT..154
DC6111A.....131	HI11102F.....138	HI10311.....144	HI11412A.....148	HI11311BZT...154
DC6112A.....131	HI11102Fg.....138	HI11301A.....144	HI11413.....149	HI11312ZT.....154
FD1001.....132	HI11103F.....138	HI11301.....144	HI11414.....149	HI11312-2ZT...154
FD1002.....132	HI11103Fg.....138	HI11302.....144	HI11417.....149	HI11313AZT...154
FD1002HD.....132	HI11104F.....138	HI11302A.....144	HI11417-1.....149	HI11314AZT...155
FD1004.....132	HI11104Fg.....138	HI11302B.....144	HI11418A.....149	HI11315AZT...155
FD1004HD.....132	HI11105F.....138	HI11303A.....145	HI11418A-1.....149	HI11315A-1ZT..155
FD1005.....132	HI11105Fg.....138	HI11304A.....145	HI11420.....150	HI11318AZT...155
FD1005HD.....132	HI11106F.....139	HI11305A.....145	HI11421.....150	HI11318A-1ZT...155
FD1007.....132	HI11106Fg.....139	HI11306.....145	HI11422.....150	HI11318BZT...155
FD2001.....133	HI11106.....139	HI11307.....145	HI11423.....150	HI11321AZT...155
FD2001HD.....133	HI11107F.....139	HI11308B.....145	HI11423-1.....150	HI11322AZT...155
FD2004.....133	HI11107Fg.....139	HI11315A.....146	HI11423-2.....150	HI11322AZT-1...155
FD3001DW.....133	HI11108F.....139	HI11315A-1...146	HI11424.....150	HI11323AZT...156
FD3002DW.....133	HI11108Fg.....139	HI11318A.....146	HI10304ZT.....150	HI11324AZT...156
FD4001DW.....133	HI11116.....139	HI11318A-1...146	HI10310ZT.....151	HI11330AZT...156
FD6000DW.....134	HI11124F.....139	HI11318B.....146	HI111ZT21135F..151	HI11332ZT...156
FD6001DW.....134	HI11128F.....140	HI11322A.....146	HI111ZT31135F.151	HI114ZT.....156
FD6002DW.....134	HI11129F.....140	HI11323A.....146	HI111ZTN31135F.151	HI114ZT-1.....156
FD6011DW.....134	HI11130F.....140	HI11401.....146	HI111ZT41135F..151	HI11401ZT.....157
FD6012DW.....134	HI11139F.....140	HI11401A.....146	HI11116ZT.....152	HI11401AZT...157
FD61001A.....135	HI11801F.....140	HI11402.....147	HI11116ZT-1...152	HI11402ZT.....157
FD61002A.....135	HI11802F.....140	HI11403.....147	HI11116ZT-2...152	HI11402-3ZT...157
FD61003A.....135	HI11803F.....141	HI11403A.....147	HI112ZT21135C.152	HI11403ZT.....157
FD61004A.....135	HI11803.....141	HI11405.....147	HI113ZT12835F.152	HI11403AZT...157
HIF5001.....136	HI11804F.....141	HI11405A.....147	HI113ZT22835F.152	HI11403AZT-1...157
HIF5002.....136	HI11805F.....141	HI11405-1.....147	HI113ZT32835F.152	HI11405ZT.....157
HIF5003.....136	HI11806F.....141	HI11406.....147	HI11301AZT...153	HI11405AZT...157
HIF5004.....136	HI11810F.....141	HI11406A.....147	HI11301ZT.....153	HI11405A-3ZT...157
HI10001F.....136	HI12601.....142	HI11407.....147	HI11316AZT...153	HI11406ZT.....157
HI10001Fg.....136	HI12602.....142	HI11407-1.....147	HI11317AZT...153	HI11406AZT...157
HI10002F.....137	HI12603.....142	HI11407A.....147	HI11302BZT...153	HI11407AZT...158

Catalog# Page	Catalog# Page	Catalog# Page	Catalog# Page	Catalog# Page
HI11407A-1ZT···158	LA1139·····166	MG6318·····175	MIA7523·····184	MIA8514·····191
HI11408ZT·····158	ZLB-07·····167	MG6319·····175	MIA7524·····184	MIA8530·····191
HI11408AZT···158	ZLB-08·····167	MG6401·····175	MIA7525·····184	MIA8515·····192
HI11409ZT·····158	ZLB-09·····167	MG6402·····175	MIA7526·····184	MIA8517·····192
HI11409AZT···158	ZLB-10·····167	MG6403·····176	MIA7527·····185	MIA8516·····192
HI11410ZT·····158	ZLB-11·····167	MG6405·····176	MIA7529·····185	MIA8547·····192
HI11410AZT···158	ZLB-12·····168	MG6901·····176	MIA7530·····185	MIA8518·····192
HI11410AZT-2···158	ZLB-17·····168	MG6902·····176	MIA7531·····185	MIA8519·····192
HI11411ZT·····158	ZLB-18·····168	MG6903·····176	MIA7532·····185	MIA8521·····192
HI11416ZT·····158	ZLB-19N·····168	MG6903-1·····176	MIA7533·····186	MIA8525·····192
HI11412ZT·····159	ZLB-19P·····168	MG6904·····177	MIA7535·····186	MIA8526·····193
HI11412-1ZT···159	LUS1101·····169	MG6905·····177	MIA7536·····186	MIA8520·····193
HI11413ZT·····159	LUS1101HD·····169	MG6906·····177	MIA7537·····186	MIA8527·····193
HI11414ZT·····159	LUS1102·····169	MG6907·····177	MIA7538·····186	MIA8528·····193
HI11417ZT·····159	LUS1103·····169	MG6908·····177	MIA7540·····187	MIA8529·····193
HI11417-1ZT···159	LUS133·····169	MG6911·····178	MIA7542·····187	MIA8531·····193
HI11418AZT···159	LUS136·····169	MIA6501·····179	MIA7543·····187	MIA8532·····194
HI11423-1ZT···160	LUS137·····170	MIA6502·····179	MIA7544·····187	MIA8533·····194
HI11423-2ZT···160	LUS140·····170	MIA6503·····179	MIA7545·····187	MIA8537·····194
HI11424ZT·····160	LUS143·····170	MIA6504·····179	MIA7546·····188	MIA8538·····194
HI11427AZT···160	LUS145·····170	MIA6506·····179	MIA7549·····188	MIA8534·····194
HI11430AZT···160	LUS147·····170	MIA7501·····180	MIA7550·····188	MIA8535·····194
HI132ZT·····160	LUS148·····171	MIA7502·····180	MIA7552·····188	MIA8536·····194
HI12001·····161	LUS149·····171	MIA7503·····180	MIA7553·····188	MIA8539·····195
ISK001·····162	LUS152·····171	MIA7504·····180	MIA7555·····189	MIA8540·····195
ISK002·····162	LUS1301A·····171	MIA7505·····180	MIA7557·····189	MIA8541·····195
ISK006·····162	MG6301·····172	MIA7506·····181	MIA7559·····189	MIA8542·····195
ISK003·····162	MG6302·····172	MIA7507·····181	MIA7560·····189	MIA8544·····195
ISK004B·····162	MG6303·····172	MIA7511·····181	MIA7601·····189	MIA8545·····196
ISK005·····162	MG6304·····172	MIA7508·····181	MIA7602·····188	MIA8546·····196
ISK007·····163	MG6305·····172	MIA7509·····181	MIA8501·····190	MIA8549·····196
ISK008·····163	MG6306·····172	MIA7510·····181	MIA8502·····190	MIA8551·····196
LA1102·····164	MG6307·····173	MIA7512·····182	MIA8512·····190	MIA8552·····196
LA1104·····164	MG6309·····173	MIA7513·····182	MIA8503·····190	MIA8553·····197
LA1103·····164	MG6310·····173	MIA7514·····182	MIA8511·····190	MIA8554·····197
LA1107·····164	MG6311·····173	MIA7515·····182	MIA8505·····190	MIA8555·····197
LA1107-1·····164	MG6312·····173	MIA7516·····182	MIA8506·····191	MIA8556·····197
LA1107-2·····164	MG6313·····174	MIA7517·····183	MIA8507·····191	MIA8558·····197
LA1114·····165	MG6314·····174	MIA7518·····183	MIA8524·····191	MIA8559·····198
LA1115·····165	MG6316·····174	MIA7519·····183	MIA8508·····191	MIA8564·····198
LA1125·····165	MG6322A·····174	MIA7520·····183	MIA8509·····191	MIA8565·····198
LA1128B·····165	MG6324A·····174	MIA7521·····183	MIA8510·····191	MIA8567·····198
LA1130·····165	MG6317·····175	MIA7522·····184	MIA8513·····191	MIA8568·····198

Catalog# Page	Catalog# Page	Catalog# Page	Catalog# Page	Catalog# Page
MIA8569.....198	MIA10036.....204	MIP8003L.....211	NPD10002L.....219	NPD11406L.....226
MIA8570A.....199	MIA10046.....204	MIP8003.....211	NPD10003.....220	NPD11406.....226
MIA8571.....199	MIA10037.....205	MIP8004L.....212	NPD10004.....220	NPD11406-1.....226
MIA8572.....199	MIA10039.....205	MIP8004.....212	NPD10005.....220	NPD11406L-1.....226
MIA8574.....199	MIA10049.....205	MIP8005L.....212	NPD10004L.....220	NPD11412.....226
MIA8575.....199	MIA10041.....205	MIP8005.....212	NPD10006.....220	NPD11407L.....226
MIA9001.....199	MIA10042.....205	MIP8007L.....212	NPD10007.....220	NPD11407.....226
MIA9002.....199	MIA10043.....205	MIP8007.....212	NPD10301.....221	NPD11407-1.....226
MIA9006.....199	MIA10044.....206	MIP8008L.....212	NPD10301L.....221	NPD11408.....226
MIA9008.....199	MIA10045.....206	MIP8008.....212	NPD10302.....221	NPD11410.....227
MIA10001.....200	MIA10048.....206	MIP8501.....212	NPD10308.....221	NPD11411.....227
MIA10002.....200	MIA10050.....206	MIP8502.....213	NPD10311.....221	NPD11419.....227
MIA10003.....200	MIA10054.....206	MIP8503.....213	NPD10302L.....221	NPD11501A.....227
MIA10004.....200	MIA10051.....206	MIP8504.....213	NPD10303.....221	NPD11502A.....227
MIA10075.....200	MIA10052.....206	MIP8505.....213	NPD10303L.....222	NPD11701AL.....228
MIA10005.....200	MIA10053.....207	MIP8506.....213	NPD10304.....222	NPD11702AL.....228
MIA10006.....200	MIA10062.....207	MIP10001.....214	NPD10304L.....222	NPD11703AL.....228
MIA10007.....201	MIA10063.....207	MIP10002.....214	NPD10304L-1.....222	NPD11722AL.....228
MIA10008.....201	MIA10065.....207	MIP10003.....214	NPD10305.....222	NPD11705AL.....228
MIA10038.....201	MIA10067.....207	MID751ZT.....214	NPD10305Ag.....222	NPD11706AL.....228
MIA10009.....201	MIA10071.....208	MOP3005.....215	NPD10305L.....222	NPD11707A.....229
MIA10012.....201	MIA10074.....208	MOP3006.....215	NPD10305L-3.....222	NPD11708A.....229
MIA10010.....201	MIA10076.....208	MOP3006A.....215	NPD10306.....223	NPD11708AL.....229
MIA10011.....201	MIA10078.....208	MOP3006B.....215	NPD10306L.....223	NPD11711AL.....229
MIA10013.....202	MIA10080A.....208	MOP3010B.....215	NPD11301.....223	NPD11709AL.....229
MIA10016.....202	MIA10082.....209	MOP6001.....215	NPD11302.....223	NPD11710AL.....229
MIA10014.....202	MIA10083A.....209	MOP6004.....215	NPD11311.....223	NPD11712AL.....229
MIA10015.....202	MIA10084A.....209	MOP6041.....216	NPD11302L.....223	NPD11717L.....230
MIA10017.....202	MIA10086.....209	MOP6064.....216	NPD11303.....224	NPD11720AL.....230
MIA10018.....202	MIA10087.....209	MOP6065.....216	NPD11303L.....224	NPD11735AL.....230
MIA10021.....202	MIA12101.....210	MOP6072.....216	NPD11305.....224	NPD11736AL.....230
MIA10020.....203	MIA12102A.....210	MOP6300.....216	NPD11305L.....224	NPD13002.....230
MIA10030.....203	MIA12103A.....210	MOP6301.....217	NPD11306.....224	NPD13401A.....231
MIA10023.....203	MIP7001.....210	NPD8301.....218	NPD11312.....224	NPD13801.....231
MIA10025.....203	MIP7002.....210	NPD8303g.....218	NPD11306L.....225	NPD13801B-1.....231
MIA10028.....203	MIP7103F.....210	NPD8701.....218	NPD11308.....225	VAL840.....232
MIA10029.....203	MIP7101F.....210	NPD8702.....218	NPD11308L.....225	VAL841.....232
MIA10047.....203	MIP7104F.....211	NPD9001.....218	NPD11310.....225	VAL842.....232
MIA10031.....204	MIP7107F.....211	NPD9002.....219	NPD11401L.....225	VAL844.....232
MIA10032.....204	MIP8001L.....211	NPD10001.....219	NPD11401.....225	VAL845.....232
MIA10033.....204	MIP8001.....211	NPD10001F.....219	NPD11414L.....225	VAL856.....232
MIA10034.....204	MIP8002L.....211	NPD10001L.....219	NPD11402.....226	VAL846.....232
MIA10035.....204	MIP8002.....211	NPD10002.....219	NPD11404.....226	VAL846-1.....232

Catalog#	Page	Catalog#	Page	Catalog#	Page	Catalog#	Page	Catalog#	Page
VAL847	232	VAL9072A	239	VAL9063A	247	7430	251	8442-1B	255
VAL850	232	VAL9078A	239	VAL927	248	7430A	251	8440-2B	255
VAL848	232	VAL9079A	239	VAL928	248	7431	251	8442-2B	255
VAL852	130	VAL205H	239	VAL9023A	248	7431A	251	8440B	255
VAL855	233	VAL205	240	VAL9016A	248	7432	251	8442B	255
VAL852-1	233	VAL206H	240	VAL9029A	248	7433	251	8442C	255
VAL853	233	VAL206	240	VAL9049A	249	7650	251	8446B	255
VAL853-2	233	VAL206A	240	VAL9074A	249	7651	251	8446C	255
VAL814	233	VAL208H	240	VAL9060AH	249	7652	251	8441-1B	256
VAL855-1	233	VAL208	241	VAL9066AH	249	7653	251	8443-1B	256
VAL855-2	233	VAL209-2	241	VAL9069A	249	DB8330	252	8441-2B	256
VAL857	233	VAL211	241	VAL9070A	250	DB8331	252	8443-2B	256
VAL857-1	233	VAL9040A	241			DB8334	252	8441B	256
VAL851	233	VAL212H	241			DB8335	252	8443B	256
VAL858B	233	VAL212	242			DB001	252	8443C	256
VAL815P	234	VAL213H	242			DB002	252	8447B	256
VAL816P	234	VAL213	242			DB003	252	8447C	256
VAL103	234	VAL9042A	242			DB004	252	8630-1B	256
VAL135	234	VAL214H	242			IN8010	252	8630-1C	256
VAL157	234	VAL9027A	243			IN8015	252	8632-1B	256
VAL252	235	VAL9058A	243			IN8025	252	8632-1C	256
VAL253	235	VAL9018H	243			IN8030	252	8632B	256
VAL537	235	VAL215-2	243			QZ2540	253	8632C	256
VAL538	235	VAL9024A	243			QZ2541	253	8631-1B	257
VAL539	235	VAL9050A	244			QZ5040	253	8631-1C	257
VAL551	236	VAL9077A	244			QZ5041	253	8633-1B	257
VAL552	236	VAL216	244			QZ7540	253	8633-1C	257
VAL615	236	VAL218H	244			QZ7541	253	8633B	257
VAL616	236	VAL218	244			DJ1001	253	8633C	257
VAL687	236	VAL220H	245			DJ524	253	QZ3520	257
VAL688	237	VAL223	245			DJ527	253	QZ3521	257
VAL204	237	VAL9045A	245			DJ528	253	QZ5020	257
VAL713	237	VAL225	245			DJ797	254	QZ5021	257
VAL773	237	VAL230	245			DJ985	254	S-15B	257
VAL813	237	VAL901	246			DT182	254	S-16B	257
VAL813-2	237	VAL902H	246			DT182-1	254	7700	257
VAL201H	237	VAL902-2	246			DT22	254	7701	257
VAL201	238	VAL903	246			LJ79026	254	7780-B	258
VAL202H	238	VAL905	246			LJ79027	254	7781-B	258
VAL9015A	238	VAL906-1	247			S5231	254	7770	258
VAL9021A	238	VAL9014A	247			SJ5231	255	7771	258
VAL9026A	238	VAL9041A	247			SJ5260	255	7800	258
VAL9032A	239	VAL9047A	247			8440-1B	256	7801	258

Catalog#	Page	Catalog#	Page	Catalog#	Page	Catalog#	Page	Catalog#	Page
7880	258	YD-T027	261	RJ025	265	C-036	269	T-017	273
7881	258	YD-T029	261	RJ026	265	C-037	269		
8624	258	YD-T030	261	RJ12015	266	C-038	269		
8625	258	B-001	261	RJ12016	266	C-039	269		
7770-1	258	B-002	262	RJ12017	266	C-045	269		
7771-1	258	B-003	262	RJ12019B	266	C-049	269		
7812	259	B-004	262	RJ12022	266	C-050	269		
7813	259	B-005	262	RJ408	266	C-051	269		
7814	259	B-006	262	RJ410	266	C-052	270		
7815	259	B-007	262	RJ546	266	YD-T001	271		
7900	259	B-008	262	1918	266	YD-T002	271		
7901	259	B-009	262	2564	266	YD-T003	271		
7902	259	B-010	262	2923	266	YD-T006	271		
7903	259	B-011	262	C-003	266	YD-T007	271		
7960	259	B-012	262	C-004	267	YD-T012	271		
7961	259	B-013	262	C-006	267	YD-T013	271		
7980	259	B-014	263	C-007	267	YD-T016	271		
7981	259	B-015	263	C-008	267	YD-T017	271		
BN354P	260	B-016	263	C-009	267	YD-T018	271		
BN354N	260	B-017	263	C-010	267	YD-T019	271		
BN35LP	260	B-032	263	C-011	267	YD-T021	271		
BN35LN	260	B-040	263	C-012	267	YD-T023	272		
BN35MP	260	B-046	263	C-013	267	YD-T026	272		
BN35MN	260	B-047	263	C-014	267	YD-T028	272		
BN35HP	260	B-048	263	C-015	267	YD-T032	272		
BN35HN	260	B-049	263	C-016	267	YD-T033	272		
BN504P	260	RJ001	263	C-017	268	RJ800	272		
BN504N	260	RJ002	263	C-018	268	RJ802	272		
BN50LP	260	RJ003	264	C-019	268	RJ808	272		
BN50LN	260	RJ004	264	C-020	268	RJ814	272		
BN50MP	260	RJ005	264	C-021	268	RJ844	272		
BN50MN	260	RJ006	264	C-022	268	T-001	272		
BN50HP	260	RJ007	264	C-023	268	T-002	272		
BN50HN	260	RJ008	264	C-024	268	T-003	273		
YD-T004	261	RJ009	264	C-025	268	T-005	273		
YD-T008	261	RJ010	264	C-026	268	T-006	273		
YD-T010	261	RJ011	264	C-029	268	T-007	273		
YD-T011	261	RJ012	264	C-030	268	A718-1	273		
YD-T014	261	RJ013	264	C-031	269	A1341	273		
YD-T015	261	RJ014	264	C-032	269	A1494	273		
YD-T022	261	RJ015	265	C-033	269	T-012	273		
YD-T025	261	RJ016	265	C-034	269	T-016	273		

00-001



FEATURES

A-Circuit
Voltage Set Point **14.60 V**

For use on : Ford, J.I. Case, Massey
Ferguson Tractors & other Lucas 21TR
Application

Original & X-References..

LUCAS			
37701	37703	37705	
37707	54048473	54048600	
54205986	54206177		
MOBILETRON		VR-LC111	
USI		71-00001	
WAI		35-9209	
CARGO		131277	
TRANSPO		IL223	

00-002

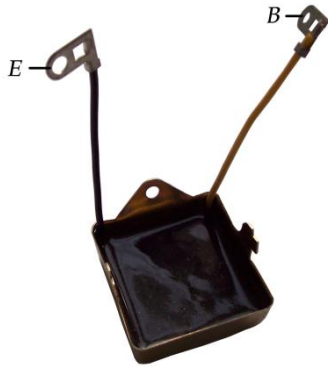

FEATURES

A-Circuit
Voltage Set Point **14.60V**

For use on : Case, Jaguar, Lotus
Massey Ferguson, MG

Original & X-References..

LUCAS			
37534	37538	37541	37555
37558	37561	37565	
MOBILETRON		VR-LC100	
WAI		35-9200	
TRANSPO		IL211	

00-003



FEATURES

A-Circuit
Voltage Set Point **28.50 V**

For use on : Ford Tractor JCB
Equipment Massey Ferguson

Original & X-References..

LUCAS			
37735		UCB 153	
28002		84959	
54022415		UCB155	
MOBILETRON		VR-LC111B	
WAI		35-9211	
CARGO		135231	
TRANSPO		IL225	

00-005



FEATUERS

A-Circuit
Voltage Set Point **14.50 V**

Original & X-References..



01-001

FEATURES **Original & X-References..**

A-Circuit	DELCO	276010
Voltage Set Point 14.60 V	MOBILETRON	VR-D276
	CARGO	139467
	DAEWOO	276010
	TRANSPO	D403

For use on: Daewoo Espero GM Satum
Lemans & Prince

01-004

FEATURES **Original & X-References..**

A-Circuit	DELCO	19009701
Voltage Set Point 14.80 V	10475019	10479914
	10479923	10479947
	10479955	1204270

01-015

Voltage Set Point 14.50 V	MOBILETRON	VR-D701
	USI	71-10022

01-002

Voltage Set Point 14.60 V	WAI	35-152
With RFI Capacitor	CARGO	135336
	TRANSPO	DE701



01-005

FEATURES **Original & X-References..**

B-Circuit	DELCO	
Voltage Set Point 14.40 V	1051-4474/4152	
Soft Start 30 %	860-0032/0096/0100/0151/0152	
Field Shorted Circuit Protection	/0164/0165/1661/0167/0168	
Under Voltage Indication	1902-0900/1901/0902	
Over Voltage Indication	LESTER 8701/2/3/4/5/6/7	
DFM Function	TRANSPO D4152	
Self Exciting Function		

For use on: Delco 24SI series

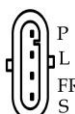

01-007

FEATURES **Original & X-References..**

B-Circuit	DELCO	19009705
Voltage Set Point 14.70 V	MOBILETRON	VR-D705H
Soft Start 30 % LRC 5 sec	UNIPOINT	YR-860
Field Shorted Circuit Protection	USI	71-10030
Under / Over Voltage Indication	WAI	35-137
DFM Function	CARGO	231184
	TRANSPO	D705

For use on: Buick Skylark, Chevrolet
Cavalier, Pontiac Grand-Am, Sunfire

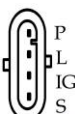

01-008

FEATURES **Original & X-References..**

B-Circuit	DELCO	19009702	13120469
Voltage Set Point 14.70 V		1116411	1116437
Soft Start 30 %		1116429	1116436
LRC 5 sec	USI		71-10044
Field Shorted Circuit Protection	TRANSPO		D702HD
Under Voltage Indication			
Over Voltage Indication			

01-036

Voltage Set Point **14.15 V**



01-010

FEATURES

A-Circuit
Voltage Set Point **14.10 V**
Field Shorted Circuit Protection
O.E. Grade

Original & X-References..

DELCO		
1116360	1116390	1116407
1116433	1116435	1116442
USI	71-10053	
WAI	35-126	35-126-2
TRANSP0	D21/D33	



01-011

FEATURES

A-Circuit
Voltage Set Point **28.10 V**
O.E. Grade

Original & X-References..

DELCO		
1105510	1116388	1116404
1894460	1984287	1987518
USI	71-10056	
WAI	35-106	35-106-1
TRANSP0	D30	

01-022

Voltage Set Point **27.50 V**
O.E. Grade

01-030

Voltage Set Point **28.10 V**

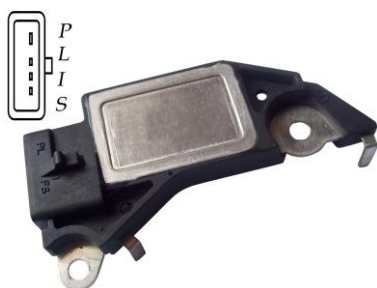

01-013

FEATURES

B-Circuit
Voltage Set Point **14.60 V**
Soft Start **30 %**
LRC **5 sec**
Field Shorted Circuit Protection
Under Voltage Indication
Over Voltage Indication

Original & X-References..

DELCO	1116411	1116429
	1116436	1116437
	D677	D685
	D698	
USI		71-10041
TRANSP0		D411HD

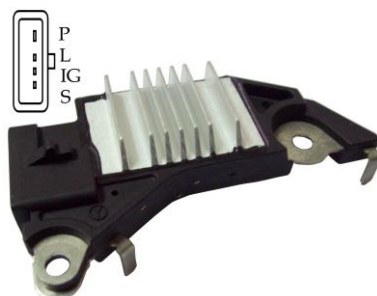

01-014

FEATURES

A-Circuit
Voltage Set Point **14.60 V**
Soft Start **30 %**
LRC **5 sec**
Field Shorted Circuit Protection
Under Voltage Indication
Over Voltage Indication

Original & X-References..

FOR DAEWOO



01-016

FEATURES

B-Circuit
Voltage Set Point **14.20 V**
Soft Start **30 %**
Field Shorted Circuit Protection
Under Voltage Indication
Over Voltage Indication
DFM Function
Self Exciting Function

Original & X-References..

DELCO	19020407
TRANSP0	D907

For use on: late Delco 22SI

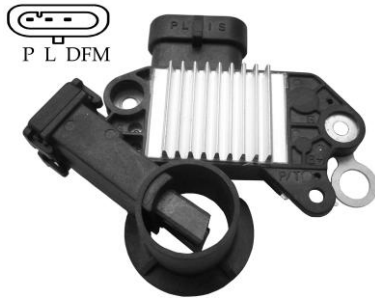

01-018

FEATURES

Original & X-References..

- B-Circuit
- Voltage Set Point **14.50 V**
- Soft Start **30 %** LRC **5 sec**
- Field Shorted Circuit Protection
- Under Voltage Indication
- Over Voltage Indication
- DFM Function

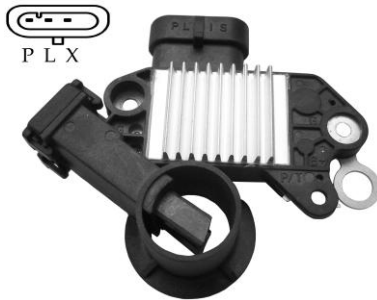

01-019

FEATURES

Original & X-References..

- B-Circuit
- Voltage Set Point **14.70 V**
- Soft Start **30 %**
- Field Shorted Circuit Protection
- Under Voltage Indication
- Over Voltage Indication
- Self Exciting Function

For use on: 11SI Alternator



01-020

FEATURES

Original & X-References..

- A-Circuit
- Voltage Set Point **14.70 V**

For use on: 11SI Alternator



01-021

FEATURES

Original & X-References..

- A-Circuit
- Voltage Set Point **14.50 V**
- Soft Start **30 %**
- LRC **5 sec**
- Field Shorted Circuit Protection
- Under Voltage Indication
- Over Voltage Indication

For use on: 11SI Alternator

MOBILETRON		VR-D717
LESTER	8483	8484
TRANSPO		D2206



01-023

FEATUERS

Original & X-References..

- A-Circuit
- Voltage Set Point **14.30 V**

For use on: 11SI Alternator

DELCO	19020204	207	208
	220198		
LESTER	8720	8721	8722
TRANSPO		D2198	

01-048

- A-Circuit
- Voltage Set Point **28.30 V**



01-025

FEATUERS

B-Circuit
 Voltage Set Point **14.70 V**
 Soft Start **30 %**
 LRC **5 sec**
 Field Circuit Protection
 Under Voltage Indication
 Over Voltage Indication
 DFM function

Original & X-References..

DELCO	10458200	10458201
WAI	35-162	
TRANSPO	D200	

01-026

FEATUERS

A-Circuit
 Voltage Set Point **14.60 V**

Original & X-References..

IK588



01-027

FEATUERS

A-Circuit
 Voltage Set Point **14.60 V**

Original & X-References..

DELCO	94648534	D673
WAI	35-153	
IK589		
TRANSPO	DE608	



01-031

FEATUERS

B-Circuit
 Voltage Set Point **14.70 V**
 Soft Start **32 %**
 LRC **5 sec**
 Field, Shorted Circuit Protection
 Under Voltage Indication
 Over Voltage Indication

Original & X-References..

DELCO	19009708
USI	71-10050
TRANSPO	DE708



01-032

FEATUERS

A-Circuit
 Voltage Set Point **14.60 V**

Original & X-References..

DELCO	1116380	1116384
	1116387	1116385
USI	71-10001	1116392
WAI	35-101	
MOBILETRON	VR-D668	
TRANSPO	D101	

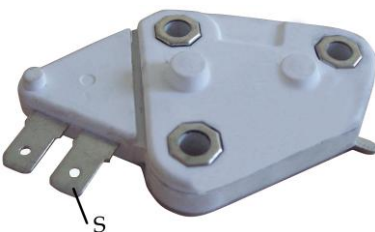



01-033

FEATUERS

B-Circuit
 Voltage Set Point **14.50 V**
 Soft Start **32 %**
 Field, Shorted Circuit Protection
 Under Voltage Indication
 Over Voltage Indication

Original & X-References..

DELCO	1116432
USI	71-10025
MOBILERTRON	VR-D432
TRANSPO	D432



01-034

FEATURES

B-Circuit
 Voltage Set Point **28.30 V**
 Soft Start **32 %**
 Field Shorted Circuit Protection
 Under Voltage Indication
 Over Voltage Indication
 DFM Function
 Self Exciting Function

Original & X-References..

DELCO	10521828	10514476
TRANSPO	D4476	

For use on: Delco 24SI series



01-037

FEATUERS

A-Circuit
 Voltage Set Point **14.55 V**

Original & X-References..

FOR DAEWOO	271910
------------	--------

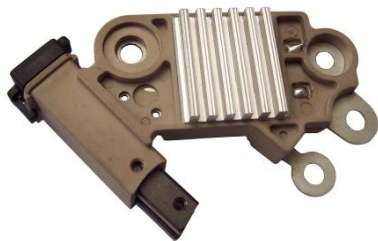

01-038

FEATUERS

A-Circuit
 Voltage Set Point **28.45V**

Original & X-References..



01-039

FEATUERS

B-Circuit
 Voltage Set Point **14.20 V**
 Soft Start **30 %**
 LRC **5 sec**
 Field Circuit Protection
 Under Voltage Indication
 Over Voltage Indication
 DFM function

Original & X-References..

DELCO	15163024	15163025
WAI	D202XHD	
TRANSPO	D202	



01-042

FEATUERS	Original & X-References..		
B-Circuit	DELCO	19009715	10480228
Voltage Set Point 14.70 V	WAI		35-141
Soft Start 30 %	TRANSPO		D9715
LRC 5 sec			
Field, Lamp Shorted Circuit Protection			
Under Voltage Indication			
Over Voltage Indication			
DFM function			

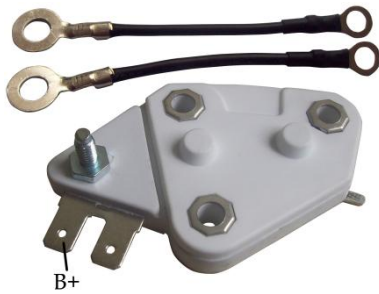

01-046

FEATUERS	Original & X-References..				
B-Circuit	DELCO	10SI	12SI	15SI	17SI
Voltage Set Point 14.60 V	TRANSPO		D713/D10AC		
Self Exciting Function					



01-047

FEATUERS	Original & X-References..			
A-Circuit	DELCO	1116389	1116406	1116407
Voltage Set Point 14.00 V		1894489	D669	D672
	WAI		35-105	
	TRANSPO		D102HD	



01-049

FEATUERS	Original & X-References..		
B-Circuit	DELCO	0392759	1509392
RVC=0 Vset= 13.80V	15093929	15200268	15263858
RC= 70% Vset= 14.45V	15857608	15905871	15905872
Soft Start 18.75 %	25869451		
LRC 2.5 sec	LESTER	8301	8302
DFM function	TRANSPO		D3587

RVC Regulator



01-050

FEATURES	Original & X-References..		
B-Circuit			
Voltage Set Point 14.50 V			
Soft Start 20 %			
LRC 5 sec			
Field, Lamp Shorted Circuit Protection			
Under Voltage Indication			
Over Voltage Indication			
DFM function			



01-051

FEATURES **Original & X-References..**

B-Circuit
 Voltage Set Point **14.50 V**
 Soft Start **20 %**
 LRC **5 sec**
 Field, Lamp Shorted Circuit Protection
 Under Voltage Indication
 Over Voltage Indication
 DFM function



01-052

FEATURES **Original & X-References..**

A-Circuit
 Voltage Set Point **14.60 V**

Original & X-References..	
DELCO	271840
TRANSCO	D840

For use on: Marine Application
 REG 5SI



01-053

FEATURES **Original & X-References..**

A-Circuit
 Voltage Set Point **14.60 V**

Original & X-References..	
DELCO	271850
	19020704
TRANSCO	19020707
	D850

For use on: Marine Application
 REG 5SI



01-054

FEATURES **Original & X-References..**

A-Circuit
 Voltage Set Point **14.60 V**

Original & X-References..	
DELCO	271940
LESTER	8460 8461
	8465 8466
TRANSCO	D940

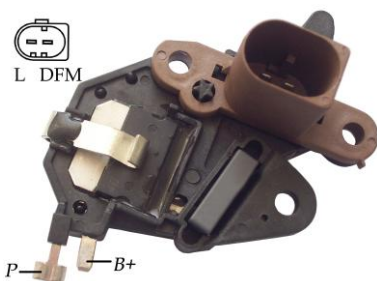

01-055

FEATURES **Original & X-References..**

B-Circuit
 Voltage Set Point **14.80 V**
 Soft Start **18.75 %**
 LRC **10 Sec**
 Under Voltage Indication
 Over Voltage Indication
 DFM Function

Original & X-References..	
ALTERNATOR REFERENCES	
MERCEDES	001500850
DELPHI	10480403
CARGO	235542
LESTER	23162
TRANSCO	DE1750

For use on: Audi ater cooling Alternator



01-057

FEATUERS

B-Circuit
 Voltage Set Point **14.80 V**
 Soft Start **30 %**
 LRC **5 sec**
 Field Shorted Circuit Protection
 Under Voltage Indication
 Over Voltage Indication

Original & X-References..

DELCO	10494747
LESTER	8238
TRANSPO	D201XHD

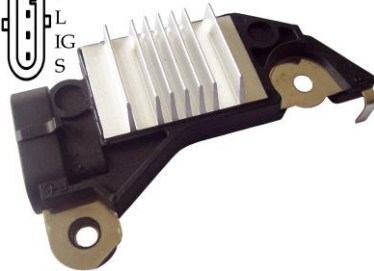

01-058

FEATURES

B-Circuit
 Voltage Set Point **14.80 V**
 Soft Start **30 %** LRC **10 sec**
 Field Shorted Circuit Protection
 Under / Over Voltage Indication

Original & X-References..

DELCO	19009703
LESTER	8158 8200
TRANSPO	D703

For use on: Buick Skylark, Chevrolet Cavalier, Pontiac Grand-Am, Sunfire



01-059

FEATURES

B-Circuit
 Voltage Set Point **14.60 V**
 Soft Start **30 %** LRC **5 sec**
 Field Shorted Circuit Protection
 Under / Over Voltage Indication
 DFM Function

Original & X-References..

DELCO	19009729
LESTER	8275 8276
TRANSPO	D729

For use on: Buick Skylark, Chevrolet Cavalier, Pontiac Grand-Am, Sunfire



01-060

FEATURES

B-Circuit
 Voltage Set Point **14.80 V**
 Soft Start **30 %** LRC **5 sec**
 Field Shorted Circuit Protection
 Under / Over Voltage Indication
 DFM Function

Original & X-References..

DELCO	19009748	19009749
		19009761
LESTER	8234 8243 8249	
	8270 8271 8272	
	8279 8283	
TRANSPO		D749XHD

For use on: Buick Skylark, Chevrolet Cavalier, Pontiac Grand-Am, Sunfire

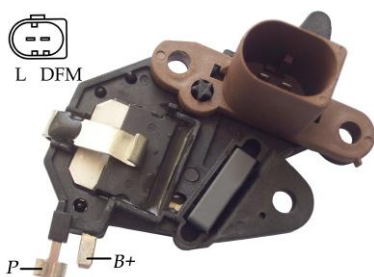

01-061

FEATURES

B-Circuit
 Voltage Set Point **14.80 V**
 Soft Start **18.75 %**
 LRC **10 Sec**
 Under Voltage Indication
 Over Voltage Indication
 DFM Function

Original & X-References..

DELCO	10480403	10480407
LESTER	23161	
TRANSPO		DE1650

For use on: Audi ater cooling Alternator



01-062

FEATURES

Original & X-References..

A -Circuit
 Voltage Set Point **14.50 V**
 Soft Start **30 %**
 LRC **5 Sec**
 Field Shorted Circuit Protection
 Under Voltage Indication
 Over Voltage Indication
 DFM Function



01-063

FEATURES

Original & X-References..

B-Circuit
 RVC=0 Vset=**13.80V**
 RC=**70%** Vset=**14.45V**
 Soft Start **18.75 %**
 LRC **2.5 sec**
 DFM function

RVC Regulator



01-064

FEATURES

Original & X-References..

B-Circuit
 Voltage Set Point **14.80 V**
 Soft Start **30 %**
 LRC **5 sec**
 Field Shorted Circuit Protection
 Under / Over Voltage Indication
 DFM Function

DELCO	1116413	1116430		
	1116445	19009730		
LESTER	7806	7904	7942	7966
	7969	8127	8170	8189
	8202	8213	8225	8226
	8248			
TRANSPO		D445		

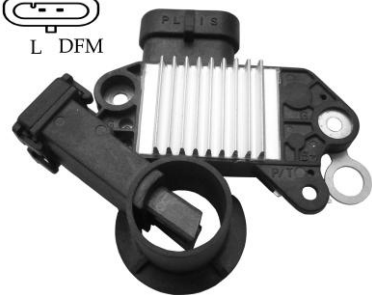

01-066

FEATURES

Original & X-References..

A -Circuit
 Voltage Set Point **14.70 V**
 Soft Start **32 %**
 LRC **5 sec**
 Field Shorted Circuit Protection
 Under / Over Voltage Indication
 DFM Function

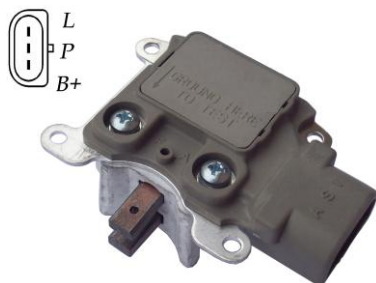

02-001

FEATURES

A-Circuit
Voltage Set Point **14.80 V**

For use on : Ford 3G Series IR/ER
Alternators

Original & X-References..

USI	71-20002
MOBILETRON	VR-F786BH
UNIPOINT	YR-F33B
WAI	35-205
CARGO	232414
TRANSP0	F794B

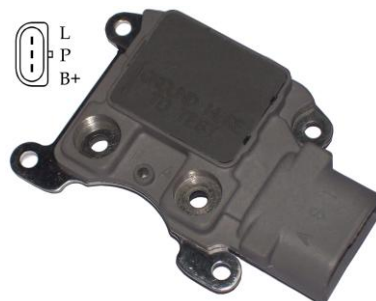

02-002

FEATURES

A-Circuit
Voltage Set Point **14.50 V**

For use on: Ford 3G Series IR/ER
Alternators

Original & X-References..

FORD	EIDU-10316-A	
	E9DF-10316-AA	
MOBILETRON	VR-F786	
USI	71-20002	
WAI	35-204-1	35-205
CARGO	136230	232414
TRANSP0	F794	



02-003

FEATURES

A-Circuit
Voltage Set Point **14.45 V**
Soft Start **30 %**
Field Shorted Circuit Protection
Under/ Over Voltage Indication
Gray with Gray Cover

For use on: Ford 6G Series IR/ER
Alternators Automobiles: FORD Crown
Victoria, Lincoln

Original & X-References..

FORD	F8WU-10C359-AB
MOBILETRON	VR-F900
USI	71-20011
WAI	35-212
CARGO	230065
TRANSP0	F600

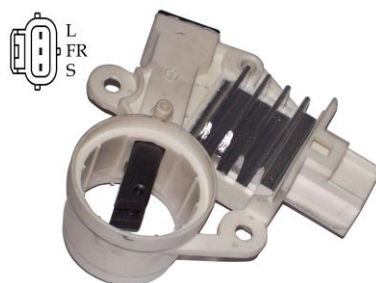

02-004

FEATURES

A-Circuit
Voltage Set Point **14.45 V**
Soft Start **30 %** LRC **5 sec**
Field Shorted Circuit Protection
Under Voltage Indication
Over Voltage Indication
White with Orange Cover

For use on: Ford 6G Series IR/ER
Alternators

Original & X-References..

FORD	XS7U-10C359-AC
	XS7U-10C359-BA
MOBILETRON	VR-F930
USI	71-20015
WAI	35-214
CARGO	233775
TRANSP0	F603

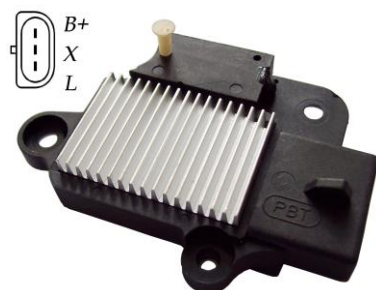

02-005

FEATURES

A-Circuit
Voltage Set Point **14.45 V**
Soft Start **30 %**
LRC **5 sec**
Field Shorted Circuit Protection
Under Voltage Indication
Over Voltage Indication

For use on: Ford 4G Series IR/ER
Alternators

Original & X-References..

FORD	F50U-10316-A
MOBILETRON	VR-F815
USI	71-20004
WAI	35-208
CARGO	138663
TRANSP0	F796



02-006

FEATURES

A-Circuit
 Voltage Set Point **14.45 V**
 Field Shorted Circuit Protection
 Over Voltage Indication

For use on : Ford 4G Series IR/ER
 Alternators

Original & X-References..

FORD	F6DU-10C359-AA
	F6DY-10316-A
	F6DY-10316-A
MOTORCRAFT	GR-817
MOBILETRON	VR-F817
USI	71-20007
WAI	35-210
CARGO	230066
TRANSP0	F798



02-007

FEATURES

A-Circuit
 Voltage Set Point **14.45 V**
 Soft Start **30 %**
 LRC **5 sec**
 Field Shorted Circuit Protection
 Under Voltage Indication
 Over Voltage Indication
 Gray with Green Cover

Original & X-References..

FORD	VP3C3U10C359AA
MOBILETRON	VR-F901
TRANSP0	F605



02-008

FEATURES

A-Circuit
 Voltage Set Point **14.45 V**
 Field Shorted Circuit Protection
 Over Voltage Indication

For use on: Ford 3G Series IR/ER
 Alternators

Original & X-References..

FORD	F3A-10316-A
	F3A-10346-A
	F3RU-10316-AA
	F3RU-10316-AA
MOTORCRAFT	GR-811
MOBILETRON	VR-F811
USI	71-20005
WAI	35-206
CARGO	135854
TRANSP0	F785

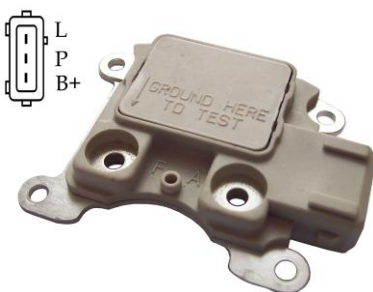

02-009

FEATURES

A-Circuit
 Voltage Set Point **14.45V**
 Soft Start **30 %**
 LRC **5 sec**
 Field Shorted Circuit Protection
 Under Voltage Indication
 Over Voltage Indication

Original & X-References..

FORD	F5RZ-10316-A
	F5RU-10316-BA
MOTORCRAFT	GR-818
MOBILETRON	VR-F818
USI	71-20006
WAI	35-209
CARGO	138185
TRANSP0	F786



02-010

FEATURES

A-Circuit
 Voltage Set Point **14.45 V**
 Soft Start **30 %** LRC **5 sec**
 Field Shorted Circuit Protection
 Under Voltage Indication
 Over Voltage Indication
 "ISA" Terminals

For use on: Ford 3G Series IR/ER
 Alternators

Original & X-References..

FORD	F4ZZ-10316-A
MOTORCRAFT	GR-814
MOBILETRON	VR-F814
USI	71-20008
WAI	35-207-4
CARGO	232415
TRANSP0	F795

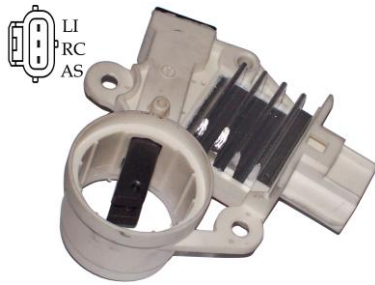

02-011

FEATUERS

A-Circuit
 RC=0 $V_s=13.50V$
 RC=55% $V_s=14.25V$
 White with Blue Cover

Original & X-References..

WAI	35-2135
CARGO	233232
MOBILETRON	VR-910
LASTER	7788 8253
	8255 8256
TRANSPO	F601

PCM Regulator



02-012

FEATUERS

A-Circuit
 RC=0 $V_s=13.50V$
 RC=55% $V_s=14.25V$

Original & X-References..

MOBILETRON	VR-VN001
LESTER	8440 8527 8528
	8531 8532 8533
TRANSPO	F611

PCM Regulator



02-013

FEATUERS

A-Circuit
 Voltage Set Point **14.30 V**
 Soft Start **30 %**
 Field, Lamp Shorted Circuit Protection
 Under Voltage Indication
 Over Voltage Indication

Original & X-References..

TRANSPO	F610
---------	------

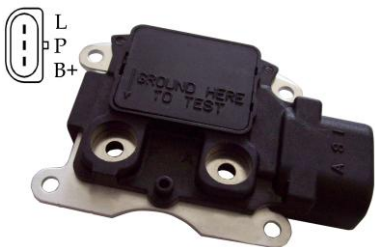

02-014

FEATUERS

A-Circuit
 Voltage Set Point **14.50 V**

Original & X-References..

FORD	E43F-10316AA
	E73F-10316-AB
USD	71-20001
TRANSPO	F784HD

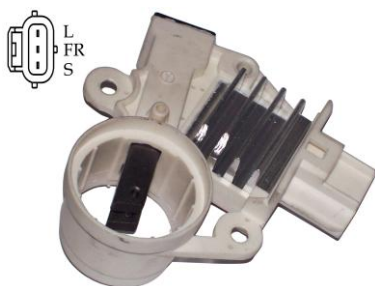

02-016

FEATUERS

A-Circuit
 Voltage Set Point **14.30 V**
 Soft Start **30 %** LRC **5 sec**
 Field, Lamp Shorted Circuit Protection
 Sense Loss Indication
 Under / Over Voltage Indication
 DFM function
 White with White Cover

Original & X-References..

FORD	XR2U-10C359-AB
	XS7U-10C359-AC
WAI	35-216
TRANSPO	F602

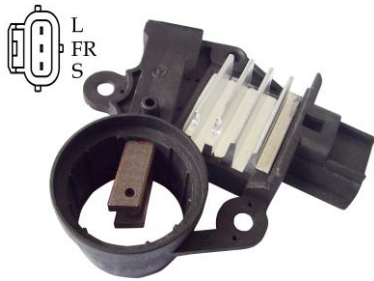

02-017

FEATUERS

- A-Circuit
- Voltage Set Point **14.40 V**
- Soft Start **30 %** LRC **5 sec**
- Field, Lamp Shorted Circuit Protection
- Sense Loss Indication
- Under Voltage Indication
- Over Voltage Indication
- DFM function
- Black with Black Cover

Original & X-References..

FORD	UP4LIU-10C359-AA
TRANSPO	F606

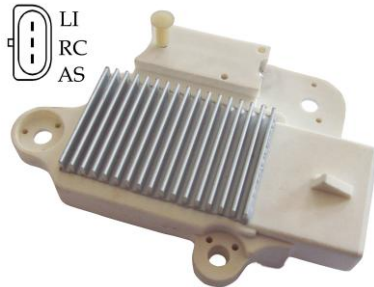

02-018

FEATUERS

- A-Circuit
- RC=0 Vs=**13.50V**
- RC=55% Vs=**14.25V**

PCM Regulator

Original & X-References..

FORD	YF1U-10C359-AA			
	VP3F1U-10C359-AA			
	VP6L8U-10C359-AA			
LESTER	8269	8313	8314	
	8403	8404	8405	8442
TRANSPO	F797			

For use on: Ford 4G Series IR/ER
Alternators



03-001

FEATURES

A-Circuit
Voltage Set Point **14.50 V**
DFM Function
63.5mm Mounting

Original & X-References..

NIPPONDENSO	126000-2090
126000-2620	126000-2190
MOBILETRON	VR-H2005-40
WAI	35-8241
CARGO	234557
TRANSPO	IN445

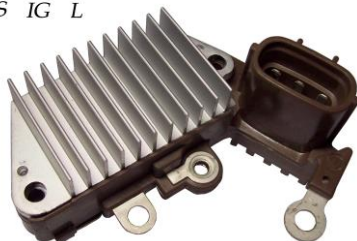

03-004

FEATUERS

A-Circuit
Voltage Set Point **14.20 V**
Soft Start **30 %**
Field Shorted Circuit Protection
Under Voltage Indication
Over Voltage Indication
57.5mm Mounting

Original & X-References..

NIPPONDENSO	126000-3790
TRANSPO	IN259

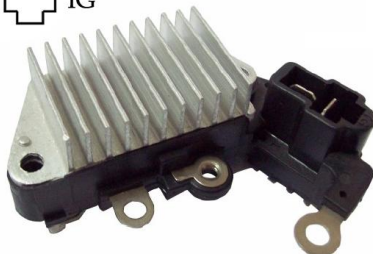

03-005

FEATURES

A-Circuit
Voltage Set Point **14.50 V**
Field Shorted Circuit Protection
Over Voltage Indication
57.5mm Mounting

Original & X-References..

NIPPONDENSO	126000-0760
126000-1160	126000-0600
TOYOTA	27700-78301
MOBILETRON	VR-H2005-15H
USI	71-30001
WAI	35-8221-1
CARGO	133872
TRANSPO	IN254

03-047

Heavy Duty Version



03-007

FEATURES

A-Circuit
Voltage Set Point **14.50 V**
Soft Start **30 %** LRC **5 sec**
Field Shorted Circuit Protection
IG / Sense Open Indication
Active lamp function - with output
Under / Over Voltage Indication
57.5mm Mounting

Original & X-References..

NIPPONDENSO	126000-0550	126000-0980
126000-1550		126000-1570
MOBILETRON		VR-H2005-23A
USI		71-30025
WAI		35-8217
CARGO		132855
TRANSPO		IN250

03-054



03-008

FEATURES

A-Circuit
Voltage Set Point **14.50 V**
Soft Start **30 %** LRC **5 sec**
Field Shorted Circuit Protection
IG / Sense Open Indication
Under / Over Voltage Indication
63.5mm Mounting

Original & X-References..

NIPPONDENSO	1260001960	1260002050
1260002200		1260002250
MOBILETRON		VR-H2005-46A
MF		VR02150
CARGO		139584
WAI		35-8240
TRANSPO		IN453

03-008S

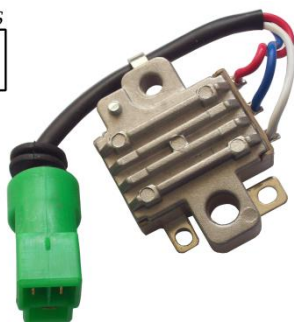
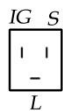

03-009

FEATURES

A-Circuit
Voltage Set Point **14.30 V**

For use on: Toyota Industrial

Original & X-References..

NIPPONDENSO	126000-0920
126000-1421	126000-1460
CARGO	133526 231197
MOBILETRON	VR-H2005-2
MF	VR01770
WAI	35-8245
TRANSP0	IN920

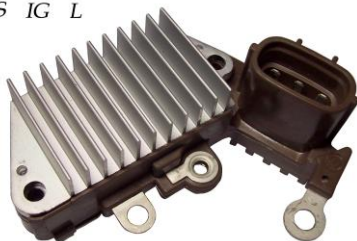
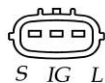

03-011

FEATURES

A-Circuit
Voltage Set Point **14.50 V**
Soft Start **30 %** LRC **5 sec**
Field Shorted Circuit Protection
IG / Sense Loss Indication
Under / Over Voltage Indication
57.5mm Mounting

Original & X-References..

NIPPONDENSO	126000-1630
MOBILETRON	VR-H2005-32A
USI	71-30014
WAI	35-8242
CARGO	138662
TRANSP0	IN257

03-055

03-012

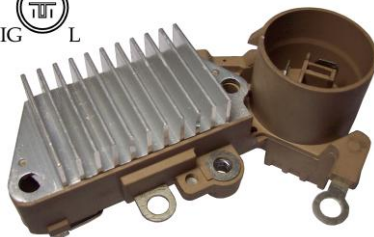

FEATURES

A-Circuit
Voltage Set Point **14.50 V**
Soft Start **30 %** LRC **5 sec**
Field Shorted Circuit Protection
IG Open Indication
Under / Over Voltage Indication
63.5mm Mounting

Original & X-References..

NIPPONDENSO	1260001200
ISUZU	8970320910
MOBILETRON	VR-H2005-16A
USI	71-30010
GARGO	134447
TRANSP0	IN435

03-012S

03-013

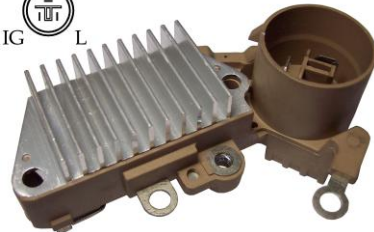

FEATURES

A-Circuit
Voltage Set Point **14.40 V**
Soft Start **30 %** LRC **5 sec**
Field Shorted Circuit Protection
IG / Sense Open Indication
Active lamp function - with output
Under / Over Voltage Indication
63.5mm Mounting

Original & X-References..

NIPPONDENSO	126000-0340	126000-0400
	126000-0510	126000-0650
	126000-0700	126000-0731
MOBILETRON	VR-H2005-4A	
USI	71-30003	
WAI	35-8204	
CARGO	131459	
TRANSP0	IN220	

03-056

03-014



FEATURES

B-Circuit
Voltage Set Point **14.70 V**
Soft Start **32 %**
Field, Lamp Shorted Circuit Protection
Under Voltage Indication
Over Voltage Indication
DFM Function

Original & X-References..

NIPPONDENSO	126600-0040	126600-0042
	104210-309	
HONDA	31100-PGK-A01	
	CSC09	
LESTER	13918 290-5084	
TRANSP0	IN6004	



03-015

FEATURES

A-Circuit
Voltage Set Point **28.50 V**

Original & X-References..

NIPPONDENSO
126000-0200 -0260 -0790
WAI 35-8223
TRANSPO IN217(With brush holder)

03-029

A-Circuit
Voltage Set Point **14.50V**

NIPPONDENSO
126000-0180 -0520 -0770 -0820
WAI 35-8203
TRANSPO IN218(With brush holder)



03-016

FEATURES

A-Circuit
Voltage Set Point **14.50 V**
Soft Start **30 %** LRC **5 sec**
Field, Shorted Circuit Protection
Under Voltage Indication
Over Voltage Indication
63.5mm Mounting

Original & X-References..

NIPPONDENSO 126000-1970
126000-1971
MOBILETRON VR-H2005-48A
CARGO 139268
TRANSPO IN452



03-016S

03-017

FEATURES

A-Circuit
Voltage Set Point **14.60V**
Soft Start **30 %** LRC **5 sec**
Field Shorted Circuit Protection
Sense Open Indication
Under / Over Voltage Indication
63.5mm Mounting

Original & X-References..

NIPPONDENSO
126000-1580 126000-1640
126000-1670 126000-1660
MOBILETRON VR-H2005-31A
USI 71-30017
WAI 35-8238-1
CARGO 135734
TRANSPO IN439



03-017S

03-018

FEATURES

A-Circuit
Voltage Set Point **14.60 V**
Soft Start **30 %** LRC **5 sec**
Field Shorted Circuit Protection
Sense Open Indication
Under / Over Voltage Indication
63.5mm Mounting
For use on: Toyota Camry, Lexus,
Mazda,Millenia2.5L

Original & X-References..

NIPPONDENSO 126000-1870
126000-2260 126000-1810
126000-1850 126000-2000
MOBILETRON VR-H2005-63A
WAI 35-8234-1
CARGO 138894
TRANSPO IN441

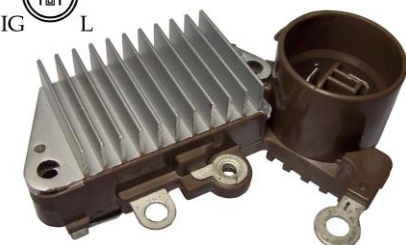

03-018S

03-019

FEATURES

A-Circuit
Voltage Set Point **14.50 V**
L Terminal Drives Choke
57.5mm Mounting

Original & X-References..

NIPPONDENSO 126000-0840
MOBILETRON VR-H2005-25
LESTER 14937
WAI 35-8218
CARGO 138664
TRANSPO IN252

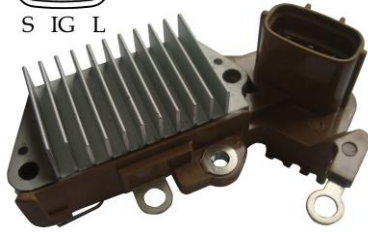

03-021

FEATURES

A-Circuit
 Voltage Set Point **14.50 V**
 Soft Start **30 %** LRC **5 sec**
 Field Shorted Circuit Protection
 IG / Sense Open Indication
 Under / Over Voltage Indication
 63.5mm Mounting

Original & X-References..

NIPPONDENSO	1260001730
	1260001750
	1260001930
TOYOTA	2770011070
	2770066040
MOBILETRONON	VR-H2005-30A
WAI	35-8235
CARGO	135737
TRANSP0	IN437

03-021S

03-022

FEATURES

A-Circuit
 Voltage Set Point **14.30 V**
 Soft Start **30 %**
 Field Shorted Circuit Protection
 Sense Open Indication
 Active lamp function - with output
 Under/ Over Voltage Indication

Original & X-References..

NIPPONDENSO	126000-0920
	126000-1421
MF	VR01770
TOYOTA	27000-64040
MOBILETRONON	VR-H2005-2
CARGO	133526 231197
TRANSP0	IN920



03-0091

03-023

FEATURES

A-Circuit
 Voltage Set Point **28.70 V**

Original & X-References..

TOYOTA	27000-1700
HINO	277000-1700
SHWAFUJI	1219-008-00XOSF
MOBILETRONON	VR-H2002-1
CARGO	136168
TRANSP0	IW700

03-061

A-Circuit
 Voltage Set Point **28.60 V**
 Lamp Shorted Circuit Protection
 L Terminal Does Not Drive Choke



03-024

FEATURES

A-Circuit
 Voltage Set Point **28.80 V**

Original & X-References..

HONO	27700-1810
NISSA	23500-99109



03-025

FEATURES

A-Circuit
 Voltage Set Point **14.50 V**
 57.5mm Mounting

Original & X-References..

NIPPONDENSO	126000-1800
USI	71-30015
WAI	35-8246
CARGO	138146
TRANSP0	IN450



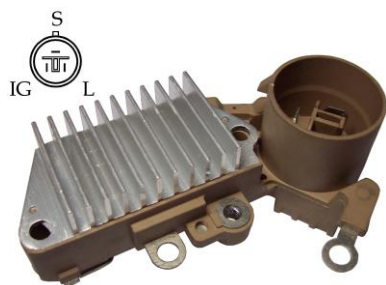

03-027

FEATURES

A-Circuit
 Voltage Set Point **14.50 V**
 Soft Start **30 %** LRC **5 sec**
 Field Shorted Circuit Protection
 IG / Sense Open Indication
 Under / Over Voltage Indication
 63.5mm Mounting

Original & X-References..

NIPPONDENSO	126000-0610	126000-1110
	126000-1440	126000-1441
MOBILETRONON		VR-H2005-33 ^a
CARGO		135730
TRANSPO		IN434

03-027S

03-028

FEATURES

A-Circuit
 Voltage Set Point **14.50V**
 Soft Start **30 %** LRC **5 sec**
 Field Shorted Circuit Protection
 Under/ Over Voltage Indication
 DFM Function
 63.5mm Mounting

Original & X-References..

NIPPONDENSO	126000-3130	126000-3131
		126000-3171
MOBILETRONON		VR-H2005-66
CARGO		234091
TRANSPO		IN447



03-028S

03-030

FEATURES

A-Circuit
 Voltage Set Point **28.20V**
 63.5mm Mounting

Original & X-References..

NIPPONDENSO	126000-7120	27700-58040
MOBILETRONON		VR-H2005-66
USI		71-30019
CARGO		138297
TRANSPO		IN460



03-032

A-Circuit
 Voltage Set Point **28.50V**
 63.5mm Mounting

03-031

FEATURES

B-Circuit
 Voltage Set Point **14.80 V**
 Soft Start **32 %**
 Field, Lamp Shorted Circuit Protection
 Under Voltage Indication
 Over Voltage Indication
 DFM Function

Original & X-References..

NIPPONDENSO	126600-3350	104210-329
MOBILETRONON		VR-H2005-90
HONDA		A04 CSC29
		31100-RAA-A01
LESTER		13980
		290-5096
TRANSPO		IN6335



03-033

FEATURES

A-Circuit
 Voltage Set Point **14.60 V**
 DFM Function
 63.5mm Mounting

Original & X-References..

NIPPONDENSO	126000-1410	126000-1860
		126000-1880
MOBILETRONON		VR-H2005-10
USI		71-30006
WAI		35-8232
TRANSPO		IN431

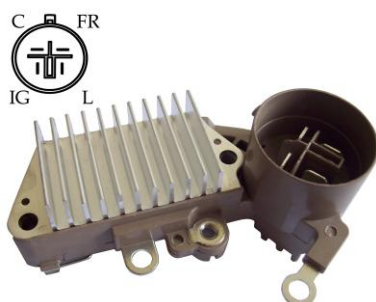

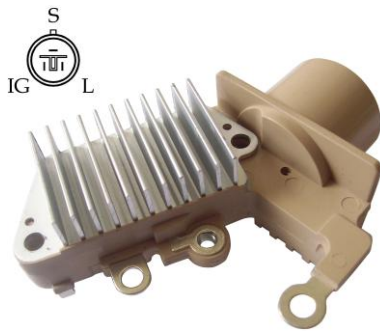

03-034

FEATURES

A-Circuit
 Voltage Set Point **14.50 V**
 Soft Start **30 %**
 LRC **5 sec**
 Field Shorted Circuit Protection
 Sense Open Indication
 Under / Over Voltage Indication
 57.5mm Mounting

Original & X-References..

NIPPONDENSO 126000-1770
 TRANSPO IN277

03-034S

03-035

FEATURES

A-Circuit
 Voltage Set Point **14.50 V**
 Soft Start **30 %** LRC **5 sec**
 Field Shorted Circuit Protection
 IG / Sense Open Indication
 Active lamp function - with output
 Under/ Over Voltage Indication
 DFM Function
 63.5mm Mounting

Original & X-References..

NIPPONDENSO 126000-2450
 126000-2190
 MOBILETRONON VR-H2005-64A
 WAI 35-8243
 CARGO 233517
 TRANSPO IN455

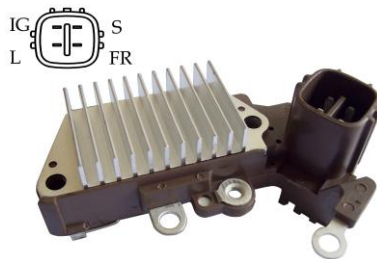

03-035S

03-036

FEATURES

A-Circuit
 Voltage Set Point **14.50 V**
 DFM Function
 63.5mm Mounting

Original & X-References..

NIPPONDENSO 126000-0940 126000-1700
 126000-1030 126000-1300
 USI 71-30005
 WAI 35-8214
 CARGO 132859
 TRANSPO IN224

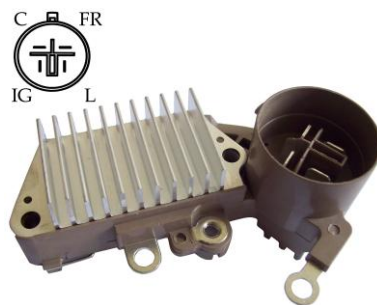

03-038

FEATURES

A-Circuit
 Voltage Set Point **14.50 V**
 Soft Start **30 %** LRC **5 sec**
 Field Shorted Circuit Protection
 IG / Sense Open Indication
 Under / Over Voltage Indication
 DFM Function
 63.5mm Mounting

Original & X-References..

NIPPONDENSO 126000-0540 126000-1170
 MOBILETRONON VR-H2005-9A
 USI 71-30004
 TRANSPO IN226

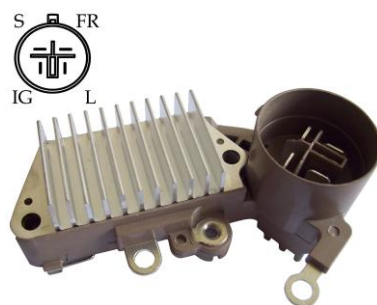

03-038S

03-039

FEATURES

A-Circuit
 Voltage Set Point **14.60 V**
 Soft Start **30 %** LRC **5 sec**
 Field Shorted Circuit Protection
 IG Open Indication
 Active lamp function - with output
 Under /Over Voltage Indication
 DFM Function
 63.5mm Mounting

Original & X-References..

NIPPONDENSO 126000-1470 126000-1471
 WAI 35-8231
 CARGO 232455
 TRANSPO IN429
 NIPPONDENSO 126000-0570
 USI 71-30009
 CARGO 132831
 TRANSPO IN225

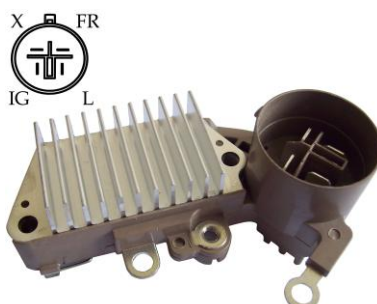

03-037



03-040

FEATURES

A-Circuit
Voltage Set Point **14.50 V**
63.5mm Mounting

Original & X-References..

NIPPONDENSO	126000-2150
	126000-2151
MOBILETRONON	VR-H2005-77
CARGO	234731
TRANSP0	IN215

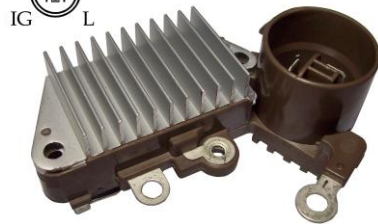

03-041

FEATURES

A-Circuit
Voltage Set Point **28.20 V**
57.5mm Mounting

Original & X-References..

03-042



FEATUERS

A-Circuit
RC=0 Vs=**13.50V**
RC=55% Vs=**14.25V**

Original & X-References..

PCM Regulator

NIPPONDENSO		
	104210-3512	104210-4091
	104210-4700	104210-5300
MOBILETRON		VR-H2005-88
TRANSP0		IN6601

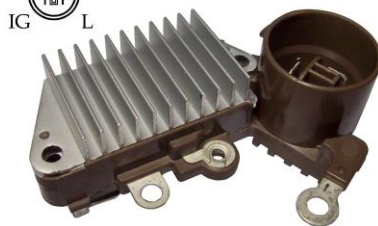

03-044

FEATURES

A-Circuit
Voltage Set Point **14.50 V**
Soft Start **30 %** LRC **5 sec**
Field Shorted Circuit Protection
IG Open Indication
Under / Over Voltage Indication
57.5mm Mounting

Original & X-References..

NIPPONDENSO	126000-0850
	126000-0880
	126000-1370
MOBILETRONON	VR-H2005-24
WAI	35-8216
CARGO	132860
TRANSP0	IN251

03-043

03-045

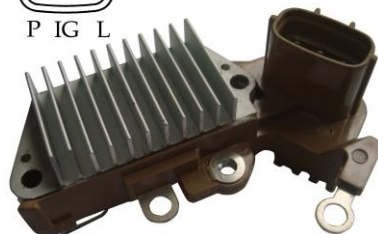

FEATURES

A-Circuit
Voltage Set Point **14.60 V**
63.5mm Mounting

Original & X-References..

NIPPONDENSO	126000-1940
MOBILETRONON	VR-H2005-59
CARGO	138638
TRANSP0	IN449

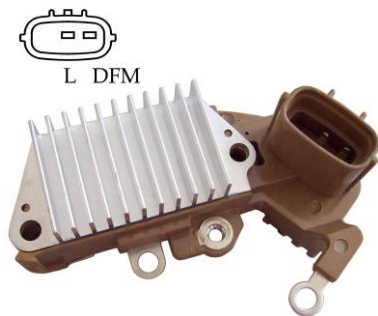

03-048

FEATUERS	Original & X-References..	
A-Circuit	LESTER	11193
Voltage Set Point 14.70 V	TRANSPO	IN454
Soft Start 30 %		
Field, Shorted Circuit Protection		
Under Voltage Indication		
Over Voltage Indication		
DFM function		
63.5mm Mounting		



03-051

FEATUERS	Original & X-References..	
A-Circuit		
Voltage Set Point 28.50 V		
Soft Start 30 %		
Field Lamp Shorted Circuit Protection		
Under Voltage Indication		
Over Voltage Indication		
63.5mm Mounting		



03-052

FEATUERS	Original & X-References..	
A-Circuit	NIPPONDENSO	12600-3300
Voltage Set Point 14.50 V	TRANSPO	IN330
Soft Start 30 % LRC 5 sec		
Field Shorted Circuit Protection		
IG Open Indication		
Under / Over Voltage Indication		
63.5mm Mounting		

03-052S	NIPPONDENSO	12600-2080
	TRANSPO	IN208

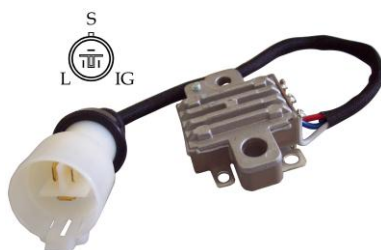

03-053

FEATUERS	Original & X-References..	
A-Circuit	NIPPONDENSO	12600-0920
Voltage Set Point 14.30 V	MOBILETRON	VR-H2005-2W
	TRANSPO	IN921



03-058

FEATUERS	Original & X-References..	
A-Circuit	MOBILETRON	VR-H2005-62A
Voltage Set Point 14.55 V	DENSO	126000-3040
Soft Start 30 % LRC 5 sec	TRANSPO	IN304
Field, Lamp Shorted Circuit Protection		
Under Voltage Indication		
Over Voltage Indication		
DFM function		
63.5mm Mounting		



03-059

FEATUERS

A-Circuit
 Voltage Set Point **14.10 V**
 Soft Start **30 %** LRC **5 sec**
 Sense Loss Indication
 Under Voltage Indication
 Over Voltage Indication
 63.5mm Mounting

Original & X-References..

NIPPONDENSO	126000-7100
MOBILETRON	VR-H2005-35
WAI	35-8237
CARGO	135734
TRANSP0	IN440

03-059S

03-060

FEATUERS

A-Circuit
 Voltage Set Point **28.50 V**

Original & X-References..

NIPPONDENSO	12600-0380
TRANSP0	IN233

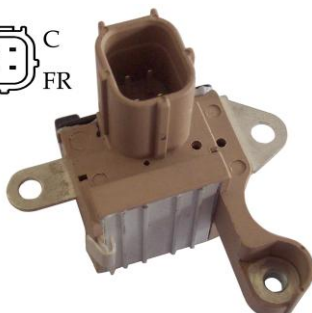

03-064

FEATUERS

B-Circuit
 Voltage Set Point **14.80 V**
 Soft Start **32 %**
 Field Shorted Circuit Protection
 Under Voltage Indication
 Over Voltage Indication
 DFM function

Original & X-References..

NIPPONDENSO	104210-591
LESTER	11392
TRANSP0	IN6365

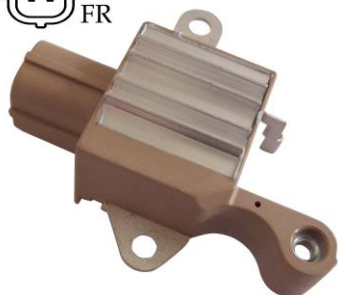

03-065

FEATUERS

B-Circuit
 Voltage Set Point **14.80 V**
 Soft Start **32 %**
 Field Shorted Circuit Protection
 Under Voltage Indication
 Over Voltage Indication
 DFM function

Original & X-References..

NIPPONDENSO	104210-589
	126600-3650
LESTER	11390
TRANSP0	IN6366

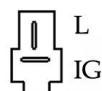

03-066

FEATURES

A-Circuit
 Voltage Set Point **14.50 V**
 Field Shorted Circuit Protection
 Over Voltage Indication
 L Terminal Drives Choke
 57.5mm Mounting

Original & X-References..

NIPPONDENSO	126000-0970
	126000-0971
WAI	35-8220
LESTER	12180 12182
TRANSP0	IN255



03-068

FEATUERS

- A-Circuit
- Voltage Set Point **14.55V**
- Soft Start **30 %**
- Field Shorted Circuit Protection
- Under Voltage Indication
- Over Voltage Indication
- DFM function
- 63.5mm Mounting

Original & X-References..

USI 71-30031



03-069

FEATURES

- A-Circuit
- Voltage Set Point **14.20 V**
- Soft Start **30 %**
- LRC **5 sec**
- Field Shorted Circuit Protection
- Under Voltage Indication
- Over Voltage Indication
- DFM function

Original & X-References..

NIPPONDENSO	126600-0150
LESTER	11087 11090
	13983 13994
TRANSPO	IN6015



03-073

FEATUERS

- B-Circuit
- Voltage Set Point **14.30 V**
- Soft Start **32 %**
- LRC **5 sec**
- Field Shorted Circuit Protection
- Sense open indication
- Under Voltage Indication
- Over Voltage Indication

Original & X-References..

NIPPONDENSO	126600-002
MOBILETRON	VR-H2005-35
TRANSPO	IN6002



03-074

FEATUERS

- B-Circuit
- Voltage Set Point **14.30 V**
- Soft Start **32 %**
- LRC **5 sec**
- Field, Lamp Shorted Circuit Protection
- Sense open indication
- Under Voltage Indication
- Over Voltage Indication
- DFM function

Original & X-References..

NIPPONDENSO	126600-3010	
	126600-3040	126600-3390
LESTER	11032	11033 11034
	11084	11088 11195
TRANSPO		IN6301



03-076

FEATURES

- A-Circuit
- Voltage Set Point **14.50 V**
- Soft Start **30 %** LRC **5 sec**
- Field Shorted Circuit Protection
- Lamp Shorted Circuit Protection
- Under / Over Voltage Indication
- 63.5mm Mounting

Original & X-References..

03-076S

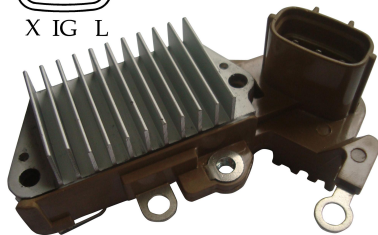

03-077

FEATURES

A-Circuit
 Voltage Set Point **14.50 V**
 Soft Start **30 %** LRC **5 sec**
 Field, Shorted Circuit Protection
 L Terminal Drives Choke
 Under Voltage Indication
 Over Voltage Indication
 63.5mm Mounting

Original & X-References..

NIPPONDENSO 126000-2480
 LESTER 13837 13875
 TRANSPO IN248

03-077S

03-079

FEATURES

A-Circuit
 Voltage Set Point **14.60V**
 Soft Start **30 %** LRC **5 sec**
 Field Shorted Circuit Protection
 Under / Over Voltage Indication
 63.5mm Mounting

Original & X-References..

NIPPONDENSO 126000-0430
 MOBILETRON VR-H2005-5H
 USI 71-30021
 WAI 35-8205 35-8205-3
 CARGO 134447
 TRANSPO IN221



03-010

03-046

Voltage Set Point **28.20 V**

03-080

FEATURES

A-Circuit
 Voltage Set Point **14.50 V**
 Soft Start **30 %** LRC **5 sec**
 Field Shorted Circuit Protection
 Under / Over Voltage Indication
 57.5mm Mounting

Original & X-References..

NIPPONDENSO 126000-0720
 126000-0721 126000-1330
 WAI 35-8215-1
 LESTER 13214 13255
 13414 14684 14871
 TRANSPO IN253

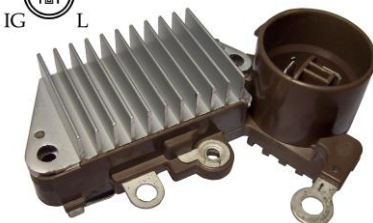

03-026

03-020 Without RFI Capacitor

03-081

FEATURES

A-Circuit
 Voltage Set Point **14.50 V**
 Soft Start **30 %**
 LRC **5 sec**
 Field Shorted Circuit Protection
 Under/ Over Voltage Indication
 DFM Function
 63.5mm Mounting

Original & X-References..

NIPPONDENSO 126000-3020 102211-075
 LESTER 23192
 TRANSPO IN302

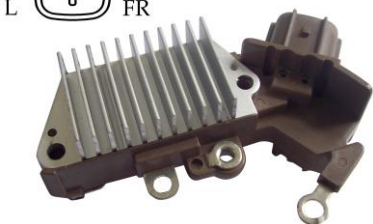

03-082

FEATURES

A-Circuit
 Voltage Set Point **14.50 V**
 Soft Start **30 %** LRC **5 sec**
 Field Shorted Circuit Protection
 IG / Sense Open Indication
 Active lamp function - with output
 Under/ Over Voltage Indication
 DFM Function
 63.5mm Mounting

Original & X-References..



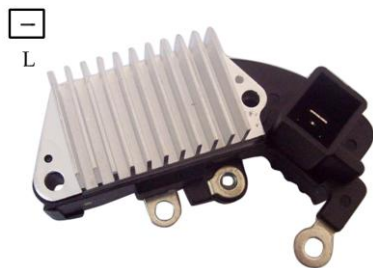

L

03-083

FEATURES

A-Circuit
 Voltage Set Point **14.40 V**
 Soft Start **30 %** LRC **5 sec**
 Field Shorted Circuit Protection
 Under/ Over Voltage Indication
 63.5mm Mounting

Original & X-References..

NIPPONDENSO	126000-1760
MOBILETRON	VR-H2005-34
LESTER	13519 13548
TRANSPO	IN443

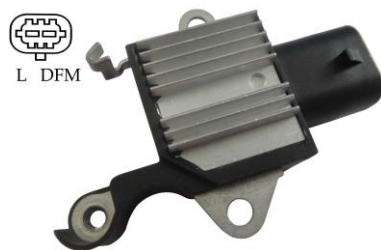

L DFM

03-084

FEATURES

B-Circuit
 RVC=0 Vset=**13.80V**
 RC=**70%** Vset=**14.45V**
 Soft Start **18.75 %**
 LRC **2.5 sec**
 DFM function

Original & X-References..

NIPPONDENSO	126600-3240
126600-3440	126600-3060
MOBILETRON	VR-H2005-101
TRANSPO	IN6324

RVC Regulator

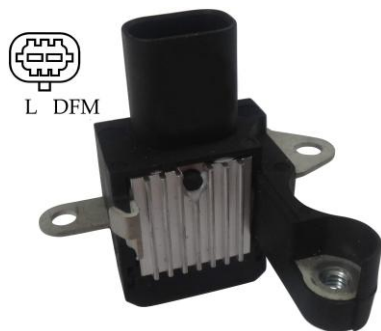

L DFM

03-085

FEATURES

B-Circuit
 RVC=0 Vset=**13.80V**
 RC=**70%** Vset=**14.45V**
 Soft Start **18.75 %**
 LRC **2.5 sec**
 DFM function

Original & X-References..

NIPPONDENSO	126600-3290
TRANSPO	IN6329

RVC Regulator



X L

03-088

FEATURES

B-Circuit
 Voltage Set Point **14.50 V**
 Soft Start **30 %** LRC **5 sec**
 Field Shorted Circuit Protection
 Under Voltage Indication
 Over Voltage Indication

Original & X-References..

03-089

FEATURES

B-Circuit
 Voltage Set Point **14.80 V**
 Soft Start **32 %** LRC **5 sec**
 Field, Lamp Shorted Circuit Protection
 Under Voltage Indication
 Over Voltage Indication

Original & X-References..

NIPPONDENSO	126600-0030
	126600-0031
MOBILETRON	VR-H2005-94
LESTER	11035 13919
TRANSPO	IN6003



03-090

FEATURES

B-Circuit
 Voltage Set Point **14.80 V**
 Soft Start **32 %** LRC **5 sec**
 Field, Lamp Shorted Circuit Protection
 Under Voltage Indication
 Over Voltage Indication

Original & X-References..

NIPPONDENSO	126600-0090
MOBILETRON	VR-H2005-104
LESTER	11003 11036
TRANSPO	IN6009

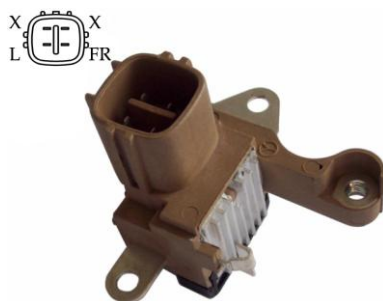

03-091

FEATURES

B-Circuit
 Voltage Set Point **14.50 V**
 Soft Start **32 %** LRC **5 sec**
 Field, Lamp Shorted Circuit Protection
 Under Voltage Indication
 Over Voltage Indication
 DFM function

Original & X-References..

NIPPONDENSO	126600-3080
LESTER	11062
TRANSPO	IN6308

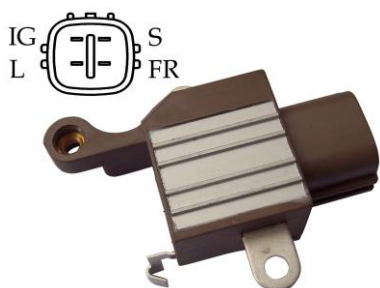

03-092

FEATUERS

B-Circuit
 Voltage Set Point **14.30 V**
 Soft Start **32 %**
 Field, Lamp Shorted Circuit Protection
 Sense open indication
 Under Voltage Indication
 Over Voltage Indication
 DFM function

Original & X-References..

NIPPONDENSO	126600-3000
LESTER	11138 11139
TRANSPO	11196 13984
	IN6300

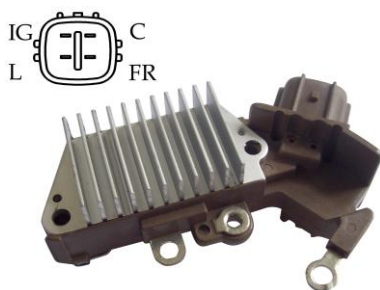

03-094

FEATURES

A-Circuit
 Voltage Set Point **14.00 V**
 Soft Start **30 %** LRC **5 sec**
 Field, Lamp Shorted Circuit Protection
 Under Voltage Indication
 Over Voltage Indication
 DFM function

Original & X-References..



04-001

FEATURES

A-Circuit (Metal Can)
Voltage Set Point **28.10V**

Slip Ring OD: 28mm

Original & X-References..

BOSCH	1197311304
FIAT	93158421
SCANIA	117253 362645
VOLVO	1606935 1625880
MOBILETRON	VR-B209
USI	71-40021
CARGO	135856
TRANSPO	IB363



04-110

A-Circuit
Voltage Set Point **28.50V**



04-002

FEATURES

A-Circuit (Metal Can)
Voltage Set Point **28.50 V**
Field Shorted Circuit Protection
O.E. Grade

Original & X-References..

PRESTOLITE	271
------------	-----



04-003

FEATURES

A-Circuit (Metal Can)
Voltage Set Point **28.50V**
O.E. Grade
With Wiring: 70mm

Original & X-References..

JFZ2929

04-041

A-Circuit (Metal Can)
Voltage Set Point **14.50V**



04-006

FEATURES

A-Circuit (Metal Can)
Voltage Set Point **28.50 V**

Slip Ring OD : 28 mm

Original & X-References..

BOSCH	
1197311315	0192053003
0192053009	0192053012
0192053014	0192053025
0190457001	
MERCEDES-BENZ	
0001549606	0021543506
0021545506	0021545606
CARGO	131340
TRANSPO	IB381 IB382

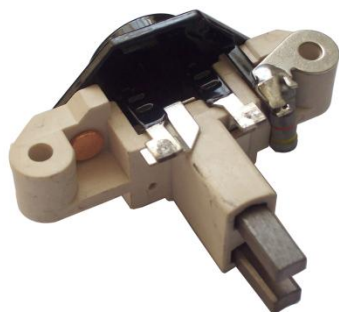

04-008

FEATURES

A-Circuit (Metal Can)
Voltage Set Point **14.60 V**
With 180 Ohm Resistor
Slip Ring OD: 14mm

Original & X-References..

BOSCH	
1197311211	1197311213
1197311217	1197311219
1197311242	1197311541
MOBILETRON	VR-B201
TRANSPO	IB387



04-009

FEATURES

A-Circuit (Metal Can)
Voltage Set Point **14.50 V**
O.E. Grade

Original & X-References..

04-052

A-Circuit (Metal Can)
Voltage Set Point **28.50 V**
Without Protect cover
O.E. Grade



04-010

FEATURES

A-Circuit (Metal Can)
Voltage Set Point **28.10 V**

Original & X-References..

04-032

A-Circuit (Metal Can)
Voltage Set Point **14.50 V**

LADA	
ALTERNATOR	VAZ 2110

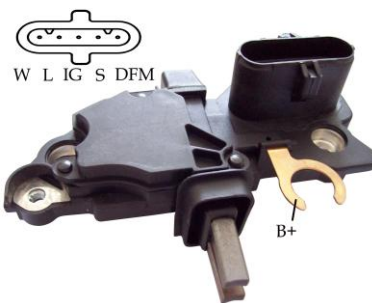

04-011

FEATURES

B-Circuit
Voltage Set Point **28.50V**
Soft Start **30 %**
LRC **5 sec**
Field Shorted Circuit Protection
IG Open Indication
Under Voltage Indication
Over Voltage Indication
DFM function

Original & X-References..

BOSCH	
F00M 145256	F00M 145298
F00M 145302	F00M 145307
F00M 145237	F00M 145299
MERCEDES-BENZ	0001542705
SCANIA	1501245
TRANSPO	IB298

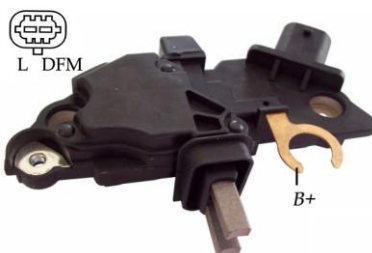

04-014

FEATURES

A-Circuit
Voltage Set Point **14.60 V**
Soft Start **30 %**
LRC **5 sec**
Field Shorted Circuit Protection
Under Voltage Indication
Over Voltage Indication
DFM function

Original & X-References..

BOSCH	F00M 145371
	F00M 145283
	F00M 145228
SCANIA	12790483
CARGO	231716
LESTER	23106
TRANSPO	IB283

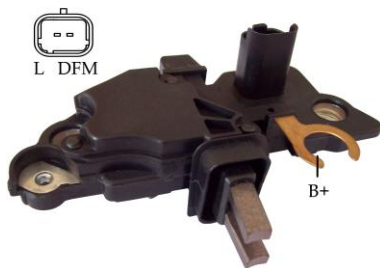

04-015

FEATURES		Original & X-References..	
A-Circuit		BOSCH	F00M 145239
Voltage Set Point	14.60V		F00M 145204
Soft Start	30 %		F00M 145387
LRC	5 sec	RENAULT	7701048230
Field Shorted Circuit Protection		CARGO	230624
Under Voltage Indication		LESTER	21504 23751
Over Voltage Indication		TRANSP0	IB239
DFM function			

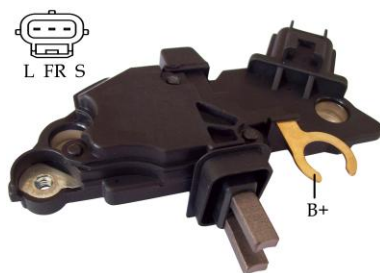

04-020

FEATURES		Original & X-References..	
A-Circuit		BOSCH	F00M 145235
Voltage Set Point	14.60V	MOBILETRON	VR-B262
Soft Start	30 %	CARGO	233508
LRC	5 sec	TRANSP0	IB235
Field Shorted Circuit Protection			IB255
Under Voltage Indication			
Over Voltage Indication			
DFM function			

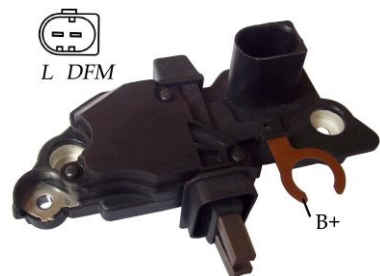

04-022

FEATURES		Original & X-References..	
A-Circuit		BOSCH	
Voltage Set Point	14.60 V	F00M 145225	F00M 145200
Soft Start	30 %	F00M 145209	F00M 145223
LRC	5 sec	F00M 145233	F00M 145333
Field Shorted Circuit Protection		F00M 145350	F00M 145353
Under Voltage Indication		MERCEDES-BENZ	0031542406
Over Voltage Indication		RENAULT	5001850026
DFM function		MOBILETRON	VR-B254
		CARGO	139925
		TRANSP0	IB225

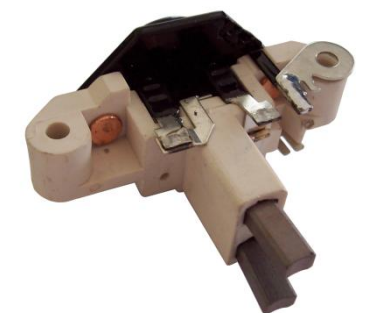

04-023

FEATURES		Original & X-References..	
A-Circuit	(Metal Can)		
Voltage Set Point	28.50 V		
Slip Ring OD:	14mm		

04-064

A-Circuit	
Voltage Set Point	28.50 V
With	430 OHM Resistor
Slip Ring OD:	14mm

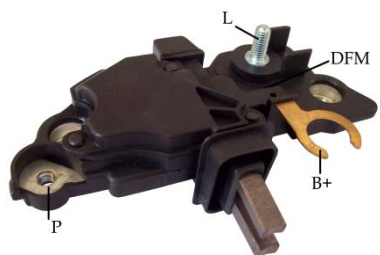

04-024

FEATURES		Original & X-References..	
A-Circuit		BOSCH	
Voltage Set Point	14.60 V	F00M 145201	F00M 145231
Soft Start	30 %	F00M 145257	F00M 145282
LRC	5 sec	F00M 145362	F00M 145370
Field Shorted Circuit Protection		MERCEDES-BENZ	
Under Voltage Indication		0031541506	0031545606
Over Voltage Indication		SA AB 5353552	
DFM function		CARGO	139044
		TRANSP0	IB231

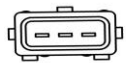

IG L DFM

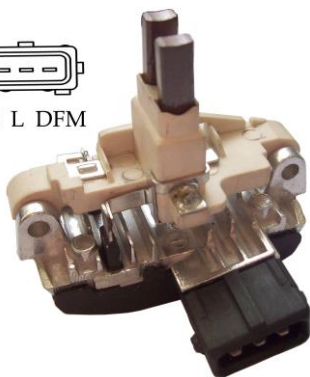

04-025

FEATURES

A-Circuit
 Voltage Set Point **14.50 V**
 Soft Start **32 %**
 LRC **5 sec**
 Field Shorted Circuit Protection
 IG Open Indication
 Under Voltage Indication
 Over Voltage Indication
 DFM function

Original & X-References..

BOSCH	1197311506	1197311516
	1197311536	1197311545
	1197311557	1197311547
AUDI/VW	037903803A	038903803C
BMW		12311435432
		12311713491
CARGO		138999
TRANSPO		IB545



L

DFM

B+

P

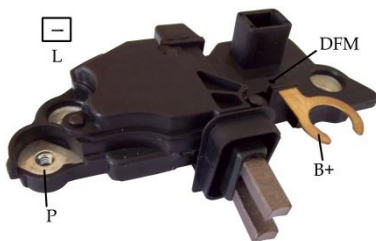

04-026

FEATURES

A-Circuit
 Voltage Set Point **14.60 V**
 Soft Start **30 %**
 LRC **5 sec**
 Field Shorted Circuit Protection
 Under Voltage Indication
 Over Voltage Indication
 DFM function

Original & X-References..

BOSCH	F00M 145229
	F00M 145208
	F00M 145351
CARGO	232927
TRANSPO	IB229

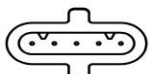

W L IG C NC

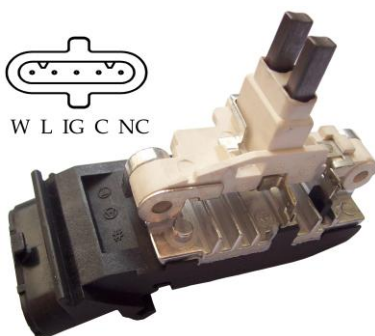

04-027

FEATURES

B-Circuit
 Voltage Set Point **28.50 V**
 Soft Start **30 %**
 Field Shorted Circuit Protection
 IG Open Indication
 Under Voltage Indication
 Over Voltage Indication

Original & X-References..

BOSCH1	197311558
	1197311554
	0272220217
MAN	81256010025
CARGO	234522
TRANSPO	IB558



DFM L



04-028

FEATURES

A-Circuit
 Voltage Set Point **14.60V**
 Soft Start **30 %**
 LRC **5 sec**
 Field Shorted Circuit Protection
 Under Voltage Indication
 Over Voltage Indication
 DFM Function

Original & X-References..

FOR MERCEDES-BENZ	
CARGO	235528

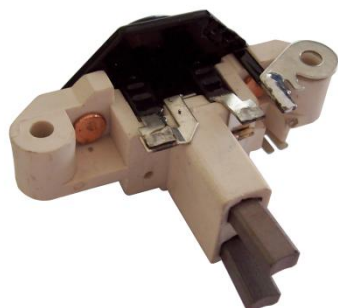

04-031

FEATURES

A-Circuit (**Metal Can**)
 Voltage Set Point **14.50 V**
 Slip Ring OD: 14mm

Original & X-References..

BOSCH		
	1197311212	1197311214
	1197311220	1197311221
	1197311223	1197311224
WAI		35-9108
TRANSPO		IB385



04-035

FEATURES

- A-Circuit
- Voltage Set Point **14.60 V**
- Soft Start **30 %**
- LRC **5 sec**
- Field Shorted Circuit Protection
- IG Open Indication
- Under Voltage Indication
- Over Voltage Indication

Original & X-References..

- FOR BMW
- WATER COOLING ALTERNATOR
- CARGO 235460

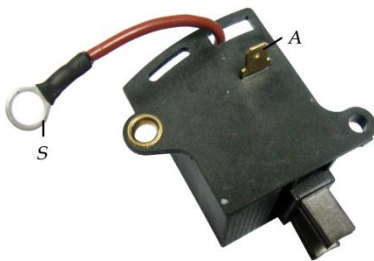

04-039

FEATURES

- A-Circuit
- Voltage Set Point **14.50 V**

Original & X-References..

- LADA 21083701500
- 5676255 173702
- LUCAS 21229189 UCB 902
- MAGNETI MARELLI
- 9400 38111
- TRANSPO IR673

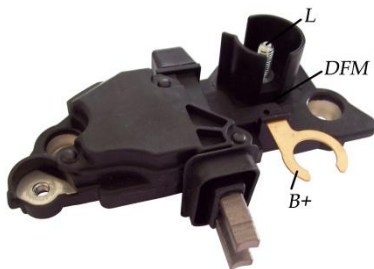

04-042

FEATURES

- A-Circuit
- Voltage Set Point **14.60V**
- Soft Start **30 %**
- LRC **5 sec**
- Field Shorted Circuit Protection
- Under Voltage Indication
- Over Voltage Indication
- DFM Function

Original & X-References..

- BOSCH F00M 145220
- CARGO 230249
- TRANSPO IB220



04-043

FEATURES

- B-Circuit
- Voltage Set Point **28.50 V**
- Soft Start **30 %**
- Field Shorted Circuit Protection
- IG / Sense Open Indication
- Under Voltage Indication
- Over Voltage Indication

Original & X-References..

- BOSCH 1197311543
- CARGO 234112

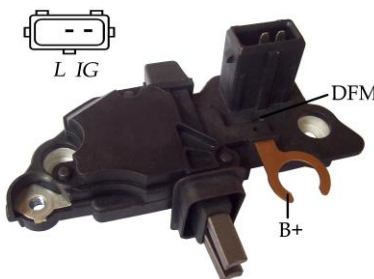

04-045

FEATURES

- A-Circuit
- Voltage Set Point **14.60 V**
- Soft Start **30 %**
- LRC **5 sec**
- Field Shorted Circuit Protection
- Under Voltage Indication
- Over Voltage Indication
- DFM Function

Original & X-References..

- BOSCH F00M 145251
- F00M 145245
- F00M 145360
- TRANSPO IB251



04-048

FEATURES

A-Circuit (Metal Can)
Voltage Set Point **14.50 V**
O.E. Grade

Original & X-References..

04-066

A-Circuit (Metal Can)
Voltage Set Point **28.50V**
O.E. Grade

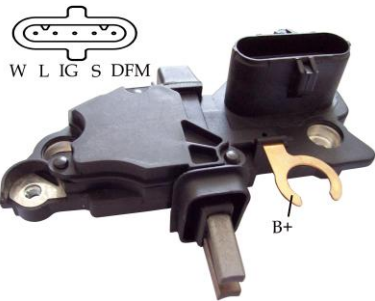

04-051

FEATURES

B-Circuit
Voltage Set Point **28.50 V**
Soft Start **30 %**
LRC **5 sec**
Field Shorted Circuit Protection
Sense / IG Open Indication
Under Voltage Indication
Over Voltage Indication
DFM Function

Original & X-References..

BOSCH		
F00M144103	F00M144119	
F00M145246	F00M145297	
LESTER	12591	12599
	220-5306/5293/5295	
CARGO	233117	
TRANSPO	IB297	

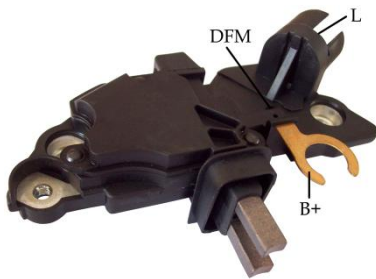

04-053

FEATURES

B-Circuit
Voltage Set Point **14.50V**
Soft Start **30 %**
Field Shorted Circuit Protection
Under Voltage Indication
Over Voltage Indication
DFM Function
Self Exciting Function

Original & X-References..

BOSCH	F00M 145252
	F00M 145243
	F00M 145270
CARGO	232193
TRANSPO	IB252

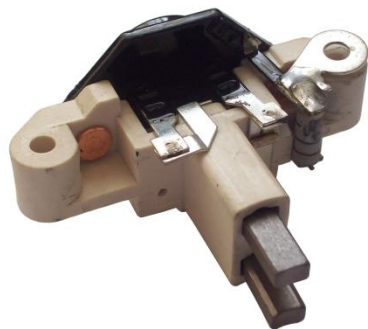

04-063

FEATURES

A-Circuit (Metal Can)
Voltage Set Point **14.60V**
With 180 Ohm Resister
Slip Ring OD: 14mm

Original & X-References..

BOSCH	1197311529
TRANSPO	IB529

04-054

A-Circuit (Metal Can)
Voltage Set Point **14.60V**
No 180 Ohm Resister
Slip Ring OD: 14mm

BOSCH	1197311548	
	1197311500	1197311523
	1197311530	1197311531
TRANSPO	IB388	



04-055

FEATURES

A-Circuit (Metal Can)
Voltage Set Point **14.60 V**
Slip Ring OD: 32mm

Original & X-References..

BOSCH	1197311032
MOBILETRON	VR-B260
TRANSPO	IB368

04-056

A-Circuit (Metal Can)
Voltage Set Point **28.10 V**
Slip Ring OD: 32mm

BOSCH	1197311310
	1197311313
TRANSPO	IB369

For use on: Engine Truck



04-057

FEATURES

- A-Circuit
- Voltage Set Point **14.50 V**
- Soft Start **30 %**
- LRC **5 sec**
- Field Lamp Choke Shorted Circuit Protection
- Under Voltage Indication
- Over Voltage Indication

Original & X-References..

LADA TRT3-01

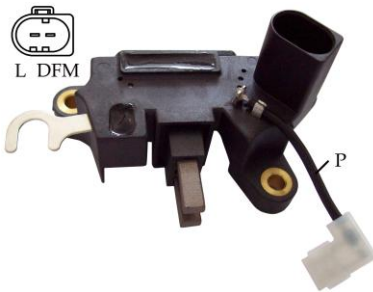

04-058

FEATURES

- B-Circuit
- Voltage Set Point **14.50 V**
- Soft Start **18 %**
- LRC **10 sec**
- Field Lamp Choke Shorted Circuit Protection
- Under Voltage Indication
- Over Voltage Indication

Original & X-References..

LADA TRT5

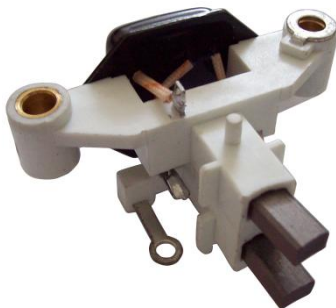

04-067

FEATURES

- A-Circuit
- Voltage Set Point **14.60 V**
- Low Cut-in Speed
- Slip Ring OD: 32mm

Original & X-References..

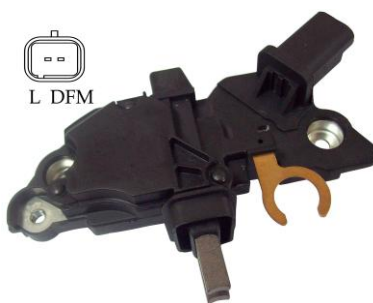

04-069

FEATURES

- B-Circuit
- Voltage Set Point **14.50 V**
- Soft Start **30%** LRC **5 sec**
- Lamp Shorted Circuit Protection
- Field Shorted Circuit Protection
- P Terminal Self Exciting Function
- Under/ Over Voltage Indication
- DFM Function
- Self Exciting Function

Original & X-References..

BOSCH	F00M 145286
	F00M 145394
CARGO	234770
TRANSP0	IB286

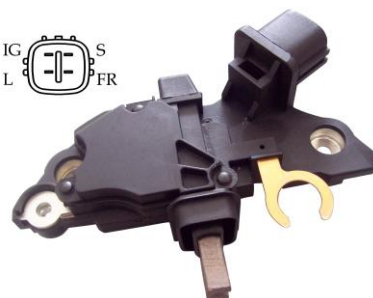

04-071

FEATURES

- A-Circuit
- Voltage Set Point **14.50 V**
- Soft Start **32%**
- LRC **5 sec**
- Field, Shorted Circuit Protection
- Sense IG Open Indication
- Under Voltage Indication
- Over Voltage Indication
- DFM Function

Original & X-References..

BOSCH	F00M 145873
	F00M 145236
CARGO	233587
TRANSP0	IB236



04-072

FEATURES

A-Circuit
 Voltage Set Point **14.60 V**
 Low Cut-in Speed
 Slip Ring OD: 28mm

Original & X-References..

BOSCH
 0192052033 0192053032
 1197311029 1197311030
 1197311031 1197311034
 MOBILETRON VR-B195M
 USI 71-40002
 WAI 35-9117
 CARGO 132666
 TRANSPO IB360



L DFM



04-078

FEATURES

A-Circuit
 Voltage Set Point **14.50 V**
 Soft Start **19 %**
 LRC **9 sec**
 Field, Lamp Shorted Circuit Protection
 Under Voltage Indication
 Over Voltage Indication
 DFM Function

Original & X-References..

BOSCH
 F00M 346010 F00M 346015
 F00M 346026 F00M 346087
 LESTER 23925 23977
 TRANSPO IB6026



04-080

FEATURES

A-Circuit **(Metal Can)**
 Voltage Set Point **14.50V**
 Slip Ring OD: 32mm

Original & X-References..

BOSCH
 1197311000 1197311001
 1197311002 1197311090
 2197311090
 TRANSPO IB350



04-034

A-Circuit
 Voltage Set Point **14.50V**
 Slip Ring OD: 32mm

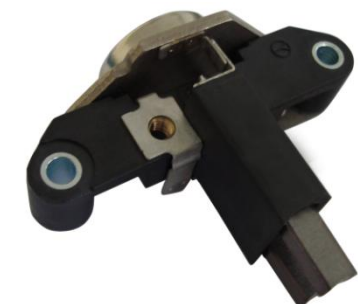

04-081

FEATUERS

A-Circuit **(Metal Can)**
 Voltage Set Point **14.50 V**

Original & X-References..

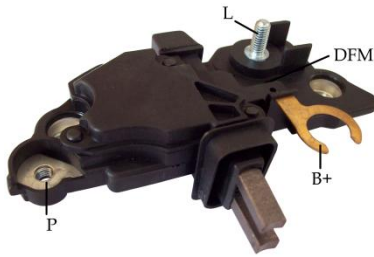

04-082

FEATURES

A-Circuit
 Voltage Set Point **14.60 V**
 Soft Start **30 %** LRC **5 sec**
 Field Shorted Circuit Protection
 Under/ Over Voltage Indication
 DFM Function
 Self Exciting Function

Original & X-References..

BOSCH	F00M 145249
	F00M 145260
	F00M 145325
TRANSPO	IB260

04-104

Voltage Set Point **28.20V**
 Circuit Protection



04-084

FEATURES

A-Circuit (Metal Can)
 Voltage Set Point **14.50 V**
 Slip Ring OD: 28mm

 For use on: Alfa Romeo, Audi,
 Chrysler, Porsche, VW, Volvo

Original & X-References..

BOSCH		
	1192052015	1192052016
	1192052020	1192052021
	1192052024	1192052025
USI		71-40002
WAI		35-9104
TRANSPO		IB352



04-083

FEATUERS

A-Circuit
 Voltage Set Point **14.40 V**

Original & X-References..

BOSCH	9190087003
	9121080303
WAI	35-9127
LESTER	13080
MOBILETRON	VR-B211
TRANSPO	IB359



04-085A

FEATUERS

A-Circuit
 Voltage Set Point **14.40 V**

Original & X-References..

CINAP GA009/2.212/2



04-0851

FEATUERS

A-Circuit
 Voltage Set Point **14.40V**

Original & X-References..

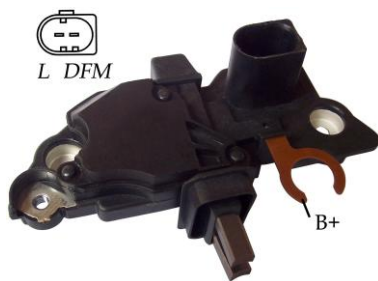

04-086

FEATUERS

A-Circuit
 Voltage Set Point **14.60 V**
 Soft Start **30 %**
 LRC **5 sec**
 Field Circuit Protection
 Under Voltage Indication
 Over Voltage Indication
 DFM function

Original & X-References..

BOSCH	FOOM145247
	FOOM145357
CARGO	235207
TRANSPO	IB247



04-087

FEATUERS

A-Circuit
 Voltage Set Point **14.40 V**

Original & X-References..

BOSCH	0192052001/2/4
TRANSPO	IB358-1



04-088

FEATUERS

A-Circuit
 Voltage Set Point **14.40 V**

Original & X-References..

BOSCH	9190087032
	190087026
MOBILETRON	VR-B103

04-095

A-Circuit
 Voltage Set Point **28.10 V**

BOSCH	9190087018
190087014	0192053006

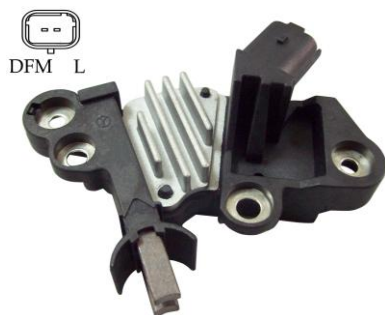

04-089

FEATUERS

B-Circuit
 Voltage Set Point **14.50 V**
 Soft Start **19 %**
 LRC **9 sec**
 Field, Lamp Shorted Circuit Protection
 Under Voltage Indication
 Over Voltage Indication
 DFM function

Original & X-References..

BOSCH	FOOM 346340
-------	-------------

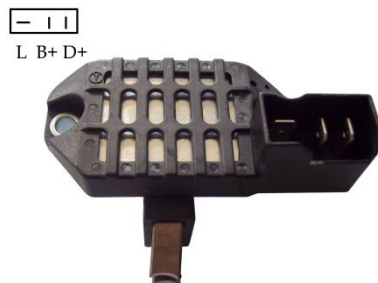

04-092

FEATUERS

A-Circuit
 Voltage Set Point **14.50 V**

Original & X-References..



04-096

FEATURES

A-Circuit (Metal Can)
Voltage Set Point **14.60 V**

Original & X-References..

ISKRA 11125204 11125165
IK5444

04-109

A-Circuit (Metal Can)
Voltage Set Point **28.50 V**



04-097

FEATUERS

B-Circuit
Voltage Set Point **14.10 V**

Original & X-References..

BOSCH 9190456007
IK413HD



04-099

FEATUERS

A-Circuit
Voltage Set Point **14.60 V**

Original & X-References..

BOSCH 9190547002
9120450041
IK586

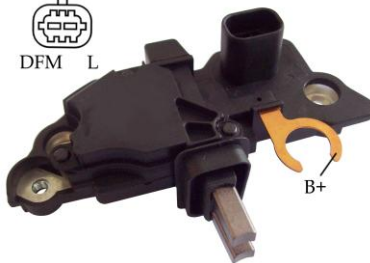

04-100

FEATUERS

B-Circuit
Voltage Set Point **14.50V**
Soft Start **30 %**
Field Shorted Circuit Protection
Under Voltage Indication
Over Voltage Indication
DFM Function
Self Exciting Function

Original & X-References..

BOSCH F00M 144109
F00M 144160
LESTER 23817
TRANSP0 IB160

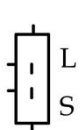

04-103

FEATUERS

A-Circuit
Voltage Set Point **14.50 V**

Original & X-References..

BOSCH 9190041002
TRANSP0 IB501

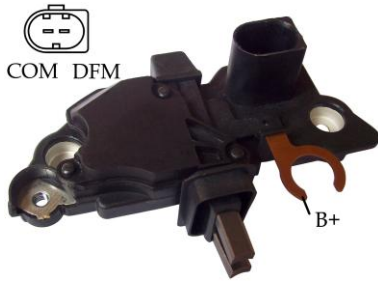

04-106

FEATUERS **Original & X-References..**

A-Circuit
 Voltage Set Point **14.80 V**
 Soft Start **17 %**
 LRC **4 sec**
 Self Exciting Function

BOSCH F00M144147

BSS Regulator



04-107

FEATUERS **Original & X-References..**

A-Circuit
 Voltage Set Point **14.80 V**
 Soft Start **17 %**
 LRC **4 sec**
 Self Exciting Function

BOSCH F00MA45221 F00M145880

BSS Regulator

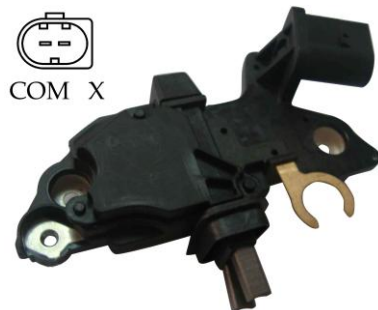

04-108

FEATUERS **Original & X-References..**

A-Circuit
 Voltage Set Point **14.80 V**
 Soft Start **17 %**
 LRC **4 sec**
 Self Exciting Function

BOSCH F00MA45221 F00M145880

BSS Regulator



04-112

FEATUERS **Original & X-References..**

A-Circuit
 Voltage Set Point **14.30 V**

BOSCH 9190087039 9190087040 IK5541

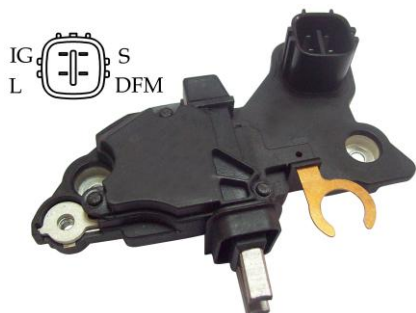

04-114

FEATUERS **Original & X-References..**

A-Circuit
 Voltage Set Point **14.50 V**
 Soft Start **32 %** LRC **5 sec**
 Field Shorted Circuit Protection
 IG / Sense Open Indication
 Under/ Over Voltage Indication
 DFM Function

BOSCH F00M145875

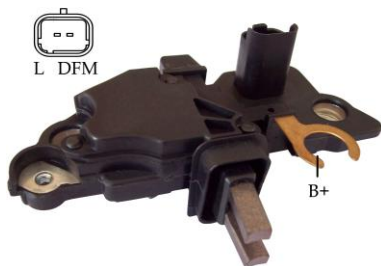

04-115

FEATURES	Original & X-References..	
A-Circuit	BOSCH	F00M 144110
Voltage Set Point 14.60V		
Soft Start 30 %		
LRC 5 sec		
Field Shorted Circuit Protection		
Under Voltage Indication		
Over Voltage Indication		
DFM function		

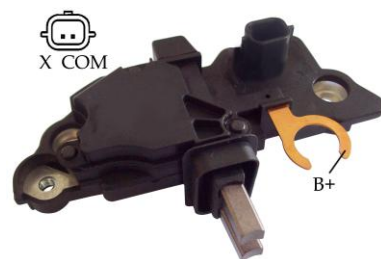

04-116

FEATUERS	Original & X-References..	
A-Circuit	BOSCH	F00M145304
Voltage Set Point 14.80 V	F00M144131	F00M145321
Soft Start 17 %	TRANSPO	IB321
LRC 4 sec		
Self Exciting Function		

BSS Regulator

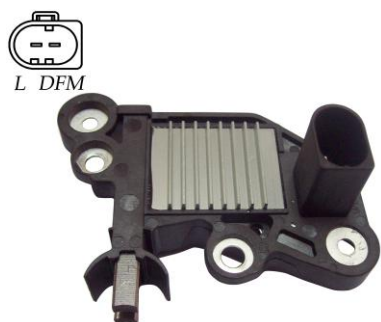

04-117

FEATUERS	Original & X-References..	
B-Circuit	IK5027	
Voltage Set Point 14.50 V		
Soft Start 30 % LRC 5 sec		
Field Shorted Circuit Protection		
L Terminal Drives Choke		
Under/ Over Voltage Indication		
DFM Function		
Self Exciting Function		



04-118

FEATURES	Original & X-References..	
B-Circuit	BOSCH	
Voltage Set Point 13.70 V	F00M346056	F00M346097
LRC 3 sec		
Self Exciting Function		

LIN Regulator



04-119

FEATURES	Original & X-References..	
B-Circuit	BOSCH	
Voltage Set Point 14.00 V	F00M346081	
LRC 3 sec		
Self Exciting Function		

LIN Regulator



04-121

FEATUERS	Original & X-References..	
B-Circuit	BOSCH	
Voltage Set Point 14.50 V	1275105104	1907107613
Soft Start 30 % LRC 5 sec		
Field Shorted Circuit Protection		
L Terminal Drives Choke		
Under/ Over Voltage Indication		
DFM Function		
Self Exciting Function		



04-122

FEATURES	Original & X-References..	
A-Circuit	BOSCH	
Voltage Set Point 14.80 V	F00M346135	
Soft Start 17 %		
LRC 4 sec		
Self Exciting Function		
BSS Regulator		



04-124

FEATURES	Original & X-References..	
A-Circuit	BOSCH	
Voltage Set Point 14.50 V	9191067049	9191067059
Soft Start 30 %	CARGO	231237
Field Shorted Circuit Protection	MOBILETRON	VR-B393
Under Voltage Indication	TRANSPO	IB343
Over Voltage Indication		

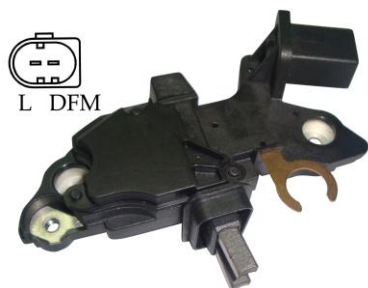

04-125

FEATURES	Original & X-References..	
A-Circuit	BOSCH	
Voltage Set Point 14.20 V	F00M145266	F00M144155
Soft Start 30 %	MOBILETRON	VR-B883
LRC 5 sec	LESTER	23269 23344
Field Shorted Circuit Protection	TRANSPO	IB266
Under Voltage Indication		
Over Voltage Indication		
DFM function		

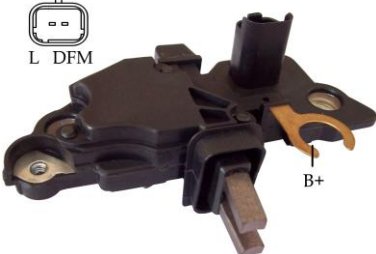

04-126

FEATURES	Original & X-References..	
A-Circuit	BOSCH	
Voltage Set Point 14.60V	F00M145276	
Soft Start 30 % LRC 5 sec	F00M145368	
Field Shorted Circuit Protection	LESTER	23367 23368
Under Voltage Indication	23369	23540 23542
Over Voltage Indication	TRANSPO	IB276
DFM function		
Self Exciting Function		
For use on: Nissan, Renault (Europe)		



04-128

FEATURES	Original & X-References..
B-Circuit	IK5028
Voltage Set Point 14.50 V	
Soft Start 30 % LRC 5 sec	
Field Shorted Circuit Protection	
L Terminal Drives Choke	
Under/ Over Voltage Indication	
DFM Function	
Self Exciting Function	



04-130

FEATURES	Original & X-References..
A-Circuit	
Voltage Set Point 14.50 V	



04-131

FEATURES	Original & X-References..
B-Circuit	BOSCH F00M 145330
Voltage Set Point 14.70 V	
Soft Start 30 % LRC 5 sec	
Field Shorted Circuit Protection	
Under/ Over Voltage Indication	
DFM Function	

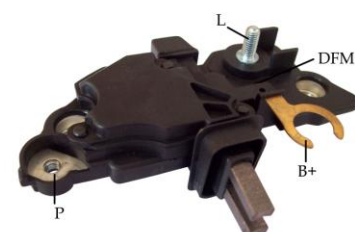

04-133

FEATURES	Original & X-References..
A-Circuit	BOSCH F00M145227
Voltage Set Point 14.70 V	MOBILETRON VR-B265
Soft Start 30 % LRC 5 sec	LESTER 13805
Field Shorted Circuit Protection	TRANSPO IB227
Under/ Over Voltage Indication	
DFM Function	

For use on: (2005-00) Saturn



04-134

FEATURES	Original & X-References..
A-Circuit	BOSCH F00M145224
Voltage Set Point 14.60 V	F00M145241
Soft Start 30 %	LESTER 13770 13771 13860
LRC 5 sec	TRANSPO IB241
Field Shorted Circuit Protection	
Under Voltage Indication	
Over Voltage Indication	



04-136

FEATURES

Original & X-References..

A-Circuit
Voltage Set Point **14.10 V**

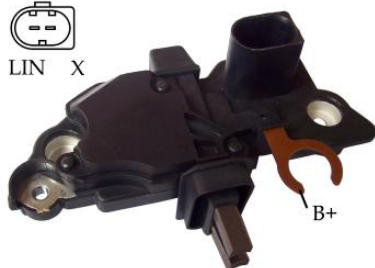

04-140

FEATURES

Original & X-References..

B-Circuit
Voltage Set Point **14.00 V**
LRC **3 sec**
Self Exciting Function

BOSCH F00M145698
F00M144150 F00M145665

LIN Regulator

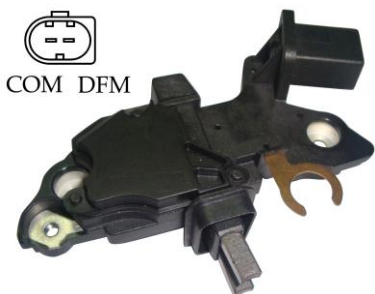

04-141

FEATURES

Original & X-References..

A-Circuit
Voltage Set Point **14.80 V**
Soft Start **17 %**
LRC **4 sec**
Self Exciting Function

BOSCH F00M145292
F00M144108 F00M144132
F00M145374 F00M145884

BSS Regulator



04-142

FEATURES

Original & X-References..

A-Circuit
Voltage Set Point **14.80 V**
Soft Start **17 %**
LRC **4 sec**
Self Exciting Function

BOSCH F00M346066

BSS Regulator



04-143

FEATURES

Original & X-References..

B-Circuit
Voltage Set Point **14.00 V**
LRC **3 sec**
Self Exciting Function

BOSCH F00M144157

LIN Regulator



LIN X



04-144

FEATURES

B-Circuit
Voltage Set Point **14.00 V**
LRC **3 sec**
Self Exciting Function

Original & X-References..

BOSCH F00M346074

LIN Regulator



LIN X



04-145

FEATURES

B-Circuit
Voltage Set Point **14.00 V**
LRC **3 sec**
Self Exciting Function

Original & X-References..

BOSCH
F00M346021 F00M346037
F00M346047 F00M346080

LIN Regulator



L DFM



04-146

FEATURES

B-Circuit
RVC=0 Vset=**13.80V**
RC=**70%** Vset=**14.45V**
Soft Start **18.75 %**
LRC **2.5 sec**
DFM function

Original & X-References..

BOSCH
F00M145314 F00M145328
F00M145696
LESTER 11075 11125
11126 11127 11185 11234
TRANSP0 IB314 IB696

RVC Regulator



COM X

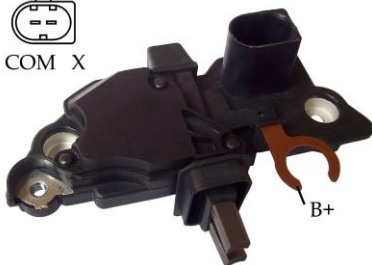

04-147

FEATUERS

A-Circuit
Voltage Set Point **14.80 V**
Soft Start **17 %**
LRC **4 sec**
Self Exciting Function

Original & X-References..

BOSCH F00MA45219

BSS Regulator

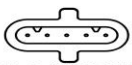

W L IG S DFM

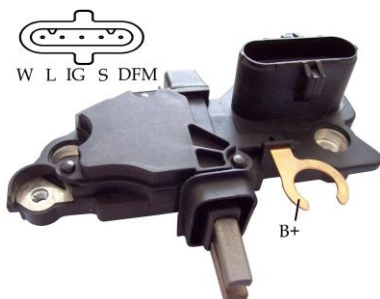

04-150

FEATURES

B-Circuit
Voltage Set Point **28.50V**
Soft Start **30 %**
LRC **5 sec**
Field Shorted Circuit Protection
IG Open Indication
Under Voltage Indication
Over Voltage Indication
DFM function

Original & X-References..

BOSCH
F00M 144106 F00M 144122
F00M 145294 F00M 145300
LESTER 23883
TRANSP0 IB5300

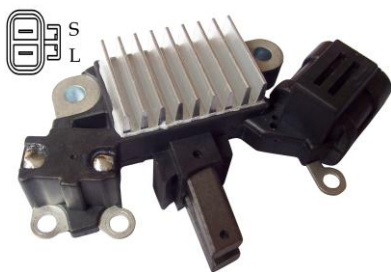

05-001

FEATURES	Original & X-References..	
A-Circuit	HITACHI	LR180-756B
Voltage Set Point 14.40 V		LR1100-702
Soft Start 30 %	MOBILETRON	VR-H2000-44
Field Shorted Circuit Protection	CARGO	234612
Under Voltage Indication	TRANSPO	IH738
Over Voltage Indication		

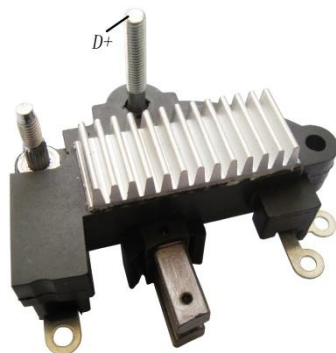

05-002

FEATURES	Original & X-References..	
A-Circuit		
Voltage Set Point 14.70 V		



05-003

FEATURES	Original & X-References..	
A-Circuit	HITACHI	8-9711264-6
Voltage Set Point 28.60 V		

05-024

B-Circuit	HITACHI	LR180-501
Voltage Set Point 14.70V	CARGO	137584

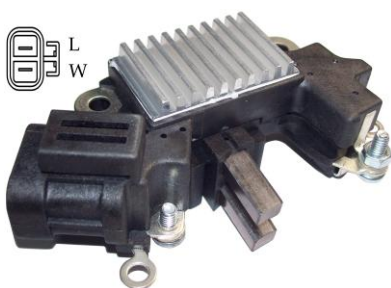

05-004

FEATURES	Original & X-References..	
A-Circuit	HITACHI	L170G-3319
Voltage Set Point 14.40 V		L170G-6308
Soft Start 30 %		L170G-7315
Field Shorted Circuit Protection	MOBILETRON	VR-H2000-41
Under Voltage Indication	CARGO	139980
Over Voltage Indication	UNIPOINT	YR-713
	TRANSPO	IH776



05-007

FEATURES	Original & X-References..	
A-Circuit	HITACHI	L150-93155
Voltage Set Point 14.70 V		L160-23153
	MOBILETRON	VR-H2000-30
	CARGO	137189
	WAI	35-8136
	TRANSPO	IH205

05-032

A-Circuit	HITACHI	L225-9315
Voltage Set Point 28.40 V	CARGO	234701

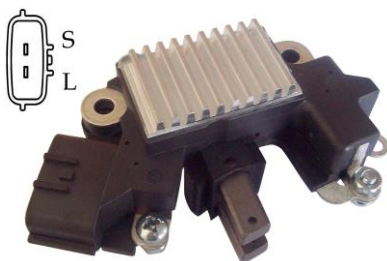

05-008

FEATURES

A-Circuit
 Voltage Set Point **14.50 V**
 Soft Start **30 %**
 Field Shorted Circuit Protection
 Sense Open Indication
 Under / Over Voltage Indication

Original & X-References..

HITACHI	L1100G-3340
	L1110G-9340
	L1125G-1340
MOBILETRON	VR-H2000-28
CARGO	138717
WAI	35-8127
UNIPOINT	YR-715
TRANSPO	IH766

05-059

Without Brush Holder

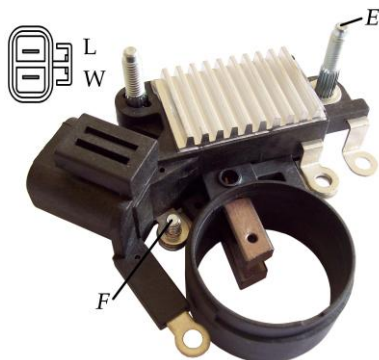

05-009

FEATURES

A-Circuit
 Voltage Set Point **14.50 V**
 Soft Start **30 %**
 Sense Open Indication
 Under Voltage Indication
 Over Voltage Indication

Original & X-References..

HITACHI	TR1E-123
LR1100	501
	502B
CARGO	230433

05-089

Without Brush Holder

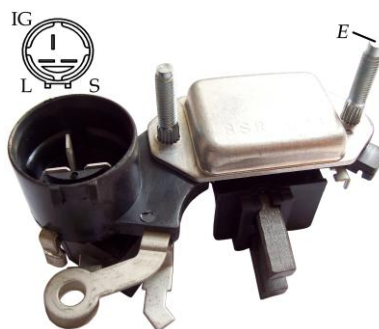

05-010

FEATURES

A-Circuit
 Voltage Set Point **14.70 V**

Original & X-References..

HITACHI	L150-33155
CARGO	133544
TRANSPO	IH252V

05-048

Without Capacitor

TRANSPO IH252

For use on: Industrial



05-011

FEATURES

A-Circuit
 Voltage Set Point **14.70 V**

Original & X-References..

HITACHI	FA8065A
	L170-G1315
TRANSPO	IH254V

05-056

Without Capacitor

TRANSPO IH254

For use on: Isuzu and Opel
 Vauxhall Astra 1.7D Ventra



05-012

FEATURES

A-Circuit
 Voltage Set Point **28.40 V**

Original & X-References..

HITACHI	TR2Z-49
TRANSPO	IH253V

05-044

Without Capacitor

TRANSPO IH253

For use on: Nissan Forklift



05-013

FEATURES

A-Circuit
Voltage Set Point **14.60 V**

Original & X-References..



05-014

FEATURES

A-Circuit
Voltage Set Point **14.40 V**
Soft Start **30 %**
Field Shorted Circuit Protection
Under Voltage Indication
Over Voltage Indication

Original & X-References..

HITACHI	LR150-511
	LR1100-502F
	LR170-509E
MOBILETRON	VR-H2000-50
CARGO	232443
TRANSPO	IH769

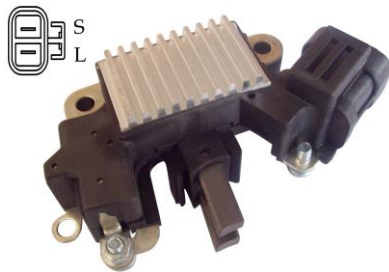

05-015

FEATURES

A-Circuit
Voltage Set Point **14.50 V**
Soft Start **30 %**
Field Shorted Circuit Protection
Sense Open Indication
Under/ Over Voltage Indication

Original & X-References..

HITACHI	L170G-5315
	L170G-6315
	L180G-23401
WAI	35-8126
MOBILETRON	VR-H2000-38
CARGO	138727
UNIPOINT	YR-714
TRANSPO	IH767

05-047

Without Brush Holder

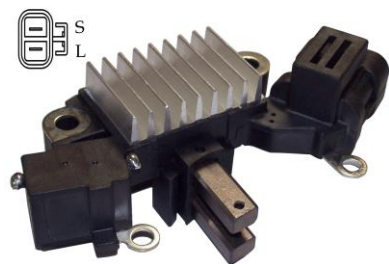

05-016

FEATURES

A-Circuit
Voltage Set Point **28.40 V**
Soft Start **30 %**
Field Shorted Circuit Protection
Sense Open Indication
Under/ Over Voltage Indication

Original & X-References..

HITACHI	LR280-508
ISUZU	8972489141

05-042

Voltage Set Point **14.40 V**
NO Sense Open Indication

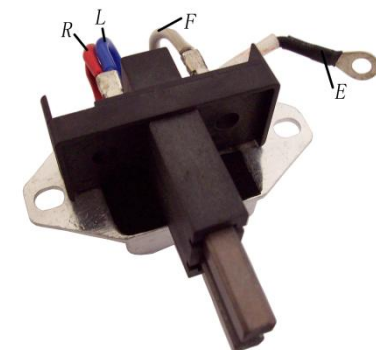

05-017

FEATURES

A-Circuit
Voltage Set Point **28.10 V**

Original & X-References..

For use on:
Nissan Bus, Truck & Industrial,
Hino, Bus, Truck & Industrial



05-020

FEATURES

A-Circuit
Voltage Set Point **14.70 V**
O.E. Grade

Original & X-References..

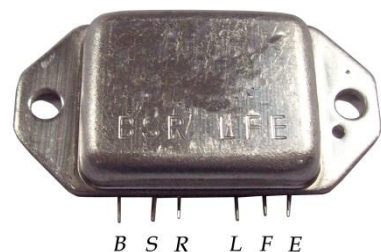

05-021

FEATURES

A-Circuit
Voltage Set Point **14.70 V**

Original & X-References..

HITACHI	L15023155
TR1Z-62	TR1Z64
TR1Z-53	TR1Z43
MOBILETRON	VR-H-2000-3
USI	71-50011
CARGO	136284
	131287
WAI	35-8101
TRANSP0	IH212

05-023

A-Circuit
Voltage Set Point **14.70 V**



For use on: Isuzu Pickup Diesel,
Nissan Maxima Diesel, Sentara, Pickup

05-022

FEATURES

A-Circuit
Voltage Set Point **28.40 V**

Original & X-References..

HITACHI	TR2Z-37	R2Z-49
MOBILETRON	VR-H200-2	
USI	71-50012	
WAI	35-8139	
CARGO	132292	
TRANSP0	IH716	

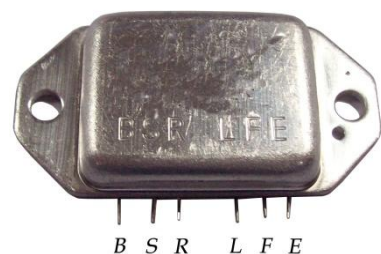

05-025

FEATURES

A-Circuit
Voltage Set Point **14.50 V**
Soft Start **30 %**
Field Shorted Circuit Protection
Sense Open Indication
Under/ Over Voltage Indication

Original & X-References..

HITACHI	L185G-4340
MOBILETRON	VR-H2000-27
WAI	35-8128
TRANSP0	IH765



05-018

Without Brush Holder



05-026

FEATURES	Original & X-References..	
A-Circuit	HITACHI	LR140-708
Voltage Set Point 14.40 V		LR140-708C
	TRANSPO	IH258

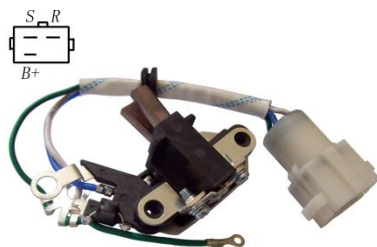

05-027

FEATURES	Original & X-References..	
A-Circuit	HITACHI	LR15078B
Voltage Set Point 14.70 V	TRANSPO	IH204

05-034
Without wire plug



05-028

FEATURES	Original & X-References..	
A-Circuit	HITACHI	L150-73154
Voltage Set Point 14.70 V	MOBILETRON	VR-H2000-36
	CARGO	132432

05-067
A-Circuit
Voltage Set Point 13.75 V



05-030

FEATURES	Original & X-References..	
A-Circuit	HITACHI	IR1Z-27
Voltage Set Point 14.70 V	WAI	35-8100 35-8114
	MOBILETRON	VR-H2000-31
	CARGO	132432
	TRANSPO	IH201

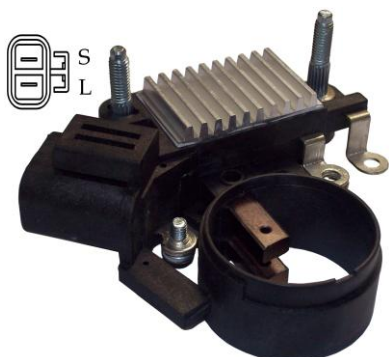

05-035

FEATURES	Original & X-References..	
A-Circuit	HITACHI	LR170-502
Voltage Set Point 14.50 V		
Soft Start 30 %		
Field Shorted Circuit Protection		
Sense Open Indication		
Under Voltage Indication		
Over Voltage Indication		

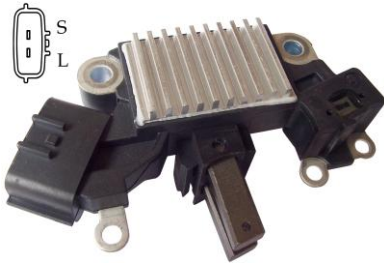

05-036

FEATURES

A-Circuit
 Voltage Set Point **14.40 V**
 Soft Start **30 %**
 Field Shorted Circuit Protection
 Under Voltage Indication
 Over Voltage Indication
 For use on:
 1995-97 Nissan Maxima 3.0L
 1998-99 Nissan Maxima SE 3.0L
 1998-99 Nissan Maxima 130 3.0L

Original & X-References..

MOBILETRON	VR-H2000-46
CARGO	231534
TRANSPO	IH774

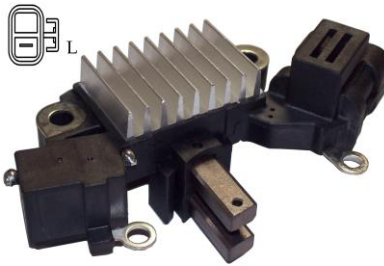

05-037

FEATURES

A-Circuit
 Voltage Set Point **28.40 V**
 Soft Start **30 %**
 Field Shorted Circuit Protection
 Under Voltage Indication
 Over Voltage Indication

Original & X-References..

05-043

Voltage Set Point **14.40 V**

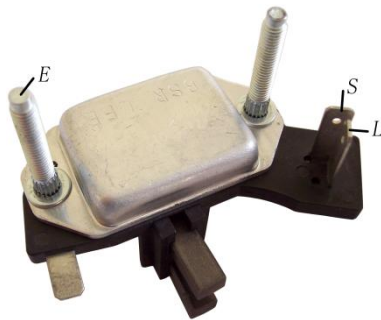

05-040

FEATURES

A-Circuit
 Voltage Set Point **28.40 V**

Original & X-References..

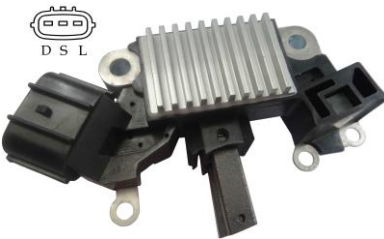

05-041

FEATURES

B-Circuit
 Voltage Set Point **14.50 V**
 Soft Start **30 %** LRC **5 sec**
 Field Shorted Circuit Protection
 Under Voltage Indication
 Over Voltage Indication
 DFM Function
 Self exciting function
 For use on: (2001) Subaru

Original & X-References..

MOBILETRON	VR-H2000-63
LESTER	13829
TRANSPO	IH742

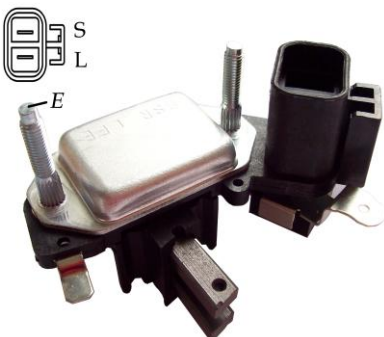

05-046

FEATURES

A-Circuit
 Voltage Set Point **14.70 V**
 With Capacitor

Original & X-References..

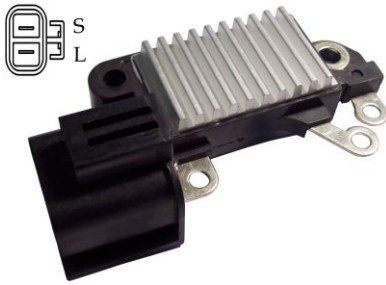

05-052

FEATURES

- A-Circuit
- Voltage Set Point **14.30 V**
- Field Lamp Shorted Circuit Protection
- Sense Open Indication
- Under Voltage Indication
- Over Voltage Indication

Alternators: Hitachi LR165-708C,
LR170-738C,LR170-744,LR180-731B
Nissan 23100-OE700,23100-OE705

Original & X-References..

HITACHI	L180G-2340
NISSAN	23215-85L00
MOBILETRON	ILETR
	VR-H200-16
USI	71-50004
WAI	35-8120
CARGO	135021
TRANSPO	IH761



05-053

FEATURES

- A-Circuit
- Voltage Set Point **14.50 V**
- Soft Start **30 %**
- Field Shorted Circuit Protection
- Under Voltage Indication
- Over Voltage Indication

Original & X-References..

HITACHI	LR1100-508
LR1100-502MD	LR1100-508F
LESTER	23802
TRANSPO	IH669

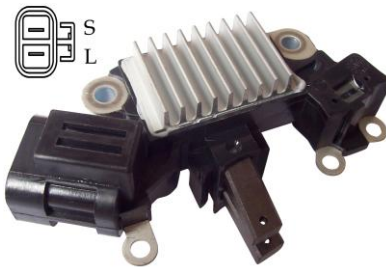

05-054

FEATURES

- A-Circuit
- Voltage Set Point **14.40 V**
- Soft Start **30 %**
- Field Shorted Circuit Protection
- Under Voltage Indication
- Over Voltage Indication

Original & X-References..

HITACHI	L185G-5340
TRANSPO	IH744

For use on: 1999-2000 Honda
Passport 3.2L 1999-2000 Isuzu Rodeo
3.2L Mid 1998-2000 Isuzu Amigo 3.2L

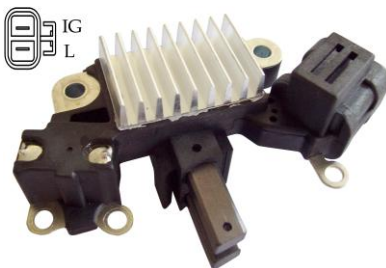

05-055

FEATURES

- A-Circuit
- Voltage Set Point **14.40 V**
- Soft Start **30 %**
- Field Shorted Circuit Protection
- Under Voltage Indication
- Over Voltage Indication

Original & X-References..

05-060

FEATURES

- A-Circuit
- Voltage Set Point **28.10V**

Original & X-References..

HITACHI	27700-1370
	27700-1510
CARGO	133516
TRANSPO	IH708

For use on: Nissan
Bus Truck & Industrial Hino





05-063

FEATURES

A-Circuit
Voltage Set Point **28.40 V**

Original & X-References..

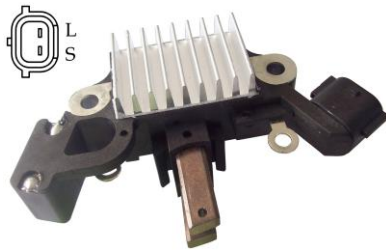

05-065

FEATURES

A-Circuit
Voltage Set Point **14.40 V**
Soft Start **30 %**
Field Shorted Circuit Protection
Under Voltage Indication
Over Voltage Indication

Original & X-References..

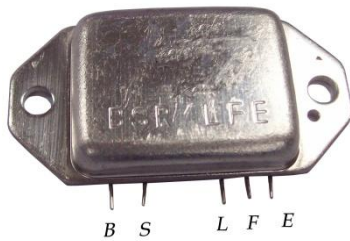

05-066

FEATURES

A-Circuit
Voltage Set Point **14.70 V**

Original & X-References..

HITACHI	TR1Z-27	TR1Z-33
	TR1Z-47	TR1Z-48
MOBILETRON	VR-H2000-1	
CARGO	130834	
TRANSPO	IH210	

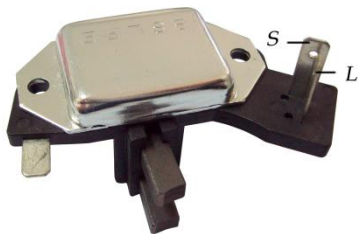

05-076

FEATURES

A-Circuit
Voltage Set Point **14.30 V**

Original & X-References..

HITACHI	L15043151
	L15063151
WAI	35-8134
CARGO	130832
BOSCH	0986192028
TRANSPO	IH203



05-083

FEATURES

A-Circuit
Voltage Set Point **28.40 V**
Soft Start **30 %**
Field Shorted Circuit Protection
Sense Open Indication
Under Voltage Indication
Over Voltage Indication

Original & X-References..

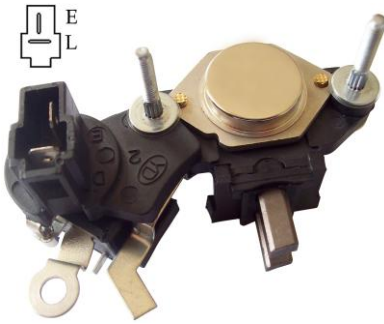

05-084

FEATURES

A-Circuit
Voltage Set Point **28.50 V**

Original & X-References..

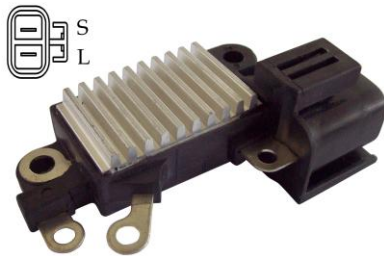

05-088

FEATUERS

A-Circuit
Voltage Set Point **14.30 V**
Field Lamp Shorted Circuit Protection
Sense Open Indication
Under Voltage Indication
Over Voltage Indication

Original & X-References..

HITACHI	L180-5340
	L180G-5340
USI	71-50003
CARGO	135022
WAI	35-8123
TRANSP0	IH762

Alternators: Hitachi LR165-708C,
LR170-738C,LR170-744,LR180-731B
Nissan 23100-OE700,23100-OE705

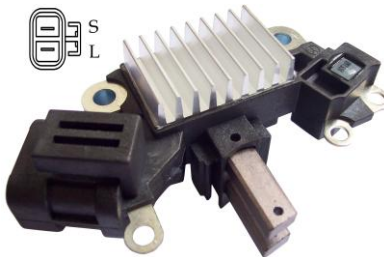

05-091

FEATUERS

A-Circuit
Voltage Set Point **14.40 V**
Soft Start **30 %**
Field Lamp Shorted Circuit Protection
Under/ Over Voltage Indication

Original & X-References..

HITACH	LR1110-712
LESTER	13900

05-095

Voltage Set Point **28.40 V**
Field Shorted Circuit Protection
Sense Open Indication

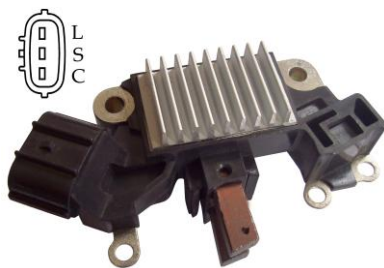

05-096

FEATUERS

A-Circuit
Voltage Set Point **14.30 V**
Soft Start **26 %**
LRC **4 sec**
Vset of "C" is controlled by duty cycle

Original & X-References..

HITACH	LR1110-724	-724B
	LR1110-725	-725B
LESTER	11119	11121
TRANSP0		IH741

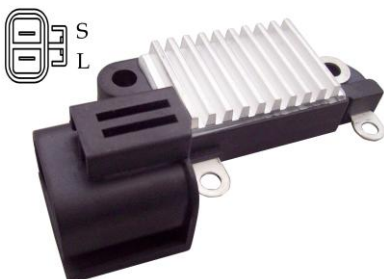

05-097

FEATUERS

A-Circuit
Voltage Set Point **14.60 V**

Original & X-References..

HITACH	L170-33152
NISSIAN	23215-50Y05
MOBILETRON	VR-H2000-14
WAI	35-8119
TRANSP0	IH760

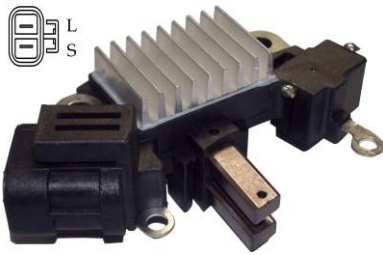

05-099

FEATURES

- A-Circuit
- Voltage Set Point **14.40 V**
- Soft Start **30 %**
- Field Shorted Circuit Protection
- Sense Open Indication
- Under Voltage Indication
- Over Voltage Indication

Original & X-References..

HITACH 21505-10753



05-100

FEATURES

- A-Circuit
- Voltage Set Point **14.40 V**

Original & X-References..

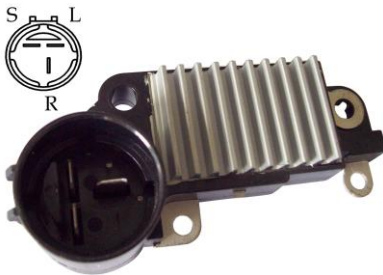

05-101

FEATURES

- A-Circuit
- Voltage Set Point **14.50 V**

Original & X-References..

CARGO 232442
 WAI 35-8125
 TRANSP0 IH251

For use on:
 HONDA ISUZU PICKUP

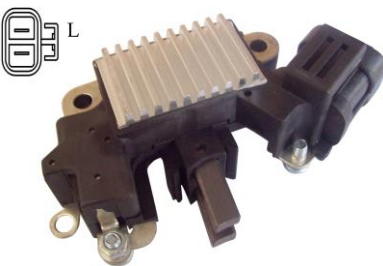

05-103

FEATURES

- A-Circuit
- Voltage Set Point **28.25 V**
- Soft Start **30 %**
- Lamp Shorted Circuit Protection
- Under Voltage Indication
- Over Voltage Indication

Original & X-References..



05-107

FEATUERS

- A-Circuit
- Voltage Set Point **14.45 V**
- Soft Start **30 %**
- Field Lamp Shorted Circuit Protection
- Under Voltage Indication
- Over Voltage Indication

Original & X-References..

For use on: NISSAN TIIDA

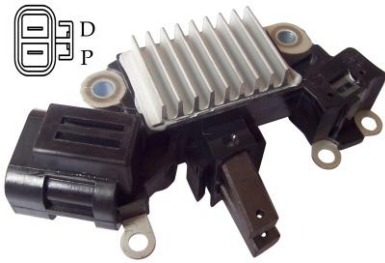

05-109

FEATURES

PD Regulator

Original & X-References..

HITACHI	LR170-758
MOBILETRON	VR-H2000-51
LESTER	13788
TRANSPO	IH758

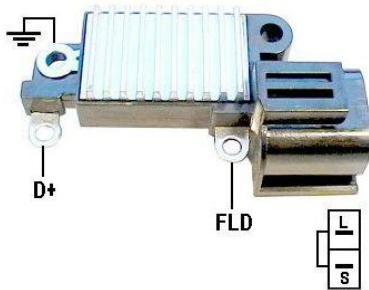

05-110

FEATURES

A-Circuit
Voltage Set Point **14.30 V**

Original & X-References..

HITACHI	L180-8315
CARGO	135158
MOBILETRON	VR-H2000-17
USI	71-50002
WAI	35-8116
TRANSPO	IH248



05-111

FEATURES

A-Circuit
Voltage Set Point **14.30 V**
Soft Start **26 %**
LRC **4 sec**
Vset of "C" is controlled by duty cycle

Original & X-References..

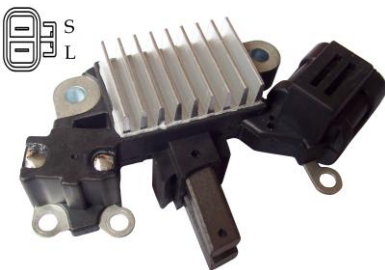

05-112

FEATURES

A-Circuit
Voltage Set Point **14.40 V**
Soft Start **30 %**
Field Shorted Circuit Protection
Under Voltage Indication
Over Voltage Indication

Original & X-References..

MOBILETRON	VR-H2000-45
LESTER	13937
TRANSPO	IH737

For use on: NISSAN SENTRA 180



05-113

FEATURES

A-Circuit
Voltage Set Point **14.30 V**
Soft Start **30 %**
LRC **5 sec**
Field Shorted Circuit Protection
Under Voltage Indication
Over Voltage Indication

Original & X-References..

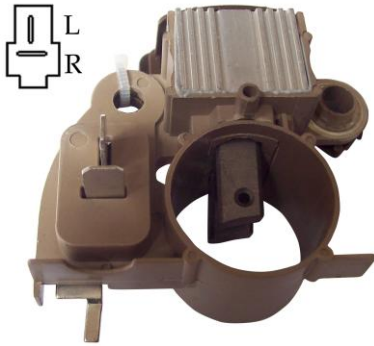

06-001

FEATURES

A-Circuit
Voltage Set Point **14.70 V**

Original & X-References..

MITSUBISHI	
A866X04870	A866X04871
A866X04872	A866X05470
A866X05471	A866X05472
A866X06072	E35618W70
MD611032	MD611146
TRANSP0	IM216HD

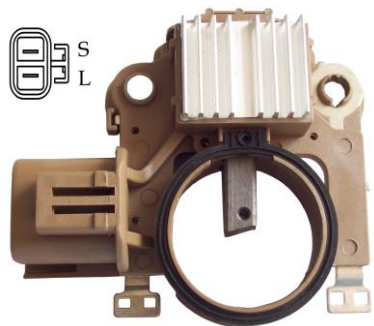

06-002

FEATURES

A-Circuit
Voltage Set Point **14.50V**

Original & X-References..

MITSUBISHI	A 866X25572
	MD618735
	MD619167
MOBILETRON	VR-H2009-67
CARGO	137075
TRANSP0	IM847

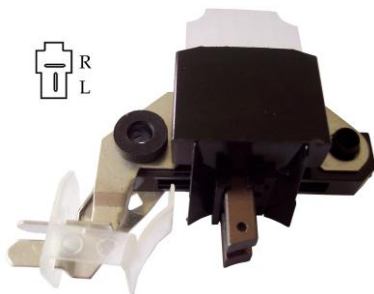

06-003

FEATURES

A-Circuit
Voltage Set Point **28.50 V**

Original & X-References..

For use on: Chrysler, Hyundai,
Mazda, Mitsubishi

MITSUBISHI	
A866X04872	A866X05471
A866X05472	E35618W70
MD611032	MD611146
MOBILETRON	VR-H2009-12
WAI	35-8301
CARGO	131517
TRANSP0	IM213HD

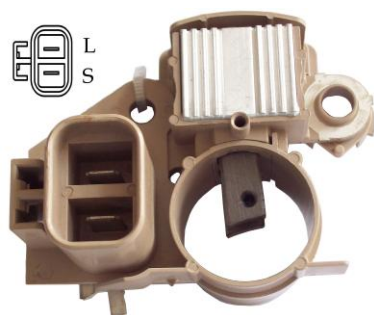

06-004

FEATURES

A-Circuit
Voltage Set Point **14.50V**

Original & X-References..

For use on: Nissan, Dodge

MITSUBISHI	
A866X05272	A866X09071
A866X09072	A866X09771
A866X09782	MD611432
WAI	35-8302
TRANSP0	IM217HD

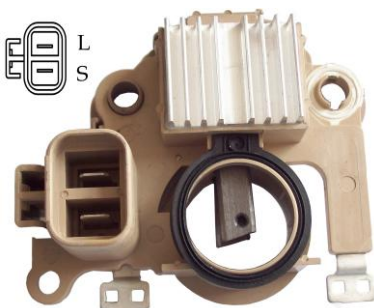

06-006

FEATURES

A-Circuit
Voltage Set Point **14.50V**

Original & X-References..

For: Mitsubishi IR/IF Alternators

MITSUBISHI	A866X22272
MOBILETRON	VR-H2009-38
WAI	35-8339
LESTER	12311 13430
	13439 13450 13596 13597
TRANSP0	IM222

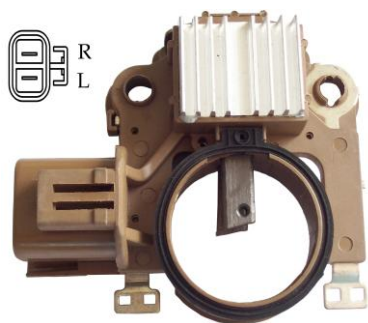

06-008

FEATURES

A-Circuit
Voltage Set Point **28.70V**

Original & X-References..

MITSUBISHI	A866X28372
	ME701399
MOBILETRON	VR-H2009-80B
CARGO	234304
TRANSPO	IM846



06-009

FEATURES

A-Circuit
Voltage Set Point **14.60 V**

Original & X-References..

MITSUBISHI	A866T03070	A866T1827
	A866T03470	MD618302
	MD607619	

06-064

Voltage Set Point **28.50 V**

For use on: Chrysler D50 Diesel
Pick-Up

MOBILETRON	VR-H2009-18
WAI	35-8304
CARGO	131290
TRANSPO	IM205

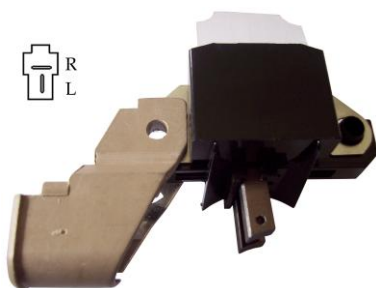

06-011

FEATURES

A-Circuit
Voltage Set Point **28.50 V**

Original & X-References..

MITSUBISHI	A866T06870
	ME700635
MOBILETRON	VR-H2009-47
CARGO	137396
TRANSPO	IM212

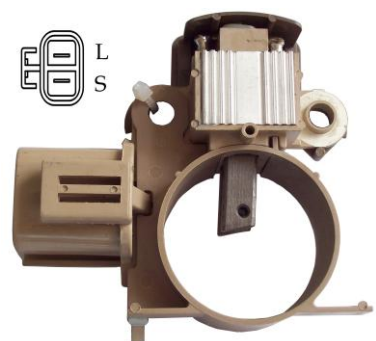

06-013

FEATURES

A-Circuit
Voltage Set Point **14.50 V**

For use on: Mitsubishi Pajero 2500
Diesel, Delica 2300 Van Diesel, Mirage
1800 Diesel, Galant 1800 Diesel, Sava
1800 Diesel, Shariot 1800 Diesel

Original & X-References..

MITSUBISHI	A866X09171
	MD611481
MOBILETRON	VR-H2009-28
WAI	35-8355
CARGO	131471
TRANSPO	IM281

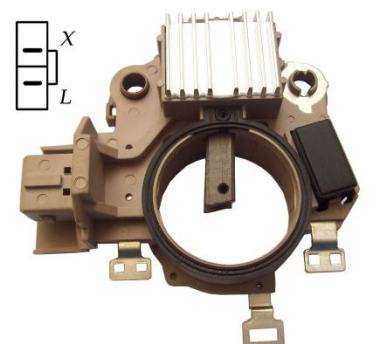

06-014

FEATURES

A-Circuit
Voltage Set Point **14.40 V**

For use on: Ford Transit Unit
A3TN1791

Original & X-References..

MITSUBISHI	A866X40371
MOBILETRON	VR-H2009-82
CARGO	230985
TRANSPO	IM757

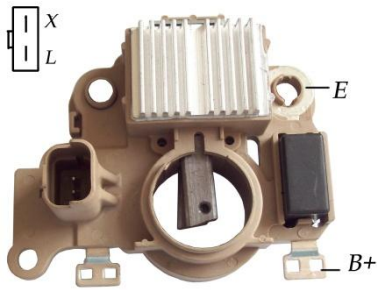

06-016

FEATURES

A-Circuit
 Voltage Set Point **14.50 V**
 Field Shorted Circuit Protection
 Over Voltage Indication
 Without Trio Diode Application

Original & X-References..

ALTERNATOR REFERENCES
 AZTB6481
 CARGO CA1652IR

For use on: Renault 2001-01 Clio II 1.5L

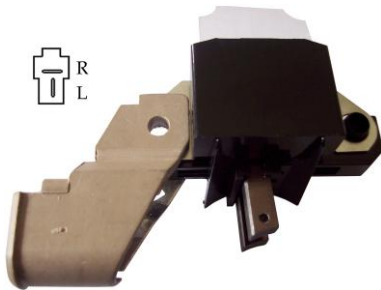

06-018

FEATURES

A-Circuit
 Voltage Set Point **14.60 V**

Original & X-References..

MITSUBISHI A866T08570
 ME700556
 MOBILETRON VR-H2009-46
 WAI 35-8344
 TRANSPO IM208

For use on: Fuso Trucks

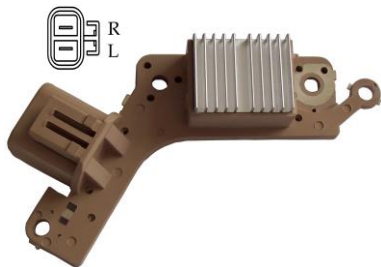

06-019

FEATURES

A-Circuit
 Voltage Set Point **28.60 V**

Original & X-References..

MITSUBISHI A866X26070
 A866X26072
 ME701302
 MOBILETRON VR-H2009-77
 TRANSPO IM843

For use on: Mitsubishi
 Motors Industrial
 Fuso Large Truck

06-026

Voltage Set Point **14.80 V**

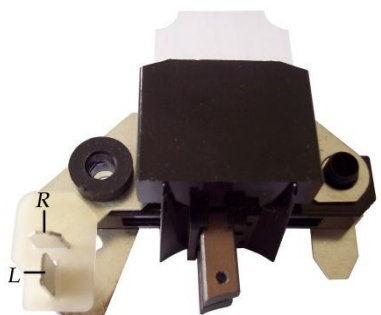

06-020

FEATURES

A-Circuit
 Voltage Set Point **14.60 V**

Original & X-References..

MITSUBISHI
 A866T00470 A866T00670
 A866T01970 A866T02770
 A866T01970 A866T02770
 MOBILETRON VR-H2009
 WAI 35-8300
 CARGO 130835
 TRANSPO IM204

For use on: Chrysler

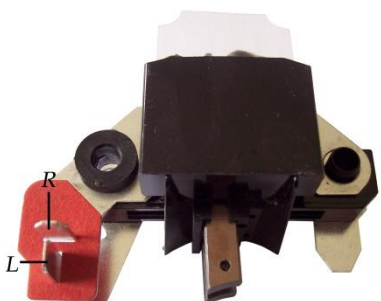

06-027

FEATURES

A-Circuit
 Voltage Set Point **28.50 V**

Original & X-References..

MITSUBISHI 0207 207
 MOBILETRON VR-H2009-21
 TRANSPO IM203

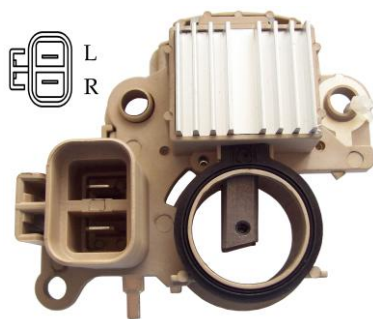

06-028

FEATURES

A-Circuit
Voltage Set Point **14.40 V**

Original & X-References..

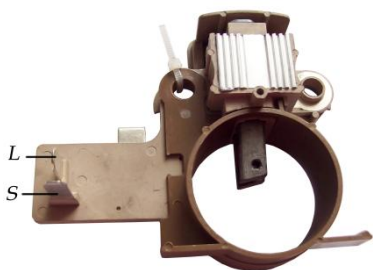

06-029

FEATURES

A-Circuit
Voltage Set Point **14.50 V**

Original & X-References..

TRANSPO IY422

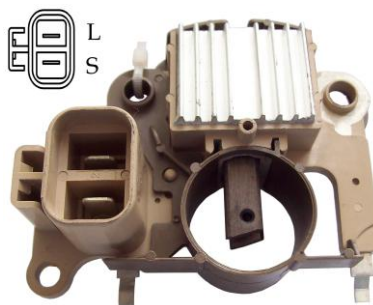

06-030

FEATURES

A-Circuit
Voltage Set Point **14.50V**

Original & X-References..

WAI	35-8324
CARGO	135032
TRANSPO	IM280

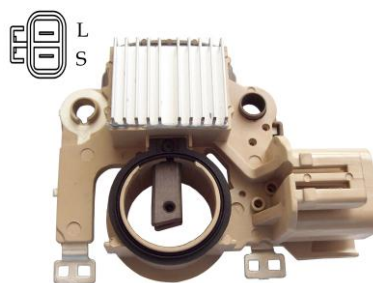

06-031

FEATURES

A-Circuit
Voltage Set Point **14.40 V**
Sense Open Indication
Under Voltage Indication
Over Voltage Indication

Original & X-References..

MITSUBISHI	
A002T33493A	A002T33593A
A002T35791	A2T33593
A2T82491	A866X23072
MOBILETRON	VR-H2009-45
WAI	35-8343
CARGO	137182
TRANSPO	IM292

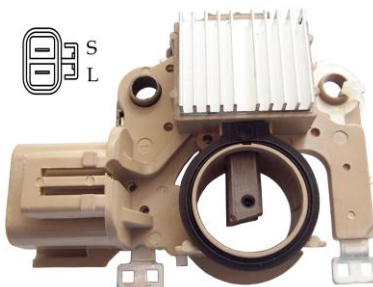

06-032

FEATURES

A-Circuit
Voltage Set Point **14.40 V**
Sense Open Indication
Under Voltage Indication
Over Voltage Indication

Original & X-References..

MITSUBISHI	
A866X20472	A866X20972
B64J18W70A	
MOBILETRON	VR-H2009-22
WAI	35-8333 35-8315
CARGO	135233
TRANSPO	IM830

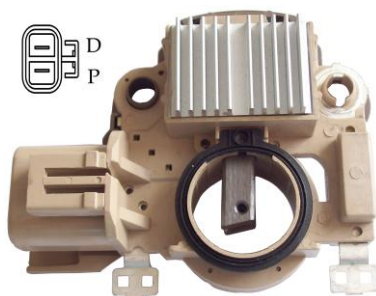

06-034

FEATURES

Original & X-References..

MITSUBISHI	A866X35472
CARGO	138872
TRANSPO	IM345

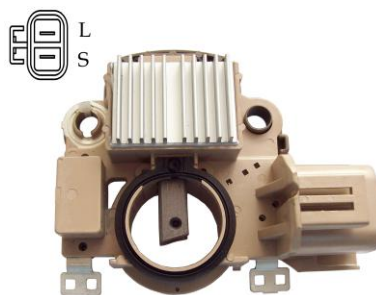

06-035

FEATURES

Original & X-References..

- A-Circuit
- Voltage Set Point **14.40 V**
- Soft Start **30 %**
- LRC **5 Sec**
- Field Shorted Circuit Protection
- Sense Open Indication
- Under Voltage Indication
- Over Voltage Indication

MITSUBISHI	A866X36272
CARGO	230043
TRANSPO	IM362

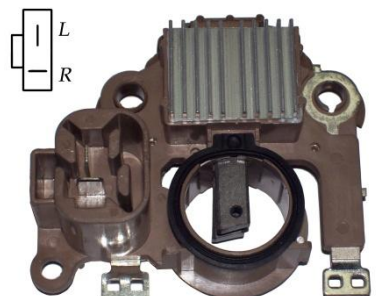

06-036

FEATURES

Original & X-References..

- A-Circuit
- Voltage Set Point **14.40 V**

MITSUBISHI	A866X26172
	MD618845
MOBILERON	VR-H2009-63
CARGO	138309
TRANSPO	IM290

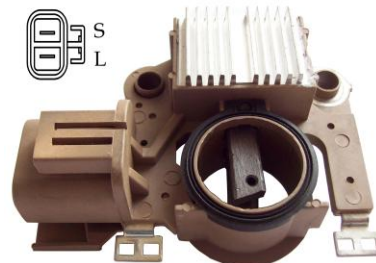

06-037

FEATURES

Original & X-References..

- A-Circuit
- Voltage Set Point **14.40V**
- Soft Start **30 %**
- LRC **5 Sec**
- Field Shorted Circuit Protection
- Sense Open Indication
- Under Voltage Indication
- Over Voltage Indication

MITSUBISHI	A866X00179
	17972 17982
LESTER	11096
WAI	35-8322
TRANSPO	IM277

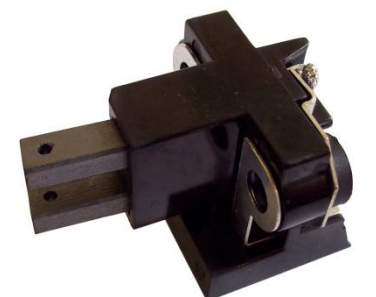

06-039

FEATURES

Original & X-References..

- A-Circuit
- Voltage Set Point **28.50 V**

MITSUBISHI	A866 T 01070
	A866 X 01070
	ME700091
WAI	35-8328
CARGO	131518
TRANSPO	IM215

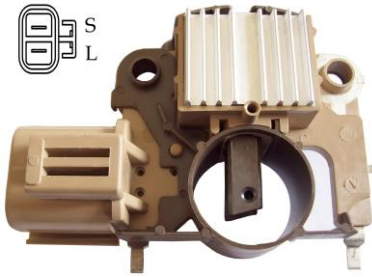

06-041

FEATURES

A-Circuit
Voltage Set Point **14.50V**

Original & X-References..

MITSUBISHI	A866X14570	14572
MOBILETRON	VR-H2009-30	
WAI	35-8326	
CARGO	134088	
TRANSP0	IM278	

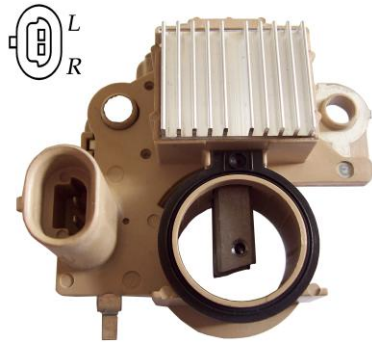

06-043

FEATURES

A-Circuit
Voltage Set Point **14.40 V**

Original & X-References..

CARGO	235205	
-------	--------	--

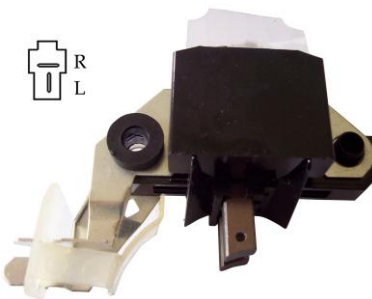

06-044

FEATURES

A-Circuit
Voltage Set Point **14.60 V**

Original & X-References..

MITSUBISHI	A 00522578	
MOBILETRON	VR-H2009-48	
UNIPOINT	YR-562	
WAI	35-8360	
TRANSP0	IM207	

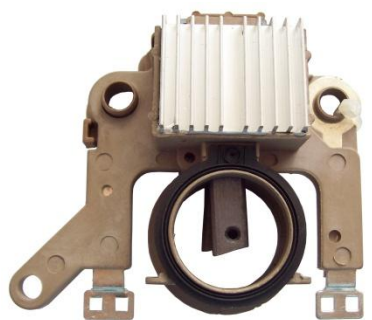

06-046

FEATURES

A-Circuit
Voltage Set Point **14.80 V**

Original & X-References..

MITSUBISHI	A 2T2094B	
MOBILETRON	VR-H2009-58	

06-045

A-Circuit
Voltage Set Point **14.40 V**

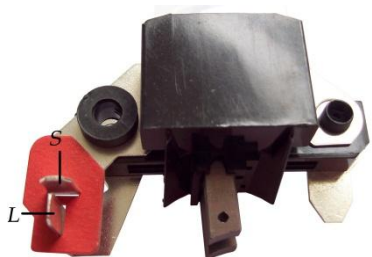

06-049

FEATURES

A-Circuit
Voltage Set Point **14.50V**

Original & X-References..

MITSUBISHI	A866T00870	
	A866T02270	
	A866T02970	
MOBILETRON	VR-H2009-3	
CARGO	131289	
TRANSP0	IM225	

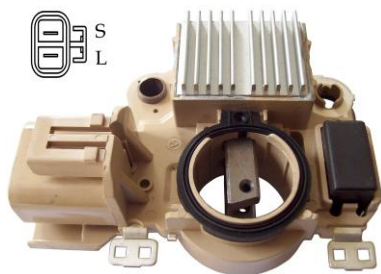

06-050

FEATURES

A-Circuit
 Voltage Set Point **14.40V**
 Soft Start **30 %** LRC **5 Sec**
 Field Shorted Circuit Protection
 Sense Open Indication
 Under / Over Voltage Indication

Original & X-References..

MITSUBISHI	A866X7672
LESTER	11051
TRANSPO	IM476

06-063

Without Sense Open Indication, Others Function are the same as 06-050

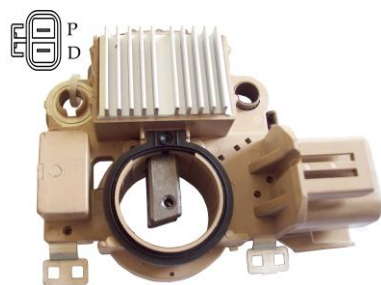

06-051

FEATURES

Original & X-References..

MITSUBISHI	A866X46572
	GY0118W70
	A3TG0081
MOBILETRON	VR-H2009-100
TRANSPO	IM465

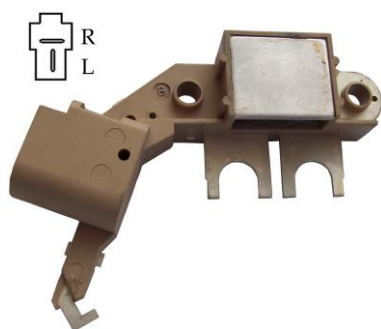

06-052

FEATURES

A-Circuit
 Voltage Set Point **28.70 V**

Original & X-References..

MITSUBISHI	A866X19972
A866X08871	ME701196
ME7000783	VR-H2009-69B
MOBILETRON	IM286
TRANSPO	

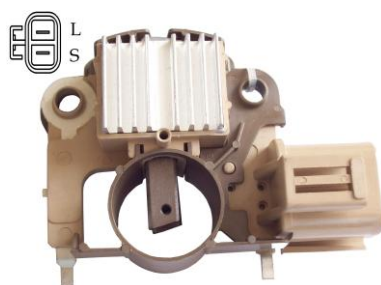

06-053

FEATURES

A-Circuit
 Voltage Set Point **14.50V**

Original & X-References..

MITSUBISHI	A866X17470
	A866X21472
	A866X13272
	A866X15170
CARGO	135030
TRONSPO	IM284 IM271

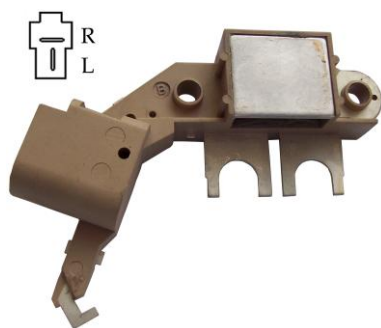

06-055

FEATURES

A-Circuit
 Voltage Set Point **14.80V**

Original & X-References..

MITSUBISHI	A866X08971
A866X23972	ME7000799
ME701260	
MOBILETRON	VR-H2009-69
TRANSPO	IM294

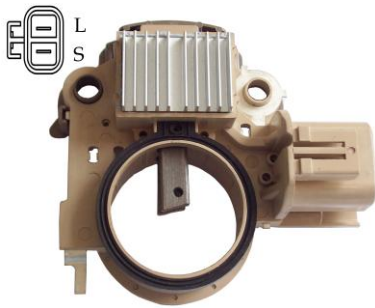

06-056

FEATURES

A-Circuit
Voltage Set Point **14.50V**

Original & X-References..

ALTERNATOR REFERENCES
HYUNDAI 3730042451
MANDO AF175363

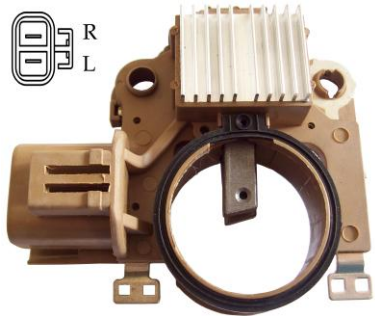

06-059

FEATURES

A-Circuit
Voltage Set Point **28.65 V**

Original & X-References..

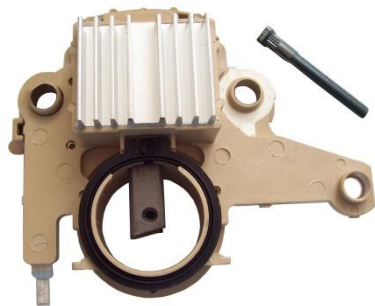

06-060

FEATURES

A-Circuit
Voltage Set Point **14.50V**

Original & X-References..

06-089

With B+ Bolt

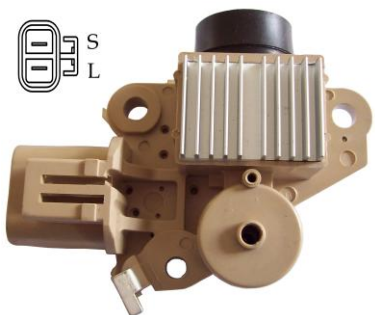

06-065

FEATURES

A-Circuit
Voltage Set Point **A 14.50V**

Original & X-References..

CARGO 231425
MOBILETRON VR-MD07
TRANSPO IY094

For use on : Alternators Mando
AB170094 OK2A218300

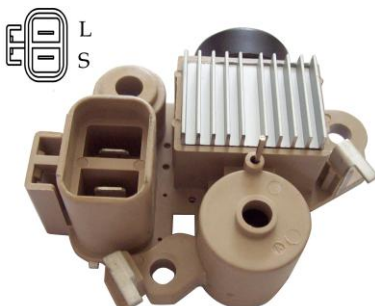

06-066

FEATURES

A-Circuit
Voltage Set Point **14.50V**

Original & X-References..

HYVNDAI 37370-22600
MADNO TA500-C09001
MOBILETRON VR-MD06
TRANSPO IY028

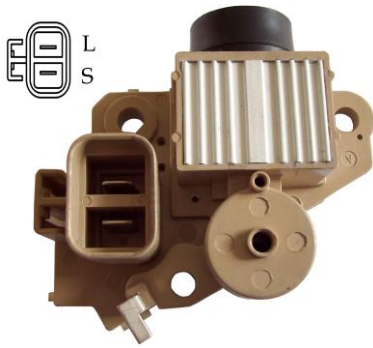

06-067

FEATURES

A-Circuit
Voltage Set Point **14.50V**

Original & X-References..

HYUNDAI	37300-22200
MOBILETRON	VR-H2009-86
CARGO	138204
TRANSPO	IY058

For use on : Alternators
3730022200 AB190058



06-068

FEATURES

A-Circuit
Voltage Set Point **14.50V**

Original & X-References..

KIA	62124520
-----	----------



06-069

FEATURES

A-Circuit
Voltage Set Point **14.50V**

Original & X-References..

KIA	055318300B
-----	------------



06-070

FEATURES

A-Circuit
Voltage Set Point **14.80V**

Original & X-References..

POONG SUNG	02121-8207
	02121-9012
MOBILETRON	VR-K01
CARGO	139469

06-079

A-Circuit
Voltage Set Point **28.60V**

POONG SUNG	02121-8207
	02121-9012
MOBILETRON	VR-K01B

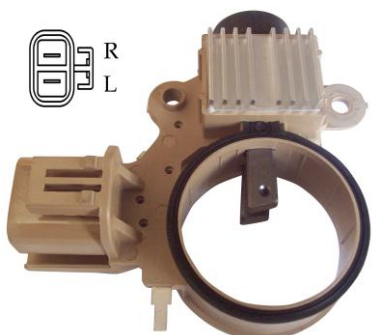

06-072

FEATURES

A-Circuit
Voltage Set Point **28.65V**

Original & X-References..



06-073

FEATURES

Original & X-References..

A-Circuit
Voltage Set Point **28.65V**

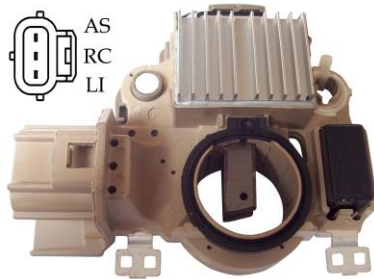

06-074

FEATUERS

Original & X-References..

A-Circuit
RC=0 Vs=**13.50V**
RC=55% Vs=**14.25V**
AS-RC-LI Terminals

RES14278
TRANSPO IM503

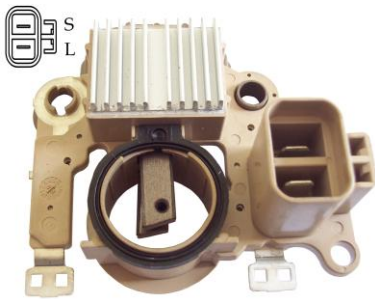

06-075

FEATURES

Original & X-References..

A-Circuit
Voltage Set Point **14.50 V**
Soft Start **30 %**
LRC **5 sec**
Field Lamp Shorted Circuit Protection
Under Voltage Indication
Over Voltage Indication

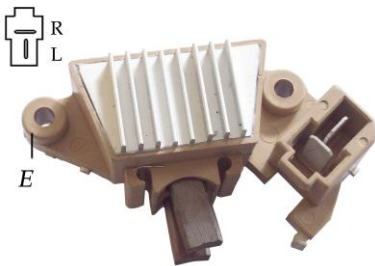

06-078

FEATURES

Original & X-References..

A-Circuit
Voltage Set Point **14.60V**

TRANSPO IY510

For use on : KIA TICO

06-084

A-Circuit
Voltage Set Point **28.60V**

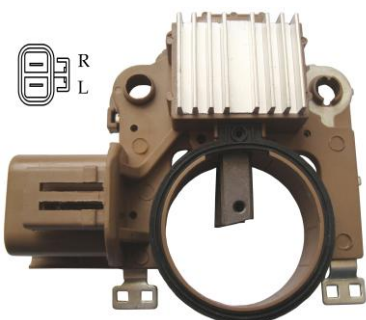

06-080

FEATURES

Original & X-References..

A-Circuit
Voltage Set Point **14.80V**

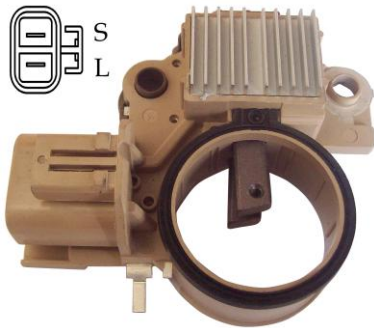

06-081

FEATURES

A-Circuit
Voltage Set Point **14.50V**

Original & X-References..

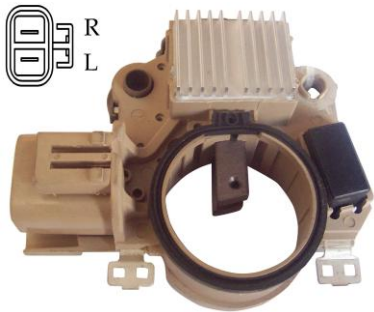

06-082

FEATURES

A-Circuit
Voltage Set Point **28.65V**

Original & X-References..

06-094

Voltage Set Point **28.70V**

06-103

Voltage Set Point **14.80V**

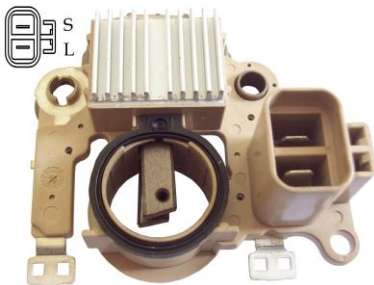

06-085

FEATURES

A-Circuit
Voltage Set Point **14.40V**
Sense Open Indication
Under Voltage Indication
Over Voltage Indication

Original & X-References..

MITSUBISHI	A866X27572
	ME701363
CARGO	139110
TRANSPO	IM854

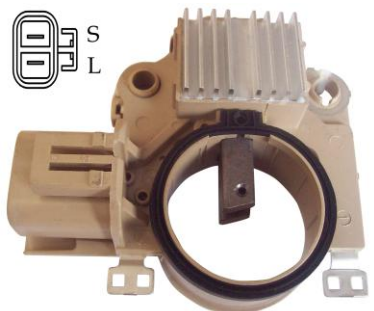

06-086

FEATURES

A-Circuit
Voltage Set Point **28.50 V**

Original & X-References..

28241239

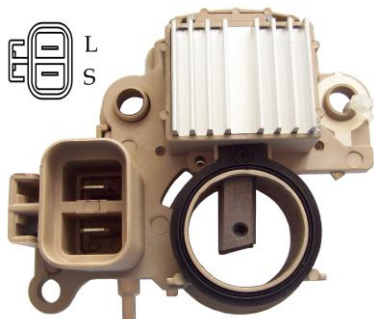

06-088

FEATURES

A-Circuit
Voltage Set Point **14.50 V**

Original & X-References..

MITSUBISHI	A866T09780
	A866T09782
MOBILETRON	VR-H2009-78
LSTER	13289
TRANSPO	IM831

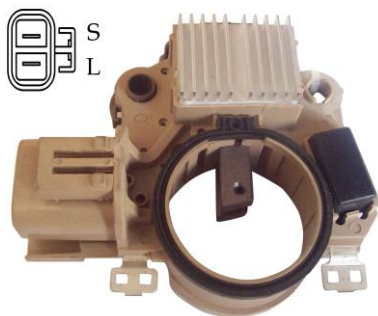

06-090

FEATUERS

A-Circuit
Voltage Set Point **14.50V**

Original & X-References..

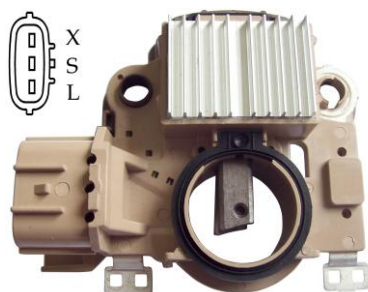

06-092

FEATUERS

A-Circuit
Voltage Set Point **14.40 V**
Soft Start **30 %**
LRC **5 Sec**
Field Shorted Circuit Protection
Sense Open Indication
Under Voltage Indication
Over Voltage Indication

Original & X-References..

MITSUBISHI	A2TB2891
	A2TB2991
SUBARU	23815-AA140
MOBILETRON	VR-H2009-107
TRANSPO	IM848

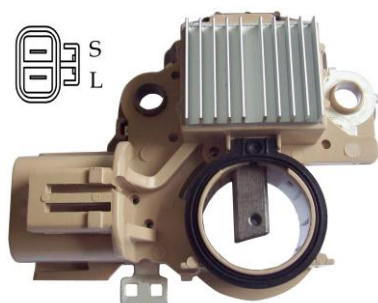

06-093

FEATUERS

A-Circuit
Voltage Set Point **14.50 V**

Original & X-References..

MOBILETRON	VR-H2009-116
MANDO	AB170036
KIA	OK201-18-300B
TRANSPO	IY794

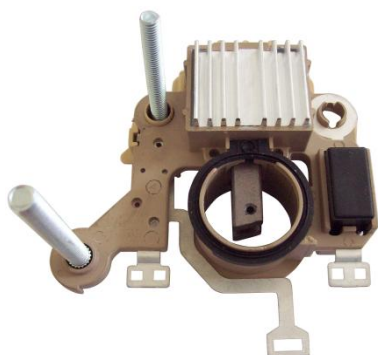

06-095

FEATUERS

A-Circuit
Voltage Set Point **28.35 V**

Original & X-References..

MITSUBISHI	A0037A859
------------	-----------

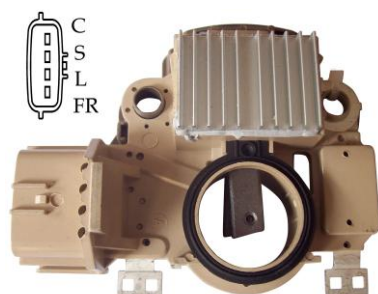

06-096

FEATUERS

A-Circuit
Voltage Set Point **14.60 V**
Soft Start **30 %**
Field, Lamp Shorted Circuit Protection
Sense Loss Indication
Under Voltage Indication
Over Voltage Indication
DFM function

Original & X-References..

MOBILETRON	VR-H2009-70A
MITSUBISHI	A866X34172
TRANSPO	IM341

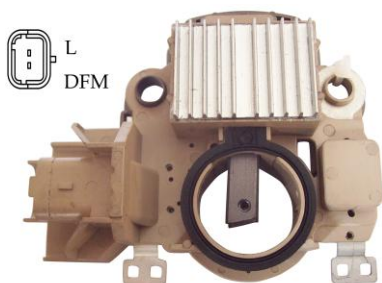

06-097

FEATUERS

A-Circuit
 Voltage Set Point **14.50 V**
 Soft Start **30 %**
 LRC **5 sec**
 Field, Lamp Shorted Circuit Protection
 Under Voltage Indication
 Over Voltage Indication
 DFM function

Original & X-References..

MITSUBISHI A866X498
 MOBILETRON VR-H2009-105
 TRANSPON IM498



06-098

FEATUERS

A-Circuit
 Voltage Set Point **28.50 V**
 Soft Start **30 %**
 Field, Lamp Shorted Circuit Protection
 IG Open Indication
 Sense Loss Indication
 Under Voltage Indication
 Over Voltage Indication

Original & X-References..

MITSUBISHI A4TA8191

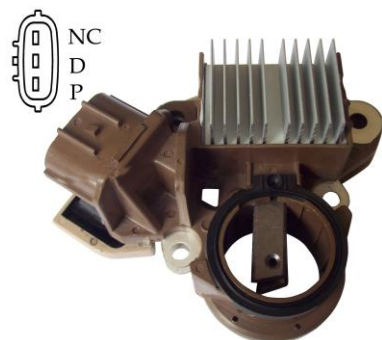

06-100

FEATUERS

Works with PCM
 Traditional test method will
 immediately damage P-D

Original & X-References..

MITSUBISHI A866X50572
 MOBILETRON VR-H2009-114
 TRANSPON IM505



06-101

FEATUERS

A-Circuit
 RC=0 Vs=**13.50V**
 RC=55% Vs=**14.25V**

Original & X-References..

MITSUBISHI A866T52970
 MOBILETRON VR-H2009-98
 TRANSPON IM529

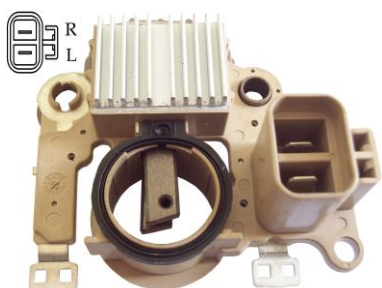

06-102

FEATUERS

A-Circuit
 Voltage Set Point **28.70 V**

Original & X-References..

MITSUBISHI ME108147



06-107

FEATUERS

A-Circuit
Voltage Set Point **14.60 V**

Original & X-References..

MOBILETRON	VR-H2009-75
TRANSPO	IM288

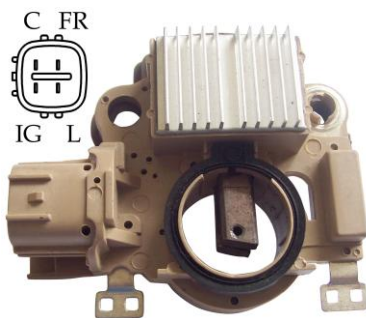

06-108

FEATUERS

A-Circuit
Voltage Set Point **14.60 V**
Soft start
Stator activated

Original & X-References..

TRANSPO	IM851
---------	-------

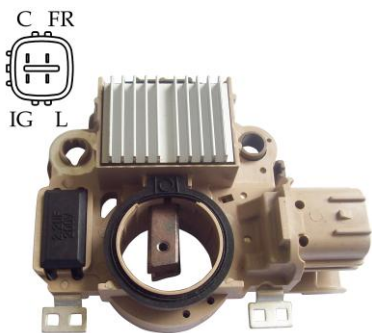

06-109

FEATURES

A-Circuit
Voltage Set Point **14.60 V**
Soft start
Stator activated

Original & X-References..

MOBILETRON	VR-H2009-113
TRANSPO	IM558

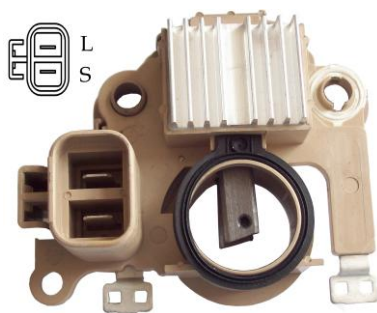

06-110

FEATURES

A-Circuit
Voltage Set Point **14.50V**

Original & X-References..

For: Mitsubishi IR/IF Alternators

MITSUBISHI	A002T34892
MOBILETRON	VR-H2009-38
WAI	35-8336
CARGO	136649 230885
TRANSPO	IM832

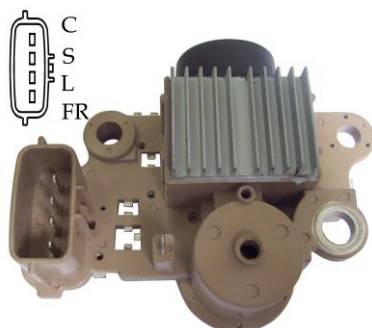

06-111

FEATUERS

A -Circuit
Voltage Set Point **14.50 V**
DFM function

Original & X-References..

TRANSPO	IY126
---------	-------

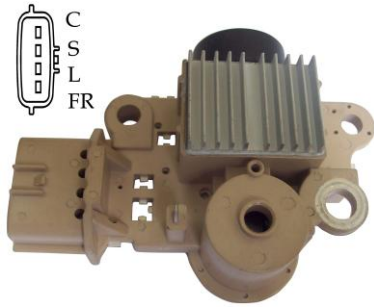

06-112

FEATUERS

A -Circuit
Voltage Set Point **14.50 V**
DFM function

Original & X-References..

TRANSPO IY146

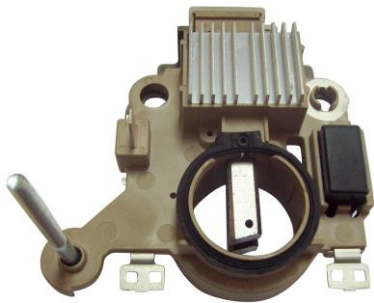

06-113

FEATURES

A-Circuit
Voltage Set Point **28.35 V**

Original & X-References..

MITSUBISHI A4TR5188

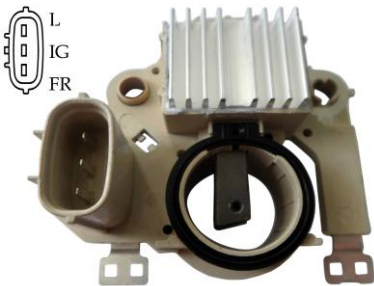

06-114

FEATURES

A-Circuit
Voltage Set Point **14.70 V**
Under Voltage Indication

Original & X-References..

MOBILETRON VR-H2009-62
MITSUBISHI A866X31882
TRANSPO IM318

For use on: Honda

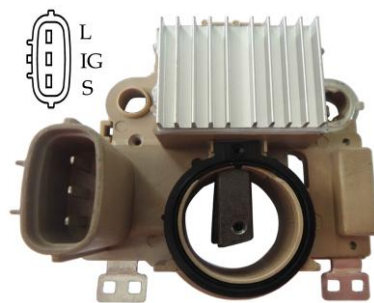

06-115

FEATURES

A-Circuit
Voltage Set Point **28.50 V**
Soft Start **30 %**
IG / Sense Open Indication
L Terminal Drives Choke
Under/ Over Voltage Indication

Original & X-References..

MOBILETRON VR-H2009-135B

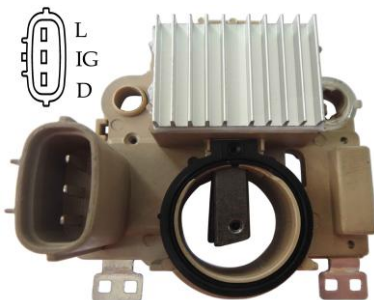

06-116

FEATURES

A-Circuit
Voltage Set Point **14.70 V**
Soft Start **30 %**
LRC **5 sec**
Field Lamp Shorted Circuit Protection
Under/ Over Voltage Indication

Original & X-References..

MOBILETRON VR-H2009-90
TRANSPO IM381

For use on: Chev Tracker, Suzuki Vitara

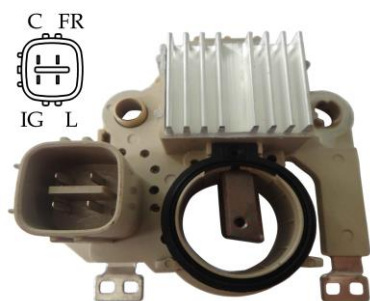

06-117

FEATURES

A-Circuit
Voltage Set Point **14.50 V**
Under Voltage Indication

Original & X-References..

MOBILETRON	VR-H2009-71
CARGO	230260
USI	71-60037
LESTER	13649 13762
TRANSP0	IM850

For use on: Honda

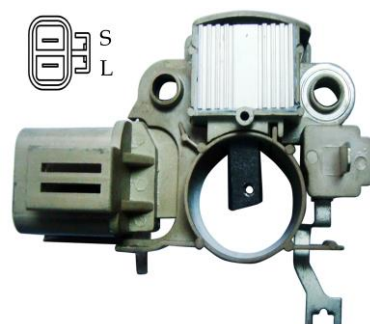

06-118

FEATURES

A-Circuit
Voltage Set Point **14.50 V**

Original & X-References..

MITSUBISHI	A866X12770
A866X12772	A866X12782
CARGO	132101
USI	71-60027
MOBILETRON	VR-H2009-7H
WAI	35-8308
TRANSP0	IM265 IM265HD

For use on: Ford Probe, Mazda

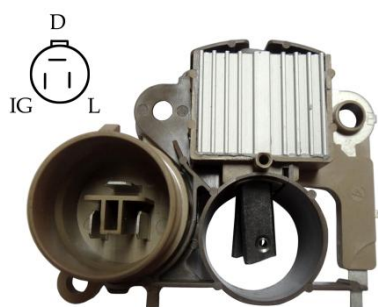

06-119

FEATURES

A-Circuit
Voltage Set Point **14.50 V**

Original & X-References..

MITSUBISHI	A866X11870 11872
MOBILETRON	VR-H2009-14N
LESTER	13213 13416
TRANSP0	IM275

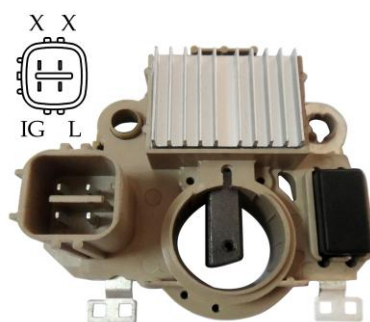

06-120

FEATURES

A-Circuit
Voltage Set Point **14.50 V**
Soft Start **30 %**
LRC **5 sec**
Field Lamp Shorted Circuit Protection
Under Voltage Indication
Over Voltage Indication

Original & X-References..

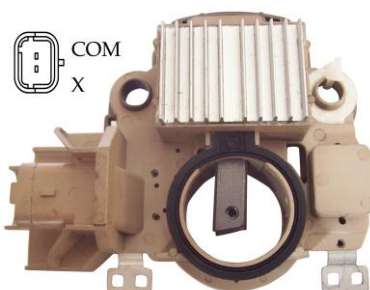

06-121

FEATURES

A-Circuit
Voltage Set Point **14.80 V**
Soft Start **17 %**
LRC **4 sec**
Self Exciting Function

Original & X-References..

BSS Regulator

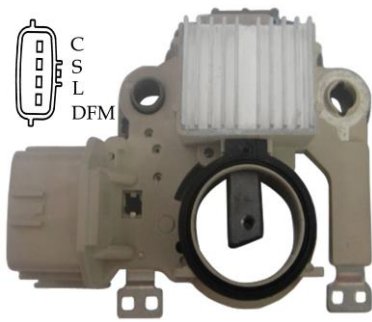

06-122

FEATURES

- A-Circuit
- Voltage Set Point **14.50 V**
- Sense Open Indication
- Under/ Over Voltage Indication
- DFM Function

Original & X-References..

MITSUBISHI	A866X28572
MOBILETRON	VR-H2009-73
LESTER	13585 13586 13587
WAI	35-8346
TRANSPO	IM845

For use on: (1999-95) Eagle, Mitsubishi

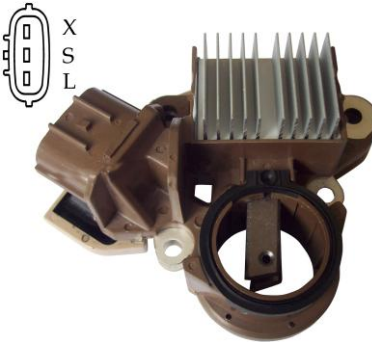

06-125

FEATURES

- A-Circuit
- Voltage Set Point **14.50V**
- Soft Start **30 %**
- LRC **5 Sec**
- Field Shorted Circuit Protection
- Sense Open Indication
- Under / Over Voltage Indication

Original & X-References..

MITSUBISHI	A2TJ0281
MOBILETRON	VR-H2009-148
LESTER	11343
TRANSPO	IM564

For use on: (2008-07) Nissan

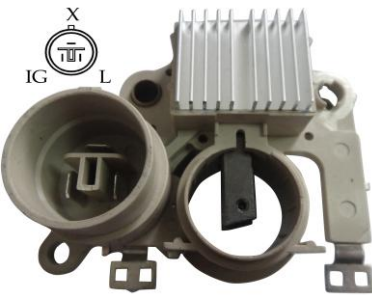

06-134

FEATUERS

- A-Circuit
- Voltage Set Point **14.50 V**

Original & X-References..

MITSUBISHI	A866X26641
WAI	35-8354
LESTER	13608 13700
TRANSPO	IM835

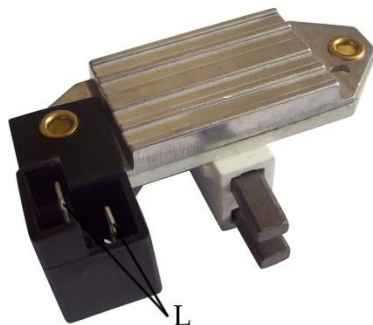

07-001

FEATURES

A-Circuit
Voltage Set Point **14.50 V**

For use on:633-200 And 633-210
Series Magneti-Marelli
Alternators On late Fiat Models

Original & X-References..

MAGNETI MARELLI	
58120022	79707161
797 074 81	RTT 119 A
RTT 119 AAC	RTT 119 AC
83600151	
WAI	35-9304
CARGO	131283
TRANSPO	IX110



07-005

FEATURES

A-Circuit
Voltage Set Point **28. 50 V**

For use on:
Fiat Tractors And Other
Fiat Applications

Original & X-References..

MAGNETI MARELLI	
79707441	RTT 117 B
MOBILETRON	VR-F119B
CARGO	131286
TRANSPO	IX111



07-006

FEATURES

B-Circuit
Voltage Set Point **14.20 V**
Soft Start **30 %** LRC **5 sec**
Field Shorted Circuit Protection
Sense Open Indication
Under/ Over Voltage Indication
DFM Function

Original & X-References..



07-014

FEATURES

A-Circuit
Voltage Set Point **14.50 V**
Soft Start **32 %** LRC **5 sec**
Field Shorted Circuit Protection
Under /Over Voltage Indication
Self-exciting

Original & X-References..

MAGNETI	
RTM151A	83611361
MOBILETRON	VR-F151A
CARGO	136432
UNIPOINT	YR-388
TRANSPO	IX 121

07-023

For use on:Fiat Punto 62
Cabrio Selcta Punto 75 ELX
HSD S SX



07-015

FEATURES

A-Circuit
Voltage Set Point **28.50 V**

Original & X-References..

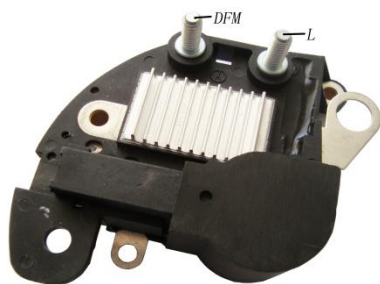

07-017

FEATURES

A-Circuit
 Voltage Set Point **14.50 V**
 Soft Start **32 %** LRC **5 sec**
 Field Shorted Circuit Protection
 Under Voltage Indication
 Over Voltage Indication
 DFM function

Original & X-References..

MAGNETI MARELLI 85563491
 CARGO 238265
 MOBILETRON VR-F157

07-017S



07-019

FEATUERS

A-Circuit
 RC=0 $V_s=13.50V$
 RC=55% $V_s=14.25V$

Original & X-References..

MARELLI 85582601010
 MOBILETRON VR-F156
 TRANSPO IX131

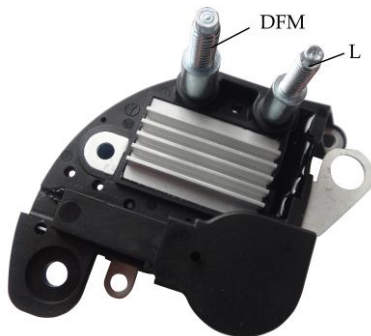

07-020

FEATURES

A-Circuit
 Voltage Set Point **14.50 V**
 Soft Start **32 %** LRC **5 sec**
 Field Shorted Circuit Protection
 Under / Over Voltage Indication
 DFM function
 Cut-in Speed: 1200rpm

Original & X-References..

CARGO 233636
 CA1890

07-020S

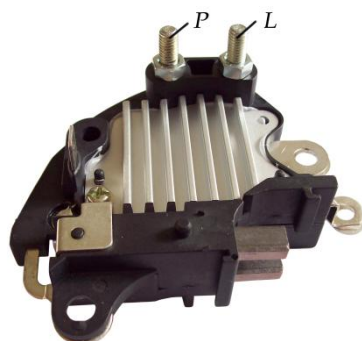

07-021

FEATURES

A-Circuit
 Voltage Set Point **14.60 V**
 Soft Start **32 %**
 LRC **5 sec**
 Field Shorted Circuit Protection
 Under Voltage Indication
 Over Voltage Indication
 With Trio Diode Application

Original & X-References..

FIAT 83614251 99946065
 CARGO 136457
 TRANSPO IX127

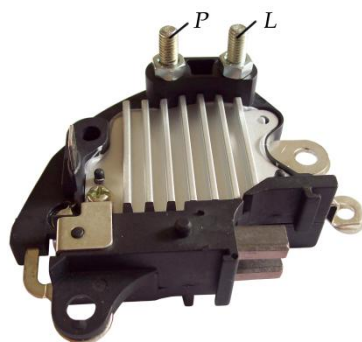

07-022

FEATURES

A-Circuit
 Voltage Set Point **28.50 V**
 Soft Start **30 %**
 Under Voltage Indication
 Over Voltage Indication

Original & X-References..

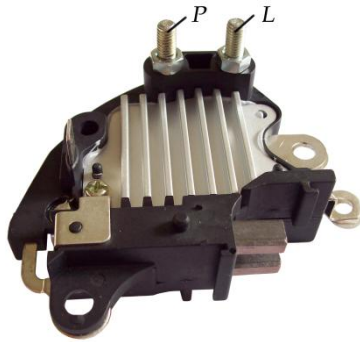

07-024

FEATURES

- A-Circuit
- Voltage Set Point **14.60 V**
- Soft Start **32 %**
- LRC **5 sec**
- Field Shorted Circuit Protection
- Under Voltage Indication
- Over Voltage Indication
- With Trio Diode Application

Original & X-References..

WAI	35-9305
CAGRO	136457
TRANSPO	IX128

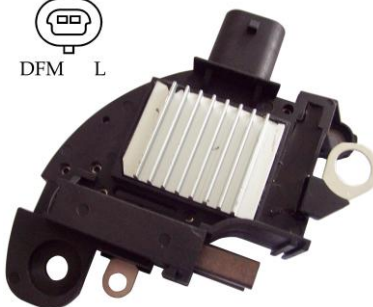

07-027

FEATURES

- B-Circuit
- Voltage Set Point **14.50 V**

Original & X-References..

07-032

FEATURES

- A-Circuit
- Voltage Set Point **14.50 V**
- Soft Start **30 %** LRC **5 sec**
- Field Shorted Circuit Protection
- Under / Over Voltage Indication
- Self-exciting

Original & X-References..

MOBILETRON	VR-F153A
CARGO	138789
WAI	35-9306
TRANSPO	IX 123



07-029

For use on: Land Rover



07-034

FEATURES

- A-Circuit
- Voltage Set Point **14.50 V**
- Soft Start **32 %** LRC **5 sec**
- Field Shorted Circuit Protection
- Under /Over Voltage Indication
- Self-exciting

Original & X-References..

CARGO	138798
-------	--------

07-034S



07-037

FEATURES

- B-Circuit
- Voltage Set Point **13.70 V**
- LRC **3 sec**
- Self Exciting Function

Original & X-References..

LIN Regulator



08-001

FEATURES	Original & X-References..	
B-Circuit	VALEO	593529
Voltage Set Point 14.50 V	CARGO	234982
Soft Start 30 % LRC 5 sec	TRANSPO	M562
Field Shorted Circuit Protection		
Under/ Over Voltage Indication		
DFM function with duty cycle limitation		
Self exciting function		



08-004

FEATURES	Original & X-References..		
B-Circuit	VALEO	593290	593310 593349
Voltage Set Point 14.50 V	CARGO	139456	230784 230785
Soft Start 30 %	TRANSPO		M517
LRC 5 sec			
Field Shorted Circuit Protection			
Under Voltage Indication			
Over Voltage Indication			
Self exciting function			

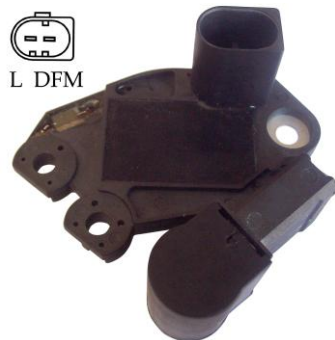

08-006

FEATURES	Original & X-References..	
B-Circuit	VALEO	2542292
Voltage Set Point 14.50 V	MOBILETRON	VR-PR2292
Soft Start 30 %	CARGO	231103
LRC 5 sec	TRANSPO	M521
Field Shorted Circuit Protection		
Under Voltage Indication		
Over Voltage Indication		
DFM function		
Self exciting function		



08-007

FEATURES	Original & X-References..	
A-Circuit	MOBILETRON	VR-PR1669
Voltage Set Point 14.50 V	CARGO	136546
	TRANSPO	M514

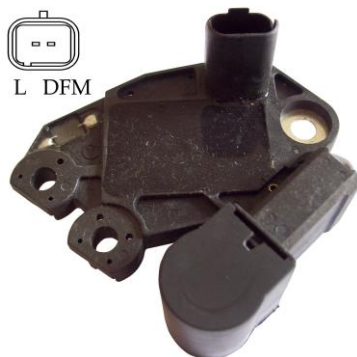

08-008

FEATURES	Original & X-References..	
B-Circuit	VALEO	2542299
Voltage Set Point 14.50 V		593384
Soft Start 30 % LRC 5 sec		593396
Field Shorted Circuit Protection	MOBILETRON	VR-PR2299H
Under Voltage Indication	CARGO	232962
Over Voltage Indication		
DFM Function		
Self exciting function		



08-009

FEATURES

B-Circuit
 Voltage Set Point **14.50 V**
 Soft Start **30 %**
 LRC **5 sec**
 Field Shorted Circuit Protection
 Under Voltage Indication
 Over Voltage Indication
 Self exciting function

Original & X-References..

VALEO	593284	2541834
VALEO	A14V115	A14V116
	A14V127	A14V135
	A14V141	
TRANSPO	M519	



08-010

FEATURES

A-Circuit
 Voltage Set Point **14.50 V**

Original & X-References..

HUCO	130696	
MOBILETRON	VR-VW010	
CARGO	133988	134475
TRANSPO	M511	

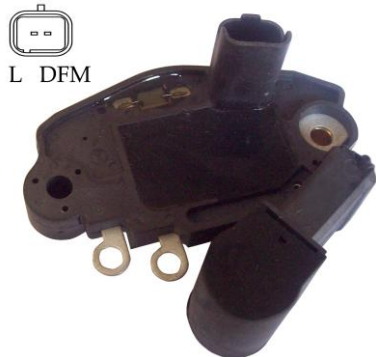

08-012

FEATURES

B-Circuit
 Voltage Set Point **14.50 V**
 Soft Start **30 %** LRC **5 sec**
 Field, Lamp Shorted Circuit Protection
 Under / Over Voltage Indication
 DFM Function
 Self exciting function

Original & X-References..

VALEO	593316	2541952
		YM1620
MOBILETRON	VR-PR1620	
CARGO	139440	139441
TRANSPO	M516	

08-037

Voltage Set Point **14.05 V**



08-014

FEATURES

A-Circuit
 Voltage Set Point **14.60 V**

Original & X-References..

LUCAS	21225183	21225371
VALEO	092897	092902
	300820	
MOBILETRON	VR-PR1925H	
WAI	35-9401	
CARGO	130661	131552
TRANSPO	IP125	

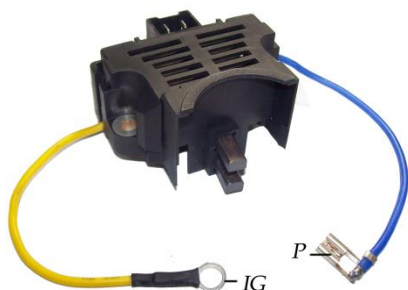

08-015

FEATURES

A-Circuit
 Voltage Set Point **14.50 V**

Original & X-References..

For use on : AMC, Renault, Volvo

LUCAS	21225345	UCB218
VALEO	182046	2590588
MOBILETRON	VR-PR1652H	
WAI	35-9405	35-9405-1
CARGO	130657	
TRANSPO	IP1652	



08-016

FEATURES

B-Circuit
 Voltage Set Point **14.50 V**
 Soft Start **30 %**
 LRC **5 sec**
 Field Shorted Circuit Protection
 Under Voltage Indication
 Over Voltage Indication
 DFM function
 Self exciting function

Original & X-References..

VALEO	593362
	YM 1610F
CARGO	234533



08-017

FEATURES

A-Circuit
 Voltage Set Point **14.20 V**

Original & X-References..

VALEO	2521766	2523190	2521760
	2522339	2522939	2940328
	2941121		

08-028

A-Circuit
 Voltage Set Point **14.50 V**

MOBILETRON	VR-VW005N
CARGO	135393 131224
TRANSPO	M506

TRANSPO	M507
---------	------



08-018

FEATURES

B-Circuit
 Voltage Set Point **14.50 V**
 Soft Start **30 %** LRC **5 sec**
 Field Shorted Circuit Protection
 Under/ Over Voltage Indication
 DFM function with duty cycle limitation
 Self exciting

Original & X-References..

VALEO	593419
CARGO	233633
TRANSPO	M564

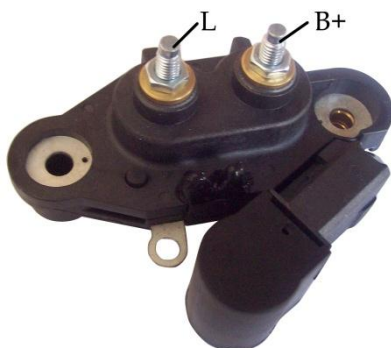

08-019

FEATURES

A-Circuit
 Voltage Set Point **14.50 V**

Original & X-References..

For use on: Fiat, Audi

VALEO	2541406	2541496	592793	9RC2055
	9RC2062		A808239A	
MOBILETRON			VR-PR1667	
CARGO			135434	
TRANSPO			M513	



08-020

FEATURES

B-Circuit
 Voltage Set Point **14.50 V**
 Soft Start **30 %**
 LRC **5 sec**
 Field Shorted Circuit Protection
 Under Voltage Indication
 Over Voltage Indication
 Self exciting function

Original & X-References..

VALEO	593534	593477	593505
MOBILETRON		VR-PR3534	
CARGO		234115	
TRANSPO		M551	

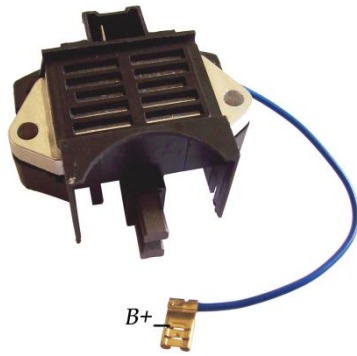

08-021

FEATURES

A-Circuit
Voltage Set Point **28.50 V**

Original & X-References..

VALEO	590640
MOBILETRON	VR-PR128B
CARGO	131120
TRANSPO	IP126



08-022

FEATURES

A-Circuit
Voltage Set Point **28.10 V**

Original & X-References..

VALEO	593260
	ZV3960H
	CA13102R
MOBILETRON	VR-PR3960
CARGO	137489

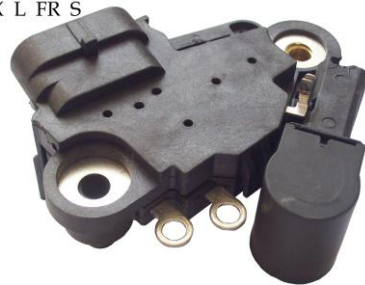
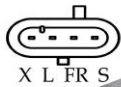

08-023

FEATURES

B-Circuit
Voltage Set Point **14.80 V**
Soft Start **30 %**
LRC **5 sec**
Field Shorted Circuit Protection
Sense Open Indication
Under Voltage Indication
Over Voltage Indication
DFM function

Original & X-References..

VALEO	2542339B
TRANSPO	M533



08-024

FEATURES

B-Circuit
Voltage Set Point **14.50 V**

Original & X-References..



08-025

FEATURES

B-Circuit
Voltage Set Point **14.50 V**

Original & X-References..

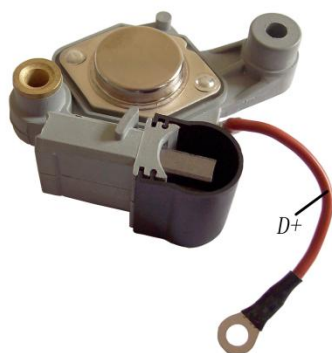

08-026

FEATURES **Original & X-References..**

A-Circuit
Voltage Set Point **14.50 V**



08-027

FEATURES **Original & X-References..**

A-Circuit
Voltage Set Point **14.70 V**

VALEO	593434	
	593466	YM1658
CARGO	235079	

08-034

A-Circuit
Voltage Set Point **28.50 V**



08-031

FEATUERS **Original & X-References..**

B-Circuit
Voltage Set Point **14.50 V**
Soft Start **32 %**
LRC **5 sec**
Field Shorted Circuit Protection
Under Voltage Indication
Over Voltage Indication
Self exciting function

VALEO	493811	
	2542521B	



08-032

FEATURES **Original & X-References..**

B-Circuit
Voltage Set Point **14.50 V**
Soft Start **30 %**
LRC **5 sec**
Field Shorted Circuit Protection
Under Voltage Indication
Over Voltage Indication
DFM function
Self exciting function

VALEO	593529	
CAGRO	234982	
TRANSPO	M562	



08-033

FEATUERS **Original & X-References..**

B-Circuit
Voltage Set Point **14.80 V**
Soft Start **32 %**
LRC **5 sec**
Field, Shorted Circuit Protection
Under Voltage Indication
Over Voltage Indication

VALEO	2542378B	2543325B
	593423	
LESTER	13971	
TRANSPO	M523	



L DFM



08-035

FEATUERS

Original & X-References..

- B-Circuit
- Voltage Set Point **14.50 V**
- Soft Start **30 %**
- LRC **5 sec**
- Field Shorted Circuit Protection
- Under Voltage Indication
- Over Voltage Indication
- DFM function
- Self exciting function



L IG

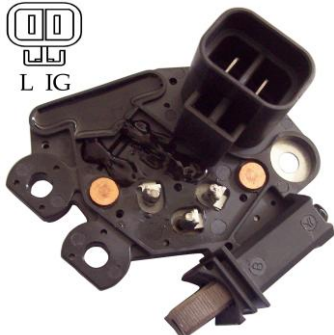

08-036

FEATUERS

Original & X-References..

- A-Circuit
- Voltage Set Point **14.50 V**

08-042

- A-Circuit
- Voltage Set Point **14.60 V**



IG L



08-038

FEATUERS

Original & X-References..

- A-Circuit
- Voltage Set Point **14.50V**



L DFM S

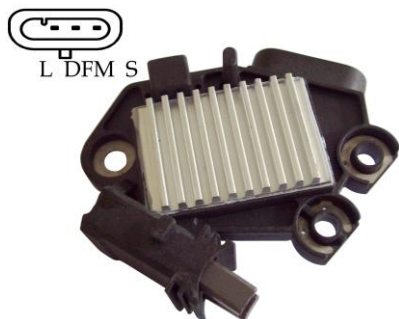

08-039

FEATUERS

Original & X-References..

- B-Circuit
- Voltage Set Point **14.45 V**
- Soft Start **30 %**
- LRC **5 sec**
- Field Shorted Circuit Protection
- Sense Open Indication
- Under Voltage Indication
- Over Voltage Indication
- DFM function

Original & X-References..	
VALEO	2542499
MOBILETRON	VR-V2499
LESTER	13943
TRANSPO	M520



X L IG



08-040

FEATURES

Original & X-References..

- B-Circuit
- Voltage Set Point **14.30 V**
- Soft Start **32 %**
- LRC **5 sec**
- Field, Shorted Circuit Protection
- Under Voltage Indication
- Over Voltage Indication
- Self Exciting Function

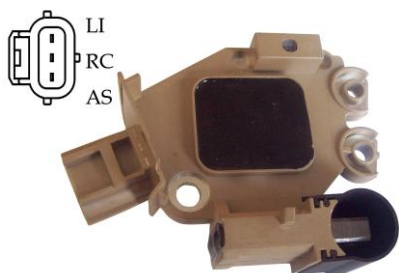

08-043

FEATUERS

A-Circuit
 RC=0 $V_s=13.50V$
 RC=55% $V_s=14.25V$

Original & X-References..

VALEO 599121
 TG9C013
 MOBILETRON VR-PR4920



08-044

FEATUERS

B-Circuit
 Voltage Set Point **14.80 V**
 Soft Start **15 %**
 LRC **2.5 sec**
 Self exciting function

Original & X-References..

VALEO 599101
 593780 595458
 CARGO 236597

COM regulator

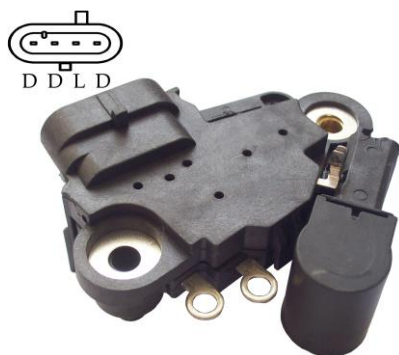

08-045

FEATURES

B-Circuit
 Voltage Set Point **14.80 V**
 Soft Start **30 %**
 LRC **5 sec**
 Field Shorted Circuit Protection
 Sense Open Indication
 Under Voltage Indication
 Over Voltage Indication
 DFM function

Original & X-References..

VALEO 254366C
 2546493C
 TRANSPO M515



08-048

FEATURES

B-Circuit
 Voltage Set Point **14.50 V**
 Soft Start **30 %**
 LRC **5 sec**
 Field Shorted Circuit Protection
 Under Voltage Indication
 Over Voltage Indication
 DFM function
 Self exciting function

Original & X-References..



08-049

FEATUERS

B-Circuit
 Voltage Set Point **14.80 V**
 Soft Start **15 %**
 LRC **2.5 sec**
 Self exciting function

Original & X-References..

VALEO 595253

COM regulator

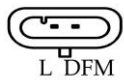

08-051

FEATURES

B-Circuit
 Voltage Set Point **14.50 V**
 Soft Start **30 %**
 LRC **5 sec**
 Field Shorted Circuit Protection
 Sense Open Indication
 Under / Over Voltage Indication
 DFM function
 Self exciting function

Original & X-References..

VALEO 2542765
 MOBILETRON VR-PR2765
 TRANSPO M524



08-052

FEATURES

B-Circuit
 Voltage Set Point **14.50 V**
 Soft Start **30 %**
 LRC **5 sec**
 Field Shorted Circuit Protection
 Under Voltage Indication
 Over Voltage Indication
 Self exciting function

Original & X-References..

VALEO 20051012 2655001
 2655479
 MOBILETRON VR-V5001
 LESTER 11015 11020
 TRANSPO M531



08-053

FEATURES

B-Circuit
 Voltage Set Point **14.50 V**
 Soft Start **30 %**
 LRC **5 sec**
 Field Shorted Circuit Protection
 Under Voltage Indication
 Over Voltage Indication
 DFM function
 Self exciting function

Original & X-References..

VALEO 2650030C
 LESTER 11017
 TRANSPO M534



08-054

FEATURES

B-Circuit
 VSP 13.80V @PWM Signal Loss
 L-F Terminals
 RVC

Original & X-References..

VALEO 2650441 2650561
 LESTER 11021 11023 11148
 11265 11266
 TRANSPO M540



08-055

FEATURES

B-Circuit
 Voltage Set Point **14.50 V**
 Soft Start **30 %**
 LRC **5 sec**
 Field Shorted Circuit Protection
 Under Voltage Indication
 Over Voltage Indication
 DFM function
 Self exciting function

Original & X-References..

VALEO 2650473
 LESTER 11142
 TRANSPO M558

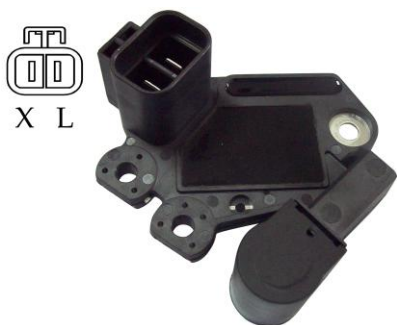

08-057

FEATURES

B-Circuit
 Voltage Set Point **14.50 V**
 Soft Start **30 %**
 LRC **5 sec**
 Field Shorted Circuit Protection
 Under Voltage Indication
 Over Voltage Indication
 Self exciting function

Original & X-References..

CARGO 236224



08-058

FEATURES

A-Circuit
 Voltage Set Point **14.80 V**
 Soft Start **17 %**
 LRC **4 sec**
 Self Exciting Function

Original & X-References..

VALEO 593771 595256 593538

BSS Regulator



08-060

FEATURES

A-Circuit
 Voltage Set Point **14.50 V**

Original & X-References..

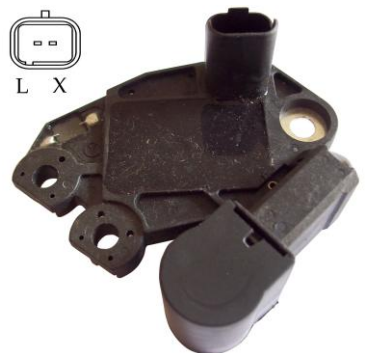

08-061

FEATURES

B-Circuit
 Voltage Set Point **14.50 V**
 Soft Start **30 %** LRC **5 sec**
 Field Shorted Circuit Protection
 Under Voltage Indication
 Over Voltage Indication
 Self exciting function

Original & X-References..



08-063

FEATURES

B-Circuit
 Voltage Set Point **14.50 V**
 Soft Start **30 %** LRC **5 sec**
 Field Shorted Circuit Protection
 Under/ Over Voltage Indication
 DFM Function
 Self Exciting Function

Original & X-References..

VALEO 20071017 20080622
 LESTER 11012 11013
 TRANSPO M563



08-064

FEATURES

Original & X-References..

B-Circuit
 Voltage Set Point **14.50 V**
 Soft Start **30 %** LRC **5 sec**
 Field Shorted Circuit Protection
 Under/ Over Voltage Indication
 DFM Function
 Self Exciting Function



08-065

FEATUERS

Original & X-References..

B-Circuit
 Voltage Set Point **14.50 V**
 Soft Start **30 %** LRC **5 sec**
 Field Shorted Circuit Protection
 Under Voltage Indication
 Over Voltage Indication
 DFM Function
 Self exciting function
 For use on: Citroen Xantia

VALEO	593532	
LESTER	21785	21788
TRANSPO	M561	



08-066

FEATUERS

Original & X-References..

B-Circuit
 Voltage Set Point **14.50 V**
 Soft Start **30 %** LRC **5 sec**
 Field Shorted Circuit Protection
 Under / Over Voltage Indication
 Self exciting function

VALEO	593546	593689
	2542299	2542638
MOBILETRON	VR-V3689	
LESTER	20506	22990
	23174	23893
TRANSPO	M546	

For use on: Mitsubishi, Nissan, Opel, Renault, Volvo (Europe)

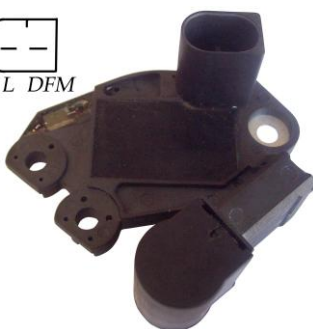

08-068

FEATURES

Original & X-References..

B-Circuit
 Voltage Set Point **14.50 V**
 Soft Start **30 %** LRC **5 sec**
 Field Shorted Circuit Protection
 Under Voltage Indication
 Over Voltage Indication
 DFM Function
 Self exciting function

VALEO	593813	
LESTER	11019	11070 11149
	11161	13946 13947
TRANSPO	M547	



08-069

FEATURES

Original & X-References..

B-Circuit
 VSP 13.80V @PWM Signal Loss
 L-F Terminals
 RVC

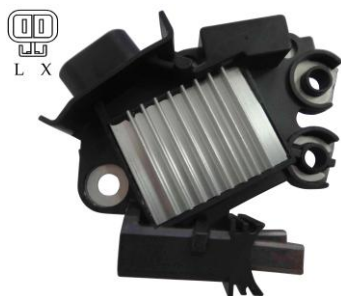

08-070

FEATURES **Original & X-References..**

B-Circuit
 Voltage Set Point **14.50 V**
 Soft Start **30 %** LRC **5 sec**
 Field Shorted Circuit Protection
 Under/ Over Voltage Indication
 Self Exciting Function



08-073

FEATURES **Original & X-References..**

B-Circuit
 Voltage Set Point **14.00 V**
 LRC **3 sec**
 Self Exciting Function

VALEO 593970

LIN Regulator



08-074

FEATURES **Original & X-References..**

B-Circuit
 Voltage Set Point **14.00 V**
 LRC **3 sec**
 Self Exciting Function

VALEO 595305

LIN Regulator



08-075

FEATURES **Original & X-References..**

B-Circuit
 Voltage Set Point **14.00 V**
 LRC **3 sec**
 Self Exciting Function

VALEO 595325

LIN Regulator



08-076

FEATURES **Original & X-References..**

B-Circuit
 Voltage Set Point **14.00 V**
 LRC **3 sec**
 Self Exciting Function

VALEO 2614772

LIN Regulator



09-001

FEATURES

A-Circuit
Voltage Set Point **28.50V**
T.C. -10mV/°C

Original & X-References..

MOTOROLA 9RC3118
USI 71-90009

09-009

Voltage Set Point **28.50V**
T.C. -7mV/°C



09-002

FEATURES

A-Circuit
Voltage Set Point **28.20V**
Field Shorted Circuit Protection

Original & X-References..

MOTOROLA 9RC3114
USI 71-90001

09-003

Voltage Set Point **28.20V**



09-012

FEATUERS

A-Circuit
Voltage Set Point **28.50 V**
Field, Shorted Circuit Protection
Longer pin

Original & X-References..

MOTOROLA 9RC3114

09-019

Voltage Set Point **28.00 V**
Longer pin



09-013

FEATUERS

A-Circuit
Voltage Set Point **14.50 V**

Original & X-References..

MOTOROLA 9RC2020



09-020

FEATURES

A-Circuit
Voltage Set Point **14.50V**

Original & X-References..

MOTOROLA 9RC2106

09-007

Voltage Set Point **14.70 V**



10-001

FEATURES

A-Circuit
Voltage Set Point **14.50 V**

For SKODA Series Alternators

Original & X-References..

MAGNETON-PAL
0134291 0134541
443930134291
443930136111
443930136131
LESTER 12140
LUCAS VCB901
TRANSPO MP291



10-003

FEATUERS

A-Circuit
Voltage Set Point **14.40 V**

Original & X-References..



11-001

FEATURES

A-Circuit
Voltage Set Point **28.20 V**

Original & X-References..

FOR MILITARY VEHICLE
5 Wiring Application



11-002

FEATURES

A-Circuit
Voltage Set Point **28.20 V**

Original & X-References..

FOR MILITARY VEHICLE
6 Wiring Application



12-001

FEATURES

A-Circuit
Voltage Set Point **28.80 V**

Original & X-References..

FOR HINO SERIES ALTERNATORS



12-002

FEATURES

A-Circuit
Voltage Set Point 29.30 V

Original & X-References..

FOR KOMATSU GRAB
CARGO 135296
TRANSPO IZ228

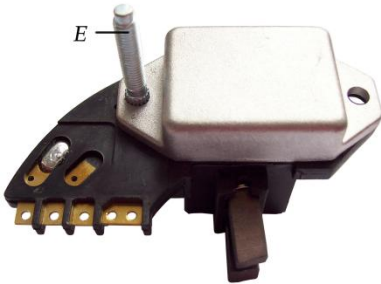

12-003

FEATURES

A-Circuit
Voltage Set Point 29.30 V

Original & X-References..

12-008

Voltage Set Point 28.50 V

12-009

With One Diode



12-005

FEATURES

A-Circuit
Voltage Set Point 28.40 V
With 4 pins

Original & X-References..

FOR KOMATSU GRAB

12-006

Voltage Set Point 14.50 V
With 4 pins

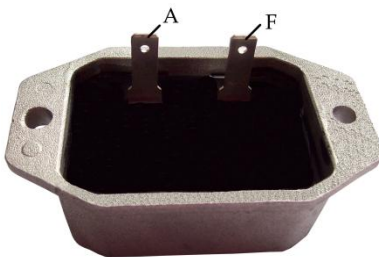

12-007

FEATURES

A-Circuit
Voltage Set Point 28.80 V

Original & X-References..

NIKKO 1440000580 1440000730
ISUZU 1812510040 1812510240
5812510120
MOBLETRON VR-H2003-1B
TRANSPO IZ226



12-010

FEATUERS

A-Circuit
Voltage Set Point 29.30 V

Original & X-References..

KM155



12-011

FEATUERS

A-Circuit
Voltage Set Point **29.20 V**

Original & X-References..

NIKKO 7-44000-0900
CARGO 135321
KM156

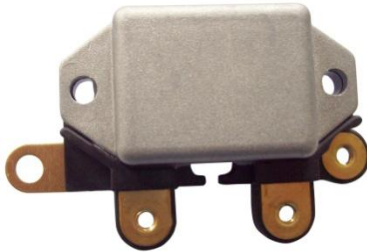

12-012

FEATUERS

A-Circuit
Voltage Set Point **28.40 V**

Original & X-References..

NIKKO 0-37519-0150
0-37519-0151
CARGO 234999



12-016

FEATUERS

A-Circuit
Voltage Set Point **14.50 V**

Original & X-References..



14-001

FEATURES

A-Circuit
Voltage Set Point **14.20 V**

For LEECE NEVILLE
Series Alternator

Original & X-References..

LEECE NEVILLE	
	102200 L79000LH
WAI	35-500
TRANSPO	L79000LH

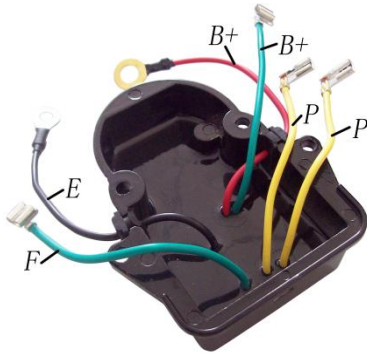

14-002

FEATURES

A-Circuit
Voltage Set Point **14.50 V**

Original & X-References..

MOTOROLA	
	105292 8RG2029A
	110434 110555
	8LAH2070V 8LHA2027
TRANSPO	M5-292A

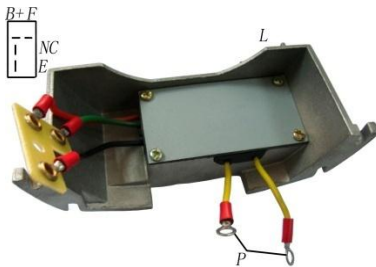

14-003

FEATURES

A-Circuit
Voltage Set Point **28.20 V**
Field, Lamp Shorted Circuit Protection
Over Voltage Indication
With Battery Operation

Original & X-References..

PRESTOLITE	8RL3108C
------------	----------

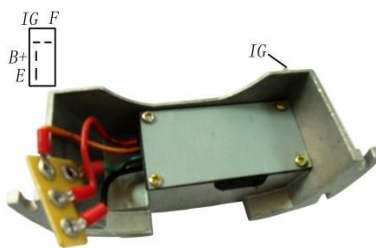

14-004

FEATURES

A-Circuit
Voltage Set Point **27.50V**
Field Shorted Circuit Protection
Over Voltage Indication
Without Battery Operation

Original & X-References..

PRESTOLITE			
	105229	105246	105351 105396
	8RL3007		8RL3011
	8RL3023C		
MOBILETRON			VR-VW006
TRANSPO			M5-396

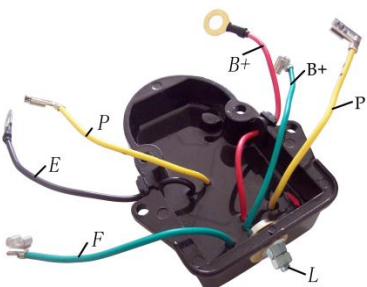

14-006

FEATURES

A-Circuit
Voltage Set Point **28.00V**
Field, Lamp Shorted Circuit Protection
Over Voltage Indication
With Battery Operation

Original & X-References..

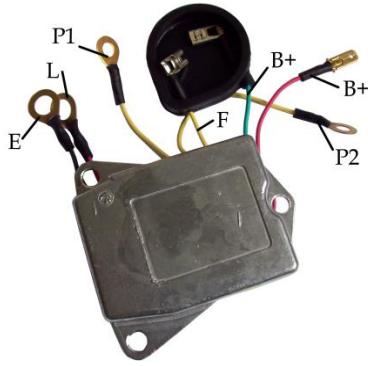

14-010

FEATUERS

Original & X-References..

- A-Circuit
- Voltage Set Point **28.20 V**
- Field, Lamp Shorted Circuit Protection
- Over Voltage Indication

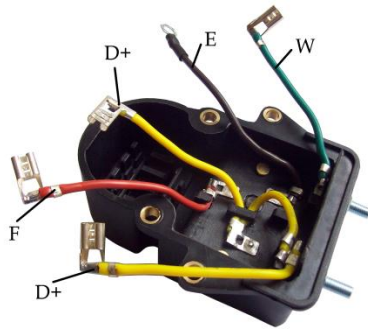

14-015

FEATUERS

Original & X-References..

- A-Circuit
- Voltage Set Point **28.50 V**
- Field, Shorted Circuit Protection

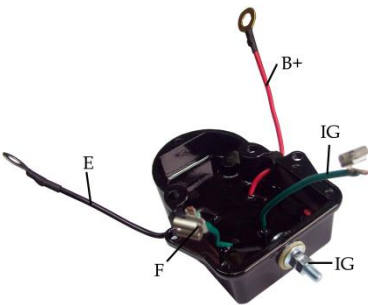

14-016

FEATUERS

Original & X-References..

- A-Circuit
- Voltage Set Point **27.50 V**
- Field, Shorted Circuit Protection



Φ112mm

BHP11201 (Y)

FEATURES

Diodes: 6-50A Avalanche
 Diameter OD: 112mm
 With M8×30mm Battery Post
 With Trio

Original & X-References..

BOSCH	1127319552	1127320852
WAI		31-9121
CARGO	135176	138077 230242
MOBILETRON		RB-22H
TRANSPO		IBR852
BOSCH		1127320850
CARGO		135439
TRANSPO		IBR850

BHP11203 (Y)

Diodes:8-50A Avalanche



Φ112mm

BHP11204 (Y)

FEATURES

Diodes: 6-50A Avalanche
 Diameter OD: 112mm
 With M8×30mm Battery Post
 With Trio

Original & X-References..

BOSCH		1 127 319 593
		1 127 320 807
WAI		31-9126
CARGO		135175 137333
MOBILETRON		RB-121H
TRANSPO		IBR844
BOSCH		1 127 319 637

BHP11202B

Diodes: 8-35A Avalanche
 For 24V Alternators

BHP11202

Diodes: 8-50A Avalanche



Φ112mm

BHP11205 (Y)

FEATURES

Diodes: 8-50A Avalanche
 Diameter OD: 112mm
 With M8×30mm Battery Post
 With Trio

Original & X-References..

BOSCH		1 127 319 560
		1 127 319 011
		1 127 319 746
CARGO		135440
MOBILETRON		RB-134H

BHP11205-2

Diodes: 6-50A Avalanche



Φ112mm

BHP11206 (Y)

FEATURES

Diodes: 6-50A Avalanche
 Diameter OD: 112mm
 With M8×30mm Battery Post
 With Trio

Original & X-References..

BOSCH		1 127 319 021
		1 127 319 673
CARGO		135546

BHP11206-1

Diodes:8-50A Avalanche



Φ112mm

BHP11207 (Y)

FEATURES

Diodes: 6-35A Avalanche
 Diameter OD: 112mm
 With M6×30mm Battery Post
 With Trio
 With 1.2 Kilohm Resistor

Original & X-References..



Φ112mm

BHP11209 (Y)

FEATURES

Diodes: 6-35A Avalanche
 Diameter OD: 112mm
 With M8×40.5mm Battery Post
 With Trio

Original & X-References..

BOSCH	1 127 319 623
	1 127 320 882
CARGO	137257
MOBILERTRON	RB-101H
UNIPOINT	REC 243

BHP11209-1

Diodes: 8-35A Avalanche



Φ112mm

BHP11210B (Y)

FEATURES

Diodes: 8-50A Avalanche
 Diameter OD: 112mm
 With M8 Battery Post
 Without Trio
 For 24V Alternators
 For use on : 0 123 325 5500

Original & X-References..

BOSCH	1 127 319 792
-------	---------------



Φ112mm

BHP11211 (Y)

FEATURES

Diodes: 8-35A Avalanche
 Diameter OD: 112mm
 With M6×30mm Battery Post
 With Trio

Original & X-References..

BHP11211-1

Diodes: 6-35A Avalanche



Φ112mm

BHP11213 (Y)

FEATURES

Diodes: 8-50A Avalanche
 Diameter OD: 112mm
 With M6 Battery Post
 With Trio

Original & X-References..

BOSCH	1 127 319 671
CARGO	139571
TRANSPO	IBR671



Φ112mm

BHP11214 (Y)

FEATURES

Diodes: 8-50A Avalanche
 Diameter OD: 112mm
 With M8×40.5mm Battery Post
 Without Trio

Original & X-References..

BOSCH	1 127 319 514
	1 127 319 563
	1 127 319 564
	1 127 319 698
CARGO	139030



Φ112mm

BHP11215 (Y)

FEATURES

Diodes: 6-50A Avalanche
 Diameter OD: 112mm
 With M8 Battery Post
 With Trio

Original & X-References..

BOSCH 1 127 319 694
 TRANSPO IBR694
 MOBILERTRON RB-36H

BHP11215-1

Diodes: 8-50A Avalanche



Φ122mm

BHP12201 (Y)

FEATURES

Diodes: 14-50A Avalanche
 Diameter OD: 122mm
 With M8×30mm Battery Post
 With Trio

Original & X-References..

BOSCH 1 127 319 552
 1 127 320 852
 WAI 31-9121
 CARGO 135605
 TRANSPO IBR834
 CARGO 230614

For use on : Mercedes Benz
BHP12201-1 12-50A Avalanche
BHP12201B 14-35 A Avalanche
 For 24V Alternators



Φ122mm

BHP12202 (Y)

FEATURES

Diodes: 8-50A Avalanche
 Diameter OD: 122mm
 With M8×30mm Battery Post
 With Trio
 For use on : VW Corado , Golf, Passat,
 Jetta, Eurovan

Original & X-References..

BOSCH 1 127 319 576
 WAI 31-9127
 CARGO 138074
 TRANSPO IBR854

BHP12202-1

Diodes:12-50A Avalanche



Φ122mm

BHP12204 (Y)

FEATURES

Diodes: 12-50A Avalanche
 Diameter OD: 122mm
 With M8×30mm Battery Post
 With Trio

Original & X-References..

BOSCH 1 127 319 690
 1 127 320 860
 CARGO 137259
 TRANSPO IBR860

For use on :1991-00 BMW w/140A



Φ122mm

BHP12205 (Y)

FEATURES

Diodes: 6-50A Avalanche
 Diameter OD: 122mm
 With M8×30mm Battery Post
 With Trio

Original & X-References..

BOSCH 1 127 319 744
 CARGO 230241 230174
 TRANSPO IBR744
 MOBILERTRON RB-33H

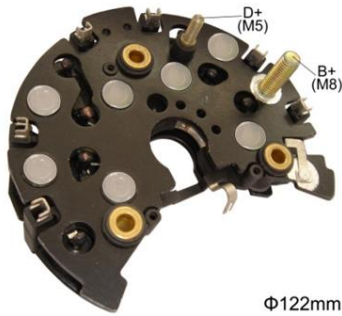

Φ122mm

BHP12206 (Y)

FEATURES

Diodes: 14-50A Avalanche
 Diameter OD: 122mm
 With M8×30mm Battery Post
 With Trio

Original & X-References..

BOSCH 1 127 319 712
 1 127 319 641



Φ122mm

BHP12207 (Δ)

FEATURES

Diodes: 6-50A Avalanche
 Diameter OD: 122mm
 With M8×30mm Battery Post
 With Trio

Original & X-References..

CARGO 231643



Φ122mm

BHP12208 (Δ)

FEATURES

Diodes: 12-50A Avalanche
 Diameter OD: 122mm
 With M8×30mm Battery Post
 With Trio

Original & X-References..

BHP12208B
 For 24V Alternators

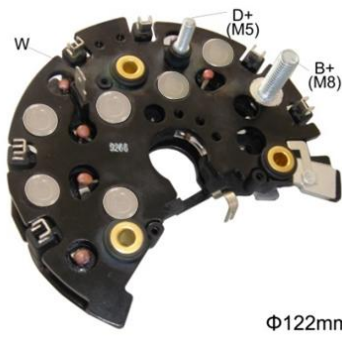

Φ122mm

BHP12208-1 (Δ)

FEATURES

Diodes: 12-50A Avalanche
 Diameter OD: 122mm
 With M8×30mm Battery Post
 With “W” terminal
 With Trio

Original & X-References..

BHP12208B-1
 For 24V Alternators



Φ122mm

BHP12209 (Δ)

FEATURES

Diodes: 6-50A Avalanche
 Diameter OD: 122mm
 With M8×30mm Battery Post
 With Trio

Original & X-References..

BOSCH 1127319734
 1127319572
 CARGO 230093



BHP12210 (Y)

FEATURES

Diodes: 8-50A Avalanche
 Diameter OD: 122mm
 With M8×30mm Battery Post
 With Trio

Original & X-References..

BOSCH	1 127 319 501
	1 127 319 578
	1 127 319 752
TRANSPO	IBR501
CARGO	230173



BHP12211B (Y)

FEATURES

Diodes: 8-50A Avalanche
 Diameter OD: 122mm
 With M8×40.5mm Battery Post
 Without Trio
 For 24V Alternators

Original & X-References..

BOSCH	1 127 319 721
CARGO	234357



BHP12212 (Y)

FEATURES

Diodes: 12-50A Avalanche
 Diameter OD: 122mm
 With M8×40.5mm Battery Post
 Without Trio

Original & X-References..

BOSCH	1 127 319 692
CARGO	139252
TRANSPO	IBR692



BHP12213B (Y)

FEATURES

Diodes: 8-50A Avalanche
 Diameter OD: 122mm
 With M8 Battery Post
 Without Trio
 For 24V Alternators

Original & X-References..

BOSCH	1 127 319794
CARGO	234333



BHP12215 (Y)

FEATURES

Diodes: 8-50A Avalanche
 Diameter OD: 122mm
 With M8×30mm Battery Post
 With Trio

Original & X-References..

BHP12215B

Diodes: 8-50A Avalanche
 For 24V Alternators



BHP12216 (Y)

FEATURES

Diodes: 8-50A Avalanche
 Diameter OD: 122mm
 With M8×30mm Battery Post
 With Trio

Original & X-References..

BOSCH 1 127 319 568
 1 127 319 732

BHP12216-1

With M6×30mm Battery Post



BHP12218 (Δ)

FEATURES

Diodes: 12-50A Avalanche
 Diameter OD: 122mm
 With M8×30mm Battery Post
 With Trio

Original & X-References..

BOSCH 1 127 319 771
 CARGO 233923



BHP12219 (Δ)

FEATURES

Diodes: 12-50A Avalanche
 Diameter OD: 122mm
 With M8×30mm Battery Post
 With Trio

Original & X-References..



BHP12220 (Y)

FEATURES

Diodes: 12-50A Avalanche
 Diameter OD: 122mm
 With M8×40.5mm Battery Post
 With Trio

Original & X-References..

BHP12220-1

Diodes: 14-50A Avalanche



BHP12226 (Δ)

FEATURES

Diodes: 12-60A Avalanche
 Diameter OD: 122mm
 With M8×30mm Battery Post
 With Trio

Original & X-References..



BHP12228A (Y)

FEATURES

Diodes: 14-50A Avalanche
 Diameter: 122mm
 With M8×30mm Battery Post
 With Trio

Original & X-References..

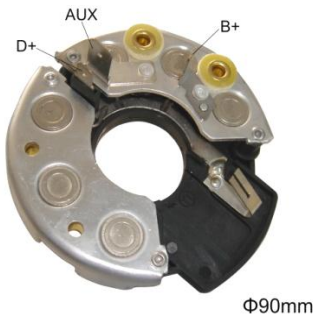

BHP9001

FEATURES

Diodes : 6-35 Ampere
 Diameter OD : 90mm
 With Trio

 For use on : Agrifur, Fiat, Lancia,
 Marshall Tractor, Same, Styer

Original & X-References..

BOSCH	1 690 521 2
	1 127 320 152
	1 127 320 192
	1 127 320 319
CARGO	130597
MOBILETRON	RB-10H
TRANSPO	IBR318



BHP9002

FEATURES

Diodes : 6-35 Ampere
 Diameter OD : 90mm
 With M6×52mm Batter Post
 With M5×28mm Trio Post
 With M5×48mm W-Post
 With Trio

Original & X-References..



BHP9003

FEATURES

Diodes : 6-35 Ampere
 Diameter OD : 90 mm
 With M6×52mm Battery Post
 With Trio

 For use on : John Deere, IH

Original & X-References..

BOSCH	169 05254
	1 127 320 115
	1 127 320 116
	1 127 320 141
	1 127 320 142
WAI	31-9144
CARGO	132670
MOBILETRON	RB-13J
TRANSPO	IBR307

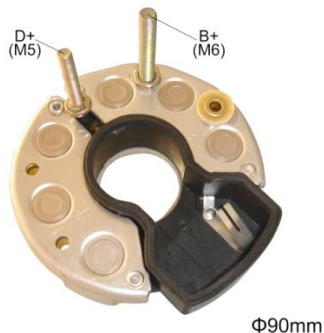

BHP9005

FEATURES

Diodes : 6-35 Ampere
 Diameter OD : 90mm
 With M6×52mm Battery Post
 With M5×28mm Trio Post
 With Trio

Original & X-References..



Φ90mm

BHP9006

FEATURES

Diodes: 6-35A Ampere
 Diameter OD: 90mm
 With M6×37mm Battery Post
 With Trio

Original & X-References..

BOSCH 9 121 080 595
 GAUSS GA1959
 TRANSPO IBR595



Φ114mm

BHP11401

FEATURES

Diodes: 6-35 Ampere
 Diameter OD: 114mm
 With M6×52.5mm Battery Post
 With M4×42mm Trio Post
 With M5×48mm W-Post
 With Trio
 For use on : DAF, Mercedes Benz,
 Renault Midliner, Steyer, Saab Scania
BHP11401HD 6-50Ampere

Original & X-References..

BOSCH
 1 127 011 098 1 127 011 101
 1 127 320 344 1 127 320 363
 1 127 320 366 1 127 320 367
 WAI 31-9139
 CARGO 133138
 MOBILETRON RB-08H
 TRANSPO IBR313

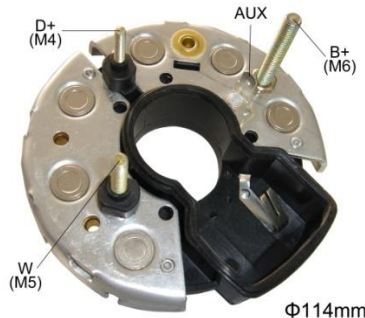

Φ114mm

BHP11402

FEATURES

Diodes: 6-35 Ampere
 Diameter OD: 114mm
 With M6×52.5mm Battery Post
 With M4×42mm Trio Post
 With M5×48mm W-Post
 With Trio
BHP11402HD 6-50 Ampere
BHP11409
 With M6×50mm Battery Post

Original & X-References..

BOSCH
 1 127 011 095 1 127 011 096
 1 127 011 097 1 127 011 103
 1 127 320 147 1 127 320 331
 WAI 31-9140
 CARGO 131468
 TRANSPO IBR314
BHP11409HD 6-50 Ampere
 With M6×50mm Battery Post



Φ114mm

BHP11403

FEATURES

Diodes: 6-35 Ampere
 Diameter OD: 114mm
 With M8×52.5mm Battery Post
 With M4×42mm Trio Post
 With M5×48mm W-Post
 With Trio
 For use on : Mercedes Benz Trucks
BHP11403HD 6-50 Ampere
BHP11403B 6-35A Avalanche
 For 24V Alternators

Original & X-References..

BOSCH 1 127 320 909
 1 127 041 132
 CARGO 133995
 MOBILETRON RB-14H
 TRANSPO IBR315

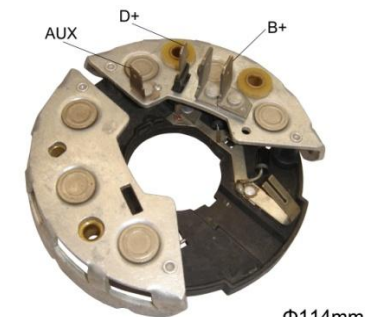

Φ114mm

BHP11404

FEATURES

Diodes: 6-35 Ampere
 Diameter OD: 114mm
 With Trio

BHP11404HD

Diodes: 6-50 Ampere

Original & X-References..

BOSCH
 1 127 011 112 1 127 011 113
 1 127 011 114 1 127 011 115
 1 127 011 135 1 127 320 101
 1 127 320 103 1 127 320 502
 WAI 31-9100
 CARGO 130603
 MOBILETRON RB-01HA
 TRANSPO IBR303

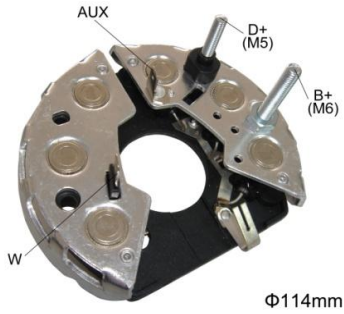

BHP11406

FEATURES

Diodes: 6-35 Ampere
 Diameter OD: 114mm
 With M6×50.4mm Battery Post
 With M5×47.2mm Trio Post
 With Trio

Original & X-References..

BHP11406HD 6-50 Ampere

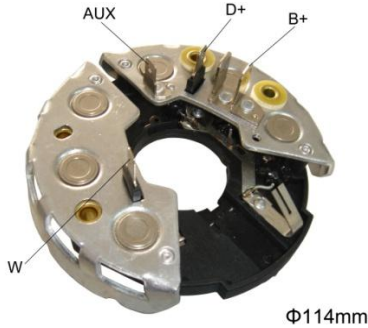

BHP11411

FEATURES

Diodes: 6-35 Ampere
 Diameter OD: 114mm
 With Trio
 For use on : Audi, VW Diesel

Original & X-References..

BOSCH		
	1 127 011 116	1 127 320 506
	1 127 320 614	1 127 320 648
WAI		31-9108
CARGO		131559
MOBILETRON		RB-03HA
TRANSPO		IBR302

BHP11411HD

Diodes: 6-50 Ampere

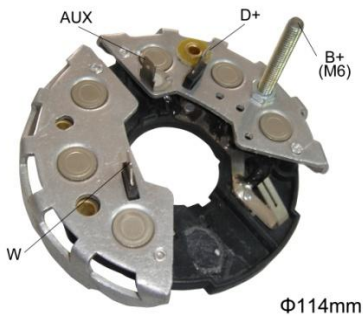

BHP11412

FEATURES

Diodes: 6-35 Ampere
 Diameter OD: 114mm
 With M6×52.5mm Battery Post
 With Trio
 For use on: Volvo Diesel

Original & X-References..

BOSCH		1 127 011 131
WAI		31-9116
CARGO		134341
MOBILETR		RB-16H
TRANSPO		IBR301

BHP11412HD

Diodes: 6-50 Ampere

BHP11431

Diodes: 6-35Ampere
 With M8×52.5mm Battery Post

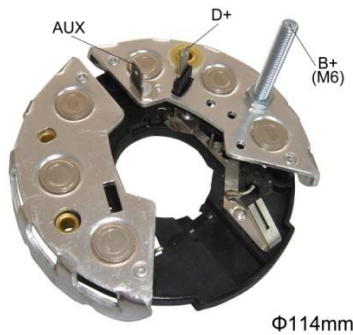

BHP11413

FEATURES

Diodes: 6-35 Ampere
 Diameter OD: 114mm
 With M6×52.5mm Battery Post
 With Trio

Original & X-References..

BOSCH		
	1 127 011 138	1 127 320 501
	1 127 320 511	1 127 320 620
WAI		31-9101
CARGO		130602
MOBILETRON		RB-02H
TRANSPO		IBR304

BHP11413HD

Diodes:6-50 Ampere

BHP11413A

Diodes:6-35A Avalanche

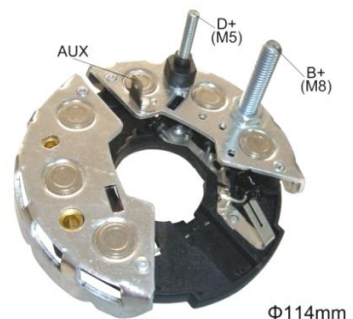

BHP11414

FEATURES

Diodes: 6-35 Ampere
 Diameter OD: 114mm
 With M8×52.5mm Battery Post
 With M5×47.2mm Trio Post
 With Trio

Original & X-References..

BOSCH		
	1 127 320 601	1 127 320 661
	1 127 320 662	1 127 320 691
CARGO		132668
		230361
MOBILETRON		RB-05H
TRANSPO		IBR316

For use on : Audi Saab Scania, VW

BHP11414HD 6-50 Ampere

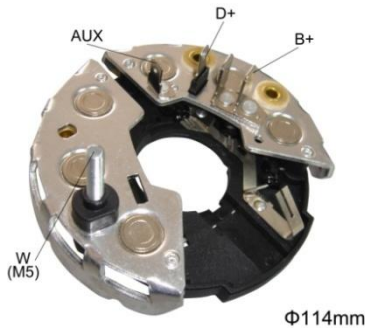

BHP11415

FEATURES

Diodes: 6-35 Ampere
 Diameter OD: 114mm
 With M5×47.2mm W-Post
 With Trio
 For use on : Ford Cortina, Granada,
 Scorio + Cargo Van
BHP11415HD 6-50 Ampere

Original & X-References..

BOSCH
 1 127 011 139 1 127 320 372
 1 127 320 580 1 127 320 652
 CARGO 132669
 MOBILETRON RB-06HA
 TRANSPO IBR317



BHP11416

FEATURES

Diodes: 6-35 Ampere
 Diameter OD: 114mm
 With M6×52.5mm Battery Post
 With M5×47.2mm Trio Post
 With M5×47.2mm W-Post
 With Trio
 For use on: Various
BHP11416HD 6-50 Ampere
BHP11416A 6-35 Avalanche

Original & X-References..

BOSCH 9 121 147 302
 CARGO 133997
 MOBILETRON RB-17H
 TRANSPO IBR320



BHP11417

FEATURES

Diodes: 6-35 Ampere
 Diameter OD: 114mm
 With (M8+M6) ×54.6 Battery Post
 With M5×47.2mm Trio Post
 With Trio
BHP11417HD
 Diodes: 6-50 Ampere

Original & X-References..

BOSCH 1 127 320 651
 1 127 320 677
 CARGO 133996
 MOBILETRON RB-19H
 TRANSPO IBR321



BHP11418

FEATURES

Diodes: 6-35 Ampere
 Diameter OD: 114mm
 With (M8+M6) ×54.6mm Battery Post
 With M5×47.2mm Trio Post
 With Trio
BHP11418HD
 Diodes: 6-50 Ampere

Original & X-References..

BOSCH 1 127 320 914
 GM 90 350 009
 CARGO 133998
 MOBILETRON RB-18H
 TRANSPO IBR322

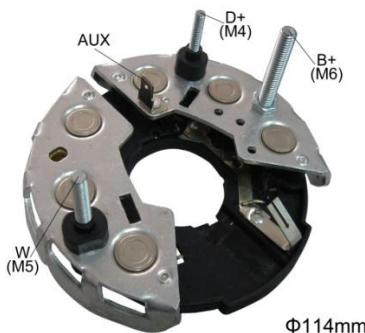

BHP11419

FEATURES

Diodes: 6-35 Ampere
 Diameter OD: 114mm
 With M6×52.5mm Battery Post
 With M4×42mm Trio Post
 With M5×47.2mm W-Post
 With Trio
BHP11419HD 6-50 Ampere

Original & X-References..

BOSCH 1 127 320 667
 FORD 6156187
 86AB10304AA
 CARGO 135890
 MOBILETRON RB-38H
 TRANSPO IBR667



BHP11420

FEATURES

Diodes: 6-35 Ampere
 Diameter OD: 114mm
 With Trio
 For use on : 1988-91 Ford Sierra 1.8L

Original & X-References..

BOSCH	1 127 320 903
CARGO	137726
MOBILETRON	RB-86H
TRANSPO	IBR903

BHP11420HD

Diodes: 6-50 Ampere

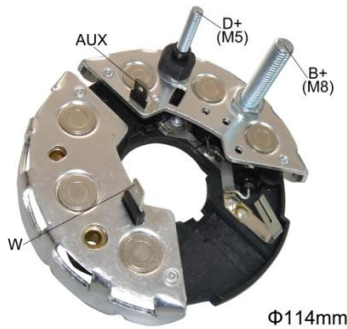

BHP11421

FEATURES

Diodes: 6-35 Ampere
 Diameter OD: 114mm
 With M8×52.5mm Battery Post
 With M5×47.2mm Trio Post
 With Trio
 For use on: Audi, VW Diesel

Original & X-References..

BOSCH	1 127 320 664
	1 127 320 665
	1 127 320 666
WAI	31-9114
CARGO	132667
MOBILETRON	RB-04H
TRANSPO	IBR311

BHP11421HD

Diodes: 6-50 Ampere

BHP11421A

Diodes: 6-35 A Avalanche



BHP11422

FEATURES

Diodes: 6-35 Ampere
 Diameter OD: 114mm
 With M6×52.5mm Battery Post
 With M4×42mm Trio Post
 With Trio
 For use on : VW

Original & X-References..

BOSCH	1 127 320 668
WAI	31-9145
CARGO	133994
MOBILETRON	RB-15H
TRANSPO	IBR319

BHP11422HD 6-50 Ampere



BHP11424

FEATURES

Diodes: 6-35 Ampere
 Diameter OD: 114mm
 With M6×52.5mm Battery Post
 With Trio
 For use on : Komatsu 1982-89 Audi Quattro Turbo

Original & X-References..

BHP11424HD

Diodes:6-50 Ampere



BHP11425

FEATURES

Diodes: 8-50 Ampere
 Diameter OD: 114mm
 With (M8+M6) ×48mm Battery Post
 With Trio

Original & X-References..



BHP11426A

FEATURES

Diodes: 6-50A Avalanche
 Diameter OD: 114mm
 With M6×50mm Battery Post
 Without Trio
BHP11426 6-50A Ampere
BHP11426-1 8-50A Ampere
BHP11426-2
 Diodes: 8-50A Ampere
 With M8×52mm Battery Post

Original & X-References..

BOSCH 9 120 067 027
 9 121 067 385
 9 121 067 394
 TRANSPO IBR388
 BOSCH 9 121 067 379
 TRANSPO IBR323
BHP11426A-1
 Diodes: 6-50 A Avalanche
 Without "W" Terminal /Without Trio

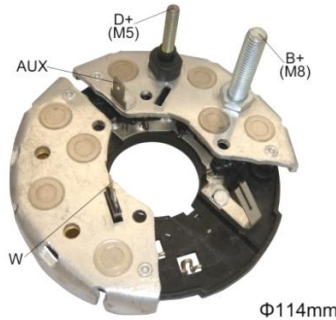

BHP11427

FEATURES

Diodes: 8-50 Ampere
 Diameter OD: 114mm
 With M8×52.5mm Battery Post
 With M5×48mm Trio Post
 With Trio

Original & X-References..

BOSCH 1 127 320 692
 CARGO 138165
 TRANSPO IBR324

BHP11427A

Diodes:8-50 A Avalanche

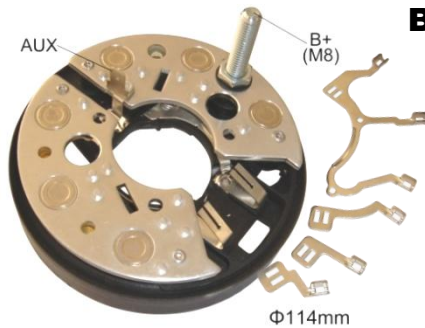

BHP11428A

FEATURES

Diodes: 6-35 A Avalanche
 Diameter OD: 114mm
 With M8×52mm Battery Post
 Without Trio

Original & X-References..

BOSCH 9 120 067 027
 9 121 067 379
 9 121 067 385
 CARGO 136591
 TRANSPO IBR388

BHP11432A

Diodes:8-35 A Avalanche



BHP11430A

FEATURES

Diodes: 8-35A Avalanche
 Diameter OD: 114mm
 With M8×52mm Battery Post
 Without Trio

Original & X-References..

BOSCH 9 121 067 067
 9 121 067 388
 9 121 067 364
 TRANSPO IBR308

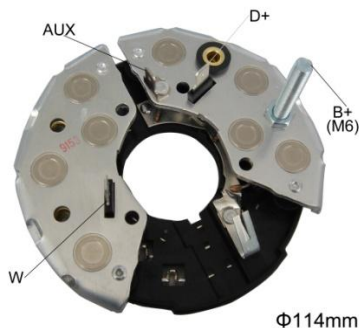

BHP11433A

FEATURES

Diodes: 8-50A Avalanche
 Diameter OD: 114mm
 With M6×52.5mm Battery Post
 With Trio
BHP11446
 Diodes: 6-50 A Ampere
 With M6×50mm Battery Post

Original & X-References..

BOSCH F010LD1067 F010LD0001
 WAGNER W060-69
 TRANSPO IBR276C



Φ114mm

BHP11435

FEATURES

Diodes: 8-50A Ampere
 Diameter OD: 114mm
 With M6×50mm Battery Post
 Without Trio

Original & X-References..

FORD	E9YJ-10304A
CARGO	136556
MOBILETRON	MFRX00711
	RB-81H
TRANSPO	IBR347

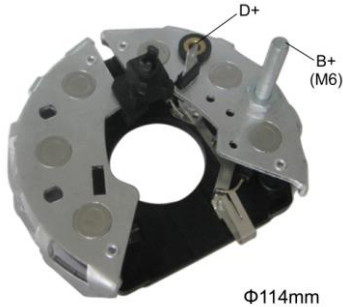

Φ114mm

BHP11440

FEATURES

Diodes: 6-35A Ampere
 Diameter OD: 114mm
 With M6×50.4mm Battery Post
 With Trio

Original & X-References..

BOSCH	0120488313
	0120488312
	0120488311

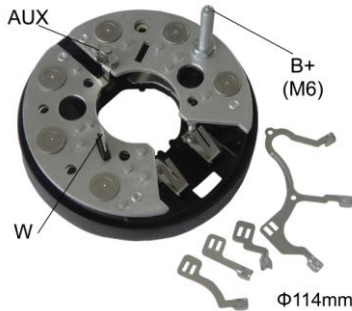

Φ114mm

BHP11445A

FEATURES

Diodes: 6-35A Avalanche
 Diameter OD: 114mm
 With M6×52.5 Battery Post

Original & X-References..

BOSCH	9120061105
-------	------------

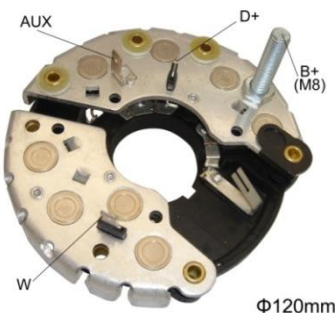

Φ120mm

BHP121001

FEATURES

Diodes: 8-35 Ampere
 Diameter OD: 120mm
 With M8×52mm Battery Post
 With Trio

Original & X-References..

For use on : Audi, VW

AUDI/VW	068 903 359 A
BOSCH	1 127 320 701
WAI	31-9138
CARGO	134000
MOBILETRON	RB-76H
TRANSPO	IBR350



Φ120mm

BHP121002

FEATURES

Diodes: 8-35 Ampere
 Diameter OD: 120mm
 With M8×52mm Battery Post
 With Trio

Original & X-References..

FOR USE ON: Audi, Fiat, Ford

BOSCH	1 127 320 700
	1 127 320 730
WAI	31-9106
CARGO	132103
MOBILETRON	RB-51H
TRANSPO	IBR351

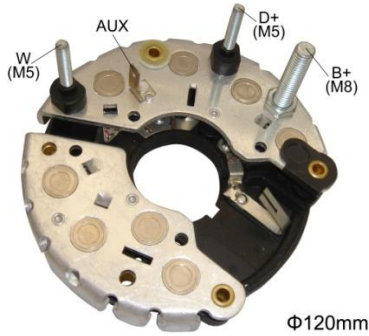

BHP121004

FEATURES

Diodes: 8-35 Ampere
 Diameter OD: 120mm
 With M8×52mm Battery Post
 With M5×48mm Trio Post
 With M5×48mm W-Post
 With Trio
 For use on : BMW, Ford, Merkur

Original & X-References..

BOSCH	1 127 320 706
CARGO	134002
MOBILETRON	RB-53H
TRANSPO	IBR353

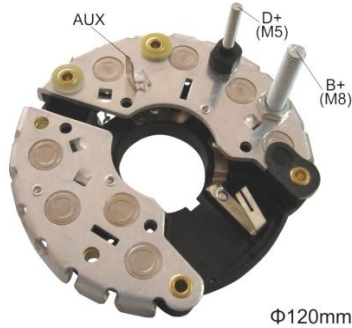

BHP121005

FEATURES

Diodes: 8-35 Ampere
 Diameter OD: 120mm
 With M8×52mm Battery Post
 With M5×48mm Trio Post
 With Trio
 For use on : Audi, BMW, Mercedes Benz, Opel, VW

Original & X-References..

BOSCH	1 127 320 705	1 127 320 710
	1 127 320 723	1 127 320 728
	1 127 320 732	1 127 320 739
	1 127 320 745	1 127 320 749
CARGO	138082	233778
MOBILETRON	RB-54H	
TRANSPO	IBR354	

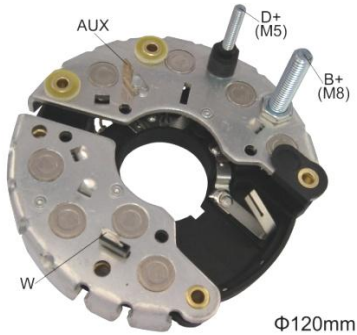

BHP121006

FEATURES

Diodes: 8-35 Ampere
 Diameter OD: 120mm
 With M8×52mm Battery Post
 With M5×48mm Trio Post
 With Trio
 Without Capacitor
BHP121015
 With Capacitor

Original & X-References..

BOSCH	1 127 320 708
	1 127 320 731
WAI	31-9133
CARGO	134003
MOBILETRON	RB-56H
TRANSPO	IBR357

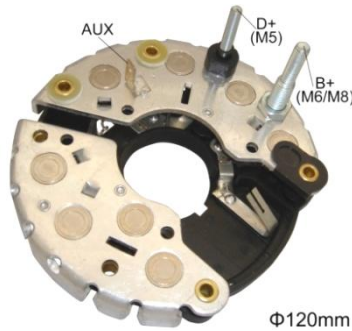

BHP121007

FEATURES

Diodes: 8-35 Ampere
 Diameter OD: 120mm
 With (M8+M6) ×54.6 Battery Post
 With M5×48mm Trio Post
 With Trio

Original & X-References..

BOSCH	1 127 320 712
	1 127 320 735
WAI	31-9132
CARGO	139169
MOBILETRON	RB-58H
TRANSPO	IBR712

For use on : Volvo

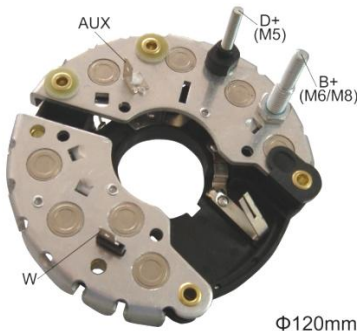

BHP121008

FEATURES

Diodes: 8-35 Ampere
 Diameter OD: 120mm
 With (M8+M6) ×54.6 Battery Post
 With M5×48mm Trio Post
 With Trio
 For use on : Volvo 240 ,740 ,760 ,940 Series

Original & X-References..

BOSCH	1 127 320 716
VOLVO	3515707

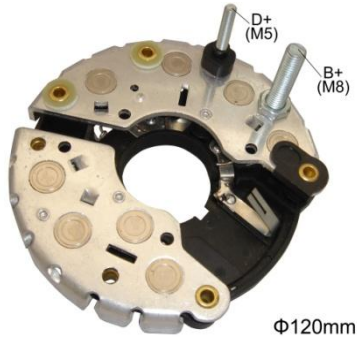

BHP121009

FEATURES

Diodes: 8-35 Ampere
 Diameter OD: 120mm
 With M8×52mm Battery Post
 With M5×48mm Trio Post
 With Trio

Original & X-References..

BOSCH	1 127 320 720
	1 127 320 741
	1 127 320 911
MOBILETRON	RB-77H
TRANSPO	IBR720

For use on : BMW 525i,735i

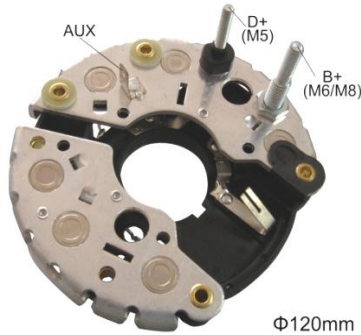

BHP121010

FEATURES

Diodes: 6-35 Ampere
 Diameter OD: 120mm
 With (M8+M6) ×54.6mm Battery Post
 With M5×48mm Trio Post
 With Trio

Original & X-References..

BOSCH	1 127 320 713
CARGO	138620
MOBILETRON	RB-59H
TRANSPO	IBR713

For use on : Volvo 740, 760, 780, 940 Series

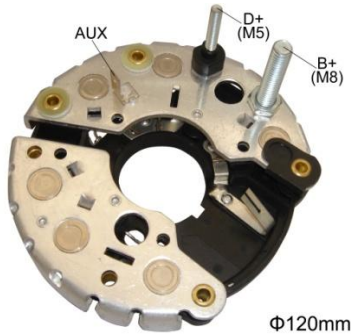

BHP121011

FEATURES

Diodes: 6-35 Ampere
 Diameter OD: 120mm
 With M8×52mm Battery Post
 With M5×48mm Trio Post
 With Trio

Original & X-References..

BOSCH	1 127 320 702
	1 127 320 709
	1 127 320 722
CARGO	133261
WAI	31-9109
MOBILETRON	RB-55H
TRANSPO	IBR355

For use on : BMW, Opel, Saab



BHP121012

FEATURES

Diodes: 6-35 Ampere
 Diameter OD: 120mm
 With (M8+M6) ×54.6mm Battery Post
 Without Trio

Original & X-References..

BOSCH	1 127 320 718
	1 127 320 719
WAI	31-9110
	31-9146
CARGO	138987
MOBILETRON	RB-75H
TRANSPO	IBR329

For use on : Chrysler, Dodge, Plymouth

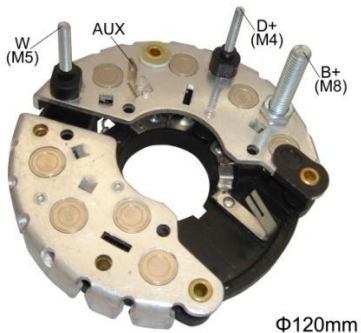

BHP121013

FEATURES

Diodes: 8-35 Ampere
 Diameter OD: 120mm
 With M8×52mm Battery Post
 With M4×48mmTrio Post
 With M5×48mmW-Post
 With Trio

Original & X-References..

BOSCH	1 127 320 750	1 127 320 753
CARGO	231451	137724
TRANSPO	IBR753	

BHP121013A 8-35 A Avalanche
BHP121013B 8-35 A Avalanche
 For 24V Alternators

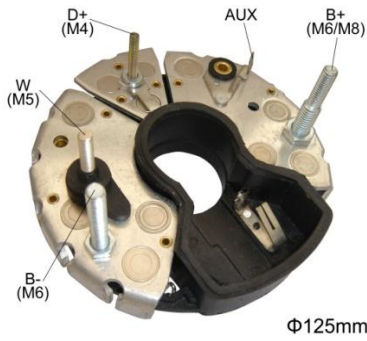

BHP12501

FEATURES

Diodes: 8-50 Ampere
 Diameter OD: 125mm
 With (M8+M6) ×54.6mm Battery Post
 With M4×32.5mm Trio Post
 With M6×52mm Ground Post
 With M5 W-Post
 With Trio
 For use on: Scania
BHP12501-1 8-50 Ampere

Original & X-References..

BOSCH	1 127 320 590
	1 127 320 977
CARGO	134609
MOBILETRON	RB-63H
TRANSPO	IBR590

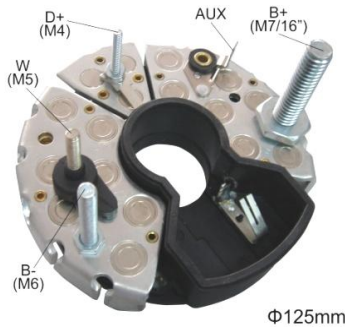

BHP12503

FEATURES

Diodes: 14-50 Ampere
 Diameter OD: 125mm
 With 7/16" Battery Post
 With M4×32.5mm Trio Post
 With M6×52mm Ground Post
 With M5 W-Post
 With Trio
 For use on : J.I. Case Tractors

Original & X-References..

BOSCH	1127320954
CARGO	136737
MOBILETRON	RB-67H
TRANSPO	IBR954

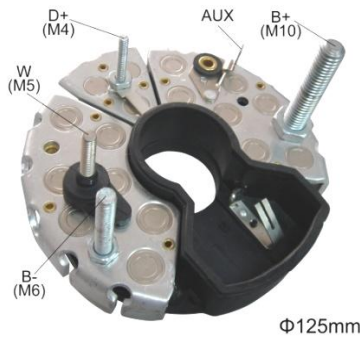

BHP12504

FEATURES

Diodes: 14-50 Ampere
 Diameter OD: 125mm
 With M10×63mm Battery Post
 With M4×32.5mm Trio Post
 With M6×52mm Ground Post
 With M5 W-Post
 With Trio

Original & X-References..

BOSCH	1127320920
CARGO	136737
MOBILETRON	RB-67H
TRANSPO	IBR954

BHP12504A 14-50 A Avalanche TRANSPO IBR954A



BHP12505B

FEATURES

Diodes: 8-35 A Avalanche
 Diameter OD: 125mm
 With 7/16" Battery Post
 With M4×32.5mm Trio Post
 With M6×52mm Ground Post
 With M5 W-Post
 With Trio
 For 24V Alternators

Original & X-References..

BOSCH	1127320957
TRANSPO	IBR957

BHP12505 8-50 Ampere

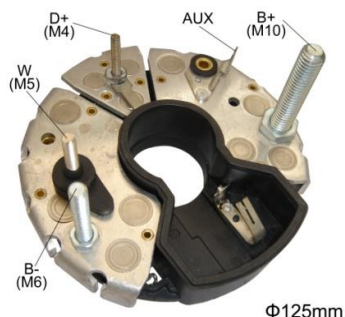

BHP12506

FEATURES

Diodes: 8-50 Ampere
 Diameter OD: 125mm
 With M10×63mm Battery Post
 With M4×32.5mm Trio Post
 With M6×52mm Ground Post
 With M5 W-Post
 With Trio

Original & X-References..

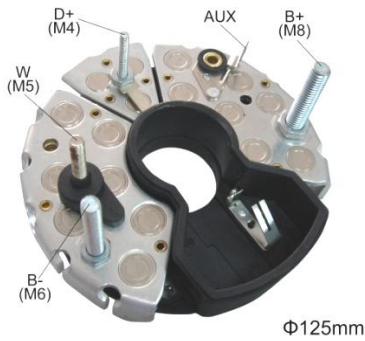

Φ125mm

BHP12509

FEATURES

Diodes: 14-50 Ampere
 Diameter OD: 125mm
 With M8×52mm Battery Post
 With M4×32.5mm Trio Post
 With M6×52mm Ground Post
 With M5 W-Post
 With Trio
 For use on : DAF, Mercedes, Saab scania, Volvo-White Truck

Original & X-References..

BOSCH	1 127 320 959	1 127 320 961
WAI		31-9142
CARGO		139581
MOBILETRON		RB-62H
TRANSPO		IBR341

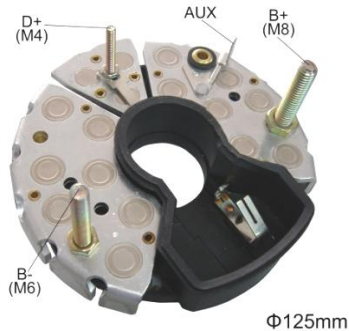

Φ125mm

BHP12510

FEATURES

Diodes: 14-50 Ampere
 Diameter OD: 125mm
 With M8×52mm Battery Post
 With M4×32.5mm Trio Post
 With M6×52mm Ground Post
 With Trio
 For use on : Mercedes, Saab scania, Volvo Truck

Original & X-References..

BOSCH	1 127 320 361	1 127 320 543
WAI		31-9115
CARGO		133530
MOBILETRON		RB-72H
TRANSPO		IBR340

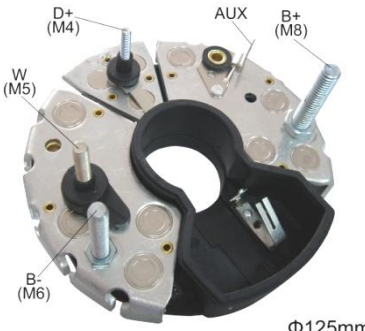

Φ125mm

BHP12511

FEATURES

Diodes: 8-50 Ampere
 Diameter OD: 125mm
 With M8×52mm Battery Post
 With M4×32.5mm Trio Post
 With M6×52mm Ground Post
 With M5 W-Post
 With Trio
BHP12511A 8-50 A Avalanche
BHP12511B 8-35 A Avalanche
 For 24V Alternators

Original & X-References..

BOSCH	1 127 320 602	1 127 320 924
	1 127 320 951	1 127 320 955
	1 127 320 956	1 127 320 980
	1 127 320 981	
TRANSPO		IBR955
BOSCH		1 127 320 989
CARGO		136832
TRANSPO		IBR989

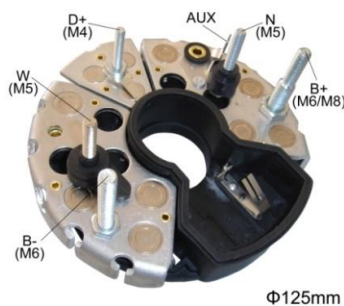

Φ125mm

BHP12517

FEATURES

Diodes: 8-50 Ampere
 Diameter OD: 125mm
 With (M8+M6) ×54.6 Battery Post
 With M4×32.5mm Trio Post
 With M6×52mm Ground Post
 With M5×25mm N-Post
 With M5 W-Post
 With Trio

Original & X-References..

BHP12519



Φ125mm

FEATURES

Diodes: 8-50 Ampere
 Diameter OD: 125mm
 With (M8+M6) ×54.6mm Battery Post
 With M4×32.5mm Trio Post
 With M6×52mm Ground Post
 With Trio

Original & X-References..

BOSCH	1 127 320 517	1 127 320 603
CARGO		231218
TRANSPO		IBR517



BHP14501

FEATURES

Diodes: 12-50 Ampere
 Diameter OD: 145mm
 With M8×52mm Battery Post
 With M5×34.5mm Trio Post
 With M8×52mm Ground Post
 With 3-35A Diode Trio
 For use on : Bus, Industrial
BHP14501B 12-35A Avalanche
 For 24V Alternators

Original & X-References..

BOSCH	1 127 320 550
TRANSPO	IBR550
TRANSPO	IBR973



BHP14502

FEATURES

Diodes: 14-50 Ampere
 Diameter OD: 145mm
 With M8×52mm Battery Post
 With M8×52mm Ground Post
 With M5×34.5mm Trio Post
 With M5×25mm "W" Post
 With 3-35A Diode Trio
 For use on: MAN Buses
BHP14502B
 Diodes: 14-35 A Avalanche

Original & X-References..

BOSCH	1 127 320 547
	1 127 320 571
CARGO	136581
MOBILETRON	RB-78H
TRANSPO	IBR547
	With M5×29.8mm"W" Post
	For 24V Alternators



BHP14507

FEATURES

Diodes: 14-50 Ampere
 Diameter OD: 145mm
 With M8×52mm Battery Post
 With M8×52mm Ground Post
 With M5×34.5mm Trio Post
 With M6 "W" Post
 With 3-35A Diode Trio

Original & X-References..

BOSCH	1127320973
TRANSPO	IBR973
BHP14507B	
	Diodes: 14-50 A Avalanche
	For 24V Alternators
	Without painting black heatsink



BHP14508A1

FEATURES

Diodes: 6-60A Avalanche
 With M8×30mm Battery Post

Original & X-References..

LESTER	13815
TRANSPO	IBR2201



BHP12015 (Y)

FEATURES

Diodes: 6-50A Avalanche
 Diameter OD: 120mm
 With M8×32mm Battery Post(L)
 With M8×22mm Battery Post(R)
 For use on : Opel Astra, Corsa, Zafira,
 Ford Modeo

Original & X-References..

BOSCH	F00M 123202
	0 124 415 001
	0 124 415 002
	0 124 415 005
	0 124 415 006
	0 124 415 008
	0 124 415 009
	0 124 415 010
CARGO	230360
TRANSPO	IBR202



BHP12016B (Δ)

FEATURES

Diodes: 6-35A Avalanche
 Diameter OD: 120mm
 With M8×32mm Battery Post(L)
 With M8×22mm Battery Post(R)
 For 24V Alternators
BHP12069B (Δ)
 Diodes: 6-60 A Avalanche
 For 24V Alternators

Original & X-References..

BOSCH F00M 133224
 TRANSPO IBR224



BHP12017 (Y)

FEATURES

Diodes: 6-50A Avalanche
 Diameter OD: 120mm
 With M6×35mm Battery Post(L)
 With M8×22mm Battery Post(R)
BHP12027 (Y)
 Diodes: 8-50A Avalanche
BHP12048 (Y)
 Diodes: 6-50A Avalanche
 With M8×38mm Battery Post(L)
 With M8×22mm Battery Post(R)

Original & X-References..

BOSCH 0 124 315 019
 0 124 315 027
 0 124 325 100
 TRANSPO IBR233

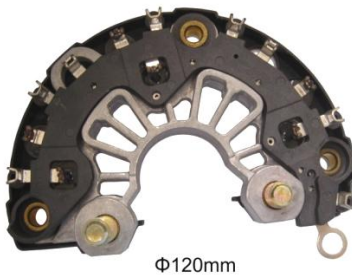

BHP12019 (Y)

FEATURES

Diodes: 6-50A Avalanche
 Diameter OD: 120mm
 With M8×32mm Battery Post(L)
 With M8×22mm Battery Post(R)
 For use on: Porsche Boxter, 911 Opel
 Astra, Zafira
BHP12019-1 (Y)
 Diodes: 8-50A Avalanche

Original & X-References..

TRANSPO IBR200
 CARGO 231714

BHP12019B (Y)
 Diodes: 6-35A Avalanche
 For 24V Alternators



BHP12020 (Y)

FEATURES

Diodes: 6-50A Avalanche
 Diameter OD: 120mm
 With M8×22mm Battery Post(L)
 With M8×32mm Battery Post(R)
 For use on : Porsche Boxter, 911 Opel
 Astra, Zafira
BHP12020B (Y)
 Diodes:6-35A Avalanche
 For 24V Alternators

Original & X-References..

BOSCH 0 124 325 051
 F00M 123226
 CARGO 235546



BHP12021 (Y)

FEATURES

Diodes: 6-50A Avalanche
 Diameter OD: 120mm
 With M8×22mm Battery Post(L)
 With M8×32mm Battery Post(R)
 For use on : Audi A4,Quattro, Passat
 1.6V,1.8, Passat Variant

Original & X-References..

TRANSPO IBR201
 CARGO 139921

BHP12024 (Y)
 Diodes: 8-50A Avalanche

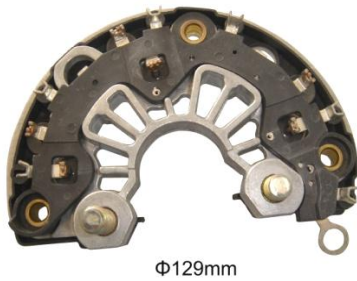

BHP12022 (△)

FEATURES

Diodes: 6-50A Avalanche
 Diameter OD: 129mm
 With M8×32mm Battery Post(L)
 With M8×22mm Battery Post(R)
 With 129 mm Negative heat sink

BHP12022 HD

Diodes: 6-50A Avalanche

Original & X-References..



BHP12023 (△)

FEATURES

Diodes: 6-50A Avalanche
 Diameter OD: 120mm
 With M8×22mm Battery Post(L)
 With M6×35mm Battery Post(R)

Original & X-References..



BHP12025 (△)

FEATURES

Diodes: 6-50A Avalanche
 Diameter OD: 120mm
 With M8×32mm Battery Post(L)
 With M8×32mm Battery Post(R)

BHP12025B (△)

Diodes: 6-35A Avalanche
 For 24V Alternators

Original & X-References..



BHP12025-1 (△)

FEATURES

Diodes: 6-50A Avalanche
 Diameter OD: 120mm
 With M8×22mm Battery Post(L)
 With M8×32mm Battery Post(R)
BHP12049HD (△)
 Diodes: 6-60A Avalanche
 With M8×22mm Battery Post(L)
 With M6×47mm Battery Post(R)

Original & X-References..

BOSCH	F00M 133201
F00M 133205	F00M 133228
F00M 133241	F00M 133246
CARGO	133921
TRANSPO	IBR201



BHP12025-2 (△)

FEATURES

Diodes: 6-50A Avalanche
 Diameter OD: 120mm
 With M8×32mm Battery Post(L)
 With M8×22mm Battery Post(R)
BHP12047HD (△)
 Diodes:6-50A Avalanche
 With M6×38mm Battery Post(L)
 With M8×22mm Battery Post(R)

Original & X-References..

BOSCH	F00M 133200
TRANSPO	IBR200

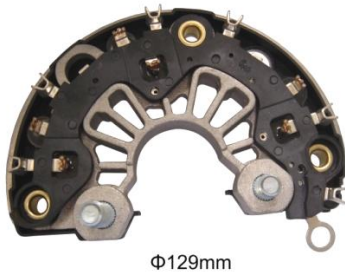

BHP12026HD (△)

FEATURES

Diodes: 6-50A Avalanche
 Diameter OD: 129mm
 With M8×22mm Battery Post(L)
 With M8×32mm Battery Post(R)
 With 129 mm Negative heat sink
BHP12026B (△)
 With M8×34.5mm Battery Post(L)
 With M8×22mm Battery Post(R)
 For 24V Alternators

Original & X-References..

BOSCH F00M 133291
 F00M 133223
BHP12092B (△)
 With M8×34.5mm Battery Post(L)
 With M8×34.5mm Battery Post(R)



BHP12030 (△)

FEATURES

Diodes: 6-50A Avalanche
 Diameter OD: 120mm
 With M8×22mm Battery Post(L)
 With M8×32mm Battery Post(R)
BHP12030HD (△)
 Diodes: 6-60A Avalanche

Original & X-References..

BOSCH F00M 133207
 0 124 515 035 0 124 515 057
 CARGO 230374
 TRANSPO IBR207



BHP12031 (Y)

FEATURES

Diodes: 6-50A Avalanche
 Diameter OD: 120mm
 With M8×22mm Battery Post(L)
 With M8×32mm Battery Post(R)
BHP12067 (Y)
 Diodes: 8-50A Avalanche
BHP120109 (Y)
 With M8×22mm Battery Post(L)
 With M8×34.5mm Battery Post(R)

Original & X-References..

BOSCH F00M 123255
 TRANSPO IBR208



BHP12032 (△)

FEATURES

Diodes: 6-50A Avalanche
 Diameter OD: 120mm
 With M8×32mm Battery Post(L)
 With M8×22mm Battery Post(R)

Original & X-References..

BOSCH F00M 123237
 TRANSPO IBR2237



BHP12033 (Y)

FEATURES

Diodes: 6-50A Avalanche
 Diameter OD: 120mm
 With M8×22mm Battery Post(L)
 With M8×34.5mm Battery Post(R)

Original & X-References..

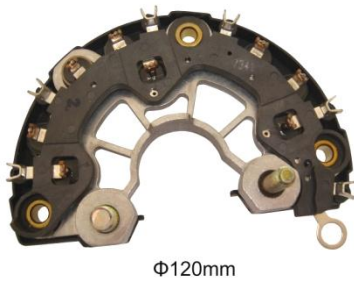

BHP12034 (Y)

FEATURES

Diodes: 8-50A Avalanche
 Diameter OD: 120mm
 With M8×22mm Battery Post(L)
 With M6×35mm Battery Post(R)

Original & X-References..

BHP12052 (Y)

Diodes: 6-50A Avalanche
 With big insulator hole

TRANSPO IBR234



BHP12035HD (Δ)

FEATURES

Diodes: 6-60Ampere
 Diameter OD: 120mm
 With M8×59.5mm Battery Post(L)
 With M8×22mm Battery Post(R)

Original & X-References..



BHP12036B (Δ)

FEATURES

Diodes: 6-35A Avalanche
 Diameter OD: 120mm
 With M8×34.5mm Battery Post(L)
 With M8×22mm Battery Post(R)
 For 24V Alternators

Original & X-References..

BHP12036BHD (Δ)

Diodes: 6-50A Avalanche



BHP12037 (Δ)

FEATURES

Diodes: 6-50A Avalanche
 Diameter OD: 129mm
 With M8×22mm Battery Post(L)
 With M8×38mm Battery Post(R)
 With 129 mm Negative heat sink

Original & X-References..

BHP12040 (Δ)

Diodes: 6-50A Avalanche
 With M8×22mm Battery Post(L)
 With M8×34.5mm Battery Post(R)



BHP12038B (Δ)

FEATURES

Diodes: 6-50A Avalanche
 Diameter OD: 120mm
 With M8×34.5mm Battery Post(L)
 With M8×38mm Battery Post(R)
 For 24V Alternators

Original & X-References..

BHP12039B (Δ)

Diodes: 6-50A Avalanche
 With M8×34.5mm Battery Post(L)
 With M8×34.5mm Battery Post(R)

BOSCH F00M 133223
 TRANSPO IBR223



Φ120mm

BHP12041 (△)

FEATURES

Diodes: 6-50A Avalanche
 Diameter OD: 120mm
 With M8×38mm Battery Post(L)
 With M8×22mm Battery Post(R)
BHP12077 (Y)
 With M8×22mm Battery Post(L)
 With M8×32mm Battery Post(R)

Original & X-References..

TRANSPO IBR225



Φ120mm

BHP12042 (△)

FEATURES

Diodes: 6-50A Avalanche
 Diameter OD: 120mm
 With M8×32mm Battery Post(L)
 With M8×22mm Battery Post(R)

Original & X-References..



Φ120mm

BHP12043 (Y)

FEATURES

Diodes: 8-50A Avalanche
 Diameter OD: 120mm
 With M8×32mm Battery Post(L)
 With M8×22mm Battery Post(R)
BHP12075 (Y)
 Diodes:8-50A Avalanche
 With M8×32mm Battery Post(L)
 With M8×32mm Battery Post(R)

Original & X-References..



Φ129mm

BHP12044HD (△)

FEATURES

Diodes: 6-50A Avalanche
 Diameter OD: 129mm
 With M8×22mm Battery Post(L)
 With M8×50mm Battery Post(R)
 With 129 mm Negative heat sink
BHP12046HD (△)
 Diodes: 6-50A Avalanche
 With M8×22mm Battery Post(L)
 With M6×51mm Battery Post(R)

Original & X-References..

BOSCH F00M 133226
 TRANSPO IBR226

 BOSCH F00M 133277
 TRANSPO IBR277



Φ129mm

BHP12051HD (△)

FEATURES

Diodes: 6-50A Avalanche
 Diameter OD: 129mm
 With M8×26mm Battery Post(L)
 With M8×50mm Battery Post(R)
 With 129 mm Negative heat sink

Original & X-References..



BHP12053 (△)

FEATURES

Diodes: 6-50A Avalanche
 Diameter OD: 129mm
 With M8×22mm Battery Post(L)
 With M8×32mm Battery Post(R)
 With 129 mm Negative heat sink

Original & X-References..

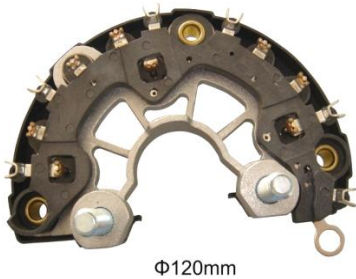

BHP12055 (Y)

FEATURES

Diodes: 8-50A Avalanche
 Diameter OD: 120mm
 With M8×32mm Battery Post(L)
 With M8×32mm Battery Post(R)

Original & X-References..

BHP12066 (Y)

Diodes:6-50A Avalanche



BHP12056 (△)

FEATURES

Diodes: 6-50A Avalanche
 Diameter OD: 129mm
 With M8×34.5mm Battery Post(L)
 With M8×22mm Battery Post(R)
 With 129 mm Negative heat sink
BHP12054HD 6-50A Avalanche
 With M8×34.5mm Battery Post(L)
 With M8×34.5mm Battery Post(R)

Original & X-References..

BOSCH	F00M 133237
TRANSPO	IBR237



BHP12057 (△)

FEATURES

Diodes: 6-50Ampere
 Diameter OD: 120mm
 With M8×26mm Battery Post(L)
 With M8×22mm Battery Post(R)

Original & X-References..



BHP12059 (Y)

FEATURES

Diodes: 8-50A Avalanche
 Diameter OD: 120mm
 With M8×26mm Battery Post(L)
 With M8×34.5mm Battery Post(R)

Original & X-References..

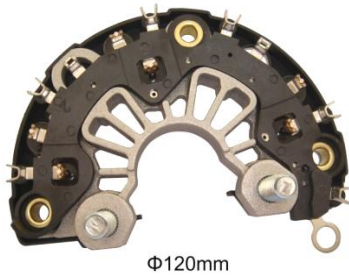

BHP12062 (Y)

FEATURES

Diodes: 6-50A Avalanche
 Diameter OD: 120mm
 With M8×32mm Battery Post(L)
 With M8×32mm Battery Post(R)

Original & X-References..

BHP12060B

Diodes:8-35A Avalanche
 For 24V Alternators



BHP12063 (Y)

FEATURES

Diodes: 8-50A Avalanche
 Diameter OD: 120mm
 With M8×22mm Battery Post(L)
 With M8×38mm Battery Post(R)

Original & X-References..

BHP120103

With M8×26mm Battery Post(L)
 With M8×22mm Battery Post(R)



BHP12064HD (Δ)

FEATURES

Diodes: 6-50A Avalanche
 Diameter OD: 129mm
 With M6×47mm Battery Post(L)
 With M8×47mm Battery Post(R)
 With 129 mm negative heat sink

Original & X-References..

BOSCH	F00M 133279
TRANSPO	IBR279

BHP12064B (Δ)

Diodes: 6-50A Avalanche
 For 24V Alternators

FIT REGULATOR	IB260
FIT COVER	C-006



BHP12065HD (Δ)

FEATURES

Diodes: 6-50A Avalanche
 Diameter OD: 120mm
 With M8×34.5mm Battery Post(L)
 With M8×34.5mm Battery Post(R)

Original & X-References..



BHP12070 (Y)

FEATURES

Diodes: 6-50A Avalanche
 Diameter OD: 120mm
 With M8×22mm Battery Post(L)
 With M8×32mm Battery Post(R)

Original & X-References..

BOSCH	F00M 123227
	F00M 123244
	F00M 123201
TRANSPO	IBR244



BHP12072 (Δ)

FEATURES

Diodes: 6-50A Avalanche
 Diameter OD: 129mm
 With M8×26mm Battery Post(L)
 With M8×34.5mm Battery Post(R)
 With 129 mm Negative heat sink

Original & X-References..

BOSCH F00M 133265



BHP12073 (Δ)

FEATURES

Diodes: 6-50A Avalanche
 Diameter OD: 129mm
 With M8×22mm Battery Post(L)
 With M8×32mm Battery Post(R)
 With 129 mm Negative heat sink

Original & X-References..

BOSCH F00M 123215
 F00M 133218
 F00M 133247
 TRANSPO IBR215

BHP12073HD (Δ)

Diodes: 6-70A Avalanche



BHP12074 (Δ)

FEATURES

Diodes: 6-50A Avalanche
 Diameter OD: 129mm
 With M8×28.5mm Battery Post(L)
 With M8×26mm Battery Post(R)
 With 129 mm Negative heat sink

Original & X-References..



BHP12076 (Δ)

FEATURES

Diodes: 6-50A Avalanche
 Diameter OD: 129mm
 With M8×26mm Battery Post(L)
 With M8×26mm Battery Post(R)
 With 129 mm Negative heat sink

Original & X-References..

BOSCH F00M 133208
 TRANSPO IBR266



BHP12080HD (Δ)

FEATURES

Diodes: 6-50A Avalanche
 Diameter OD: 129mm
 With M8×38mm Battery Post(L)
 With M8×22mm Battery Post(R)
 With 129 mm Negative heat sink

Original & X-References..

BOSCH F00M 133274
 F00M 133292
 TRANSPO IBR274



BHP12081A (Δ)

FEATURES

Diodes:6-50A Avalanche
 Diameter OD: 120mm
 With M8×32mm Battery Post(L)
 With M8×32mm Battery Post(R)

Original & X-References..

BOSCH F00M 133209



BHP12083HD (Δ)

FEATURES

Diodes: 6-50A Avalanche
 Diameter OD: 120mm
 With M6×35mm Battery Post(L)
 With M6×35mm Battery Post(R)

Original & X-References..



BHP12086 (Y)

FEATURES

Diodes : 6-50 Avalanche
 Diameter OD: 120mm
 With M8×22mm Battery Post (L)
 With M8×34.5mm Battery Post (R)

Original & X-References..

BOSCH F00M 144002



BHP12094 (Δ)

FEATURES

Diodes: 6-50A Avalanche
 Diameter OD: 129mm
 With M8×32mm Battery Post(L)
 With 129 mm Negative heat sink

Original & X-References..

BOSCH F00M 133298
 TRANSPO IBR212



BHP12095 (Y)

FEATURES

Diodes: 8-50A Avalanche
 Diameter OD: 120mm
 With M8×26mm Battery Post(L)
 With M8×26mm Battery Post(R)

Original & X-References..



BHP12099 (Y)

FEATURES	Original & X-References..
Diodes : 8-50A Avalanche	
Diameter OD:120mm	
With M8×22mm Battery Post (L)	
With M8×34.5mm Battery Post (R)	



BHP120100 (Y)

FEATURES	Original & X-References..
Diodes : 6-50A Avalanche	
Diameter OD:120mm	
With M8×32mm Battery Post (L)	
With M8×22mm Battery Post (R)	
BHP120133A (Y)	BOSCH 0124325064
With M6×35mm Battery Post(L)	MOBILETRON RB-161H
With M8×22mm Battery Post(R)	



BHP120101B (△)

FEATURES	Original & X-References..
Diodes : 6-50A Avalanche	
Diameter OD:120mm	
With M8×26mm Battery Post (L)	
With M8×26mm Battery Post (R)	
For 24V Alternators	



BHP120120B (△)

FEATURES	Original & X-References..
Diodes: 6-50A Avalanche	
Diameter OD: 129mm	
With M8×34.5mm Battery Post(L)	
With M8×38mm Battery Post(R)	
For 24V Alternators	



BHP120135A (Y)

FEATURES	Original & X-References..
Diodes: 6-50A Avalanche	BOSCH 0124325067
Diameter OD: 120mm	
With M8×32mm Battery Post(L)	
With M8×22mm Battery Post(R)	



BHP120136A (Δ)

FEATURES

Original & X-References..

Diodes: 6-60A Avalanche
 Diameter OD: 129mm
 With M8×34.5mm Battery Post (L)
 With M8×22mm Battery Post (R)
 With 129mm Negative heat sink



BHP120137A (Δ)

FEATURES

Original & X-References..

Diodes: 6-50A Avalanche
 Diameter OD: 120mm
 With M8×22mm Battery Post (L)
 With M8×34.5mm Battery Post (R)

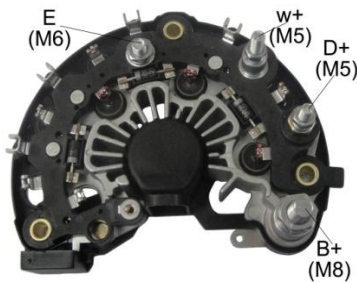

BHP120104HD

FEATURES

Original & X-References..

Diodes : 6-60AAvalanche
 With M8×40mm Battery Post
 With M6×32.5mm Ground Post
 With M5 W-Post
 With Trio
 With Capacitor

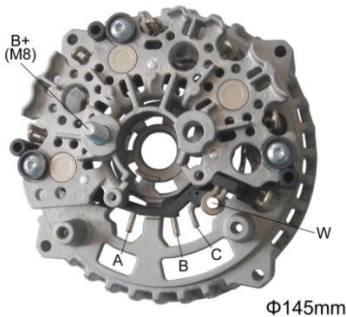

BHP12801

FEATURES

Original & X-References..

Diodes: 6-50A Avalanche
 Diameter OD: 145mm
 With M8×32mm Battery Post
 With "W" Terminal

BOSCH F00M 314001
 0121615003

Customer provide Negative heat sink



BHP12804

FEATURES

Original & X-References..

Diodes: 6-60A Avalanche (ACTRON)
 With M8×15.5mm Battery Post

Customer provide Negative heat sink



BHP12805

FEATURES

Diodes: 6-60A Avalanche (ACTRON)
 With M8×32mm Battery Post

Original & X-References..

Customer provide Negative heat sink



BHP12806

FEATURES

Diodes: 6-60A Avalanche (ACTRON)
 With M8×15.5mm Battery Post

Original & X-References..

Customer provide Negative heat sink



BHP12807

FEATURES

Diodes: 6-60A Avalanche
 With M8×15.5mm Battery Post

Original & X-References..

BOSCH F00M 314004

Customer provide Negative heat sink



BHP12811

FEATURES

Diodes:6-50A Avalanche
 With M8×32mm Battery Post

Original & X-References..

Customer provide Negative heat sink



BHP12815A

FEATURES

Diodes: 6-60A Avalanche
 Diameter OD: 128mm
 With M8×23.5mm Battery Post

Original & X-References..

BOSCH F00M346135



DC5164

FEATURES

Diodes: 6-35A Avalanche Press-Fit
With Aluminum Heat sinks

For: CS121,CS130 Alternators

DC5163

Diodes: 6-50A Avalanche Press-Fit

Original & X-References..

DELCO	10457236	10472597
	10470730	10457690
	1989658	
WAI	31-113-1	31-136
CARGO		131880
TRANSPO		DR4000HD



DC5302

Diodes: 6-35A Avalanche Press-Fit
With Aluminum Heat sinks

For: CS121,CS130 Alternators

DC5301

Diodes: 6-50A Avalanche Press-Fit



DC5164D

FEATURES

Diodes: 6-35A Avalanche Press-Fit
With M8×46mm Battery Post
With Aluminum Heat sinks
For use on: GM-Vehicles

DC5163D

Diodes: 6-50A Avalanche Press-Fit

Original & X-References..

DELCO		10475758
		10492837
		1047578
WAI		31-120
		31-133
		31-133-1
CARGO		135337
TRANSPO		DR4200HD



DC5302D

Diodes: 6-35A Avalanche Press-Fit
With M8×46mm Battery Post
With Aluminum Heat sinks

For use on: GM-Vehicles

DC5301D

Diodes: 6-50A Avalanche Press-Fit



DC5164-2D

FEATURES

Diodes: 6-35A Avalanche Press-Fit
With M8×48mm Battery Post
With Aluminum Heat sinks

Original & X-References..



DC5263D

FEATURES

Diodes: 6-50A Avalanche
 With (M8+M6) ×46mm Battery Post

Original & X-References..

DELCO	10480228
TRANSPO	DR4220

For use on: Acura CL 3.0L Honda
 Accord 3.0L



DC5300

FEATURES

Diodes: 6-50A Avalanche

 For use on: WAI 1998-2000 Saturn
 31-213 SC1,SLSedan,SWWagon 1.9L

Original & X-References..

DELCO	10492300
WAI	31-123
CARGO	232070
MOBILETRON	RD-25A
TRANSPO	DR1200



DC5304

FEATURES

Diodes: 6-50A Avalanche
 With Trio

Original & X-References..



DCE5170

FEATURES

Diodes: 6-35A Avalanche
 With M8 ×47.3mm Battery post installed
 With Aluminum Heat sinks
 With Trio
 For use on: Opel Corsa, Omega, Vectra,
 Astra, Fontera, Tigra

Original & X-References..

DCE5173 6-50A Avalanche
DCE5171 6-50A Avalanche
 With Copper Negative Heat sink

DELCO	10475034
	1205464
	589714
WAI	31-131
CARGO	136595
MOBILETRON	RD-04B
TRANSPO	DER2000
	DER2000V



DCE5177

FEATURES

Diodes: 6-50A Avalanche
 With M8 ×46mm Battery Post Installed
 With Aluminum Heat sinks
 For use on: Opel Corsa, Omega, Vectra,
 Astra, Fontera, Tigra

Original & X-References..

DCE5175
 Diodes: 6-50A Avalanche
 With Copper Negative Heat sink

DELCO	10493596	3472020
	3472820	3478687
CARGO		231797
TRANSPO		DER2010
DELCO		10493596



DCE5179

FEATURES	Original & X-References..	
Diodes: 6-50A Avalanche	DELCO	10475034
With M8×46mm Battery Post Installed		1205464
With Aluminum Heat sinks		589714
With Trio	WAI	31-131
DCE5178	CARGO	136595
Diodes: 6-50A Avalanche	MOBILETRON	RD-04B
With Copper Negative Heat sink	TRANSP0	DER2000
		DER2000V

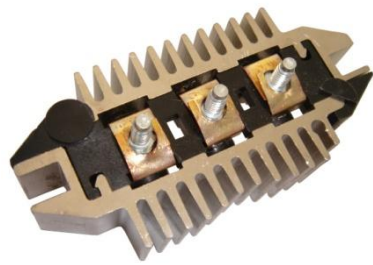

DCE1003

FEATURES	Original & X-References..	
Diodes: 6-25 Ampere Button	DELCO	3472813
	WAI	31-130-1
		31-130
For use on: Opel , Vauxhall	CARGO	131458
	TRANSP0	DER1003
	DELCO	3493008
DCE1004	WAI	31-129
Diodes: 6-35 Ampere Button	CARGO	132931
	TRANSP0	DER1004



DC5070

FEATURES	Original & X-References..		
Diodes: 6-25 Ampere Button	DELCO	1975313	1985313
		D3919	D3913
For use on: GM Vehicles	WAI		31-104
	CARGO		131875
	MOBILETRON		RD-14
	TRANSP0		DR5070

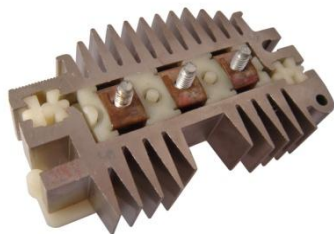

DC5072

FEATURES	Original & X-References..		
Diodes: 6-50 Ampere Button	DELCO	1975313	1985313
For use on: GM Vehicles		D3919	D3913
	WAI		31-104-1
DC5075	MOBILETRON		RD-14
Diodes: 6-50 Ampere Button	TRANSP0		DR5072
NOTE: Positive Ground Version of DC5072	TRANSP0		DR5075

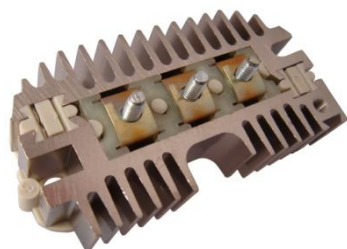

DC5185

FEATURES	Original & X-References..		
Diodes: 6-25 Ampere Button	DELCO	1852209	1875627
For use on: GM Vehicles		1891055	1984638
	WAI	31-101	31-101-3
DC5185HD	MOBILETRON		RD-09
Diodes: 6-50 Ampere Button	TRANSP0	DR5040	DR5042
DC5185-1			
Diodes: 6-25 Ampere Button			
NOTE: Positive Ground Version of DC5185	TRANSP0	DR5045	



DC5170

FEATURES

Diodes: 6-25 Ampere Button
 For 17SI 97-108A Alternators
 For use on: GM Vehicles, Cadillac

Original & X-References..

DELCO	1985801
	D3985
TRANSP0	DR5170

DC5172

Diodes: 6-50 Ampere Button



DC5190

FEATURES

Diodes: 6-25 Ampere Button
 For 56-78A Alternators
 For use on: GM Vehicles, Agricultural,
 Industrial

Original & X-References..

DELCO	1984454
	D3924
WAI	31-102
CARGO	131873
MOBILETRON	RD-12

DC5191

Diodes: 6-50 Ampere Button

TRANSP0	DR5050
TRANSP0	DR5052

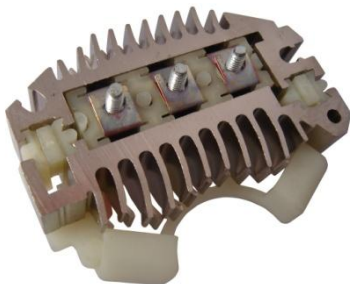

DC5192

FEATURES

Diodes: 6-50 Ampere Button
 With Bi-Directional Heatsinks

 For use on: GM Vehicles, Jeep

Original & X-References..

DELCO	1987061
	D3986
WAI	31-103
CARGO	131874
MOBILETRON	RD-13HV

DC5193

Diodes: 6-70 Ampere Button

TRANSP0	DR5054
TRANSP0	DR5056

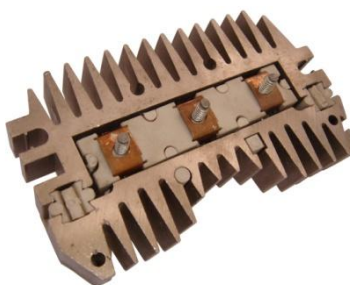

DC5184

FEATURES

Diodes: 6-25 Ampere Button
 For use on: GM Passenger Car, Heavy
 Truck

Original & X-References..

DELCO	1875645	1892914
WAI	31-109	31-109-1
CARGO		30555
MOBILETRON	RD-17	RD-17H
TRANSP0	DR5080	DR5082
TRANSP0	DR5085	

DC5184-1 6-35 Ampere Button

DC5184HD

Diodes: 6-50 Ampere Button
DC5085 6-50 Ampere Button

NOTE: Positive Ground Version of
DC5184HD



DC5180

FEATURES

Diodes: 3-50A Avalanche
 3-50A Ampere Button
 With Late Saw-Fin Design
 For use on: GM P Series Step-up Van,
 Chevy Corvette, Buick Regal, Cadillac,
 Chevy Blazer, CK-Series Trucks, GMC
 Suburvan

Original & X-References..

DELCO	10467052
	D3990
	1989774
WAI	31-115
CARGO	131881
TRANSP0	DR5176



DC5181

FEATURES

Diodes: 6-50A Avalanche Button
With Late Saw-Fin Design

For use on: GM Truck B6 Series,
B7 Series, P6 Series, Kodiak

DC5181B

Diodes: 6-50A Avalanche
For 24V Alternators

Original & X-References..

DELCO	10470609
	D3992
WAI	31-116
CARGO	231062
MOBILETRON	RD-06A
TRANSPO	DR5177



DC5181AP

FEATURES

Diodes: 6-50A Avalanche Press fit
For use on: GM Truck B6 Series,
B7 Series, P6 Series, Kodiak

DC5181AHDP 6-60A Avalanche

DC5181BP 6-50A Avalanche

DC5181BHDP

Diodes: 6-60A Avalanche
For 24V Alternators

Original & X-References..

DELCO	10470609
	D3992
WAI	31-116
CARGO	231062
MOBILETRON	RD-06A
TRANSPO	DR5177PF

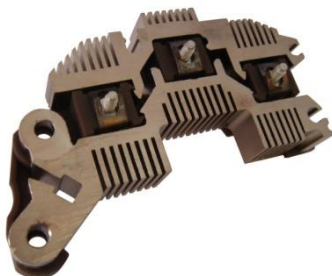

DC5182

FEATURES

Diodes: 6-50A Jumbo Avalanche Button
With Recessed Mounting Hole

For 140A Alternators

For use on: Buick Riviera, Roadmaster,
Olds Toronado, Chevy Truck, Cadillac
Commercial, Fleetwood Brougham,
Chevy Camaro, Impala, Lumina,
Pontiac, Firebird

Original & X-References..

DELCO	10475800
WAI	31-118
CARGO	232068
MOBILETRON	RD-07
TRANSPO	DR5178



DC5183

FEATURES

Diodes: 6-50A Jumbo Avalanche Button
For 124-140A Alternators

See **DC5182** for Recessed Mtg.Hole

For use on: Cadillac Deville, Eldorado,
Seville

Original & X-References..

DELCO	10472095
WAI	31-117
CARGO	232069
MOBILETRON	RD-08
TRANSPO	DR5179



DC5187

FEATURES

Diodes: 6-50 Ampere Button
For use on: Navistar, Cummings
Engine, Detroit Diesel Engine, Ford
Truck B, F Series, Mack, Volvo

DC5188 6-50A Avlananche

For 12V Alternators

DC5188B 6-50A Avlananche

For 24V Alternators

DC5189 3-50 Ampere Button
3-50A Jumbo Avlananche Button

Original & X-References..

DELCO	1988976
	D3987
WAI	31-106
CARGO	131877
MOBILETRON	RD-05
TRANSPO	DR5173
TRANSPO	DR5175



DC5187P

FEATURES	Original & X-References..	
Diodes: 6-50Ampere press fit diodes	DELCO	1988976
		D3987
	WAI	31-106
	CARGO	131877
	MOBILETRON	RD-05
	TRANSPO	DR5173PF



DC5281P

FEATURES	Original & X-References..	
Diodes: 6-60A Avalanche press fit diodes	DELCO	35SI
		2371,10512371
	TRANSPO	DR5186

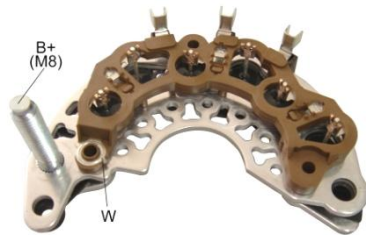

DC1101

FEATURES	Original & X-References..	
Diodes: 6-35A Avalanche With M8×47.5mm Battery Post Without Trio For 11SI Alternators	TRANSPO	DR2910
	DC1105	
	Diodes: 6-35A Avalanche With M6×21mm Battery Post Without Trio	

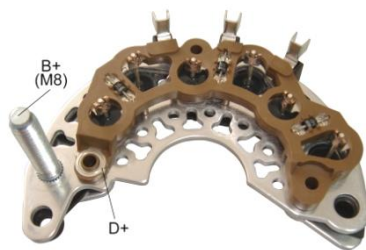

DC1102

FEATURES	Original & X-References..	
Diodes: 6-35A Avalanche With M8×47.5mm Battery Post With Trio	TRANSPO	DR2295
	For 7SI Alternators	



DC1122A

FEATURES	Original & X-References..	
Diodes: 6-50A Avalanche With M8×47.5mm Battery Post With Trio		

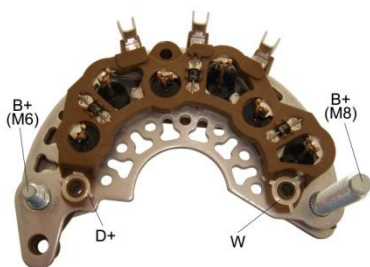

DC1103

FEATURES

Diodes: 6-35A Avalanche
 With M8×47.5mm Battery Post
 With M6×21mm Battery Post
 With Trio

Original & X-References..

TRANSPO DR2206

For 11SI Alternators



DC1124A

FEATURES

Diodes: 6-50A Avalanche
 With M8×28.5mm Battery Post(L)
 With M8×35mm Battery Post(R)

Original & X-References..

Customer provide Negative heat sink



DC1670 (Positive)

FEATURES

Diodes: 3-35 Ampere
 For use on: Heavy Duty Truck,
 Industrial

Original & X-References..

WAI 31-108
 CARGO 131879
 TRANSPO DR1670



DC1867 (Negative)

FEATURES

Diodes: 3-35 Ampere
 For use on: Heavy Duty Truck,
 Industrial

Original & X-References..

WAI 31-107
 CARGO 131876
 TRANSPO DR1867



DC4100

FEATURES

Diodes: 6-35A Avalanche
 With M8 Battery Post
 With Trio
 For use on:1999-00 Daewoo
 Leganza2.2L w/Delphi

Original & X-References..

DELCO 96206871
 CARGO 234307
 TRANSPO DR6871

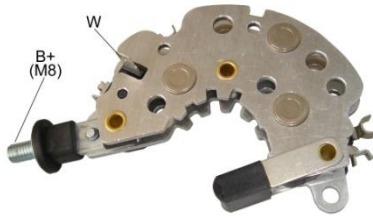

DC4108

FEATURES

Diodes: 6-60A Avalanche
 With M8 Battery Post
 With Trio

Original & X-References..

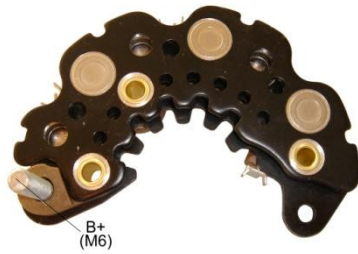

DC9410

FEATURES

Diodes: 6-50A Avalanche
 With M6×38mm Battery Post
 With Trio

Original & X-References..

DELCO	0601-0003
19020601	19020612
CARGO	235139
TRANSPO	DR9410

For use on:2000-UP Mercury w/GM V8

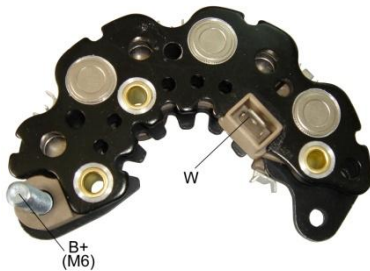

DC9411

FEATURES

Diodes: 6-50A Avalanche
 With M6×38mm Battery Post
 With Trio
 With P-Terminal
 For use on: Crusader Marine , Hyster ,
 Indmar Marine , Mercury Marine

Original & X-References..

TRANSPO	DR9411
---------	--------

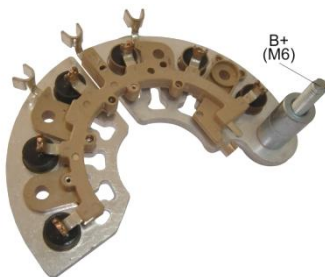

DC6100

FEATURES

Diodes: 6-50A Avalanche
 With M6×53.5mm Battery Post
 For use on: Chevrolet, GMC

Original & X-References..

WAI	31-135
MOBILETRON	RD-26
TRANSPO	DR4400

DC6100HD

Diodes: 6-60A Avalanche

TRANSPO	DR4400HD-1
---------	------------

DC6101

Diodes: 6-35A Avalanche

DC6102 6-50A Avalanche

With M8×53.5mm Battery Post 31-134

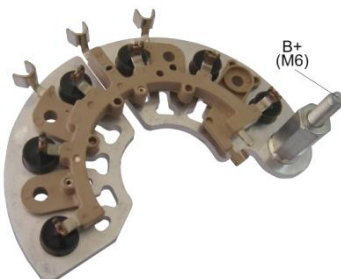

DC6103

FEATURES

Diodes: 6-50A Avalanche
 With M6×53mm Battery Post

Original & X-References..

DELCO	10494503
-------	----------

DC6103HD

Diodes: 6-60A Avalanche



DC6104

FEATURES

Diodes: 6-50A Avalanche
With 5/16" x45mm Battery Post

Original & X-References..

DELCO	10502870
REC	DR24SI
TRANSPO	DR2400

DC6104B

FOR 24V ALTERNATOR

TRANSPO	DR2402
---------	--------

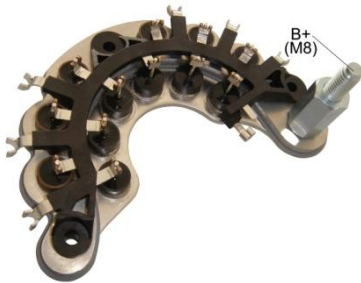

DC6106

FEATURES

Diodes: 12-50A Avalanche
With M8 x52.5mm Battery Post

For Mercedes Water Cooling Alternator

Original & X-References..

ALTERNATOR NO:

MERCEDES	001500850
DELPHI	10480403
CARGO	CA 16771R



DC6109A

FEATURES

Diodes: 6-60A Avalanche
With M6 x46.5 Battery Post

Original & X-References..

TRANSPO	DR3580
---------	--------



DC6111A

FEATURES

Diodes: 6-60A Avalanche
With M8 x49mm Battery Post

Original & X-References..

DELCO	8400219
	8400218



DC6112A

FEATURES

Diodes: 6-60A Avalanche
With M8 x49mm Battery Post

Original & X-References..



FD1001

FEATURES

Diodes: 6-25 Ampere Button
 For 40-65A Alternators
 Aluminum Heat Sinks with Cooling
 Slots Fine Thread Studs
 Unique Copper Insert Design
 For use on :Ford, Mercury, Light Trucks

Original & X-References..

FORD	D6AZ10304A
	GY-1327
	D9VY-10304-A
WAI	31-200-12
CARGO	131421
MOBILETRON	RF-08H
TRANSPO	FR1070



FD1002

FEATURES

Diodes: 6-35 Ampere Press-Fit
 For 40-65A Alternators
 Aluminum Heat Sinks
 Fine Thread Studs
 For use on: Ford, Mercury, Light Truck

Original & X-References..

FORD	GY-1327
	GY-1306A
	D6AZ10304A
WAI	31-200-12
CARGO	131421
MOBILETRON	RF-08H
TRANSPO	FR1040
TRANSPO	FR1046

FD1002HD

Diodes: 6-50Ampere



FD1004

FEATURES

Diodes: 6-25 Ampere Button
 For 40-65A Alternators
 Aluminum Heat Sinks with Cooling
 Slots Fine Thread Studs
 High Temp Circuit Board
 For use on :Ford, Mercury, Light Trucks

Original & X-References..

FORD	GY1306A
WAI	31-200
	31-200-4
MOBILETRON	RF-07H
CARGO	130517
TRANSPO	FR1080

FD1004HD

Diodes: 6-50Ampere



FD1005

FEATURES

Diodes: 6-35 Ampere Press-Fit
 For 70-100A Alternators
 Aluminum Heat Sinks
 OE-Type High Temp Circuit Board
 For use on: For Passenger Car, Light Truck

Original & X-References..

FORD	GY-1026
	D2OZ10304A
WAI	31-201
	31-202
CARGO	131422
MOBILETRON	RF-09H
TRANSPO	FR1270

FD1005HD 6-50Ampere



FD1007

FEATURES

Diodes: 6-50 Ampere Press-Fit
 For 70-100A Alternators
 Copper Heat Sinks
 OE-Type High Temp Circuit Board
 For use on: Ford Passenger Car, Light Truck

Original & X-References..

FORD	
E9DZ10304A	GY-1345-A
F0HZ-10304A	GY-1302-B
WAI	31-202
CARGO	131430
MOBILETRON	RF-16HV
TRANSPO	FR1290



FD2001

FEATURES

Diodes: 6-35 Ampere
 Nickel Plated Brass Terminals
 Hi-Temp BBS Receptacle
 Thermally Conductive Encapsulation
 For 40-65A Application
 For use on: Ford, Mercury, Light Truck

FD2001HD

Diodes: 6-50Ampere

Original & X-References..

FORD	E6DZ10304
	E6DZ10304A
WAI	31-206 31-203-3
CARGO	131882 137048
MOBILETRON	RF-02
TRANSPO	FR192PF
WAI	31-206-1 31-206-2
TRANSPO	FR192PXD

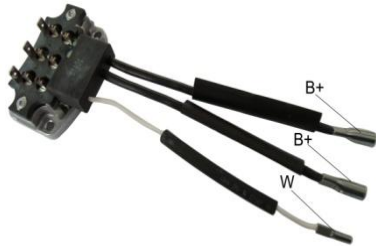

FD2004

FEATURES

Diodes : 6-50A Ampere
 Crimp-weld diode terminations

For 40-80A Application
 For use on: Ford, Mercury, Light Truck

Original & X-References..

TRANSPO	FR192BBS
---------	----------



FD3001DW

FEATURES

Diodes: 8-35 Ampere
 Diameter OD: 133mm
 Drop-down Stator Terminals

For use on: Ford Passenger Car, Light Truck

Original & X-References..

FORD	F5A2-10304BA
WAI	31-207-1
CARGO	136209
TRANSPO	FR2013



FD3002DW

FEATURES

Diodes: 8-50 Ampere
 Diameter OD: 146mm
 Drop-down Stator Terminals

For use on: Ford Passenger Car, Light Truck

Original & X-References..

WAI	31-208
	31-208-1
CARGO	136210
MOBILETRON	RF-053
TRANSPO	FR2023



FD4001DW

FEATURES

Diodes: 8-60 Ampere
 Diameter OD: 133mm
 OE-Style Leadframe
 For 130A Applications

For use on: Ford Lincoln, Mercury

Original & X-References..

SAS COMPONENTS	10210
FORD	F6LU-10300CA
	F5OZ-10300FA
	F6OU-10300AA
	F6ZU-10300BB
F6DU-10300BB	
WAI	31-210
CARGO	139668
MOBILETRON	RF-06
TRANSPO	FR3003



FD6000DW

FEATURES

Diodes: 8-35 Ampere
 Diameter OD: 136mm
 Drop-down Stator Terminals

For use on: 1998-2004 Ford Series,
 Excursion, F series Dickup, Focus,
 Mustang, Windstar.

Original & X-References..

FORD	F8 WV10A 366 AAZP
WAI	31-213
CARGO	230842
TRANSPO	FR6003



FD6001DW

FEATURES

Diodes: 8-35 Ampere
 Diameter OD: 136mm
 Drop-down Stator Terminals

For use on: 1998-2003 Ford Contor,
 Focus, Mercury, Cougar, Mystique 2.0L

Original & X-References..

WAI	31-216
CARGO	233208
MOBILETRON	RF-113
TRANSPO	FR6013



FD6002DW

FEATURES

Diodes: 8-50 Ampere
 Diameter OD: 149mm
 Drop-down Stator Terminals For
 Improved Stator-Wire Attachment
 For use on: 1998-2003 Ford, Lincoln,
 Mercurry.

Original & X-References..

FORD	F8AU-10A366AIP
WAI	31-212-1 31-212
MOBILETRON	RF-12
CARGO	230870
TRANSPO	FR6023



FD6011DW

FEATURES

Diodes: 6-35 Ampere
 Diameter OD: 136mm
 Drop-down Stator Terminals For
 Improved Stator-Wire Attachment

Original & X-References..

WAI	31-218-1 31-217
CARGO	233207
MOBILETRON	RF-133
TRANSPO	FR6073



FD6012DW

FEATURES

Diodes: 6-35 Ampere
 Diameter OD: 136mm
 Drop-down Stator Terminals For
 Improved Stator-Wire Attachment
 For use on:
 2001-2003 Ford Escape 2.0L
 2001-2003 Mazda Tribute 2.0L

Original & X-References..

FORD	1L8Z-10346AB 1125500588
WAI	31-219-1
CARGO	233210
MOBILETRON	RF-153
TRANSPO	FR6083



FD61001A

FEATURES

Diodes: 8-50A Avalanche
 Diameter OD: 114mm
 With M6×16.4mm Battery Post

Original & X-References..

MOBLETRON	RF-18HV
CARGO	235019
TRANSPO	FR6102



FD61002A

FEATURES

Diodes: 8-50A Avalanche
 Diameter OD: 114mm
 With M6×39mm Battery Post

Original & X-References..

FORD INDIA	
MOBILETRON	RF-19H
VALEO	3N2110300BB
TRANSPO	FR6100



FD61003A

FEATURES

Diodes:8-50A Avalanche
 Diameter OD:105mm
 With M6×39mm Battery Post

Original & X-References..

TRANSPO	FR6104
---------	--------

For Ford/Visteon RC28 European 104A alternator
 Used On: Ford Fiesta, Ka(Europe)



FD61004A

FEATURES

Diodes:8-50A Avalanche
 Diameter OD:105mm
 With M6×16.4mm Battery Post
 For Ford/Visteon RC28 European 110A

Original & X-References..

TRANSPO	FR6106
---------	--------

HIF5001



FEATURES

Diodes: 6-25 Ampere Button
With M5×32.6mm Mounting Bolt

For use on: Nissan, Isuzu, Subaru,
Yanmar, Nissan Forklifts

Original & X-References..

HITACHI	
L125-6320	L125-8320
L140-6320	L140-7320
L160-13201	L140-9320
WAI	31-8100-3
CARGO	130618
MOBILETRON	RH-49
TRANSP0	IHR1000
	IHR1000HD

HIF5002



FEATURES

Diodes: 6-35 Ampere
With M5×32.6mm Mounting Bolt

For use on: Nissan, Isuzu, Subaru,
Yanmar, Nissan Forklifts

Original & X-References..

MOBILETRON	RH-49C
TRANSP0	IHR1000HD

The Same as **HIF5001**
Except Using TIN-CAN Diode

HIF5003



FEATURES

Diodes: 6-25 Ampere Button
With M5×36mm Mounting Bolt
With Trio

For use on: Nissan, Isuzu, Subaru

Original & X-References..

HITACHI	L135-N13201	
	L150-N13202	
WAI	31-8103	
CARGO	131549	131548
MOBILETRON	RH-51	
TRANSP0	IHR1001	

HIF5004



FEATURES

Diodes: 6-35 Ampere
With M5×36mm Mounting Bolt
With Trio

For use on: Nissan

Original & X-References..

LUCAS	21511112	UBJ105
WAI	31-8104	
CAGRO	134386	
MOBILETRON	RH-50	
TRANSP0	IHR1002	

HI10001F



FEATURES

Diodes: 6-35 Ampere
Diameter OD: 100mm
With M5×31mm Mounting Bolt
With Trio

HI10001Fg

Diodes: 6-35Ampere Dish
For use on: Nissan

Original & X-References..

HITACHI	L135-6320
WAI	31-8147
CARGO	135466
MOBILETRON	RH-19
TRANSP0	IHR733



HI10002F

FEATURES

Diodes: 6-35 Ampere Dish Diameter
 OD: 100mm
 With M5×43mm Battery Post
 With M5×31mm Mounting Bolt
 With Trio
HI10002Fg
 Diodes: 6-35Ampere Dish
 For use on: Industrial, Yanmar

Original & X-References..

HITACHI	L135-3320
	L135-332000
WAI	31-8135
CARGO	132406
MOBILETRON	RH-20
TRANSPO	IHR734



HI10003F

FEATURES

Diodes: 6-35 Ampere
 Diameter OD: 100mm
 With M5×31mm Mounting Bolt
HI10003Fg
 Diodes: 6-35Ampere Dish
 For use on: Isuzu Diesel, Mazda Diesel

Original & X-References..

HITACHI	L140-23201
CARGO	132410
MOBILETRON	RH-16
TRANSPO	IHR727



HI10004F

FEATURES

Diodes: 6-35 Ampere Dish
 Diameter OD: 100mm
 With M5×31mm Mounting Bolt
 With Trio
HI10004Fg
 Diodes: 6-35Ampere Dish
 For use on: Chevy Luv Diesel, Isuzu Pickup Diesel

Original & X-References..

HITACHI	L140-53201
WAI	31-8119
CARGO	135757
MOBILETRON	RH-17
TRANSPO	IHR728



HI10013FE

FEATURES

Diodes: 6-50 Ampere
 Diameter OD: 100mm
 With M6×44.4mm Battery Post
 With (M5+M4)×39.8mm Mounting Bolt
 With Trio
 For use on: Nissan 200SX, Nissan Sentra, Subaru

Original & X-References..

HITACHI	LR150-704
	L170-9320
WAI	31-8109
CARGO	132098
MOBILETRON	RH-39C
NISSAN	2310051S00
	23230-51500
TRANSPO	IHR719

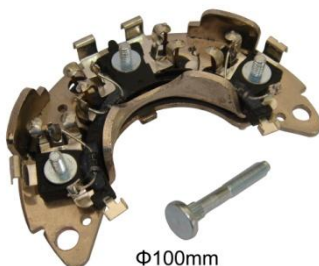

HI10014FE

FEATURES

Diodes: 8-50 Ampere
 Diameter OD: 100mm
 With M6×44.4mm Battery Post
 With (M5+M4)×39.8mm Mounting Bolt
 With Trio
 For use on: Subaru XT Coupe, Nissan Axxess
HI10015 8-35Ampere Dish

Original & X-References..

HITACHI	L165-6320
	L165-7320
	L170-7302
WAI	31-8114
CARGO	133377
MOBILETRON	RH-40C
NISSAN	2323077A00
TRANSPO	IHR720



HI11101F

FEATURES

Diodes: 6-35 Ampere
 Diameter OD: 111mm
 With M5×31mm Mounting Bolt
 With Trio
HI11101Fg
 Diodes: 6-35Ampere Dish
HI111016-35Ampere
 With Aluminum Heat sinks

Original & X-References..

HITACHI	L150-13204
WAI	31-8106
CARGO	131599
MOBILETRON	RH-02
TRANSPO	IHR604



HI11102F

FEATURES

Diodes: 6-35 Ampere
 Diameter OD: 111mm
 With M5×43mm Battery Post
 With M5×31mm Mounting Bolt
 With Trio
HI11102Fg
 Diodes: 6-35Ampere Dish

Original & X-References..

HITACHI	L150-13206
WAI	31-8107
CARGO	131600
MOBILETRON	RH-03
TRANSPO	IHR710
	IHR709
	IHR710HD



HI11103F

FEATURES

Diodes: 6-35 Ampere
 Diameter OD: 111mm
 With M5×31mm Mounting Bolt
HI11103Fg
 Diodes: 6-35Ampere Dish
 For use on: Industrial

Original & X-References..

HITACHI	L150-13205
WAI	31-8140
CARGO	131602
MOBILETRON	RH-06
TRANSPO	IHR711



HI11104F

FEATURES

Diodes: 6-35 Ampere
 Diameter OD: 111mm
 With M5×31mm Mounting Bolt
 With Trio
HI11104Fg
 Diodes: 6-35Ampere Dish
 For use on: Nissan Pick-up

Original & X-References..

HITACHI	L150-93201
---------	------------



HI11105F

FEATURES

Diodes: 6-35 Ampere Dish
 Diameter OD: 111mm
 With M5×43mm Battery Post
 With M5×31mm Mounting Bolt
HI11105Fg
 Diodes: 6-35Ampere Dish
 For use on: Subaru

Original & X-References..

HITACHI	L150-13202
WAI	31-8139
CARGO	132051
MOBILETRON	RH-09
TRANSPO	IHR715



HI11106F

FEATURES

Diodes: 6-35 Ampere
 Diameter OD: 111mm
 With M5×31mm Mounting Bolt
 With Trio
HI11106Fg
 Diodes: 6-35Ampere Dish
HI11106 6-35 Ampere
 With Aluminum Heat sinks

Original & X-References..

HITACHI	
L140-13202	L140-53202
L150-83201	L150-83202
WAI	31-8113
CARGO	131603
MOBILETRON	RH-04
TRANSPO	IHR723
	IHR723HD



HI11107F

FEATURES

Diodes: 6-35Ampere
 Diameter OD: 111mm
 With M5×39mm Mounting Bolt
 With Trio
HI11107Fg
 Diodes: 6-35Ampere Dish

Original & X-References..

HI11108F



FEATURES

Diodes: 6-35 Ampere dish
 Diameter OD: 111mm
 With M5×39mm Mounting Bolt
 With M5×31mm Mounting Bolt
HI11108Fg 6-35Ampere Dish
 For use on: IHC, Nissan Diesel, Isuzu Diesel

Original & X-References..

HITACHI	L150-M13201
	L150-M13202
	L155-M13202WAI
31-8111	
CARGO	131601
TRANSPO	IHR712
	IHR712HD



HI11116

FEATURES

Diodes: 6-35 Ampere Press Fit Diode
 Diameter OD: 111mm
 With M5×33.5mm Mounting Bolt
 With Trio
 With Aluminum Heat sinks

Original & X-References..

HITACHI	
L140-13202	L140-53202
L150-83201	L150-83202
WAI	31-8113
CARGO	131603
MOBILETRON	RH-04
TRANSPO	IHR723
	IHR723HD



HI11124F

FEATURES

Diodes: 6-35 Ampere
 Diameter OD: 111mm
 With M5×43mm Mounting Post
 With M5×23mm Mounting Bolt
 With Trio

Original & X-References..



HI11128F

FEATURES

Diodes: 6-35 Ampere
 Diameter OD: 111mm
 With M5×43mm Battery Bolt
 With M5×31mm Mounting Bolt

Original & X-References..



HI11129F

FEATURES

Diodes: 6-35 Ampere
 Diameter OD: 111mm
 With M5×39mm Mounting Bolt
 With Trio

Original & X-References..



HI11130F

FEATURES

Diodes: 6-35 Ampere
 Diameter OD: 111mm
 With M6×35.2mm Battery Post
 With M5×31mm Mounting Bolt
 With M5×43mm Battery Bolt
 With Trio

Original & X-References..

HI11139F

Diodes:6-35Ampere
 With M5×38mm Battery Bolt



HI11801F

FEATURES

Diodes: 6-35Ampere
 Diameter OD: 118mm
 With M5×43mm Battery Post
 With M5×31mm Mounting Bolt
 With Trio
 For use on: Nissan, Subaru DL/GL/RX Hatchback, Sedan & Wagon, Subaru Loyale

Original & X-References..

HITACHI	L150-13203
	L150-13230
	L160-3320
WAI	31-8105CARGO
131598	
MOBILETRON	RH-01
TRANSPO	IHR603
	IHR603HD



HI11802F

FEATURES

Diodes: 6-35 Ampere
 Diameter OD: 118mm
 With M5×31mm Mounting Bolt
 With Trio
 For use on: Isuzu & Nissan Diesel Applications, Maxima Diesel

Original & X-References..

HITACHI	L160-23201
WAI	31-8112
CARGO	132053
MOBILETRON	RH-14
TRANSPO	IHR607
	IHR607HD



HI11803F

FEATURES

Diodes: 6-35 Ampere
 Diameter OD: 118mm
 With M5×31mm Mounting Bolt
 With Trio
 For use on: Nissan with 70 Ampere
 Alternators, Isuzu NPR
HI11803
 Diodes: 6-35Ampere
 With Aluminum Heat sinks

Original & X-References..

HITACHI	L160-23202
WAI	31-8133
CARGO	135037
MOBILETRON	RH-15
TRANSPO	IHR721
	IHR721HD
HITACHI	L160-43202



HI11804F

FEATURES

Diodes: 6-35Ampere
 Diameter OD: 118mm
 With M5×31mm Mounting Bolt
 With Trio
 The Same As **HI11803** Except Adding
 A Wire

Original & X-References..

HITACHI	L160-3320
	L150-13203
WAI	31-8105CARGO
	131598
MOBILETRON	RH-11
TRANSPO	IHR605
	IHR605HD



HI11805F

FEATURES

Diodes: 6-35 Ampere
 Diameter OD: 118mm
 With M6×35.2mm Battery Post
 With M5×46.5mm Mounting Bolt
 With M5×41mm Mounting Bolt
 With Trio
 For use on: Nissan, Subaru DL/GL/RX
 Hatchback, Sedan & Wagon, Subaru
 Loyale

Original & X-References..



HI11806F

FEATURES

Diodes: 6-35 Ampere
 Diameter OD: 118mm
 With M6×35.2mm Battery Post
 With M5×46.5mm Mounting Bolt
 With M5×41mm Mounting Bolt
 With Trio

Original & X-References..

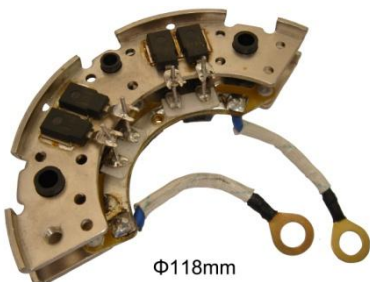

HI11810F

FEATURES

Diodes: 8-30 Ampere
 Diameter OD: 118mm
 With Trio

Original & X-References..



HI12601

FEATURES

Diodes: 6-25 Ampere
 Diameter OD: 126mm
 With M5×21mm Mounting Bolt
 With Trio

Original & X-References..

NIKKO 0337302190
 CARGO 135681



HI12602

FEATURES

Diodes : 6-25A Ampere
 Diameter OD : 126mm
 With M5×48.5mm Battery Post
 With M5×53.5mm Trio Post
 With Trio
 With 150 Ohm Resistor

Original & X-References..



HI12603

FEATURES

Diodes : 6-25A Ampere
 Diameter OD : 126mm
 With M5×30mm Battery Post
 With Trio
 With Capacitor
 With 150 Ohm Resistor

Original & X-References..



HI13201

FEATURES

Diodes: 8-25 Ampere
 Diameter OD: 132mm
 With M6×33.5mm Battery Post
 With Trio

Original & X-References..

ISUZU 1812191070
 NIKKO 0357300270
 0357300300
 0357300460
 CARGO 234578



HI10301

FEATURES

Diodes: 6-35 Ampere
 Diameter OD: 103 mm
 With M5×16.6mm Battery Post
 With Trio

Original & X-References..

For use on: Nissan Pickup, Pathfinder,
 Subaru Legacy

HITACHI L180-13202
 RENARD 15802
 WAI 31-8123
 CARGO 135040
 MOBILETRON RH-23
 TRANSPO IHR752



HI10302

FEATURES

Diodes: 6-35 Ampere
 Diameter OD: 103mm
 With M6×34mm Battery Post
 With M5×31.6mm Mounting Bolt
 With Trio

Original & X-References..

HITACHI	LR150-711
CARGO	138695
MOBILETRON	RH-28
TRANSPO	IHR757

For use on: Honda, Isuzu, Nissan Sentra



HI10303

FEATURES

Diodes: 8-35 Ampere
 Diameter OD: 103 mm
 With M5×16.6mm Battery Post
 Without Trio

Original & X-References..

HITACHI	L170-23203
CARGO	135039
MOBILETRON	RH-24
TRANSPO	IHR753

For use on: Nissan Pulsar, Sentra



HI10304

FEATURES

Diodes: 6-35Ampere
 Diameter OD: 103 mm
 With M5×16.6mm Battery Post
 With M5×31.6mm Mounting Bolt
 Without Trio
 For use on: Nissan Altima, Axxess

Original & X-References..

HITACHI	L180G-7320
LR180-725C	LR180-736B
LR180-725B	LR170-739
WAI	31-8132
	31-8132-1
CARGO	139464
MOBILETRON	RH-29
TRANSPO	IHR758



HI10305

FEATURES

Diodes: 6-35 Ampere
 Diameter OD: 103 mm
 With M6×43mm Battery Post
 With Trio

Original & X-References..

HITACHI	L170-43202
WAI	31-8127
CARGO	136650
MOBILETRON	RH-22
TRANSPO	IHR751

For use on: Nissan Pickup, Pathfinder



HI10306

FEATURES

Diodes: 8-35 Ampere
 Diameter OD: 103mm
 With M6×43mm Battery Post
 With M5×31.6mm Mounting Bolt
 Without Trio
 For use on: Nissan Sentra
HI10310 8-35 Ampere
 With M6×34mm Battery Post

Original & X-References..

HITACHI	L170-G2320
WAI	31-8129
CARGO	135318
MOBILETRON	RH-25
TRANSPO	IHR754



Φ103mm

HI10307

FEATURES

Diodes: 8-35 Ampere
 Diameter OD: 103mm
 With M6×43mm Battery Post
 With M5×31.6mm Mounting Bolt
 With Trio

Original & X-References..

HITACHI	L170-G1320
WAI	31-8125
CARGO	136976
MOBILETRON	RH-26
TRANSPO	IHR755

For use on: Honda, Isuzu, Nissan Sentra



Φ103mm

HI10308

FEATURES

Diodes: 6-35 Ampere
 Diameter OD: 103 mm
 With M5×16.6mm Battery Post
 With M5×31.6mm Mounting Bolt
 With Trio
 For use on: Infiniti G20, Nissan Sentra,
 NX2000

Original & X-References..

HITACHI	L180-13202
WAI	31-8123
CARGO	135040
MOBILETRON	RH-23
TRANSPO	IHR756 I HR752

HI10309

Diodes: 8-35 Ampere



Φ103mm

HI10311

FEATURES

Diodes: 8-35 Ampere
 Diameter OD: 103mm
 With M5×31.6mm Mounting Bolt
 For use on: Subaru Legacy 2.2L 70Amp

Original & X-References..

HITACHI	L170-33202
WAI	31-8117
CARGO	135038
MOBILETRON	RH-21
TRANSPO	IHR750



Φ127mm

HI11301A

FEATURES

Diodes: 8-35 A Avalanche
 Diameter OD: 127mm
 With M8×45.6mm Battery Post
 With M5×31.6mm Mounting Bolt
 For use on: 1999-up Opel Astra, Vectra
 1.7L, 1999-up Opel Corsa, W/AC1.7L

Original & X-References..

0901-0021	
CARGO	235729
MOBILETRON	RH-73
TRANSPO	IHR769

HI11301 8-35 Ampere



Φ113mm

HI11302

FEATURES

Diodes: 8-35 Ampere
 Diameter OD: 113mm
 With M8×45.6mm Battery Post
 With M5×31.6mm Mounting Bolt

Original & X-References..

HI11302A
 Diodes: 8-35 A Avalanche
HI11302B 8-35A Avalanche
 For 24V Alternator
 With M6×51mm Battery Post



HI11303A

FEATURES

Diodes: 8-60 A Avalanche
 Diameter OD: 119mm
 With M6×20.3mm Battery Post
 With M5×31.6mm Mounting Bolt

 For use on: Nissan Maxima 3.0L
 DOHC, Infiniti 130

Original & X-References..

HITACHI	L1125G-2320
	L1110G-4320
WAI	31-8142
CARGO	138718
MOBILETRON	RH-35
TRANSPO	IHR773



HI11304A

FEATURES

Diodes: 8-35 A Avalanche
 Diameter OD: 119mm
 With M6×20.3mm Battery Post
 With M5×31.6mm Mounting Bolt

 For use on: 95-97 Nissan Maxima 3.0L
 DOHC, 98-99 Nissan Maxima
 SE3.0L, 98-99 Infiniti 3.0L

Original & X-References..

HITACHI	LR1110-709B
	LR1110-707G
	LR1110-710F
MOBILETRON	RH-77
CARGO	234027
NISSAN	231000L701
TRANSPO	IHR770



HI11305A

FEATURES

Diodes: 6-35 A Avalanche
 Diameter OD: 119mm
 With M6×20.3mm Battery Post
 With M5×31.6mm Mounting Bolt
 Mates to Regulators with Integral Brush
 Holder
 For use on: 98-99 Nissan Maxima 3.0L

Original & X-References..

HITACHI	LR1110711
	LR1110711B
	L1100G-23201
NISSAN	231000L700
TRANSPO	IHR771



HI11306

FEATURES

Diodes: 6-35 Ampere
 Diameter OD: 119mm
 With M8×50.5mm Battery Post
 With M5×36.5mm Mounting Bolt

Original & X-References..

HI11307

Diodes: 8-35 Ampere



HI11308B

FEATURES

Diodes: 8-35A Avalanche
 Diameter OD: 127mm
 With M6×51mm Battery Post

Original & X-References..

HITACHI	LR280-508
---------	-----------

For 24V Alternators



HI11315A

FEATURES

Diodes: 6-60A Avalanche
 Diameter OD :127mm
 With M8×45.6mm Battery Post
 With M5×35mm Mounting Post

Original & X-References..

HITACHI	LR1100-502MD
TRANSPO	IHR669

HI11315A-1

Diodes: 8-60A Avalanche



HI11318A

FEATURES

Diodes: 8-35A Avalanche
 Diameter OD :127mm
 With M6×20.3mm Battery Post
 With M5×31.6mm Mounting Post

Original & X-References..

HI11318A-1

With M8×50.5mm Battery Post

HI11318B

Diodes: 8-35A Avalanche
 For 24V Alternators



HI11322A

FEATURES

Diodes : 12-35A Avalanche
 Diameter OD : 113mm
 With M6×20.3mm Battery Post
 With M5×31.6mm Mounting Bolt
 For 12V Alternators

Original & X-References..

TRANSPO	IHR765
---------	--------



HI11323A

FEATURES

Diodes : 8-35 A Avalanche
 Diameter OD : 119mm
 With M8×50.5mm Battery Post
 With M5×31.6mm Mounting Bolt

Original & X-References..



HI11401

FEATURES

Diodes: 6-35 Ampere
 Diameter OD: 115mm
 With M8×45.6mm Battery Post
 With M5×31.6mm Mounting Bolt
 For use on: Opel Corsa, Vectra

Original & X-References..

HITACHI	L170G-23203
GM	97122644
CARGO	230094
MOBILETRON	RH-48
TRANSPO	IHR749

HI11401A

Diodes: 6-35A Avalanche



HI11402

FEATURES

Diodes: 8-35 Ampere
 Diameter OD: 114mm
 With M6×51mm Battery Post
 With M5×42.5mm Mounting Bolt
 With Trio
 For use on: 8-97083286-0

Original & X-References..

HITACHI L180G-8320
 CARGO 138615



HI11403

FEATURES

Diodes: 8-35 Ampere
 Diameter OD: 114mm
 With M8×45.6mm Battery Post
 With M5×31.6mm Mounting Bolt
 For use on: Nissan Sentra, 200SX,
 200SX Turbo
HI11403A
 Diodes: 8-35A Avalanche

Original & X-References..

HITACHI LR170-748
 LR170-748B
 LR190-729
 LR180-751
 WAI 31-8141
 CARGO 138732
 TRANSPO IHR746



HI11405

FEATURES

Diodes: 6-35 Ampere
 Diameter OD: 114mm
 With M6×20.3mm Battery Post
 For use on: Nissan Altima
HI11405A
 Diodes: 6-35A Avalanche
HI11405-1
 Diodes: 8-35 Ampere

Original & X-References..

HITACHI LR160-727
 LR180-741H LR180-744
 CARGO 230662
 NISSAN 231001E800
 WAI 31-8136
 MOBILETRON RH-32
 TRANSPO IHR778
 TRANSPO IHR783



HI11406

FEATURES

Diodes: 8-35 Ampere
 Diameter OD: 114mm
 With M5×18.5mm Battery Post
 With M5×31.6mm Mounting Bolt
HI11406A
 Diodes: 8-35A Avalanche

Original & X-References..

HI11407



FEATURES

Diodes: 8-35 Ampere
 Diameter OD: 114mm
 With M6×20.3mm Battery Post
 With M5×31.6mm Mounting Bolt
 For use on: Nissan 240 SX
HI11407-1 6-35 Ampere
HI11407A 8-35A Avalanche
HI11407A-161
 Diodes: 8-35A Avalanche
 With M6×51mm Battery Post

Original & X-References..

HITACHI LR185-701H
 LR190-724 LR180-724C
 WAI 31-8143
 NISSAN 2310070F05
 MOBILETRON RH-33
 TRANSPO IHR775
 HITACHI 0901-0027
 TRANSPO IHR744
 MOBILTERON RH-66
 TRANSPO IHR780



HI11408

FEATURES

Diodes: 8-35 Ampere
 Diameter OD: 114mm
 With M6×20.3mm Battery Post
 With M5×31.6mm Mounting Bolt
 For use on: 1977-2000 Nisan puthfinder 3.3L

Original & X-References..

HITACHI	L190G-43205
J&N	172-44066
CARGO	234315
TRANSPO	IHR737

HI11408A

Diodes: 8-35A Avalanche



HI11409

FEATURES

Diodes: 8-35 Ampere
 Diameter OD: 114mm
 With (M8 +M4)×55.4mm Battery Post
 With (M5+M4)×41.8mm Mounting Bolt

Original & X-References..

HITACHI	L1100-501B
CARGO	231081

HI11409A

Diodes: 8-35A Avalanche

HI11416

Diodes: 6-35Ampere



HI11410

FEATURES

Diodes: 8-35 Ampere
 Diameter OD: 114mm
 With M6×20.3mm Battery Post
 With M5×31.6mm Mounting Bolt
 For use on: 1998-2002 Nissan Forntier 2.4L, 2000-2002 Nissan Xterra 2.4L

Original & X-References..

HITACHI	LR170-757B
	L190G-13205
NISSAN	231003S500
MOBILETRON	RH-70
TRANSPO	IHR738

HI11410A 8-35A Avalanche

TRANSPO	IHR739
---------	--------

HI11419 6-35 Ampere

0901-0011



HI11411

FEATURES

Diodes: 6-35 Ampere
 Diameter OD: 114mm
 With M6×51mm Battery Post
 With (M5+M4)×41.8mm Mounting Bolt

Original & X-References..

HITACHI	L190G-33201
	L190G-83204
NISSAN	2323086N00
CARGO	138617



HI11412

FEATURES

Diodes: 8-35Ampere
 Diameter OD: 114mm
 With M8×45.6mm Battery Post

Original & X-References..

HITACHI	L160G-53201
MOBILETRON	RH-65

HI11412A

Diodes: 8-35A Avalanche



Φ114mm

HI11413

FEATURES

Diodes: 8-35A Ampere
 Diameter OD: 114mm
 With M6×48mm Battery Post
 With Trio

Original & X-References..

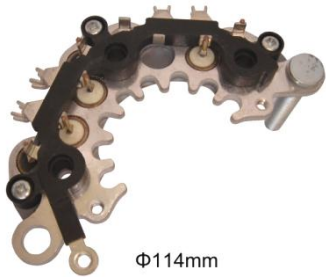

Φ114mm

HI11414

FEATURES

Diodes: 6-35 Ampere
 Diameter OD: 114mm
 With M8×49mm Battery Post

Original & X-References..

HITACHI	LR170-745
MOBILETRON	RH-30
TRANSPO	IHR745

For use on: Nissan Pick-up, Pathfinder



Φ114mm

HI11417

FEATURES

Diodes: 8-35 Ampere
 Diameter OD: 114mm
 With M6×48mm Battery Post
 With M5×31.6mm Mounting Bolt

Original & X-References..

HI11417-1

With M8×49mm Battery Post



Φ114mm

HI11418A

FEATURES

Diodes: 6-35A Avalanche
 Diameter OD: 114mm
 With M6×51mm Battery Post
 With M5×31.6mm Mounting Bolt

Original & X-References..

J&N	172-44064
TRANSPO	IHR781



Φ114mm

HI11418A-1

FEATURES

Diodes: 6-35A Avalanche
 Diameter OD: 114mm
 With M6×51mm Battery Post
 With M5×31.6mm Mounting Bolt

Original & X-References..

J&N	172-44065
CARGO	234909
TRANSPO	IHR782



HI11420

FEATURES

Diodes: 8-35 Ampere
 Diameter OD: 114mm
 With M8×45.6mm Battery Post
 With M5×31.6mm Mounting Bolt
HI11421
 With M6×20.3mm Battery Post

Original & X-References..



HI11422

FEATURES

Diodes : 6-35A Ampere
 Diameter OD : 114mm
 With M6×20.3mm Battery Post
 With M5×31.6mm Mounting Bolt
 With Trio

Original & X-References..



HI11423

FEATURES

Diodes : 6-35A Ampere
 Diameter OD : 114mm
 With M6×20.3mm Battery Post
HI11423-1
 Diodes : 8-35A Ampere
HI11423-2
 Diodes : 6-35A Ampere
 With M8×45.6mm Battery Post

Original & X-References..

HIACHI	LR170758
HONDA	BP4W18300B
	BP4W1830-0BC
TRANSPO	IHR762



HI11424

FEATURES

Diodes : 8-35A Ampere
 Diameter OD : 114mm
 With M6×48mm Battery Post

Original & X-References..

HIACHI	LR190744
ISUZU	2902768300
LESTER	13825
CARGO	234829
TRANSPO	IHR764



HI10304ZT

FEATURES

Complete set with
 REC **HI10304+REG (05-088H)** 14V

Original & X-References..

TRANSPO	IHR758+IH762
---------	--------------



HI10310ZT

FEATURES

Complete set with
REC HI10310+REG (05-052) 14V

For use on: LR170-734

Original & X-References..

TRANSPO IHR754+IH761



HI111ZT21135F

FEATURES

Complete set with
REC HI11106+ REG (05-007H) 14V

For use on: NISSAN (DIESEL)

Original & X-References..



HI111ZT31135F

FEATURES

Complete set with
REC HI11106+ REG (05-010H) 14V

For use on: NISSAN (DIESEL)

Original & X-References..

HITACHI L140-53202
L150-83201

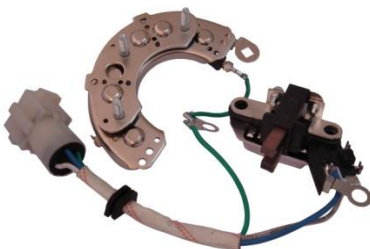

HI111ZTN31135F

FEATURES

Complete set with
REC HI11101+ REG (05-027H) 14V

For use on: NISSAN (DIESEL)

Original & X-References..

HITACHI L150-13204



HI111ZT41135F

FEATURES

Complete set with
REC HI11106+ REG (05-011H) 14V

-
For use on: NISSAN (DIESEL)

Original & X-References..

HITACHI L140-53202
L150-83201



HI11116ZT

FEATURES

Complete set with
REC HI11116+ REG (05-010H) 14V

HI11116ZT-1

REC HI11116+REG (05-011H) 14V
With 4 pin plug

HI11116ZT-2

REC HI11116+ REG (05-012H) 28V

Original & X-References..

HITACHI L140-53202
L150-83201

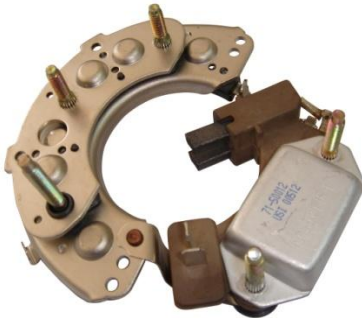

HI112ZT21135C

FEATURES

Diodes: 6-35Ampere
Diameter OD: 112mm
Complete set with
REC HI11102C+ REG (05-030H) 14V

Original & X-References..



HI113ZT12835F

FEATURES

Complete set with
REC HI11124+ REG (12-0031) 28V

Original & X-References..

CARGO 135680



HI113ZT22835F

FEATURES

Complete set with
REC HI11124+ REG (12-0031) 28V

Original & X-References..



HI113ZT32835F

FEATURES

Complete set with
REC HI11124+ REG (12-0091) 28V

Original & X-References..



HI11301AZT

FEATURES

Complete set with
REC HI11301A+REG (05-085) 14V

HI11301ZT

Complete set with
REC HI11301+REG (05-085) 14V

HI11316AZT

Complete set with
REC HI11316A+REG (05-085) 14V

Original & X-References..

HITACHI	LR1100-502E
	LR1100-502G
TRANSP0	IHR769+IH769



HI11317AZT

FEATURES

Complete set with
REC HI11301A+REG (05-0531) 14V

Original & X-References..

HITACHI	LR180-508
---------	-----------



HI11302BZT

FEATURES

Complete set with
REC HI11302B+REG (05-037H) 28V

L Terminal

HI11302A-1ZT

REC HI11302A-1+REG(05-042H) 14V
L.S Terminal

Original & X-References..

HITACHI	LR250-517
CARGO	113190



HI11303AZT

FEATURES

Complete set with
REC HI11303A+REG (05-0082) 14V

Original & X-References..

HITACHI	LR1110-705
TRANSP0	IHR773+IH766

HI11303AZT-2

REC HI11303A+REG (05-0251) 14V



HI11305AZT

FEATURES

Complete set with
REC HI11305A+REG (05-054H) 14V

Original & X-References..

HITACHI	LR1110-713C
IHR771+IH744	

HI11305AZT-1

REC HI11305A+REG (05-036H) 14V IHR771+IH774

HI11305AZT-2

REC HI11305A+REG(05-0961) 14V IHR771+IH741

LESTER	13901
--------	-------



HI11306ZT

FEATURES

Complete set with
REC HI11306+REG (05-0251) 14V

Original & X-References..

HITACHI LR190-734

HI11307ZT

Complete set with
REC HI11307+REG (05-0251) 14V



HI11308BZT

FEATURES

Complete set with
REC HI11308B+REG (05-016H) 24V

Original & X-References..

HITACHI LR280-508

HI11308BZT-1

REC HI11308B+REG (05-037H) 24V

HI11308B-1ZT

REC HI11308B-1+REG (05-016H) 24V



HI11311BZT

FEATURES

Complete set with
REC HI11311B+REG (05-1031) 24V

Original & X-References..



HI11312ZT

FEATURES

Complete set with
REC HI11312+REG (05-043H) 14V

Original & X-References..

HITACHI LR180-510

L Terminal

HI11312-2ZT

REC HI11312-2+REG (05-043H) 14V



HI11313AZT

FEATURES

Complete set with
REC HI11303A+REG (05-0541) 14V

Original & X-References..

IHR773+IH744

For use on: Nissan Maxima 3.0L
DOHC, Infiniti 130



HI11314AZT

FEATURES

Complete set with
REC HI11304A+REG (05-036H) 14V

For use on: 95-97 Nissan Maxima 3.0L
DOHC,98-99 Nissan Maxima
SE3.0L,98-99 Infiniti 3.0L

Original & X-References..

IHR770+IH774



HI11315AZT

FEATURES

Complete set with
REC HI11315A+REG (05-0531) 14V

HI11315A-1ZT

Complete set with
REC HI11315A-1+REG(05-0141) 14V

Original & X-References..

HITACHI LR1100-502MD
IHR669+IH669



HI11318AZT

FEATURES

Complete set with
REC HI11318A+REG (05-042H) 14V

HI11318A-1ZT

REC HI11318A-1+REG(05-042H) 14V

HI11318BZT

Complete set with
REC HI11318B+REG (05-016H) 24V

Original & X-References..

HITACHI LR280-501



HI11321AZT

FEATURES

Complete set with
REC HI11321A+REG (05-054H) 14V

Original & X-References..

HII1321A+IH744



HI11322AZT

FEATURES

Complete set with
REC HI11322A+REG (05-091) 14V

HI11322AZT-1

Complete set with
REC HI11322A+REG (05-0961) 14V

Original & X-References..

HITACHI LR1130-701
WAI 48-8111
LESTER 11120
IHR765+IH746

WAI 48-8113
LESTER 11165
IHR765+IH747



HI11323AZT

FEATURES

Complete set with
REC HI11323A+REG (05-054H) 14V

Original & X-References..

HITACHI	LR1100-712
LESTER	13900



HI11324AZT

FEATURES

Complete set with
REC HI11324A+REG (05-0961) 14V

Original & X-References..

LESTER	11119
--------	-------



HI11330AZT

FEATURES

Complete set with
REC HI11330A+REG(05-1061) 14V

Original & X-References..



HI11332ZT

FEATURES

Complete set with
REC HI11332+REG(05-0251) 14V

Original & X-References..



HI114ZT

FEATURES

Complete set with
REC HI11123+ REG (05-046) 14V

Original & X-References..

HI114ZT-1

REC HI11123+REG (05-005) 14V



HI11401ZT

FEATURES

Complete set with
REC HI11401+REG (05-0041) 14V

For use on: Opel Corsa, Ventra

HI11401AZT

Complete set with
REC HI11401A+REG (05-0041) 14V

Original & X-References..

HITACHI	LR170-505
	LR170-505B
TRANSPO	IHR749+IH776



HI11402ZT

FEATURES

Complete set with
REC HI11402A+REG (05-0031) 24V

HI11402-3ZT

Complete set with
REC HI11402+REG (05-0241) 14V

Original & X-References..

For use on: 8-97083286-0	
HITACHI	LR1100-503
CARGO	138615



HI11403ZT

FEATURES

Complete set with
REC HI11403+REG (05-0151) 14V

HI11403AZT

Complete set with
REC HI11403A+REG (05-0151) 14V

HI11403AZT-1

REC HI11403A+REG (05-001H) 14V

Original & X-References..

HITACHI	LR170-748
	LR170-748B
	LR180-751
	LR190-729
TRANSPO	IHR746+IH767



HI11405ZT

FEATURES

Complete set with
REC HI11405+REG (05-0151) 14V

HI11405AZT

Complete set with
REC HI11405A+REG (05-0151) 14V

HI11405A-3ZT

REC HI11405A-3+REG (05-0151) 14V

Original & X-References..

HITACHI	LR160-727
	LR180-741H
	LR180-744
TRANSPO	IHR778+IH767



HI11406ZT

FEATURES

Complete set with
REC HI11406+REG (05-0151) 14V

HI11406AZT

Complete set with
REC HI11406A+REG (05-0151) 14V

Original & X-References..

HI11406+IH767



HI11407AZT

FEATURES

Complete set with
 REC HI11407A+REG (05-0251) 14V
 For use on: Subaru Legacy

Original & X-References..

LESTER 13645
 TRANSPO IHR744+IH765

HI11407A-1ZT

Complete set with
 REC HI11407A-1+REG (05-0251) 14V

HITACHI LR160-728
 WAI 48-8102
 TRANSPO IHR775+IH765



HI11408ZT

FEATURES

Complete set with
 REC HI11408+REG (05-0151) 14V
 For use on:1977-2000 Nisan puthfinder
 3.3L

Original & X-References..

HITACHI LR19073
 NISSAN 23100-OW001
 TRANSPO IHR737+IH767

HI11408AZT

Complete set with
 REC HI11408A+REG (05-0151) 14V



HI11409ZT

FEATURES

Complete set with
 REC HI11409+REG (05-009H) 14V

Original & X-References..

HITACHI LR1100-501B

HI11409AZT

Complete set with
 REC HI11409A+REG (05-009H) 14V



HI11410ZT

FEATURES

Complete set with
 REC HI11410+REG (05-001H) 14V
 For use on: 1998-2002 Nissan Forntier
 2.4L, 2000-2002 Nissan Xterra 2.4L

Original & X-References..

IHR738+IH738

HI11410AZT

REC HI11410A+REG (05-001H) 14V

HI11410AZT-2

REC HI11410A+REG (05-055H) 14V



HI11411ZT

FEATURES

Complete set with
 REC HI11411+REG (05-035H) 14V

Original & X-References..

HITACHI LR170-502B

HI11416ZT

With (M8+M4) ∅55.4mm Battery Post
 Complete set with
 REC HI11416+REG (05-035H) 14V



HI11412ZT

FEATURES

Complete set with
REC HI11412+REG (05-0251) 14V

Original & X-References..

HITACHI LR160-728E

HI11412-1ZT

Complete set with
REC HI11412-1+REG (05-0251) 14V

CARGO JA1516IR



HI11413ZT

FEATURES

Complete set with
REC HI11413+REG (05-002) 14V

Original & X-References..



HI11414ZT

FEATURES

Complete set with
REC HI11414+REG (05-0151) 14V

Original & X-References..

LESTER 13728
TRANSPO IHR745+IH767

For use on: Nissan Pick-up, Pathfinder



HI11417ZT

FEATURES

Complete set with
REC HI11417+REG (05-001H) 14V

Original & X-References..

HI11417-1ZT

REC HI11417-1+REG (05-001H) 14V



HI11418AZT

FEATURES

Complete set with
REC HI11418A+REG (05-102) 14V

Original & X-References..

HITACHI LR160-730C
LESTER 13745N
TRANSPO IHR781+IH772



HI11423-1ZT

FEATURES

Complete set with
REC HI11423-1+REG (05-054H) 14V

Original & X-References..

HI11423-2ZT

REC HI11423-2+REG (05-054H) 14V
M8×45.6mm Battery Bolt



HI11424ZT

FEATURES

Complete set with
REC HI11424+REG (05-054H) 14V

Original & X-References..

HITACHI	LR190-744
LESTER	13825
IHR764+IH744	



HI11427AZT1

FEATURES

Complete set with
REC HI11427+REG (05-041) 14V

Original & X-References..

HITACHI	LR190-742
CARGO	13829
TRANSPO	IHR742+IH742

Customer provide Regulator



HI11430ZT

FEATURES

Complete set with
REC HI11430+REG(05-054H) 14V

Original & X-References..

HITACHI	LR180763
YANMAR	12391077210



HI132ZT

FEATURES

Diodes: 8-25 Ampere
Diameter OD: 132mm
Complete set with
REC HI13201+REG (12-001H) 28V

Original & X-References..

**HI12001A****FEATURES**

Diodes:12-35A Avalanche
With M8 ×37mm Battery Post
Without Trio

For used on: NISSAN TIIDA

Original & X-References..

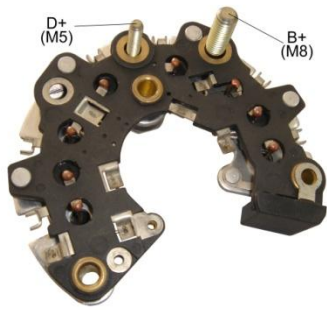

ISK001

FEATURES

- Diodes: 8-35A Avalanche
- With M8×39.5mm Battery Post
- With M5×28.5mm Trio Post
- With Trio
- With Capacitor

Original & X-References..

ISKRA	16903314
CARGO	231050
MONARK DIESEL	093231050
	93231050

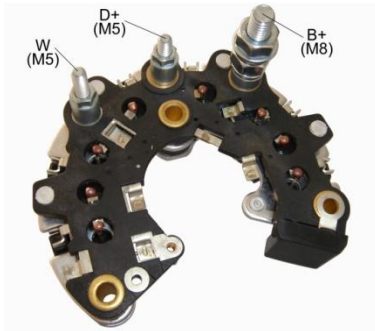

ISK002

FEATURES

- Diodes: 8-35 A Avalanche
- With M8×54mm Battery Post
- With M5×32mm Trio Post
- With M5×32mm W Post
- With Trio
- With Capacitor

Original & X-References..

ISKRA	16903507
CARGO	231472

ISK006

- Diodes: 6-35 A Avalanche

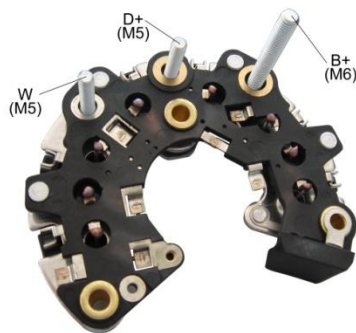

ISK003

FEATURES

- Diodes: 8-35A Avalanche
- With M6×54mm Battery Post
- With M5×32mm Trio Post
- With M5×32mm W Post
- With Trio
- With Capacitor

Original & X-References..

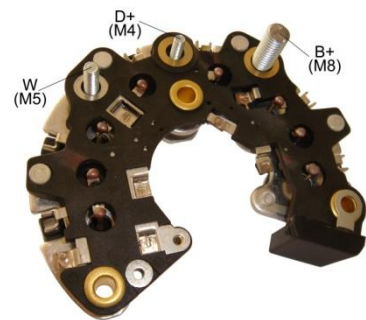

ISK004B

FEATURES

- Diodes: 8-35A Avalanche
- With M8×35.5mm Battery Post
- With M4×19.8mm Trio Post
- With M5×21.3mm W Post
- With Trio
- With Capacitor
- For 24V Alternators

Original & X-References..

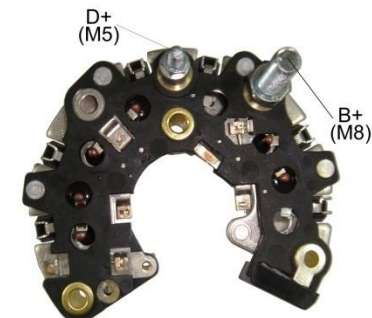

ISK005

FEATURES

- Diodes:6-35A Avalanche
- With M8×54mm Battery Post
- With M5×32mm Trio Post
- With Trio
- With Capacitor

Original & X-References..

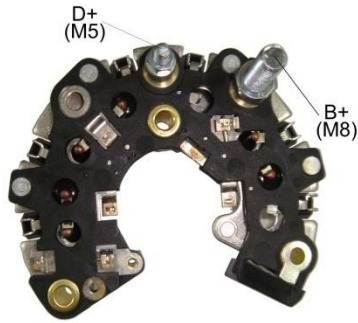

ISK007

FEATURES

Original & X-References..

- Diodes:8-35A Avalanche
- With M8×39.5mm Battery Post
- With M5×28.5mm Trio Post
- With Trio
- With Capacitor

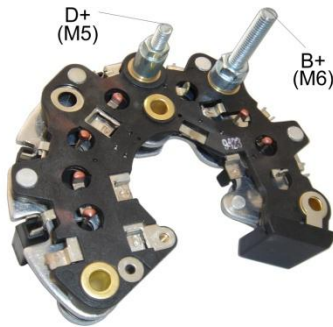

ISK008

FEATURES

Original & X-References..

- Diodes :6-35A Avalanche
- With M6×54mm Battery Post
- With M5×32mm Trio Post
- With Trio
- With Capacitor



LA1102

FEATURES

Diodes: 6-50AAvalanche
 With M6x51mm Battery Post
 With Trio/Capacitor
 Without "W" Terminal

Original & X-References..

TR1-105-04

LA1104

Diodes: 8-50AAvalanche
 Without Capacitor
 Without "W" Terminal



LA1103

FEATURES

Diodes: 6-50 A Avalanche
 With Trio
 Without Capacitor
 Without "W" Terminal

Original & X-References..

BVO-1-105



LA1107

FEATURES

Diodes: 6-50 A Avalanche
 With Trio
 Without Capacitor
 Without "W" Terminal

Original & X-References..

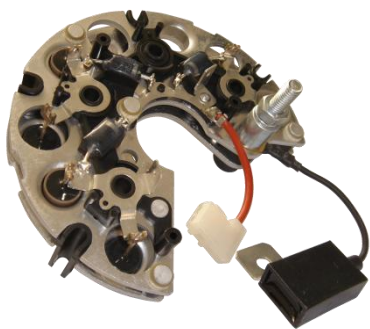

LA1107-1

FEATURES

Diodes: 6-50 AAvalanche
 With Trio
 With Capacitor
 With "W" Terminal

Original & X-References..

5B03-105-03

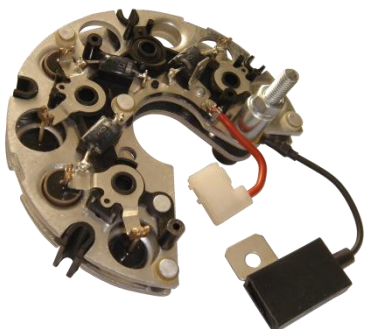

LA1107-2

FEATURES

Diodes: 6-50 A Avalanche
 With Trio
 With Capacitor
 Without "W" Terminal

Original & X-References..

6B03-105-01



LA1114

FEATURES

Diodes: 6-35 Ampere
 With Trio
 Without Capacitor
 Without "W" Terminal

Original & X-References..

56-65-02



LA1115

FEATURES

Diodes: 6-35 Ampere
 Without Tiro
 Without Capacitor
 Without "W" Terminal

Original & X-References..

56-65-02e



LA1125

FEATURES

Diodes:6-50A Avalanche
 With Trio
 Without Capacitor
 Without "W" terminal

Original & X-References..



LA1128B

FEATURES

Diodes:8-50A Avalanche
 With M6×51mm Battery Post
 With Trio
 With Capacitor
 With "W" terminal
 For 24V Alternators

Original & X-References..



LA1130

FEATURES

Diodes:6-35 Avalanche
 With M6×51mm Battery Post
 With Trio
 Without "W" terminal

Original & X-References..

LA1139**FEATURES**

Diodes: 6-35 A Ampere
With M5×30mm Battery Post
Without Trio
Without Capacitor

Original & X-References..



ZLB-07

FEATURES

Diodes: Positive Assembly, 3-50
 Ampere Press Fit 330 Volt
 With Lead Wire 1-125mm
 With Lead Wire 2-85mm

For use on: 140-160A 2800JB Series,
 7800JB Series

Original & X-References..

LEECE NEVILLE	97084
MOBILETRON	RC-07HV
WAI	31-505
CARGO	230752
LESTER	7613
TRANSP0	LR97084



ZLB-08

FEATURES

Diodes: Negative Assembly,3-50
 Ampere Press Fit 330 Volt
 With Lead Wire 1-125mm
 With Lead Wire 2-85mm

For use on: 140-160A 2800JB Series,
 7800JB Series

Original & X-References..

LEECE NEVILLE	97085
MOBILETRON	RC-08HV
WAI	31-504
CARGO	230753
LESTER	7613
TRANSP0	LR97085



ZLB-09

FEATURES

Diodes: Positive ssembly,3-35
 Ampere Press Fit 330 Volt
 With Lead Wire 3-125mm

For use on: 130A 2700JB Series

Original & X-References..

LEECE NEVILLE	79193
MOBILETRON	RC-05HV
WAI	31-503
CARGO	230606
LESTER	7614
	7767
	7602
TRANSP0	LR79193



ZLB-10

FEATURES

Diodes: Negative Assembly,3-35
 Ampere Press Fit 330 Volt
 With Lead Wire 3-134mm

For use on: 130A 2700JB Series

Original & X-References..

LEECE NEVILLE	79415
MOBILETRON	RC-06HV
WAI	31-502
CARGO	230607
LESTER	7706JA
	7711JA
TRANSP0	LR79415



ZLB-11

FEATURES

Diodes: Positive Assembly,3-35
 Ampere Button
 Steel Heat Sink
 With 1/4" x 40 Battery Post

For use on: Chrysler Square Back

Original & X-References..

WAI	31-301-1
CARGO	131420
TRANSP0	CR3040
	CR3042
	CR3042HD



ZLB-12

FEATURES	Original & X-References..	
Diodes: Negative Assembly, 3-35	WAI	31-300-2
Ampere Button	CARGO	131419
Aluminum Heat Sink	TRANSPO	CR3041
		CR3043
For use on: Chrysler Square Back		CR3043HD



ZLB-17

FEATURES	Original & X-References..	
Diodes: 6-50Ampere	LEECE NEVILLE	101425
Negative Assembly	TRANSPO	LR711425
10-Gauge Leads with Hi-Temp Insulation		
For use on: EMV, Navistar Trucks		



ZLB-18

FEATURES	Original & X-References..
Diodes: Positive Assembly, 3-35 Ampere	1070-0710
Button	
Aluminum Heat Sink	
With 1/4" x 40 Battery Post	



ZLB-19N

FEATURES	Original & X-References..
Diodes: 4-30 Ampere	
Negative Assembly	
Aluminum Heat Sink	



ZLB-19P

FEATURES	Original & X-References..
Diodes: 4-30 Ampere	
Positive Assembly	
Aluminum Heat Sink	

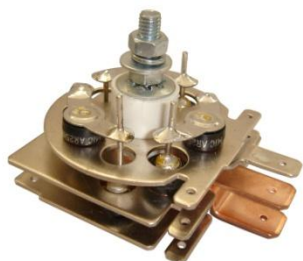

LUS1101

FEATURES

Diodes: 9-25 Ampere Button
 With M5×50mm Mounting Post

 For use on: Austin, Lotus, MG,
 Triumph, Chrysler & Ford Imports

Original & X-References..

LUCAS	83 166	83 334
	83 520	83 842
WAI	31-9200	
CARGO	130643	
MOBILETRON	RL-08HV	
TRANSPO	ILR166	

LUS1101HD

Diodes: 9-35 Ampere Button

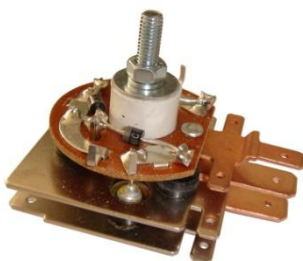

LUS1102

FEATURES

Diodes: 6-25 Ampere Button
 With M5×50mm Mounting Post
 With Trio

Original & X-References..

LUCAS	83 166
	83 334 83 520
	83 842 83 844
WAI	31-920
CARGO	130643

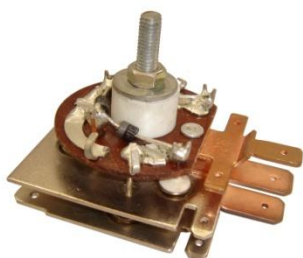

LUS1103

FEATURES

Diodes: 6-35 Ampere Dish Diode
 With M5×50mm Mounting Post
 With Trio

Original & X-References..

For use on: Austin, Lotus, MG,
 Triumph, Chrysler & Ford Imports

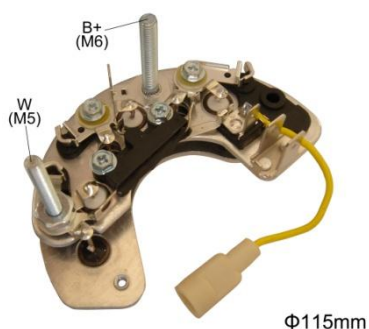

LUS133

FEATURES

Diodes: 6-35 Ampere
 Diameter OD: 115mm
 With M6×41.7mm Battery Post
 With M5×53.7mm W-Post
 With Lead Wire 110mm
 With Trio

Original & X-References..

LUCAS	84 201	84 422
WAI	31-9208	
CARGO	131304	
MOBILETRON	RL-01H	
TRANSPO	ILR566HD	

For use on: Massey Ferguson, J.I. Case

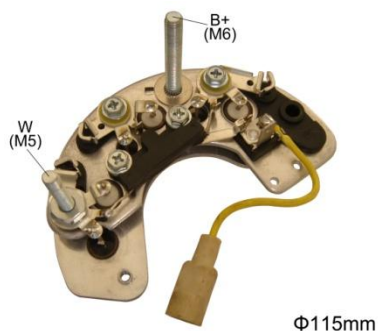

LUS136

FEATURES

Diodes: 6-35 Ampere
 Diameter OD: 115mm
 With M6×46.5mm Battery Post
 With M5×47.5mm W-Post
 With Lead Wire 110mm
 With Trio

Original & X-References..

LUCAS	84 468	UBB 136
CARGO	132720	
MOBILETRON	RL-11H	
TRANSPO	ILR567HD	

For use on: Ford Tractor

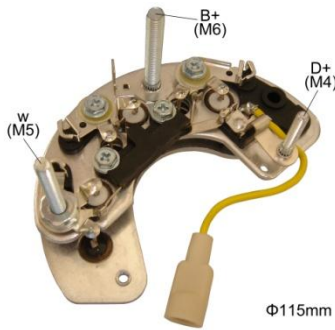

LUS137

FEATURES

Diodes: 6-35 Ampere
 Diameter OD: 115mm
 With M6×43.7mm Battery Post
 With M5×53.7mm W-Post
 With M4×28mm Trio Post
 With Lead Wire 110mm
 With Trio
 For use on: Ford Tractor, Rover

Original & X-References..

FORD	86AB10304BA
LUCAS	84 469 UBB 137
CARGO	132721
MOBILETRON	RL-09H
TRANSPO	ILR568HD

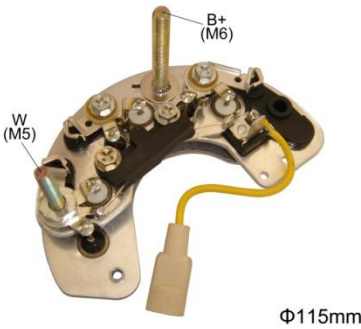

LUS140

FEATURES

Diodes: 6-35 Ampere
 Diameter OD: 115mm
 With M6×46.5mm Battery Post
 With M5×47.5mm W-Post
 With Lead Wire 110mm
 With Trio

Original & X-References..

LUCS	UBB 140	84456
WAI	31-9220	
CARGO	132718	
MOBILETRON	RL-06H	
UNIPOINT	REC-834	
TRANSPO	ILR570HD	

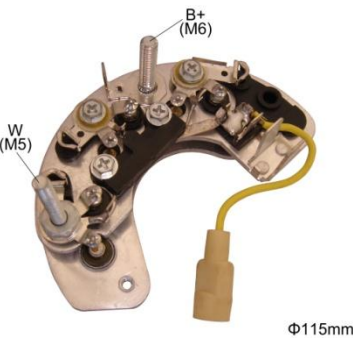

LUS143

FEATURES

Diodes: 6-35 Ampere
 Diameter OD: 115mm
 With M6×32.5mm Battery Post
 With M5×53.7mm W-Post
 With Lead Wire 110mm
 With Trio
 For use on: Industrial

Original & X-References..

LUCAS	84 889	UBB 143
WAI	31-9208	
CARGO	131304	
MOBILETRON	RL-01H	
UNIPOINT	REC-838	
	REC831	
TRANSPO	ILR571HD	

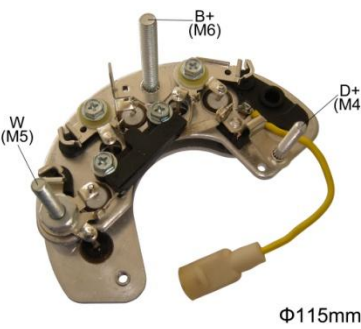

LUS145

FEATURES

Diodes: 6-35 Ampere
 Diameter OD: 115mm
 With M6×43.7mm Battery Post
 With M5×47.5mm W-Post
 With M4×28mm Trio Post
 With Lead Wire 110mm
 With Trio
 For use on: Ford

Original & X-References..

LUCAS	4572	UBB 145
WAI	31-9222	
CARGO	136666	
MOBILETRON	RL-21H	
UNIPOINT	REC-835	
TRANSPO	ILR572HD	

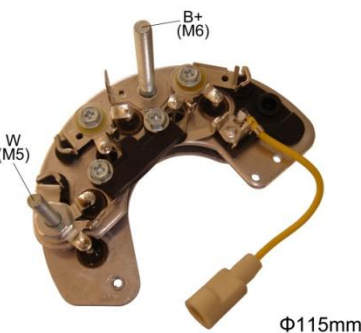

LUS147

FEATURES

Diodes: 6-35 Ampere
 Diameter OD: 115mm
 With M6×46.5mm Battery Post
 With M5×47.5mm W-Post
 With Trio
 For use on: Industrial

Original & X-References..

LUCAS	84 888	UBB 147
WAI	31-9221	
CARGO	133430	
MOBILETRON	RL-07H	
UNIPOINT	REC836	
TRANSPO	ILR574HD	

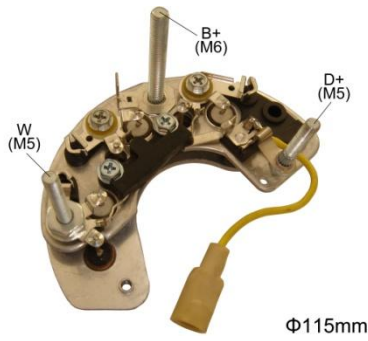

LUS148

FEATURES

Diodes: 6-35 Ampere
 Diameter OD: 115mm
 With M6×52mm Battery Post
 With M5×53.7mm W-Post
 With M5×31.5mm Trio Post
 With Lead Wire 110mm
 With Trio
 For use on: Nissan Primera

Original & X-References..

LUCAS	84 976	633 285 06
WAI	31-9223	
CARGO	136324	
MOBILETRON	RL-10H	
TRANSPO	ILR576HD	

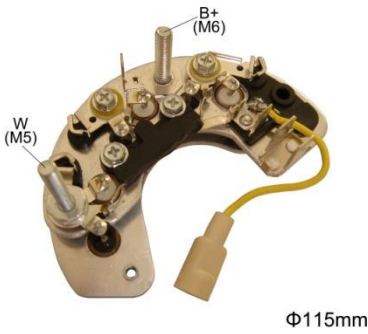

LUS149

FEATURES

Diodes: 6-35 Ampere
 Diameter OD: 115mm
 With M6×32.5 mm Battery Post
 With M5×53.7mm W-Post
 With Lead Wire 110mm
 With Trio
 For use on: Nissan Industrial, Rover

Original & X-References..

LUCAS	84 574	UBB 138
CARGO	138808	
MOBILETRON	RL-22H	
TRANSPO	ILR569HD	

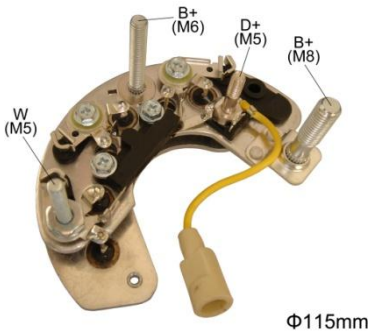

LUS152

FEATURES

Diodes: 6-35 Ampere
 Diameter OD: 115mm
 With M6×41.7mm Battery Post
 With M8×38mm Battery Post
 With M5×47.5mm W-Post
 With M5×25mm Trio Post
 With Lead Wire 110mm
 With Trio

Original & X-References..



LUS1301A

FEATURES

Diodes: 6-35A Avalanche
 Diameter OD: 120mm
 With M6×43.7mm Battery Post
 With Lead Wire 60mm
 With Trio

Original & X-References..

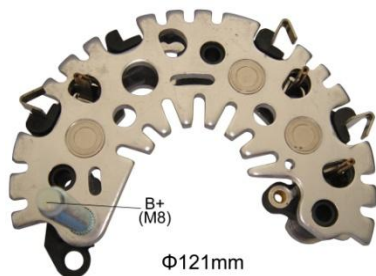

MG6301

FEATURES

Diodes: 6-50A Avalanche
 Diameter OD: 121mm
 With M8×50mm Battery Post
 Without trio
 For use on: Alfa Romeo 145,146,155
 GTV speider Fiat Bravo, Barchetta,
 Marea, Palio, Punto90, Ducato 1.9TD
 Lancia Nuova, Delta, Dedra K2.4TD

Original & X-References..

MAGNETI MARELLI
 63624201
 63320256
 MOBILETRON RI-23H
 CARGO 138377
 TRANSPO IXR642

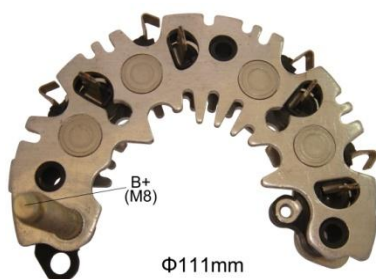

MG6302

FEATURES

Diodes: 8-50A Avalanche
 Diameter OD: 111mm
 With M8×50mm Battery Post
 For use on: Fiat Punto 55,66,75,90 TDS

Original & X-References..

MAGNETI MARELLI
 63321240
 63623701
 MOBILETRON RI-19H
 WAI 31-9338
 CARGO 138800
 TRANSPO IXR634

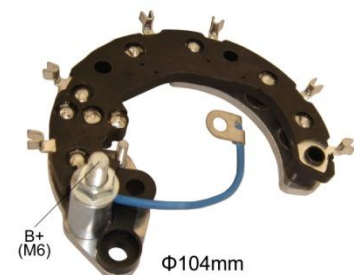

MG6303

FEATURES

Diodes: 6-35 Ampere
 Diameter OD: 104mm
 With M6×41mm Battery Post
 With M4×17mm
 With Trio
 For use on: Ford Tractor Range Rover,
 Land Rover

Original & X-References..

MAGNETI MARELLI
 84574
 MOBILETRON RI-16H
 CARGO 136740
 TRANSPO IXR542

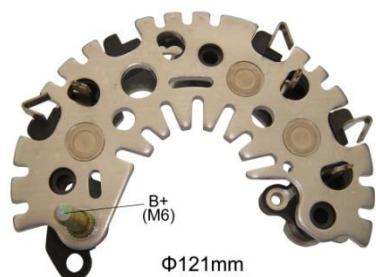

MG6304

FEATURES

Diodes: 6-50A Avalanche
 Diameter OD: 121mm
 With M6×34.5mm Battery Post

Original & X-References..

MAGNETI MARELLI
 63624202
 MOBILETRON RI-24H
 CARGO 138801
 TRANSPO IXR719

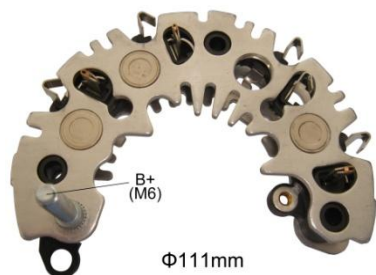

MG6305

FEATURES

Diodes: 6-35A Avalanche
 Diameter OD: 111mm
 With M6×39.5mm Battery Post

Original & X-References..

ALTERNAOTR REFERENCES
 CARGO CA1217IR
 FIAT 63341730

MG6306

Diodes: 8-50A Avalanche



MG6307

FEATURES **Original & X-References..**

Diodes: 6-35A Avalanche	MAGNETI MARELLI	
Diameter OD: 111mm	63623501	RDD33
With M8×50mm Battery Post	MOBILETRON	RI-14H
	CARGO	136423
	TRANSPO	IXR633

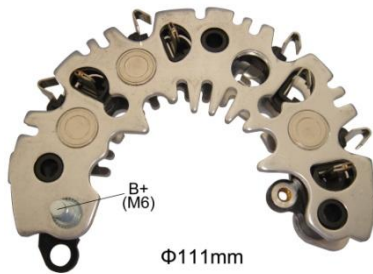

MG6309

FEATURES **Original & X-References..**

Diodes: 6-35A Avalanche	CARGO	230119
Diameter OD: 111mm		
With M6×18.5mm Battery Post		



MG6310

FEATURES **Original & X-References..**

Diodes: 8-35A Avalanche		
Diameter OD: 111mm		
With M6×18.5mm Battery Post		

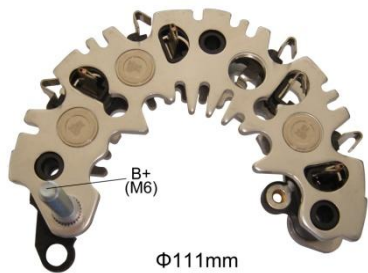

MG6311

FEATURES **Original & X-References..**

Diodes: 6-50A Avalanche		
Diameter OD: 111mm		
With M6×39.5mm Battery Post		



MG6312

FEATURES **Original & X-References..**

Diodes: 6-35A Avalanche	MAGNETI MARELLI	
Diameter OD: 111mm	63624801	
With M8×50mm Battery Post	063624701010	063624801010
Without trio	MOBILETRON	RI-21H
For use on: Fiat Punto 55,60,75,90 TDS	CARGO	139214
	TRANSPO	IXR633



MG6313

FEATURES

Diodes: 6-35A Avalanche
 Diameter OD: 111mm
 With M6×23.5mm Battery Post

Original & X-References..

ALTERNAOTR	REFERENCES
MAGNETI MARELLI	
	1201-0003
CARGO	CA1340IR
FIAT	63321679
	63341679
MOBILETRON	RI-32H
TRANSPO	IXR631

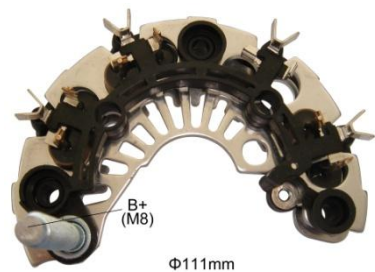

MG6314

FEATURES

Diodes: 6-35A Avalanche
 Diameter OD: 111mm
 With M8×50mm Battery Post

Original & X-References..

MAGNETI MARELLI	
	63625002
CARGO	231025

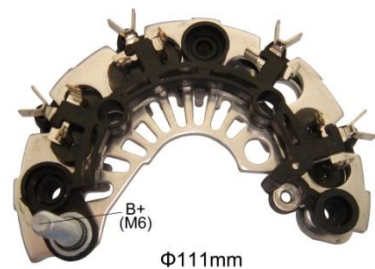

MG6316

FEATURES

Diodes: 6-35A Avalanche
 Diameter OD: 111mm
 With M6×39.5mm Battery Post

Original & X-References..

TRANSPO	IXR631
---------	--------

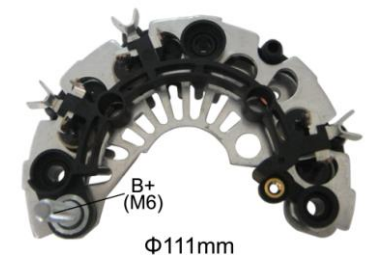

MG6322A

FEATURES

Diodes: 6-50A Avalanche
 Diameter: 111mm
 With M6×39.5mm Battery Post

Original & X-References..



MG6324A

FEATURES

Diodes: 6-50A Avalanche
 Diameter: 111mm
 With M8×49mm Battery Post

Original & X-References..



MG6317

FEATURES

Diodes: 6-35A Avalanche
 Diameter OD: 121mm
 With M8×46mm Battery Post

Original & X-References..

ALT348



MG6318

FEATURES

Diodes: 6-35A Avalanche
 Diameter OD: 111mm
 With M8×33.3mm Battery Post
 With Trio

Original & X-References..

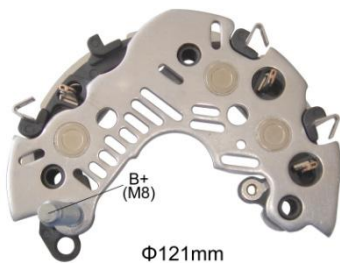

MG6319

FEATURES

Diodes: 6-50A Avalanche
 Diameter OD: 121mm
 With M8×50mm Battery Post
 Without trio

Original & X-References..

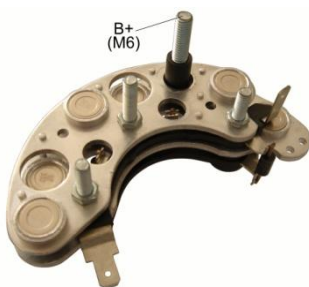

MG6401

FEATURES

Diodes: 6-35 A Avalanche
 With M6×41.7mm Battery Post
 With Trio

Original & X-References..

MAGNETI MARELLI
 0135240 0135241
 443930135240
 CARGO 134977

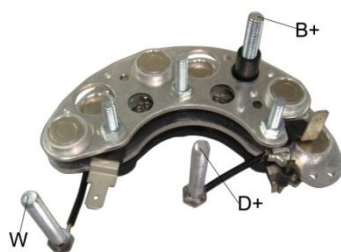

MG6402

FEATURES

Diodes: 6-35A Avalanche
 With M6×41.7mm Battery Post
 With M5×39mm Trio Post
 With M5×35mm W-Post
 With M5×35mm Mounting Post
 With Trio

Original & X-References..

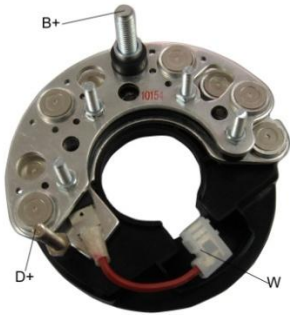

MG6403

FEATURES

Diodes: 8-50A Avalanche
 With M8×43mm Battery Post
 With M5×28mm Trio Post
 With M5×39mm Mounting Post
 With Trio

Original & X-References..

CARGO 234596



MG6405

FEATURES

Diodes:8-50 Ampere
 With M6×41.7mm Battery Post
 With Trio

Original & X-References..

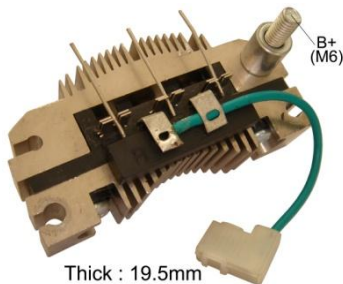

MG6901

FEATURES

Diodes: 6-25Ampere Button
 With M6×45mm Batter Post
 With M5×25mm Tighting Bolt
 With Trio
 Thick: 19.5mm
 For use on: Fiat

Original & X-References..

FIAT
 4 808 510 4 808 513 4 808 517
 4 808 518 7 541 401 7 542 145
 7 548 004 7 552 382
 MOBILETRON RI-02
 UNIPOINT REC-353
 WAI 31-9304
 CARGO 131505
 TRANSPO IXR 693

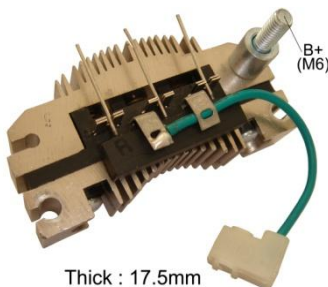

MG6902

FEATURES

Diodes: 6-25Ampere Button
 With M6×45mm Battery Post
 With Trio
 Thick: 17.5mm
 For use on: Fiat

Original & X-References..

MAGNETI MARELLI 63621501
 LUCAS 21222124 UBB 812
 WAI 31-9305
 CARGO 131391
 TRANSPO IXR692

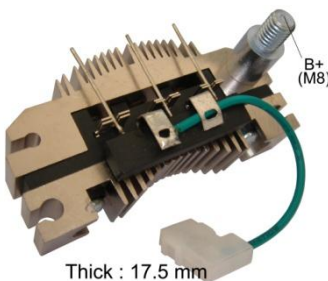

MG6903

FEATURES

Diodes: 6-25Ampere Button
 With (M8+M5)×50.5mm Battery Post
 With Trio
 Thick: 17.5 mm
 For use on: Fiat

Original & X-References..

MAGNETI MARELLI
 063622901010 63622901
 CARGO 139218
 TRANSPO IXR704

MG6903-1

Diodes:6-35A Ampere Button

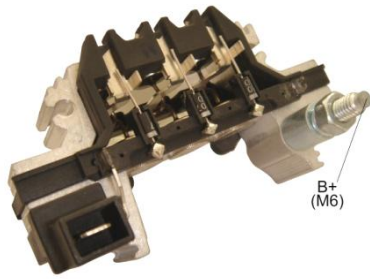

MG6904

FEATURES

Diodes: 6-35A Avalanche press fit diode
 With M6×50mm Battery Post
 With Trio

Original & X-References..

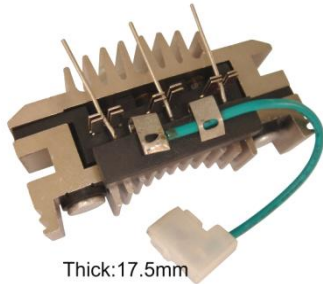

Thick:17.5mm

MG6905

FEATURES

Diodes: 6-35Ampere Button
 With Trio
 Thick:17.5mm
 For use on: Fiat

Original & X-References..

MAGNETI MARELLI	64826040	64878691
MOBILETRON	RI-01	
UNIPOINT	REC-351	REC-352
WAI	31-9302	
CARGO	130650	
TRANSPO	IXR691	



Thick:17.5mm

MG6906

FEATURES

Diodes: 6-35Ampere Button
 Without Trio
 Thick:17.5mm
 For use on: Peugeot 404,405, Renault R16,R6,Saab

Original & X-References..

MAGNETI MARELLI	690971		
VALEO	NC013	NC014	
MOBILETRON	RU-01		
UNIPOINT	REC-923		
CARGO	130634		
WAI	31-9400		
TRANSPO	IDR197		

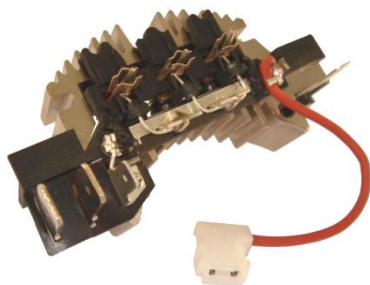

MG6907

FEATURES

Diodes: 6-25 Ampere Button
 With Trio

Original & X-References..

ISKRA	16906614
MOBILETRON	RT-19H
CARGO	231363



Thick:17.5mm

MG6908

FEATURES

Diodes: 6-35Ampere Button
 With Trio
 Thick:17.5mm
 For use on: Fiat

Original & X-References..

MOBILETRON	RU-02
TRANSPO	IDR560

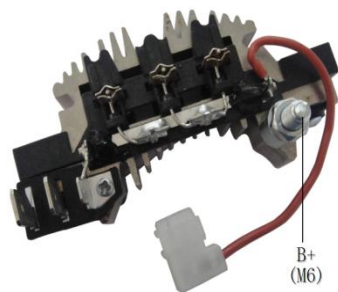
MG6911**FEATURES**

Diodes: 6-25 Ampere Button
With M6×50mm Battery Post
With Trio

Original & X-References..

TRANSPO LS12509



MIA6501

FEATURES

Diodes: 6-30 Ampere
 Mounting Length: 65mm
 With M5×49mm Battery Post
 With Trio

For use on: Ford, Mazda, Mitsubishi,
 Plymouth

Original & X-References..

MITSUBISHI	A 860 T 11970	A 860 T 13370
	A 860 T 19870	
MOBILETRON	RM-01	RM-02
	RM-15	
WAI	31-8305	
	31-8316	
CARGO	132039	136981
TRANSPO	IMR6542	

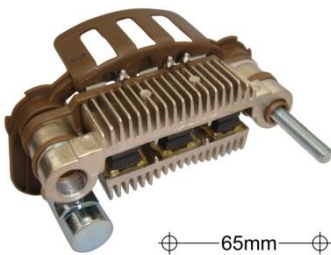

MIA6502

FEATURES

Diodes: 6-30 Ampere
 Mounting Length: 65mm
 With M5×49mm Battery Post
 With Trio

For use on: Subaru Justy

Original & X-References..

MIA6503

FEATURES

Diodes: 6-30 Ampere
 Mounting Length: 65mm
 With Trio
 For use on: Hyundai, Mitsubishi, Dodge
 Colt, Hyundai, Mitsubishi Precis,
 Mirage, Plymouth Champ

Original & X-References..

MITSUBISHI	A 860 T 16770
	A 860 T 13770
	MD611254
MOBILETRON	RM-04
WAI	31-8323
CARGO	132791
TRANSPO	IMR6548



MIA6504

FEATURES

Diodes: 6-30 Ampere
 Mounting Length: 65mm
 With M6×49.5mm Battery Post
 With Trio

For use on: Subaru Justy

Original & X-References..

MITSUBISHI	A 860 T 22770
MOBILETRON	RM-03
WAI	31-8317
CARGO	132789
TRANSPO	IMR6540



MIA6506

FEATURES

Diodes : 6-30A Ampere
 Mounting Length : 65mm
 With M8×54mm Battery Post
 With Trio
 With Capacitor

Original & X-References..





MIA7501

FEATURES

Diodes: 6-30 Ampere
 Mounting Length: 75mm
 With M5×49mm Battery Post
 With Trio

For use on: Mazda 626, B1800, B2000,
 Picjup, RX7

Original & X-References..

MITSUBISHI	
A 860 T 17570	A 860 T 17970
A 860 T 24270	A 860 T 13270
MOBILETRON	RM-08
WAI	31-8303
CARGO	132040
TRANSP0	IMR7544



MIA7502

FEATURES

Diodes: 6-30 Ampere
 Mounting Length: 75mm
 With M5×44mm Battery Post
 With Trio

For use on: Mazda 626, Pickup,RX7

Original & X-References..

MITSUBISHI	A 860 T 17570
A 860 T 17970	A 860 T 24270
A 860 T 13270	A 860 T 26970
MOBILETRON	RM-08
WAI	31-8335
CARGO	132040
TRANSP0	IMR7546



MIA7503

FEATURES

Diodes: 6-30 Ampere
 Mounting Length: 75mm
 With Trio

For use on: Chrysler Laser, Ford,
 Mitsubishi Starion

Original & X-References..

MITSUBISHI	A 860 T 17770
MD611307	A 860 T 17779
MOBILETRON	RM-11
WAI	31-8322
CARGO	133265
UNIPOINT	REC-575
TRANSP0	IMR7550



MIA7504

FEATURES

Diodes: 6-30 Ampere
 Mounting Length: 75mm
 With M6×49.5mm Battery Post
 With Trio

For use on: Mazda 626, MX-6, Ford
 Probe, Hyundai, Dodge

Original & X-References..

MITSUBISHI	A 860 T 27170
WAI	31-8320
CARGO	132469
TRANSP0	IMR7556

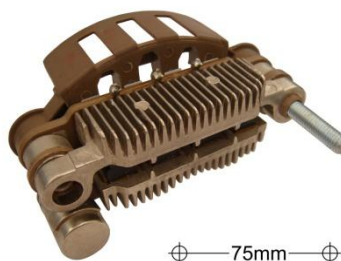

MIA7505

FEATURES

Diodes: 8-30 Ampere
 Mounting Length: 75mm
 With M6×49.5mm Battery Post
 With Trio

For use on: Geo Tracker, Suzuki
 Sidekick

Original & X-References..

MITSUBISHI	A 860 T 30370
MOBILETRON	RM-22
WAI	31-8359
CARGO	135215
TRANSP0	IMR7558

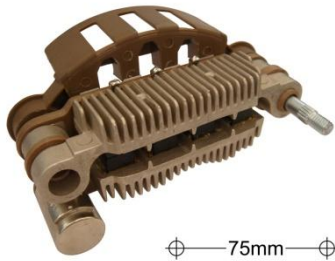

MIA7506

FEATURES

Diodes: 8-30 Ampere
 Mounting Length: 75mm
 With M5×44mm Battery Post
 With Trio

For use on: Mazda Protege

Original & X-References..

MITSUBISHI	A 860 T 32570
MOBILETRON	RM-23
WAI	31-8345
CARGO	134027
TRANSPO	IMR7562

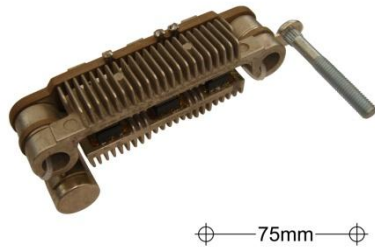

MIA7507

FEATURES

Diodes: 6-30 Ampere
 Mounting Length: 75mm
 With M6×47.5mm Battery Post
 With Trio
 For use on: Mitsubishi Galant, Mirage,
 Pajero

MIA7511

Diodes: 6-30Ampere
 Without B+ Terminal

Original & X-References..

MITSUBISHI	A 860 T 22370
	MD611479
MOBILETRON	RM-20HV
WAI	31-8375
CARGO	132468
TRANSPO	IMR7564

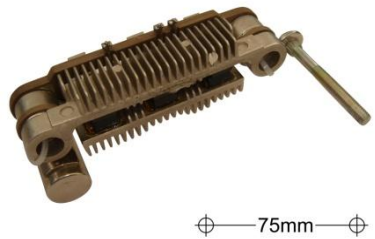

MIA7508

FEATURES

Diodes: 6-30 Ampere
 Mounting Length: 75mm
 With M5×47.5mm Battery Post
 With Trio

For use on: Mitsubishi Mirage Diesel

Original & X-References..

MITSUBISHI	A 860 T 19370
	MD611501
MOBILETRON	RM-18
CARGO	135228
TRANSPO	IMR7568



MIA7509

FEATURES

Diodes: 6-30 Ampere
 Mounting Length: 75mm
 With M5×49mm Battery Post
 With Trio
 For use on: Dodge Colt, Mitsubishi
 Mirage 1.5L

Original & X-References..

MITSUBISHI	A 860 T 24570
MOBILETRON	RM-19
WAI	31-8361
CARGO	135248
TRANSPO	IMR7570



MIA7510

FEATURES

Diodes: 6-30 Ampere
 Mounting Length:75mm
 With M5×44mm Battery Post
 With Trio
 For use on: Mazda 323

Original & X-References..

MITSUBISHI	A 860 T 27070
MOBILETRON	RM-10 RM-16
WAI	31-8344
CARGO	135247
UNITPOINT	REC-572
TRANSPO	IMR7572

MIA7512



⊕—75mm—⊕

FEATURES

Diodes: 8-30 Ampere
 Mounting Length: 75mm
 With Trio
 For use on: Honda Civic, Del Sol

Original & X-References..

MITSUBISHI	A5T04292
	A860T38570
MOBILETRON	RM-27
WAI	31-8370
CARGO	232606
TRANSPO	IMR7584

MIA7513



⊕—75mm—⊕

FEATURES

Diodes: 6-30 Ampere
 Mounting Length: 75mm
 With M6×49.5mm Battery Post
 With Trio
 For use: Mazda 929

Original & X-References..

MITSUBISHI	A860X20099
MOBILETRON	RM-24
WAI	31-8341
CARGO	136733
TRANSPO	IMR7586

MIA7514

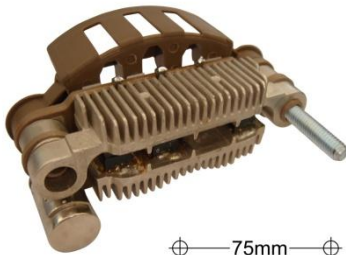

⊕—75mm—⊕

FEATURES

Diodes: 6-30 Ampere
 Mounting Length: 75mm
 With M6×49.5mm Battery Post
 With Trio
 For use on: Peugeot

Original & X-References..

MITSUBISHI	1901-0002
J&N	172-48098
TRANSPO	IMR7596

MIA7515



⊕—75mm—⊕

FEATURES

Diodes: 6-30 Ampere
 Mounting Length: 75mm
 With M6×49.5mm Battery Post
 With Trio

Original & X-References..

MIA7516



⊕—75mm—⊕

FEATURES

Diodes: 6-30 Ampere
 Mounting Length: 75mm
 With M8×59.5mm Battery Post
 With Trio

Original & X-References..

MITSUBISHI	A860T46570
	MD61884
MOBILETRON	RM-124
TRANSPO	IMR7588

For use on: 1993-94 Mazda Mitsubishi



⊕—75mm—⊕

MIA7517

FEATURES

Diodes: 6-30 Ampere
 Mounting Length: 75mm
 With Trio

For use on: Mitsubishi, Dodge Truck,
 Plymouth

Original & X-References..

LUCAS	21513132
MITSUBISHI	A860T13170
	A860T16970
	MD607917
MOBILETRON	RM-07
WAI	31-8301
CARGO	132466
TRANSPO	IMR7542

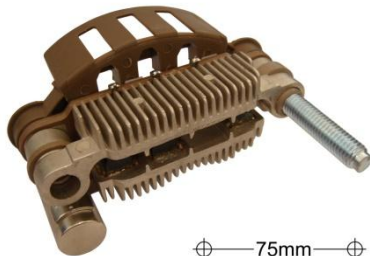

⊕—75mm—⊕

MIA7518

FEATURES

Diodes: 6-30 Ampere
 Mounting Length: 75mm
 With M8×59.5mm Battery Post
 With Trio

Original & X-References..

TRANSPO	IMR7588
---------	---------

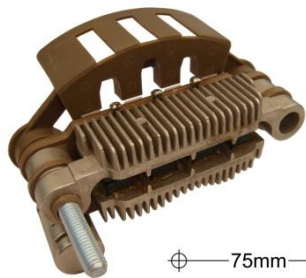

⊕—75mm—⊕

MIA7519

FEATURES

Diodes: 8-30 Ampere
 Mounting Length: 75mm
 With M6×49.5mm Battery Post
 With Trio

Original & X-References..



⊕—75mm—⊕

MIA7520

FEATURES

Diodes: 6-30 Ampere
 Mounting Length: 75mm
 With M6×47.5mm Battery Post
 With Trio

Original & X-References..

4D55



⊕—75mm—⊕

MIA7521

FEATURES

Diodes: 8-30 Ampere
 Mounting Length: 75mm
 With M6×49.5mm Battery Post
 With Trio

Original & X-References..

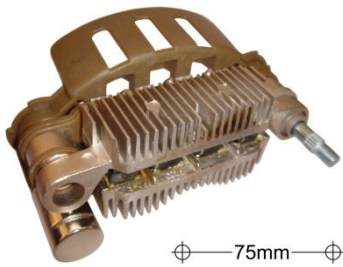

MIA7522

FEATURES

Diodes: 8-30 Ampere
 Mounting Length: 75mm
 With M5×44mm Battery Post
 With Trio
 For use on: Honda Civic

Original & X-References..

MITSUBISHI	A866X45281
	A5T06391
MOBILETRON	RM-28
WAI	31-8371
TRANSPO	IMR7576



MIA7523

FEATURES

Diodes: 6-30 Ampere
 Mounting Length: 75mm
 With Trio
 For use on: Nissan 200SX, Pulsar,
 Maxima, Stanza

Original & X-References..

MITSUBISHI	A860T17270
MOBILETRON	RM-09
NISSAN	2312408E16
WAI	31-8319
CARGO	132467
TRANSPO	IMR7548

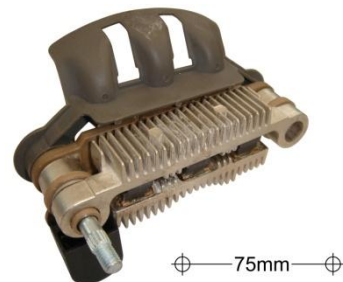

MIA7524

FEATURES

Diodes: 6-30 Ampere
 Mounting Length: 75mm
 With M5×44mm Battery Post
 With Trio
 For use on: Nissan, Mazda323, Mazda
 MX, Mercury Tracer

Original & X-References..

MITSUBISHI	A860T20270
NISSAN	2312458L10
MOBILETRON	RM-12
WAI	31-8324
CARGO	132792
TRANSPO	IMR7552



MIA7525

FEATURES

Diodes: 6-30 Ampere
 Mounting Length: 75mm
 With M6×49.5mm Battery Post
 With Trio
 For use on: Nissan 300ZXr

Original & X-References..

MITSUBISHI	A860T16470
NISSAN	2312442L71
MOBILETRON	RM-17
WAI	31-8342
CARGO	133539
TRANSPO	IMR7554

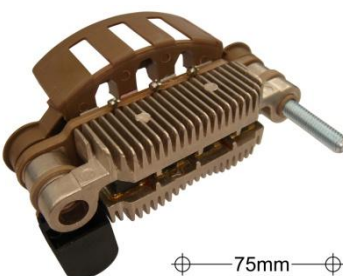

MIA7526

FEATURES

Diodes: 8-30 Ampere
 Mounting Length: 75mm
 With M6×49.5mm Battery Post
 With Trio
 For use on: Nissan Pulsar

Original & X-References..

MITSUBISHI	A860T27270
	A860X27299
MOBILETRON	RM-14
WAI	31-8337
CARGO	134295
TRANSPO	IMR7560

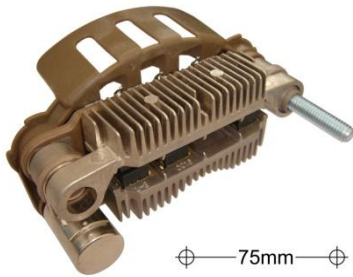

MIA7527

FEATURES

Diodes: 6-30 Ampere
 Mounting Length: 75mm
 With M6×49.5mm Battery Post
 With Trio

Original & X-References..

MITSUBISHI A5T05091 A5T07092 A860T39770 LESTER WAI TRANSPO	A5T03391 A5T07091 A5TA0391 13336 13587 13415 31-8376 IMR7582
--	--

For use on: Mitsubishi 50-70 Amp IR/IF Alternators

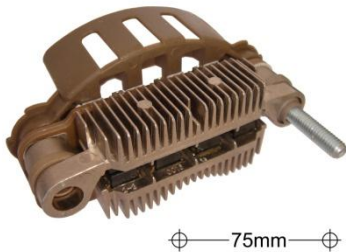

MIA7529

FEATURES

Diodes: 8-30Ampere
 Mounting Length: 75mm
 With M6×49.5mm Battery Post
 Without Trio

Original & X-References..

MITSUBISHI MOBILETRON CARGO TRANSPO	A860X83370 RM-136 235297 IMR7579
--	---

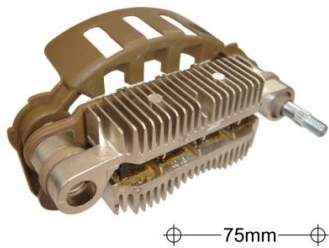

MIA7530

FEATURES

Diodes: 8-30A Avalanche
 Mounting Length: 75mm
 With M5×44mm Battery Post
 Without Trio

Original & X-References..

MITSUBISHI CARGO	A005TA6392C CA16651IR 235526
---------------------	------------------------------------



MIA7531

FEATURES

Diodes: 6-30A Avalanche
 Mounting Length: 75mm
 With M5×44mm Battery Post
 Without Trio

Original & X-References..

MITSUBISHI CARGO	A001TA3392C CA1832IR 236741
---------------------	-----------------------------------

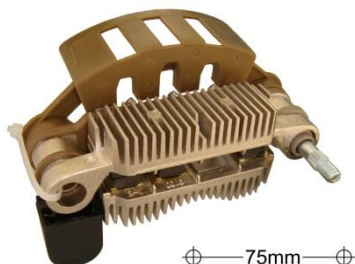

MIA7532

FEATURES

Diodes: 6-30Ampere
 Mounting Length: 75mm
 With M5×44mm Battery Post
 With Trio

Original & X-References..

WAI MITSUBISHI TRANSPO	31-8360 A5T01577 A5T03677 IMR7580
------------------------------	--



⊕ — 75mm — ⊕

MIA7533

FEATURES

Diodes: 8-35Ampere
 Mounting Length: 75mm
 With M5×44mm Battery Post
 Without Trio

Original & X-References..

MITSUBISHI	1901-0053
MOBILETRON	RM-145
TRANSPO	IMR7581



⊕ — 75mm — ⊕

MIA7535

FEATURES

Diodes: 6-30A Avalanche
 Mounting Length: 75mm
 With M5×44mm Battery Post
 Without Trio

Original & X-References..

1901-0021



⊕ — 75mm — ⊕

MIA7536

FEATURES

Diodes: 6-30A Avalanche
 Mounting Length : 75mm
 With M5×44mm Battery Post
 Without Trio
 Without Capacitor

Original & X-References..

CARGO	235527
-------	--------



⊕ — 75mm — ⊕

MIA7537

FEATURES

Diodes : 8-30A Ampere
 Mounting Length : 75mm
 With M6×49.5mm Battery Post
 Without Trio
 Without Capacitor

Original & X-References..

MITSUBISHI	A5TA7091
GAUSS	GA1383



⊕ — 75mm — ⊕

MIA7538

FEATURES

Diodes : 6-30A Ampere
 Mounting Length : 75mm
 With M6×49.5mm Battery Post
 Without Trio
 Without Capacitor

Original & X-References..

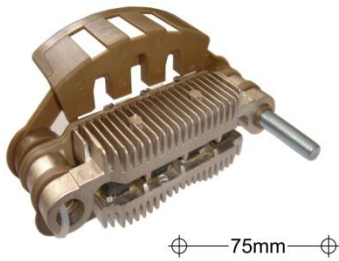

MIA7540

FEATURES

Diodes:8-30A Ampere
 Mounting Length : 75mm
 With M6×49.5mm Battery Post
 Without Capacitor
 Without Trio

Original & X-References..

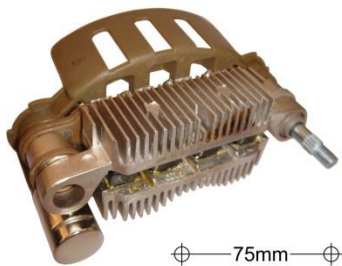

MIA7542

FEATURES

Diodes:6-30A Ampere
 Mounting Length : 75mm
 With M5×44mm Battery Post
 With Trio
 With Capacitor

Original & X-References..

MITSUBISHI	1901-0005
TRANSPO	IMR7590



MIA7543

FEATURES

Diodes:8-30A Ampere
 Mounting Length : 75mm
 With M6×49.5mm Battery Post
 Without Trio
 With Capacitor

Original & X-References..

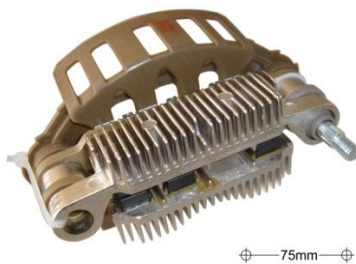

MIA7544

FEATURES

Diodes: 6-30A Ampere
 Mounting Length: 75mm
 With M5×41mm Battery Post
 Without Trio
 Without Capacitor

Original & X-References..



MIA7545

FEATURES

Diodes: 6-30A Ampere
 Mounting Length: 75mm
 With M5×44mm Battery Post
 Without Trio
 Without Capacitor

Original & X-References..

MITSUBISHI	A860X70970
MOBILETRON	RM-129A
TRANSPO	IMR75816

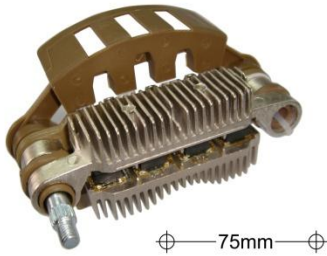

MIA7546

FEATURES

Diodes: 8-30A Avalanche
 Mounting Length: 75mm
 With M5×44mm Battery Post
 Without Trio
 Without Capacitor

Original & X-References..

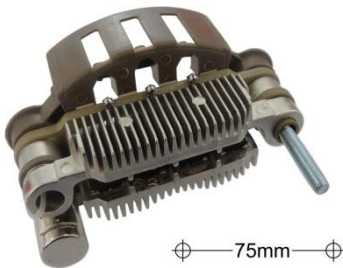

MIA7549

FEATURES

Diodes:8-30A Ampere
 Mounting Length: 75mm
 With M5×49mm Battery Post
 With Trio
 With Capacitor

Original & X-References..

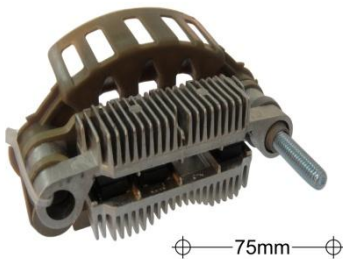

MIA7550

FEATURES

Diodes:6-30A Ampere
 Mounting Length: 75mm
 With M6×49.5mm Battery Post
 Without Trio
 Without Capacitor

Original & X-References..

JA1181IR

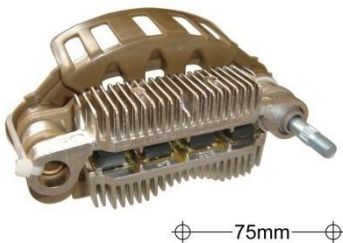

MIA7552

FEATURES

Diodes:8-30A Avalanche
 Mounting Length: 75mm
 With M5×41mm Battery Post
 Without Trio
 Without Capacitor

Original & X-References..



MIA7553

FEATURES

Diodes:6-30Ampere
 Diameter OD: 75mm
 With M5×44mm Battery Post
 With Trio/Capacitor

Original & X-References..

TRANSP0 IMR7580

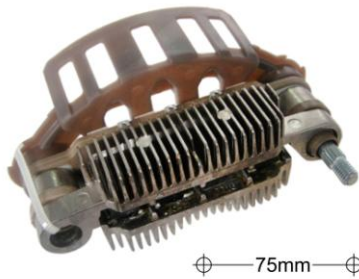

MIA7555

FEATURES

Diodes : 6-30 A Ampere
 Mounting Length: 75mm
 With M5×41mm Battery Post
 Without Trio

Original & X-References..



MIA7557

FEATURES

Diodes: 8-30 Ampere
 Mounting Length: 75mm
 With M5×44mm Battery Post
 With Trio/Capacitor

Original & X-References..

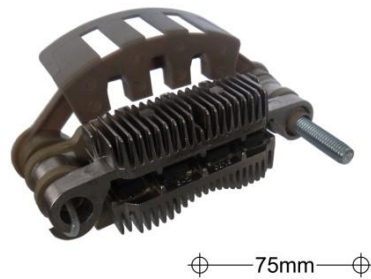

MIA7559

FEATURES

Diodes: 8-30 Ampere
 Mounting Length: 75mm
 With M6×49.5mm Battery Post
 Without Trio/Capacitor

Original & X-References..

MITSUBISHI	A860X83370
MOBILETRON	RM-136
CARGO	235297
TRANSPO	IMR7579

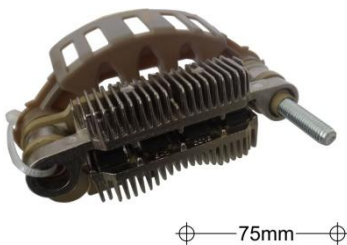

MIA7560

FEATURES

Diodes: 8-30 Ampere
 Mounting Length: 75mm
 With M6×49.5mm Battery Post
 Without Trio/Capacitor

Original & X-References..

13893



MIA7601

FEATURES

Diodes: 8-30 Ampere
 Mounting Length: 76mm
 With Trio

Original & X-References..

MIA7602



⊕ — 76mm — ⊕

FEATURES

Diodes: 8-30 Ampere
 Mounting Length: 76mm
 With M5x49mm Battery Post
 With Trio

Original & X-References..

MIA8501

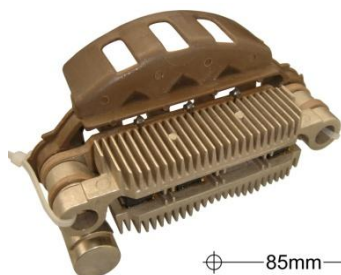

⊕ — 85mm — ⊕

FEATURES

Diodes: 6-30Ampere
 Mounting Length: 85mm
 With Trio
 For use on: Ford Tempo, Taurus,
 Mercury Topaz, Sable

Original & X-References..

MITSUBISHI	A 860 T 28670
WAI	31-8318
CARGO	134297
MOBILETRON	RM-29
TRANSPO	IMR8540

MIA8502

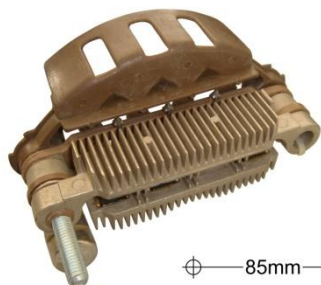

⊕ — 85mm — ⊕

FEATURES

Diodes: 6-30Ampere
 Mounting Length: 85mm
 With M6x49.5mm Battery Post
 With Trio
 For use on: Ford Thunderbird

Original & X-References..

FORD	E8PZ10304A
WAI	31-8327
MOBILETRON	RM-30
CARGO	233511
TRANSPO	IMR8542

MIA8512

Diodes: 8-30 Ampere

1901-0013	
TRANSPO	IMR85104

MIA8503

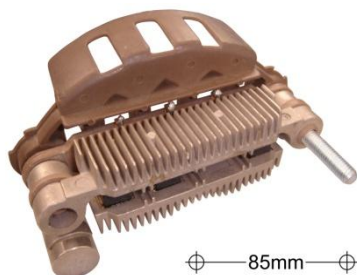

⊕ — 85mm — ⊕

FEATURES

Diodes: 6-30 Ampere
 Mounting Length: 85mm
 With M6x49.5mm Battery Post
 With Trio
 For use on: Mazda MPV

Original & X-References..

MITSUBISHI	A 860 T 31370	A 860 T 34070
WAI		31-8336
MOBILETRON		RM-31
CARGO		135041
TRANSPO		IMR8544
		IMR8546
CARGO		135042
TRANSPO		IMR8574
CARGO		135042

MIA8511

Diodes: 8-30 Ampere

MIA8505

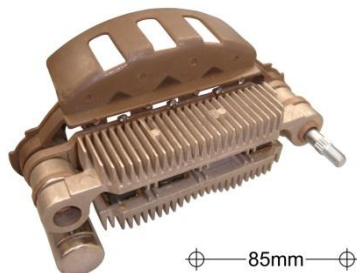

⊕ — 85mm — ⊕

FEATURES

Diodes: 6-30 Ampere
 Mounting Length: 85mm
 With M5x44mm Battery Post
 With Trio
 For use on: Ford Escort, Mazda 323

Original & X-References..

MITSUBISHI	A 860 T 38270
	B36618W60A
WAI	31-8380
CARGO	136977
MOBILETRON	RM-38
TRANSPO	IMR8548

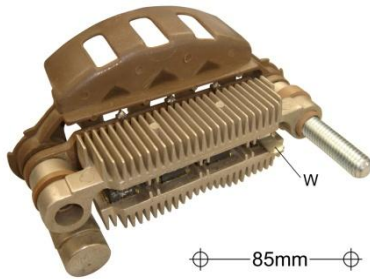

MIA8506

FEATURES

Diodes: 8-30 Ampere
 Mounting Length: 85mm
 With M8×54mm Battery Post
 With Trio

Original & X-References..

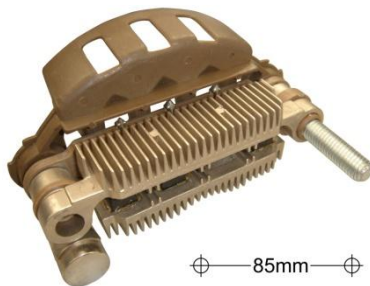

MIA8507

FEATURES

Diodes: 6-30 Ampere
 Mounting Length: 85mm
 With M8×54mm Battery Post
 With Trio
 For use on: Mazda 626, MX6

MIA8524

Diodes: 6-30 Ampere
 Without Trio
MIA8508 8-30 Ampere

Original & X-References..

SAS COMPONENTS	7709
mitsubishi	A860T32170
MOBILETRON	RM-37
WAI	31-8350
CARGO	137861
TRANSPO	IMR8580
TRANSPO	IMR8582
1901-0006	

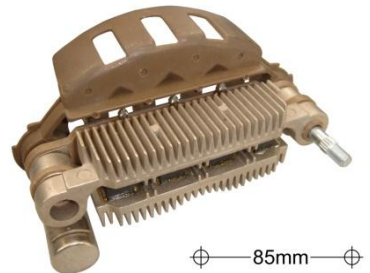

MIA8509

FEATURES

Diodes: 6-30 Ampere
 Mounting Length: 85mm
 With M5×44mm Battery Post
 Without Trio
 For use on: Subaru XT

MIA8510

Diodes: 8-30 Ampere
 With Trio

Original & X-References..

RENARD	11399	19710
WAI	31-8388	
CARGO	135249	
MOBILETRON	RM-33	
TRANSPO	IMR8572	

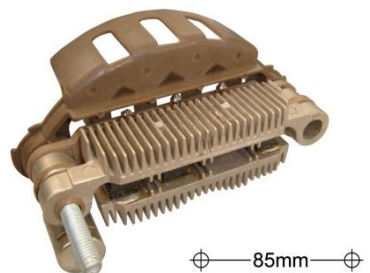

MIA8513

FEATURES

Diodes: 6-30 Ampere
 Mounting Length: 85mm
 With M6×49.5mm Battery Post
 With Trio

For use on: Subaru XT

Original & X-References..

mitsubishi	A2T14591
	A2T28792
TRANSPO	IMR85106

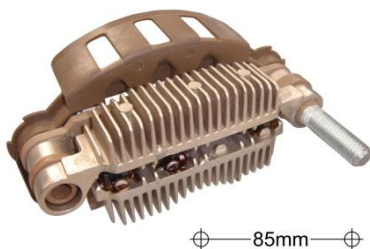

MIA8514

FEATURES

Diodes: 6-30 Ampere
 Mounting Length: 85mm
 With M8×54mm Battery Post
 Without Capacitor
 Without Trio
 For use on: Mazda Protege

MIA8530

Diodes: 8-30 Ampere

Original & X-References..

mitsubishi	A860T57870
MOBILETRON	RM-110HV
WAI	31-8382
CARGO	138873
LESTER	13718
TRANSPO	IMR8566
	IM341
TRANSPO	IMR85668

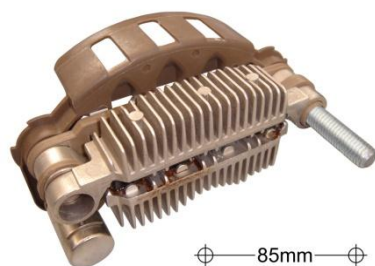

MIA8515

FEATURES

Diodes: 6-30 Ampere
 Mounting Length: 85mm
 With M8×54mm Battery Post
 With Trio
 For use on: Mitsubishi Eclipse, Eagle
 Talon

Original & X-References..

mitsubishi A2TA08912C
 WAI 31-8363
 TRANSPO IMR8588

MIA8517 8-30 Ampere

mitsubishi A 860 T 42670
 TRANSPO IMR8594

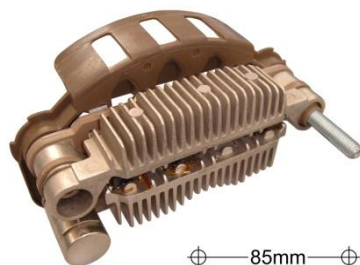

MIA8516

FEATURES

Diodes: 6-30 Ampere
 Mounting Length: 85mm
 With M6×49.5mm Battery Post
 With Trio
 For use on: Chrysler Imports,
 Mitsubishi

Original & X-References..

mitsubishi A 860 T 38770
 MD618568
 WAI 31-8367
 CARGO 136979
 MOBILETRON RM-36 RM-57
 TRANSPO IMR8590
 IM832

MIA8547 8-30 Ampere

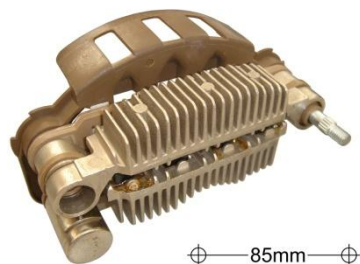

MIA8518

FEATURES

Diodes: 8-30 Ampere
 Mounting Length: 85mm
 With M5×44mm Battery Post
 With Trio

Original & X-References..

mitsubishi A860T38970
 WAI 31-8381
 CARGO 135948
 MOBILETRON RM-58
 TRANSPO IMR85100

For use on: Mazda 626

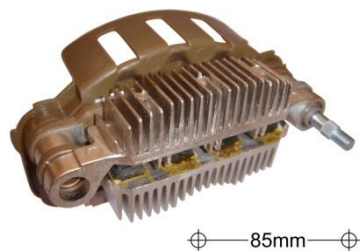

MIA8519

FEATURES

Diodes: 8-30 Ampere
 Mounting Length: 85mm
 With M5×44mm Battery Post
 Without Capacitor
 Without Trio

Original & X-References..

LESTER 13889
 TRANSPO IMR8599

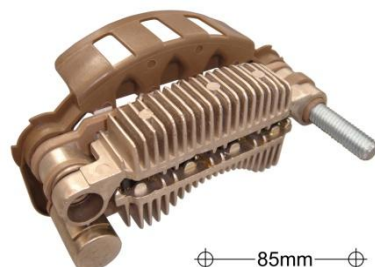

MIA8521

FEATURES

Diodes: 8-30 Ampere
 Mounting Length: 85mm
 With M8×54mm Battery Post
 With Trio

Original & X-References..

mitsubishi A860T42670
 CARGO 137076
 TRANSPO IMR8594

MIA8525

Diodes: 6-30 Ampere

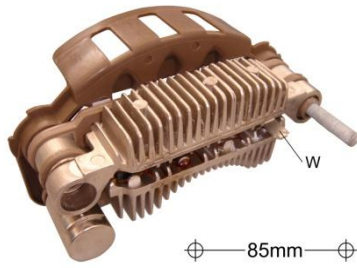

MIA8526

FEATURES

Diodes: 6-30 Ampere
 Mounting Length: 85mm
 With M5×49mm Battery Post
 With "W" Terminal
 With Trio
 With Capacitor
MIA8520
 Without "W" Terminal

Original & X-References..

CARGO 136552

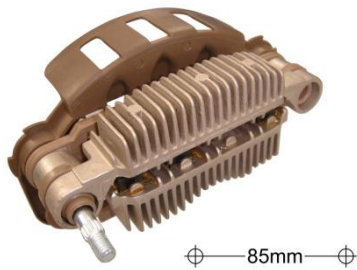

MIA8527

FEATURES

Diodes: 6-30 Ampere
 Mounting Length: 85mm
 With M5×44mm Battery Post
 Without Trio/Capacitor

Original & X-References..

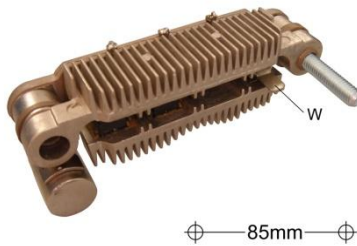

MIA8528

FEATURES

Diodes: 6-30 Ampere
 Mounting Length: 85mm
 With M6×49.5mm Battery Post
 With "W" Terminal
 With Trio

Original & X-References..

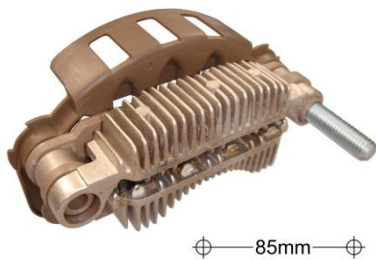

MIA8529

FEATURES

Diodes: 6-30 Ampere
 Mounting Length: 85mm
 With M8×54mm Battery Post
 With Trio
 Without Capacitor

Original & X-References..

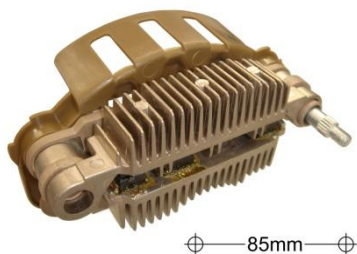

MIA8531

FEATURES

Diodes: 6-30 Ampere
 Mounting Length: 85mm
 With M5×44mm Battery Post
 Without Trio/Capacitor

Original & X-References..

mitsubishi A860X61970
 MOBILETRON RM-130
 TRANSPO IMR8567

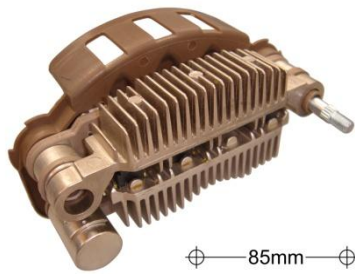

MIA8532

FEATURES

Diodes: 6-35 A Avalanche
 Mounting Length: 85mm
 With M5×44mm Battery Post
 Without Trio

Original & X-References..

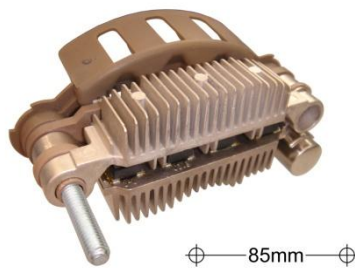

MIA8533

FEATURES

Diodes: 8-30 Ampere
 Mounting Length: 85mm
 With M6×49.5mm Battery Post
 Without Trio
 For use on: Avenger,
 Cirrus, Neon, Sebring
MIA8537 6-30 Ampere
 With M6×60mm Battery Post
MIA8538 8-30 Ampere
 With Trio

Original & X-References..

MITSUBISHI	
A2T81192	A2T3791
A2TA749	A2T7491
WAI	31-8374
TRANSPO	IMR8597
TRANSPO	IMR8596
TRANSPO	IMR8598

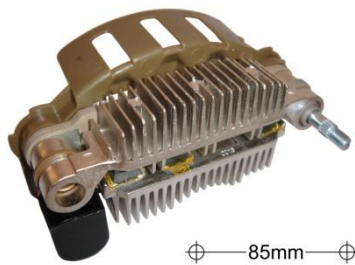

MIA8534

FEATURES

Diodes: 6-30 Ampere
 Mounting Length: 85mm
 With M5×44mm Battery Post
 With Trio
 For use on: Ford, Mazda

Original & X-References..

MITSUBISHI	A860T39170
WAI	31-8351
MOBILETRON	RM-39
CARGO	136978
TRANSPO	IMR8592

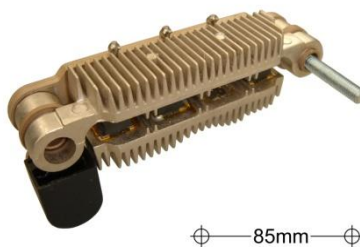

MIA8535

FEATURES

Diodes: 6-30 Ampere
 Mounting Length: 85mm
 With M5×49mm Battery Post
 With Trio

Original & X-References..

MITSUBISHI	A860T29370
TRANSPO	IMR8578

For use on: Mitsubishi

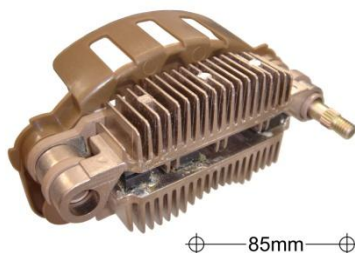

MIA8536

FEATURES

Diodes: 6-30 Ampere
 Mounting Length: 85mm
 With M6×43.5mm Battery Post
 Without Trio/Capacitor

Original & X-References..

MITSUBISHI	A2TB2991
MOBILETRON	RM-135
TRANSPO	IMR8595

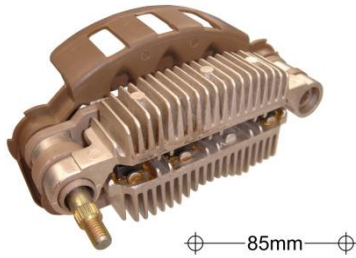

MIA8539

FEATURES

Diodes: 6-30 Ampere
 Mounting Length: 85mm
 With M5×44mm Battery Post
 Without Trio
 Without Capacitor

Original & X-References..

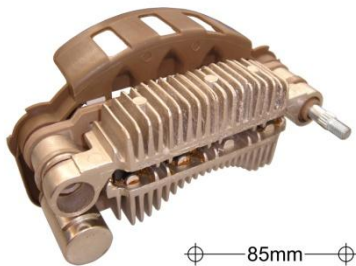

MIA8540

FEATURES

Diodes: 6-30 Ampere
 Mounting Length: 85mm
 With M5×44mm Battery Post
 With Trio

Original & X-References..

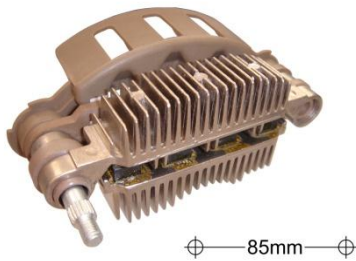

MIA8541

FEATURES

Diodes: 8-30A Avalanche
 Mounting Length: 85mm
 With M5×44mm Battery Post
 Without Trio
 Without Capacitor

Original & X-References..

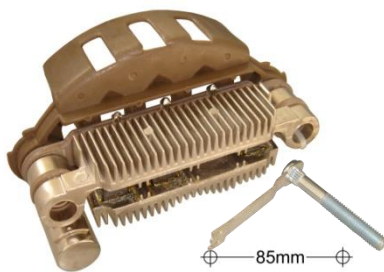

MIA8542

FEATURES

Diodes: 6-30 Ampere
 Mounting Length: 85mm
 With M6×47.5mm Battery Post
 With Trio
 With Capacitor

Original & X-References..

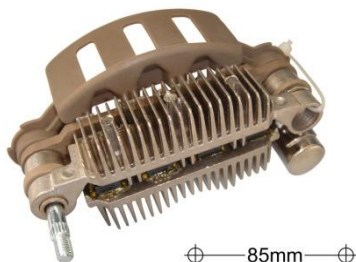

MIA8544

FEATURES

Diodes: 8-30Ampere
 Mounting Length: 85mm
 With M5×44mm Battery Post
 With Trio
 With Capacitor

Original & X-References..

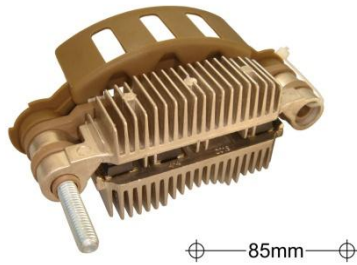

MIA8545

FEATURES

Diodes: 6-30Ampere
 Mounting Length: 85mm
 With M6×49.5mm Battery Post
 With Trio

Original & X-References..

LESTER 13735

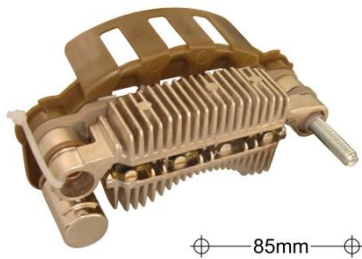

MIA8546

FEATURES

Diodes: 6-30Ampere
 Mounting Length: 85mm
 With M6×49.5mm Battery Post
 With Trio

Original & X-References..

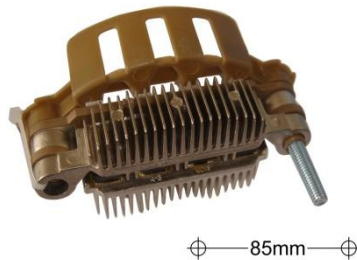

MIA8549

FEATURES

Diodes : 8-30A Ampere
 Mounting Length :85mm
 With M6×49.5mm Battery Post
 Without Trio
 Without Capacitor

Original & X-References..

HONDA 31127-PGM-004
 MOBILETRON RM-154HV
 TRANSPO IMR8585

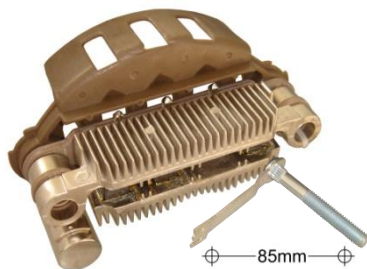

MIA8551

FEATURES

Diodes : 8-30A Ampere
 Mounting Length :85mm
 With M6×47.5mm Battery Post
 With Trio
 With Capacitor

Original & X-References..

MITSUBISHI ME701716

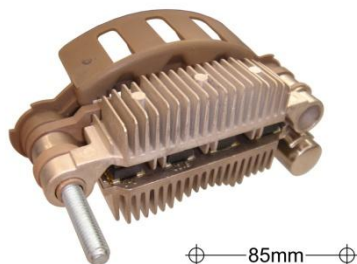

MIA8552

FEATURES

Diodes : 8-30A Ampere
 Mounting Length :85mm
 With M6×60mm Battery Post
 Without Trio
 With Capacitor

Original & X-References..

WAGNER W065-168
 CHRYLER 4609101
 LESTER 13575
 TRANSPO IMR8597

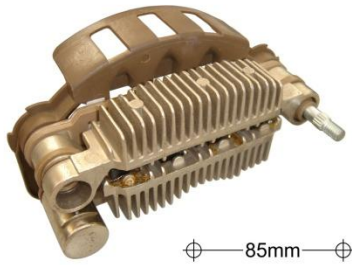

MIA8553

FEATURES

Diodes:6-30A Ampere
 Mounting Length : 85mm
 With M5×44mm Battery Post
 With Trio
 With Capacitor

Original & X-References..

MOBILETRON RM-94
 MITSUBISHI A860T06870

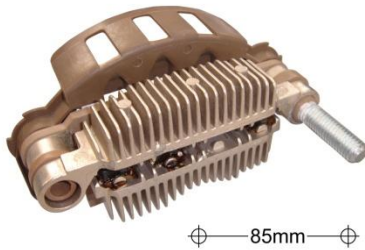

MIA8554

FEATURES

Diodes:6-30A Avalanche
 Mounting Length : 85mm
 With M8×54mm Battery Post
 Without Capacitor
 Without Trio

Original & X-References..

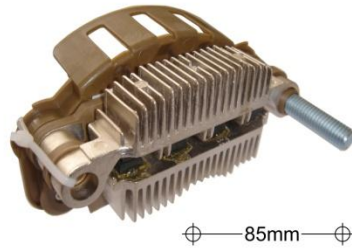

MIA8555

FEATURES

Diodes:8-30A Avalanche
 Mounting Length : 85mm
 With M8×54mm Battery Post
 Without Capacitor
 Without Trio

Original & X-References..

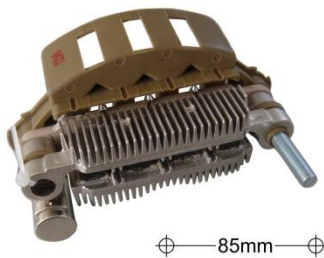

MIA8556

FEATURES

Diodes :8-30 Ampere
 Mounting Length : 85mm
 With M6×49.5mm Battery Post
 With Trio
 With Capacitor

Original & X-References..

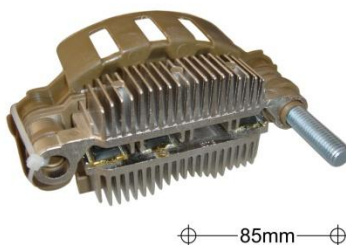

MIA8558

FEATURES

Diodes:6-30 Ampere
 Mounting Length : 85mm
 With M8×54mm Battery Post
 With Trio

Original & X-References..

MITSUBISHI A002TA8891
 CARGO GA1340

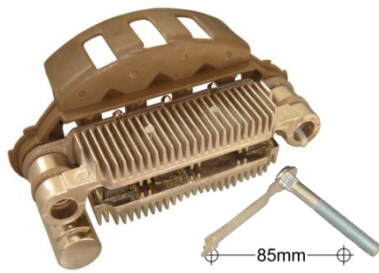

MIA8559

FEATURES

Diodes:6-30A Ampere
 Mounting Length : 85mm
 With M8×49mm Battery Post
 With Trio
 With Capacitor

Original & X-References..

mitsubishi ME202971

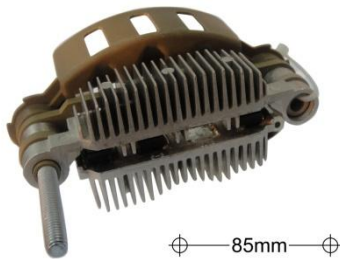

MIA8564

FEATURES

Diodes:6-30A Ampere
 Mounting Length: 85mm
 With M6×60mm Battery Post
 Without Trio
 Without Capacitor

Original & X-References..

LESTER 13735
 WAI 31-8384
 TRANSP0 IMR8568

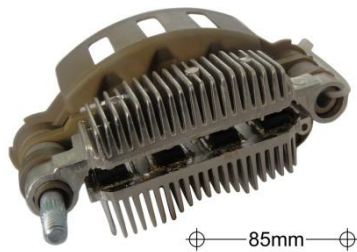

MIA8565

FEATURES

Diodes:8-30A Ampere
 Mounting Length: 85mm
 With M6×43.5mm Battery Post
 Without Trio
 Without Capacitor

Original & X-References..

mitsubishi A860X45170
 TRANSP0 IMR8575



MIA8567

FEATURES

Diodes: 6-30 Ampere
 Mounting Length: 85mm
 With M6×49.5mm Battery Post
 With Trio/Capacitor

Original & X-References..

MIA8568

With M5×44mm Battery Post



MIA8569

FEATURES

Diodes : 8-30 A Ampere
 Mounting Length: 85mm
 With M6×49.5mm Battery Post
 With Trio/Capacitor

Original & X-References..

mitsubishi A4TU3599

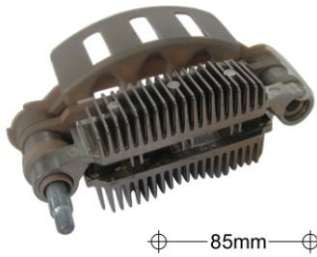

MIA8570A

FEATURES

Diodes : 6-30 A Avalanche
 Mounting Length: 85mm
 With M5×44mm Battery Post

Original & X-References..

MITSUBISHI	A2TG1081ZT
MOBILETRON	RM-161HV
NISSAN	23100-2NAOA-1

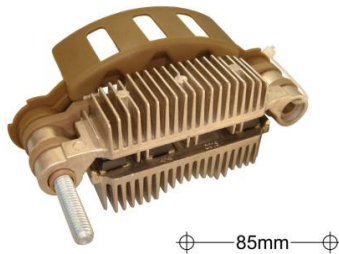

MIA8571

FEATURES

Diodes: 6-30 Ampere
 Mounting Length: 85mm
 With M6×49.5mm Battery Post

Original & X-References..

LESTER	13735
WAI	31-8384
TRANSPO	IMR8568

For use on: (2001-98) Dodge, Plymouth

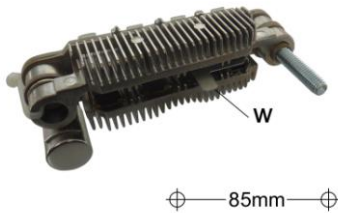

MIA8572

FEATURES

Diodes: 8-30A Ampere
 Diameter: 85mm
 With M6×49.5mm Battery Post
 With "W" Terminal
 With Trio/Capacitor

Original & X-References..

DIESEL	A4TU5486
--------	----------

MIA8574

With M5×44mm Battery Post



MIA8575

FEATURES

Diodes: 8-30 Ampere
 Mounting Length: 85mm
 With M8×59.5mm Battery Post
 With "W" Terminal
 With Trio/Capacitor

Original & X-References..

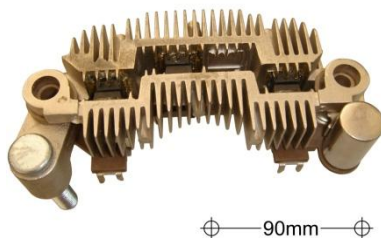

MIA9001

FEATURES

Diodes: 6-30 A Avalanche
 Mounting Length: 90mm
 With M8×45.6mm Battery Post
 With Trio
MIA9002 8-30A Avalanche
MIA9006
MIA9008
 Diodes :6-30A Ampere
MIA9008
 Diodes:8-30A Ampere

Original & X-References..

1601-0008	
TRANSPO	IYR9028
CARGO	234653
TRANSPO	IYR9003
VALEO	TA000A48401
	TA000A48402

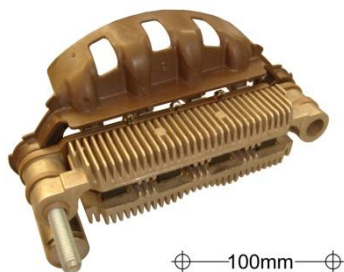

MIA10001

FEATURES

Diodes: 8-30 Ampere
 Mounting Length: 100mm
 With M6×49.5mm Battery Post
 With Trio
 For use on: Ford Thunderbird, Mercury Cougar, Hyundai Alliance

Original & X-References..

MITSUBISHI	A860T35270
FORD	E9PZ10304B
MOBILETRON	RM-41
WAI	31-8329
CARGO	135252
TRANSP0	IMR10040

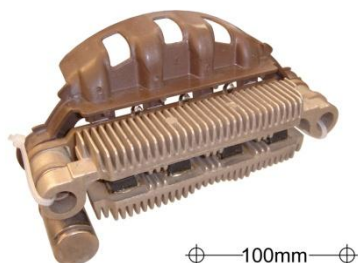

MIA10002

FEATURES

Diodes: 8-30 Ampere
 Mounting Length: 100mm
 With Trio
 For use on: Mitsubishi Van & Wagon, Dodge Eagle, Chrysler Imports

Original & X-References..

MITSUBISHI	A 860 T 23070	A 860 T 28070
	MD602227	MD611564
MOBILETRON	RM-40	
WAI	31-8325	
CARGO	132793	
TRANSP0	IMR10042	

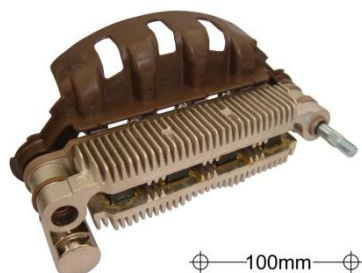

MIA10003

FEATURES

Diodes: 8-30 Ampere
 Mounting Length: 100mm
 With M5×44mm Battery Post
 With Trio

Original & X-References..

MITSUBISHI	A 860 T 30170
MOBILETRON	RM-42
WAI	31-8338
CARGO	135229
TRANSP0	IMR10044

For use on: Subaru XT

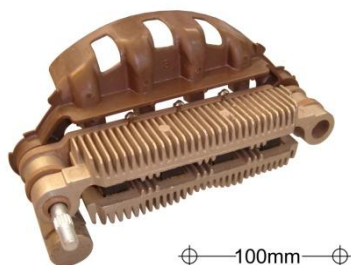

MIA10004

FEATURES

Diodes: 8-30 Ampere
 Mounting Length: 100mm
 With M5×44mm Battery Post
 With Trio
 With Capacitor

Original & X-References..

MIA10075

With M6×49.5mm Battery Post

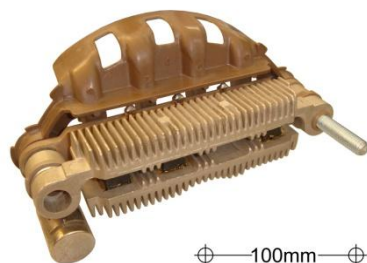

MIA10005

FEATURES

Diodes: 6-30 Ampere
 Mounting Length: 100mm
 With M6×49.5mm Battery Post
 With Trio/Capacitor
 For use on: Mitsubishi 3000GT, Diamante

Original & X-References..

MITSUBISHI	A 860 T 36070
	MD618422
CARGO	139269
TRANSP0	IMR10048

MIA10006

Diodes: 8-30Ampere

MITSUBISHI	A860T23370
CARGO	137486
TRANSP0	IMR10050

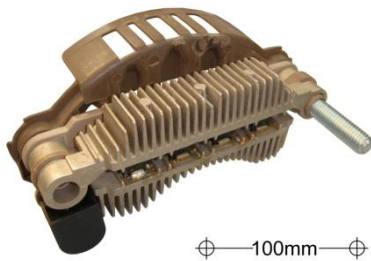

MIA10007

FEATURES

Diodes: 8-30 Ampere
 Mounting Length: 100mm
 With M8×54mm Battery Post
 With Trio/Capacitor
 For use on: Ford Taurus SHO

Original & X-References..

MITSUBISHI	A 860 T 42070
MOBILETRON	RM-48
WAI	31-8358
CARGO	135900
TRANSPO	IMR10060

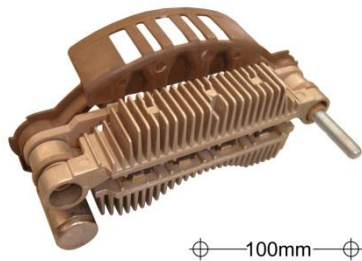

MIA10008

FEATURES

Diodes: 8-30Ampere
 Mounting Length: 100mm
 With M6×49.5mm Battery Post
 With Trio/Capacitor
 For use on: Ford Taurus SHO

Original & X-References..

MITSUBISHI	A 860 T 42070
MOBILETRON	RM-47
WAI	31-8357
TRANSPO	IMR10062

MIA10038

Diodes: 6-30Ampere

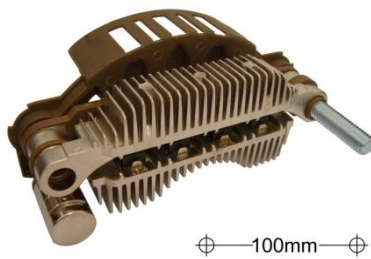

MIA10009

FEATURES

Diodes: 8-30 Ampere
 Mounting Length: 100mm
 With M8×54mm Battery Post
 With Trio/Capacitor
 For use on: Mazda 929

Original & X-References..

MITSUBISHI	A 860 T 36770
	JE4818W60B
MOBILETRON	RM-45
WAI	31-8355
CARGO	135901
TRANSPO	IMR10066

MIA10012

Diodes: 6-30Ampere

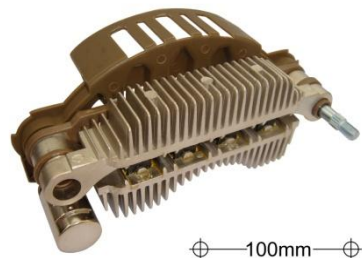

MIA10010

FEATURES

Diodes: 8-30Ampere
 Mounting Length: 100mm
 With M5×44mm Battery Post
 With Trio
 For use on: Mazda RX7 Turbo

Original & X-References..

MITSUBISHI	A 860 T 40270
MOBILETRON	RM-49
WAI	31-8366
CARGO	135882
TRANSPO	IMR10068

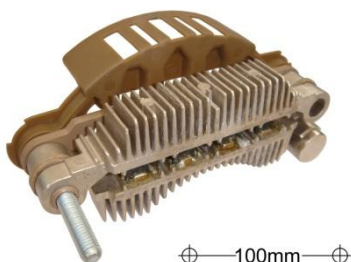

MIA10011

FEATURES

Diodes: 8-30 Ampere
 Mounting Length: 100mm
 With M6×49.5mm Battery Post
 With Trio/Capacitor

Original & X-References..

MITSUBISHI	A 3T14292
MOBILETRON	RM-125HV
WAI	31-8373
TRANSPO	IMR10088

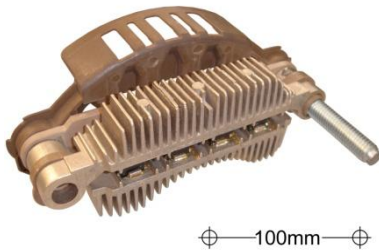

MIA10013

FEATURES

Diodes: 8-30 Ampere
 Mounting Length: 100mm
 With M8×59.5mm Battery Post
 With Trio
 Without Capacitor

Original & X-References..

FORD	98VB10K359BB
MITSUBISHI	A3TN1791
	A860X42970
MOBILETRON	RM-99HV
CARGO	231079
TRANSPO	IMR10057
	IM757

MIA10016

Diodes: 8-30Ampere
 With M5×35mm Mounting Bolt

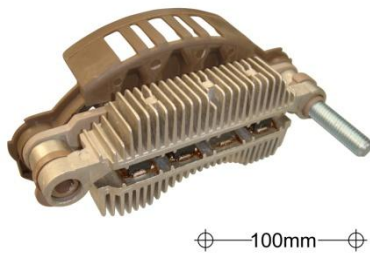

MIA10014

FEATURES

Diodes: 6-30 Ampere
 Mounting Length: 100mm
 With M8×54mm Battery Post
 With Trio
 Without Capacitor

Original & X-References..

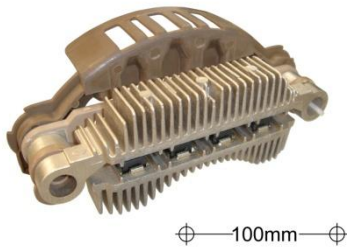

MIA10015

FEATURES

Diodes: 8-30 Ampere
 Mounting Length: 100mm
 With Trio
 Without Capacitor
 For use on: Ford Transit

Original & X-References..

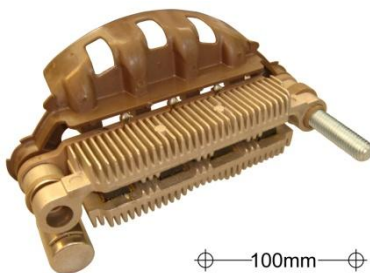

MIA10017

FEATURES

Diodes: 8-30 Ampere
 Mounting Length: 100mm
 With M8×54mm Battery Post
 With Trio

Original & X-References..

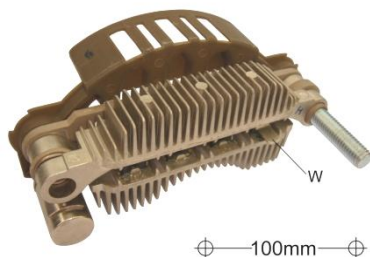

MIA10018

FEATURES

Diodes: 8-30 Ampere
 Mounting Length: 100mm
 With M8×54mm Battery Post
 With "W" Terminal
 With Trio

Original & X-References..

4D33

MIA10021

Diodes: 6-30Ampere

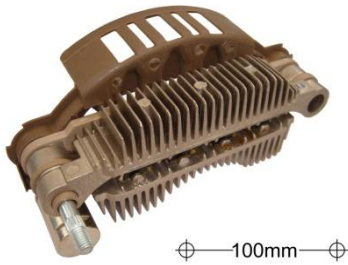

MIA10020

FEATURES

Diodes: 8-30 Ampere
 Mounting Length: 100mm
 With M5×44mm Battery Post
 With Trio
 Without Capacitor
 For use on: Ford Ambulance and
 Emergency

Original & X-References..

TRANSP0	IMR10052
CARGO	234310

MIA10030
 With Capacitor

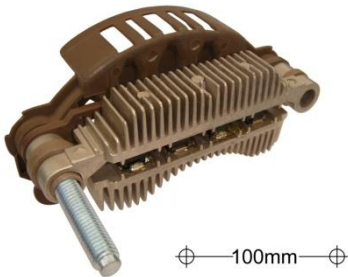

MIA10023

FEATURES

Diodes: 8-30 Ampere
 Mounting Length: 100mm
 With M8×59.5mm Battery Post
 With M5×35mm Mounting Bolt
 With Trio
 Without Capacitor

Original & X-References..

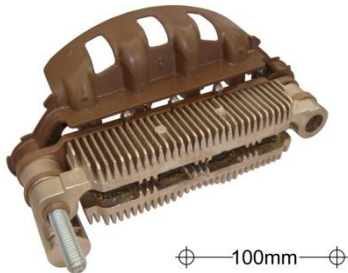

MIA10025

FEATURES

Diodes: 8-30 Ampere
 Mounting Length: 100mm
 With M6×49.5mm Battery Post
 With Trio/ Capacitor

Original & X-References..

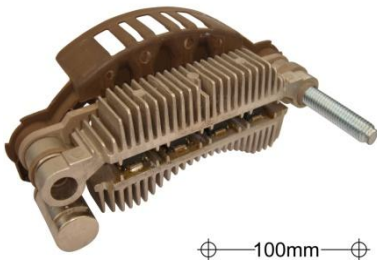

MIA10028

FEATURES

Diodes: 8-30Ampere
 Mounting Length: 100mm
 With M8×59.5mm Battery Post
 With Trio/Capacitor

Original & X-References..

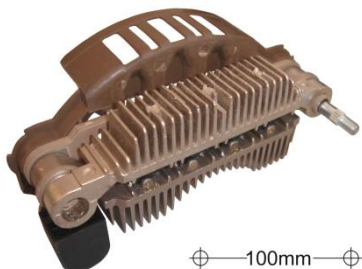

MIA10029

FEATURES

Diodes: 8-30 Ampere
 Mounting Length: 100mm
 With M5×44mm Battery Post
 With Trio
 For use on: Ford Probe, Mazda626,
 Mazda MX6

Original & X-References..

FORD	F32Z10346B
MITSUBISHI	A860T38670
	A860T40270
WAI	31-8356
CARGO	135882
TRANSP0	IMR10064

MIA10047
 Diodes: 6-30 Ampere

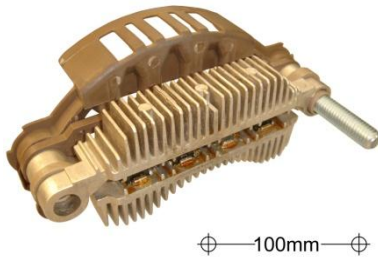

MIA10031

FEATURES

Diodes: 8-35Ampere
 Mounting Length: 100mm
 With M8×54mm Battery Post
 With Trio
 Without Capacitor

Original & X-References..

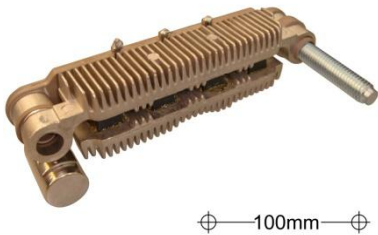

MIA10032

FEATURES

Diodes: 8-30Ampere
 Mounting Length: 100mm
 With M8×59.5mm Battery Post
 With Trio/Capacitor

Original & X-References..

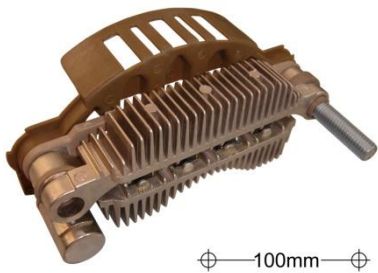

MIA10033

FEATURES

Diodes: 8-35 A Avalanche
 Mounting Length: 100mm
 With M8×54mm Battery Post
 Without Trio
 With Capacitor

Original & X-References..

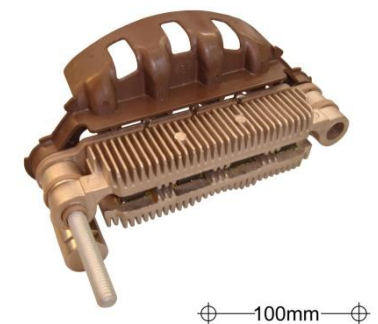

MIA10034

FEATURES

Diodes: 8-30Ampere
 Mounting Length: 100mm
 With M6×60mm Battery Post
 With Trio/ Capacitor

Original & X-References..

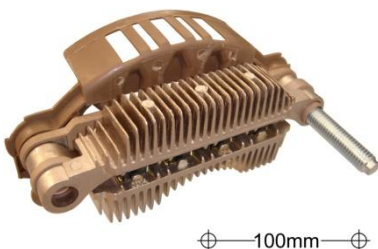

MIA10035

FEATURES

Diodes: 8-35 A Avalanche
 Mounting Length: 100mm
 With M8×59.5mm Battery Post
 Without Trio/ Capacitor
 For use on: 1999-2001Mercury Villager
 Van3.3L(125A)
MIA10036 8-30 Ampere
MIA10046
 Diodes:8-30Ampere
 With Capacitor

Original & X-References..

TRANSPO	IMR10058
CARGO	230884
J&N	172-48108
MOBILETRON	RM-134

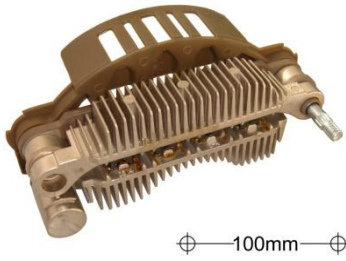

MIA10037

FEATURES

Diodes: 8-30Ampere
 Mounting Length: 100mm
 With M5×44mm Battery Post
 With Trio
 With Capacitor

Original & X-References..

MITSUBISHI A860T41370
 TRANSPO IMR10070

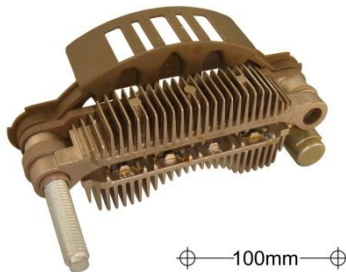

MIA10039

FEATURES

Diodes: 6-30Ampere
 Mounting Length: 100mm
 With M8×59.5mm Battery Post
 With Trio
 With Capacitor

Original & X-References..

MITSUBISHI A860X47070
 MOBILETRON RM-116
 CARGO 139111

MIA10049

Diodes: 8-30Ampere

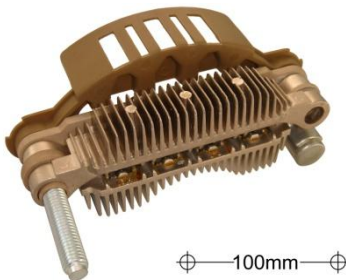

MIA10041

FEATURES

Diodes: 8-30Ampere
 Mounting Length: 100mm
 With M8×59.5mm Battery Post
 With Trio
 With Capacitor

Original & X-References..

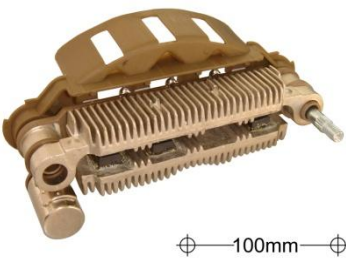

MIA10042

FEATURES

Diodes: 6-30Ampere
 Mounting Length: 100mm
 With M5×44mm Battery Post
 With Trio
 With Capacitor

Original & X-References..

CARGO 236816

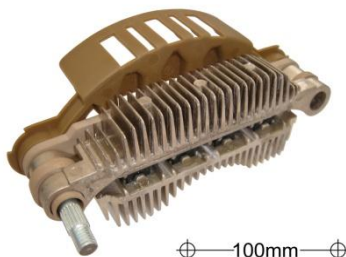

MIA10043

FEATURES

Diodes: 8-30Ampere
 Mounting Length: 100mm
 With M6×44.5mm Battery Post
 Without Trio
 Without Capacitor

Original & X-References..

MOBILETRON RM-127
 TRANSPO IMR10081

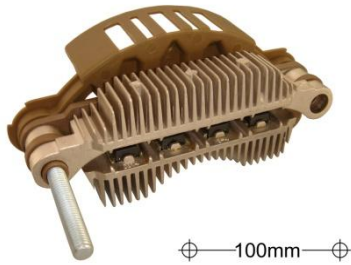

MIA10044

FEATURES

Diodes: 8-30Ampere
 Mounting Length: 100mm
 With M6×60mm Battery Post
 Without Trio/Capacitor

Original & X-References..

MOBILETRON RM-131HV
 TRANSPO IMR10090

MIA10045

Diodes:8-30Ampere
 With Capacitor

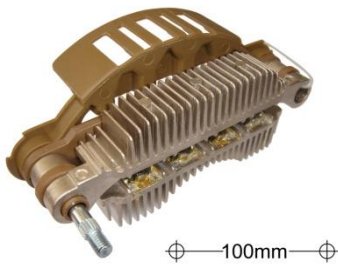

MIA10048

FEATURES

Diodes: 8-30Ampere
 Mounting Length: 100mm
 With M5×44mm Battery Post
 Without Trio/Capacitor

Original & X-References..

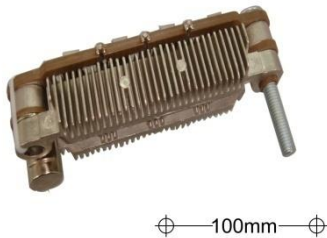

MIA10050

FEATURES

Diodes : 8-30A Ampere
 Mounting Length : 100mm
 With M6×49.5mm Battery Post
 With Trio
 With Capacitor

Original & X-References..

MIA10054

With M6×60mm Battery Post

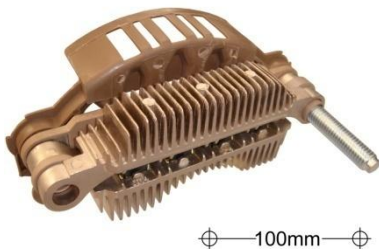

MIA10051

FEATURES

Diodes :8-35A Avalanche
 Mounting Length : 100mm
 With M8×54m Battery Post
 Without Trio
 Without Capacitor

Original & X-References..

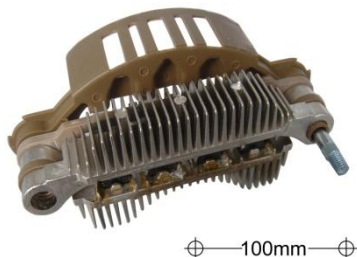

MIA10052

FEATURES

Diodes : 8-30 Ampere
 Mounting Length : 100mm
 With M5×44mm Battery Post
 Without Trio
 Without Capacitor

Original & X-References..

MITSUBISHI A860X66270
 TRANSPO IMR10047

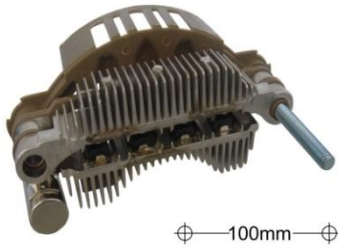

MIA10053

FEATURES

Diodes : 8-30A Ampere
 Mounting Length : 100mm
 With M6×60mm Battery Post
 With Trio
 With Capacitor

Original & X-References..

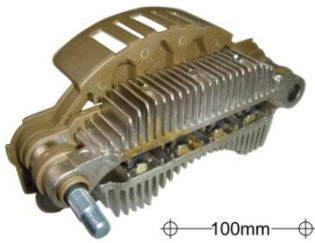

MIA10062

FEATURES

Diodes : 8-30A Ampere
 Mounting Length : 100mm
 With M6×44.5mm Battery Post
 Without Trio
 Without Capacitor

Original & X-References..

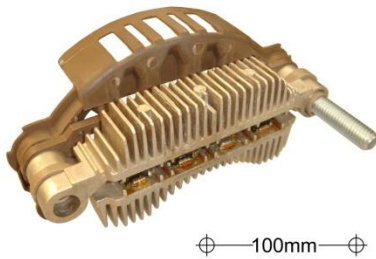

MIA10063

FEATURES

Diodes:6-30A Ampere
 Mounting Length : 100mm
 With M8×54mm Battery Post
 Without Trio
 Without Capacitor

Original & X-References..

MITSUBISHI	1901-0030
J&N	172-48104
TRANSPO	IMR10067

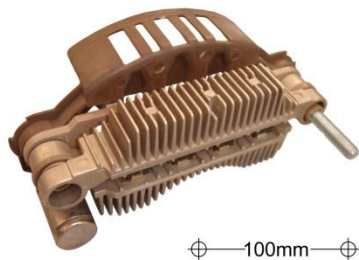

MIA10065

FEATURES

Diodes:8-30 Ampere
 Mounting Length : 100mm
 With M5×44mm Battery Post
 With Trio
 With Capacitor

Original & X-References..

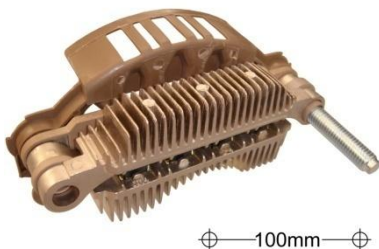

MIA10067

FEATURES

Diodes : 6-40A Avalanche
 Mounting Length : 100mm
 With M8×59.5mm Battery Post
 Without Trio
 Without Capacitor

Original & X-References..

MITSUBISHI	A3TG1991
TRANSPO	IMR10045
LESTER	11102

MIA10071



⊕—100mm—⊕

FEATURES

Diodes:8-30 Ampere
 Mounting Length: 100mm
 With M8×54mm Battery Post
 With "W" Terminal
 With Trio
 With Capacitor

Original & X-References..

MIA10074



⊕—100mm—⊕

FEATURES

Diodes:6-30 Ampere
 Diameter OD: 100mm
 With M5×44mm Battery Post
 Without Trio
 Without Capacitor

Original & X-References..

LESTER 11118

MIA10076

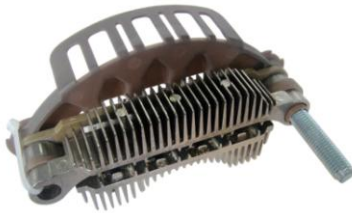

⊕—100 mm—⊕

FEATURES

Diodes : 8-30 A Ampere
 Mounting Length: 100mm
 With M8×59.5mm Battery Post
 With Trio

Original & X-References..

MITSUBISHI A4TR5188

MIA10078

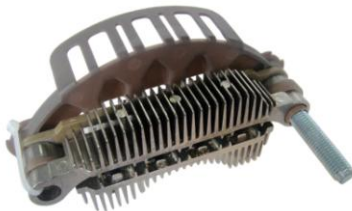

⊕—100 mm—⊕

FEATURES

Diodes: 8-30 Ampere
 Mounting Length: 100mm
 With Trio/Capacitor

Original & X-References..

MIA10080A



⊕—100 mm—⊕

FEATURES

Diodes:8-30 A Avalanche
 Diameter OD: 100mm
 With M8×50mm Battery Post
 With Trio/Capacitor

Original & X-References..

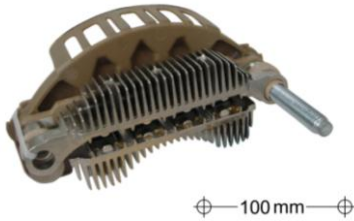

MIA10082

FEATURES

Diodes : 8-30 A Ampere
 Mounting Length: 100mm
 With M8 x59.5mm Battery Post

Original & X-References..

MITSUBISHI A4TA8494



MIA10083A

FEATURES

Diodes : 8-35 A Avalanche
 Mounting Length: 100mm
 With M8 x59.5mm Battery Post
 With Trio

Original & X-References..

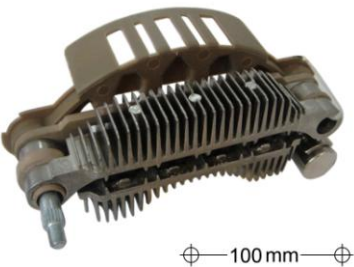

MIA10084A

FEATURES

Diodes : 8-35 A Avalanche
 Mounting Length: 100mm
 With M5 x44mm Battery Post
 With Trio/Capacitor

Original & X-References..

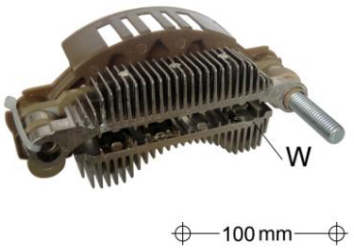

MIA10086

FEATURES

Diodes: 6-30A Ampere
 Diameter: 100mm
 With M8 x59.5mm Battery Post
 With Trio
 Without Capacitor

Original & X-References..

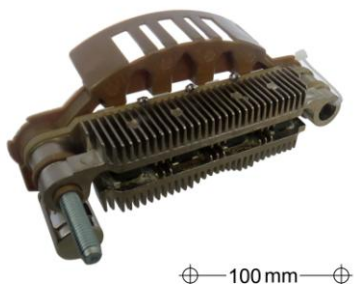

MIA10087

FEATURES

Diodes: 8-30A Ampere
 Diameter: 100mm
 With M6 x49.5mm Battery Post
 With Trio/Capacitor

Original & X-References..

MIA12101



FEATURES

Diodes : 12-35 A Ampere
 Diameter OD: 128mm
 With M5×44mm Battery Post

Original & X-References..

MIA12102A



FEATURES

Diodes : 16-35 A Avalanche
 Diameter OD: 128mm
 With M8×59.5mm Battery Po

Original & X-References..

MIA12103A



FEATURES

Diodes : 16-35 A Avalanche
 Diameter OD: 128mm
 With M5×44mm Battery Post

Original & X-References..

MIP7001



FEATURES

Diodes: 4-30 Ampere Block
 Mounting Length: 70mm
 Stamped steel heat sink
 Fore use on: MITSUBISHI

Original & X-References..

IW700	2800
HINO	27700-1700
SAWAFUJI	1219-008-00XOSF
NISSAN	23500-E9007

MIP7002

Diodes: 6-30Ampere Block

MIP7103F



⊕ — 71mm — ⊕

FEATURES

Diodes: 6-35 Ampere Button
 Mounting Length: 71mm
 With Trio
 Without Capacitor
 For use on: Chrysler , Dodge ,Plymouth
MIP7101F
 Diodes: 6-35Ampere (7650/7651)

Original & X-References..

MITSUBISHI	
3446828100	A001T02871
A001T22771	A001T23283
MOBILETRON	MR-59
WAI	31-8308
CARGO	132087
TRANSPO	IMR7111

MIP7104F

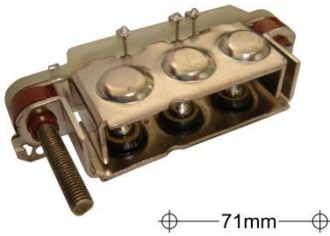

FEATURES

- Diodes: 6-35 Ampere Button
- Mounting Length: 71mm
- With M5×43mm Battery Post
- With Trio
- Without Capacitor

Original & X-References..

MITSUBISHI	A860T09470
MOBILETRON	RM-88
WAI	31-8389
CARGO	138974
TRANSPO	IMR7117

For use on: Nissan Pickup, Pulsar

MIP7107F



FEATURES

- Diodes: 6-35 Ampere
- Mounting Length: 71mm
- With M5×51mm Battery Post
- With Trio

Original & X-References..

MIP8001L

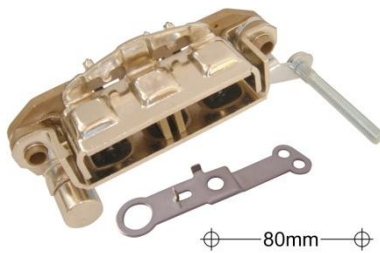

FEATURES

- Diodes: 6-35 Ampere
- Mounting Length: 80mm
- With M5×43mm Battery Post
- With Trio
- With Aluminum Heat sinks
- MIP8001** 6-35Ampere
- With Copper Heat sinks

Original & X-References..

MITSUBISHI	A860T08270
MOBILETRON	RM-65
WAI	31-8313
CARGO	132130
TRANSPO	IMR8041

MIP8002L

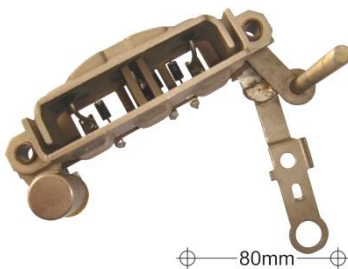

FEATURES

- Diodes: 6-35 Ampere
- Mounting Length: 80mm
- With M5×51mm Battery Post
- With Trio
- With metal
- With Aluminum Heat sinks
- MIP8002** 6-35Ampere
- With Copper Heat sinks

Original & X-References..

MIP8003L

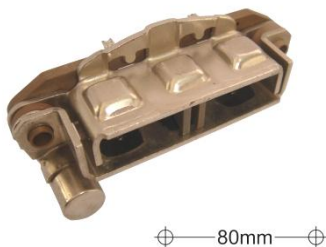

FEATURES

- Diodes: 6-35 Ampere
- Mounting Length: 80 mm
- With Trio
- With Aluminum Heat sinks
- For use on: Dodge Trucks, Mazda, Mitsubishi, Plymouth
- MIP8003** 6-35Ampere
- With Copper Heat sinks

Original & X-References..

MITSUBISHI	A 860 T 06070	A 860 T 06082
	MD607568	A 860 T 06470
MOBILETRON		RM-66
WAI		31-8310
CARGO		131221 131541
TRANSPO		IMR8043

MIP8004L

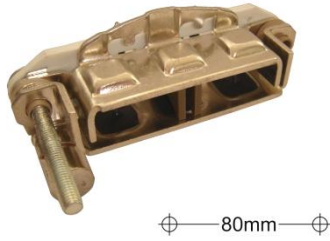

FEATURES

Diodes: 6-35 Ampere
 Mounting Length: 80mm
 With M5×51mm Battery Post
 With Trio
 With Aluminum Heat sinks
 For use on: Mazda GLC
MIP8004 6-35Ampere
 With Copper Heat sinks

Original & X-References..

MITSUBISHI	A 860 T 10770
MOBILETRON	RM-67
WAI	31-8315
CARGO	131532
TRANSPO	IMR8045

MIP8005L



FEATURES

Diodes: 6-35 Ampere
 Mounting Length: 80mm
 With Trio
 With Aluminum Heat sinks
 For use on: Nissan Vans, Nissan March
MIP8005 6-35Ampere
 With Copper Heat sinks

Original & X-References..

MITSUBISHI	A 860 T 08470
MOBILETRON	RM-85
WAI	31-8390
CARGO	131543
TRANSPO	IMR8011

MIP8007L

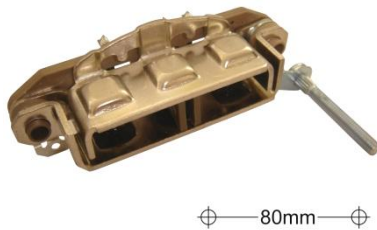

FEATURES

Diodes: 6-35 Ampere
 Mounting Length: 80mm
 With M5×43mm Battery Post
 With Trio
 With Aluminum Heat sinks
 For use on: Mitsubishi Motors
MIP8007 6-35Ampere
 With Copper Heat sinks

Original & X-References..

MITSUBISHI	ME700555
	A860T14570
MOBILETRON	RM-86
CARGO	136726
TRANSPO	IMR8047

MIP8008L

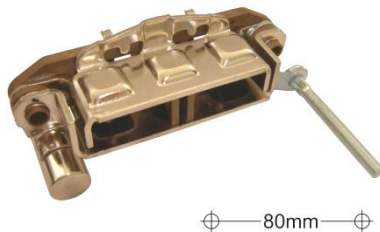

FEATURES

Diodes: 6-35 Ampere
 Mounting Length: 80mm
 With M5×51mm Battery Post
 With Trio
 With Aluminum Heat sinks
 For use on: Dodge Trucks, Mitsubishi
MIP8008 6-35Ampere
 With Copper Heat sinks

Original & X-References..

MITSUBISHI	A 860 T 08270
	MD607616
MOBILETRON	RM-65
WAI	31-8313
CARGO	132130
TRANSPO	IMR8041

MIP8501



FEATURES

Diodes: 6-35 Ampere
 Mounting Length: 85mm
 With Trio
 With Copper Heat sinks
 For use on: Dodge, Mazda, Mitsubishi,
 Plymouth

Original & X-References..

MITSUBISHI	A 860 T 03970	A 860T05170
	MD607370	MD607441
MOBILETRON		RM-68
WAI		31-8314
CARGO		130833
TRANSPO		IMR8511



⊕—85mm—⊕

MIP8502

FEATURES

Diodes: 6-35 Ampere
 Mounting Length: 85mm
 With Trio
 With Copper Heat sinks
 For use on: Mazda 626, Dodge Truck

Original & X-References..

MITSUBISHI	
A 860 T 08370	A 860 T 10470
MD607693	A 860 T 09370
MOBILETRON	RM-83
WAI	31-8311
CARGO	131545
TRANSPO	IMR8541



⊕—85mm—⊕

MIP8503

FEATURES

Diodes: 6-35 Ampere
 Mounting Length: 85 mm
 With M5 ×43mm Battery Post
 With Trio
 With Copper Heat sinks
 For use on: Mitsubishi Mirage Turbo,
 Mazda Diesel 626

Original & X-References..

MITSUBISHI	
2323004D00	A 860 T 08770
A 860 T 15170	MD607680
MOBILETRON	RM-73
WAI	31-8331
CARGO	132463
TRANSPO	IMR8545



⊕—85mm—⊕

MIP8504

FEATURES

Diodes: 6-35 Ampere
 Mounting Length: 85mm
 With Trio
 With Copper Heat Sinks
 For use on: Mazda GLC Sedan

Original & X-References..

MITSUBISHI	A002T23471
MOBILETRON	RM-69
WAI	31-8304
CARGO	131544
TRANSPO	IMR8571



⊕—85mm—⊕

MIP8505

FEATURES

Diodes: 6-35 Ampere
 Mounting Length: 85mm
 With M5 ×43mm Battery Post
 With Trio
 With Copper Heat sinks

Original & X-References..



⊕—85mm—⊕

MIP8506

FEATURES

Diodes: 6-35 Ampere
 Mounting Length: 85mm
 With M5 ×43mm Battery Post
 With Trio
 With Aluminum Heat Sinks

Original & X-References..



⊕—100mm—⊕

MIP10001

FEATURES

Diodes: 6-50 Ampere
 Mounting Length: 100mm
 With Trio
 With Copper Heat Sinks

For use on: Mazda 626, Plymouth
 Coquest

Original & X-References..

MITSUBISHI	A003T34077
	A860T10370
MOBILETRON	RM-74
WAI	31-8306
CARGO	131547
TRANSPO	IMR10041



⊕—100mm—⊕

MIP10002

FEATURES

Diodes: 6-50 Ampere
 Mounting Length: 100mm
 With Trio
 Without Capacitor

For use on: Dodge, Mazda

Original & X-References..

MITSUBISHI	A860T07370
	A860T04170
MOBILETRON	RM-75
WAI	31-8307
CARGO	131227
TRANSPO	IMR10011



⊕—100mm—⊕

MIP10003

FEATURES

REC MI
 Diodes: 6-50 Ampere
 Mounting Length: 100mm
 With M5 ×43mm Battery Post
 With Trio
 With Copper Heat Sinks
 For use on: Nissan Bluebird 2000
 Diesel

Original & X-References..

MITSUBISHI	A860T11770
MOBILETRON	RM-76
J&N	172-48005
WAI	31-8378
CARGO	132464
TRANSPO	IMR10043



MID751ZT

FEATURES

Complete set with
 REC MID751+REG(06-078) 14V

Original & X-References..

TRANSPO	IYR751+IY510
---------	--------------



MOP3005

FEATURES

Diodes: 6-50Ampere
With Trio

Original & X-References..



MOP3006

FEATURES

Diodes:6-50 Ampere

Original & X-References..

TRANSPO MR6206



MOP3006A

FEATURES

Diodes: 6-50A Avalanche

Original & X-References..

LESTER	8058	8328
	8329	8410
TRANSPO	MR6255	

MOP3006B

For 24V Alternators



MOP3010B

FEATURES

Diodes: 12-35A Avalanche
With Capacitor
For 24V Alternators

Original & X-References..



MOP6001

FEATURES

Diodes:3-35Ampere
Positive Rectifier

Original & X-References..

3109-1018

MOP6004

Diodes:3-35Ampere
Negative Rectifier

3109-1012

All maker's names & numbers are used for reference purposes only



MOP6041

FEATURES

Diodes: 3-25 Ampere
 With 2—37.2×3/16" Bolt
 Negative Rectifier
 For: Motorola A/8AL, HA/8HA,
 RA/8AR Series Alternators w/Isolation

Original & X-References..

MOTOROLA	101-106	101-107
	101-11	
LESTER	7091	7099
	7353	7353
	7361	7365
WAI	31-403	
CARGO	131888	
TRANSPO	MR6041	



MOP6064

FEATURES

Diodes: 3-35 Ampere
 With 2—37.2×3/16" Bolt
 Positive Rectifier
 For: Motorola 60-70 Amp/12 Volt
 Alternators
 For use on: Farm, Industrial, Marine
 Applications

Original & X-References..

MOTOROLA	101-147	101-149
	101-17	
LESTER	7376	
WAI	31-408	
CARGO	131893	
TRANSPO	MR6064	



MOP6065

FEATURES

Diodes: 3-35 Ampere
 With 2—37.2×3/16" Bolt
 Negative Rectifier
 For: Motorola 60-70 Amp/12 Volt
 Alternators
 For use on: Farm, Industrial, Marine
 Applications

Original & X-References..

MOTOROLA	101-148	101-47
LESTER	7376	
WAI	31-407	
CARGO	131892	
TRANSPO	MR6065	



MOP6072

FEATURES

Diodes: 3-50 Ampere
 With 50.3×1/4" Bolt
 Positive Rectifier
 For: Motorola Alternators
 For use on: Industrial Equipment

Original & X-References..

MOTOROLA	101-162	101-187
LESTER	7417	
WAI	31-406-1	
CARGO	131891	
TRANSPO	MR6072	



MOP6300

FEATURES

Diodes: 1-25 Ampere
 With 35×1/4" Bolt
 Negative Rectifier

Original & X-References..

MOTOROLA	101-23	101-3
	101-58	37438
LESTER	7356	7357
	7362	7364
CARGO	131885	
TRANSPO	MR6300	

MOP6301



FEATURES

Diodes: 2-25 Ampere
 With 35 x 1/4" Bolt
 Negative Rectifier

Original & X-References..

MOTOROLA	101-13	101-29
	101-65	10959
LESTER	7356	7357
	7362	7364
CARGO	131886	
TRANSPO	MR6301	



NPD8301

FEATURES

Diodes: 8-35 Ampere
Diameter OD: 83mm
With M6 Battery Post

For use on: Industrial

Original & X-References..

NIPPONDENSO	021580-3110
MOBILETRON	RN-18
WAI	31-8221
CARGO	137872
TRANSPO	INR718



NPD8303g

FEATURES

Diodes: 8-35 Ampere Dish Diode
Diameter OD: 83mm
With M6x44mm Battery Post

For use on: Industrial

Original & X-References..

NIPPONDENSO	100211-4640
	100211-1670
	100211-4650
	021580-3450
TOYOTA	1624164011
MOBILETRON	RN-26
TRANSPO	INR716



NPD8701

FEATURES

Diodes: 8-35 Ampere
Diameter OD: 87mm
With M6 Battery Post

For use on: Tractors,
TOYOTA 27060-DF020

Original & X-References..

NIPPONDENSO	
	100211-1680
	100211-0610
	121000-4230
	121000-4250
MOBILETRON	RN-40
CARGO	134306
TRANSPO	INR723



NPD8702

FEATURES

Diodes: 8-35 Ampere
Diameter OD: 87mm
With M6 Battery Post
For use on: Isuzu I-Mark, Toyota Teral ,
4-Runner

Original & X-References..

NIPPONDENSO	021580-3130
TOYOTA	27375-72150
MOBILETRON	RN-15
WAI	31-8200
ISUZU	8-94449-781-1
CARGO	132540
TRANSPO	INR724



NPD9001

FEATURES

Diodes: 8-35 Ampere
Diameter OD: 90mm
With M6 Battery Post
Without Mounting Hole for Ground
Strap

For use on: Honda Civic, CRX, Toyota
Tercel, Acura

Original & X-References..

NIPPONDENSO	021580-2250
WAI	31-8205
CARGO	132541
MOBILETRON	RN-16
TOYOTA	27375-6340
TRANSPO	INR725

NPD9002



FEATURES

Diodes: 8-35 Ampere
 Diameter OD: 90mm
 With M6×44mm Battery Post

For use on: Geo Spectrum, Isuzu I-Mark

Original & X-References..

NIPPONDENSO	100211-1220
100211-1330	100211-3720
021580-2341	
WAI	31-8206
CARGO	135258
MOBILETRON	RN-17
ISUZU	16231-64851
TRANSPO	INR726

NPD10001



FEATURES

Diodes: 8-50 Ampere
 Diameter OD: 100mm
 For use on: Acura, Honda, Isuzu,
 Toyota, Sterling

NPD10001F

With Steel Heat sinks

Original & X-References..

NIPPONDENSO	021580-2160
021580-2230	27357-63020
MOBILETRON	RN-13
WAI	31-8201
CARGO	132082
TRANSPO	INR720

NPD10001L



FEATURES

Diodes:8-35 Ampere Press-fit Diodes
 Diameter OD: 100mm
 With M6 Battery Post
 With Aluminum Heat sinks

Original & X-References..

NIPPONDENSO	021580-2160
021580-2230	27357-63020
MOBILETRON	RN-13
WAI	31-8201
CARGO	132082
TRANSPO	INR720P

NPD10002



FEATURES

Diodes: 8-50 Ampere
 Diameter OD: 100mm
 With M6×40mm Battery Post
 For use on: Geo Strom, Isuzu
 Impulse, Stylus

Original & X-References..

NIPPONDENSO	100211-1070
100211-1100	100211-3120
021580-2512	
MOBILETRON	RN-12
RENARD	11264
WAI	31-8211
CARGO	135250
TRANSPO	INR401

NPD10002L



FEATURES

Diodes:8-35 Ampere Press-fit Diodes
 Diameter OD: 100mm
 With M6×40mm Battery Post
 With Aluminum Heat sinks

Original & X-References..

NIPPONDENSO	100211-1070
100211-1100	100211-3120
MOBILETRON	RN-12
RENARD	11264
WAI	31-8211
CARGO	135250
TRANSPO	INR401P



Φ100mm

NPD10003

FEATURES

Diodes: 8-50 Ampere
 Diameter OD: 100mm
 With M6×40mm Battery Post
 With Mounting Hole for Ground Strap

Original & X-References..

For use on: Geo Strom, Isuzu Impulse, Stylus



Φ100mm

NPD10004

FEATURES

Diodes: 8-50 Ampere
 Diameter OD: 100mm
 With M6 Battery Post
 With Mounting Hole for Ground Strap

Original & X-References..

For use on:
 1996-00 Suzuki Esteam 1.6L
 1997-99 Toyota 4-Runner 2.7L
 TRANSPO INR502

NPD10005

Diodes: 6-35Ampere



Φ100mm

NPD10004L

FEATURES

Diodes: 8-35Ampere Press-fit Diodes
 Diameter OD: 100mm
 With M6 Battery Post
 With Mounting Hole for Ground Strap
 With Aluminum Heat sinks

Original & X-References..

For use on:
 1996-00 Suzuki Esteam 1.6L
 1997-99 Toyota 4-Runner 2.7L
 TRANSPO INR502P



Φ100mm

NPD10006

FEATURES

Diodes: 8-50 Ampere
 Diameter OD: 100mm
 With M6×44mm Battery Post

Original & X-References..

For use on: Chrysler Laser, LeBaron, New Yorker, Dodge600, Aires Caravan, Plymouth Acclaim, Reliant, Voyager, Turismo

NIPPONDENSO	1401-0001
	021580-4120
	021580-4490
TOYOTA	27357-74120
	27357-74290
MOBILETRON	RN-14
WAI	31-8204
CARGO	135415
TRANSPO	INR72P



Φ100mm

NPD10007

FEATURES

Diodes: 8-50 Ampere
 Diameter OD: 100mm
 With M6×40mm Battery Post
 With Mounting Hole for Ground Strap

Original & X-References..

NPD10301



FEATURES

Diodes: 8-50 Ampere
 Diameter OD: 103mm
 With M6×44mm Battery Post
 With Ground Screw Hole
 For use on: Chrysler Lebaron ,Dodge
 Caravan, spirt, Daytona, Omni

Original & X-References..

NIPPONDENSO	021580-3640
	025180-4660
	025180-4840
MOBILETRON	RN-01
WAI	31-8208
	31-8208-1
CARGO	135417
TRANSPO	INR729

NPD10301L



FEATURES

Diodes: 8-50 Ampere Press-fit Diodes
 Diameter OD: 103mm
 With M6×44mm Battery Post
 With Ground Screw Hole
 With Aluminum Heat sinks

Original & X-References..

NIPPONDENSO	021580-3640
	025180-4660
	025180-4840
MOBILETRON	RN-01
WAI	31-8208
	31-8208-1
CARGO	135417
TRANSPO	INR729P

NPD10302



FEATURES

Diodes: 8-50 Ampere
 Diameter OD: 103mm
 With M6×44mm Battery Post
 With Ground Screw Hole
 For use on: All 1993 Chrysler LH-Cars
NPD10308 8-50 Ampere
 Nicle Plating
NPD10311
 Diodes: 6-50 Ampere

Original & X-References..

NIPPONDENSO	021580-3640
	100211-8810
	121000-3480
WAI	31-8208
CARGO	135418
TRANSPO	INR403

NPD10302L



FEATURES

Diodes: 8-50 Ampere Press-fit Diodes
 Diameter OD: 103mm
 With M6×44mm Battery Post
 With Aluminum Heat sinks
 With Ground Screw Hole

Original & X-References..

NIPPONDENSO	100211-8810
	121000-3480
WAI	31-8208
CARGO	135418
TRANSPO	INR403P

NPD10303



FEATURES

Diodes: 8-50 Ampere
 Diameter OD: 103mm
 With M8 Battery Post
 With Ground Screw Hole
 For use on: Volvo Turbo Aircon, Lexus

Original & X-References..

NIPPONDENSO	021580-4640
	100211-2400
	101211-5450
MOBILETRON	RN-05
WAI	31-8217
CARGO	135043
TRANSPO	INR722



NPD10303L

FEATURES

Diodes: 8-50 Ampere Press-fit Diodes
 Diameter OD: 103mm
 With M8 Battery Post
 With Ground Screw Hole
 With Aluminum Heat sinks

Original & X-References..

NIPPONDENSO	100211-2400
	101211-5450
MOBILETRON	RN-05
WAI	31-8217
CARGO	135043
TRANSPO	INR722P



NPD10304

FEATURES

Diodes: 8-50 Ampere
 Diameter OD: 103mm
 With M6 Battery Post(31 9)

Original & X-References..

NIPPONDENSO	021580-3830
	100211-8050
	100211-8710
WAI	31-8212
RENARD	11227
CARGO	133672
TRANSPO	INR731



NPD10304L

FEATURES

Diodes: 8-50 Ampere Press-fit Diodes
 Diameter OD: 103mm
 With M6 Battery Post(31 9)
 Press-fit Diodes
 With Aluminum Heat sinks

Original & X-References..

NIPPONDENSO	100211-8050
	100211-8710
WAI	31-8212
RENARD	11227
CARGO	133672
TRANSPO	INR731P

NPD10304L-1

With M6 Battery Post(36 9)



NPD10305

FEATURES

Diodes: 8-50 Ampere
 Diameter OD: 103mm
 With M6 Battery Post
 With Ground Screw Hole
 For use on: Geo Prizm, Toyota Celica, Corolla

Original & X-References..

MOBILETRON	RN-03
RENARD	11262
WAI	31-8212
CARGO	133672
TRANSPO	INR402
CARGO	237663

NPD10305Ag

Diodes: 8-35 A Avalanche dish



NPD10305L

FEATURES

Diodes:8-50A Ampere Press-fit Diodes
 Diameter OD: 103mm
 With M6 Battery Post
 With Ground Screw Hole
 With Aluminum Heat sinks

Original & X-References..

MOBILETRON	RN-03
RENARD	11262
WAI	31-8212
CARGO	133672
TRANSPO	INR402P
CARGO	237663

NPD10305L-3

Diodes:6-50A Avalanche

NPD10306



FEATURES

Diodes: 8-50 Ampere
 Diameter OD: 103mm
 With M8×50mm Battery Post
 With Ground Screw Hole
 For use on: Volvo 740 Series 2.3L
 W/Turbo

Original & X-References..

NIPPONDENSO	100211-8620
	100211-8630
	100211-8632
RENARD	11222
WAI	31-8218
	31-8222
CARGO	136741 135418
TRANSPO	INR739

NPD10306L



FEATURES

Diodes:8-50 Ampere Press-fit Diodes
 Diameter OD: 103mm
 With M8×50mm Battery Post
 With Ground Screw Hole
 With Aluminum Heat sinks

Original & X-References..

NIPPONDENSO	100211-8620
	100211-8630
	100211-8632
RENARD	11222
WAI	31-8218
	31-8222
CARGO	136741 135418
TRANSPO	INR739P

NPD11301



FEATURES

Diodes: 8-50 Ampere
 Diameter OD: 113mm
 With M8 Battery Post

 For use on: Toyota Land Cruiser

Original & X-References..

NIPPONDENSO	021580-4100
	021580-4610
	021580-4690
MOBILETRON	RN-08
WAI	31-8213
CARGO	137874
TRANSPO	INR732

NPD11302



FEATURES

Diodes: 8-50 Ampere
 Diameter OD: 113mm
 With M8 Battery Post
 With Ground Screw Hole
 For use on: Lexus SC400, Toyota
NPD11311
 Diodes: 8-50 Ampere
 Nicle Plating

Original & X-References..

DENSO	021580-4690
	021580-4100
MOBILETRON	RN-11
RENARD	11254
WAI	31-8214
CARGO	137874
TRANSPO	INR733

NPD11302L



FEATURES

Diodes:8-50 Ampere Press-fit Diodes
 Diameter OD: 113mm
 With M8 Battery Post
 With Ground Screw Hole
 With Aluminum Heat sinks

Original & X-References..

DENSO	021580-4690
	021580-4100
MOBILETRON	RN-11
RENARD	11254
WAI	31-8214
CARGO	137874
TRANSPO	INR733P

NPD11303



Φ113mm

FEATURES

Diodes: 8-50 Ampere
 Diameter OD: 113mm
 With M6×44mm Battery Post
 With Ground Screw Hole

Original & X-References..

NIPPONDENSO	121000-4000
021580-4820	121000-4010
MOBILETRON	RN-02
WAI	31-8207
CARGO	135416
TRANSPO	INR734

NPD11303L



Φ113mm

FEATURES

Diodes:8-50 Ampere Press-fit Diodes
 Diameter OD: 113mm
 With M6×44mm Battery Post
 With Ground Screw Hole
 With Aluminum Heat sinks

Original & X-References..

NIPPONDENSO	121000-4000
021580-4820	121000-4010
MOBILETRON	RN-02
WAI	31-8207
CARGO	135416
TRANSPO	INR734P

NPD11305



Φ113mm

FEATURES

Diodes: 8-50 Ampere
 Diameter OD: 113mm
 With M6×44mm Battery Post
 For use on: Chrysler New Yorker,
 Dodge Caravan, Dynasty, Dodge
 Truck, Plymouth Voyager, Acclaim

Original & X-References..

NIPPONDENSO	121000-4000
	121000-4010
ISUZU	8 8121 8 0330
MOBILETRON	RN-02
WAI	31-8207
CARGO	135416
TRANSPO	INR728

NPD11305L



Φ113mm

FEATURES

Diodes:8-50A Ampere Press-fit Diodes
 Diameter OD: 113mm
 With M6×44mm Battery Post
 With Ground Screw Hole
 With Aluminum Heat sinks

Original & X-References..

NIPPONDENSO	121000-4000
	121000-4010
ISUZU	8 8121 8 0330
MOBILETRON	RN-02
WAI	31-8207
CARGO	135416
TRANSPO	INR728P

NPD11306



Φ113mm

FEATURES

Diodes: 8-50 Ampere
 Diameter OD: 113mm
 With M6 Battery Post
 With Ground Screw Hole
 For use on: Acura
NPD11312
 Diodes: 8-50 Ampere
 Without Ground Screw Hole

Original & X-References..

NIPPONDENSO	121000-4230
	121000-4250
WAI	31-8232
TRANSPO	INR735



NPD11306L

FEATURES

Diodes:8-50 Ampere Press-fit Diodes
 Diameter OD: 113mm
 With M6 Battery Post
 With Ground Screw Hole
 With Aluminum Heat sinks

Original & X-References..

NIPPONDENSO	121000-4230
	121000-4250
WAI	31-8232
TRANSPO	INR735P



NPD11308

FEATURES

Diodes: 8-50 Ampere
 Diameter OD: 113mm
 With M8x47mm Battery Post
 With Ground Screw Hole

Original & X-References..

DENSO	021580-2500
021580-4250	021580-4590
MOBILETRON	RN-16
WAI	31-8215
CARGO	233246
TRANSPO	INR736



NPD11308L

FEATURES

Diodes:8-50 Ampere Press-fit Diodes
 Diameter OD: 113mm
 With M8x47mm Battery Post
 With Ground Screw Hole
 With Aluminum Heat sinks

Original & X-References..

DENSO	021580-4250
	021580-4590
MOBILETRON	RN-16
WAI	31-8215
CARGO	233246
TRANSPO	INR736P



NPD11310

FEATURES

Diodes: 8-50 Ampere
 Diameter OD: 113mm
 With M8 Battery Post
 With Ground Screw Hole

Original & X-References..

FILS LESTER NUMBERS		
13410	13687	13791



NPD11401L

FEATURES

Diodes: 8-35 Ampere
 Diameter OD: 114mm
 With M5x47.5mm Battery Post
 With M5x35mm Ground Post
 With M5x41.5mm Mounting Bolt
 With Aluminum heat sink
NPD11401
 Diodes: 8-35 Ampere
 With Cooper Heat sinks

Original & X-References..

021580-2300

NPD11414L

Diodes: 6-35 Ampere
 With Aluminum Heat sinks



NPD11402

FEATURES

Diodes: 8-35 Ampere
 Diameter OD: 114mm
 With M6×48.5mm Battery Post
 With M5×40mm Battery Mounting Bolt
 With M5×40mm Ground Post
 With M5×35mm Ground Mounting Bolt
 With Trio
 With cooper heat sink

Original & X-References..



NPD11404

FEATURES

Diodes: 6-50 Ampere
 Diameter OD: 114mm
 With M6×48.5mm Battery Post
 With M5×40mm Ground Post
 With M5×41.5mm Mounting Bolt
 With Trio
 With steel heat sink

Original & X-References..



NPD11406L

FEATURES

Diodes: 6-35 Ampere
 Diameter OD: 114mm
 With M6×48.5mm Battery Post
 With M5×35mm Ground Post
 With M5×41.5mm Mounting Bolt
NPD11406 6-35 Ampere
 With Cooper Heat sinks
NPD11412 8-35 Ampere
 With M6×40mm Battery Post
 With cooper heatsink

Original & X-References..

NIPPONDENSO	021590 1890
	021590 1990
	021590 1910
CARGO	132657
NPD11406-1	8-35 Ampere
	With cooper heat sink
NPD11406L-1	8-35 Ampere
	With Aluminum Heat sinks



NPD11407L

FEATURES

Diodes: 8-35 Ampere Diodes
 Diameter OD: 114mm
 With M6×48.5mm Battery Post
 With M5×35mm Ground Post
 With M5×41.5mm Mounting Bolt
 With Aluminum Heat sinks

Original & X-References..

NPD11407
 Diodes: 8-35 Ampere
 With cooper heat sink

NPD11407-1
 With M6×40mm Battery Post
 With cooper heat sink



NPD11408

FEATURES

Diodes: 6-35 Ampere
 Diameter OD: 100mm
 With M6×49.5mm Battery Post
 With M5×36mm Battery Mounting Bolt
 With M5×38mm Ground Post
 With M5×38mm Ground Mounting Bolt

Original & X-References..

NIPPONDENSO	021600-1340
CARGO	135884
TRANSPO	INR400



NPD11410

FEATURES

- Diodes: 8-35 Ampere
- Diameter OD: 114mm
- With M6×48.5mm Battery Post
- With M5×40mm Battery Mounting Bolt
- With M5×40mm Ground Post
- With M5×35mm Ground Mounting Bolt
- With Trio
- With cooper heat sink

Original & X-References..



NPD11411

FEATURES

- Diodes: 6-50 Ampere
- Diameter OD: 114mm
- With M6×55mm Battery Post
- With M5×40mm Ground Post
- With M5×41.5mm Mounting Bolt
- With Trio
- With steel heat sink

Original & X-References..



NPD11419

FEATURES

- Diodes: 8-35 Ampere
- Diameter OD: 114mm
- With M6×58mm Battery Post
- With M5×47.5mm Ground Post
- With M5×35mm Mounting Bolt
- With Trio

Original & X-References..



NPD11501A

FEATURES

- Diodes :6-50 A Avalanche Press-Fit
- Diameter OD : 113mm
- With M6×33mm Battery Post
- With Aluminum Heat sinks

Original & X-References..

- | | |
|-------------|-------------|
| NIPPONDENSO | 021580-9220 |
| TRANSPO | INR438 |



NPD11502A

FEATURES

- Diodes :6-50 A Avalanche Press-Fit
- Diameter OD : 113mm
- With M8×46mm Battery Post
- With Aluminum Heat sinks

Original & X-References..

- | | |
|-------------|-------------|
| NIPPONDENSO | 021580-9210 |
|-------------|-------------|



NPD11701AL

FEATURES

Diodes: 6-50 A Avalanche Press-Fit
 Diameter OD: 117mm
 With M6×33mm Battery Post
 With Aluminum Heat sinks

Original & X-References..

NIPPONDENSO	021580-6610
TOYOTA	2735703-0070
MOBILETRON	RN-46
TRANSPO	INR430



NPD11702AL

FEATURES

Diodes: 12-35 A Avalanche Press-Fit
 Diameter OD: 117mm
 With M6×33mm Battery Post
 With Aluminum Heat sinks
 For use on: 2003 Toyota Tundra Pickup
 4.7L

Original & X-References..

NIPPONDENSO	1401-0009
	104210338
TOYOTA	27060-0F040
MOBILETRON	RN-34
CARGO	237607
TRANSPO	INR422



NPD11703AL

FEATURES

Diodes: 12-35 A Avalanche Press-Fit
 Diameter OD: 117mm
 With M8×46mm Battery Post
 With Aluminum Heat sinks

Original & X-References..

NIPPONDENSO	421000-0120
	021997-1123
MOBILETRON	RN-30
TRANSPO	INR420

NPD11722AL

With M8×40.5mm Battery Post



NPD11705AL

FEATURES

Diodes: 6-50 A Avalanche Press-Fit
 Diameter OD: 117mm
 With M6×34.5mm Battery Post
 With Aluminum Heat sinks

Original & X-References..

NIPPONDENSO	021580-6490
HONDA	31127-RAA-A010M
MOBILETRON	RN-48
TRANSPO	INR429



NPD11706AL

FEATURES

Diodes: 12-35 A Avalanche Press-Fit
 Diameter OD: 117mm
 With M8×30mm Battery Post
 With Aluminum Heat sinks
 For use on: 2001-2003 Chrysler Town
 & Country 3.3L
 2001-2003 Dodge Caravan 3.3L

Original & X-References..

MOBILETRON	RN-29
CARGO	237607
TRANSPO	INR421



Φ117mm

NPD11707A

FEATURES

Diodes: 12-35A Avalanche Press-Fit
 Diameter OD: 117mm
 With M8×46mm Battery Post
 With Copper Heat sinks
 For use on: 2002-01 Acura MDX3.5L
 2004-02 Honda Odyssey 3.5L
 2004-03 Honda Pilot 3.5L

Original & X-References..

NIPPONDENSO 1401-0026
 TRANSPO INR424



Φ117mm

NPD11708A

FEATURES

Diodes: 12-35 A Avalanche Press-Fit
 Diameter OD: 117mm
 With M8×40mm Battery Post
 With Copper Heat sinks
 For use on: 2005 Chrysler Sebring 2.4L
 2005 Chrysler Town & Country 3.3L
 2005-04 Dodge Durango 5.7L

Original & X-References..

CARGO 235589
 TRANSPO INR433

NPD11711A

With M6×33mm Battery Post

NPD11708AL

With Aluminum Heat sinks

CARGO 236328



Φ117mm

NPD11709AL

FEATURES

Diodes: 12-35 A Avalanche Press-Fit
 Diameter OD: 117mm
 With M6×34.5mm Battery Post
 With Aluminum Heat sinks

Original & X-References..

For use on :
 2001-05 Cadillac Deville FWD4.6L
 2001-04 Cadillac Seville 4.6L
 2004-05 Pontiac Bonneville 4.6L
 TRANSPO INR425



Φ117mm

NPD11710AL

FEATURES

Diodes: 6-50 A Avalanche Press-Fit
 Diameter OD: 117mm
 With M8×30mm Battery Post
 With Aluminum Heat sinks

Original & X-References..



Φ117mm

NPD11712AL

FEATURES

Diodes :7-50 A Avalanche Press-Fit
 Diameter OD : 117mm
 With M8×30mm Battery Post
 With Aluminum Heat sinks

Original & X-References..

NIPPONDENSO 104210-351
 104210-376
 MOBILETRON RN-37
 CARGO 237613
 TRANSPO INR431



NPD11717L

FEATURES

Diodes: 12-35A Ampere Press-Fit
 Diameter: 117mm
 With M8×40mm Battery Post
 With Aluminum Heat sinks

Original & X-References..

DENSO	421000001, 421000002, 421000004, 421000006, 421000010, 421000030, 4210000301
MOBILETRON	RN-29
LESTER	11063, 13870, 13871, 13912, 13913
TRANSPO	INR421

For use on: (2005-01) Chrysler, Dodge,
Jeep



NPD11720AL

FEATURES

Diodes :7-50A Avalanche Press-Fit
 Diameter OD : 117mm
 With M8×40mm Battery Post
 With Aluminum Heat sinks

Original & X-References..

LESTER	13871 13868
MOBILETRON	RN-55
TRANSPO	INR423



NPD11735AL

FEATURES

Diodes: 12-60 A Avalanche Press-Fit
 Diameter OD: 117mm
 With M8×46mm Battery Post
 With Aluminum Heat sinks

Original & X-References..

NIPPONDENSO	021580-6830 104210-2160
MOBILETRON	RN-54
TRANSPO	INR436



NPD11736AL

FEATURES

Diodes: 12-60 A Avalanche Press-Fit
 Diameter OD: 117mm
 With M6×40mm Battery Post
 With Aluminum Heat sinks

Original & X-References..

NIPPONDENSO	021580-5920
MOBILETRON	RN-44
TRANSPO	INR425



NPD13002

FEATURES

Diodes: 6-35 Ampere
 Diameter OD: 130mm
 With M10×50.5mm Battery Post
 With M6×40mm Ground Post
 With Trio/Capacitor

Original & X-References..



NPD13401A

FEATURES

Diodes:12-50A Avalanche
 With M8×46mm Battery Post

Original & X-References..

104210-6100
 INR435
 11181



NPD13801

FEATURES

Diodes: 8-50 Ampere Press-Fit
 Diameter OD:138mm
 With Aluminum Heat sinks
 With 5/16"×60mm Battery Post

Original & X-References..

3146-3800

NPD13801B-1

Diodes: 8-50 A Avalanche Press-Fit
 For 24V Alternators



Φ107mm

VAL840

FEATURES

Diodes: 6-50A Avalanche
 Diameter OD: 107mm
 With M8×49mm Battery Post
 Without Trio
 Without “W” Terminal
 For use on: Passit
VAL841 8-50A Avalanche
VAL842 8-50A Avalanche
 With “W” Terminal

Original & X-References..

VALEO 593174
 CARGO 138303



Φ107mm

VAL844

FEATURES

Diodes: 6-50A Avalanche
 Diameter OD: 107mm
 With M8×49mm Battery Post
 With Trio
 With “W” Terminal
 For use on: Renault, Peugeot
VAL845 8-50A Avalanche
VAL856 6-50A Avalanche
 With M8×59mm Battery Post

Original & X-References..

VALEO 2546062 2546076
 592844 592917
 CARGO 135427
 TRANSPO IPR844



Φ107mm

VAL846

FEATURES

Diodes: 8-50 A Avalanche
 Diameter OD: 107mm
 With M8×60.8mm Battery Post
 With Trio
 With “W” Terminal
VAL846-1
 With (M8+M6)×46mm Battery Post
 For use on: Renault, Peugeot

Original & X-References..

VALEO 2545941 545940
 592846 592847
 A546860A NF007
 CARGO 135518
 TRANSPO IPR846



Φ107mm

VAL847

FEATURES

Diodes: 6-50A Avalanche
 Diameter OD: 107mm
 With M8×60.8mm Battery Post
 Without Trio
 With “W” Terminal
 For use on: Renault, Peugeot
VAL850

Original & X-References..

MOBILETRON MFRX03952
 RP-18
 VALEO 2545938 545937
 TRANSPO IPR847



Φ107mm

VAL848

FEATURES

Diodes:6-50A Avalanche
 Diameter OD:107mm
 With M8×49mm Battery Post
 Without Trio
 Without “W” Terminal
 For use on: Citroen, Peugeot

Original & X-References..



Φ107mm

VAL852

FEATURES

Diodes: 6-50A Avalanche
 Diameter OD: 107mm
 With M8×60.8mm Battery Post
 Without Trio
 With “W” Terminal

VAL855

Diodes: 8-50 A Avalanche
VAL852-1
 With(M8+M6) ×50mm Battery Post

Original & X-References..



Φ107mm

VAL853

FEATURES

Diodes: 6-50A Avalanche
 Diameter OD: 107mm
 With M8×49mm Battery Post
 Without “W” Terminal
 With Trio

VAL853-2 6-50 Ampere

VAL814

Diodes: 8-50A Avalanche

Original & X-References..

VALEO	592915
TRANSPO	MER592



Φ107mm

VAL855-1

FEATURES

Diodes:6-50A Avalanche
 Diameter OD:107mm
 With (M8+M6) ×46mm Battery Post
 Without Trio
 With “W” Terminal

VAL855-2 8-50A Avalanche

With(M8+M6) ×50mm Battery Post

Original & X-References..



Φ107mm

VAL857

FEATURES

Diodes: 8-50A Avalanche
 Diameter OD: 107mm
 With M8×43mm Battery Post
 With Trio
 With “W” Terminal

VAL857-1

With M8×40mm Battery Post

VAL851

Diodes: 6-50 A Avalanche

Original & X-References..

VALEO	2546048	546041
	592848	NF009
MOBILETRON	RP-13	
CARGO	135278	
TRANSPO	IPR848	
CARGO	135494	
TRANSPO	MER592	



Φ107mm

VAL858B

FEATURES

Diodes: 6-50A Avalanche
 Diameter OD: 107mm
 With M8×49mm Battery Post
 With M5×25mm W-post
 With Trio

For 24V Alternator

Original & X-References..

VALEO	2546423
MOBILETRON	RP-28
CARGO	139483



VAL815P

FEATURES

Diodes : 12-35A Avalanche
 With M8×37.5mm Battery Post
 With M4×14mm Mounting Bolt

Original & X-References..

VALEO 593287
 CARGO 233614



VAL816P

FEATURES

Diodes : 12-35A Avalanche
 With M8×37.5mm Battery Post
 With M4×14mm Mounting Bolt

Original & X-References..

VALEO 593287 593499
 2809019 2809020
 CARGO 232199
 TRANSPO MER1920

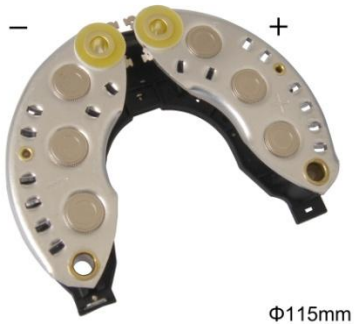

VAL103

FEATURES

Diodes: 6-50 Ampere
 Diameter OD: 115mm
 With Trio
 Without Capacitor
 For use on: Renault

Original & X-References..

HUCO 139668
 J&N ELECTRIC 172-40036
 LANDMAN B.V. M8060
 LECLERCQ 009-0232
 LUCAS 21224163
 SWS PR114017
 CARGO 131569
 TRANSPO IPR103



VAL135

FEATURES

Diodes: 6-50 Ampere
 Diameter OD: 115mm
 With Capacitor
 Without Trio
 For use on: Renault, Toro, Winnebago

Original & X-References..

VALEO A103543A
 A180593A NC145
 MOBLIETRON RP-01
 WAI 31-9421
 CARGO 131228
 TRANSPO IPR135



VAL157

FEATURES

Diodes: 6-50 Ampere
 Diameter OD: 115mm
 Without Capacitor
 Without Trio
 For use on: Renault Alliance, 18I Fuego

Original & X-References..

VALEO 105135/54
 NC133 NC216
 MOBLIETRON RP-03
 TRANSPO IPR157



Φ115mm

VAL252

FEATURES

Diodes: 6-50 Ampere
 Diameter OD: 115mm
 With Capacitor
 Without Trio
 Live "W" Circuit
 For use on: Renault

Original & X-References..

VALEO	105690
A523707A	A523724A NC141
MOBLIETRON	RP-07
WAI	31-9442
CARGO	132985
TRANSPO	IPR252



Φ115mm

VAL253

FEATURES

Diodes: 6-50 Ampere
 Diameter OD: 115mm
 With Capacitor
 Without Trio
 Live "W" Circuit

Original & X-References..

VALEO	105690
A523707A	A523724A NC141
MOBLIETRON	RP-07
WAI	31-9442
CARGO	132985
TRANSPO	IPR252



Φ115mm

VAL537

FEATURES

Diodes: 6-50 Ampere
 Diameter OD: 115mm
 With Capacitor
 With Trio
 For use on: Citroen, fiat, peugeot

Original & X-References..

VALEO	592595
	A180537A
	NC144
MOBILETRON	MFRX03782
	RP-04H
TRANSPO	IPR537



Φ115mm

VAL538

FEATURES

Diodes: 6-50 Ampere
 Diameter OD: 115mm
 With Capacitor
 With Trio
 For use on: Peugeot 205, Renault R25

Original & X-References..

VALEO	592747
	592749
	NC976
WAI	31-9434
TRANSPO	IPR747



Φ115mm

VAL539

FEATURES

Diodes: 6-50 Ampere
 Diameter OD: 115mm
 With Capacitor
 Without Trio
 For use on: AMC, Peugeot, Renault

Original & X-References..

VALEO	A105901A
	NC139 NC936
LUCAS	21225388
MOBLIETRON	RP-03
WAI	31-9402
CARGO	133689
TRANSPO	IPR539



VAL551

FEATURES

Diodes: 6-50 Ampere
 Diameter OD: 115mm
 With Capacitor
 With Trio
 Live "W" Circuit

For use on: Volvo Penta

Original & X-References..

VALEO	103551/54
	A523726A
	NC135 NC730
LUCAS	21225388
MOBLIETRON	RP-02
WAI	31-9403
CARGO	131701
TRANSPO	IPR551



VAL552

FEATURES

Diodes: 6-50 Ampere
 Diameter OD: 115mm
 With Capacitor
 With Trio
 With 200 Ohm Resistor
 Live "W" Circuit

Original & X-References..

VAL615

FEATURES

Diodes: 6-50 Ampere
 Diameter OD: 115mm
 With Capacitor
 Without Trio

Original & X-References..

VALEO	106016/28
NC143	104247
WAI	31-9414
CARGO	131573
TRANSPO	IPR615



VAL616

FEATURES

Diodes: 6-50 Ampere
 Diameter OD: 115mm
 With Capacitor
 With Trio

Original & X-References..

VALEO	A103543A
	A180593A
	NC145
WAI	31-9421
CARGO	131228
TRANSPO	IPR135



VAL687

FEATURES

Diodes: 6-50 Ampere
 Diameter OD: 115mm
 With Capacitor
 With Trio

Original & X-References..





VAL688

FEATURES

Diodes: 6-50 Ampere
 Diameter OD: 115mm
 With Capacitor
 With Trio
 For use on: Peugeot, Renault, Saab

Original & X-References..

VALEO	592596	NC138
LUCAS	21225400	UBB240
MOBLIETRON	RP-04	
WAI	31-9413	
CARGO	131164	
TRANSPO	IPR203	

VAL204

With 82 Ohm Resistor

TRANSPO	IPR554
---------	--------



VAL713

FEATURES

Diodes: 6-50 Ampere
 Diameter OD: 115mm
 With Capacitor
 With Trio

Original & X-References..

VALEO	101713	210303
MOBLIETRON	RP-05H	
WAI	31-9405	31-9405-1
CARGO	133687	
TRANSPO	IPR713	

For use on: Porsche



VAL773

FEATURES

Diodes:6-50 Ampere
 Diameter OD:115mm
 Without Capacitor
 With Trio
 With 82 Ohm Resistor
 For use on: Peugeot Diesel

Original & X-References..

103546/54		
VALEO	NC134	NC217
MOBILETRON	RP-04R	
WAI	31-9401	
CARGO	131569	
TRANSPO	IPR773	



VAL813

FEATURES

Diodes:6-50 Ampere
 Diameter OD:115mm
 With Capacitor
 With Trio
 With 82 Ohm Resistor

Original & X-References..

VALEO	A521404A	NC142
MOBLIETRON	RP-09R	
WAI	31-9430	
CARGO	133741	
TRANSPO	IPR813	

VAL813-2

With 200 Ohm Resistor
 For use on: Peugeot



VAL201H

FEATURES

Diodes: 3-50 A Avalanche
 With Trio
 With (M8+M6)×44.5mm Battery Post
 Without negative heat sink as VAL201

Original & X-References..



VAL201

FEATURES

Diodes: 6-50A Avalanche
 With (M8+M6)×44.5mm Battery Post
 With M5×25mm Mounting Bolt
 With Trio

Original & X-References..



VAL202H

FEATURES

Diodes: 3-60 A Avalanche
 Without Trio
 With M8×30mm Battery Post
 Without negative heat sink

Original & X-References..



VAL9015A

FEATUERS

Diodes:6-60A Avalanche
 With M8×35mm Battery Post
 With M5×36.5mm Mounting Bolt
 Without Trio

Original & X-References..

TRANSP0 MER5235

Customer provide Negative heat sink



VAL9021A

FEATURES

Diodes: 6-60A Avalanche
 With M8×30mm Battery Post
 With M5×36.5mm Mounting Bolt

Original & X-References..

Customer provide Negative heat sink



VAL9026A

FEATUERS

Diodes: 6-50A Avalanche
 With M8×35mm Battery Post
 With M5×36.5mm Mounting Bolt

Original & X-References..

Customer provide Negative heat sink



VAL9032A

FEATUERS	Original & X-References..	
Diodes: 6-80A Avalanche	VALEO	593899
With M8×32mm Battery Post		
With M5×36.5mm Mounting Bolt		

Customer provide Negative heat sink



VAL9072A

FEATURES	Original & X-References..	
Diodes: 6-50A Avalanche	VALEO	TG15C059
With M8×32mm Battery Post		TG15C091
With M5×36.5mm Mounting Bolt		TG15C125

Custom provide Negative heat sink



VAL9078A

FEATURES	Original & X-References..	
Diodes: 6-80A Avalanche	VA0046	
With M8×32mm Battery Post	VALEO	TG17C041
With M5×36.5mm Mounting Post		

Customer provide Negative heat sink



VAL9079A

FEATURES	Original & X-References..	
Diodes: 6-60A Avalanche	VALEO	TG14C011
With M8×32mm Battery Post		
With M5×36.5mm Mounting Post		

Customer provide Negative heat sink



VAL205H

FEATURES	Original & X-References..	
Diodes: 3-50 A Avalanche		
Without Trio		
With (M8+M6)×44.5mm Battery Post		
Without negative heat sink as VAL205		



VAL205

FEATURES

Diodes: 6-50A Avalanche
 With (M8+M6)×44.5mm Battery Post
 With M5×25mm Mounting Bolt

Original & X-References..

Customer provide Negative heat sink



VAL206H

FEATURES

Diodes: 3-50 A Avalanche
 Without Trio
 With M8×30mm Battery Post
 Without negative heat sink as VAL206

Original & X-References..



VAL206

FEATURES

Diodes: 6-50A Avalanche
 With M8×30mm Battery Post
 With M5×25mm Mounting Bolt

Original & X-References..



VAL206A

FEATURES

Diodes: 6-50A Avalanche
 With M8×30mm Battery Post
 With M5×36.5mm Mounting Post

Original & X-References..

37300-2B101

Customer provide Negative heat sink



VAL208H

FEATURES

Diodes: 3-60 A Avalanche
 Without Trio
 With (M8+M6)×44.5mm Battery Post
 Without negative heat sink as VAL208

Original & X-References..

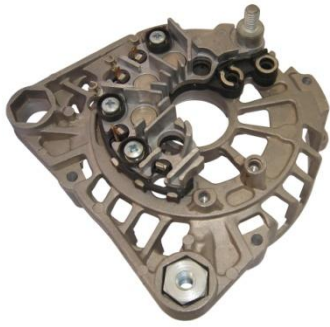

VAL208

FEATURES

Diodes: 6-60A Avalanche
 With (M8+M6)×44.5mm Battery Post
 With M5×25mm Mounting Bolt

Original & X-References..

CARGO 233615

Customer provide Negative heat sink



VAL209-2

FEATURES

Diodes : 6-50A Avalanche
 With (M8+M6) ×51.5mm Battery Post
 With M5×25mm Mounting Bolt

Original & X-References..



VAL211

FEATURES

Diodes : 6-50A Avalanche
 With (M8+M6) ×53mm Battery Post
 With M5×25mm Mounting Bolt
 With Trio

Original & X-References..

Customer provide Negative heat sink



VAL9040A

FEATURES

Diodes: 6-50A Avalanche
 With M6×47.5mm Battery Post
 With M5×25mm Mounting Bolt
 With Trio

Original & X-References..

Customer provide Negative heat sink



VAL212H

FEATURES

Diodes: 3-50 A Avalanche
 Without Trio
 With M8×34.5mm Battery Post
 Without negative heat sink as VAL212

Original & X-References..



VAL212

FEATURES

Diodes: 6-50 A Avalanche
 With M8×34.5mm Battery Post
 With M5×36.5mm Mounting Bolt
 Without Trio

Original & X-References..

Customer provide Negative heat sink



VAL213H

FEATURES

Diodes: 3-60 A Avalanche
 Without Trio
 With (M8+M6)×44.5mm Battery Post
 Without negative heat sink as VAL213

Original & X-References..



VAL213

FEATURES

Diodes: 6-60A Avalanche
 With (M8+M6)×44.5 mm Battery Post
 With M5×25mm Mounting Bolt

Original & X-References..

Customer provide Negative heat sink



VAL9042A

FEATURES

Diodes: 6-60A Avalanche
 With (M8+M6)×44.5mm Battery Post
 With M5×25mm Mounting Bolt

Original & X-References..

Customer provide Negative heat sink



VAL214H

FEATURES

Diodes: 3-60 A Avalanche
 Without Trio
 With M8×33.3mm Battery Post
 Without negative heat sink as VAL214

Original & X-References..

SG 15S021
 CA 1509IR
 CARGO 235654



VAL9027A

FEATUERS

Original & X-References..

Diodes:6-50A Avalanche
 With M8×35mm Battery Post
 With M5×36.5mm Mounting Bolt
 Without Trio

Customer provide Negative heat sink



VAL9058A

FEATURES

Original & X-References..

Diodes: 6-60A Avalanche
 With M8×33.3mm Battery Post

Customer provide Negative heat sink



VAL9018H

FEATUERS

Original & X-References..

Diodes:3-50A Avalanche
 With M8×40mm Battery Post
 Without Trio



VAL215-2

FEATURES

Original & X-References..

Diodes:6-50A Avalanche
 With M8×40mm Battery Post

VALEO	2600172
TRANSPO	MER523

Customer provide Negative heat sink



VAL9024A

FEATUERS

Original & X-References..

Diodes:6-50A Avalanche
 With M8×34.5mm Battery Post
 With M5×36.5mm Mounting Bolt
 Without Trio

TRANSPO	MER5230
---------	---------

Customer provide Negative heat sink



VAL9050A

FEATURES

Diodes: 6-50A Avalanche
 With M8×40mm Battery Post
 With M5×36.5mm Mounting Bolt

Original & X-References..

Customer provide Negative heat sink



VAL9077A

FEATUERS

Diodes: 6-50A Avalanche
 With M8×34.5mm Battery Post
 With M5×36.5mm Mounting Post

Original & X-References..

TRANSPO MER5247

Customer provide Negative heat sink



VAL216

FEATURES

Diodes : 6-50A Avalanche
 With (M8+M6) ×51.5mm Battery Post
 With M5×25mm Mounting Bolt
 With Trio

Original & X-References..

Customer provide Negative heat sink



VAL218H

FEATURES

Diodes:3-50 A Avalanche
 With (M8+M6)×44.5mm Battery Post
 Without Trio

Original & X-References..

Without negative heat sink as VAL218



VAL218

FEATURES

Diodes : 6-50A Avalanche
 With (M8+M6) ×44.5mm Battery Post
 With M5×25mm Mounting Bolt

Original & X-References..

SG7S012

Customer provide Negative heat sink



VAL220H

FEATURES

Diodes:3-50 A Avalanche
 With (M8+M6)×44.5mm Battery Post
 With Trio

Original & X-References..

Without negative heat sink as VAL220



VAL223

FEATURES

Diodes : 6-50A Avalanche
 With M6×34.5mm Battery Post
 With M5×36.5mm Mounting Bolt
 Without Trio

Original & X-References..

VALEO TG9C013

Customer provide Negative heat sink



VAL9045A

FEATUERS

Diodes: 6-50A Avalanche
 With M6×34.5mm Battery Post
 With M5×36.5mm Mounting Bolt

Original & X-References..

Customer provide Negative heat sink



VAL225

FEATURES

Diodes:6-50A Avalanche
 With (M8+M6)×53mm Battery Post
 With Trio

Original & X-References..

Customer provide Negative heat sink



VAL230

FEATURES

Diodes:6-50A Avalanche
 With M8×35mm Battery Post
 With M5×36.5mm Mounting Bolt
 Without Trio

Original & X-References..

VALEO 2650237
 TRANSP0 MER524

Customer provide Negative heat sink



VAL901

FEATURES	Original & X-References..	
Diodes: 8-50A Avalanche	VALEO	593397
With (M8+M6)×51.5mm Battery Post	CARGO	231101
With M5×25mm Mounting Bolt		
With Trio		



VAL902H

FEATURES	Original & X-References..	
Diodes: 4-50 A Avalanche		
Without Trio		
With (M8+M6)×44.5mm Battery Post		
Without negative heat sink as		



VAL902-2

FEATURES	Original & X-References..	
Diodes : 8-50A Avalanche	VALEO	SG12B019
With (M8+M6) ×44.5mm Battery Post		
With M5×25 mm Mounting Bolt		
Without Trio		
Customer provide Negative heat sink		



VAL903

FEATURES	Original & X-References..	
Diodes : 6-50A Avalanche	VALEO	2547906
With (M8+M6) ×44.5mm Battery Post		593463
With M5×25mm Mounting Bolt	CARGO	235652
With Trio	TRANSP0	MER528



VAL905

FEATURES	Original & X-References..	
Diodes : 6-50A Avalanche		
With (M8+M6) ×44.5mm Battery Post		
With M5×23mm Mounting Bolt		
Customer provide Negative heat sink		



VAL906-1

FEATURES

Diodes:6-50A Avalanche
 With(M8+M6)×41.5mm Battery Post
 Without Trio

Original & X-References..

VALEO SG913037

Customer provide Negative heat sink



VAL9014A

FEATUERS

Diodes:6-50A Avalanche
 With (M6+M6) ×47.5mm Battery Post
 Without Trio

Original & X-References..

Customer provide Negative heat sink



VAL9041A

FEATUERS

Diodes: 8-50A Avalanche
 With (M8+M6) ×44.5mm Battery Post
 With M5×25mm Mounting Bolt

Original & X-References..

Customer provide Negative heat sink



VAL9047A

FEATURES

Diodes: 8-50A Avalanche
 With (M8+M6) ×44.5mm Battery Post
 With M5×25mm Mounting Bolt

Original & X-References..

Customer provide Negative heat sink



VAL9063A

FEATURES

Diodes: 6-50A Avalanche
 With (M8+M6) ×44.5mm Battery Post
 With M5×25mm Mounting Bolt

Original & X-References..

VALEO SG12S073
 LESTER 11050
 WAI 11050N

Customer provide Negative heat sink



VAL927

FEATURES

Diodes: 6-50A Avalanche
 With (M8+M6)×44.5mm Battery Post
 With M5×25mm Mounting Bolt

Original & X-References..

VALEO	SG14B019
	SG14B020
	2549502-M2
LESTER	13970
TRANSPO	MER538



VAL928

FEATURES

Diodes: 6-50A Avalanche
 With (M8+M6)×44.5mm Battery Post
 With M5×25mm Mounting Bolt

Original & X-References..



VAL9023A

FEATUERS

Diodes:6-50A Avalanche
 With (M8+M6) ×44.5mm Battery Post
 With M5×25mm Mounting Bolt
 Without Trio

Original & X-References..

Customer provide Negative heat sink



VAL9016A

FEATUERS

Diodes:6-50A Avalanche
 With M8×35mm Battery Post
 Without Trio

Original & X-References..

TRANSPO	MER5240
---------	---------

Customer provide Negative heat sink



VAL9029A

FEATUERS

Diodes:6-50A Avalanche
 With M8×35mm Battery Post
 With M5×25mm Mounting Bolt
 Without Trio

Original & X-References..

TRANSPO	MER5201
---------	---------

Customer provide Negative heat sink



VAL9049A

FEATURES	Original & X-References..	
Diodes: 6-50A Avalanche	VALEO	SG12S084
With M8×35mm Battery Post	LESTER	13938
With M5×25mm Mounting Bolt	TRANSPO	MER5202

Customer provide Negative heat sink



VAL9074A

FEATUERS	Original & X-References..	
Diodes: 6-50A Avalanche	VALEO	2542454A, 2542559A, 2650011, 2650017, 2650132A, SG12S056, SG12S057, SG12S071, SG12S074, SG12S075, SG12S083, SG12S104
With M8×35mm Battery Post		
With M5×25mm Mounting Post		
Customer provide Negative heat sink		
For use on: (2007-01) Buick, Chevrolet, Oldsmobile, Pontiac	LESTER	13866, 13943
	TRANSPO	MER5204

VAL9060AH

FEATURES	Original & X-References..	
Diodes: 3-50A Avalanche		
With (M8+M6) ×44.5mm Battery Post		
Without Trio		



VAL9066AH

FEATURES	Original & X-References..	
Diodes: 4-50A Avalanche		
With Trio		
With (M8+M6) ×44.5mm Battery Post		



VAL9069A

FEATURES	Original & X-References..	
Diodes: 6-50A Avalanche	VALEO	A0002655009
With M8×40mm Battery Post	LESTER	11014
With M5×36.5mm Mounting Bolt	WAI	11014N

Customer provide Negative heat sink



**VAL9070A****FEATURES**

Diodes: 6-50A Avalanche
With M8×35.5mm Battery Post
With M5×36.5mm Mounting Post

Customer provide Negative heat sink

Original & X-References..

TRANSPO MER5225

DISH DIODES



7430

FEATURES

Diode: POSITIVE, 25Ampere , 300V
Dim(mm): 8.4OD
Lead(mm): 1.5Dia x20L

Original & X-References...

A.I.M.	AT-0749DP
ACE-ELECTRIC	S4305
CPC	ADSG-9P
GAP INT.LTD.	GP9172
HUCO	139419
RAYLOC	01-040-022-0037
CARGO	131509
TRANSPO	7220

7430A

Diode: POSITIVE, 25A Avalanche,
24-32V

7431

FEATURES

Diode: NEGATIVE, 25Ampere , 300V
Dim(mm): 8.4OD
Lead(mm): 1.5Dia x20L

Original & X-References...

A.I.M.	AT-0749DN
ACE-ELECTRIC	S4306
CPC	ADSG-9N
GAP INT.LTD.	GP9171
HUCO	139418
RAYLOC	01-040-022-0038
CARGO	131508
TRANSPO	7221

7431A

Diode: NEGATIVE, 25A Avalanche,
24-32V

7432

FEATURES

Diode: POSITIVE, 35Ampere , 300V
Dim(mm): 9.7OD
Lead(mm):1.5Dia x20L

Original & X-References...

A.I.M.	AT-0787DP
ACE-ELECTRIC	S4307

CPC	ADSG-9LP
GAP INT.LTD.	GP9170
HUCO	139421
TRANSPO	7230

7433

FEATURES

Diode: NEGATIVE,35Ampere , 300V
Dim(mm): 9.7OD
Lead(mm): 1.5Dia x20L

Original & X-References...

A.I.M.	AT-0787DN
ACE-ELECTRIC	S4308
CPC	ADSG-9LN
GAP INT.LTD.	GP9169
HUCO	139420
TRANSPO	7231

CAN DIODES



7650

FEATURES

Diode: POSITIVE, 25Ampere , 300V
Dim(mm): 8.8OD 5/16"
Lead(mm): 1.5Dia x24.6L

Original & X-References...

JUST PAPTS	F1-1460P R
MOBILETRON	MFDD00061
	DD-1011
SOLID STATE	DF7650
WAI	32-702-1
CARGO	131507
TRANSPO	8524

7651

FEATURES

Diode: NEGATIVE, 25Ampere , 300V
Dim(mm): 8.8OD 5/16"
Lead(mm): 1.5Dia x24.6L

Original & X-References...

MOBILETRON	MFDD00051
	DD-1010
WAI	32-701-1
CARGO	131507
TRANSPO	8525



7652

FEATURES

Diode: POSITIVE, 25Ampere , 300V
Dim(mm): 8.8OD 5/16"
Lead(mm): Fork

Original & X-References...

RENARD	7652
SAS COMPONENTS	9922
WAGNER	W04X-30
WAI	32-724
TRANSPO	8534

7653

FEATURES

Diode: NEGATIVE, 25Ampere , 300V
Dim(mm): 8.8OD 5/16"
Lead(mm): Fork

Original & X-References...

RENARD	7653
WAGNER	W04X-31
WAI	32-723
WIEGEL	DIOUN800021
TRANSPO	8535

BLOCK DIODES



DB8330

FEATURES

Diode: POSITIVE, 30Ampere , 200V

Original & X-References...

SAS COMPONENTS	7664
WAI	32-8300
CARGO	133704
TRANSP0	8330

DB8331

FEATURES

Diode: NEGATIVE, 30Ampere , 200V

Original & X-References...

SAS COMPONENTS	7665
WAI	32-8301
TRANSP0	8331
CARGO	133705

DB8334

FEATURES

Diode: POSITIVE, 35Ampere , 200V

Original & X-References...

WAI	32-8303
WIEGEL	DIOUN800015
TRANSP0	8334

DB8335

FEATURES

Diode: NEGATIVE, 35Ampere , 200V

Original & X-References...

WAI	32-8304
WIEGEL	DIOUN800016
TRANSP0	8335

BUTTON DIODES



DB001

FEATURES

Diode: 25Ampere , 200V

Dim(mm): 8.5OD×6T

Original & X-References...

A.I.M	AD-704D
ACE-ELECTRIC	S4301
CPC	ADME-009 DME-009
HUCO	13 9427
IPM	1A-1462
WAI	32-734
TRANSP0	8125

DB002

FEATURES

Diode: 35A Avalanche , 24-32V

Dim(mm): 10OD×6T

Original & X-References...

WAI	32-731
WIEGEL	DIOUN800009
TRANSP0	8135

DB003

FEATURES

Diode: 50Ampere , 200V

Dim(mm): 10OD×6T

Original & X-References...

AMSCO	D2-25
HUCO	13 9422
JUST PARTS	D11463HD
LECLERCQ	009-0095
RENARD	7620
SAS COMPONENTS	1132
WAI	32-735
TRANSP0	8150

DB004

FEATURES

Diode: 50A Avalanche , 24-32V

Dim(mm): 10OD×6T

Original & X-References...

TRANSP0	8153
---------	------

AXIAL LEAD DIODES



IN8010

FEATURES

Diode: 1.0 Ampere , 200V

Original & X-References...

A.I.M	AD-0713D
CARGO	130937
CPC	ADME-0111
J&N ELECTRIC	171-01000
JUST PARTS	D11472
TRANSP0	8010

IN8015

FEATURES

Diode: 1.5 Ampere , 200V

Original & X-References...

A.I.M	AD-0713D1.5
CPC	ADME-011
J&N ELECTRIC	171-01001
RENARD	7500
WAI	32-8904
WIEGEL	DIOUN800005
TRANSP0	8015

IN8025

FEATURES

Diode: 2.5 Ampere , 200V

Original & X-References...

RENARD	7502
WAI	32-8908
WIEGEL	DIOUN800006
TRANSP0	8025

IN8030

FEATURES

Diode: 3.0 Ampere , 200V

Original & X-References...

CARGO	131294
DELCO	1964187
J&N ELECTRIC	171-01002
LECLERCQ	009-0396
WAI	32-8905
SAS COMPONENTS	1088
TRANSP0	8030

STUD MOUNT DIODES



**QZ2540
FEATURES**

Diode: POSITIVE, 25Ampere , 400V
Stud: 1/4"-28

**QZ2541
FEATURES**

Diode: NEGATIVE, 25Ampere , 400V
Stud: 1/4"-28

**QZ5040
FEATURES**

Diode: POSITIVE, 50Ampere , 400V
Stud: 1/4"-28

**QZ5041
FEATURES**

Diode: NEGATIVE, 50Ampere , 400V
Stud: 1/4"-28

**QZ7540
FEATURES**

Diode: POSITIVE, 70Ampere , 400V
Stud: 1/4"-28

Original & X-References...

CARGO	133495
LECLERCQ	009-0097
WAI	32-769
TRANSPO	1120

**QZ7541
FEATURES**

Diode: NEGATIVE, 75Ampere , 400V
Stud: 1/4"-28

Original & X-References...

J&N ELECTRIC	171-06001
WAI	32-768
TRANSPO	1120-R

DELCO TRIOS



**DJ1001
FEATURES**

DIODE TRIO DR 27SI
For use on: Delco 27SI, Type 100/200
Alternators

Original & X-References...

A.I.M	AO-0727D
ACE-ELECTRIC	S2201
AES	92
AMC	801817 830891
AMSCO	DA-5
BWD	SC116



**DJ524
FEATURES**

DIODE TRIO DR 11SI
Orange Case
For use on: European & South American
Vehicles With Delco 11 SI Alternators

Original & X-References...

CARGO	130674	132611
CPC	ARDE-112	
DELCO	1984032	3472312
	7982635	DR3901
FILKO	131ZT	
GAPINT.LTD.		GP210
TRANSPO		DET524



**DJ527
FEATURES**

DIODE TRIO DR 10SI
Orange Case
For use on: Delco 10 , 12 , 15 , 17SI
Alternators

Original & X-References...

A.I.M	AO-0710D
ACE-ELECTRIC	S1390
AES	91
AMSCO	DA-109
ATP	DR10T
CATERPILLAR	9N 1202
CPC	ATDE-690
TRANSPO	D527



**DJ528
FEATURES**

DIODE TRIO DR 10SI
Black Case
For use on: Delco 10 , 12 , 15 , 17SI
Alternators

Original & X-References...

A.I.M	AO-0710D
ACE-ELECTRIC	S1390
AES	91
AMSCO	DA-109
ATP	DR10T
CATERPILLAR	9N 1202
CPC	ATDE-690
TRANSPO	D528



DJ797

FEATURES

DIODE TRIO DR 30SI

For use on: Delco 30SI Alternators

Original & X-References...

A.I.M	AO-0730D
ACE-ELECTRIC	S2245
AMSCO	DA-5T
BWD	SC228
CARGO	131416
DELCO	10456389 1876797
ECHLIN	AC 63
TRANSPO	D797



DJ985

FEATURES

DIODE TRIO DR 21SI

For use on: Delco 17& 21SI Alternators

Original & X-References...

A.I.M	AO-0717D
ACE-ELECTRIC	S1662
AEC	94
AMSCO	DA-234
CARGO	131897
DELCO	1988985 D3927
TRANSPO	D985

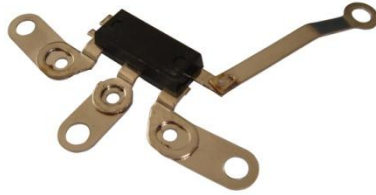

DT182

FEATURES

DIODE TRIO DR 33SI

For use on: Industrial, Agricultural , Delco 321-734, 10459114

Original & X-References...

DELCO	10491182
J&N ELECTRIC	171-12106
WAI	33-109
TRANSPO	DT182

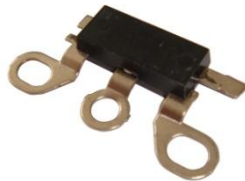

DT182-1

FEATURES

DIODE TRIO DR 33SI



DT22

FEATURES

DIODE TRIO DR 22SI

With Quick-Start Circuit

For use on: Delco 22SI Alternators

Original & X-References...

DELCO	10487805
J&N ELECTRIC	171-12103
LECLERCO	009-0528
WAGNER	D04-08
WAI	33-108
TRANSPO	DT22



LJ79026

FEATURES

Diode: 1A , 200V

For use on: Leece Neville 4400-4700J, 7000-7700J Alternators

Original & X-References...

A.I.M	AX-0705D
ACE-ELECTRIC	S1427
AMSCO	LN-193
JUST PARTS	LN11487
WAI	33-502
TRANSPO	L79026



LJ79027

FEATURES

Diode: 1A, 200V

For use on: Leece Neville 2300-2800JB Alternators

Original & X-References...

AES	1054
AMSCO	LN-191
WAI	33-500
TRANSPO	L79027



S5231

FEATURES

Diode: 3A , 800V



SJ5231
FEATURES

Diode: 3A, 800V



SJ5260
FEATURES

DIODE TRIO DR 21SI

Original & X-References...

CARGO 233201

PRESS-FIT TRIOS



8440-1B
FEATURES

Diode: POSITIVE, 35Ampere, 300V
Dim(mm): 12.78(1/2")OD
Lead(mm): 1.3Dia×23L

Original & X-References...

BOSCH	0 270 100 105
	0 270 100 311 0 270 100 333
HUCO	13 9407
WAI	32-9101
TRANSPO	8234
CARGO	130912

8442-1B
FEATURES

Diode: POSITIVE, 50Ampere, 300V
Dim(mm): 12.78(1/2")OD
Lead(mm): 1.3Dia×23L

Original & X-References...

WAI	32-200
TRANSPO	8252

8440-2B
FEATURES

Diode: POSITIVE, 35A Avalanche,
34-45V
Dim(mm): 12.78(1/2")OD
Lead(mm): 1.3Dia×23L

8442-2B
FEATURES

Diode: POSITIVE, 50A Avalanche,
34-45V
Dim(mm): 12.78(1/2")OD
Lead(mm): 1.3Dia×23L

Original & X-References...

WAGNER	W04X-44
TRANSPO	8466

8440B
FEATURES

Diode: POSITIVE, 35A Avalanche,
24-32V
Dim(mm): 12.78(1/2")OD
Lead(mm): 1.3Dia×23L

Original & X-References...

WAGNER	W04X-38
WIEGEL	DIOUN800017
TRANSPO	8440

8442B
FEATURES

Diode: POSITIVE, 50A Avalanche,
24-32V
Dim(mm): 12.78(1/2")OD
Lead(mm): 1.3Dia×23L

Original & X-References...

WAGNER	W04X-40
WAI	32-9103
WIEGEL	DIOUN800019
TRANSPO	8454

8442C
FEATURES

Diode: POSITIVE, 50A Avalanche,
24-32V
Dim(mm): 12.87(1/2")OD
Lead(mm): 1.3Dia×23L

8446B
FEATURES

Diode: POSITIVE, 60A Avalanche,
24-32V
Dim(mm): 12.78(1/2")OD
Lead(mm): 1.3Dia×23L

8446C
FEATURES

Diode: POSITIVE, 60A Avalanche,
24-32V
Dim(mm): 12.87(1/2")OD
Lead(mm): 1.3Dia×23L



8441-1B
FEATURES

Diode: NEGATIVE, 35Ampere, 300V
Dim(mm): 12.78(1/2")OD
Lead(mm): 1.3Dia×23L

Original & X-References...

BOSCH	0 270 100 354
	0 270 100 358
HUCO	13 9406
WAI	32-9100
TRANSPO	8235

8443-1B
FEATURES

Diode: NEGATIVE, 50Ampere, 300V
Dim(mm): 12.78(1/2")OD
Lead(mm): 1.3Dia×23L

Original & X-References...

WAI	32-201
TRANSPO	8253

8441-2B
FEATURES

Diode: NEGATIVE, 35A Avalanche,
34-45V
Dim(mm): 12.78(1/2")OD
Lead(mm): 1.3Dia×23L

8443-2B
FEATURES

Diode: NEGATIVE, 50A Avalanche,
34-45V
Dim(mm): 12.78(1/2")OD
Lead(mm): 1.3Dia×23L

Original & X-References...

WAGNER	W04X-43
TRANSPO	8467

8441B
FEATURES

Diode: NEGATIVE, 35A Avalanche,
24-32V
Dim(mm): 12.78(1/2")OD
Lead(mm): 1.3Dia×23L

Original & X-References...

WAGNER	W04X-37
WIEGEL	DIOUN800018
TRANSPO	8441

8443B
FEATURES

Diode: NEGATIVE, 50A Avalanche,
24-32V
Dim(mm): 12.78(1/2")OD
Lead(mm): 1.3Dia×23L

Original & X-References...

WAGNER	W04X-39
WAI	32-9102
WIEGEL	DIOUN800020
TRANSPO	8455

8443C
FEATURES

Diode: NEGATIVE, 50A Avalanche,
24-32V
Dim(mm): 12.87(1/2")OD
Lead(mm): 1.3Dia×23L

8447B
FEATURES

Diode: NEGATIVE, 60A Avalanche,
24-32V
Dim(mm): 12.78(1/2")OD
Lead(mm): 1.3Dia×23L

8447C
FEATURES

Diode: NEGATIVE, 60A Avalanche,
24-32V
Dim(mm): 12.87(1/2")OD
Lead(mm): 1.3Dia×23L



8630-1B
FEATURES

Diode: POSITIVE, 35Ampere, 300V
Dim(mm): 11.78 OD
Lead(mm): 1.5Dia×20L

Original & X-References...

WAI	32-8105
WIEGEL	DIOUN800024
TRANSPO	8630

8630-1C
FEATURES

Diode: POSITIVE, 35Ampere, 300V
Dim(mm): 11.87 OD
Lead(mm): 1.5Dia×20L

8632-1B
FEATURES

Diode: POSITIVE, 50Ampere, 300V
Dim(mm): 11.78 OD
Lead(mm): 1.5Dia×20L

8632-1C
FEATURES

Diode: POSITIVE, 50Ampere, 300V
Dim(mm): 11.87 OD
Lead(mm): 1.5Dia×20L
TRANSPO 8652
WAI 32-8107

8632B
FEATURES

Diode: POSITIVE, 50 A Avalanche,
19-32V
Dim(mm): 11.78 OD
Lead(mm): 1.5Dia×20L

Original & X-References...

WAI	32-8109
WIEGEL	DIOUN800028
TRANSPO	8660

8632C
FEATURES

Diode: POSITIVE, 50 A Avalanche,
19-32V
Dim(mm): 11.87 OD
Lead(mm): 1.5Dia×20L



8631-1B
FEATURES

Diode: NEGATIVE, 35Ampere, 300V
Dim(mm): 11.78 OD
Lead(mm): 1.5Dia x20L

Original & X-References...

WAI	32-8104
WIEGEL	DIOUN800025
TRANSPO	8631

8631-1C
FEATURES

Diode: NEGATIVE, 35Ampere, 300V
Dim(mm): 11.87 OD
Lead(mm): 1.5Dia x20L

8633-1B
FEATURES

Diode: NEGATIVE, 50Ampere, 300V
Dim(mm): 11.77 OD
Lead(mm): 1.5Dia x20L

8633-1C
FEATURES

Diode: NEGATIVE, 50Ampere, 300V
Dim(mm): 11.87 OD
Lead(mm): 1.5Dia x20L

8633B
FEATURES

Diode: NEGATIVE, 50 A Avalanche,
19-32V
Dim(mm): 11.78 OD
Lead(mm): 1.5Dia x20L

Original & X-References...

WAI	32-8108
WIEGEL	DIOUN800029
TRANSPO	8661

8633C
FEATURES

Diode: NEGATIVE, 50 A Avalanche,
19-32V
Dim(mm): 11.87 OD
Lead(mm): 1.5Dia x20L



QZ3520
FEATURES

Diode: POSITIVE, 35Ampere, 300V
Dim(mm): 12.75 OD
Lead(mm): 1.4Dia x29L

QZ3521
FEATURES

Diode: NEGATIVE, 35Ampere, 300V
Dim(mm): 12.75 OD
Lead(mm): 1.4Dia x29L



QZ5020
FEATURES

Diode: POSITIVE, 50Ampere, 300V
Dim(mm): 12.75 OD
Lead(mm): 2.5Dia x16.2L

QZ5021
FEATURES

Diode: NEGATIVE, 50Ampere, 300V
Dim(mm): 12.75 OD
Lead(mm): 2.5Dia x16.2L



S-15B
FEATURES

Diode: POSITIVE, 25Ampere, 300V
Dim(mm): 11 OD
Lead(mm): Fork, 2mm x18.5L

S-16B
FEATURES

Diode: NEGATIVE, 25Ampere, 300V
Dim(mm): 11 OD
Lead(mm): Fork, 2mm x18.5L



7700
FEATURES

Diode: POSITIVE, 25Ampere, 300V
Dim(mm): 12.7(1/2")OD
Lead(mm): 1.5Dia x25L

Original & X-References...

MOBILETRON	DD-1013
NAPA	AC1P
RENARD	7700
TRANSPO	8724

7701
FEATURES

Diode: NEGATIVE, 25Ampere, 300V
Dim(mm): 12.7(1/2")OD
Lead(mm): 1.5Dia x25L

Original & X-References...

MOBILETRON	DD-1012
NAPA	AC1N
TRANSPO	8725



7780-B

FEATURES

Diode: POSITIVE, 35Ampere, 300V
 Dim(mm): 12.7 (1/2")OD
 Lead(mm): 1.5Dia×25L

Original & X-References...

MOBILETRON	DD-1015
TRANSPO	8734

7781-B

FEATURES

Diode: NEGATIVE, 35Ampere, 300V
 Dim(mm): 12.7(1/2") OD
 Lead(mm): 1.5Dia×25L

Original & X-References...

MOBILETRON	DD-1014
TRANSPO	8735



7770

FEATURES

Diode: POSITIVE, 50Ampere, 300V
 Dim(mm): 12.7 (1/2")OD
 Lead(mm): 2.5Dia×20.8L

Original & X-References...

WAGNER	W04X-05
WAI	32-755
TRANSPO	8752

7771

FEATURES

Diode: NEGATIVE, 50Ampere, 300V
 Dim(mm): 12.7 (1/2")OD
 Lead(mm): 2.5Dia×20.8L

Original & X-References...

WAI	32-754
TRANSPO	8753



7800

FEATURES

Diode: POSITIVE, 25Ampere, 300V
 Dim(mm): 12.7 (1/2")OD
 Lead(mm): 1.4 Dia×29.3L

7801

FEATURES

Diode: NEGATIVE, 25Ampere, 300V
 Dim(mm): 12.7 (1/2")OD
 Lead(mm): 1.4 Dia×29.3L



7880

FEATURES

Diode: POSITIVE, 35Ampere, 300V
 Dim(mm): 12.7 (1/2")OD
 Lead(mm): 1.4 Dia×29.3L

Original & X-References...

CHRYSLLEY	3000 047	CH4005
DUBOIS	5003	
TRANSPO	8824	

7881

FEATURES

Diode: NEGATIVE, 35Ampere, 300V
 Dim(mm): 12.7 (1/2")OD
 Lead(mm): 1.4 Dia×29.3L

Original & X-References...

CHRYSLLEY	3000 046	CH4004
DUBOIS	5004	
TRANSPO	8825	



8624

FEATURES

Diode: POSITIVE, 35Ampere, 300V
 Dim(mm): 13 OD
 Lead(mm): 2Dia×18.5L

Original & X-References...

CARGO	134495
HITACHI	Q06B
WAI	32-8101
TRANSPO	8624

8625

FEATURES

Diode: NEGATIVE, 35Ampere, 300V
 Dim(mm): 13 OD
 Lead(mm): 2Dia×18.5L

Original & X-References...

CARGO	134494
HITACHI	Q05B
WAI	32-8100
TRANSPO	8625



7770-1

FEATURES

Diode: POSITIVE, 50Ampere, 300V
 Dim(mm): 12.7 (1/2")OD
 Lead(mm): 35L

7771-1

FEATURES

Diode: NEGATIVE, 50Ampere, 300V
 Dim(mm): 12.7(1/2") OD
 Lead(mm): 35L



7812

FEATURES

Diode: POSITIVE, 35Ampere, 300V
 Dim(mm): 12.7 (1/2")OD
 Lead(mm): 35L

7813

FEATURES

Diode: NEGATIVE, 35Ampere, 300V
 Dim(mm): 12.7(1/2") OD
 Lead(mm): 35L



7814

FEATURES

Diode: POSITIVE, 35Ampere, 300V
 Dim(mm): 12.7 (1/2")OD
 Lead(mm): 17L

7815

FEATURES

Diode: NEGATIVE, 35Ampere, 300V
 Dim(mm): 12.7 (1/2")OD
 Lead(mm): 17L



7900

FEATURES

Diode: POSITIVE, 25Ampere, 300V
 Dim(mm): 12.75 (1/2")OD
 Lead(mm): 30

Original & X-References...

DELCO	1852929	1959829
WAI		32-108
TRANSP		8960

7901

FEATURES

Diode: NEGATIVE, 25Ampere, 300V
 Dim(mm): 12.75 (1/2")OD
 Lead(mm): 30

Original & X-References...

DELCO	1852928	1959830
WAI		32-107
TRANSP		8961



7902

FEATURES

Diode: POSITIVE, 35Ampere, 300V
 Dim(mm): 12.75(1/2")OD
 Lead(mm): 30L

7903

FEATURES

Diode: NEGATIVE, 35Ampere,300V
 Dim(mm): 12.75(1/2")OD
 Lead(mm): 30



7960

FEATURES

Diode: POSITIVE, 35Ampere, 300V
 Dim(mm): 12.7 (1/2")OD
 Lead(mm): 40L

7961

FEATURES

Diode: NEGATIVE, 35Ampere, 300V
 Dim(mm): 12.7(1/2") OD
 Lead(mm): 40L



7980

FEATURES

Diode: POSITIVE, 35Ampere, 300V
 Dim(mm): 12.75 (1/2")OD
 Lead(mm): 30L
 Popular for Delco 25SI

Original & X-References...

CARGO	130672
DELCO	1971672
WAI	32-103
TRANSP	8980

7981

FEATURES

Diode: NEGATIVE, 35Ampere, 300V
 Dim(mm): 12.75 (1/2")OD
 Lead(mm): 30L
 Popular for Delco 25SI

Original & X-References...

CARGO	133194
DELCO	1971671
WAI	32-102
TRANSP	8981

PRESS-FIT OJ DIODE



**BN354P
FEATURES**

Diode: POSITIVE, 35Ampere, 300V
Dim(mm): 12.80(1/2")OD
Lead(mm): 1.3Dia x23L

**BN354N
FEATURES**

Diode: NEGATIVE, 35Ampere, 300V
Dim(mm): 12.80(1/2")OD
Lead(mm): 1.3Dia x23L

**BN35LP
FEATURES**

Diode: POSITIVE, 35Ampere,
19-24V Avalanche
Dim(mm): 12.80(1/2")OD
Lead(mm): 1.3Dia x23L

**BN35LN
FEATURES**

Diode: NEGATIVE, 35Ampere,
19-24V Avalanche
Dim(mm): 12.80(1/2")OD
Lead(mm): 1.3Dia x23L

**BN35MP
FEATURES**

Diode: POSITIVE, 35Ampere,
24-32V Avalanche
Dim(mm): 12.80(1/2")OD
Lead(mm): 1.3Dia x23L

**BN35MN
FEATURES**

Diode: NEGATIVE, 35Ampere,
24-32V Avalanche
Dim(mm): 12.80(1/2")OD
Lead(mm): 1.3Dia x23L

**BN35HP
FEATURES**

Diode: POSITIVE, 35Ampere,
34-42V Avalanche
Dim(mm): 12.80(1/2")OD
Lead(mm): 1.3Dia x23L

**BN35HN
FEATURES**

Diode: NEGATIVE, 35Ampere,
34-42V Avalanche
Dim(mm): 12.80(1/2")OD
Lead(mm): 1.3Dia x23L

**BN504P
FEATURES**

Diode: POSITIVE, 50Ampere, 300V
Dim(mm): 12.80(1/2")OD
Lead(mm): 1.3Dia x23L

**BN504N
FEATURES**

Diode: NEGATIVE, 50Ampere, 300V
Dim(mm): 12.80(1/2")OD
Lead(mm): 1.3Dia x23L

**BN50LP
FEATURES**

Diode: POSITIVE, 50Ampere,
19-24V Avalanche
Dim(mm): 12.80(1/2")OD
Lead(mm): 1.3Dia x23L

**BN50LN
FEATURES**

Diode: NEGATIVE, 50Ampere,
19-24V Avalanche
Dim(mm): 12.80(1/2")OD
Lead(mm): 1.3Dia x23L

**BN50MP
FEATURES**

Diode: POSITIVE, 50Ampere,
24-32V Avalanche
Dim(mm): 12.80(1/2")OD
Lead(mm): 1.3Dia x23L

**BN50MN
FEATURES**

Diode: NEGATIVE, 50Ampere,
24-32V Avalanche
Dim(mm): 12.80(1/2")OD
Lead(mm): 1.3Dia x23L

**BN50HP
FEATURES**

Diode: POSITIVE, 50Ampere,
34-42V Avalanche
Dim(mm): 12.80(1/2")OD
Lead(mm): 1.3Dia x23L

**BN50HN
FEATURES**

Diode: NEGATIVE, 50Ampere,
34-42V Avalanche
Dim(mm): 12.80(1/2")OD
Lead(mm): 1.3Dia x23L



YD-T004

For use on : TOYOTA
CARGO 230116
021630-0650



YD-T008



YD-T010

CARGO 132426
For : HIR252
L150-43303

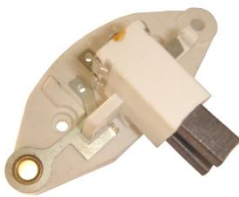

YD-T011



YD-T014

Capacitor : 0.47uF . 250V
CARGO 135226
021630-0602



YD-T015

Capacitor : 0.47uF . 250V



YD-T022

CARGO 135640
1403-0003



YD-T025

For : HIR766
L180G-4330



YD-T027

For : HIR767
L170G-3330



YD-T029

Replacing 903 902 0
Servicing A124N A12M 12V
Complete w/brushes
CARGO 130703 130702 133547
74999461



YD-T030

For : HIR776

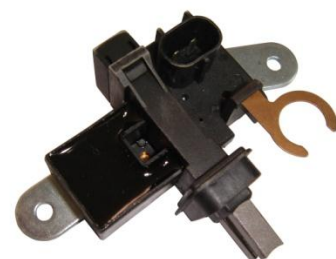

B-001

Capacitor : 2.2uF . 250V



B-002
Brush Holder Assy
For : FR3G



B-003
10475746
For :Delco CS130D Series IR/IF
Alternators WAI 39-109
Components:38-119/120/39-1209
Brush Holder

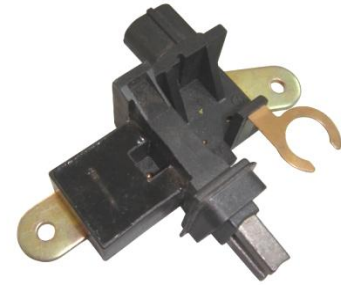

B-004
Capacitor : 2.2uF . 250V



B-005
For : H111130



B-006



B-007



B-008



B-009
CARGO 135419



B-010
Brush Holder Assy.
For: Nippondenso IR/IF Alternators
WAI 39-8200 CARGO 132084



B-011



B-012



B-013



B-014



B-015
021620-2530



B-016



B-017



B-032



B-040



B-046



B-047



B-048



B-049



RJ001
Capacitor:2.2uF.250V



RJ002
Capacitor : 2.2Uf/250V



RJ003
2.2uF.250V
CA766 HIR776



RJ004
HIR111ZT



RJ005
1.5uF.160V
CS144



RJ006
1.5uF.220V



RJ007
2.2uF.100V



RJ008
2.2uF.100V



RJ009
2.2uF.160V



RJ010
1.5uF.250V
7mm Eyelet, 51mm Lead Length
46-1107-20SI



RJ011
1.5uF.250V
4.5mm Eyelet, 50mm Lead Length
46-1101 -10SI



RJ012
0.22uF.400V



RJ013
0.22uF.400V



RJ014
0.5uF.250V
HI11810ZT



RJ015

0.47uF.250V
YD-T014/5



RJ016

0.5uF.200V
46-5101(L96545)



RJ025

Capacitor:2.2uF.250V
CARGO 139580
L180G-2318



RJ026

Capacitor:2.2uF.250V
CARGO 138731
L180G-1318



RJ12015

Capacitor:2.2uF.250V
 CARGO 232833
 FOOM 146 622/0 124 415 005/
 146 718



RJ12016

Capacitor:2.2uF.250V
 CARGO 139926
 FOOM 146 609/0 124 225
 001,002,004,009,022,023,024,025



RJ12017

Capacitor:2.2uF.400V
 CARGO 139656
 FOOM 126603



RJ12019B

Capacitor:2.2uF.250V
 FOOM 146659



RJ12022

Capacitor:2.2uF.400V
 CARGO 232192
 FOOM 146644



RJ408

Capacitor:2.2uF.250V



RJ410

Capacitor:2.2uF.250V
 CARGO 139928
 FOOM 146626



RJ546



1918



2564



2923



C-003



C-004

Capacitor:2.2uF.250V



C-006

Capacitor:2.2uF.250V



C-007



C-008



C-009



C-010



C-011

2547772



C-012

1615-0007



C-013



C-014



C-015



C-016



C-017
2548336



C-018



C-019



C-020



C-021



C-022



C-023



C-024
Capacitor : 2.2Uf/250V
0124515016



C-025
Capacitor : 2.2Uf/250V
A628592A FOOM 146761



C-026



C-029



C-030



C-031



C-032



C-033



C-034



C-036



C-037



C-038



C-039



C-045



C-049



C-050



C-051

**C-052**



YD-T001

Capacitor:2.7uF.250V
For use on :NIPPONDENSO
CARGO 234501
026220-0150



YD-T002

Capacitor:0.47uF.250V
For use on :NIPPONDENSO
CARGO 231453
126220-0050



YD-T003

Capacitor:1uF.100V
For use on :NIPPONDENSO
WAI 46-82201
CARGO 231893
126220-0110



YD-T006

Capacitor:1.5uF.100V
For use on :NIPPONDENSO
CARGO 234727
TRANSPO INP421
1405-0008



YD-T007

CARGO 232212



YD-T012

Capacitor:1.5uF.100V
For use on :NIPPONDENSO
CARGO 235691



YD-T013

Capacitor:1.5uF.100V
CARGO 235673
TRANSPO IN420



YD-T016

Servicing 633 21711 63341711
Terminal
CARGO 233825
1220-0043



YD-T017

CARGO 232464
1920-0044



YD-T018

Servicing 633 21679
B+ Terminal
CARGO 232465
MM8047



YD-T019

CARGO 233823
1917-0003



YD-T021



YD-T023

A13V1241
KOPIE
1320-0138



YD-T026

CARGO 234069
1920-0057



YD-T028

Replacing 593288
CARGO 139451



YD-T032

For: NPR920



YD-T033

CARGO 232215
2547987



RJ800

Capacitor:2.2uF.250V
CARGO 135514
95-0275



RJ802

Capacitor:2.2uF.250V
CARGO 135433



RJ808

Capacitor:2.2uF.250V
CARGO 136644



RJ814

Capacitor:2.2uF.250V
CARGO 135495
592934



RJ844

Capacitor:2.2uF.250V
CARGO 137522
593233



T-001

Resistor 460 Ohm/2W
For:HI11810ZT



T-002

Capacitor:2.2uF.250V



T-003

CARGO: 235458
 VALEO: 2542524 2542771
 2548655



T-005

Servicing A127 54022487
 Resistor
 CARGO 231353
 1220-0044



T-006



T-007



A718-1



A1341



A1494



T-012

361°



T-016



T-017