



00-001/LUR223

FEATURES

A-Circuit
Voltage Set Point **14.60 V**

For use on : Ford, J.I. Case, Massey
Ferguson Tractors & other Lucas 21TR
Application

Original & X-References..

LUCAS			
37701	37703	37705	
37707	54048473	54048600	
54205986	5420617		
MOBILETRON		VR-LC111	
USI		71-00001	
WAI		35-9209	
CARGO		131277	
TRANSPO		IL223	



00-002/LUR211

FEATURES

A-Circuit
Voltage Set Point **14.60V**

For use on : Case, Jaguar, Lotus
Massey Ferguson, MG

Original & X-References..

LUCAS			
37534	37538	37541	37555
37558	37561		
TRANSPO		IL211	



00-003/LUR225

FEATURES

A-Circuit
Voltage Set Point **28.50 V**

For use on : Ford Tractor JCB
Equipment Massey Ferguson

Original & X-References..

LUCAS			
37735		UCB 153	
MOBILETRON		VR-LC111B	
WAI		35-9211	
CARGO		135231	
TRANSPO		IL225	



00-005

FEATUERS

A-Circuit
Voltage Set Point **14.50 V**

Original & X-References..



01-010/DCR21

FEATURES

A-Circuit
 Voltage Set Point **14.10 V**
 Field Shorted Circuit Protection
 O.E. Grade

Original & X-References..

DELCO	1116360	1116390	1116407
	1116433	1116435	1116442
USI		71-10053	
WAI		35-126	35-126-2
TRANSP0		D21	



01-011/DCR30

FEATURES

A-Circuit
 Voltage Set Point **28.10 V**
 O.E. Grade

01-022

A-Circuit
 Voltage Set Point **27.50 V**
 OE Grade

01-030

A-Circuit
 Voltage Set Point **28.10 V**

Original & X-References..

DELCO	1105510	1116388	1116404
	1894460	1984287	1987518
USI		71-10056	
WAI		35-106	35-106-1
TRANSP0		D30	



01-026

FEATUERS

A-Circuit
 Voltage Set Point **14.60 V**

Original & X-References..



01-027

FEATUERS

A-Circuit
 Voltage Set Point **14.60 V**

Original & X-References..

DELCO	94648534	D673
WAI	35-153	
TRANSP0	DE608	



01-032

FEATUERS

A-Circuit
 Voltage Set Point **14.60 V**

Original & X-References..

DELCO	1116380	1116384
	1116385	1116392
USI	71-10001	
WAI	35-101	
MOBILETRON	VR-D668	
TRANSP0	D101	



01-046

FEATUERS	Original & X-References..				
B-Circuit Voltage Set Point 14.60 V	DELCO 27SI/Type Alternators	10SI 100	12SI 205	15SI Series IR/EF	17SI D713/D10AC



01-047

FEATUERS	Original & X-References..				
A-Circuit Voltage Set Point 14.00 V	DELCO 1894489 WAI TRANSPO	1116389* D669	1116406 D672 35-105	1116407	D102HD



01-001

FEATURES	Original & X-References..	
A-Circuit Voltage Set Point 14.60 V	DELCO MOBILETRON CARGO	276010 VR-D276 139467
For use on: Daewoo Espero GM Satum Lemans & Prince	DAEWOO TRANSPO	276010 D403



01-002

FEATURES	Original & X-References..
A-Circuit Voltage Set Point 14.60 V	



01-004/DER701

FEATURES	Original & X-References..	
A-Circuit Voltage Set Point 14.80 V	DELCO 10475019 10479923 10479955	19009701 10479914 10479947 1204270
01-015 A-Circuit Voltage Set Point 14.50 V	MOBILETRON USI WAI CARGO TRANSPO	VR-D701 71-10022 35-152 135336 DE701
For use on: Opel Corsa, Omega Vectra, Astra, Fontera, Tigra		



01-005

FEATURES

B-Circuit
 Voltage Set Point **14.40 V**
 Soft Start **30 %**
 Field Shorted Circuit Protection
 Under Voltage Indication
 Over Voltage Indication
 DFM Function
 Self Exciting Function

Original & X-References..

DELCO
 1051-4474/4152
 860-0032/0096/0100/0151/0152
 /0164/0165/1665/0167/0168
 1902-0900/0901/0902
 LESTER 870/2/3/4/5/6/7
 240-4069/4070/4071/4072/4073/4076
 TRANSPO D4152

For use on: Delco 24SI series



01-007/DCR705

FEATURES

B-Circuit
 Voltage Set Point **14.70 V**
 Soft Start **30 %** LRC **10 sec**
 Field Shorted Circuit Protection
 Under / Over Voltage Indication
 DFM Function

Original & X-References..

DELCO 19009705
 MOBILETRON VR-D705H
 UNIPOINT YR-860
 USI 71-10030
 WAI 35-137
 CARGO 231184
 TRANSPO D705

For use on: Buick Skylark, Chevrolet
 Cavalier, Pontiac Grand-Am, Sunfire



01-008/DCR702HD

FEATURES

B-Circuit
 Voltage Set Point **14.70 V**
 Soft Start **30 %**
 LRC **5 sec**
 Field Shorted Circuit Protection
 Under Voltage Indication
 Over Voltage Indication

Original & X-References..

DELCO 19009702 13120469
 1116411 1116437
 1116429 1116436
 USI 71-10044
 TRANSPO D702HD

01-036

Voltage Set Point **14.15 V**



01-013

FEATURES

B-Circuit
 Voltage Set Point **14.60 V**
 Soft Start **30 %**
 LRC **5 sec**
 Field Shorted Circuit Protection
 Under Voltage Indication
 Over Voltage Indication

Original & X-References..

DELCO 1116411 1116429
 1116436 1116437
 D677 D685
 D698
 USI 71-10041
 TRANSPO D411HD

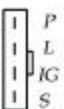

01-014

FEATURES

A-Circuit
 Voltage Set Point **14.60 V**
 Soft Start **30 %**
 LRC **5 sec**
 Field Shorted Circuit Protection
 Under Voltage Indication
 Over Voltage Indication

Original & X-References..



01-016

FEATURES

B-Circuit
 Voltage Set Point **14.20 V**
 Soft Start **30 %**
 Field Shorted Circuit Protection
 Under Voltage Indication
 Over Voltage Indication
 DFM Function
 Self Exciting Function

Original & X-References..

DELCO	19020407
TRANSP0	D907

For use on: late Delco 22SI

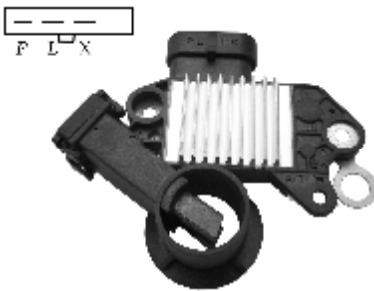

01-019

FEATURES

B-Circuit
 Voltage Set Point **14.70 V**
 Soft Start **30 %**
 Field Shorted Circuit Protection
 Under Voltage Indication
 Over Voltage Indication
 Self Exciting Function

Original & X-References..

For use on: 7SI Alternator

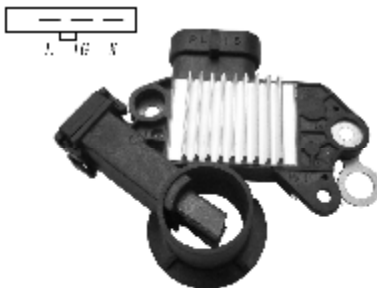

01-020

FEATURES

A-Circuit
 Voltage Set Point **14.70 V**

Original & X-References..

For use on: 7SI Alternator

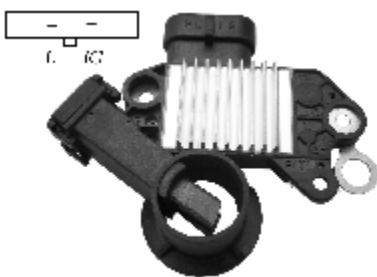

01-021

FEATURES

A-Circuit
 Voltage Set Point **14.50 V**
 Soft Start **30 %**
 LRC **5 sec**
 Field Shorted Circuit Protection
 Under Voltage Indication
 Over Voltage Indication

Original & X-References..

For use on: 7SI Alternator



01-023

FEATUERS

A-Circuit
 Voltage Set Point **14.30 V**

Original & X-References..

TRANSP0	D2198
---------	-------

For use on: 7SI Alternator

01-048

A-Circuit
 Voltage Set Point **28.30 V**

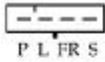

01-025

FEATUERS		Original & X-References..	
B-Circuit		DELCO	10458200 10458201
Voltage Set Point 14.70 V		WAI	35-162
Soft Start 30 %		TRANSPO	D200
LRC 5 sec			
Field Circuit Protection			
Under Voltage Indication			
Over Voltage Indication			
DFM function			

01-031



FEATUERS		Original & X-References..	
B-Circuit		DELCO	19009708
Voltage Set Point 14.70 V		USI	71-10050
Soft Start 32 %		TRANSPO	DE708
LRC 5 sec			
Field, Shorted Circuit Protection			
Under Voltage Indication			
Over Voltage Indication			

01-033



FEATUERS		Original & X-References..	
B-Circuit		DELCO	1116432
Voltage Set Point 14.50 V		USI	71-10025
Soft Start 32 %		MOBILERTRON	VR-D432
Field, Shorted Circuit Protection		TRANSPO	D432
Under Voltage Indication			
Over Voltage Indication			

01-034



FEATURES		Original & X-References..	
B-Circuit		DELCO	10521828 10514476
Voltage Set Point 28.30 V		TRANSPO	D4476
Soft Start 32 %			
Field Shorted Circuit Protection			
Under Voltage Indication			
Over Voltage Indication			
DFM Function			
Self Exciting Function			

For use on: Delco 24SI series

01-035



FEATUERS		Original & X-References..	
B-Circuit		DELCO	19009747
Voltage Set Point 14.30 V		USI	71-10059
Soft Start 30 %			
Field Shorted Circuit Protection			
Under Voltage Indication			
Over Voltage Indication			
DFM Function			



01-037

FEATUERS	Original & X-References..	
A-Circuit Voltage Set Point 14.55 V	DEAWOO	271910

01-038

FEATUERS	Original & X-References..	
A-Circuit Voltage Set Point 28.45V		



01-039

FEATUERS	Original & X-References..		
B-Circuit Voltage Set Point 14.20 V Soft Start 30 % LRC 5 sec Field Circuit Protection Under Voltage Indication Over Voltage Indication DFM function	DELCO	15163024	15163025
	WAI	D202XHD	
	TRANSP0	D202	

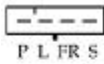

01-042

FEATUERS	Original & X-References..	
B-Circuit Voltage Set Point 14.70 V Soft Start 30 % LRC 5 sec Field, Lamp Shorted Circuit Protection Under Voltage Indication Over Voltage Indication DFM function	TRANSP0	D9715



01-049

FEATUERS	Original & X-References..		
B-Circuit VSP 13.80 V @ PWM Signal Loss L- F Terminals RVC	DELCO	0392759, 15093928, 15093929, 15200268, 15263858, 15857608, 15905871, 15905872, 25869451	
	Lester Nos:	8301, 8302	
	TRANSP0	D3587	





01-050

FEATURES

Original & X-References..

B-Circuit
 Voltage Set Point **14.50 V**
 Soft Start **20 %**
 LRC **5 sec**
 Field, Lamp Shorted Circuit Protection
 Under Voltage Indication
 Over Voltage Indication
 DFM function



01-051

FEATURES

Original & X-References..

B-Circuit
 Voltage Set Point **14.50 V**
 Soft Start **20 %**
 LRC **5 sec**
 Field, Lamp Shorted Circuit Protection
 Under Voltage Indication
 Over Voltage Indication
 DFM function



01-052

FEATURES

Original & X-References..

A-Circuit
 Voltage Set Point **14.60 V**

DELCO	271840
TRANSPO	D840

For use on: Marine Application
 REG 5SI



01-053

FEATURES

Original & X-References..

A-Circuit
 Voltage Set Point **14.60 V**

DELCO	271850
TRANSPO	D850

For use on: Marine Application
 REG 5SI



01-055

FEATURES

Original & X-References..

B-Circuit
 Voltage Set Point **14.80 V**
 Soft Start **18.75 %**
 LRC **10 Sec**
 Under Voltage Indication
 Over Voltage Indication
 DFM Function

CERGO	235653
ALTERNATOR REFERENCES	
MERCEDES	001500850
DELPHI	10480403
CARGO	CA1677IR

For use on : Audi ater cooling
 Alternator



02-001/FDR300

FEATURES

A-Circuit
Voltage Set Point **14.80 V**

For use on : Ford 3G Series IR/ER
Alternators

Original & X-References..

USI	71-20002
MOBILETRON	VR-F786BH
UNIPOINT	YR-F33B
WAI	35-205
CARGO	232414
TRANSPO	F794B



02-002/FDR794

FEATURES

A-Circuit
Voltage Set Point **14.70 V**

For use on: Ford 3G Series IR/ER
Alternators

Original & X-References..

FORD	EIDU-10316-A
MOBILETRON	VR-F786
USI	71-20002
WAI	35-204-1 35-205
CARGO	136230 232414
TRANSPO	F794



02-003/FDR600

FEATURES

A-Circuit
Voltage Set Point **14.45 V**
Soft Start **30 %**
Field Shorted Circuit Protection
Under Voltage Indication
Over Voltage Indication

For use on: Ford 6G Series IR/ER
Alternators Automobiles: FORD Crown
Victoria, Lincoln

Original & X-References..

FORD	F8WU-10C359-AB
MOBILETRON	VR-F900
USI	71-20011
WAI	35-212
CARGO	230065
TRANSPO	F600



02-004/FDR603

FEATURES

A-Circuit
Voltage Set Point **14.45 V**
Soft Start **30 %**
LRC **5 sec**
Field Shorted Circuit Protection
Under Voltage Indication
Over Voltage Indication

For use on: Ford 6G Series IR/ER
Alternators

Original & X-References..

FORD	XS7U-10C359-AC
	XS7U-10C359-BA
MOBILETRON	VR-F930
USI	71-20015
WAI	35-214
CARGO	233775
TRANSPO	F603



02-005/FDR796

FEATURES

A-Circuit
Voltage Set Point **14.45 V**
Soft Start **30 %**
LRC **5 sec**
Field Shorted Circuit Protection
Under Voltage Indication
Over Voltage Indication

For use on: Ford 4G Series IR/ER
Alternators

Original & X-References..

FORD	F50U-10316-A
MOBILETRON	VR-F815
USI	71-20004
WAI	35-208
CARGO	138663
TRANSPO	F796



02-006/FDR798

FEATURES

A-Circuit
Voltage Set Point **14.45 V**
Field Shorted Circuit Protection
Over Voltage Indication

For use on : Ford 4G Series IR/ER
Alternators

Original & X-References..

FORD	F6DU-10C359-AA
	F6DY-10316-A
	F6DY-10316-A
MOTORCRAFT	GR-817
MOBILETRON	VR-F817
USI	71-20007
WAI	35-210
CARGO	230066
TRANSPO	F798



02-007

FEATURES

A-Circuit
Voltage Set Point **14.45 V**
Soft Start **30 %**
LRC **5 sec**
Field Shorted Circuit Protection
Under Voltage Indication
Over Voltage Indication

Original & X-References..

FORD	VP3C3U10C359AA
MOBILETRON	VR-F901
TRANSPO	F605



02-008/FDR785

FEATURES

A-Circuit
Voltage Set Point **14.45 V**
Field Shorted Circuit Protection
Over Voltage Indication

For use on: Ford 3G Series IR/ER
Alternators

Original & X-References..

FORD	F3A-10316-A
	F3A-10346-A
	F3RU-10316-AA
	F3RU-10316-AA
MOTORCRAFT	GR-811
MOBILETRON	VR-F811
USI	71-20005
WAI	35-206
CARGO	135854
TRANSPO	F785



02-009/FDR786

FEATURES

A-Circuit
Voltage Set Point **14.45V**
Soft Start **30 %**
LRC **5 sec**
Field Shorted Circuit Protection
Under Voltage Indication
Over Voltage Indication

Original & X-References..

FORD	F5RZ-10316-A
MOTORCRAFT	GR-818
MOBILETRON	VR-F818
USI	71-20006
WAI	35-209
CARGO	138185
TRANSPO	F786



02-010/FDR795

FEATURES

A-Circuit
Voltage Set Point **14.45 V**
Soft Start **30 %**
LRC **5 sec**
Field Shorted Circuit Protection
Under Voltage Indication
Over Voltage Indication
"ISA" Terminals

For use on: Ford 3G Series IR/ER
Alternators

Original & X-References..

FORD	F4ZZ-10316-A
MOTORCRAFT	GR-814
MOBILETRON	VR-F814
USI	71-20008
WAI	35-207-4
CARGO	232415
TRANSPO	F795



02-011

FEATUERS		Original & X-References..		
A-Circuit		WAI	35-2135	
RC=0	Vs=13.50V	CARGO	233232	
RC=55%	Vs=14.25V	MOBILETRON	VR-910	
		LASTER NOS:7788	8253	8255
		8256		
		TRANSP0	F601	



02-012

FEATUERS		Original & X-References..	
A-Circuit		MOBILETRON	VR-VN001
RC=0	Vs=13.50V	TRANSP0	F611
RC=55%	Vs=14.25V		



02-013

FEATUERS		Original & X-References..	
A-Circuit		TRANSP0	F610
Voltage Set Point 14.30 V			
Soft Start 30 %			
Field, Lamp Shorted Circuit Protection			
Under Voltage Indication			
Over Voltage Indication			



02-014

FEATUERS		Original & X-References..	
A-Circuit		FORD	E43F-10316AA
Voltage Set Point 14.50 V		USD	71-20001
		TRANSP0	F784HD



02-016

FEATUERS		Original & X-References..	
A-Circuit		WAI	35-216
Voltage Set Point 14.30 V		TRANSP0	F602
Soft Start 30 %			
LRC 5 sec			
Field, Lamp Shorted Circuit Protection			
Sense Loss Indication			
Under Voltage Indication			
Over Voltage Indication			
DFM function			



02-017

FEATUERS		Original & X-References..	
A-Circuit		FORD	UP4LIU-10C359-AA
Voltage Set Point	14.40 V	TRANSPO	F606
Soft Start	30 %		
LRC	5 sec		
Field, Lamp Shorted Circuit Protection			
Sense Loss Indication			
Under Voltage Indication			
Over Voltage Indication			
DFM function			

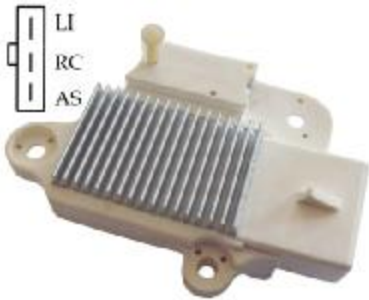

02-018

FEATUERS		Original & X-References..		
A-Circuit		LASTER NOS:	8269	8313 8314
RC=0	Vs=13.50V	8403	8404	8405 8442
RC=55%	Vs=14.25V	TRANSPO	F797	

For use on: Ford 4G Series IR/ER
Alternators

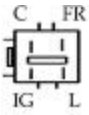

03-001/IN445

FEATURES

A-Circuit
 Voltage Set Point **14.50 V**
 DFM Function
 63.5mm Mounting

Original & X-References..

NIPPONDENSO	126000-2090
	126000-2190
MOBILETRON	VR-H2005-40
WAI	35-8241
TRANSPO	IN445



03-004

FEATUERS

A-Circuit
 Voltage Set Point **14.20 V**
 Soft Start **30 %**
 Field Shorted Circuit Protection
 Under Voltage Indication
 Over Voltage Indication
 57.5mm Mounting

Original & X-References..

NIPPONDENSO	126000-3790
TRANSPO	IN259



03-005/NPR254

FEATURES

A-Circuit
 Voltage Set Point **14.50 V**
 Field Shorted Circuit Protection
 Over Voltage Indication
 57.5mm Mounting

Original & X-References..

NIPPONDENSO	126000-0760	126000-1160
		126000-0600
TOYOTA	27700-78301	
USI	71-30001	
WAI	35-8221	
CARGO	133872	
TRANSPO	IN254	

03-066

L Terminal Drives Choke



03-007/NPR250

FEATURES

A-Circuit
 Voltage Set Point **14.50 V**
 Soft Start **30 %** LRC **5 sec**
 Field Shorted Circuit Protection
 IG / Sense Open Indication
 Under / Over Voltage Indication
 57.5mm Mounting

Original & X-References..

NIPPONDENSO	126000-0550	126000-0980
	126000-1550	126000-1570
MOBILETRON	VR-H2005-23A	
USI	71-30025	
WAI	35-8217	
CARGO	132855	
TRANSPO	IN250	

03-054

For use on: Daihatsu Charade
 Toyota Tercel



03-008

FEATURES

A-Circuit
 Voltage Set Point **14.50 V**
 Soft Start **30 %**
 LRC **5 sec**
 Field Shorted Circuit Protection
 IG / Sense Open Indication
 Under / Over Voltage Indication
 63.5mm Mounting

Original & X-References..

NIPPONDENSO	1260001960	1260002050
	1260002200	1260002250
MOBILETRON	VR-H2005-46A	
MF	VR02150	
CARGO	139584	
WAI	35-8240	
TRANSPO	IN453	



03-010/NPR221

FEATURES

A-Circuit
Voltage Set Point **14.60V**
63.5mm Mounting

For use on: Honda Civic, Chevy Spectrum, Isuzu I-Mark

Original & X-References..

NIPPONDENSO	126000-0430
MOBILETRON	VR-H2005-5H
USI	71-30021
WAI	35-8205 35-8205-3
CARGO	134447
TRANSPO	IN221



03-011/NPR257

FEATURES

A-Circuit
Voltage Set Point **14.50 V**
Soft Start **30 %**
LRC **5 sec**
Field Shorted Circuit Protection
IG / Sense Loss Indication
Under / Over Voltage Indication
57.5mm Mounting

Original & X-References..

NIPPONDENSO	126000-1630
MOBILETRON	VR-H2005-32A
USI	71-30014
WAI	35-824
CARGO	138662
TRANSPO	IN257

03-055



03-012

FEATURES

A-Circuit
Voltage Set Point **14.50 V**
Soft Start **30 %**
LRC **5 sec**
Field Shorted Circuit Protection
IG Open Indication
Under Voltage Indication
Over Voltage Indication
63.5mm Mounting

Original & X-References..

NIPPONDENSO	1260001200
ISUZU	8970320910
MOBILETRON	VR-H2005-16A
USI	71-30010
GARGO	134447
TRANSPO	IN435



03-013/NPR220

FEATURES

A-Circuit
Voltage Set Point **14.40 V**
Soft Start **30 %** LRC **5 sec**
Field Shorted Circuit Protection
IG / Sense Open Indication
Under / Over Voltage Indication
63.5mm Mounting

Original & X-References..

NIPPONDENSO	126000-0340	126000-0400
	126000-0510	126000-0650
	126000-0700	126000-0731
MOBILETRON	VR-H2005-4A	
USI	71-30003	
WAI	35-8204	
CARGO	131459	
TRANSPO	IN220	

03-056



03-016

FEATURES

A-Circuit
Voltage Set Point **14.50 V**
Soft Start **30 %**
LRC **5 sec**
Field, Shorted Circuit Protection
Under Voltage Indication
Over Voltage Indication
63.5mm Mounting

Original & X-References..

NIPPONDENSO	126000-1970
	126000-1971
MOBILETRON	VR-H2005-48A
CARGO	139268
TRANSPO	IN452

03-077

L Terminal Drives Choke



03-017/NPR439

FEATURES

A-Circuit
 Voltage Set Point **14.60V**
 Soft Start **30 %**
 LRC **5 sec**
 Field Shorted Circuit Protection
 Sense Open Indication
 Under Voltage Indication
 Over Voltage Indication
 63.5mm Mounting

Original & X-References..

NIPPONDENSO	126000-1580	126000-1640
	126000-1670	126000-1660
MOBILETRON		VR-H2005-31A
USI		71-30017
WAI		35-8238
CARGO		135734
TRANSPO		IN439



03-018/NPR441

FEATURES

A-Circuit
 Voltage Set Point **14.60 V**
 Soft Start **30 %** LRC **5 sec**
 Field Shorted Circuit Protection
 Sense Open Indication
 Under / Over Voltage Indication
 63.5mm Mounting

Original & X-References..

NIPPONDENSO	126000-1870	126000-2260
MOBILETRON		VR-H2005-63A
WAI		35-8234
CARGO		138894
TRANSPO		IN441

For use on: Toyota Camry, Lexus, Mazda, Millenia 2.5L



03-021/NPR437

FEATURES

A-Circuit
 Voltage Set Point **14.50 V**
 Soft Start **30 %** LRC **5 sec**
 Field Shorted Circuit Protection
 IG / Sense Open Indication
 Under / Over Voltage Indication
 63.5mm Mounting

Original & X-References..

NIPPONDENSO	1260001730	1260001750
		1260001930
TOYOTA		2770011070
		2770066040
MOBILETRONON		VR-H2005-30A
WAI		35-8235
CARGO		135737
TRANSPO		IN437

03-076

Lamp Shorted Circuit Protection
 NO IG / Sense Open Indication



03-025

FEATURES

A-Circuit
 Voltage Set Point **14.50 V**
 57.5mm Mounting

Original & X-References..

NIPPONDENSO	126000-1800
USI	71-30015
TRANSPO	IN450



03-026

FEATURES

A-Circuit
 Voltage Set Point **14.50 V**
 57.5mm Mounting

Original & X-References..

NIPPONDENSO	126000-2350
WAI	35-8237
TRANSPO	IN256

03-020

A-Circuit
 Voltage Set Point **14.50 V**
 57.5mm Mounting
 Without RFI Capacitor



03-027

FEATURES

A-Circuit
 Voltage Set Point **14.50 V**
 Soft Start **30 %**
 LRC **5 sec**
 Field Shorted Circuit Protection
 IG / Sense Open Indication
 Under / Over Voltage Indication
 63.5mm Mounting

Original & X-References..

NIPPONDENSO	126000-0610	126000-1110
	126000-1440	126000-1441
TRANSPO		IN434



03-028/NPR447

FEATURES

A-Circuit
 Voltage Set Point **14.50V**
 Soft Start **30 %** LRC **5 sec**
 Field Shorted Circuit Protection
 IG Open Indication
 Under Voltage Indication
 Over Voltage Indication
 DFM Function
 63.5mm Mounting

Original & X-References..

NIPPONDENSO	126000-3130	126000-3131
		126000-3171
TRANSPO		IN447



03-030/NPR460

FEATURES

A-Circuit
 Voltage Set Point **28.20V**
 63.5mm Mounting

 For use on: Toyota Coaster Diesel
 Fits Alternators :Denso 100211-6240,
 100211-6250,100211-6260,100211-6270
 Toyota 27060-17120,2706058150,
 27060-58230,27060-58250

Original & X-References..

NIPPONDENSO	126000-7120	27700-58040
MOBILETRONON		VR-H2005-66
USI		71-30019
CARGO		138297
TRANSPO		IN460



03-032

FEATURES

A-Circuit
 Voltage Set Point **28.50 V**
 With Trio Diode Application
 63.5mm Mounting

Original & X-References..



03-033

FEATURES

A-Circuit
 Voltage Set Point **14.60 V**
 DFM Function
 63.5mm Mounting

Original & X-References..

NIPPONDENSO	126000-1410	126000-1860
		126000-1880
USI		71-30006
TRANSPO		IN431



03-034

FEATURES

A-Circuit
 Voltage Set Point **14.50 V**
 Soft Start **30 %**
 LRC **5 sec**
 Field Shorted Circuit Protection
 Sense Open Indication
 Under / Over Voltage Indication
 57.5mm Mounting

Original & X-References..

NIPPONDENSO	126000-1770
TRANSPO	IN277

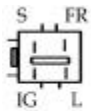

03-035

FEATURES

A-Circuit
 Voltage Set Point **14.50 V**
 Soft Start **30 %**
 LRC **5 sec**
 Field Shorted Circuit Protection
 IG / Sense Open Indication
 Under Voltage Indication
 Over Voltage Indication
 DFM Function
 63.5mm Mounting

Original & X-References..

NIPPONDENSO	126000-2450	126000-2190
MOBILETRONON	VR-H2005-64A	
WAI	35-8243	
CARGO	233517	
TRANSPO	IN455	



03-036

FEATURES

A-Circuit
 Voltage Set Point **14.50 V**
 DFM Function
 63.5mm Mounting

Original & X-References..

NIPPONDENSO	126000-0940	126000-1700
	126000-1030	126000-1300
USI	71-30005	
TRANSPO	IN224	



03-037

FEATURES

A-Circuit
 Voltage Set Point **14.60 V**
 IG Open Indication
 DFM Function
 63.5mm Mounting

Original & X-References..

NIPPONDENSO	126000-0570
USI	71-30009
TRANSPO	IN225



03-038

FEATURES

A-Circuit
 Voltage Set Point **14.50 V**
 Soft Start **30 %**
 LRC **5 sec**
 Field Shorted Circuit Protection
 IG / Sense Open Indication
 Under Voltage Indication
 Over Voltage Indication
 DFM Function
 63.5mm Mounting

Original & X-References..

NIPPONDENSO	126000-0540	126000-1170
USI	71-30004	
TRANSPO	IN226	



03-039

FEATURES

A-Circuit
 Voltage Set Point **14.60 V**
 Soft Start **30 %**
 LRC **5 sec**
 Field Shorted Circuit Protection
 IG Open Indication
 Under Voltage Indication
 Over Voltage Indication
 DFM Function
 63.5mm Mounting

Original & X-References..

NIPPONDENSO	126000-1470
	126000-1471
TRANSPON	IN429



03-040

FEATURES

A-Circuit
 Voltage Set Point **14.50 V**
 63.5mm Mounting

Original & X-References..

NIPPONDENSO	126000-2150
	126000-2151
MOBILETRONON	VR-H2005-77
TRANSPON	IN215



03-041

FEATURES

A-Circuit
 Voltage Set Point **28.20 V**
 57.5mm Mounting

Original & X-References..



03-043

FEATURES

A-Circuit
 Voltage Set Point **14.50 V**
 57.5mm Mounting

Original & X-References..

NIPPONDENSO	126000-0850
	126000-0880
	126000-1370

03-044

A-Circuit
 Voltage Set Point **14.50 V**
 Soft Start **30 %** LRC **5 sec**
 Field Shorted Circuit Protection
 Under / Over Voltage Indication
 57.5mm Mounting

MOBILETRONON	VR-H2005-24
WAI	35-8216
CARGO	132860
TRANSPON	IN251



03-045

FEATURES

A-Circuit
 Voltage Set Point **14.60 V**
 63.5mm Mounting

Original & X-References..

NIPPONDENSO	126000-1940
MOBILETRONON	VR-H2005-59
CARGO	138638
TRANSPON	IN449



03-046

FEATURES

Original & X-References..

A-Circuit
Voltage Set Point **28.20 V**
63.5mm Mounting



03-047

FEATUERS

Original & X-References..

A-Circuit
Voltage Set Point **14.50 V**
57.5mm Mounting

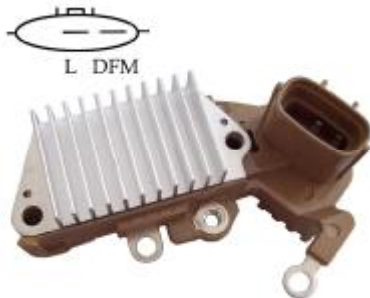

03-048

FEATUERS

Original & X-References..

A-Circuit
Voltage Set Point **14.70 V**
Soft Start **30 %**
Field, Shorted Circuit Protection
Under Voltage Indication
Over Voltage Indication
DFM function
63.5mm Mounting



03-051

FEATUERS

Original & X-References..

A-Circuit
Voltage Set Point **28.50 V**
Soft Start **30 %**
Field, Lamp Shorted Circuit Protection
Under Voltage Indication
Over Voltage Indication
63.5mm Mounting



03-052

FEATUERS

Original & X-References..

A-Circuit
Voltage Set Point **14.50 V**
Soft Start **30 %**
LRC **5 sec**
Field Shorted Circuit Protection
IG Open Indication
Under / Over Voltage Indication
63.5mm Mounting



03-058

FEATUERS	Original & X-References..
A-Circuit	MOBILETRON VR-H2005-62A
Voltage Set Point 14.55 V	DENSO 126000-3040
Soft Start 30 %	
LRC 5 sec	
Field, Lamp Shorted Circuit Protection	
Under Voltage Indication	
Over Voltage Indication	
DFM function	
63.5mm Mounting	



03-059

FEATUERS	Original & X-References..
A-Circuit	NIPPONDENSO 126000-7100
Voltage Set Point 14.10 V	MOBILETRON VR-H2005-35
Soft Start 30 %	WAI 35-8237
LRC 5 sec	TRANSPO IN440
Sense Loss Indication	
Under Voltage Indication	
Over Voltage Indication	
63.5mm Mounting	



03-068

FEATUERS	Original & X-References..
A-Circuit	USI 71-30031
Voltage Set Point 14.55V	
Soft Start 30 %	
Field Shorted Circuit Protection	
Under Voltage Indication	
Over Voltage Indication	
DFM function	
63.5mm Mounting	



03-015/IVR506

FEATURES	Original & X-References..
A-Circuit	TRANSPO IN217(With brush holder)
Voltage Set Point 28.50 V	

03-029

A-Circuit	TRANSPO IN218(With brush holder)
Voltage Set Point 14.50V	



03-023/ IVR-254

FEATURES	Original & X-References..
A-Circuit	TOYOTA 27000-1700
Voltage Set Point 28.70 V	HINO 277000-1700
	SHWAFUJI 1219-008-00XOSF
	MOBILETRONON VR-H2002-1
	CARGO 136168
	TRANSPO IW700
03-061	
A-Circuit	
Voltage Set Point 28.60 V	
Lamp Shorted Circuit Protection	
L Terminal Does Not Drive Choke	

03-024/ IVR-256



FEATURES

A-Circuit
Voltage Set Point **28.80 V**

Original & X-References..

HONO	27700-1810
NISSA	23500-99109

03-003/NPR131



FEATURES

A-Circuit
Voltage Set Point **28.50 V**
Field Shorted Circuit Protection

Original & X-References..

03-060



FEATUERS

A-Circuit
Voltage Set Point **28.50 V**

Original & X-References..

NIPPONDENSO	12600-0380
TRANSPO	IN233

03-022/NPR920



FEATURES

A-Circuit
Voltage Set Point **14.30 V**
Soft Start **30 %**
Field Shorted Circuit Protection
Sense Open Indication
Under Voltage Indication
Over Voltage Indication

Original & X-References..

NIPPONDENSO	12600-0920
	126000-1421
MF	VR01770
TOYOTA	27000-64040
MOBILETRONON	VR-H2005-2
CARGO	133526 231197
TRANSPO	IN920

03-049

03-053



FEATUERS

A-Circuit
Voltage Set Point **14.30 V**

Original & X-References..

NIPPONDENSO	12600-0920
MOBILETRON	VR-H2005-2W
TRANSPO	IN921



03-009/NPR920

FEATURES

A-Circuit
Voltage Set Point **14.30 V**

For use on: Toyota Industrial

Original & X-References..

CARGO	133526	231197
MOBILETRON	VR-H2005-2	
MF	VR01770	
WAI	35-8245	
TRANSP0	IN920	



03-014

FEATURES

B-Circuit
Voltage Set Point **14.80 V**
Soft Start **32 %**
Field, Lamp Shorted Circuit Protection
Under Voltage Indication
Over Voltage Indication
DFM Function

Original & X-References..

NIPPONDENSO	126600-0040	
	126600-0042	
	104210-309	
HONDA	31100-PGK-A01	
	CSC09	
LESTER	13918	290-5084
TRANSP0	IN6004	



03-006

FEATURES

B-Circuit
Voltage Set Point **14.80 V**
Soft Start **31.25%**
LRC **2.5 sec**
Field, Lamp Shorted Circuit Protection
Under Voltage Indication
Over Voltage Indication
DFM function

Original & X-References..



03-031

FEATURES

B-Circuit
Voltage Set Point **14.80 V**
Soft Start **32 %**
Field, Lamp Shorted Circuit Protection
Under Voltage Indication
Over Voltage Indication
DFM Function

Original & X-References..

NIPPONDENSO	126600-3350	
	104210-329	
HONDA	A04 CSC29	
	31100-RAA-A01	
LESTER	13980	
	290-5096	
TRANSP0	IN6335	



03-042

FEATUERS

A-Circuit
RC=0 Vs=13.50V
RC=55% Vs=14.25V
AS-RC-LI Terminals

Original & X-References..

NIPPONDENSO	104210-3512	104210-4091
	104210-4700	104210-5300
MOBILETRON	VR-H2005-88	
TRANSP0	IN6601	



03-064

FEATUERS

Original & X-References..

- B-Circuit**
- Voltage Set Point **14.80 V**
- Soft Start **32 %**
- Field Shorted Circuit Protection
- Under Voltage Indication
- Over Voltage Indication
- DFM function

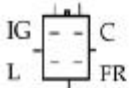

03-065

FEATUERS

Original & X-References..

- B-Circuit**
- Voltage Set Point **14.80 V**
- Soft Start **32 %**
- Field Shorted Circuit Protection
- Under Voltage Indication
- Over Voltage Indication
- DFM function



03-073

FEATUERS

Original & X-References..

- B-Circuit**
- Voltage Set Point **14.30 V**
- Soft Start **32 %**
- LRC 5 sec**
- Field Shorted Circuit Protection
- Sense open indication
- Under Voltage Indication
- Over Voltage Indication

TRANSPO	IN6002
NIPPONDENSO	126600-002

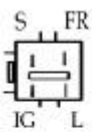

03-074

FEATUERS

Original & X-References..

- B-Circuit**
- Voltage Set Point **14.30 V**
- Soft Start **32 %**
- LRC 5 sec**
- Field, Lamp Shorted Circuit Protection
- Sense open indication
- Under Voltage Indication
- Over Voltage Indication
- DFM function

NIPPONDENSO	104210-205	-347
	-3471	-420 -423 -487 -4870
Lester	11138	11139 11196 13984
TRANSPO	IN6300	



04-001/BOR363

FEATURES

A-Circuit (Metal Can)
Voltage Set Point **28.10V**

Slip Ring OD: 28mm

Original & X-References..

BOSCH	1197311304
FIAT	93158421
SCANIA	117253 362645
VOLVO	1606935 1625880
MOBILETRON	VR-B209
USI	71-40021
CARGO	135856
TRANSPO	IB363



04-072/BOR360

FEATURES

A-Circuit
Voltage Set Point **14.60 V**
Low Cut-in Speed
Slip Ring OD: 28mm

04-110

A-Circuit
Voltage Set Point **28.50 V**

TRANSPO IB363

Original & X-References..

BOSCH		
	0192052033	0192053032
	1197311029	1197311030
	1197311031	1197311034
MOBILETRON		VR-B195M
USI		71-40002
WAI		35-9117
CARGO		132666
TRANSPO		IB360



04-034/BOR350

FEATURES

A-Circuit
Voltage Set Point **14.50V**
Slip Ring OD: 32mm

Original & X-References..

BOSCH		
	1197311000	1197311001
	1197311002	1197311090
	2197311090	
TRANSPO		IB350



04-080/BOR350

FEATURES

A-Circuit (Metal Can)
Voltage Set Point **14.50V**
Slip Ring OD: 32mm

Original & X-References..

BOSCH		
	1197311000	1197311001
	1197311002	1197311090
	2197311090	
TRANSPO		IB350



04-046/BOR352

FEATURES

A-Circuit
Voltage Set Point **14.50 V**

Slip Ring OD: 28mm
FOR USE ON: Alfa Romeo, Audi,
Chrysler, Porsche, VW, Volvo

Original & X-References..

BOSCH		
	1192052015	1192052016
	1192052020	1192052021
	1192052024	1192052025
USI		71-40002
WAI		35-9104
TRANSPO		IB352



04-084/BOR352

FEATURES

A-Circuit **(Metal Can)**
 Voltage Set Point **14.50 V**
 Slip Ring OD: 28mm
 FOR USE ON: Alfa Romeo, Audi,
 Chrysler, Porsche, VW, Volvo

Original & X-References..

BOSCH	
1192052015	1192052016
1192052020	1192052021
1192052024	1192052025
USI	71-40002
WAI	35-9104
TRANSPO	IB352



04-055/BOR368

FEATURES

A-Circuit **(Metal Can)**
 Voltage Set Point **14.60 V**
 Slip Ring OD: 32mm

Original & X-References..

BOSCH	1197311032
MOBILETRON	VR-B260
TRANSPO	IB368



04-056/BOR369

FEATURES

A-Circuit **(Metal Can)**
 Voltage Set Point **28.10 V**
 Slip Ring OD: 32mm

Original & X-References..

BOSCH	1197311310
	1197311313
TRANSPO	IB369

For use on: Engine Truck



04-006/BOR343

FEATURES

A-Circuit **(Metal Can)**
 Voltage Set Point **28.50 V**
 Slip Ring OD : 28 mm

Original & X-References..

BOSCH	
1197311315	0192053003
0192053009	0192053012
0192053014	0192053025
0190457001	
MERCEDES-BENZ	
0001549606	0021543506
0021545506	0021545606
CARGO	131340
TRANSPO	IB381 IB382



04-103

FEATUERS

A-Circuit
 Voltage Set Point **14.50 V**

Original & X-References..

TRANSPO	IB501
---------	-------



04-002/BOR271

FEATURES

A-Circuit (Metal Can)
Voltage Set Point **28.50 V**
Field Shorted Circuit Protection
O.E. Grade

Original & X-References..
PRESTOLITE 271



04-003/BOR340

FEATURES

A-Circuit (Metal Can)
Voltage Set Point **28.50V**
O.E. Grade
With Wiring: 70mm

Original & X-References..
JFZ2929



04-009

FEATURES

A-Circuit (Metal Can)
Voltage Set Point **14.50 V**
O.E. Grade

Original & X-References..

04-052/BOR341

A-Circuit (Metal Can)
Voltage Set Point **28.50 V**
Without Protect cover
O.E. Grade



04-017/BOR342-1

FEATURES

A-Circuit (Metal Can)
Voltage Set Point **28.50 V**
O.E. Grade

Original & X-References..

04-073

A-Circuit
Voltage Set Point **28.10 V**



04-049/BOR153

FEATURES

A-Circuit (Metal Can)
Voltage Set Point **28.50V**
Field Shorted Circuit Protection
O.E. Grade

Original & X-References..



04-075

FEATURES

Original & X-References..

A-Circuit (Metal Can)
Voltage Set Point **28.10 V**
Slip Ring OD: 32mm



04-081

FEATUERS

Original & X-References..

A-Circuit (Metal Can)
Voltage Set Point **14.50 V**



04-008/BOR387

FEATURES

Original & X-References..

A- Circuit (Metal Can)
Voltage Set Point **14.60 V**
With 180 Ohm Resistor
Slip Ring OD: 14mm

BOSCH	
1197311211	1197311213
1197311217	1197311219
1197311242	1197311541
TRANSPO	IB387

04-061

A-Circuit
Voltage Set Point **14.60 V**
With 180 Ohm Resistor
Slip Ring OD: 14mm
Low Cut-in Speed

For use on :VOLVO,
VW,CORRADO,VW PASSAT



04-023

FEATURES

Original & X-References..

A-Circuit (Metal Can)
Voltage Set Point **28.50 V**
Slip Ring OD: 14mm

04-064

A-Circuit
Voltage Set Point **28.50 V**
With 430 OHM Resistor
Slip Ring OD: 14mm



04-031/BOR385

FEATURES

Original & X-References..

A- Circuit (Metal Can)
Voltage Set Point **14.50 V**
Slip Ring OD: 14mm

BOSCH	
1197311212	1197311214
1197311220	1197311221
1197311223	1197311224
WAI	35-9108
TRANSPO	IB385

04-062

A-Circuit
Voltage Set Point **14.50 V**
Low Cut-in Speed
Slip Ring OD: 14mm



04-033/BOR487

FEATURES

A-Circuit (Metal Can)
Voltage Set Point **28.50V**
O.E. Grade

Original & X-References..



04-048/BOR198

FEATURES

A-Circuit (Metal Can)
Voltage Set Point **14.50 V**
O.E. Grade

Original & X-References..

04-066/BOR199

A-Circuit (Metal Can)
Voltage Set Point **28.50V**
O.E. Grade



04-054/BOR388

FEATURES

A-Circuit (Metal Can)
Voltage Set Point **14.60V**
Slip Ring OD: 14mm

Original & X-References..

BOSCH	1197311548
1197311500	1197311523
1197311530	1197311531
TRANSPO	IB388



04-063/BOR529

FEATURES

A-Circuit (Metal Can)
Voltage Set Point **14.60V**
With 180 OHM Resister
Slip Ring OD: 14mm

Original & X-References..

BOSCH	1197311529
TRANSPO	IB529

For use on: Audi ,VW



04-087

FEATUERS

A-Circuit
Voltage Set Point **14.40 V**

Original & X-References..

BOSCH	0192052001/2/4
TRANSPO	IB358-1



04-088

FEATUERS	Original & X-References..	
A-Circuit Voltage Set Point 14.40 V	BOSCH	9190087032
	MOBILETRON	190087026 VR-B103

04-095

A-Circuit Voltage Set Point 28.10 V	BOSCH 190087014	9190087018 0192053006
---	--------------------	--------------------------



04-083

FEATUERS	Original & X-References..	
A-Circuit Voltage Set Point 14.20 V	BOSCH	9190087003 9121080303
	WAI	35-9127
	TRANSPO	IB359



04-085

FEATUERS	Original & X-References..
A-Circuit Voltage Set Point 14.40 V	CINAP GA009/2.212/2



04-0851

FEATUERS	Original & X-References..
A-Circuit Voltage Set Point 14.40V	



04-097

FEATUERS	Original & X-References..	
B-Circuit Voltage Set Point 14.10 V	BOSCH	9190456007
	IK413HD	



04-099

FEATUERS	Original & X-References..	
A-Circuit Voltage Set Point 14.60 V	BOSCH	9190547002 9120450041
	IK586	



04-112

FEATUERS	Original & X-References..	
A-Circuit Voltage Set Point 14.50 V	IK5541	



04-067

FEATURES	Original & X-References..	
A-Circuit Voltage Set Point 14.60 V Low Cut-in Speed Slip Ring OD: 32mm		



04-096

FEATUERS	Original & X-References..	
A-Circuit Voltage Set Point 14.60 V		

04-109

A-Circuit
Voltage Set Point **28.50 V**



04-010

FEATURES	Original & X-References..	
A-Circuit Voltage Set Point 28.10 V		
04-032/LAR001 A-Circuit Voltage Set Point 14.50 V	LADA ALTERNATOR	VAZ 2110



04-039/LAR673

FEATURES

A-Circuit
Voltage Set Point **14.50 V**

Original & X-References..

LADA	21083701500	
	5676255	173702
LUCAS	21229189	UCB 902
MAGNETI MARELLI	9400 38111	
TRANSPO	IR673	

04-057

FEATURES

A-Circuit
Voltage Set Point **14.50 V**
Soft Start **30 %**
LRC **5 sec**
Field, Lamp Choke Shorted Circuit Protection
Under Voltage Indication
Over Voltage Indication

Original & X-References..

LADA TRT3-01



04-058

FEATURES

B-Circuit
Voltage Set Point **14.50 V**
Soft Start **18 %**
LRC **10 sec**
Field, Lamp Shorted Circuit Protection
Under Voltage Indication
Over Voltage Indication

Original & X-References..

LADA TRT5



04-011/BOR298

FEATURES

B-Circuit
Voltage Set Point **28.50V**
Soft Start **30 %**
LRC **5 sec**
Field Shorted Circuit Protection
IG Open Indication
Under Voltage Indication
Over Voltage Indication
DFM function

Original & X-References..

BOSCH	F00M 145256	F00M 145298
	F00M 145302	F00M 145307
	F00M 145237	F00M 145299
MERCEDES-BENZ	0001542705	
SCANIA	1501245	
TRANSPO	IB298	



04-014/BOR409

FEATURES

A-Circuit
Voltage Set Point **14.60 V**
Soft Start **30 %**
LRC **5 sec**
Field Shorted Circuit Protection
Under Voltage Indication
Over Voltage Indication
DFM function

Original & X-References..

BOSCH	F00M 145371	
	F00M 145283	
	F00M 145228	
	F00M 145265	
SCANIA	12790483	
CARGO	231716	





04-015/BOR239

FEATURES

A-Circuit
 Voltage Set Point **14.60V**
 Soft Start **30 %**
 LRC **5 sec**
 Field Shorted Circuit Protection
 Under Voltage Indication
 Over Voltage Indication
 DFM function

Original & X-References..

BOSCH	F00M 145239
	F00M 145204
	F00M 145387
RENAULT	7701048230
CARGO	230624
TRANSPO	IB239



04-020/BOR408

FEATURES

A-Circuit
 Voltage Set Point **14.60V**
 Soft Start **30 %**
 LRC **5 sec**
 Field Shorted Circuit Protection
 Under Voltage Indication
 Over Voltage Indication
 DFM function

Original & X-References..

BOSCH	F00M 145235
MOBILETRON	VR-B262
CARGO	233508
TRANSPO	IB235
	IB255



04-022/BOR410

FEATURES

A-Circuit
 Voltage Set Point **14.60 V**
 Soft Start **30 %**
 LRC **5 sec**
 Field Shorted Circuit Protection
 Under Voltage Indication
 Over Voltage Indication
 DFM function

Original & X-References..

BOSCH	F00M 145225	F00M 145200
	F00M 145209	F00M 145223
	F00M 145233	F00M 145333
	F00M 145350	F00M 145353
MERCEDES-BENZ	0031542406	
RENAULT	5001850026	
MOBILETRON	VR-B254	
CARGO	139925	
TRANSPO	IB225	



04-024/BOR231

FEATURES

A-Circuit
 Voltage Set Point **14.60 V**
 Soft Start **30 %**
 LRC **5 sec**
 Field Shorted Circuit Protection
 Under Voltage Indication
 Over Voltage Indication
 DFM function

Original & X-References..

BOSCH	F00M 145201	F00M 145231
	F00M 145257	F00M 145282
	F00M 145362	F00M 145370
MERCEDES-BENZ	0031541506	0031545606
	SAAB 5353552	
CARGO	139044	
TRANSPO	IB231	



04-026/BOR229

FEATURES

A-Circuit
 Voltage Set Point **14.60 V**
 Soft Start **30 %**
 LRC **5 sec**
 Field Shorted Circuit Protection
 Under Voltage Indication
 Over Voltage Indication
 DFM function

Original & X-References..

BOSCH	F00M 145229
	F00M 145208
	F00M 145351
CARGO	232927
TRANSPO	IB229



04-028/BOR411

FEATURES

A-Circuit
 Voltage Set Point **14.60V**
 Soft Start **30 %**
 LRC **5 sec**
 Field Shorted Circuit Protection
 Under Voltage Indication
 Over Voltage Indication
 DFM Function

Original & X-References..

FOR MERCEDES-BENZ
 CARGO 235528



04-035/BOR411

FEATURES

A-Circuit
 Voltage Set Point **14.60 V**
 Soft Start **30 %**
 LRC **5 sec**
 Field Shorted Circuit Protection
 IG Open Indication
 Under Voltage Indication
 Over Voltage Indication

Original & X-References..

FOR BMW
 WATER COOLING ALTERNATOR
 CARGO 235460



04-042/BOR220

FEATURES

A-Circuit
 Voltage Set Point **14.60V**
 Soft Start **30 %**
 LRC **5 sec**
 Field Shorted Circuit Protection
 Under Voltage Indication
 Over Voltage Indication
 DFM Function

Original & X-References..

BOSCH F00M 145220
 CARGO 230249
 TRANSPO IB220



04-045/BOR251

FEATURES

A-Circuit
 Voltage Set Point **14.60 V**
 Soft Start **30 %**
 LRC **5 sec**
 Field Shorted Circuit Protection
 Under Voltage Indication
 Over Voltage Indication
 DFM Function

Original & X-References..

BOSCH F00M 145251
 F00M 145245
 F00M 145360
 TRANSPO IB251



04-051/BOR297

FEATURES

B-Circuit
 Voltage Set Point **28.50 V**
 Soft Start **30 %**
 LRC **5 sec**
 Field Shorted Circuit Protection
 Sense / IG Open Indication
 Under Voltage Indication
 Over Voltage Indication
 DFM Function

Original & X-References..

BOSCH
 0-124-555-005/006/009/010/017
 0-124-655-005/006/008/012
 4982318 4892320 4982318
 5010589551 20409240 20466317
 LESTER 12591 12599
 220-5306/5293/5295
 CARGO 233117
 TRANSPO IB297

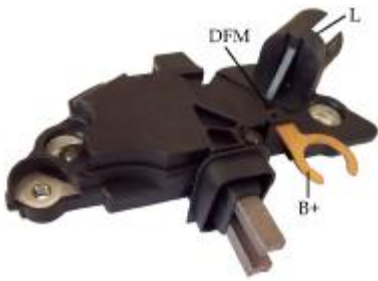

04-053/BOR252

FEATURES

B-Circuit
 Voltage Set Point **14.50V**
 Soft Start **30 %**
 Field Shorted Circuit Protection
 Under Voltage Indication
 Over Voltage Indication
 DFM Function

Original & X-References..

BOSCH	F00M 145252
	F00M 145243
	F00M 145270
CARGO	232193
TRANSPO	IB252



04-105/BOR286

FEATURES

B-Circuit
 Voltage Set Point **14.50 V**
 Soft Start **30%** LRC **5 sec**
 Lamp Shorted Circuit Protection
 P Terminal Self Exciting Funtion
 Under/ Over Voltage Indication
 DFM Function

Original & X-References..

BOSCH	F00M 145286
	F00M 145394
CARGO	234770
TRANSPO	IB286

04-069

Soft Start **32 %**
 Field Shorted Circuit Protection



04-071/BOR236

FEATURES

A-Circuit
 Voltage Set Point **14.50 V**
 Soft Start **32%**
 LRC **5 sec**
 Field, Shorted Circuit Protection
 Sense IG Open Indication
 Under Voltage Indication
 Over Voltage Indication
 DFM Function

Original & X-References..

BOSCH	F00M 145873
	F00M 145236
CARGO	233587
TRANSPO	IB236



04-082

FEATURES

A-Circuit
 Voltage Set Point **14.60 V**
 Soft Start **30 %** LRC **5 sec**
 Field Shorted Circuit Protection
 Under/ Over Voltage Indication
 DFM Function
 Self Exciting Function

Original & X-References..

BOSCH	F00M 145249
	F00M 145260
	F00M 145325
TRANSPO	IB260

04-104

Voltage Set Point **28.20V**
 Circuit Protection



04-086

FEATUERS

A-Circuit
 Voltage Set Point **14.60 V**
 Soft Start **30 %**
 LRC **5 sec**
 Field Circuit Protection
 Under Voltage Indication
 Over Voltage Indication
 DFM function

Original & X-References..

BOSCH	FOOM145247
	FOOM145357
TRANSPO	IB247



04-100

FEATUERS	Original & X-References..	
B-Circuit	BOSCH	F00M 144109
Voltage Set Point 14.50V		
Soft Start 30 %		
Field Shorted Circuit Protection		
Under Voltage Indication		
Over Voltage Indication		
DFM Function		



04-106

FEATUERS	Original & X-References..	
A-Circuit	BOSCH	F00M 144147
Voltage Set Point 14.80 V		
Soft Start 15 %		
LRC 2.5 sec		
COM		



04-107

FEATUERS	Original & X-References..	
A-Circuit	BOSCH	F00M 145880
Voltage Set Point 14.80 V	F00M 145262	F00M 145285
Soft Start 15 %		
LRC 2.5 sec		
COM		



04-108

FEATUERS	Original & X-References..	
A-Circuit		
Voltage Set Point 14.80 V		
Soft Start 15 %		
LRC 2.5 sec		
COM		



04-025

FEATURES	Original & X-References..	
A-Circuit	BOSCH	1197311506 1197311516
Voltage Set Point 14.50 V		1197311536 1197311545
Soft Start 32 %		1197311557 1197311547
LRC 5 sec	AUDI/VW	
Field Shorted Circuit Protection	037903803A	038903803C
IG Open Indication	BMW	12311435432
Under Voltage Indication		12311713491
Over Voltage Indication	CARGO	138999
DFM function	TRANSPO	IB545



04-027

FEATURES

B-Circuit
 Voltage Set Point **28.50 V**
 Soft Start **30 %**
 Field Shorted Circuit Protection
 IG Open Indication
 Under Voltage Indication
 Over Voltage Indication

Original & X-References..

BOSCH1	197311558
	1197311554
	0272220217
MAN	81256010025
CARGO	234552
TRANSP0	IB558



04-043

FEATURES

B-Circuit
 Voltage Set Point **28.50 V**
 Soft Start **30 %**
 Field Shorted Circuit Protection
 IG / Sense Open Indication
 Under Voltage Indication
 Over Voltage Indication

Original & X-References..

BOSCH	1197311543
CARGO	234112



04-078

FEATURES

A-Circuit
 Voltage Set Point **14.50 V**
 Soft Start **19 %**
 LRC **9 sec**
 Field, Lamp Shorted Circuit Protection
 Under Voltage Indication
 Over Voltage Indication
 DFM Function

Original & X-References..

BOSCH	F00M 346026
-------	-------------



04-089

FEATUERS

B-Circuit
 Voltage Set Point **14.50 V**
 Soft Start **19 %**
 LRC **9 sec**
 Field, Lamp Shorted Circuit Protection
 Under Voltage Indication
 Over Voltage Indication
 DFM function

Original & X-References..

BOSCH	F00M 346340
-------	-------------



04-092

FEATUERS

A-Circuit
 Voltage Set Point **14.50 V**

Original & X-References..



05-001/HIR738

FEATURES

A-Circuit
 Voltage Set Point **14.40 V**
 Soft Start **30 %**
 Field Shorted Circuit Protection
 Under Voltage Indication
 Over Voltage Indication

Original & X-References..

HITACHI	LR180-756B
	LR1100-702
MOBILETRON	VR-H2000-44
TRANSPO	IH738



05-002/HIR413

FEATURES

B-Circuit
 Voltage Set Point **14.70 V**

Original & X-References..



05-003/HIR1140

FEATURES

A-Circuit
 Voltage Set Point **28.60 V**

Original & X-References..

HITACHI	8-9711264-6
---------	-------------



05-004/HIR776

FEATURES

A-Circuit
 Voltage Set Point **14.40 V**
 Soft Start **30 %**
 Field Shorted Circuit Protection
 Under Voltage Indication
 Over Voltage Indication

Original & X-References..

HITACHI	L170G-3319
	L170G-6308
	L170G-7315
MOBILETRON	VR-H2000-41
CARGO	139980
UNIPOINT	YR-713
TRANSPO	IH776



05-008/HIR766

FEATURES

A-Circuit
 Voltage Set Point **14.50 V**
 Soft Start **30 %**
 Field Shorted Circuit Protection
 Sense Open Indication
 Under Voltage Indication
 Over Voltage Indication

Original & X-References..

HITACHI	L1100G-3340
	L1110G-9340
	L1125G-1340
MOBILETRON	VR-H2000-28
CARGO	138717
WAI	35-8127
UNIPOINT	YR-715
TRANSPO	IH766

05-059/HIR766-1

Without Brush Holder



05-009/HIR409

FEATURES	Original & X-References..	
A-Circuit	HITACHI	TR1E-123
Voltage Set Point 14.50 V	LR1100	501
Soft Start 30 %		502B
Sense Open Indication	CARGO	230433
Under Voltage Indication		
Over Voltage Indication		

05-089

Without Brush Holder



05-014/HIR769

FEATURES	Original & X-References..	
A-Circuit	HITACHI	LR150-511
Voltage Set Point 14.40 V		LR1100-502F
Soft Start 30 %		LR170-509E
Field Shorted Circuit Protection	MOBILETRON	VR-H2000-50
Under Voltage Indication	CARGO	232443
Over Voltage Indication	TRANSPO	IH769



05-015/HIR767

FEATURES	Original & X-References..	
A-Circuit	HITACHI	L170G-5315
Voltage Set Point 14.50 V		L170G-6315
Soft Start 30 %		L180G-23401
Field Shorted Circuit Protection	WAI	35-8126
Sense Open Indication	MOBILETRON	VR-H2000-38
Under Voltage Indication	CARGO	138727
Over Voltage Indication	UNIPOINT	YR-714
05-047/HIR767-1	TRANSPO	IH767

Without Brush Holder



05-016/HIR739

FEATURES	Original & X-References..	
A-Circuit	HITACHI	LR280-508
Voltage Set Point 28.40 V	ISUZU	8972489141
Soft Start 30 %		
Field Shorted Circuit Protection		
Sense Open Indication		
Under/ Over Voltage Indication		

05-042

A-Circuit
Voltage Set Point **14.40 V**
NO Sense Open Indication



05-024/HIR1140-3

FEATURES	Original & X-References..	
B-Circuit	HITACHI	LR180-501
Voltage Set Point 14.70V	CARGO	137584



05-025/HIR765

FEATURES

A-Circuit
 Voltage Set Point **14.50 V**
 Soft Start **30 %**
 Field Shorted Circuit Protection
 Sense Open Indication
 Under Voltage Indication
 Over Voltage Indication

Original & X-References..

HITACHI	L185G-4340
MOBILETRON	VR-H2000-27
WAI	35-8128
TRANSPO	IH765

05-018/HIR765-1

Without Brush Holder



05-026

FEATURES

A-Circuit
 Voltage Set Point **14.40 V**

Original & X-References..

HITACHI	LR140-708
	LR140-708C
TRANSPO	IH258



05-035/HIR411

FEATURES

A-Circuit
 Voltage Set Point **14.50 V/A 15.70 V**
 Soft Start **30 %**
 Field Shorted Circuit Protection
 Sense Open Indication
 Under Voltage Indication
 Over Voltage Indication

Original & X-References..

HITACHI	LR170-502
---------	-----------



05-036/HIR774

FEATURES

A-Circuit
 Voltage Set Point **14.40 V**
 Soft Start **30 %**
 Field Shorted Circuit Protection
 Under Voltage Indication
 Over Voltage Indication
 For use on:
 1995-97 Nissan Maxima 3.0L
 1998-99 Nissan Maxima SE 3.0L
 1998-99 Nissan Maxima 130 3.0L

Original & X-References..

MOBILETRON	VR-H2000-46
CARGO	231534
TRANSPO	IH774



05-037

FEATURES

A-Circuit
 Voltage Set Point **28.40 V**
 Soft Start **30 %**
 Field Shorted Circuit Protection
 Under Voltage Indication
 Over Voltage Indication

Original & X-References..

05-043

A-Circuit
 Voltage Set Point **14.40 V**



05-053

FEATURES	Original & X-References..	
A-Circuit	HITACHI	LR1100-508
Voltage Set Point 14.50 V		
Soft Start 30 %		
Field Shorted Circuit Protection		
Under Voltage Indication		
Over Voltage Indication		



05-054

FEATURES	Original & X-References..	
A-Circuit	HITACHI	L185G-5340
Voltage Set Point 14.40 V	TRANSPO	IH744
Soft Start 30 %		
Field Shorted Circuit Protection		
Under Voltage Indication		
Over Voltage Indication		

For use on: 1999-2000 Honda
 Passport 3.2L 1999-2000 Isuzu Rodeo
 3.2L Mid 1998-2000 Isuzu Amigo 3.2L



05-055

FEATURES	Original & X-References..	
A-Circuit		
Voltage Set Point 14.40 V		
Soft Start 30 %		
Field Shorted Circuit Protection		
Under Voltage Indication		
Over Voltage Indication		



05-065

FEATURES	Original & X-References..	
A-Circuit		
Voltage Set Point 14.40 V		
Soft Start 30 %		
Field Shorted Circuit Protection		
Under Voltage Indication		
Over Voltage Indication		



05-083

FEATURES	Original & X-References..	
A-Circuit		
Voltage Set Point 28.40 V		
Soft Start 30 %		
Field Shorted Circuit Protection		
Sense Open Indication		
Under Voltage Indication		
Over Voltage Indication		



05-091

FEATUERS

Original & X-References..

A-Circuit
 Voltage Set Point **14.40 V**
 Soft Start **30 %**
 Field, Lamp Shorted Circuit Protection
 Under Voltage Indication
 Over Voltage Indication

05-095

Voltage Set Point **28.40 V**
 Field Shorted Circuit Protection
 Sense Open Indication



05-094

FEATUERS

Original & X-References..

A-Circuit
 Voltage Set Point **14.40 V**
 Soft Start **30 %**
 Field Shorted Circuit Protection
 Under Voltage Indication
 Over Voltage Indication



05-099

FEATURES

Original & X-References..

A-Circuit
 Voltage Set Point **14.40 V**
 Soft Start **30 %**
 Field Shorted Circuit Protection
 Sense Open Indication
 Under Voltage Indication
 Over Voltage Indication



05-103

FEATURES

Original & X-References..

A-Circuit
 Voltage Set Point **28.25 V**
 Soft Start **30 %**
 Lamp Shorted Circuit Protection
 Under Voltage Indication
 Over Voltage Indication



05-100

FEATURES

Original & X-References..

A-Circuit
 Voltage Set Point **14.40 V**



05-052/HIR761

FEATURES	Original & X-References..	
A-Circuit	HITACHI	L180G-2340
Voltage Set Point 14.30 V	NISSAN	23215-85L00
Field, Lamp Shorted Circuit Protection	MOBILETRON	ILETR
Sense Open Indication		VR-H200-16
Under Voltage Indication	USI	71-50004
Over Voltage Indication	WAI	35-8120
	CARGO	135021
	TRANSPO	IH761
Alternators: Hitachi LR165-708C, LR170-738C, LR170-744, LR180-731B Nissan 23100-OE700, 23100-OE705		



05-088

FEATUERS	Original & X-References..	
A-Circuit	HITACHI	L180-5340
Voltage Set Point 14.30 V		L180G-5340
Field, Lamp Shorted Circuit Protection	USI	71-50003
Sense Open Indication	CARGO	135022
Under Voltage Indication	WAI	35-8123
Over Voltage Indication	TRANSPO	IH762
Alternators: Hitachi LR165-708C, LR170-738C, LR170-744, LR180-731B Nissan 23100-OE700, 23100-OE705		

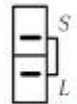

05-097

FEATUERS	Original & X-References..	
A-Circuit	HITACH	L170-33152
Voltage Set Point 14.60 V	NISSIAN	23215-50Y05
	MOBILETRON	VR-H2000-14
	WAI	35-8119
	TRANSPO	IH760

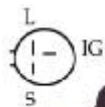

05-101

FEATURES	Original & X-References..	
A-Circuit	CARGO	232442
Voltage Set Point 14.50 V	WAI	35-8125
	TRANSPO	IH251

FOR USE ON : HONDA, ISUZU,
PICKUP



05-007/HIR205

FEATURES	Original & X-References..	
A-Circuit	HITACHI	L150-93155
Voltage Set Point 14.70 V		L160-23153
	MOBILETRON	VR-H2000-30
	CARGO	137189
	WAI	35-8136
	TRANSPO	IH205



05-010/HIR252V

FEATURES

A-Circuit
Voltage Set Point **14.70 V**

Original & X-References..

HITACHI	L150-33155
CARGO	133544
TRANSPO	IH252V

05-048/HIR252

Without Capacitor

TRANSPO	IH252
---------	-------

For use on: Industrial



05-011/HIR254V

FEATURES

A-Circuit
Voltage Set Point **14.70 V**

Original & X-References..

HITACHI	FA8065A
	L170-G1315
TRANSPO	IH254V

05-056/HIR254

Without Capacitor

TRANSPO	IH254
---------	-------

For use on: Isuzu and Opel
Vauxhall Astra 1.7D Ventra



05-012/HIR253V

FEATURES

A-Circuit
Voltage Set Point **28.40 V**

Original & X-References..

HITACHI	TR2Z-49
TRANSPO	IH253V

05-044/HIR253

Without Capacitor

TRANSPO	IH253
---------	-------

For use on: Nissan Forklift



05-013

FEATURES

A-Circuit
Voltage Set Point **14.60 V**

Original & X-References..



05-027/HIR204

FEATURES

A-Circuit
Voltage Set Point **14.70 V**

Original & X-References..

HITACHI	LR15078B
TRANSPO	IH204

05-034

Without wire plug



05-028/HIR2005

FEATURES

A-Circuit
Voltage Set Point **14.70 V**

Original & X-References..

HITACHI	L150-73154
MOBILETRON	VR-H2000-36
CARGO	132432

05-067

A-Circuit
Voltage Set Point **13.75 V**



05-030/HIR201

FEATURES

A-Circuit
Voltage Set Point **14.70 V**

Original & X-References..

HITACHI	IR1Z-27
WAI	35-8100 35-8114
MOBILETRON	VR-H2000-31
CARGO	132432
TRANSPO	IH201



05-032/HIR207

FEATURES

A-Circuit
Voltage Set Point **28.40 V**

Original & X-References..

HITACHI	L225-9315
CARGO	234701



05-040/HIR209

FEATURES

A-Circuit
Voltage Set Point **28.40 V**

Original & X-References..



05-046/HIR114

FEATURES

A-Circuit
Voltage Set Point **14.70 V**
With Capacitor

Original & X-References..

05-063/HIR202



FEATURES

A-Circuit
Voltage Set Point **28.40 V**

Original & X-References..

05-076/HIR203



FEATURES

A-Circuit
Voltage Set Point **14.30 V**

Original & X-References..

HITACHI	L15043151
	L15063151
WAI	35-8134
CARGO	130832
BOSCH	0986192028
TRANSPO	IH203

05-020/HIR112



FEATURES

A-Circuit
Voltage Set Point **14.70 V**
O.E. Grade

Original & X-References..

MOTOROLA	9RC2106
----------	---------

05-051



FEATURES

A-Circuit
Voltage Set Point **14.50 V**

Original & X-References..

05-084



FEATURES

A-Circuit
Voltage Set Point **28.50 V**

Original & X-References..



05-021/ HIR212

FEATURES

A-Circuit
Voltage Set Point **14.70 V**

Original & X-References..

HITACHI	L15023155
TRIZ-62	TRIZ64
TRIZ-53	TRIZ43
MOBILETRON	VR-H-2000-3
USI	71-50011
CARGO	136284
	131287
WAI	35-8101
TRANSPO	IH212



05-022/HIR716

FEATURES

A-Circuit
Voltage Set Point **28.40 V**

Original & X-References..

HITACHI	TR2Z-37	R2Z-49
MOBILETRON	VR-H200-2	
USI	71-50012	
WAI	35-8139	
CARGO	132292	
TRANSPO	IH716	



05-023/HIR212

FEATURES

A-Circuit
Voltage Set Point **14.70 V**

Original & X-References..

HITACHI	L15023155	TRIZ-43
	TRIZ-53	TRIZ-62
USI	71-50011	
WAI	35-8101	
TRANSPO	IH212	

For use on: Isuzu Pickup Diesel,
Nissan Maxima Diesel, Sentara, Pickup



05-060/HIR708

FEATURES

A-Circuit
Voltage Set Point **28.10V**

Original & X-References..

HITACHI	27700-1370
	27700-1510
CARGO	133516
TRANSPO	IH708

For use on: Nissan
Bus Truck & Industrial Hino



05-066/HIR210

FEATURES

A-Circuit
Voltage Set Point **14.70 V**

Original & X-References..

HITACHI	TR1Z-27	TR1Z-33
	TR1Z-47	TR1Z-48
MOBILETRON	VR-H2000-1	
CARGO	130834	
TRANSPO	IH210	

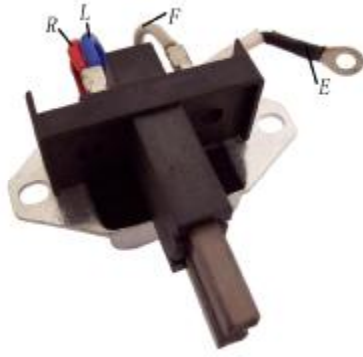

05-017

FEATURES

Original & X-References..

A-Circuit

Voltage Set Point **28.10 V**

For use on:

Nissan Bus, Truck & Industrial,

Hino, Bus, Truck & Industrial

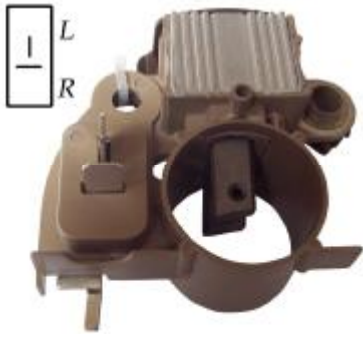

06-001/MIR216HD

FEATURES

A-Circuit
Voltage Set Point **14.70 V**

Original & X-References..

MITSUBISHI	
A866X04870	A866X04871
A866X04872	A866X05470
A866X05471	A866X05472
A866X06072	E35618W70
MD611032	MD611146
TRANSP0	IM216HD

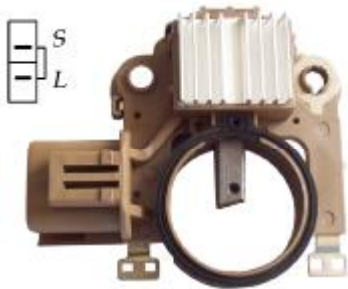

06-002/MIR847

FEATURES

A-Circuit
Voltage Set Point **14.50V**

Original & X-References..

MITSUBISHI	
A 866X25572	MD618735
	MD619167
MOBILETRON	VR-H2009-67
CARGO	137075
TRANSP0	IM847

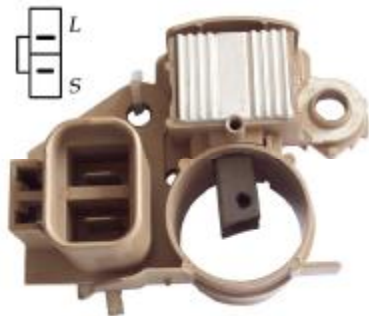

06-004/MIR217

FEATURES

A-Circuit
Voltage Set Point **14.50V**

For use on: Nissan, Dodge

Original & X-References..

MITSUBISHI	
A866X05272	A866X09071
A866X09072	A866X09771
A866X09782	MD611432
WAI	35-8302
TRANSP0	IM217HD

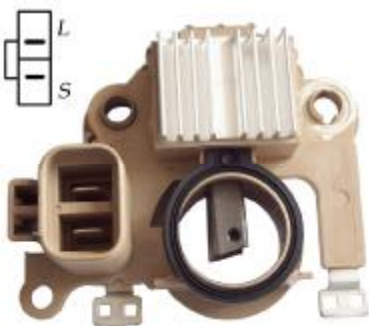

06-006/MIR832

FEATURES

A-Circuit
Voltage Set Point **14.50V**

For: Mitsubishi IR/IF Alternators

Original & X-References..

MITSUBISHI	
A002T34892	
MOBILETRON	VR-H2009-38
WAI	35-8336
CARGO	136649 230885
TRANSP0	IM832

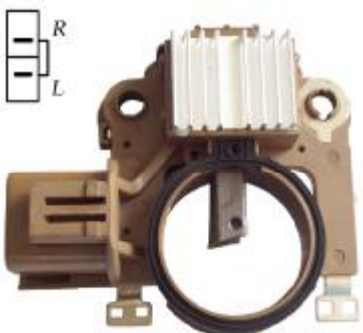

06-008/MIR846

FEATURES

A-Circuit
Voltage Set Point **28.70V**

Original & X-References..

MITSUBISHI	
A866X28372	ME701399
MOBILERTON	VR-H2009-80B
CARGO	234304
TRANSP0	IM846

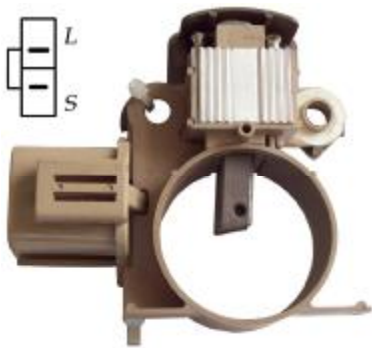

06-013/MIR281

FEATURES

A-Circuit
Voltage Set Point 14.50V

For use on: Mitsubishi Pajero 2500 Diesel, Delica 2300 Van Diesel, Mirage 1800 Diesel, Galant 1800 Diesel, Sava 1800 Diesel, Shariot 1800 Diesel

Original & X-References..

MITSUBISHI	A866X09171
	MD611481
MOBILETRON	VR-H2009-28
WAI	35-8355
CARGO	131471
TRANSPO	IM281

06-105

Voltage Set Point 28.50 V



06-014/MIR757

FEATURES

A-Circuit
Voltage Set Point **14.40 V**

For use on: Ford Transit Unit A3TN1791

Original & X-References..

MITSUBISHI	A866X40371
MOBILETRON	VR-H2009-82
CARGO	230985
TRANSPO	IM757



06-016/MIR809

FEATURES

A-Circuit
Voltage Set Point **14.50 V**
Field Shorted Circuit Protection
Over Voltage Indication
Without Trio Diode Application

For use on: Renault 2001-01 Clio II 1.5L

Original & X-References..

ALTERNATOR REFERENCES	
	AZTB6481
CARGO	CA1652IR

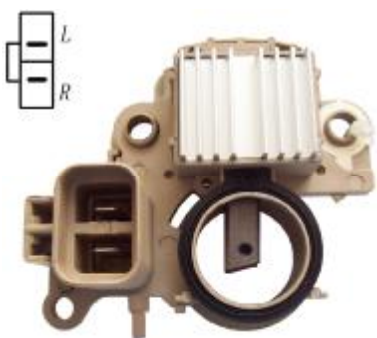

06-028

FEATURES

A-Circuit
Voltage Set Point **14.40 V**

Original & X-References..

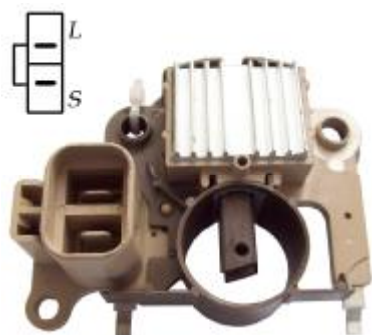

06-030/MIR280

FEATURES

A-Circuit
Voltage Set Point **14.50V**

Original & X-References..

WAI	35-8324
CARGO	135032
TRANSPO	IM280

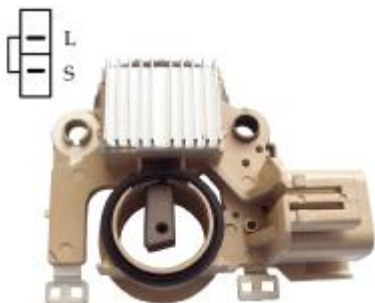

06-031/MIR292

FEATURES

A-Circuit
 Voltage Set Point **14.40 V**
 Sense Open Indication
 Under Voltage Indication
 Over Voltage Indication

Original & X-References..

MITSUBISHI	
A002T33493A	A002T33593A
A002T35791	A2T33593
A2T82491	
MOBILETRON	VR-H2009-45
WAI	35-8343
CARGO	1371882
TRANSP0	IM292

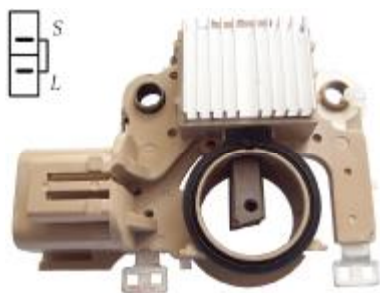

06-032/MIR2009-22

FEATURES

A-Circuit
 Voltage Set Point **14.40 V**
 Sense Open Indication
 Under Voltage Indication
 Over Voltage Indication

Original & X-References..

MITSUBISHI	
A866X20472	A866X20972
B64J18W70A	
MOBILETRON	VR-H2009-22
WAI	35-8333 35-8315
CARGO	135233
TRANSP0	IM830

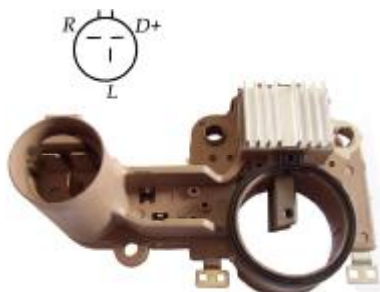

06-033/MIR001

FEATURES

A-Circuit
 Voltage Set Point **28.65V**

Original & X-References..

06-034

FEATURES

Original & X-References..

MITSUBISHI	
A866X35472	A866X35472
CARGO	138872
TRANSP0	IM345

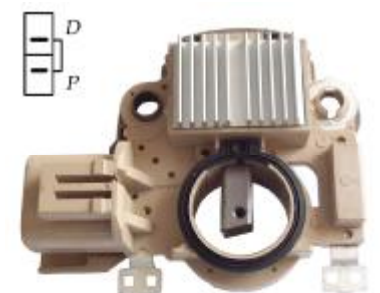

06-035

FEATURES

A-Circuit
 Voltage Set Point **14.40 V**
 Soft Start **30 %**
 LRC **5 Sec**
 Field Shorted Circuit Protection
 Sense Open Indication
 Under Voltage Indication
 Over Voltage Indication

Original & X-References..

MITSUBISHI	A866X35472
CARGO	230043

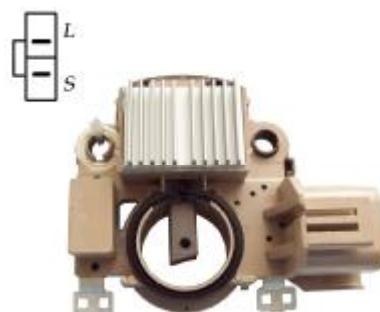



06-036/MIR290

FEATURES

A-Circuit
Voltage Set Point **14.40 V**

Original & X-References..	
MITSUBISHI	A866X26172
	MD618845
MOBILERON	VR-H2009-63
CARGO	138309
TRANSP0	IM290

06-037

FEATURES

A-Circuit
Voltage Set Point **14.40V**
Soft Start **30 %**
LRC **5 Sec**
Field Shorted Circuit Protection
Sense Open Indication
Under Voltage Indication
Over Voltage Indication

Original & X-References..	
---------------------------	--

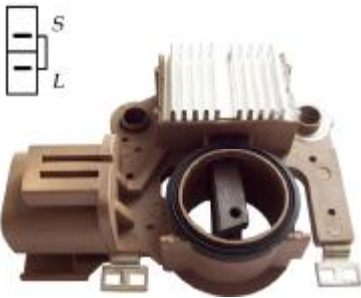

06-041/MIR278

FEATURES

A-Circuit
Voltage Set Point **14.50V**

Original & X-References..	
MITSUBISHI	A005T03092
MOBILETRON	VR-H2009-30
WAI	35-8326
CARGO	134088
TRANSP0	IM278

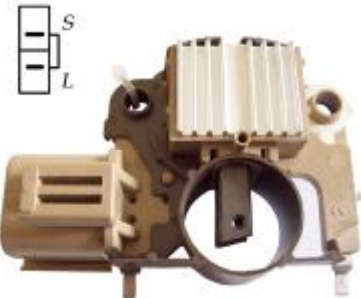

06-043/MIR005

FEATURES

A-Circuit
Voltage Set Point **14.40 V**

Original & X-References..	
CARGO	235205



06-046/MIR2009-58

FEATURES

A-Circuit
Voltage Set Point **14.80 V**

Original & X-References..	
MITSUBISHI	A 2T2094B
MOBILETRON	VR-H2009-58

06-045

A-Circuit
Voltage Set Point **14.40 V**



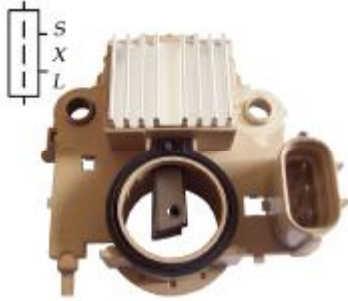

06-047/MIR002

FEATURES

A-Circuit
Voltage Set Point **14.50 V**

Original & X-References..



06-050

FEATURES

A-Circuit
Voltage Set Point **14.40V**
Soft Start **30 %** LRC **5 Sec**
Field Shorted Circuit Protection
Sense Open Indication
Under / Over Voltage Indication

Original & X-References..

TRANSPO IM476

06-063

Without Sense Open Indication, Others
Function are the same as 06-050

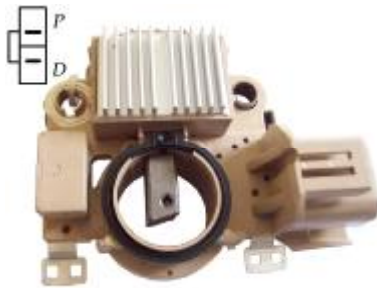

06-051

FEATURES

Original & X-References..

MITSUBISHI	A866X46572 GY0118W70 A3TG0081
MOBILETRON TRANSPO	VR-H2009-100 IM465

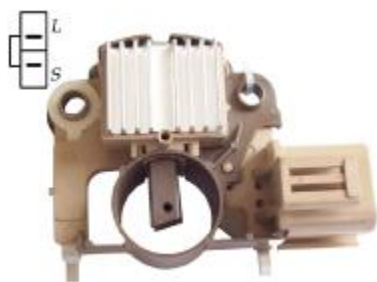

06-053/MIR271

FEATURES

A-Circuit
Voltage Set Point **14.50V**

Original & X-References..

MITSUBISHI	A866X17470 A866X21472 A866X13272 A866X15170
CARGO TRONSPO	135030 IM284 IM271



06-056

FEATURES

A-Circuit
Voltage Set Point **14.50V**

Original & X-References..

ALTERNATOR REFERENCES
HYUNDAI 3730042451
MANDO AF175363

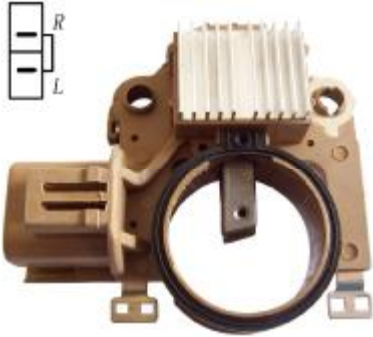

06-059

FEATURES

Original & X-References..

A-Circuit
Voltage Set Point **28.65 V**



06-060/MIR003

FEATURES

Original & X-References..

A-Circuit
Voltage Set Point **14.50V**

06-089
With B+ Bolt



06-065

FEATURES

Original & X-References..

A-Circuit
Voltage Set Point **A 14.50V**

CARGO	231425
MOBILETRON	VR-MD07
TRANSPO	IY094

For use on : Alternators Mando
AB170094 OK2A218300

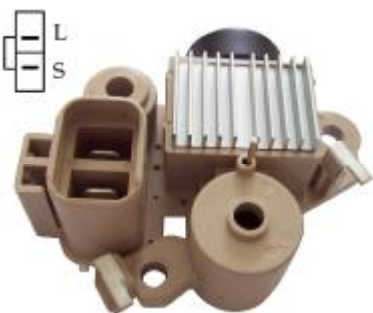

06-066

FEATURES

Original & X-References..

A-Circuit
Voltage Set Point **14.50V**

HYUNDAI	37370-22600
MADNO	TA500-C09001
MOBILETRON	VR-MD06
TRANSPO	IY028



06-067

FEATURES

Original & X-References..

A-Circuit
Voltage Set Point **14.50V**

HYUNDAI	37300-22200
MOBILETRON	VR-H2009-86
CARGO	138204
TRANSPO	IY058

For use on : Alternators
3730022200 AB190058

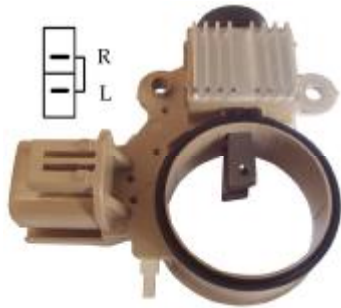

06-072**FEATURES**

Original & X-References..

A-Circuit
Voltage Set Point **28.65V**

06-073**FEATURES**

Original & X-References..

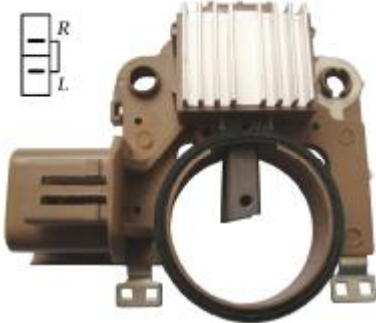
A-Circuit
Voltage Set Point **28.65V**

06-080/MIR847R**FEATURES**

Original & X-References..

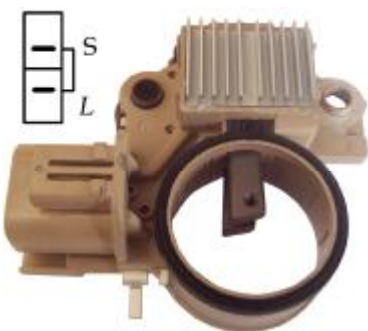
A-Circuit
Voltage Set Point **14.80V**

06-081**FEATURES**

Original & X-References..

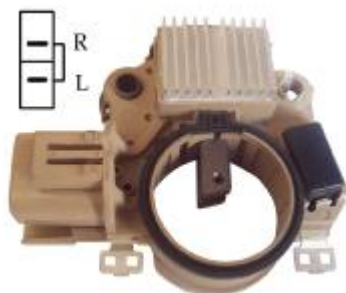
A-Circuit
Voltage Set Point **14.50V**

06-082**FEATURES**

Original & X-References..

A-Circuit
Voltage Set Point **28.65V****06-094**Voltage Set Point **28.70V****06-103**Voltage Set Point **14.80V**

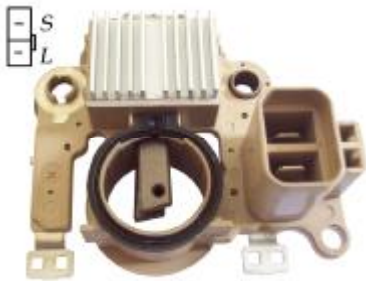

06-085

FEATURES

A-Circuit
 Voltage Set Point **14.40V**
 Sense Open Indication
 Under Voltage Indication
 Over Voltage Indication

Original & X-References..

MITSUBISHI	A866X27572
	ME701363
CARGO	139110
TRANSPO	IM854

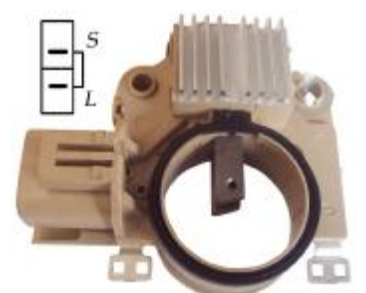

06-086

FEATURES

A-Circuit
 Voltage Set Point **28.50 V**

Original & X-References..

28241239

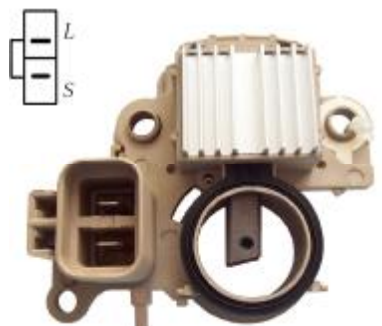

06-088/MIR831

FEATURES

A-Circuit
 Voltage Set Point **14.50 V**

Original & X-References..

MITSUBISHI	A866T09780
	A866T09782
MOBILETRON	VR-H2009-78
TRANSPO	IM831

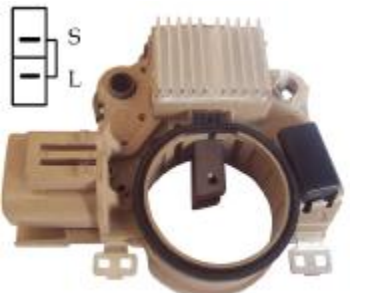

06-090

FEATUERS

A-Circuit
 Voltage Set Point **14.50V**

Original & X-References..

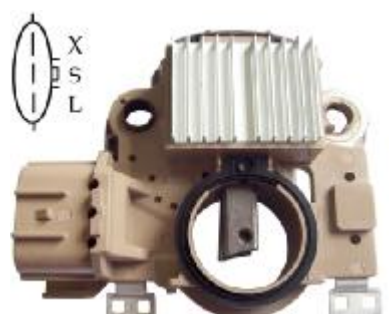

06-092

FEATUERS

A-Circuit
 Voltage Set Point **14.40 V**
 Soft Start **30 %**
 LRC **5 Sec**
 Field Shorted Circuit Protection
 Sense Open Indication
 Under Voltage Indication
 Over Voltage Indication

Original & X-References..

MITSUBISHI	427
SUBARU	23815-AA140
MOBILETRON	VR-H2009-107
TRANSPO	IM848

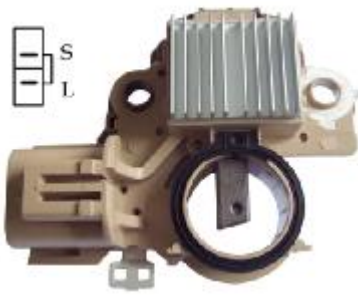

06-093

FEATUERS	Original & X-References..
A-Circuit Voltage Set Point 14.50 V	MOBILETRON VR-H2009-116 MANDO AB170036 KIA OK201-18-300B



06-095

FEATUERS	Original & X-References..
A-Circuit Voltage Set Point 28.35 V	MITSUBISHI A0037A8591

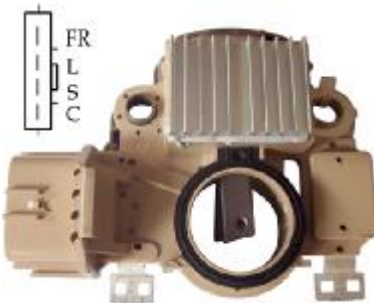

06-096

FEATUERS	Original & X-References..
A-Circuit Voltage Set Point 14.60 V Soft Start 30 % Field, Lamp Shorted Circuit Protection Sense Loss Indication Under Voltage Indication Over Voltage Indication DFM function	MOBILETRON VR-H2009-70A MITSUBISHI A866X34172

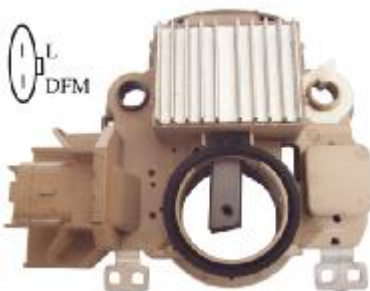

06-097

FEATUERS	Original & X-References..
A-Circuit Voltage Set Point 14.50 V Soft Start 30 % LRC 5 sec Field, Lamp Shorted Circuit Protection Under Voltage Indication Over Voltage Indication DFM function	MITSUBISHI A866X498 MOBILETRON VR-H2009-105 TRANSPO IM498



06-098

FEATUERS	Original & X-References..
A-Circuit Voltage Set Point 28.50 V Soft Start 30 % Field, Lamp Shorted Circuit Protection IG Open Indication Sense Loss Indication Under Voltage Indication Over Voltage Indication	



06-099

FEATUERS	Original & X-References..
A-Circuit Voltage Set Point 14.25 V PCM	RES14278



06-100

FEATUERS	Original & X-References..
Works with PCM Traditional test method will immediately damage P-D	MITSUBISHI A860X85670 TRANSPO IM505 MOBILETRON VR-H2009-114



06-101

FEATUERS	Original & X-References..
A-Circuit RC=0 Vs= 13.50V RC=55% Vs= 14.25V	MITSUBISHI A866T52970 TRANSPO IM529



06-102

FEATUERS	Original & X-References..
A-Circuit Voltage Set Point 28.70 V	



06-107

FEATUERS	Original & X-References..
A-Circuit Voltage Set Point 14.60 V	MOBILETRON VR-H2009-75 TRANSPO IM288

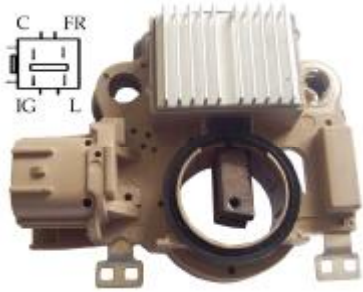

06-108

FEATUERS	Original & X-References..	
A-Circuit	MOBILETRON	VR-H2009-113
Voltage Set Point 14.60 V	TRANSPO	IM558
Soft start		
Stator activated		

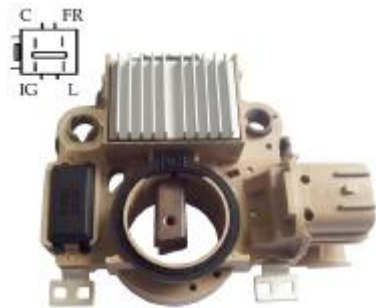

06-109

FEATURES	Original & X-References..	
A-Circuit	TRANSPO	IM851
Voltage Set Point 14.60 V	DIXIE	35-13893
Soft start		
Stator activated		

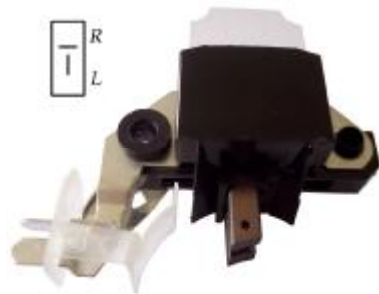

06-003/MIR213

FEATURES	Original & X-References..	
A-Circuit	MITSUBISHI	
Voltage Set Point 28.50 V	A866X04872	A866X05471
	A866X05472	E35618W70
	MD611032	MD611146
For use on: Chrysler, Hyundai, Mazda, Mitsubishi	MOBILETRON	VR-H2009-12
	WAI	35-8301
	CARGO	131517
	TRANSPO	IM213HD



06-009/MIR205

FEATURES	Original & X-References..	
A-Circuit	MITSUBISHI	
Voltage Set Point 14.60 V	A866T03070	A866T1827
	A866T03470	MD618302
	MD607619	
06-064	MOBILETRON	VR-H2009-18
Voltage Set Point 28.50 V	WAI	35-8304
For use on: Chrysler D50 Diesel Pick-Up	CARGO	131290
	TRANSPO	IM205

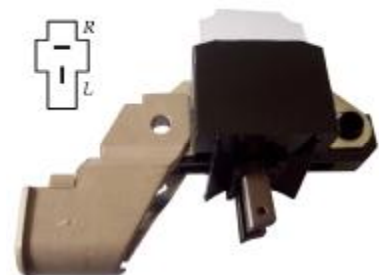

06-011/MIR212

FEATURES	Original & X-References..	
A-Circuit	MITSUBISHI	A866T06870
Voltage Set Point 28.50 V		ME700635
	MOBILETRON	VR-H2009-47
	CARGO	137396
	TRANSPO	IM212

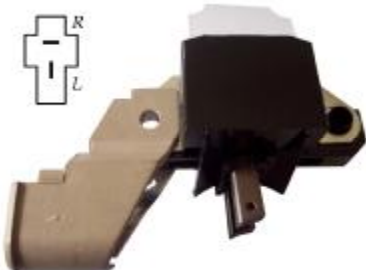

06-018/MIR208

FEATURES

A-Circuit
Voltage Set Point **14.60 V**

For use on: Fuso Trucks

Original & X-References..

MITSUBISHI	A866T08570
	ME700556
MOBILETRON	VR-H2009-46
WAI	35-8344
TRANSPO	IM208

06-020/MIR204

FEATURES

A-Circuit
Voltage Set Point **14.60 V**

For use on: Chrysler

Original & X-References..

MITSUBISHI	A866T00470	A866T00670
	A866T01970	A866T02770
	A866T01970	A866T02770
MOBILETRON		VR-H2009
WAI		35-8300
CARGO		130835
TRANSPO		IM204



06-027/MIR203

FEATURES

A-Circuit
Voltage Set Point **28.50 V**

Original & X-References..

MITSUBISHI	0207	207
MOBILETRON		VR-H2009-21
TRANSPO		IM203



06-044/MIR207

FEATURES

A-Circuit
Voltage Set Point **14.60 V**

Original & X-References..

MITSUBISHI	A 00522578
MOBILETRON	VR-H2009-48
UNIPOINT	YR-562
WAI	35-8360
TRANSPO	IM207

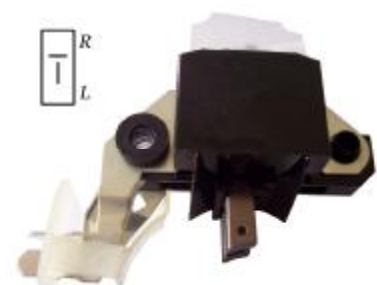

06-049

FEATURES

A-Circuit
Voltage Set Point **14.50V**

Original & X-References..

MITSUBISHI	A866T00870
	A866T02270
	A866T02970
MOBILETRON	VR-H2009-3
CARGO	131289
TRANSPO	IM225





06-039/MIR215

FEATURES

A-Circuit
Voltage Set Point **28.50 V**

Original & X-References..

MITSUBISHI	A866 T 01070
	A866 X 01070
	ME700091
WAI	35-8328
CARGO	131518
TRANSP0	IM215



06-019/MIR843

FEATURES

A-Circuit
Voltage Set Point **28.60 V**

For use on: Mitsubishi
Motors Industrial
Fuso Large Truck

Original & X-References..

MITSUBISHI	A866X26070
	A866X26072
	ME701302
MOBILETRON	VR-H2009-77
TRANSP0	IM843

06-026

A-Circuit
Voltage Set Point **14.80 V**



06-052/MIR286

FEATURES

A-Circuit
Voltage Set Point **28.70 V**

Original & X-References..

MITSUBISHI	A866X08871	A866X19972
	ME7000783	ME701196
MOBILETRON	VR-H2009-69B	
TRANSP0	IM286	

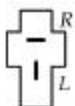

06-055

FEATURES

A-Circuit
Voltage Set Point **14.80V**

Original & X-References..

MITSUBISHI	A866X08971
	A866X23972
	ME7000799
	ME701260
MOBILETRON	VR-H2009-69
TRANSP0	IM294



06-057

FEATURES

A-Circuit
Voltage Set Point **28.50 V**

Original & X-References..



06-068

FEATURES	Original & X-References..	
A-Circuit	KIA	62124520
Voltage Set Point	14.50V	



06-069

FEATURES	Original & X-References..	
A-Circuit	KIA	055318300B
Voltage Set Point	14.50V	



06-070

FEATURES	Original & X-References..	
A-Circuit	POONG SUNG	02121-8207
Voltage Set Point	14.80V	
	MOBILETRON	VR-K01
	CARGO	139469

06-079

A-Circuit	POONG SUNG	02121-8207
Voltage Set Point	28.60V	
	MOBILETRON	VR-K01B

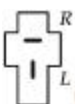

06-078

FEATURES	Original & X-References..	
A-Circuit	TRANSPO	IY510
Voltage Set Point	14.60V	

For use on : KIA TICO



06-029/HYR4220

FEATURES	Original & X-References..	
A-Circuit	TRANSPO	IY422
Voltage Set Point	14.50 V	



07-001/MGR110

FEATURES

A-Circuit
Voltage Set Point **14.50 V**

For use on:633-200 And 633-210
Series Magneti-Marelli
Alternators On late Fiat Models

Original & X-References..

MAGNETI MARELLI
58120022 79707161
797 074 81 RTT 119 A
RTT 119 AAC RTT 119 AC
83600151
WAI 35-9304
CARGO 131283
TRANSPO IX110



07-005/MGR111

FEATURES

A-Circuit
Voltage Set Point **28. 50 V**

For use on:
Fial Tractors And Other
Fial Applications

Original & X-References..

MAGNETI MARELLI
79707441 RTT 117 B
MOBILETRON VR-F119B
CARGO 131286
TRANSPO IX111



07-015

FEATURES

A-Circuit
Voltage Set Point **28.50 V**

Original & X-References..



07-002/MGR122

FEATURES

A-Circuit
Voltage Set Point **14.50 V**
Field Shorted Circuit Protection
Over Voltage Indication

07-018

Voltage Set Point **14.50 V**
Cut-in Speed: 1200rpm

07-023

Voltage Set Point **14.50 V**

Original & X-References..

MAGNETI
RTM151A 83611361
MOBILETRON VR-F151A
CARGO 136432
UNIPOINT YR-388
TRANSPO IX 121

For use on:Fiat Punto 62
Cabrio Selcta Punto 75 ELX
HSD S SX



07-014

FEATURES

A-Circuit
Voltage Set Point **14.50 V**
Soft Start **30 %**
LRC **5 sec**
Field Shorted Circuit Protection
Under Voltage Indication
Over Voltage Indication

Original & X-References..

MAGNETI
RTM151A 83611361
MOBILETRON VR-F151A
CARGO 136432
UNIPOINT YR-388
TRANSPO IX 121



07-004/MGR123

FEATURES

A-Circuit
 Voltage Set Point **14.50 V**
 Field Shorted Circuit Protection
 Over Voltage Indication

Original & X-References..

MOBILETRON	VR-F153A
CARGO	138789
WAI	35-9306
TRANSPO	IX 123

07-029

A-Circuit
 Voltage Set Point **14.50 V**

For use on: Land Rover



07-032/MGR123

FEATURES

A-Circuit
 Voltage Set Point **14.50 V**
 Soft Start **30 %**
 LRC **5 sec**
 Field Shorted Circuit Protection
 Under Voltage Indication
 Over Voltage Indication

Original & X-References..



07-010/MGR126

FEATURES

A-Circuit
 Voltage Set Point **14.50 V**
 Field Shorted Circuit Protection
 Over Voltage Indication

Original & X-References..



07-016

FEATURES

A-Circuit
 Voltage Set Point **14.50 V**
 Soft Start **32 %** LRC **5 sec**
 Field Shorted Circuit Protection
 Under / Over Voltage Indication
 DFM function

Original & X-References..

CARGO	233636
	CA1890

07-020

Cut-in Speed: 1200rpm, Others
 Function are the same as 07-016



07-017

FEATURES

A-Circuit
 Voltage Set Point **14.50 V**
 Soft Start **32 %**
 LRC **5 sec**
 Field Shorted Circuit Protection
 Under Voltage Indication
 Over Voltage Indication
 DFM function

Original & X-References..

MAGNETI MARELLI	85563491
CARGO	238265
MOBILETRON	VR-F157



07-025

FEATURES

A-Circuit
 Voltage Set Point **14.50 V**
 Field Shorted Circuit Protection
 Over Voltage Indication

Original & X-References..

IK5121

07-026

A-Circuit
 Voltage Set Point **14.50 V**
 Field, Shorted Circuit Protection



07-027

FEATURES

B-Circuit
 Voltage Set Point **14.50 V**

Original & X-References..



07-028

FEATURES

A-Circuit
 Voltage Set Point **14.50 V**
 Soft Start **30 %**
 LRC **5 sec**
 Field Shorted Circuit Protection
 Under / Over Voltage Indication

Original & X-References..



07-019

FEATUERS

A-Circuit
 RC=0 Vs=**13.50V**
 RC=**55%** Vs=**14.25V**

Original & X-References..

MARELLI	85582601010
MOBILETRON	VR-F156
TRANSPO	IX131



07-021

FEATURES

A-Circuit
 Voltage Set Point **14.60 V**
 Soft Start **32 %**
 LRC **5 sec**
 Field Shorted Circuit Protection
 Under Voltage Indication
 Over Voltage Indication
 With Trio Diode Application

Original & X-References..

FIAT	83614251	99946065
TRANSPO		IX127



07-022

FEATURES

A-Circuit
Voltage Set Point **28.50 V**
Soft Start **30 %**
Under Voltage Indication
Over Voltage Indication

Original & X-References..

FIAT	83614251	99946065
TRANSPO		IX127



07-024

FEATURES

A-Circuit
Voltage Set Point **14.60 V**
Soft Start **32 %**
LRC **5 sec**
Field Shorted Circuit Protection
Under Voltage Indication
Over Voltage Indication
With Trio Diode Application

Original & X-References..

WAI		35-9305
TRANSPO		IX128



08-001/VAR203

FEATURES

B-Circuit
 Voltage Set Point **14.50 V**
 Soft Start **30 %** LRC **5 sec**
 Field Shorted Circuit Protection
 Under/ Over Voltage Indication
 DFM function

Original & X-References..

CARGO 234982

08-047

Self exciting



08-004/VAR517

FEATURES

B-Circuit
 Voltage Set Point **14.50 V**
 Soft Start **30 %**
 LRC **5 sec**
 Field Shorted Circuit Protection
 Under Voltage Indication
 Over Voltage Indication

Original & X-References..

VALEO 593290 593310 593349
 CARGO 139456 230784 230785
 TRANSPO M517



08-006/VAR206

FEATURES

B-Circuit
 Voltage Set Point **14.50 V**
 Soft Start **30 %**
 LRC **5 sec**
 Field Shorted Circuit Protection
 Under Voltage Indication
 Over Voltage Indication
 DFM function

Original & X-References..

VALEO 2542292
 MOBILETRON VR-PR2292
 CARGO 231103
 TRANSPO M521



08-007/VAR514

FEATURES

A-Circuit
 Voltage Set Point **14.50 V**

Original & X-References..

MOBILETRON VR-PR1669
 CARGO 136546
 TRANSPO M514



08-008/VAR204

FEATURES

B-Circuit
 Voltage Set Point **14.50 V**
 Soft Start **30 %** LRC **5 sec**
 Field Shorted Circuit Protection
 Under Voltage Indication
 Over Voltage Indication
 DFM Function

Original & X-References..

VALEO 2542299
 593384
 593396
 MOBILETRON VR-PR2299H
 CARGO 232962

08-046

Self exciting



08-009/VAR519

FEATURES

B-Circuit
 Voltage Set Point **14.50 V**
 Soft Start **30 %**
 LRC **5 sec**
 Field Shorted Circuit Protection
 Under Voltage Indication
 Over Voltage Indication

Original & X-References..

VALEO	A14V115	A14V116
	A14V127	A14V135
	A14V141	
TRANSPO	M519	



08-010/VAR512

FEATURES

A-Circuit
 Voltage Set Point **14.50 V**

Original & X-References..

HUCO	130696	
MOBILETRON	VR-VW010	
CARGO	133988	134475
TRANSPO	M511	



08-012/VAR516

FEATURES

B-Circuit
 Voltage Set Point **14.50 V**
 Soft Start **30 %** LRC **5 sec**
 Field, Lamp Shorted Circuit Protection
 Under / Over Voltage Indication
 DFM Function

Original & X-References..

VALEO	593316	2541952
	YM1620	
MOBILETRON	VR-PR1620	
CARGO	139440	139441
TRANSPO	M516	

08-037

Voltage Set Point **14.05 V**



08-016/VAR520

FEATURES

B-Circuit
 Voltage Set Point **14.50 V**
 Soft Start **30 %**
 LRC **5 sec**
 Field Shorted Circuit Protection
 Under Voltage Indication
 Over Voltage Indication
 DFM function

Original & X-References..

VALEO	593362	
	YM 1610F	
CARGO	234533	



08-018/VAR207

FEATURES

B-Circuit
 Voltage Set Point **14.50 V**
 Soft Start **30 %**
 LRC **5 Sec**
 Field Shorted Circuit Protection
 Under Voltage Indication
 Over Voltage Indication
 DFM Function

Original & X-References..

VALEO	593419	
CARGO	233633	



08-019/VAR513

FEATURES

A-Circuit
Voltage Set Point **14.50 V**

Original & X-References..

MOBILETRON	VR-PR1667
CARGO	135434
TRANSPO	M513

For use on: Fiat, Audi



08-020

FEATURES

B-Circuit
Voltage Set Point **14.50 V**
Soft Start **30 %**
LRC **5 sec**
Field Shorted Circuit Protection
Under Voltage Indication
Over Voltage Indication

Original & X-References..

VALEO	593534
	593477
	593505
MOBILETRON	VR-PR3534
CARGO	234115

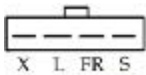

08-023

FEATURES

B-Circuit
Voltage Set Point **14.80 V**
Soft Start **30 %**
LRC **5 sec**
Field Shorted Circuit Protection
Sense Open Indication
Under Voltage Indication
Over Voltage Indication
DFM function

Original & X-References..

VALEO	2546366C
	2546493C
MOBILETRON	VR-PR6366
TRANSPO	M515



08-024/VAR201

FEATURES

B-Circuit
Voltage Set Point **14.50 V**

Original & X-References..

CARGO	234961
-------	--------



08-025

FEATURES

B-Circuit
Voltage Set Point **14.50 V**

Original & X-References..



08-032

FEATURES

B-Circuit
 Voltage Set Point **14.50 V**
 Soft Start **30 %**
 LRC **5 sec**
 Field Shorted Circuit Protection
 Under Voltage Indication
 Over Voltage Indication
 DFM function

Original & X-References..

VALEO	545472	548419
		593529
MOBILETRON	VR-PR3529	
ALTERNATOR	REFERENCES	
VALEO	A13VI277	



08-028

FEATUERS

B-Circuit
 Voltage Set Point **14.40 V**
 Soft Start **18 %**
 LRC **10 sec**
 Field, Lamp Shorted Circuit Protection
 Under Voltage Indication
 Over Voltage Indication
 DFM function

Original & X-References..

VALEO	493811
-------	--------



08-044

FEATUERS

A-Circuit
 Voltage Set Point **14.80 V**
 Soft Start **15 %**
 LRC **2.5 sec**

Original & X-References..

COM regulator



08-031

FEATUERS

B-Circuit
 Voltage Set Point **14.50 V**
 Soft Start **32 %**
 LRC **5 sec**
 Field, Shorted Circuit Protection
 Under Voltage Indication
 Over Voltage Indication

Original & X-References..



08-033

FEATUERS

B-Circuit
 Voltage Set Point **14.80 V**
 Soft Start **32 %**
 LRC **5 sec**
 Field, Shorted Circuit Protection
 Under Voltage Indication
 Over Voltage Indication

Original & X-References..

CA1631



08-035

FEATUERS **Original & X-References..**

B-Circuit
 Voltage Set Point **14.50 V**
 Soft Start **30 %**
 LRC **5 sec**
 Field Shorted Circuit Protection
 Under Voltage Indication
 Over Voltage Indication
 DFM function



08-036

FEATUERS **Original & X-References..**

A-Circuit
 Voltage Set Point **14.70 V**

08-042

A-Circuit
 Voltage Set Point **14.70 V**



08-038

FEATUERS **Original & X-References..**

A-Circuit
 Voltage Set Point **14.50V**



08-039

FEATUERS **Original & X-References..**

B-Circuit
 Voltage Set Point **14.45 V**
 Soft Start **30 %**
 LRC **5 sec**
 Field Shorted Circuit Protection
 Sense Open Indication
 Under Voltage Indication
 Over Voltage Indication
 DFM function



08-043

FEATUERS **Original & X-References..**

A-Circuit
 RC=**0** $V_s=13.50V$
 RC=**55%** $V_s=14.25V$

VALEO 593675
TG9C013



08-022/VAR513 28V

FEATURES

A-Circuit
Voltage Set Point **28.10 V**

Original & X-References..

VALEO	593260
	ZV3960H
	CA13102R
MOBILETRON	VR-PR3960
CARGO	137489



08-026/VAR521

FEATURES

A-Circuit
Voltage Set Point **14.50 V**

Original & X-References..

CARGO	235369
-------	--------



08-027

FEATURES

A-Circuit
Voltage Set Point **14.70 V**

Original & X-References..

VALEO	493820
	439427
CARGO	235079

08-034

A-Circuit
Voltage Set Point **28.50 V**



08-014/VAR125

FEATURES

A-Circuit
Voltage Set Point **14.60 V**

Original & X-References..

LUCAS	21225183	21225371
VALEO	092897	092902
MOBILETRON	VR-PR1925H	
WAI	35-9401	
CARGO	130661	131552
TRANSPO	IP125	



08-015/VAR1652N

FEATURES

A-Circuit
Voltage Set Point **14.50 V**

Original & X-References..

For use on : AMC, Renault, Volvo

LUCAS	21225345	UCB218
VALEO	182046	2590588
MOBILETRON	VR-PR1652H	
WAI	35-9405	35-9405-1
CARGO	130657	
TRANSPO	IP1652	



08-021/VAR124

FEATURES

A-Circuit
Voltage Set Point **28.50 V**

Original & X-References..

VALEO	590640
MOBILETRON	VR-PR128B
CARGO	131120
TRANSPO	IP126



08-017/YD-T005

FEATURES

A-Circuit
Voltage Set Point **14.20 V**

Original & X-References..

VALEO	2521766
	592806 592952
MOBILETRON	VR-VW005N
CARGO	135393 131224
TRANSPO	M507 M506



09-001

FEATURES	Original & X-References..
A-Circuit	MOTOROLA 9RC3118
Voltage Set Point 28.50V	USI 71-90009
T.C. -10mV/°C	

09-009

Voltage Set Point **28.50V**
T.C. -7mV/°C



09-020

FEATURES	Original & X-References..
A-Circuit	MOTOROLA 9RC2106
Voltage Set Point 14.50V	

09-007

Voltage Set Point **14.70 V**



09-002

FEATURES	Original & X-References..
A-Circuit	MOTOROLA 9RC3114
Voltage Set Point 28.20V	USI 71-90001
Field Shorted Circuit Protection	

09-003

Voltage Set Point **28.20V**



09-004

FEATURES	Original & X-References..
A-Circuit	MOTOROLA 9RC3114
Voltage Set Point 28.50 V	USI 71-90006
Field, Shorted Circuit Protection	

09-005

Voltage Set Point **28.50 V**



09-012

FEATUERS	Original & X-References..
A-Circuit	MOTOROLA 9RC3114
Voltage Set Point 28.50 V	
Field, Shorted Circuit Protection	
Longer pin	

09-019

Voltage Set Point **28.00 V**
Longer pin



09-013

FEATUERS
A-Circuit
Voltage Set Point **14.50 V**

Original & X-References..
MOTOROLA 9RC2020



10-001/MPR291

FEATURES	Original & X-References..
A-Circuit	MAGNETON-PAL
Voltage Set Point 14.50 V	0134291 0134541
For SKODA Series Alternators	443930134291
	LUCAS VCB901
	TRANSPO MP291



10-003

FEATUERS	Original & X-References..
A-Circuit	
Voltage Set Point 14.40 V	



11-001

FEATURES	Original & X-References..
A-Circuit	FOR MILITARY VEHICLE
Voltage Set Point 28.20 V	5 Wiring Application



11-002

FEATURES	Original & X-References..
A-Circuit	FOR MILITARY VEHICLE
Voltage Set Point 28.20 V	6 Wiring Application





12-001/NKR428

FEATURES

A-Circuit
Voltage Set Point **28.80 V**

Original & X-References..

FOR HINO SERIES ALTERNATORS



12-002/NKR228

FEATURES

A-Circuit
Voltage Set Point **29.30 V**

Original & X-References..

FOR KOMATSU GRAB
CARGO 135296
TRANSPO IZ228



12-003/NKR328

FEATURES

A-Circuit
Voltage Set Point **29.30 V**

Original & X-References..

12-008

A-Circuit
Voltage Set Point **28.50 V**

12-009

With One Diode



12-005/NKR227

FEATURES

A-Circuit
Voltage Set Point **28.40 V**
With 4 pins

Original & X-References..

FOR KOMATSU GRAB

12-006/NKR229

A-Circuit
Voltage Set Point **14.50 V**
With 4 pins



12-007

FEATURES

A-Circuit
Voltage Set Point **28.80 V**

Original & X-References..

NIKKO 1440000580
1440000730
ISUZU 1812510040
1812510240
5812510120
MOBLETRON VR-H2003-1B
TRANSPO IZ226



12-010

FEATUERS	Original & X-References..
A-Circuit Voltage Set Point 29.30 V	KM155



12-011

FEATUERS	Original & X-References..
A-Circuit Voltage Set Point 29.20 V	KM156



12-012

FEATUERS	Original & X-References..
A-Circuit Voltage Set Point 28.40 V	



14-001

FEATURES

A-Circuit
Voltage Set Point **14.20 V**

For LEECE NEVILLE
Series Alternator

Original & X-References..
LEECE NEVILLE
102200 L79000LH
TRANSPO L79000LH
23002800

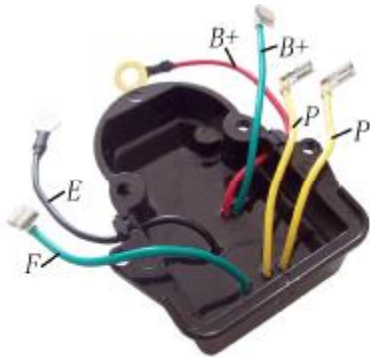

14-002

FEATURES

A-Circuit
Voltage Set Point **14.50 V**

FOR USE ON Alternators

Original & X-References..
MOTOROLA
105292 8RG2029A
110434 110555
8LAH2070V 8LHA2027
TRANSPO M5-292A



14-003

FEATURES

A-Circuit
Voltage Set Point **28.20 V**
Field, Lamp Shorted Circuit Protection
Over Voltage Indication
With Battery Operation

Original & X-References..
PRESTOLITE 8RL3108C

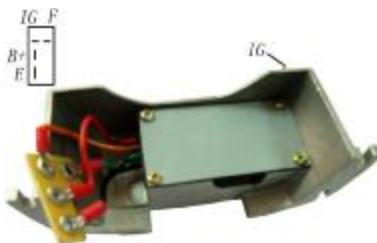

14-004

FEATURES

A-Circuit
Voltage Set Point **27.50V**
Field Shorted Circuit Protection
Over Voltage Indication
Without Battery Operation

Original & X-References..
PRESTOLITE
105229 105246 105351 105396
8RL3007 8RL3011
8RL3023C
MOBILETRON VR-VW006
TRANSPO M5-396

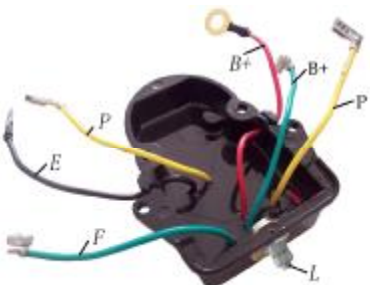

14-006

FEATURES

A-Circuit
Voltage Set Point **28.00V**
Field, Lamp Shorted Circuit Protection
Over Voltage Indication
With Battery Operation

Original & X-References..



14-010

FEATUERS

Original & X-References..

A-Circuit
 Voltage Set Point **28.20 V**
 Field, Lamp Shorted Circuit Protection
 Over Voltage Indication

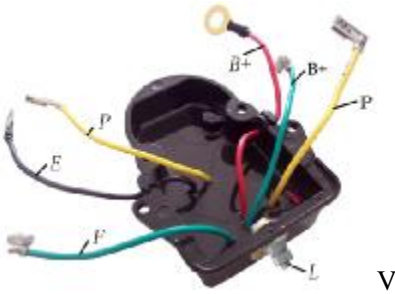

14-012

FEATUERS

Original & X-References..

A-Circuit
 Voltage Set Point **28.00 V**
 Field, Lamp Shorted Circuit Protection
 Over Voltage Indication



14-014

FEATUERS

Original & X-References..

A-Circuit
 Voltage Set Point **28.00 V**
 Field, Lamp Shorted Circuit Protection
 Over Voltage Indication

销售确认停用



14-015

FEATUERS

Original & X-References..

A-Circuit
 Voltage Set Point **28.50 V**
 Field, Shorted Circuit Protection

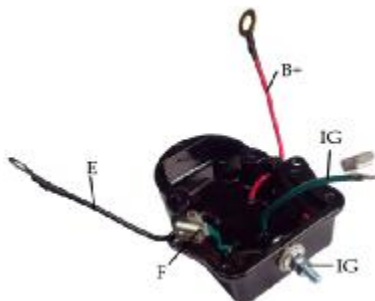

14-016

FEATUERS

Original & X-References..

A-Circuit
 Voltage Set Point **27.50 V**
 Field, Shorted Circuit Protection

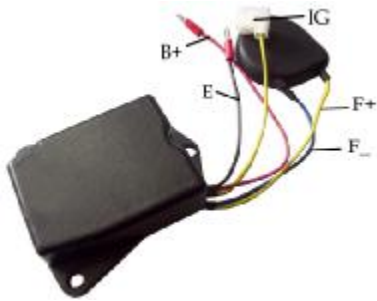

14-017

FEATUERS

Original & X-References..

A-Circuit
Voltage Set Point **27.50 V**
Field, Shorted Circuit Protection

Customer provide aluminum housing

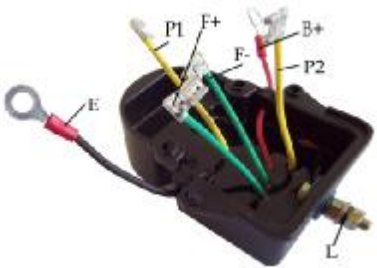

14-018

FEATUERS

Original & X-References..

A-Circuit
Voltage Set Point **28.00V**
Field, Lamp Shorted Circuit Protection
Over Voltage Indication
With Battery Operation

Customer provide aluminum housing

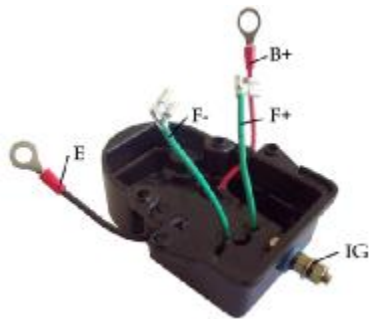

14-019

FEATUERS

Original & X-References..

A-Circuit
Voltage Set Point **27.50V**
Field Shorted Circuit Protection
Over Voltage Indication
Without Battery Operation

Customer provide aluminum housing
