

13000100 / 00-001



FEATURES

A-Circuit
Voltage Set Point **14.60 V**

For use on : Ford, J.I. Case, Massey
Ferguson Tractors & other Lucas 21TR
Application

Original & X-References..

LUCAS			
37701	37703	37705	
37707	54048473	54048600	
54205986	54206177		
MOBILETRON		VR-LC111	
USI		71-00001	
WAI		35-9209	
CARGO		131277	
TRANSPO		IL223	

13010100 / 00-002

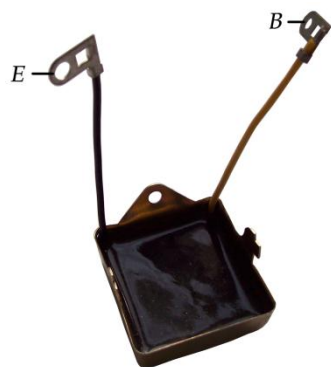

FEATURES

A-Circuit
Voltage Set Point **14.60V**

For use on : Case, Jaguar, Lotus
Massey Ferguson, MG

Original & X-References..

LUCAS			
37534	37538	37541	37555
37558	37561	37565	
MOBILETRON		VR-LC100	
WAI		35-9200	
TRANSPO		IL211	

13000200 / 00-003



FEATURES

A-Circuit
Voltage Set Point **28.50 V**

For use on : Ford Tractor JCB
Equipment Massey Ferguson

Original & X-References..

LUCAS		
37735	UCB 153	
28002	84959	
54022415	UCB155	
MOBILETRON	VR-LC111B	
WAI	35-9211	
CARGO	135231	
TRANSPO	IL225	

13020100 / 00-005

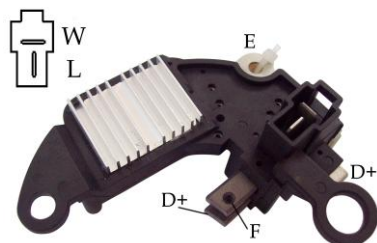

FEATUERS

A-Circuit
Voltage Set Point **14.50 V**

Original & X-References..

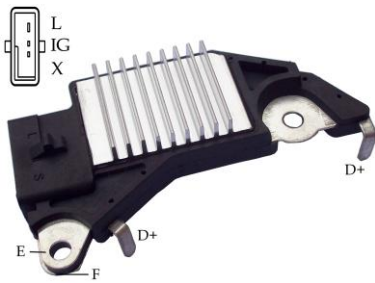

13100100 / 01-001

FEATURES

A-Circuit
Voltage Set Point **14.60 V**

For use on: Daewoo Espero GM Satum
Lemans & Prince

Original & X-References..

DELCO	276010
MOBILETRON	VR-D276
CARGO	139467
DAEWOO	276010
TRANSPO	D403



13100300 / 01-004

FEATURES

A-Circuit
Voltage Set Point **14.80 V**

13100900 / 01-015

Voltage Set Point **14.50 V**

13100200 / 01-002

Voltage Set Point **14.60 V**

With RFI Capacitor

Original & X-References..

DELCO	19009701
	10475019 10479914
	10479923 10479947
	10479955 1204270
MOBILETRON	VR-D701
USI	71-10022
WAI	35-152
CARGO	135336
TRANSPO	DE701

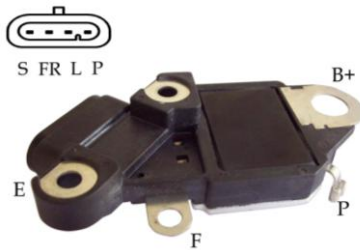

13110100 / 01-005

FEATURES

B-Circuit
Voltage Set Point **14.40 V**
Soft Start **30 %**
Field Shorted Circuit Protection
Under Voltage Indication
Over Voltage Indication
DFM Function
Self Exciting Function

For use on: Delco 24SI series

Original & X-References..

DELCO	1051-4474/4152
	860-0032/0096/0100/0151/0152
	/0164/0165/1661/0167/0168
	1902-0900/1901/0902
LESTER	8701/2/3/4/5/6/7
TRANSPO	D4152

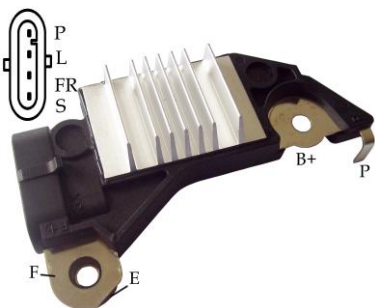

13100500 / 01-007

FEATURES

B-Circuit
Voltage Set Point **14.70 V**
Soft Start **30 %** LRC **5 sec**
Field Shorted Circuit Protection
Under / Over Voltage Indication
DFM Function

For use on: Buick Skylark, Chevrolet
Cavalier, Pontiac Grand-Am, Sunfire

Original & X-References..

DELCO	19009705
MOBILETRON	VR-D705H
UNIPOINT	YR-860
USI	71-10030
WAI	35-137
CARGO	231184
TRANSPO	D705

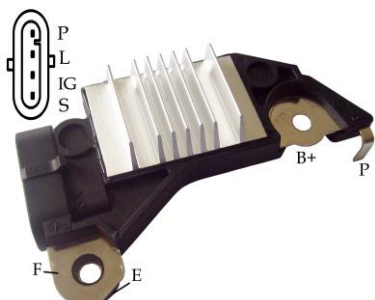

13100600 / 01-008

FEATURES

B-Circuit
Voltage Set Point **14.70 V**
Soft Start **30 %**
LRC **5 sec**
Field Shorted Circuit Protection
Under Voltage Indication
Over Voltage Indication

13101400 / 01-036

Voltage Set Point **14.15 V**

Original & X-References..

DELCO	19009702	13120469
	1116411	1116437
	1116429	1116436
USI		71-10044
CARGO		135547
TRANSPO		D702HD

13120100 / 01-010

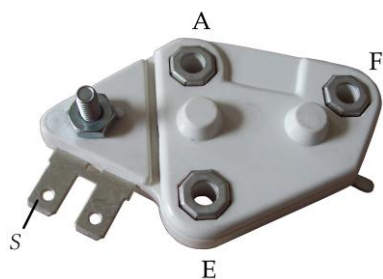

FEATURES

A-Circuit
Voltage Set Point **14.10 V**
Field Shorted Circuit Protection
O.E. Grade

Original & X-References..

DELCO		
1116360	1116390	1116407
1116433	1116435	1116442
MOBILETRON		VR-D669
USI	71-10053	
WAI	35-126	35-126-2
TRANSPO	D21/D33	

13120600 / 01-030

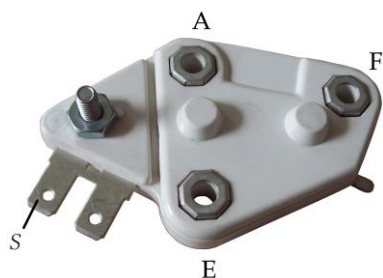

FEATURES

A-Circuit
Voltage Set Point **28.10 V**
O.E. Grade

Original & X-References..

DELCO		
1105510	1116388	1116404
1894460	1984287	1987518
USI	71-10056	
WAI	35-106	35-106-1
TRANSPO	D30	

13120200 / 01-011

A-Circuit
Voltage Set Point **28.10 V**
O.E. Grade

13100700 / 01-013

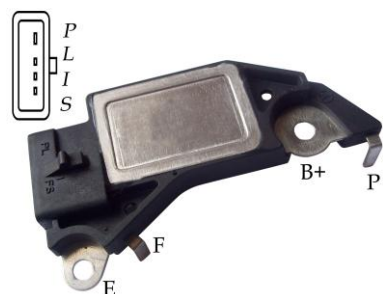

FEATURES

B-Circuit
Voltage Set Point **14.60 V**
Soft Start **30 %**
LRC **5 sec**
Field Shorted Circuit Protection
Under Voltage Indication
Over Voltage Indication

Original & X-References..

DELCO	1116411	1116429
	1116436	1116437
	D677	D685
	D698	
USI		71-10041
TRANSPO		D411HD

13100800 / 01-014

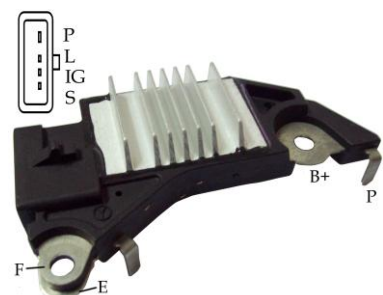

FEATURES

A-Circuit
Voltage Set Point **14.60 V**
Soft Start **30 %**
LRC **5 sec**
Field Shorted Circuit Protection
Under Voltage Indication
Over Voltage Indication

Original & X-References..

FOR DAEWOO

13110200 / 01-016

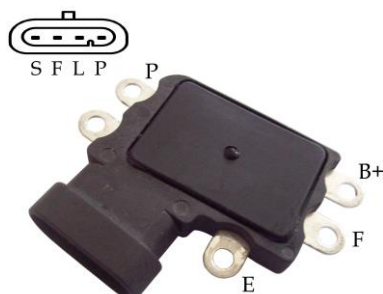

FEATURES

B-Circuit
Voltage Set Point **14.20 V**
Soft Start **30 %**
Field Shorted Circuit Protection
Under Voltage Indication
Over Voltage Indication
DFM Function
Self Exciting Function

Original & X-References..

DELCO	19020407
TRANSPO	D907

For use on: late Delco 22SI

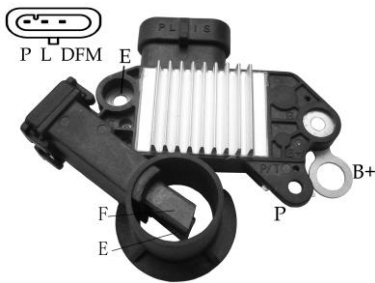

13130100 / 01-018

FEATURES

Original & X-References..

B-Circuit
 Voltage Set Point **14.50 V**
 Soft Start **30 %** LRC **5 sec**
 Field Shorted Circuit Protection
 Under Voltage Indication
 Over Voltage Indication
 DFM Function

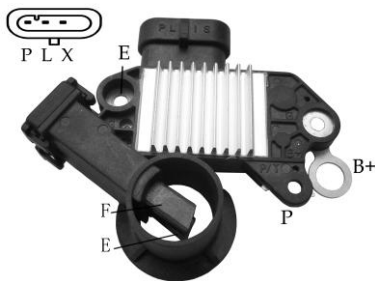

13130200 / 01-019

FEATURES

Original & X-References..

B-Circuit
 Voltage Set Point **14.70 V**
 Soft Start **30 %**
 Field Shorted Circuit Protection
 Under Voltage Indication
 Over Voltage Indication
 Self Exciting Function

For use on: 11SI Alternator

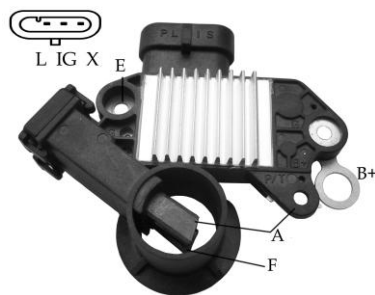

13130300 / 01-020

FEATURES

Original & X-References..

A-Circuit
 Voltage Set Point **14.70 V**

For use on: 11SI Alternator

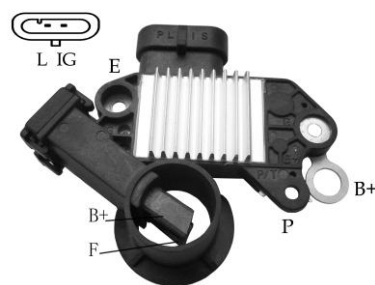

13130500 / 01-021

FEATURES

Original & X-References..

A-Circuit
 Voltage Set Point **14.50 V**
 Soft Start **30 %**
 LRC **5 sec**
 Field Shorted Circuit Protection
 Under Voltage Indication
 Over Voltage Indication

MOBILETRON		VR-D717
LESTER	8483	8484
TRANSPON		D2206

For use on: 11SI Alternator

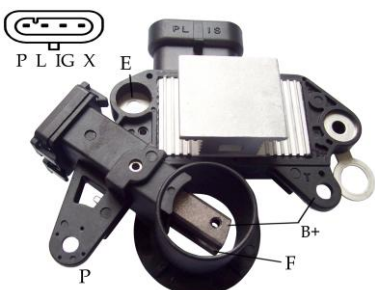

13130600 / 01-023

FEATUERS

Original & X-References..

A-Circuit
 Voltage Set Point **14.30 V**

DELCO	19020204	207	208
	220198		
LESTER	8720	8721	8722
TRANSPON		D2198	

For use on: 11SI Alternator

13130900 / 01-048

A-Circuit
 Voltage Set Point **28.30 V**

DELCO	8600210
LESTER	8688

13110300 / 01-025



FEATUERS

B-Circuit
 Voltage Set Point **14.70 V**
 Soft Start **30 %**
 LRC **5 sec**
 Field Circuit Protection
 Under Voltage Indication
 Over Voltage Indication
 DFM function

Original & X-References..

DELCO	10458200	10458201
MOBILETRON	VR-D232	
WAI	35-162	
TRANSPO	D200	

13120400 / 01-026

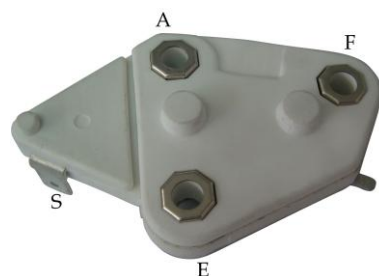

FEATUERS

A-Circuit
 Voltage Set Point **14.60 V**

Original & X-References..

DELCO	13472557	3472557	3493050
MOBILETRON	VR-D673C		
TRANSPO	DE606		

13121500 / 01-027

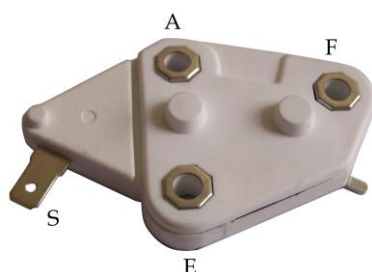

FEATUERS

A-Circuit
 Voltage Set Point **14.60 V**

Original & X-References..

DELCO	94648534	D673
MOBILETRON	VR-D690	
WAI	35-153	
IK589		
TRANSPO	DE608	

13101100 / 01-031



FEATUERS

B-Circuit
 Voltage Set Point **14.70 V**
 Soft Start **32 %**
 LRC **5 sec**
 Field, Shorted Circuit Protection
 Under Voltage Indication
 Over Voltage Indication

Original & X-References..

DELCO	19009708
CARGO	231796
USI	71-10050
TRANSPO	DE708

13120700 / 01-032

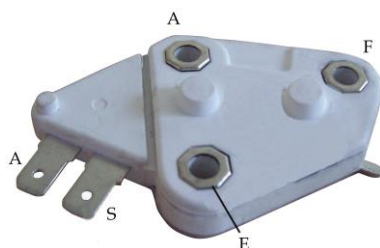

FEATUERS

A-Circuit
 Voltage Set Point **14.60 V**

Original & X-References..

DELCO	1116380	1116384	
	1116387	1116385	1116392
USI	71-10001		
WAI	35-101		
MOBILETRON	VR-D668		
TRANSPO	D101		

13101200 / 01-033

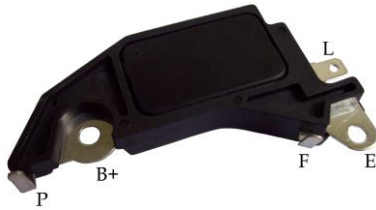

FEATUERS

B-Circuit
 Voltage Set Point **14.50 V**
 Soft Start **32 %**
 Field, Shorted Circuit Protection
 Under Voltage Indication
 Over Voltage Indication

Original & X-References..

DELCO	1116432
USI	71-10025
MOBILERTRON	VR-D432
TRANSPO	D432

13110400 / 01-034

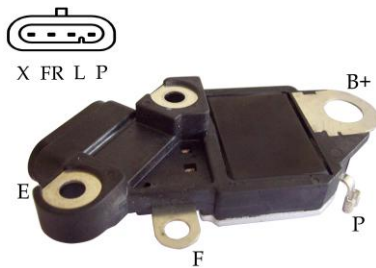

FEATURES

B-Circuit
 Voltage Set Point **28.30 V**
 Soft Start **32 %**
 Field Shorted Circuit Protection
 Under Voltage Indication
 Over Voltage Indication
 DFM Function
 Self Exciting Function

Original & X-References..

DELCO	10521828	10514476
TRANSPO	D4476	

For use on: Delco 24SI series

13110500 / 01-037

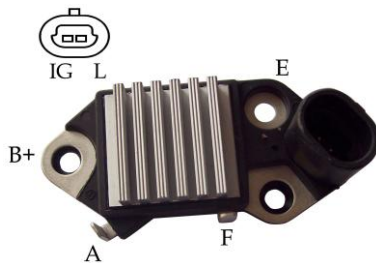

FEATUERS

A-Circuit
 Voltage Set Point **14.55 V**

Original & X-References..

FOR DAEWOO	271910
MOBILETRON	VR-D271
CARGO:	139468

13130700 / 01-038

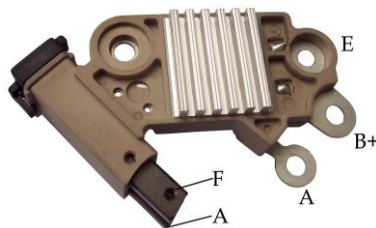

FEATUERS

A-Circuit
 Voltage Set Point **28.45V**

Original & X-References..

FOR DAEWOO	2502-600C
------------	-----------

13110600 / 01-039



FEATUERS

B-Circuit
 Voltage Set Point **14.20 V**
 Soft Start **30 %**
 LRC **5 sec**
 Field Circuit Protection
 Under Voltage Indication
 Over Voltage Indication
 DFM function

Original & X-References..

DELCO	15163024	15163025
WAI	D202XHD	
TRANSPO	D202	

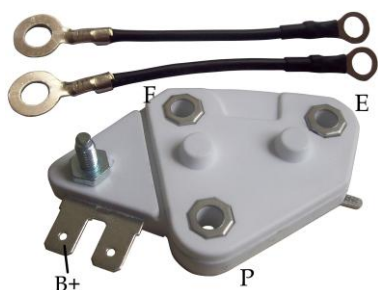

13120800 / 01-046

FEATUERS

B-Circuit
Voltage Set Point **14.60 V**
Self Exciting Function

Original & X-References..

DELCO	10SI	12SI	15SI	17SI
TRANSPO		D713/D10AC		

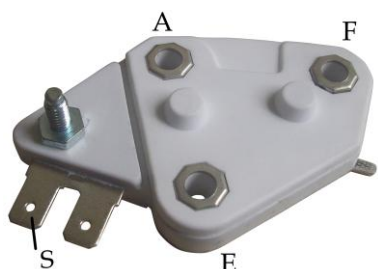

13120900 / 01-047

FEATUERS

A-Circuit
Voltage Set Point **14.00 V**

Original & X-References..

DELCO	1116389	1116406	1116407
	1894489	D669	D672
WAI		35-105	
CARGO		134750	
TRANSPO		D102HD	

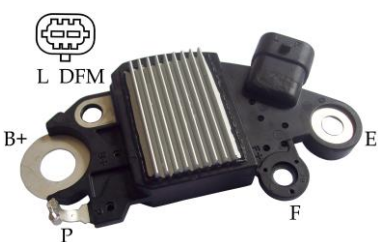

13140100 / 01-049

FEATUERS

B-Circuit
RVC=0 Vset=**13.80V**
RC=**70%** Vset=**14.45V**
Soft Start **18.75 %**
LRC **2.5 sec**
DFM function

Original & X-References..

DELCO	0392759	1509392
15093929	15200268	15263858
15857608	15905871	15905872
25869451		
LESTER	8301	8302
TRANSPO		D3587

RVC Regulator



13140200 / 01-050

FEATURES

B-Circuit
Voltage Set Point **14.50 V**
Soft Start **20 %**
LRC **5 sec**
Field, Lamp Shorted Circuit Protection
Under Voltage Indication
Over Voltage Indication
DFM function

Original & X-References..



13140300 / 01-051

FEATURES

B-Circuit
Voltage Set Point **14.50 V**
Soft Start **20 %**
LRC **5 sec**
Field, Lamp Shorted Circuit Protection
Under Voltage Indication
Over Voltage Indication
DFM function

Original & X-References..

CARGO	331774
-------	--------



13131000 / 01-052

FEATURES

A-Circuit
Voltage Set Point **14.60 V**

Original & X-References..

DELCO	271840
TRANSPO	D840

For use on: Marine Application
REG 5SI

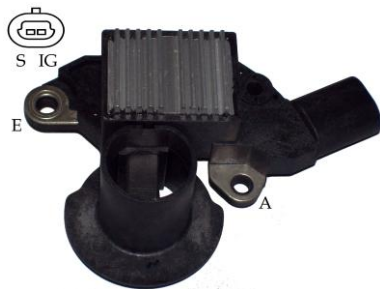

13131100 / 01-053

FEATURES

A-Circuit
Voltage Set Point **14.60 V**

Original & X-References..

DELCO	271850	
	19020704	19020707
TRANSPO		D850

For use on: Marine Application
REG 5SI

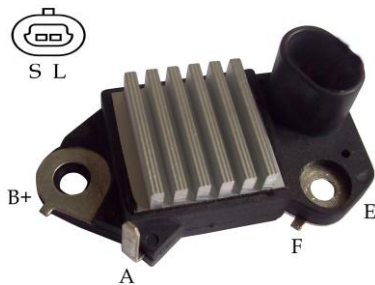

13110700 / 01-054

FEATURES

A-Circuit
Voltage Set Point **14.60 V**

Original & X-References..

DELCO	271940	
LESTER	8460	8461
	8465	8466
TRANSPO		D940

13160100 / 01-055

FEATURES

B-Circuit
Voltage Set Point **14.80 V**
Soft Start **18.75 %**
LRC **10 Sec**
Field, Lamp Shorted Circuit Protection
Under Voltage Indication
Over Voltage Indication
DFM Function

Original & X-References..

ALTERNATOR REFERENCES
MERCEDES 001500850
DELPHI 10480403
CARGO 235542
LESTER 23162
TRANSPO DE1750

For use on: Audi ater cooling Alternator

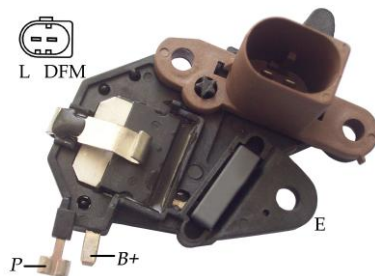

13110800 / 01-057

FEATUERS

B-Circuit
Voltage Set Point **14.80 V**
Soft Start **30 %**
LRC **5 sec**
Field Shorted Circuit Protection
Under Voltage Indication
Over Voltage Indication

Original & X-References..

DELCO	10494747
CARGO	232665
LESTER	8238
TRANSPO	D201XHD



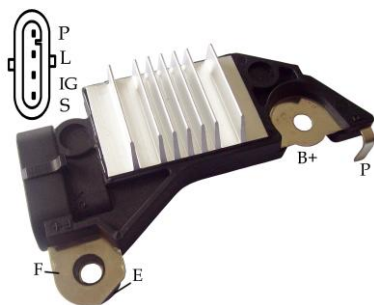

13101700 / 01-058

FEATURES

B-Circuit
 Voltage Set Point **14.80 V**
 Soft Start **30 %** LRC **10 sec**
 Field Shorted Circuit Protection
 Under / Over Voltage Indication

Original & X-References..

DELCO	19009703
LESTER	8158 8200
TRANSPO	D703

For use on: Buick Skylark, Chevrolet Cavalier, Pontiac Grand-Am, Sunfire

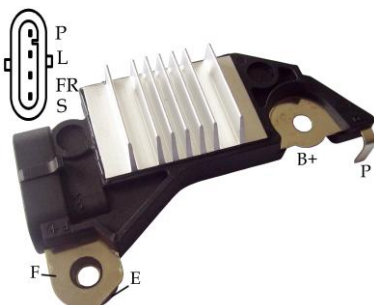

13101800 / 01-059

FEATURES

B-Circuit
 Voltage Set Point **14.60 V**
 Soft Start **30 %** LRC **5 sec**
 Field Shorted Circuit Protection
 Under / Over Voltage Indication
 DFM Function

Original & X-References..

DELCO	19009729
LESTER	8275 8276
TRANSPO	D729

For use on: Buick Skylark, Chevrolet Cavalier, Pontiac Grand-Am, Sunfire

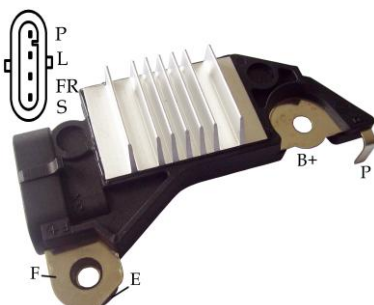

13101900 / 01-060

FEATURES

B-Circuit
 Voltage Set Point **14.80 V**
 Soft Start **30 %** LRC **5 sec**
 Field Shorted Circuit Protection
 Under / Over Voltage Indication
 DFM Function

Original & X-References..

DELCO	19009748	19009749
	19009761	
LESTER	8234 8243 8249	
	8270 8271 8272	
	8279 8283	
TRANSPO	D749XHD	

For use on: Buick Skylark, Chevrolet Cavalier, Pontiac Grand-Am, Sunfire

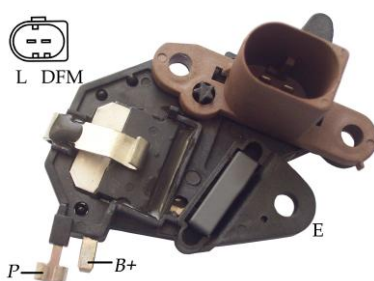

13160300 / 01-061

FEATURES

B-Circuit
 Voltage Set Point **14.80 V**
 Soft Start **18.75 %**
 LRC **10 Sec**
 Field, Lamp Shorted Circuit Protection
 Under Voltage Indication
 Over Voltage Indication
 DFM Function

Original & X-References..

DELCO	10480403	10480407
LESTER	23161	
TRANSPO		DE1650

For use on: Audi ater cooling Alternator



13131200 / 01-062

FEATURES

A -Circuit
 Voltage Set Point **14.50 V**
 Soft Start **30 %**
 LRC **5 Sec**
 Field Shorted Circuit Protection
 Under Voltage Indication
 Over Voltage Indication
 DFM Function

Original & X-References..



13150100 / 01-063

FEATURES

B-Circuit
 RVC=0 $V_{set}=13.80V$
 RC=70% $V_{set}=14.45V$
 Soft Start 18.75 %
 LRC 2.5 sec
 DFM function

Original & X-References..

DELCO 13579662

RVC Regulator

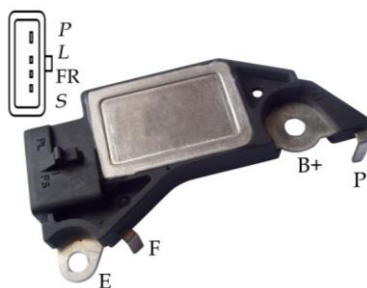

13102000 / 01-064

FEATURES

B-Circuit
 Voltage Set Point 14.80 V
 Soft Start 30 %
 LRC 5 sec
 Field Shorted Circuit Protection
 Under / Over Voltage Indication
 DFM Function

Original & X-References..

DELCO	1116413	1116430		
	1116445	19009730		
LESTER	7806	7904	7942	7966
	7969	8127	8170	8189
	8202	8213	8225	8226
	8248			
TRANSPO		D445		



13150200 / 01-065

FEATURES

B-Circuit
 RVC=0 $V_{set}=13.80V$
 RC=70% $V_{set}=14.45V$
 Soft Start 18.75 %
 LRC 2.5 sec
 DFM function

Original & X-References..

DELCO 13579666

RVC Regulator

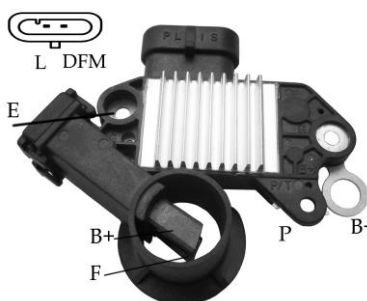

13131300 / 01-066

FEATURES

A -Circuit
 Voltage Set Point 14.70 V
 Soft Start 32 %
 LRC 5 sec
 Field Shorted Circuit Protection
 Under / Over Voltage Indication
 DFM Function

Original & X-References..

13111000 / 01-069



FEATURES

B-Circuit
 Voltage Set Point 28.50 V
 Soft Start 30 %
 Field Shorted Circuit Protection
 S、IG Open Indication
 Under Voltage Indication
 Over Voltage Indication

Original & X-References..

18SI	FAT5801315656
DELCO	10514591

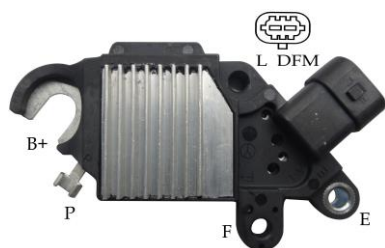

13140400 / 01-071

FEATURES

B-Circuit
 RVC=0 $V_{set}=13.80V$
 RC=70% $V_{set}=14.45V$
 Soft Start 18.75 %
 LRC 2.5 sec
 DFM function

Original & X-References..

ADE0005A-600
 SAME USE AS 01-049

RVC Regulator

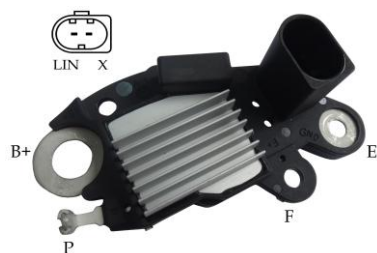

13140500

FEATURES

B-Circuit
 Voltage Set Point 14.00 V
 LRC 3 sec
 Self Exciting Function

Original & X-References..

LIN Regulator

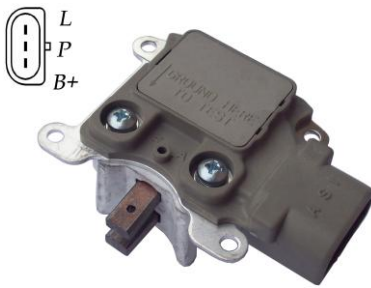

13200100 / 02-001

FEATURES

A-Circuit
Voltage Set Point **14.80 V**

For use on : Ford 3G Series IR/ER
Alternators

Original & X-References..

FORD	FIDU-10C359-AA
	FIDZ-10C359A
MOTORCRAFT	GR-821
MOBILETRON	VR-F786BH
UNIPOINT	YR-F33B
WAI	35-205
CARGO	232414
TRANSPO	F794B

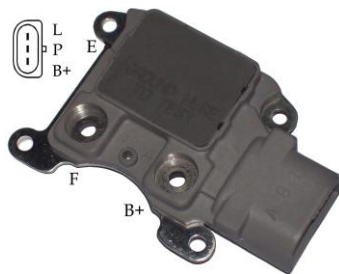

13200700 / 02-002

FEATURES

A-Circuit
Voltage Set Point **14.50 V**

For use on: Ford 3G Series IR/ER
Alternators

Original & X-References..

FORD	EIDU-10316-A
	E9DF-10316-AA
MOBILETRON	VR-F786
USI	71-20002
WAI	35-204-1 35-205
CARGO	136230 232414
TRANSPO	F794

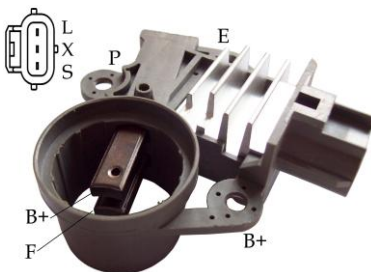

13220100 / 02-003

FEATURES

A-Circuit
Voltage Set Point **14.45 V**
Soft Start **30 %**
Field Shorted Circuit Protection
Under Voltage Indication
Over Voltage Indication
Gray with Gray Cover

For use on: Ford 6G Series IR/ER
Alternators Automobiles: FORD Crown
Victoria, Lincoln

Original & X-References..

FORD	F8WU-10C359-AB
MOBILETRON	VR-F900
USI	71-20011
WAI	35-212
CARGO	230065
TRANSPO	F600

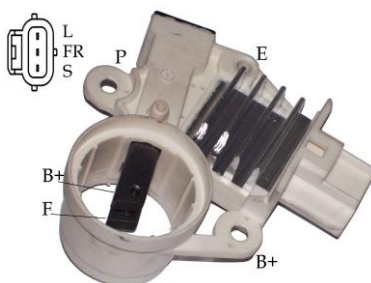

13220200 / 02-004

FEATURES

A-Circuit
Voltage Set Point **14.45 V**
Soft Start **30 %** LRC **5 sec**
Field Shorted Circuit Protection
Under Voltage Indication
Over Voltage Indication
White with Orange Cover

For use on: Ford 6G Series IR/ER
Alternators

Original & X-References..

FORD	XS7U-10C359-AC
	XS7U-10C359-BA
MOBILETRON	VR-F930
USI	71-20015
WAI	35-214
CARGO	233775
TRANSPO	F603

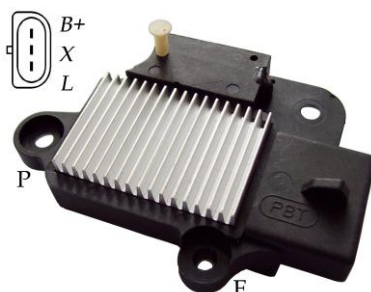

13210100 / 02-005

FEATURES

A-Circuit
Voltage Set Point **14.45 V**
Soft Start **30 %**
LRC **5 sec**
Field Shorted Circuit Protection
Under Voltage Indication
Over Voltage Indication

For use on: Ford 4G Series IR/ER
Alternators

Original & X-References..

FORD	F50U-10316-A
MOBILETRON	VR-F815
USI	71-20004
WAI	35-208
CARGO	138663
TRANSPO	F796

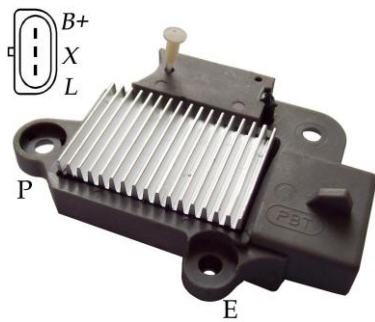

13210200 / 02-006

FEATURES

A-Circuit
Voltage Set Point **14.45 V**
Field Shorted Circuit Protection
Over Voltage Indication

For use on : Ford 4G Series IR/ER
Alternators

Original & X-References..

FORD	F6DU-10C359-AA
	F6DY-10316-A
	F6DY-10316-A
MOTORCRAFT	GR-817
MOBILETRON	VR-F817
USI	71-20007
WAI	35-210
CARGO	230066
TRANSP0	F798

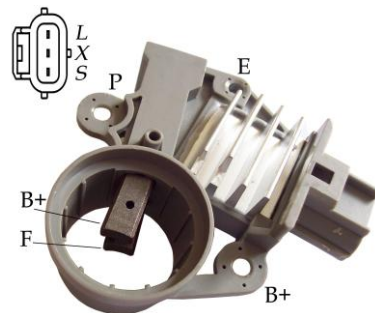

13220400 / 02-007

FEATURES

A-Circuit
Voltage Set Point **14.45 V**
Soft Start **30 %**
LRC **5 sec**
Field Shorted Circuit Protection
Under Voltage Indication
Over Voltage Indication
Gray with Green Cover

Original & X-References..

FORD	VP3C3U10C359AA
MOBILETRON	VR-F901
TRANSP0	F605

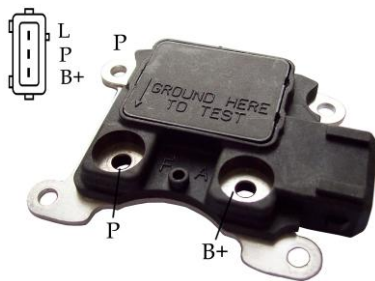

13200200 / 02-008

FEATURES

A-Circuit
Voltage Set Point **14.45 V**
Field Shorted Circuit Protection
Over Voltage Indication

For use on: Ford 3G Series IR/ER
Alternators

Original & X-References..

FORD	F3A-10316-A
	F3A-10346-A
	F3RU-10316-AA
MOTORCRAFT	GR-811
MOBILETRON	VR-F811
USI	71-20005
WAI	35-206
CARGO	135854
TRANSP0	F785

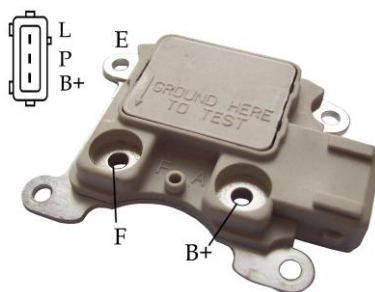

13200300 / 02-009

FEATURES

A-Circuit
Voltage Set Point **14.45V**
Soft Start **30 %**
LRC **5 sec**
Field Shorted Circuit Protection
Under Voltage Indication
Over Voltage Indication

Original & X-References..

FORD	F5RZ-10316-A
	F5RU-10316-BA
MOTORCRAFT	GR-818
MOBILETRON	VR-F818
USI	71-20006
WAI	35-209
CARGO	138185
TRANSP0	F786

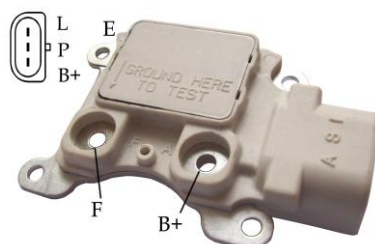

13210400 / 02-010

FEATURES

A-Circuit
Voltage Set Point **14.45 V**
Soft Start **30 %** LRC **5 sec**
Field Shorted Circuit Protection
Under Voltage Indication
Over Voltage Indication
"ISA" Terminals
For use on: Ford 3G Series IR/ER
Alternators

Original & X-References..

FORD	F4ZZ-10316-A
MOTORCRAFT	GR-814
MOBILETRON	VR-F814
USI	71-20008
WAI	35-207-4
CARGO	232415
TRANSP0	F795

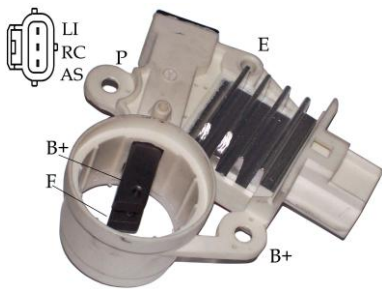

13220600 / 02-011

FEATUERS

A-Circuit
 RC=0 $V_s=13.50V$
 RC=55% $V_s=14.25V$
 White with Blue Cover

PCM Regulator

Original & X-References..

FORD	XW4U-10C359-AB
WAI	35-2135
CARGO	233232
MOBILETRON	VR-910
LESTER	7788 8253
	8255 8256
TRANSP0	F601

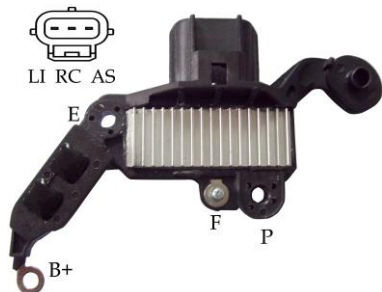

13230100 / 02-012

FEATUERS

A-Circuit
 RC=0 $V_s=13.50V$
 RC=55% $V_s=14.25V$

PCM Regulator

Original & X-References..

LESTER	8440 8527 8528
	8531 8532 8533
MOBILETRON	VR-VN001
CARGO	235601
TRANSP0	F611

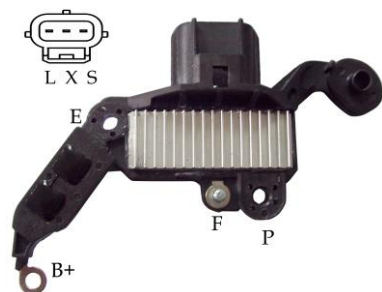

13230200 / 02-013

FEATUERS

A-Circuit
 Voltage Set Point 14.30 V
 Soft Start 30 %
 Field, Lamp Shorted Circuit Protection
 Under Voltage Indication
 Over Voltage Indication

Original & X-References..

TRANSP0	F610
MOBILETRON	VR-VN002

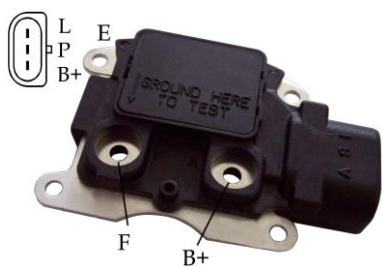

13200500 / 02-014

FEATUERS

A-Circuit
 Voltage Set Point 14.50 V

Original & X-References..

FORD	E43F-10316AA
	E73F-10316-AB
MOBILETRON	VR-F784HD
TRANSP0	F784HD

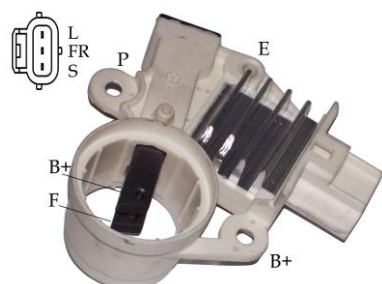

13220800 / 02-016

FEATUERS

A-Circuit
 Voltage Set Point 14.30 V
 Soft Start 30 % LRC 5 sec
 Field, Lamp Shorted Circuit Protection
 Sense Loss Indication
 Under / Over Voltage Indication
 DFM function
 White with White Cover

Original & X-References..

FORD	XR2U-10C359-AB
	XS7U-10C359-AC
MOBILETRON	F920
WAI	35-216
TRANSP0	F602

13220900 / 02-017

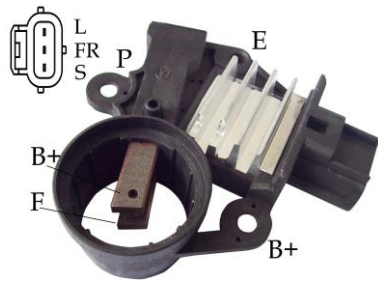

FEATUERS

A-Circuit
 Voltage Set Point **14.40 V**
 Soft Start **30 %** LRC **5 sec**
 Field, Lamp Shorted Circuit Protection
 Sense Loss Indication
 Under Voltage Indication
 Over Voltage Indication
 DFM function
 Black with Black Cover

Original & X-References..

FORD	UP4LIU-10C359-AA
MOBILETRON	VR-F931
TRANSPO	F606

13210300 / 02-018

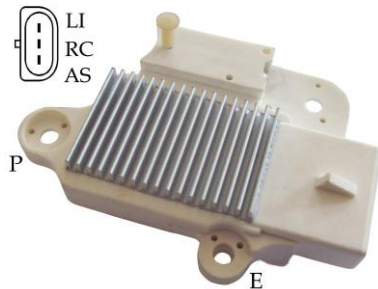

FEATUERS

A-Circuit
 RC=0 $V_s=13.50V$
 RC=55% $V_s=14.25V$

 PCM Regulator

 For use on: Ford 4G Series IR/ER
 Alternators

Original & X-References..

FORD	YF1U-10C359-AA		
	VP3F1U-10C359-AA		
	VP6L8U-10C359-AA		
LESTER	8269	8313	8314
	8403	8404	8405
	8404	8405	8442
MOBILETRON	VR-F822		
TRANSPO	F797		

13320100 / 03-001

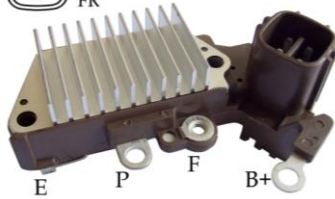

FEATURES

A-Circuit
Voltage Set Point **14.50 V**
DFM Function
63.5mm Mounting

Original & X-References..

NIPPONDENSO	126000-2090
	126000-2620
MOBILETRON	VR-H2005-40
WAI	35-8241
CARGO	234557
TRANSP0	IN445

13320200 / 03-004

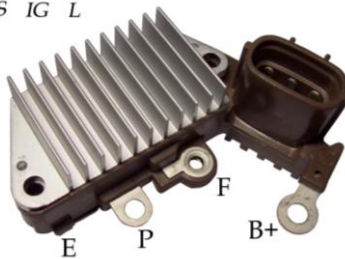

FEATUERS

A-Circuit
Voltage Set Point **14.20 V**
Soft Start **30 %**
Field Shorted Circuit Protection
Sense Open Indication
Under Voltage Indication
Over Voltage Indication
57.5mm Mounting

Original & X-References..

NIPPONDENSO	126000-3790
MOBILETRON	VR-H2005-50A
TRANSP0	IN259

13320300 / 03-005

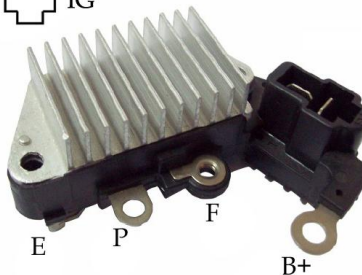

FEATURES

A-Circuit
Voltage Set Point **14.50 V**
Field Shorted Circuit Protection
Over Voltage Indication
57.5mm Mounting

Original & X-References..

NIPPONDENSO	126000-0760
	126000-1160
	126000-0600
TOYOTA	27700-78301
MOBILETRON	VR-H2005-39
USI	71-30001
WAI	35-8221-1
CARGO	133872
TRANSP0	IN254

13323400 / 03-047

Heavy Duty Version

13320400 / 03-007

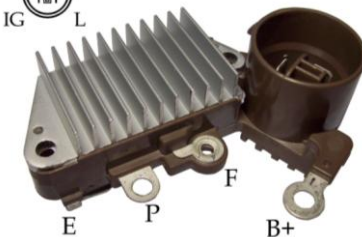

FEATURES

A-Circuit
Voltage Set Point **14.50 V**
Soft Start **30 %** LRC **5 sec**
Field Shorted Circuit Protection
IG / Sense Open Indication
Active lamp function - with output
Under / Over Voltage Indication
57.5mm Mounting

Original & X-References..

NIPPONDENSO	
	126000-0550
	126000-1550
	126000-0980
	126000-1570
MOBILETRON	VR-H2005-23A
USI	71-30025
WAI	35-8217
CARGO	132855
TRANSP0	IN250

13323800 / 03-054

13320500 / 03-008

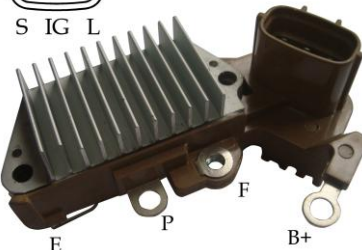

FEATURES

A-Circuit
Voltage Set Point **14.50 V**
Soft Start **30 %** LRC **5 sec**
Field Shorted Circuit Protection
IG / Sense Open Indication
Under / Over Voltage Indication
63.5mm Mounting

Original & X-References..

NIPPONDENSO	
	1260001960
	1260002200
	1260002050
	1260002250
MOBILETRON	VR-H2005-46A
MF	VR02150
CARGO	139584
WAI	35-8240
TRANSP0	IN453

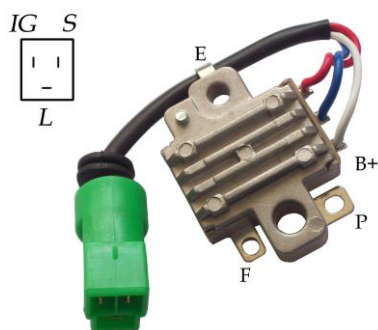

13350100 / 03-009

FEATURES

A-Circuit
Voltage Set Point **14.30 V**

For use on: Toyota Industrial

Original & X-References..

NIPPONDENSO	126000-0920
126000-1421	126000-1460
CARGO	133526 231197
MOBILETRON	VR-H2005-2
MF	VR01770
WAI	35-8245
TRANSPO	IN920



13351000 / 03-0091

FEATURES

A-Circuit
Voltage Set Point **14.30 V**
Soft Start **30 %**
Field Shorted Circuit Protection
Sense Open Indication
Active lamp function - with output
Under/ Over Voltage Indication

Original & X-References..

NIPPONDENSO	126000-0920
126000-1421	
MF	VR01770
TOYOTA	27000-64040
MOBILETRONON	VR-H2005-2
CARGO	133526 231197
TRANSPO	IN920

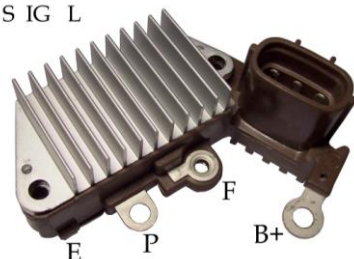

13320700 / 03-011

FEATURES

A-Circuit
Voltage Set Point **14.50 V**
Soft Start **30 %** LRC **5 sec**
Field Shorted Circuit Protection
IG / Sense Loss Indication
Under / Over Voltage Indication
57.5mm Mounting

Original & X-References..

NIPPONDENSO	126000-1630
MOBILETRON	VR-H2005-32A
USI	71-30014
WAI	35-8242
CARGO	138662
TRANSPO	IN257

13323900 / 03-055

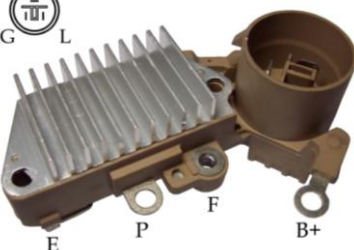

13320800 / 03-012

FEATURES

A-Circuit
Voltage Set Point **14.50 V**
Soft Start **30 %** LRC **5 sec**
Field Shorted Circuit Protection
IG Open Indication
Under / Over Voltage Indication
63.5mm Mounting

Original & X-References..

NIPPONDENSO	1260001200
ISUZU	8970320910
MOBILETRON	VR-H2005-16A
USI	71-30010
GARGO	134447
TRANSPO	IN435

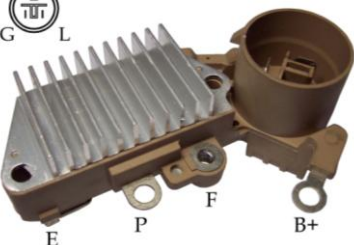

13320900 / 03-013

FEATURES

A-Circuit
Voltage Set Point **14.40 V**
Soft Start **30 %** LRC **5 sec**
Field Shorted Circuit Protection
IG / Sense Open Indication
Active lamp function - with output
Under / Over Voltage Indication
63.5mm Mounting

Original & X-References..

NIPPONDENSO	126000-0340	126000-0400
	126000-0510	126000-0650
	126000-0700	126000-0731
MOBILETRON	VR-H2005-4A	
USI	71-30003	
WAI	35-8204	
CARGO	131459	
TRANSPO	IN220	

13324000 / 03-056

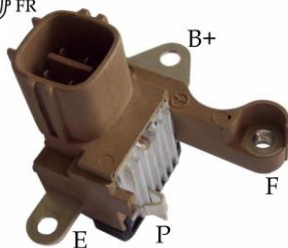

13300100 / 03-014

FEATURES

B-Circuit
 Voltage Set Point **14.70 V**
 Soft Start **32 %**
 Field, Lamp Shorted Circuit Protection
 Under Voltage Indication
 Over Voltage Indication
 DFM Function

Original & X-References..

NIPPONDENSO	126600-0040
	126600-0042
	104210-309
HONDA	31100-PGK-A01
	CSC09
LESTER	13918 290-5084
MOBILETRON	VR-2005-99
TRANSPO	IN6004

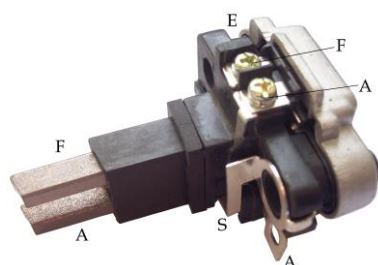

13340300 / 03-015

FEATURES

A-Circuit
 Voltage Set Point **28.50 V**

Original & X-References..

NIPPONDENSO	126000-0200	-0260	-0790
MOBILETRON	VR-2005-12		
TRANSPO	IN217(With brush holder)		
CARGO	131527		

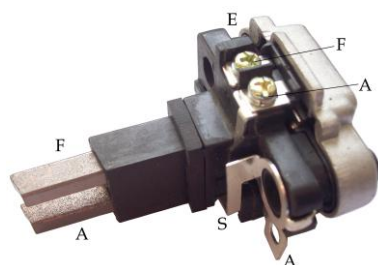

13340400 / 03-029

FEATURES

A-Circuit
 Voltage Set Point **14.50V**

Original & X-References..

NIPPONDENSO	126000-0180	-0520	-0770	-0820
MOBILETRON	VR-2005-11			
TRANSPO	IN218(With brush holder)			

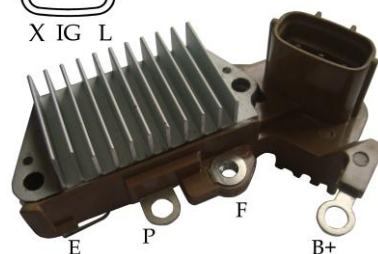

13321000 / 03-016

FEATURES

A-Circuit
 Voltage Set Point **14.50 V**
 Soft Start **30 %** LRC **5 sec**
 Field, Shorted Circuit Protection
 Under Voltage Indication
 Over Voltage Indication
 63.5mm Mounting

Original & X-References..

NIPPONDENSO	126000-1970
	126000-1971
MOBILETRON	VR-H2005-48A
CARGO	139268
TRANSPO	IN452

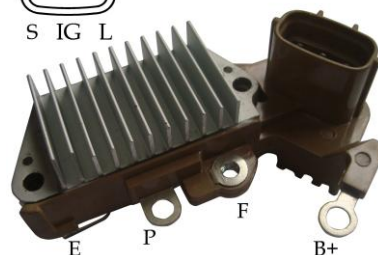

13321100 / 03-017

FEATURES

A-Circuit
 Voltage Set Point **14.60V**
 Soft Start **30 %** LRC **5 sec**
 Field Shorted Circuit Protection
 Sense Open Indication
 Under Voltage Indication
 Over Voltage Indication
 63.5mm Mounting

Original & X-References..

NIPPONDENSO	126000-1580	126000-1640
	126000-1670	126000-1660
MOBILETRON	VR-H2005-31A	
USI	71-30017	
WAI	35-8238-1	
CARGO	135734	
TRANSPO	IN439	

13321200 / 03-018

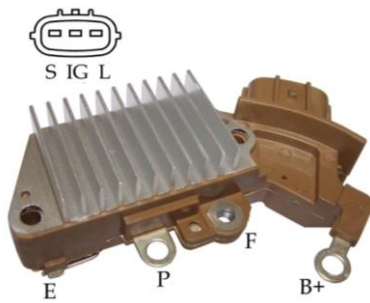

FEATURES

A-Circuit
 Voltage Set Point **14.60 V**
 Soft Start **30 %** LRC **5 sec**
 Field Shorted Circuit Protection
 Sense Open Indication
 Under / Over Voltage Indication
 63.5mm Mounting
 For use on: Toyota Camry, Lexus, Mazda, Millenia 2.5L

Original & X-References..

NIPPONDENSO	126000-1870
	126000-2260
	126000-1810
	126000-1850
	126000-2000
MOBILETRON	VR-H2005-63A
WAI	35-8234-1
CARGO	138894
TRANSPO	IN441

13321300 / 03-019

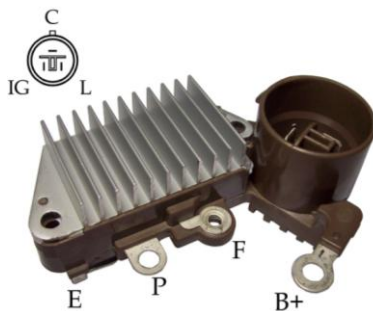

FEATURES

A-Circuit
 Voltage Set Point **14.50 V**
 L Terminal Drives Choke
 57.5mm Mounting

Original & X-References..

NIPPONDENSO	126000-0840
MOBILETRON	VR-H2005-25
LESTER	14937
WAI	35-8218
CARGO	138664
TRANSPO	IN252

13321500 / 03-021

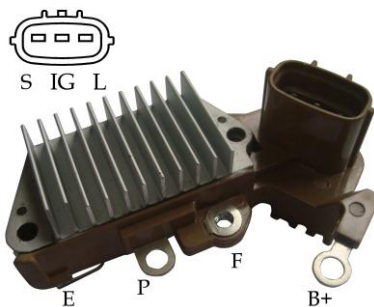

FEATURES

A-Circuit
 Voltage Set Point **14.50 V**
 Soft Start **30 %** LRC **5 sec**
 Field Shorted Circuit Protection
 IG / Sense Open Indication
 Under / Over Voltage Indication
 63.5mm Mounting

Original & X-References..

NIPPONDENSO	1260001730
	1260001750
	1260001930
TOYOTA	2770011070
	2770066040
MOBILETRONON	VR-H2005-30A
WAI	35-8235
CARGO	135737
TRANSPO	IN437

13350300 / 03-023

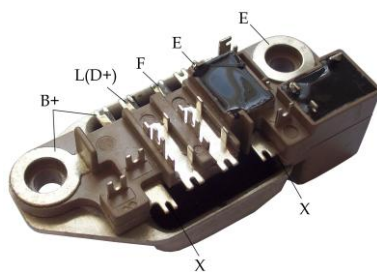

FEATURES

A-Circuit
 Voltage Set Point **28.70 V**

Original & X-References..

TOYOTA	27000-1700
HINO	277000-1700
SHWAFUJI	1219-008-00XOSF
MOBILETRONON	VR-H2002-1
CARGO	136168
TRANSPO	IW700

13350800 / 03-061

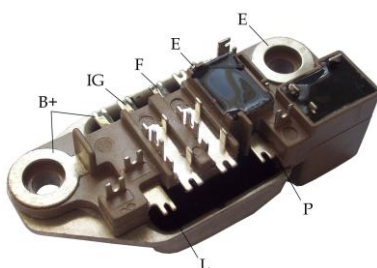

FEATURES

A-Circuit
 Voltage Set Point **28.60 V**
 Lamp Shorted Circuit Protection
 L Terminal Does Not Drive Choke

Original & X-References..

0201-102-3010/3011
H07DW06E

13350400 / 03-024

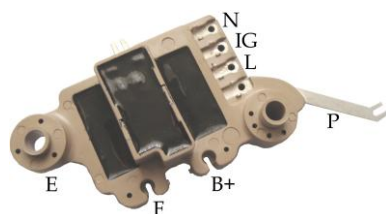

FEATURES

A-Circuit
Voltage Set Point **28.80 V**

Original & X-References..

HONO	27700-1810
NISSAN	23500-99109
CARGO	233493
MOBILETRON	VR-2005-102B

13321600 / 03-025

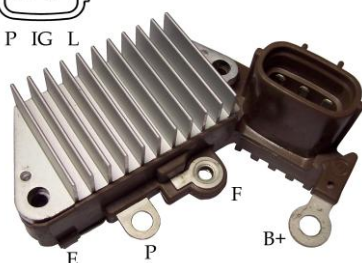

FEATURES

A-Circuit
Voltage Set Point **14.50 V**
57.5mm Mounting

Original & X-References..

NIPPONDENSO	126000-1800
MOBILETRON	VR-2005-60
USI	71-30015
WAI	35-8246
CARGO	138146
TRANSPO	IN450

13321800 / 03-027

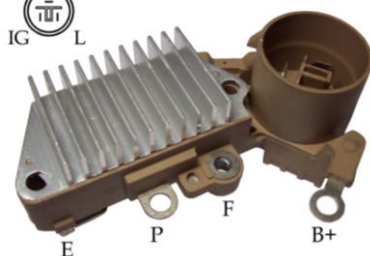

FEATURES

A-Circuit
Voltage Set Point **14.50 V**
Soft Start **30 %** LRC **5 sec**
Field Shorted Circuit Protection
IG / Sense Open Indication
Under / Over Voltage Indication
63.5mm Mounting

Original & X-References..

NIPPONDENSO	126000-0610	126000-1110
	126000-1440	126000-1441
MOBILETRON	VR-H2005-33	^a
CARGO	135730	
TRANSPO	IN434	

13321900 / 03-028

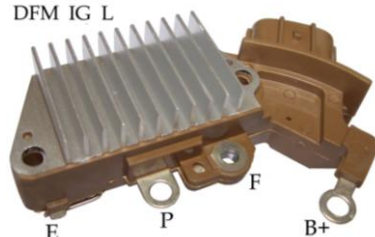

FEATURES

A-Circuit
Voltage Set Point **14.50V**
Soft Start **30 %** LRC **5 sec**
Field Shorted Circuit Protection
Under/ Over Voltage Indication
DFM Function
63.5mm Mounting

Original & X-References..

NIPPONDENSO	126000-3130
	126000-3131
	126000-3171
MOBILETRON	VR-H2005-66
CARGO	234091
TRANSPO	IN447

13322000 / 03-030

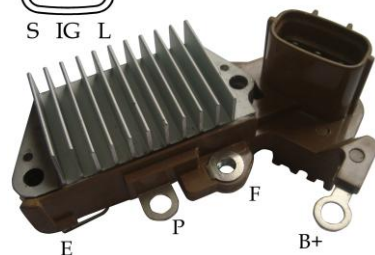

FEATURES

A-Circuit
Voltage Set Point **28.20V**
63.5mm Mounting

Original & X-References..

NIPPONDENSO	126000-7120
	27700-58040
MOBILETRON	VR-H2005-65
USI	71-30019
CARGO	138297
TRANSPO	IN460

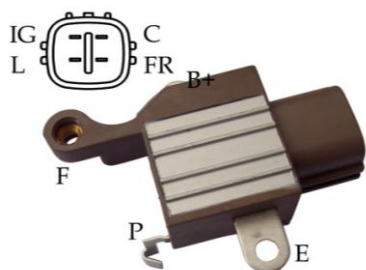

13300200 / 03-031

FEATURES

B-Circuit
 Voltage Set Point **14.60 V**
 Soft Start **32 %**
 Field, Lamp Shorted Circuit Protection
 Under Voltage Indication
 Over Voltage Indication
 DFM Function

Original & X-References..

NIPPONDENSO	126600-3350
	104210-329
MOBILETRONON	VR-H2005-90
HONDA	A04 CSC29
	31100-RAA-A01
LESTER	13980 290-5096
CARGO	237650
TRANSPO	IN6335

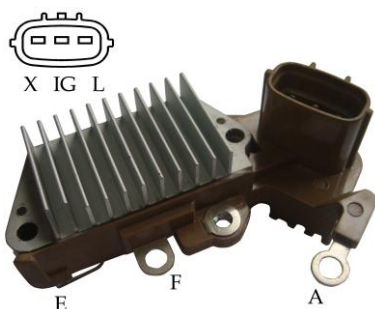

13322100 / 03-032

FEATURES

A-Circuit
 Voltage Set Point **28.50V**
 63.5mm Mounting

Original & X-References..

TRANSPO	IN462
---------	-------

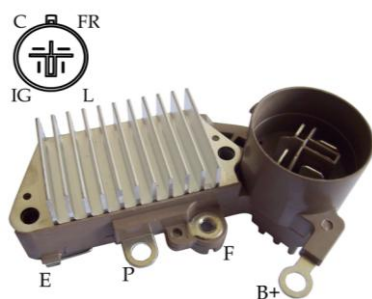

13322200 / 03-033

FEATURES

A-Circuit
 Voltage Set Point **14.60 V**
 DFM Function
 63.5mm Mounting

Original & X-References..

NIPPONDENSO	126000-1410
	126000-1860
	126000-1880
MOBILETRONON	VR-H2005-10
USI	71-30006
WAI	35-8232
CARGO	132859
TRANSPO	IN431

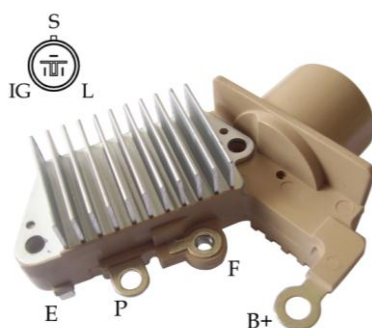

13322300 / 03-034

FEATURES

A-Circuit
 Voltage Set Point **14.50 V**
 Soft Start **30 %**
 LRC **5 sec**
 Field Shorted Circuit Protection
 Sense Open Indication
 Under / Over Voltage Indication
 57.5mm Mounting

Original & X-References..

NIPPONDENSO	126000-1770
TRANSPO	IN277

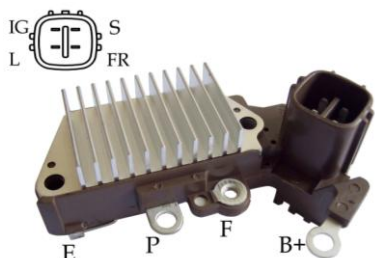

13322400 / 03-035

FEATURES

A-Circuit
 Voltage Set Point **14.50 V**
 Soft Start **30 %** LRC **5 sec**
 Field Shorted Circuit Protection
 IG / Sense Open Indication
 Active lamp function - with output
 Under/ Over Voltage Indication
 DFM Function
 63.5mm Mounting

Original & X-References..

NIPPONDENSO	126000-2450
	126000-2190
MOBILETRONON	VR-H2005-64A
WAI	35-8243
CARGO	233517
TRANSPO	IN455

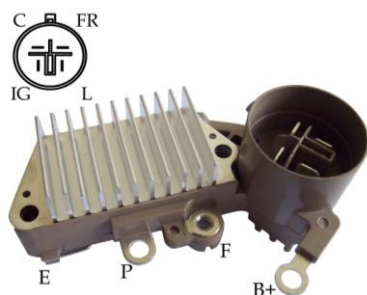

13322500 / 03-036

FEATURES

A-Circuit
Voltage Set Point **14.50 V**
DFM Function
63.5mm Mounting

Original & X-References..

NIPPONDENSO	126000-0940	126000-1700
	126000-1030	126000-1300
USI		71-30005
WAI		35-8214
CARGO		132859
MOBILETRON		VR-2005-10
TRANSPO		IN224

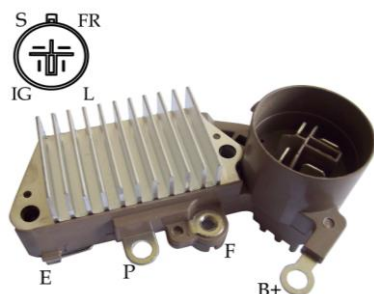

13322700 / 03-038

FEATURES

A-Circuit
Voltage Set Point **14.50 V**
Soft Start **30 %** LRC **5 sec**
Field Shorted Circuit Protection
IG / Sense Open Indication
Under / Over Voltage Indication
DFM Function
63.5mm Mounting

Original & X-References..

NIPPONDENSO	126000-0540	126000-1170
		126000-1700
MOBILETRON		VR-H2005-9A
USI		71-30004
MOBILETRON		VR-2005-9A
WAI		35-8213
TRANSPO		IN226

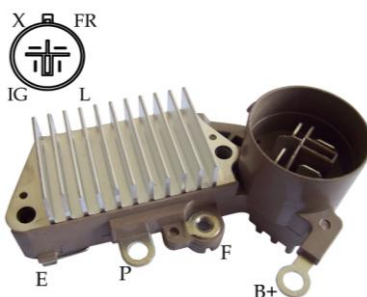

13322800 / 03-039

FEATURES

A-Circuit
Voltage Set Point **14.60 V**
Soft Start **30 %** LRC **5 sec**
Field Shorted Circuit Protection
IG Open Indication
Active lamp function - with output
Under /Over Voltage Indication
DFM Function
63.5mm Mounting

Original & X-References..

NIPPONDENSO	126000-1470 /1471
WAI	35-8231
MOBILETRON	VR-2005-19A
CARGO	232455
TRANSPO	IN429
NIPPONDENSO	126000-0570
MOBILETRON	VR-2005-8
CARGO	132831
TRANSPO	IN225

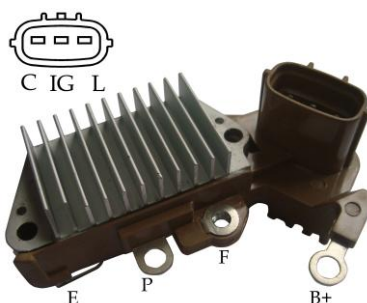

13322600 / 03-037

FEATURES

A-Circuit
Voltage Set Point **14.50 V**
63.5mm Mounting

Original & X-References..

NIPPONDENSO	126000-2150	126000-2151
MOBILETRON		VR-H2005-77
CARGO		234731
TRANSPO		IN215

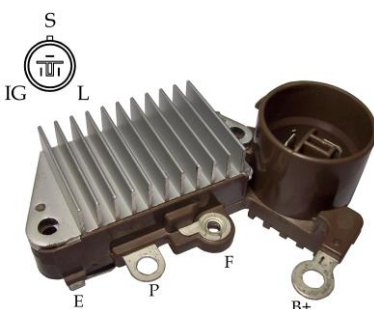

13322900 / 03-041

FEATURES

A-Circuit
Voltage Set Point **28.20 V**
57.5mm Mounting

Original & X-References..

DENSO	126000-2360	126000-7050
CARGO		235748
TRANPO		IN705

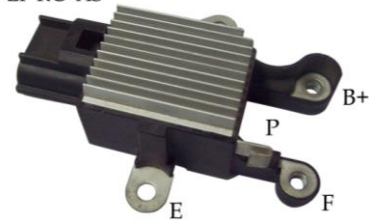

13300300 / 03-042

FEATUERS

A-Circuit
 RC=0 $V_s=13.50V$
 RC=55% $V_s=14.25V$

PCM Regulator

Original & X-References..

NIPPONDENSO	104210-3512	104210-4091
	104210-4700	104210-5300
MOBILETRON		VR-H2005-88
TRANSPO		IN6601

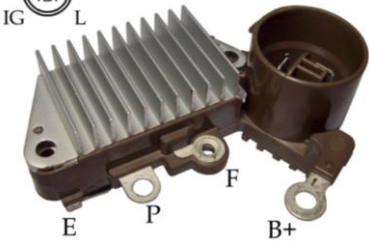

13323100 / 03-044

FEATURES

A-Circuit
 Voltage Set Point **14.50 V**
 Soft Start **30 %** LRC **5 sec**
 Field Shorted Circuit Protection
 IG Open Indication
 Under / Over Voltage Indication
 57.5mm Mounting

Original & X-References..

NIPPONDENSO	126000-0850	126000-0880
		126000-1370
MOBILETRONON		VR-H2005-24
WAI		35-8216
CARGO		132860
TRANSPO		IN251

13323000 / 03-043

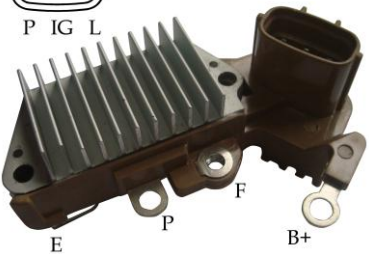
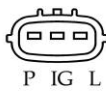

13323200 / 03-045

FEATURES

A-Circuit
 Voltage Set Point **14.60 V**
 63.5mm Mounting

Original & X-References..

NIPPONDENSO	126000-1940
MOBILETRONON	VR-H2005-59
CARGO	138638
TRANSPO	IN449

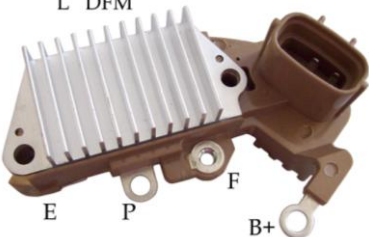

13323500 / 03-048

FEATUERS

A-Circuit
 Voltage Set Point **14.70 V**
 Soft Start **30 %**
 Field, Shorted Circuit Protection
 Under Voltage Indication
 Over Voltage Indication
 DFM function
 63.5mm Mounting

Original & X-References..

LESTER	11193
MOBILETRON	VR-H2005-92
TRANSPO	IN454

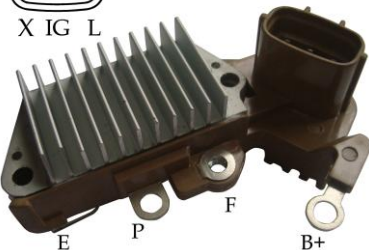

13323600 / 03-051

FEATUERS

A-Circuit
 Voltage Set Point **28.50 V**
 Soft Start **30 %**
 Field Lamp Shorted Circuit Protection
 Under Voltage Indication
 Over Voltage Indication
 63.5mm Mounting

Original & X-References..

NIPPONDENSO	126000-2310	126000-2320
CARGO	333040	
TRANSPO	IN462	IN373

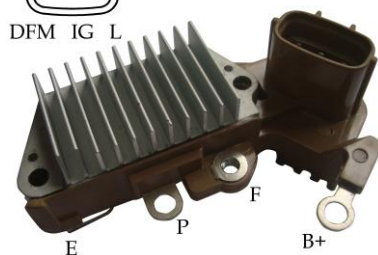

13323700 / 03-052

FEATUERS

A-Circuit
 Voltage Set Point **14.50 V**
 Soft Start **30 %** LRC **5 sec**
 Field Shorted Circuit Protection
 IG Open Indication
 Under / Over Voltage Indication
 63.5mm Mounting

Original & X-References..

NIPPONDENSO	126000-3300
MOBILETRON	VR-2005-173
TRANSPO	IN330

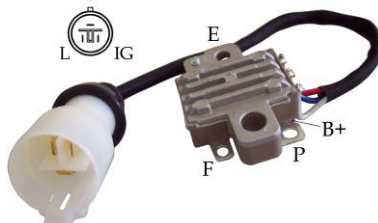

13350600 / 03-053

FEATUERS

A-Circuit
 Voltage Set Point **14.30 V**

Original & X-References..

NIPPONDENSO	126000-0920
MOBILETRON	VR-H2005-2W
CARGO	234644
TRANSPO	IN921

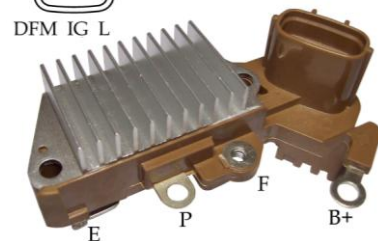

1332C200 / 03-058

FEATUERS

A-Circuit
 Voltage Set Point **14.55 V**
 Soft Start **30 %** LRC **5 sec**
 Field, Lamp Shorted Circuit Protection
 Under Voltage Indication
 Over Voltage Indication
 DFM function
 63.5mm Mounting

Original & X-References..

MOBILETRON	VR-H2005-62A
DENSO	126000-3040
TRANSPO	IN304

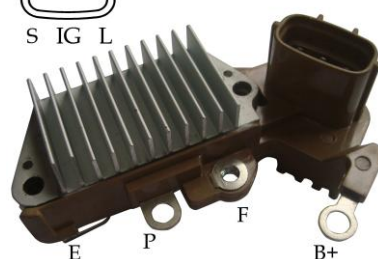

13324100 / 03-059

FEATUERS

A-Circuit
 Voltage Set Point **14.10 V**
 Soft Start **30 %** LRC **5 sec**
 Sense Loss Indication
 Under Voltage Indication
 Over Voltage Indication
 63.5mm Mounting

Original & X-References..

NIPPONDENSO	126000-7100
MOBILETRON	VR-H2005-35
WAI	35-8237
CARGO	135734
TRANSPO	IN440



13340500 / 03-060

FEATUERS

A-Circuit
 Voltage Set Point **28.50 V**

Original & X-References..

NIPPONDENSO	12600-0380
TRANSPO	IN233

13300400 / 03-062

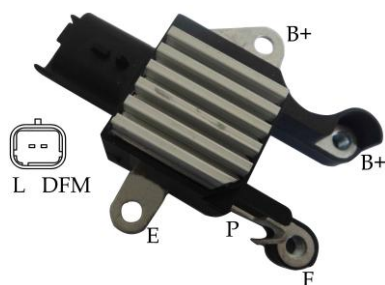

FEATUERS

A-Circuit
Voltage Set Point **14.50 V**
DFM Function

Original & X-References..

NIPPONDENSO	104210-317
MOBILETRON	VR-H2005-83
TRANSPO	IN317

13300500 / 03-064

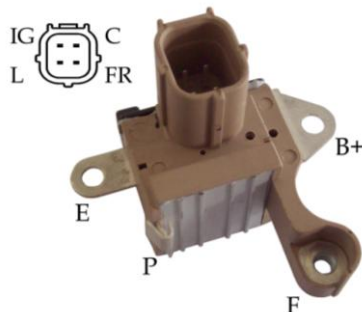

FEATUERS

B-Circuit
Voltage Set Point **14.70 V**
Soft Start **32 %**
Field Shorted Circuit Protection
Under Voltage Indication
Over Voltage Indication
DFM function

Original & X-References..

NIPPONDENSO	104210-591
	126600-3650
LESTER	11392
MOBILETRON	VR-2005-149
TRANSPO	IN6365

13300600 / 03-065

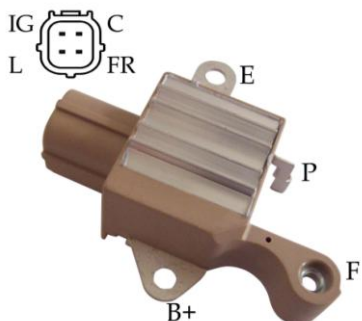

FEATUERS

B-Circuit
Voltage Set Point **14.60 V**
Soft Start **32 %**
Field Shorted Circuit Protection
Under Voltage Indication
Over Voltage Indication
DFM function

Original & X-References..

NIPPONDENSO	104210-589
	126600-3660
MOBILETRON	VR-2005-148
CARGO	237650
LESTER	11390
TRANSPO	IN6366

13324200 / 03-066

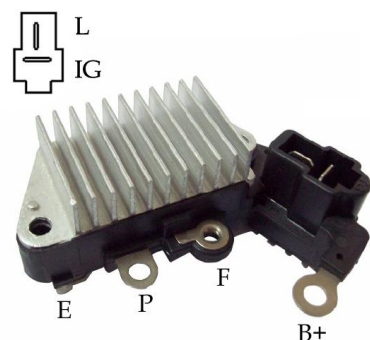

FEATURES

A-Circuit
Voltage Set Point **14.50 V**
Field Shorted Circuit Protection
Over Voltage Indication
L Terminal Drives Choke
57.5mm Mounting

Original & X-References..

NIPPONDENSO	126000-0970
	126000-0971
MOBILETRON	VR-2005-15H
WAI	35-8220
LESTER	12180 12182
CARGO	133519
TRANSPO	IN255

13324300 / 03-068

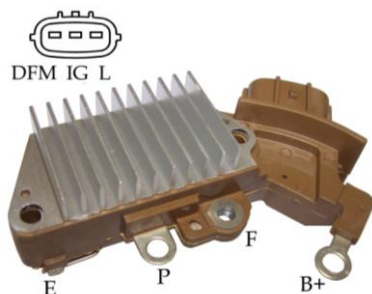

FEATUERS

A-Circuit
Voltage Set Point **14.55V**
Soft Start **30 %**
Field Shorted Circuit Protection
Under Voltage Indication
Over Voltage Indication
DFM function
63.5mm Mounting

Original & X-References..

NIPPONDENSO	126000-2871
CARGO	235449
MOBILETRON	VR-H2005-82

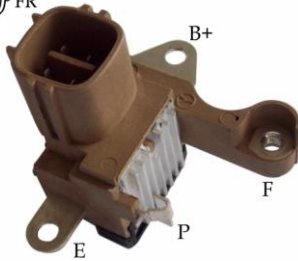

13300700 / 03-069

FEATURES

A-Circuit
 Voltage Set Point **14.20 V**
 Soft Start **30 %**
 LRC **5 sec**
 Field Shorted Circuit Protection
 Sense open indication
 Under Voltage Indication
 Over Voltage Indication
 DFM function

Original & X-References..

NIPPONDENSO	126600-0150
LESTER	11087 11090 13983 13994
MOBILETRON	VR-H2005-91
TRANSPO	IN6015

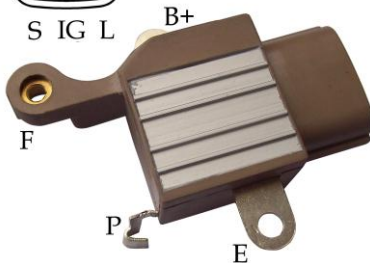

13300800 / 03-073

FEATUERS

B-Circuit
 Voltage Set Point **14.30 V**
 Soft Start **32 %**
 LRC **5 sec**
 Field Shorted Circuit Protection
 Sense open indication
 Under Voltage Indication
 Over Voltage Indication

Original & X-References..

NIPPONDENSO	126600-002
MOBILETRON	VR-H2005-93
TRANSPO	IN6002

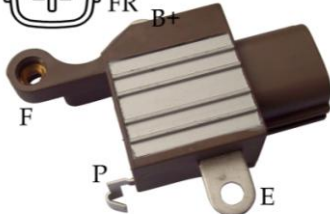

13300900 / 03-074

FEATUERS

B-Circuit
 Voltage Set Point **14.30 V**
 Soft Start **32 %**
 LRC **5 sec**
 Field, Lamp Shorted Circuit Protection
 Sense open indication
 Under Voltage Indication
 Over Voltage Indication
 DFM function

Original & X-References..

NIPPONDENSO	126600-3010 126600-3040 126600-3390
LESTER	11032 11033 11034 11084 11088 11195
MOBILETRON	VR-H2005-85
CARGO	235837
TRANSPO	IN6301

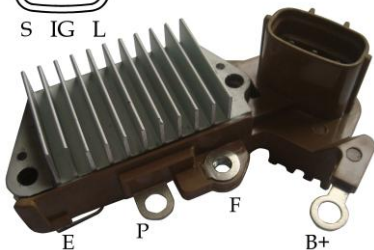

13324800 / 03-076

FEATURES

A-Circuit
 Voltage Set Point **14.50 V**
 Soft Start **30 %** LRC **5 sec**
 Field Shorted Circuit Protection
 Lamp Shorted Circuit Protection
 Under / Over Voltage Indication
 63.5mm Mounting

Original & X-References..

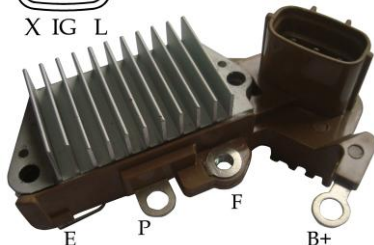

13324900 / 03-077

FEATURES

A-Circuit
 Voltage Set Point **14.50 V**
 Soft Start **30 %** LRC **5 sec**
 Field, Shorted Circuit Protection
 L Terminal Drives Choke
 Under Voltage Indication
 Over Voltage Indication
 63.5mm Mounting

Original & X-References..

NIPPONDENSO	126000-2480
LESTER	13837 13875
TRANSPO	IN248

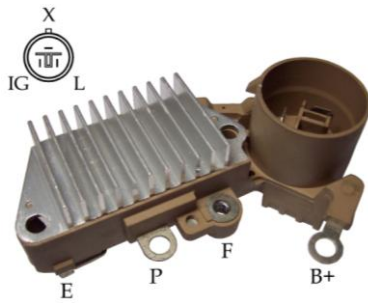

13325100 / 03-079

FEATURES

A-Circuit
 Voltage Set Point **14.60V**
 Soft Start **30 %** LRC **5 sec**
 Field Shorted Circuit Protection
 Under / Over Voltage Indication
 63.5mm Mounting

Original & X-References..

NIPPONDENSO	126000-0430
MOBILETRON	VR-H2005-5H
USI	71-30021
WAI	35-8205 35-8205-3
CARGO	134447
TRANSPO	IN221

13320600 / 03-010

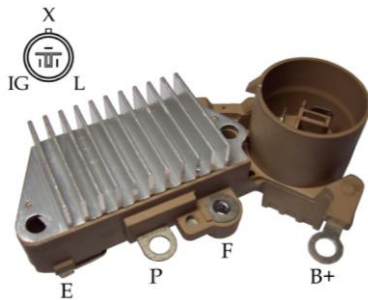

13323300 / 03-046

FEATURES

A-Circuit
 Voltage Set Point **28.20 V**

Original & X-References..

13325200 / 03-080

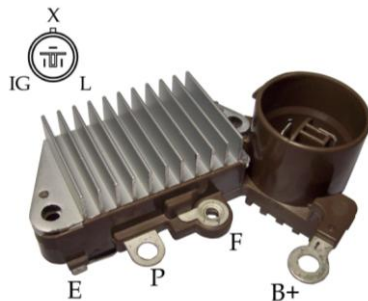

FEATURES

A-Circuit
 Voltage Set Point **14.50 V**
 Soft Start **30 %** LRC **5 sec**
 Field Shorted Circuit Protection
 Under / Over Voltage Indication
 57.5mm Mounting

Original & X-References..

NIPPONDENSO	126000-0720	126000-0721	126000-1330
WAI	35-8215-1		
LESTER	13214	13255	
	13414	14684	14871
MOBILETRON	VR-H2005-26A		
TRANSPO	IN253		

13321700 / 03-026

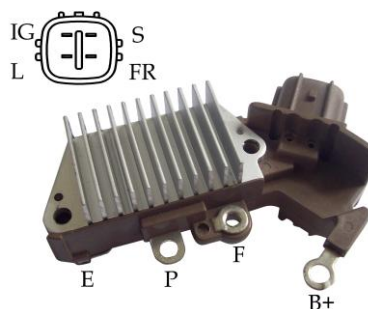

13325300 / 03-081

FEATURES

A-Circuit
 Voltage Set Point **14.50 V**
 Soft Start **30 %**
 LRC **5 sec**
 Field Shorted Circuit Protection
 Under/ Over Voltage Indication
 DFM Function
 63.5mm Mounting

Original & X-References..

NIPPONDENSO	126000-3020	102211-075
MOBILETRON	VR-H2005-179	
LESTER	23192	
CARGO	237642	
TRANSPO	IN302	

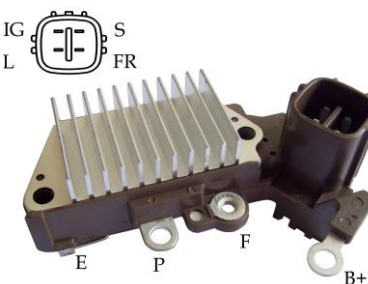

13325400 / 03-082

FEATURES

A-Circuit
 Voltage Set Point **14.50 V**
 Soft Start **30 %** LRC **5 sec**
 Field Shorted Circuit Protection
 IG / Sense Open Indication
 Active lamp function - with output
 Under/ Over Voltage Indication
 DFM Function
 63.5mm Mounting

Original & X-References..

NIPPONDENSO	126000-3690
TOYOTA	27700-50040
MOBILETRON	VR-H2005-64A
LESTER	11089 11152
TRANSPO	IN369

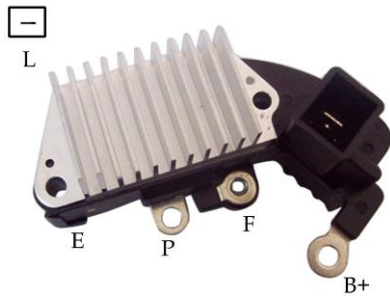

13325500 / 03-083

FEATURES

A-Circuit
 Voltage Set Point **14.40 V**
 Soft Start **30 %** LRC **5 sec**
 Field Shorted Circuit Protection
 Under/ Over Voltage Indication
 63.5mm Mounting

Original & X-References..

NIPPONDENSO	126000-1760
MOBILETRON	VR-H2005-34
LESTER	13519 13548
CARGO	136727
TRANSPO	IN443

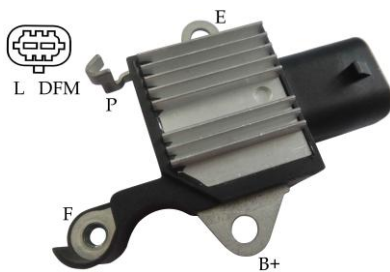

13310200 / 03-084

FEATURES

B-Circuit
 RVC=0 Vset=**13.80V**
 RC=**70%** Vset=**14.45V**
 Soft Start **18.75 %**
 LRC **2.5 sec**
 DFM function

Original & X-References..

NIPPONDENSO	126600-3240
126600-3440	126600-3060
MOBILETRON	VR-H2005-101
TRANSPO	IN6324

RVC Regulator

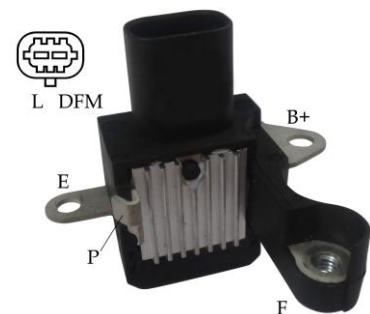

13310300 / 03-085

FEATURES

B-Circuit
 RVC=0 Vset=**13.80V**
 RC=**70%** Vset=**14.45V**
 Soft Start **18.75 %**
 LRC **2.5 sec**
 DFM function

Original & X-References..

NIPPONDENSO	126600-3290
LETSTER	11156 11183
	11237 11250
MOBILETRON	VR-H2005-163
TRANSPO	IN6329

RVC Regulator

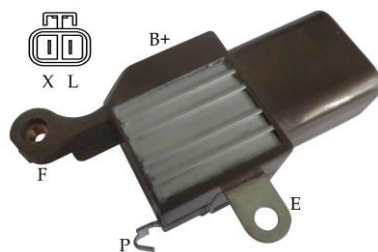

13301100 / 03-088

FEATURES

B-Circuit
 Voltage Set Point **14.50 V**
 Soft Start **30 %** LRC **5 sec**
 Field Shorted Circuit Protection
 Under Voltage Indication
 Over Voltage Indication

Original & X-References..

ISUZU	104210-9031
	8973697161
1MOBILETRON	VR-H2005-166

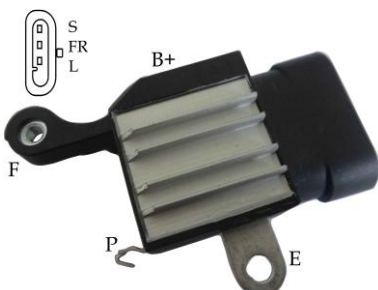

13301200 / 03-089

FEATURES

B-Circuit
 Voltage Set Point **14.80 V**
 Soft Start **32 %** LRC **5 sec**
 Field, Lamp Shorted Circuit Protection
 Sense Open Indication
 Under Voltage Indication
 Over Voltage Indication
 DFM function

Original & X-References..

NIPPONDENSO	126600-0030
	126600-0031
MOBILETRON	VR-H2005-94
LESTER	11035 13919
TRANSPO	IN6003

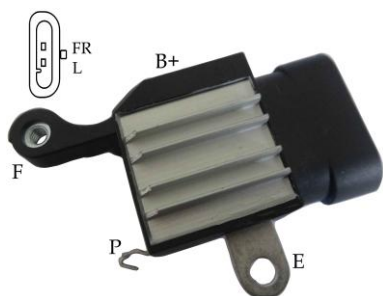

13301300 / 03-090

FEATURES

B-Circuit
 Voltage Set Point **14.80 V**
 Soft Start **32 %** LRC **5 sec**
 Field, Lamp Shorted Circuit Protection
 Under Voltage Indication
 Over Voltage Indication
 DFM function

Original & X-References..

NIPPONDENSO	126600-0090
MOBILETRON	VR-H2005-104
LESTER	11003 11036
TRANSPO	IN6009

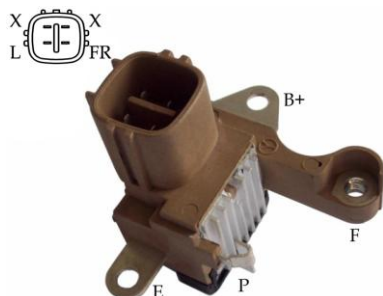

13301400 / 03-091

FEATURES

B-Circuit
 Voltage Set Point **14.50 V**
 Soft Start **32 %** LRC **5 sec**
 Field, Lamp Shorted Circuit Protection
 Under Voltage Indication
 Over Voltage Indication
 DFM function

Original & X-References..

NIPPONDENSO	126600-3080
MOBILETRON	VR-H2005-152
LESTER	11062
TRANSPO	IN6308

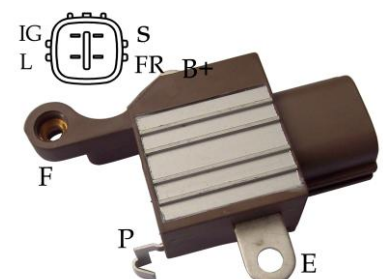

13301500 / 03-092

FEATUERS

B-Circuit
 Voltage Set Point **14.30 V**
 Soft Start **32 %**
 Field, Lamp Shorted Circuit Protection
 Sense open indication
 Under Voltage Indication
 Over Voltage Indication
 DFM function

Original & X-References..

NIPPONDENSO	126600-3000
LESTER	11138 11139
	11196 13984
MOBILETRON	VR-H2005-146
TRANSPO	IN6300

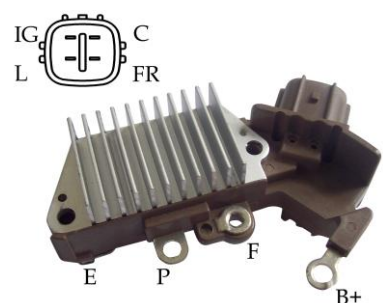

13325900 / 03-094

FEATURES

A-Circuit
 Voltage Set Point **14.00 V**
 Soft Start **30 %** LRC **5 sec**
 Field, Lamp Shorted Circuit Protection
 Under Voltage Indication
 Over Voltage Indication
 DFM function

Original & X-References..

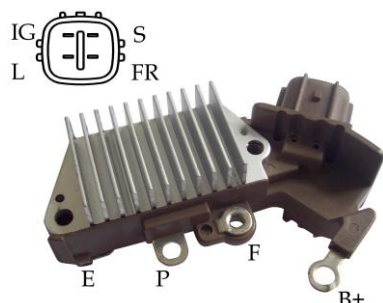

13326200 / 03-096

FEATURES

A-Circuit
 Voltage Set Point **14.15 V**
 Soft Start **30 %**
 LRC **5 sec**
 Field Shorted Circuit Protection
 Under/ Over Voltage Indication
 DFM Function
 63.5mm Mounting

Original & X-References..

NIPPONDENSO	126600-0520
	126600-0540
MOBILETRON	VR-H2005-100A
LESTER	11194
TRANSPO	IN3054



X LIN X

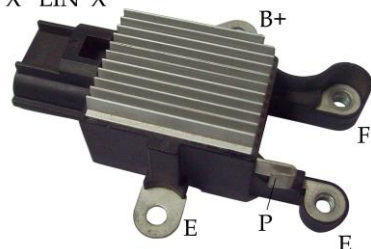

13310400 / 03-099

FEATURES

B-Circuit
Voltage Set Point **14.30 V**
LRC **3 sec**
Self Exciting Function

Original & X-References..

NIPPONDENSO	126600-7120
MOBILETRON	VR-H2005-171
LESTER	11054

LIN Regulator



IG L

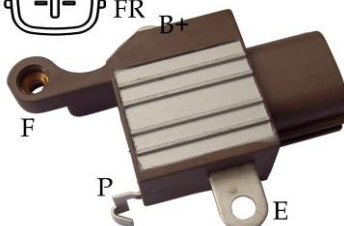

13326400 / 03-100

FEATURES

B-Circuit
Voltage Set Point **14.05 V**
Soft Start **32 %** LRC **5 sec**
Field, Lamp Shorted Circuit Protection
Sense open indication
Under Voltage Indication
Over Voltage Indication
DFM function

Original & X-References..

NIPPONDENSO	126600-3230
MOBILETRON	VRH2005-146
LESTER	11136 11137
TRANSP0	IN6323



S IG L

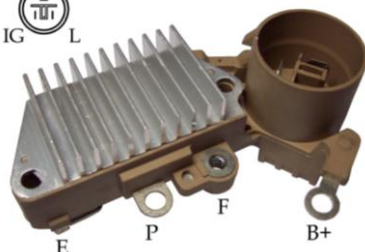

13326500/ 03-101

FEATURES

A-Circuit
Voltage Set Point **14.60V**
Soft Start **30 %** LRC **5 sec**
Field Shorted Circuit Protection
Under / Over Voltage Indication
63.5mm Mounting

Original & X-References..

TRANSP0	IN461
---------	-------



IG L S X

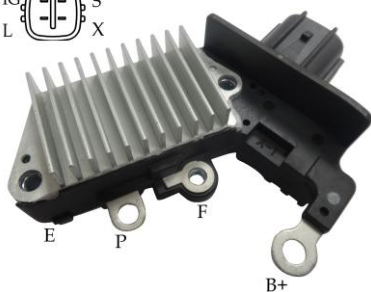

1332CQ00

FEATURES

A-Circuit
Voltage Set Point **14.50V**
Soft Start **30 %** LRC **5 sec**
Field Shorted Circuit Protection
Under / Over Voltage Indication
57.5mm Mounting

Original & X-References..

126000-2700



13400100 / 04-001

FEATURES

A-Circuit (Metal Can)
Voltage Set Point 28.10V

Slip Ring OD: 28mm

Original & X-References..

BOSCH	1197311304
FIAT	93158421
SCANIA	117253 362645
VOLVO	1606935 1625880
MOBILETRON	VR-B209
USI	71-40021
CARGO	135856
TRANSPO	IB363

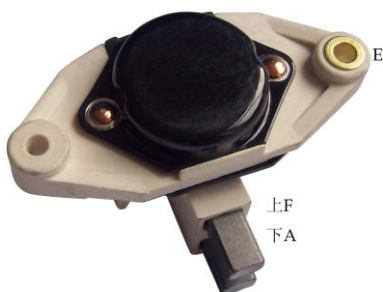

13412300 / 04-110

A-Circuit (Helmet Steel)
Voltage Set Point 28.50V

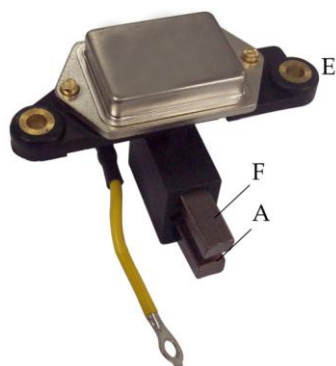

13400200 / 04-002

FEATURES

A-Circuit (Metal Can)
Voltage Set Point 28.50 V
Field Shorted Circuit Protection
O.E. Grade

Original & X-References..

PRESTOLITE 271

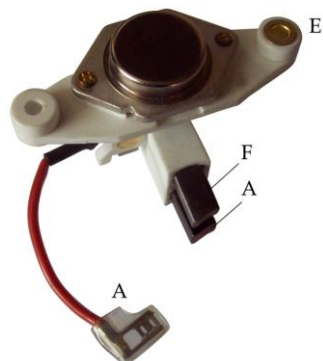

13400300 / 04-003

FEATURES

A-Circuit (Metal Can)
Voltage Set Point 28.50V
O.E. Grade
With Wiring: 70mm

Original & X-References..

JFZ2929

13401900 / 04-041

A-Circuit (Metal Can)
Voltage Set Point 14.50V



13400500 / 04-006

FEATURES

A-Circuit (Metal Can)
Voltage Set Point 28.50 V

Slip Ring OD : 28 mm

Original & X-References..

BOSCH	1197311315	0192053003
	0192053009	0192053012
	0192053014	0192053025
MERCEDES-BENZ	0001549606	0021543506
	0021545506	0021545606
MOBILETRON		VR-B206
CARGO		131340
TRANSPO		IB381 IB382

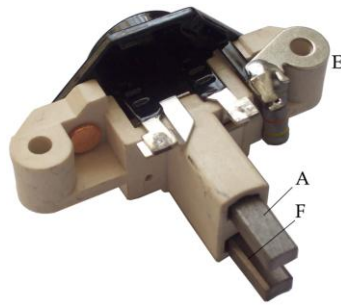

13400700 / 04-008

FEATURES

A-Circuit (Metal Can)
Voltage Set Point **14.60 V**
With 180 Ohm Resistor
Slip Ring OD: 14mm

Original & X-References..

BOSCH	
1197311211	1197311213
1197311217	1197311219
1197311242	1197311541
MOBILETRON	VR-B201
TRANSPO	IB387

13410900/ 04-061

A-Circuit (Metal Can)
Voltage Set Point **14.60 V**

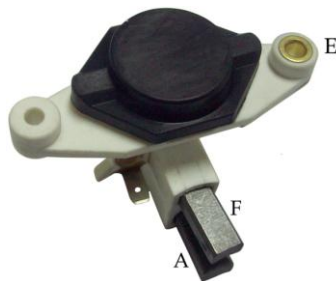

13400800 / 04-009

FEATURES

A-Circuit (Metal Can)
Voltage Set Point **14.50 V**
O.E. Grade

Original & X-References..

13402200 / 04-052

A-Circuit (Metal Can)
Voltage Set Point **28.50 V**
Without Protect cover
O.E. Grade



13400900 / 04-010

FEATURES

A-Circuit (Metal Can)
Voltage Set Point **28.10 V**

Original & X-References..

13401500 / 04-032

A-Circuit (Metal Can)
Voltage Set Point **14.50 V**

LADA	
ALTERNATOR	VAZ 2110

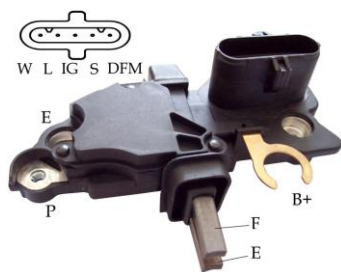

13420100 / 04-011

FEATURES

B-Circuit
Voltage Set Point **28.50V**
Soft Start **30 %** LRC **5 sec**
Field Shorted Circuit Protection
IG Open Indication
Under Voltage Indication
Over Voltage Indication
DFM function

Original & X-References..

BOSCH	
F00M 145256	F00M 145298
F00M 145302	F00M 145307
F00M 145237	F00M 145299
MERCEDES-BENZ	0001542705
SCANIA	1501245
CARGO	231523
TRANSPO	IB298

13425800 / 04-164

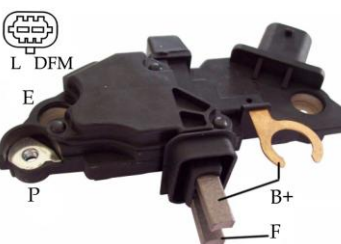

13420300 / 04-014

FEATURES

A-Circuit
Voltage Set Point **14.60 V**
Soft Start **30 %**
LRC **5 sec**
Field Shorted Circuit Protection
Under Voltage Indication
Over Voltage Indication
DFM function

Original & X-References..

BOSCH	F00M 145371
	F00M 145283
	F00M 145228
SCANIA	12790483
MOBILETRON	VR-B3716
CARGO	231716
LESTER	23106
TRANSPO	IB283

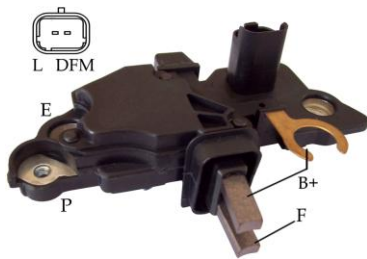

13420400 / 04-015

FEATURES

A-Circuit
 Voltage Set Point **14.60V**
 Soft Start **30 %**
 LRC **5 sec**
 Field Shorted Circuit Protection
 Under Voltage Indication
 Over Voltage Indication
 DFM function

Original & X-References..

BOSCH	F00M 145239
	F00M 145204
	F00M 145387
RENAULT	7701048230
MOBILETRON	VR-B251
CARGO	230624
LESTER	21504 23751
TRANSP0	IB239

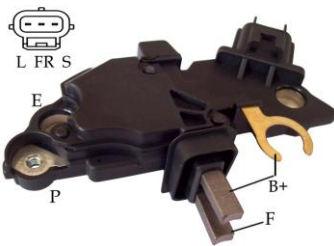

13420500 / 04-020

FEATURES

A-Circuit
 Voltage Set Point **14.60V**
 Soft Start **30 %**
 LRC **5 sec**
 Field Shorted Circuit Protection
 Under Voltage Indication
 Over Voltage Indication
 DFM function

Original & X-References..

BOSCH	F00M 145235
MOBILETRON	VR-B262
CARGO	233508
TRANSP0	IB235
	IB255

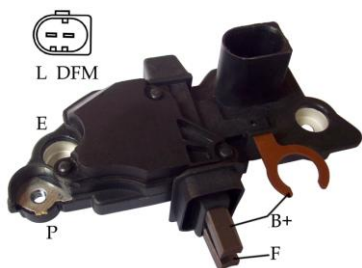

13420600 / 04-022

FEATURES

A-Circuit
 Voltage Set Point **14.60 V**
 Soft Start **30 %**
 LRC **5 sec**
 Field Shorted Circuit Protection
 Under Voltage Indication
 Over Voltage Indication
 DFM function

Original & X-References..

BOSCH	F00M 145225	F00M 145200
	F00M 145209	F00M 145223
	F00M 145233	F00M 145333
	F00M 145350	F00M 145353
MERCEDES-BENZ	0031542406	
RENAULT	5001850026	
MOBILETRON	VR-B254	
CARGO	139925	
TRANSP0	IB225	

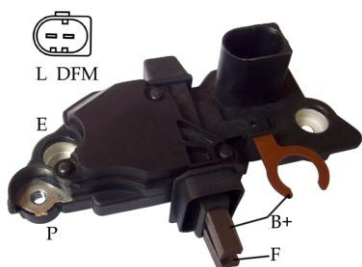

13420700 / 04-0221

FEATURES

A-Circuit
 Voltage Set Point **14.60 V**
 Soft Start **30 %**
 LRC **5 sec**
 Field Shorted Circuit Protection
 Under Voltage Indication
 Over Voltage Indication
 DFM function
 Self Exciting Function

Original & X-References..

BOSCH	F00M 144136	F00M 145200
	F00M 145209	F00M 145225
	F00M 145350	
TRANSP0	IB5225	

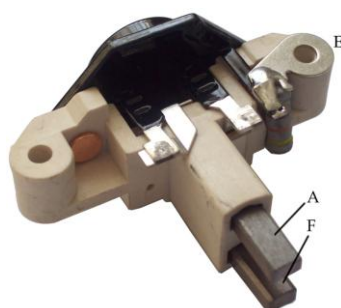

13401300 / 04-023

FEATURES

A-Circuit (**Metal Can**)
 Voltage Set Point **28.50 V**
 Slip Ring OD: 14mm

Original & X-References..

13402900 / 04-064

A-Circuit (**Metal Can**)
 Voltage Set Point **28.50 V**
 With 430 OHM Resistor
 Slip Ring OD: 14mm

13420800 / 04-024

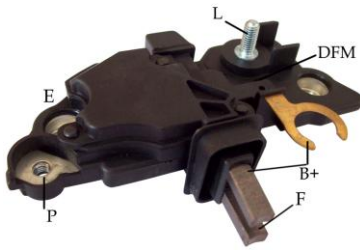

FEATURES

A-Circuit
 Voltage Set Point **14.60 V**
 Soft Start **30 %**
 LRC **5 sec**
 Field Shorted Circuit Protection
 Under Voltage Indication
 Over Voltage Indication
 DFM function

Original & X-References..

BOSCH		
F00M 145201		F00M 145231
F00M 145257		F00M 145282
F00M 145362		F00M 145370
MOBILETRON		VR-B252
MERCEDES-BENZ		
0031541506		0031545606
SA AB 5353552		
CARGO		139044
TRANSPO		IB231

13460100 / 04-025

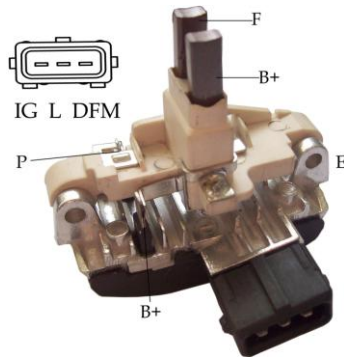

FEATURES

A-Circuit
 Voltage Set Point **14.50 V**
 Soft Start **32 %**
 LRC **5 sec**
 Field Shorted Circuit Protection
 IG Open Indication
 Under Voltage Indication
 Over Voltage Indication
 DFM function

Original & X-References..

BOSCH	1197311506	1197311516
	1197311536	1197311545
	1197311557	1197311547
AUDI/VW		
	037903803A	038903803C
BMW		12311435432
		12311713491
CARGO		138999
TRANSPO		IB545

13420900 / 04-026

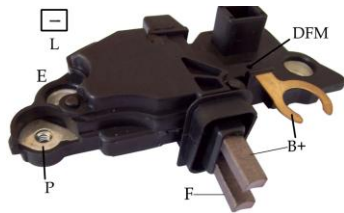

FEATURES

A-Circuit
 Voltage Set Point **14.60 V**
 Soft Start **30 %**
 LRC **5 sec**
 Field Shorted Circuit Protection
 Under Voltage Indication
 Over Voltage Indication
 DFM function

Original & X-References..

BOSCH	F00M 145229
	F00M 145208
	F00M 145351
MOBILETRON	VR-B238
CARGO	232927
TRANSPO	IB229

13427300/ 04-0261

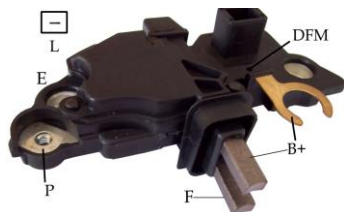

FEATURES

A-Circuit
 Voltage Set Point **14.60 V**
 Soft Start **30 %**
 LRC **5 sec**
 Field Shorted Circuit Protection
 Under Voltage Indication
 Over Voltage Indication
 DFM function
 Self Exciting Function

Original & X-References..

TRANSPO	IB5369
---------	--------

13460200 / 04-027

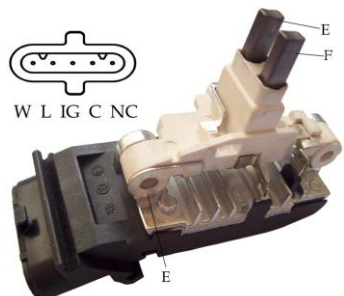

FEATURES

B-Circuit
 Voltage Set Point **28.50 V**
 Soft Start **30 %**
 Field Shorted Circuit Protection
 IG Open Indication
 Under Voltage Indication
 Over Voltage Indication

Original & X-References..

BOSCH1	197311558
	1197311554
	0272220217
MAN	81256010025
MOBILETRON	VR-B558B
CARGO	234522
TRANSPO	IB558



13421000 / 04-028

FEATURES

A-Circuit
Voltage Set Point **14.60V**
Soft Start **30 %**
LRC **5 sec**
Field Shorted Circuit Protection
Under Voltage Indication
Over Voltage Indication
DFM Function

Original & X-References..

BOSCH	F00M 225201
	F00M 225401
LESTER	13975 22952
MOBILETRON	VR-B257
CARGO	235528
TRANSPO	IB201

FOR MERCEDES-BENZ

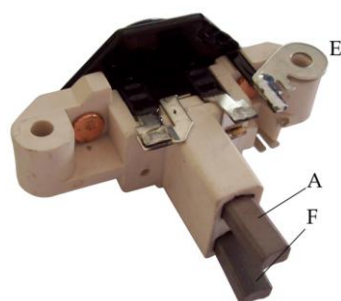

13401400 / 04-031

FEATURES

A-Circuit (Metal Can)
Voltage Set Point **14.50 V**
Slip Ring OD: 14mm

Original & X-References..

BOSCH		
	1197311212	1197311214
	1197311220	1197311221
	1197311223	1197311224
MOBILETRON		VR-B200H
WAI		35-9108
TRANSPO		IB385

13411000 / 04-062

A-Circuit (Helmet Steel)
Voltage Set Point **14.50 V**



13421100 / 04-035

FEATURES

A-Circuit
Voltage Set Point **14.60 V**
Soft Start **30 %**
LRC **5 sec**
Field Shorted Circuit Protection
IG Open Indication
Under Voltage Indication
Over Voltage Indication

Original & X-References..

BOSCH	F00M 255200
	F00M 255201
LESTER	11074 13815
MOBILETRON	VR-B394
CARGO	235460
TRANSPO	IB200

FOR BMW
WATER COOLING ALTERNATOR

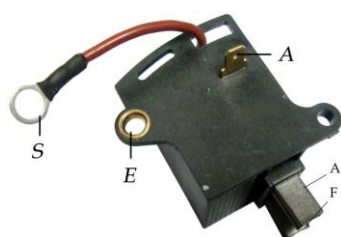

13410700 / 04-039

FEATURES

A-Circuit
Voltage Set Point **14.50 V**

Original & X-References..

LADA	21083701500
	5676255 173702
LUCAS	21229189 UCB 902
MAGNETI MARELLI	
	9400 38111
MOBILETRON	VR-LD160
TRANSPO	IR673

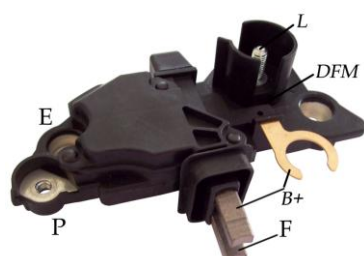

13421200 / 04-042

FEATURES

A-Circuit
Voltage Set Point **14.60V**
Soft Start **30 %**
LRC **5 sec**
Field Shorted Circuit Protection
Under Voltage Indication
Over Voltage Indication
DFM Function

Original & X-References..

BOSCH	F00M 145220
MOBILETRON	VR-B256
CARGO	230249
TRANSPO	IB220

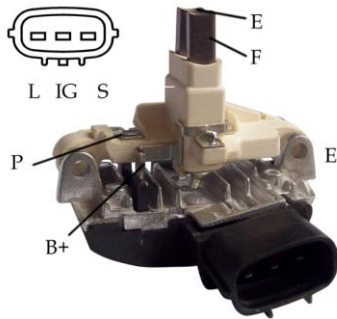

13460300 / 04-043

FEATURES

B-Circuit
Voltage Set Point **28.50 V**
Soft Start **30 %**
Field Shorted Circuit Protection
IG / Sense Open Indication
Under Voltage Indication
Over Voltage Indication

Original & X-References..

BOSCH	1197311543
CARGO	234112
TRANSPO	IB543

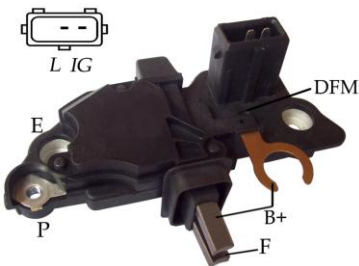

13421400 / 04-045

FEATURES

A-Circuit
Voltage Set Point **14.60 V**
Soft Start **30 %**
LRC **5 sec**
Field Shorted Circuit Protection
Under Voltage Indication
Over Voltage Indication
DFM Function

Original & X-References..

BOSCH	F00M 145251
	F00M 145245
	F00M 145360
MOBILETRON	VR-B360
TRANSPO	IB251

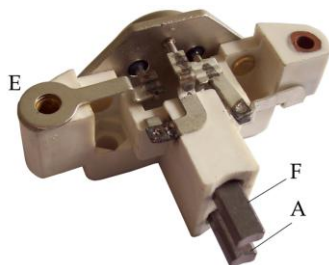

13402000 / 04-048

FEATURES

A-Circuit (Metal Can)
Voltage Set Point **14.50 V**
O.E. Grade

Original & X-References..

13403100 / 04-066

A-Circuit (Metal Can)
Voltage Set Point **28.50V**
O.E. Grade

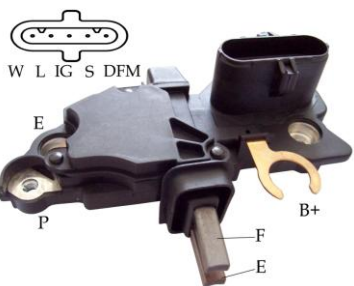

13421500 / 04-051

FEATURES

B-Circuit
Voltage Set Point **28.50 V**
Soft Start **30 %** LRC **5 sec**
Field Shorted Circuit Protection
Sense / IG Open Indication
Under Voltage Indication
Over Voltage Indication
DFM Function

Original & X-References..

BOSCH	F00M 144103	F00M 144119
	F00M 145246	F00M 145297
LESTER	12591	12599
	220-5306/5293/5295	
CARGO	233117	
TRANSPO	IB297	

FOR USE ON : SCANIA IVECO

13425900 / 04-165

13421600 / 04-053

FEATURES

B-Circuit
Voltage Set Point **14.50V**
Soft Start **30 %**
Field Shorted Circuit Protection
Under Voltage Indication
Over Voltage Indication
DFM Function
Self Exciting Function

Original & X-References..

BOSCH	F00M 145252
	F00M 145243
	F00M 145270
CARGO	232193
TRANSPO	IB252

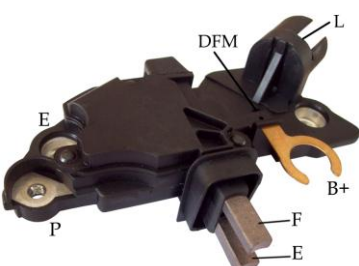

13402800 / 04-063

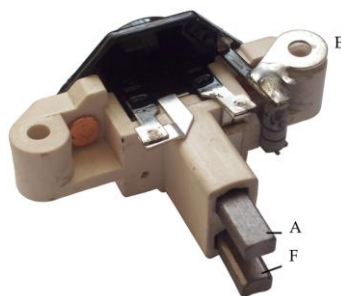

FEATURES

A-Circuit (Metal Can)
Voltage Set Point **14.60V**
With 180 Ohm Resister
Slip Ring OD: 14mm

Original & X-References..

BOSCH	1197311529
CARGO	137117
TRANSPO	IB529

13402300 / 04-054

A-Circuit (Metal Can)
Voltage Set Point **14.60V**
No 180 Ohm Resister
Slip Ring OD: 14mm

BOSCH	1197311548
	1197311500
	1197311523
	1197311530
	1197311531
TRANSPO	IB388

13402400 / 04-055



FEATURES

A-Circuit (Metal Can)
Voltage Set Point **14.60 V**
Slip Ring OD: 32mm

Original & X-References..

BOSCH	1197311032
MOBILETRON	VR-B260
TRANSPO	IB368

13402500 / 04-056

A-Circuit (Metal Can)
Voltage Set Point **28.10 V**
Slip Ring OD: 32mm

BOSCH	1197311310
	1197311313
MOBILETRON	VR-B203
CARGO	136433
TRANSPO	IB369

For use on: Engine Truck

13402600 / 04-057

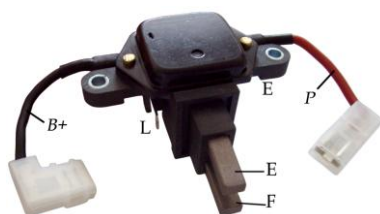

FEATURES

B-Circuit
Voltage Set Point **14.50 V**
Soft Start **30 %**
LRC **5 sec**
Field Lamp Choke Shorted Circuit Protection
Under Voltage Indication
Over Voltage Indication

Original & X-References..

LADA TRT3-01

13402700 / 04-058

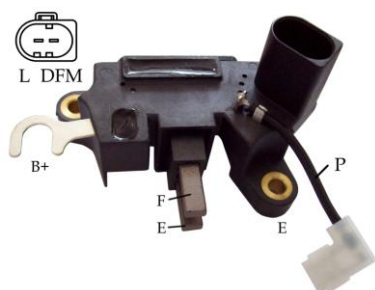

FEATURES

B-Circuit
Voltage Set Point **14.50 V**
Soft Start **18 %**
LRC **10 sec**
Field Lamp Choke Shorted Circuit Protection
Under Voltage Indication
Over Voltage Indication

Original & X-References..

LADA TRT5

13403200 / 04-067

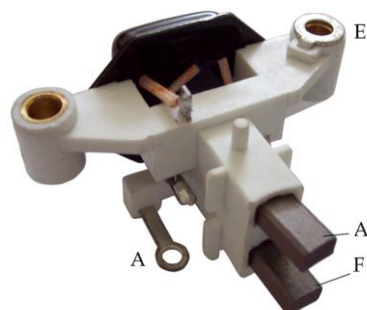

FEATURES

A-Circuit (Helmet Steel)
Voltage Set Point **14.60 V**
Low Cut-in Speed
Slip Ring OD: 32mm

Original & X-References..

CARGO	231044
MOBILETRON	VR-1K01

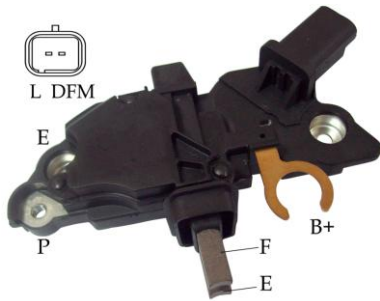

13421800 / 04-069

FEATURES

B-Circuit
 Voltage Set Point **14.50 V**
 Soft Start **30%** LRC **5 sec**
 Lamp Shorted Circuit Protection
 Field Shorted Circuit Protection
 P Terminal Self Exciting Function
 Under/ Over Voltage Indication
 DFM Function
 Self Exciting Function

Original & X-References..

BOSCH	F00M 145286
	F00M 145394
CARGO	234770
TRANSPO	IB286

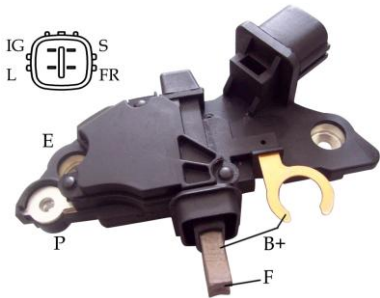

13421900 / 04-071

FEATURES

A-Circuit
 Voltage Set Point **14.50 V**
 Soft Start **32%**
 LRC **5 sec**
 Field, Shorted Circuit Protection
 Sense IG Open Indication
 Under Voltage Indication
 Over Voltage Indication
 DFM Function

Original & X-References..

BOSCH	F00M 145873
	F00M 145236
MOBILETRON	VR-B243
CARGO	233587
TRANSPO	IB236

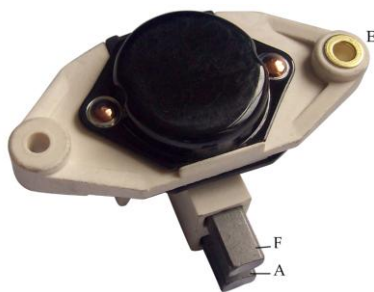

13411100 / 04-072

FEATURES

A-Circuit (**Helmet Steel**)
 Voltage Set Point **14.60 V**
 Low Cut-in Speed
 Slip Ring OD: 28mm

Original & X-References..

BOSCH	0192052033	0192053032
	1197311029	1197311030
	1197311031	1197311034
MOBILETRON	VR-B195M	
USI	71-40002	
WAI	35-9117	
CARGO	132666	
TRANSPO	IB360	



13450100 / 04-078

FEATURES

A-Circuit
 Voltage Set Point **14.50 V**
 Soft Start **19 %**
 LRC **9 sec**
 Field, Lamp Shorted Circuit Protection
 Under Voltage Indication
 Over Voltage Indication
 DFM Function

Original & X-References..

BOSCH	F00M 346010	F00M 346015
	F00M 346026	F00M 346087
LESTER	23925	23977
TRANSPO	IB6026	



13403700 / 04-081

FEATUERS

A-Circuit (**Metal Can**)
 Voltage Set Point **14.50 V**

Original & X-References..

13403600 / 04-080



FEATURES

A-Circuit (Metal Can)
Voltage Set Point **14.50V**
Slip Ring OD: 32mm

Original & X-References..

BOSCH	
1197311000	1197311001
1197311002	1197311090
2197311090	
TRANSPO	IB350

13410600 / 04-034



A-Circuit (Helmet Steel)
Voltage Set Point **14.50V**
Slip Ring OD: 32mm

13422000 / 04-082

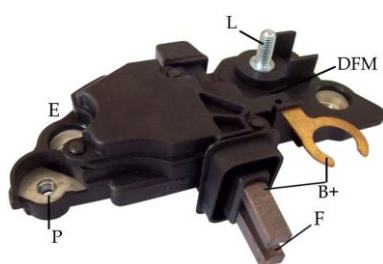

FEATURES

A-Circuit
Voltage Set Point **14.60 V**
Soft Start **30 %** LRC **5 sec**
Field Shorted Circuit Protection
Under/ Over Voltage Indication
DFM Function
Self Exciting Function

Original & X-References..

BOSCH	F00M 145249
	F00M 145260
	F00M 145325
TRANSPO	IB260

13422300 / 04-104

Voltage Set Point **28.20V**
Circuit Protection

13403800 / 04-084

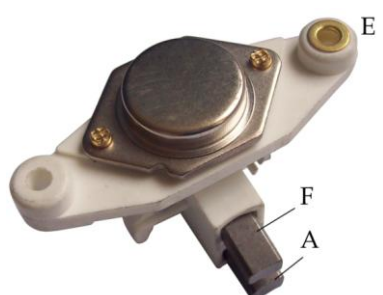

FEATURES

A-Circuit (Metal Can)
Voltage Set Point **14.50 V**
Slip Ring OD: 28mm

Original & X-References..

For use on: Alfa Romeo, Audi,
Chrysler, Porsche, VW, Volvo

BOSCH	
1192052015	1192052016
1192052020	1192052021
1192052024	1192052025
USI	71-40002
WAI	35-9104
TRANSPO	IB352

13411300 / 04-083



FEATUERS

A-Circuit
Voltage Set Point **14.40 V**

Original & X-References..

BOSCH	9190087003
	9121080303
WAI	35-9127
LESTER	13080
MOBILETRON	VR-B211
TRANSPO	IB359



04-085A/13547200

FEATUERS

A-Circuit
Voltage Set Point **14.40 V**

Original & X-References..

BOSCH 9120080041
9120080061
9120080072
9120080122
0120080090



13411400 / 04-0851

FEATUERS

A-Circuit
Voltage Set Point **14.40V**

Original & X-References..

AUDIVW 0409038031
BOSCH 9121808303
9121080303
LESTER 13080 20093
TRASPO IB003

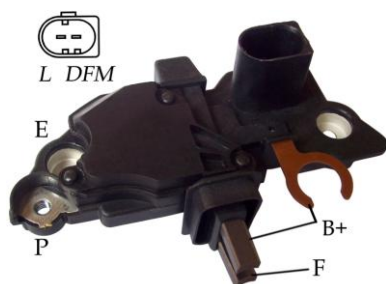

13422100 / 04-086

FEATUERS

A-Circuit
Voltage Set Point **14.60 V**
Soft Start **30 %**
LRC **5 sec**
Field Circuit Protection
Under Voltage Indication
Over Voltage Indication
DFM function

Original & X-References..

BOSCH FOOM 145247
FOOM 145357
CARGO 235207
TRANSPO IB247

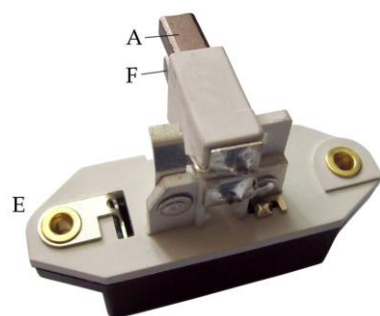

13411600 / 04-087

FEATUERS

A-Circuit
Voltage Set Point **14.40 V**
Slip Ring OD: 32mm

Original & X-References..

BOSCH 0192052001/2/4
TRANSPO IB358-1

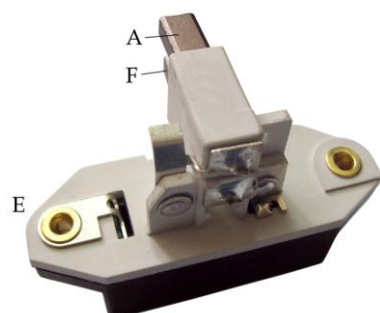

13411700 / 04-088

FEATUERS

A-Circuit
Voltage Set Point **14.40 V**
Slip Ring OD: 28mm

Original & X-References..

BOSCH 9190087032
190087026
MOBILETRON VR-B103

13411800 / 04-095

A-Circuit
Voltage Set Point **28.10 V**

BOSCH 9190087018
190087014 0192053006

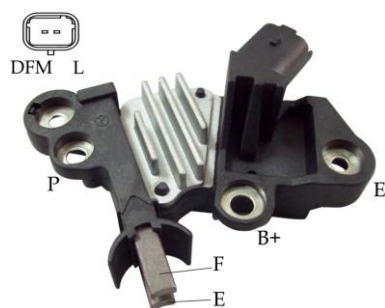

13450200 / 04-089

FEATUERS

B-Circuit
 Voltage Set Point **14.50 V**
 Soft Start **19 %**
 LRC **9 sec**
 Field, Lamp Shorted Circuit Protection
 Under Voltage Indication
 Over Voltage Indication
 DFM function

Original & X-References..

BOSCH FOOM 346340

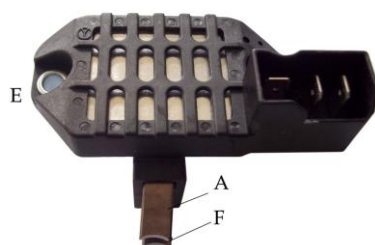

13417200 / 04-092

FEATUERS

A-Circuit
 Voltage Set Point **14.50 V**

Original & X-References..

MAGNATON 0138841
 CARGO 234480



13404200 / 04-096

FEATURES

A-Circuit (Metal Can)
 Voltage Set Point **14.60 V**

Original & X-References..

ISKRA 11125204 11125165
 IK5444

13404400 / 04-109

A-Circuit (Metal Can)
 Voltage Set Point **28.50 V**

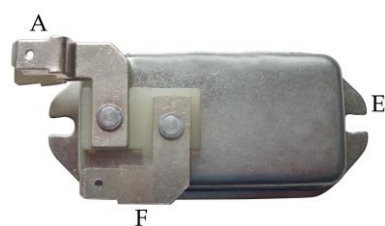

13540100 / 04-097

FEATUERS

B-Circuit
 Voltage Set Point **14.10 V**

Original & X-References..

BOSCH 9190456007
 IK413HD

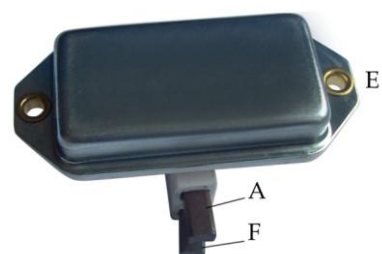

13412000 / 04-099

FEATUERS

A-Circuit
 Voltage Set Point **14.60 V**

Original & X-References..

BOSCH 9190547002
 9120450041
 IK586

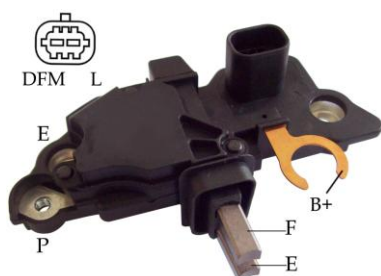

13423200/ 04-129

FEATUERS

B-Circuit
Voltage Set Point **14.50V**
Soft Start **30 %**
Field Shorted Circuit Protection
Under Voltage Indication
Over Voltage Indication
DFM Function
Self Exciting Function

Original & X-References..

BOSCH	F00M 144109
	F00M 144160
MOBILETRON	VR-B160
CAGRO	332132
LESTER	23817
TRANSP0	IB160

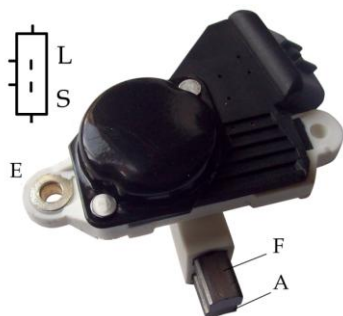

13412200 / 04-103

FEATUERS

A-Circuit (**Helmet Steel**)
Voltage Set Point **14.50 V**

Original & X-References..

BOSCH	9190041002
TRANSP0	IB501

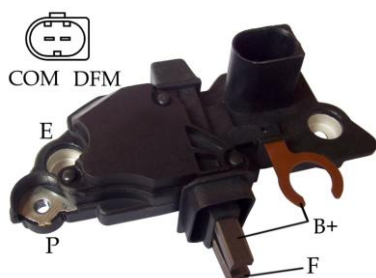

13422400 / 04-106

FEATUERS

A-Circuit
Voltage Set Point **14.80 V**
Soft Start **17 %**
LRC **4 sec**
Self Exciting Function

Original & X-References..

BSS Regulator

BOSCH	F00M 144147
	F00M 145272
	F00M 145293
	F00M 145367
	F00M 145395
CARGO	237270
LESTER	13954 23248
	23285 23964
TRANSP0	IB293

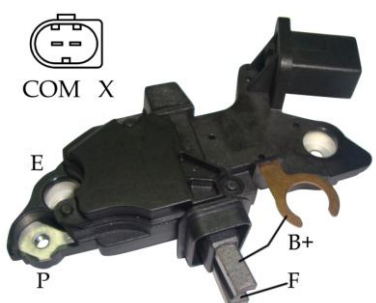

13422500 / 04-107

FEATUERS

A-Circuit
Voltage Set Point **14.80 V**
Soft Start **17 %**
LRC **4 sec**
Self Exciting Function

Original & X-References..

BSS Regulator

BOSCH		
	F00M A45221	F00M 145880
	F00M 145312	F00M 145655
LESTER	23254	23375
CARGO	236455	
TRANPO	IB262	

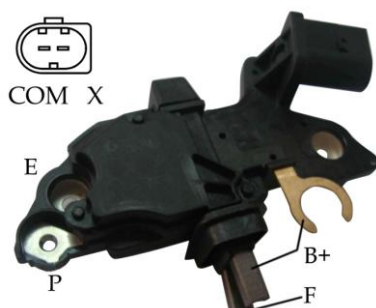

13422600 / 04-108

FEATUERS

A-Circuit
Voltage Set Point **14.80 V**
Soft Start **17 %**
LRC **4 sec**
Self Exciting Function

Original & X-References..

BSS Regulator

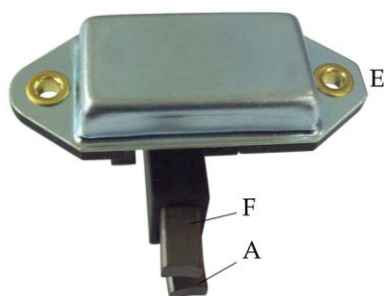

13412400 / 04-112

FEATUERS

A-Circuit
Voltage Set Point **14.30 V**

Original & X-References..

BOSCH 9190087039 9190087040
IK5541

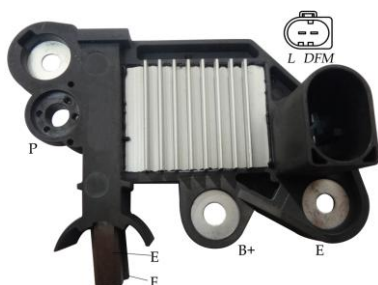

13440200 / 04-113

FEATURES

B-Circuit
Voltage Set Point **14.50 V**
Soft Start **30 %** LRC **5 sec**
Field Shorted Circuit Protection
L Terminal Drives Choke
Under/ Over Voltage Indication
DFM Function
Self Exciting Function

Original & X-References..

9RC7129C

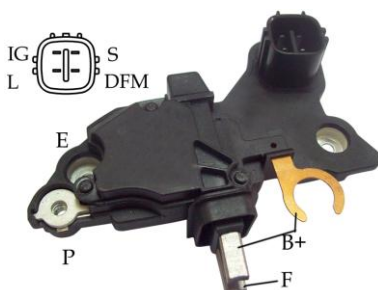

13440300 / 04-114

FEATURES

A-Circuit
Voltage Set Point **14.50 V**
Soft Start **32 %** LRC **5 sec**
Field Shorted Circuit Protection
IG / Sense Open Indication
Under/ Over Voltage Indication
DFM Function

Original & X-References..

BOSCH F00M 145875
F00M 145332
CARGO 330189

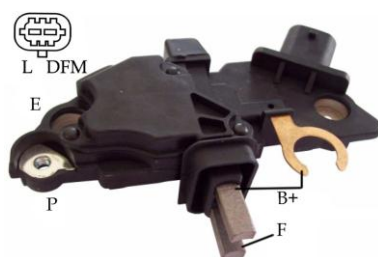

13422700 / 04-115

FEATURES

A-Circuit
Voltage Set Point **14.50V**
Soft Start **30 %**
LRC **5 sec**
Field Shorted Circuit Protection
Under Voltage Indication
Over Voltage Indication
DFM function

Original & X-References..

BOSCH F00M 144110

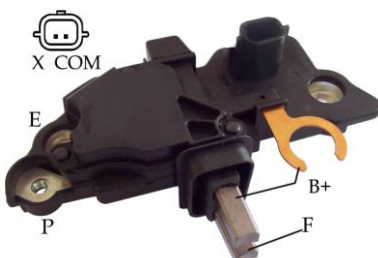

13422800 / 04-116

FEATUERS

A-Circuit
Voltage Set Point **14.80 V**
Soft Start **17 %**
LRC **4 sec**
Self Exciting Function

Original & X-References..

BOSCH F00M 145304
F00M 144131 F00M 145321
TRANSPO IB321

BSS Regulator

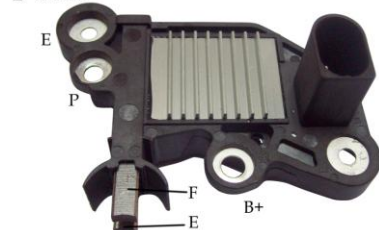

13440400 / 04-117

FEATUERS

B-Circuit
 Voltage Set Point **14.50 V**
 Soft Start **30 %** LRC **5 sec**
 Field Shorted Circuit Protection
 L Terminal Drives Choke
 Under/ Over Voltage Indication
 DFM Function
 Self Exciting Function

Original & X-References..

BOSCH	F00M 346057
	F00M 346098
	F00M 346074

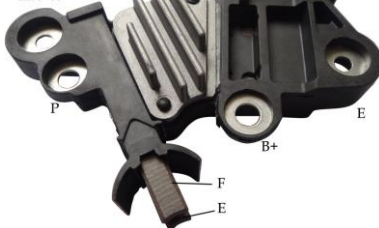

13450300 / 04-118

FEATURES

B-Circuit
 Voltage Set Point **13.70 V**
 LRC **3 sec**
 Self Exciting Function

Original & X-References..

BOSCH	
F00M 346056	F00M 346097
F00M 346005	F00M 346019
CARGO	330116
TRANSPO	IB6056

LIN Regulator

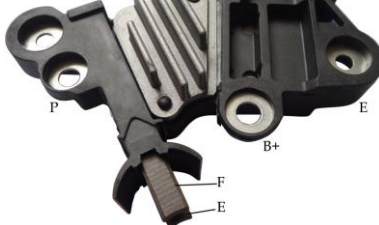

13450400 / 04-119

FEATURES

B-Circuit
 Voltage Set Point **14.00 V**
 LRC **3 sec**
 Self Exciting Function

Original & X-References..

BOSCH	F00M 346081
F00M346020	F00M346036
F00M346048	

LIN Regulator



13450500 / 04-121

FEATUERS

B-Circuit
 Voltage Set Point **14.50 V**
 Soft Start **30 %** LRC **5 sec**
 Field Shorted Circuit Protection
 L Terminal Drives Choke
 Under/ Over Voltage Indication
 DFM Function
 Self Exciting Function

Original & X-References..

BOSCH	
1275105104	1907107613
1907107613	0272220704



13450600 / 04-122

FEATURES

A-Circuit
 Voltage Set Point **14.80 V**
 Soft Start **17 %**
 LRC **4 sec**
 Self Exciting Function

Original & X-References..

BOSCH	F00M 346135
-------	-------------

BSS Regulator



13412600 / 04-124

FEATURES

A-Circuit
Voltage Set Point **14.50 V**
Soft Start **30 %**
Field Shorted Circuit Protection
Under Voltage Indication
Over Voltage Indication

Original & X-References..

BOSCH	9191067043
9191067049	9191067059
CARGO	231237
MOBILETRON	VR-B393
TRANSPO	IB343

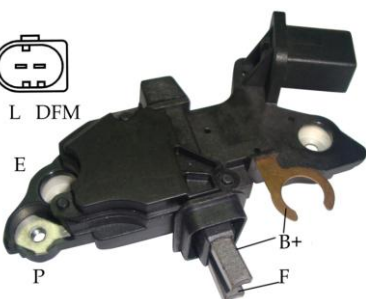

13422900 / 04-125

FEATURES

A-Circuit
Voltage Set Point **14.20 V**
Soft Start **30 %**
LRC **5 sec**
Field Shorted Circuit Protection
Under Voltage Indication
Over Voltage Indication
DFM function

Original & X-References..

BOSCH	F00M145266	F00M 144155
MOBILETRON	VR-B883	
LESTER	23269	23344
TRANSPO	IB266	

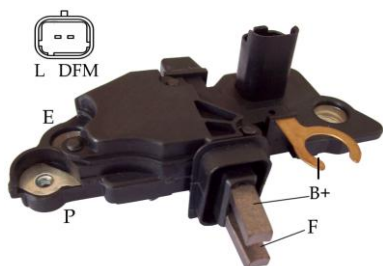

13423000 / 04-126

FEATURES

A-Circuit
Voltage Set Point **14.60V**
Soft Start **30 %** LRC **5 sec**
Field Shorted Circuit Protection
Under Voltage Indication
Over Voltage Indication
DFM function
Self Exciting Function
For use on: Nissan, Renault (Europe)

Original & X-References..

BOSCH	F00M 145276	F00M 145368
LESTER	23367	23368
	23369	23540 23542
CARGO	236717	
TRANSPO	IB276	

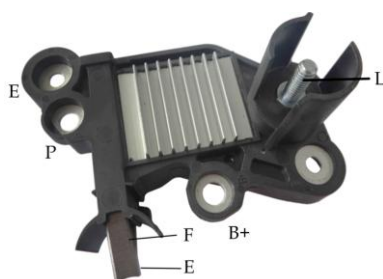

13440500 / 04-128

FEATURES

B-Circuit
Voltage Set Point **14.50 V**
Soft Start **30 %** LRC **5 sec**
Field Shorted Circuit Protection
L Terminal Drives Choke
Under/ Over Voltage Indication
DFM Function
Self Exciting Function

Original & X-References..

BOSCH	1275200003	0272220703
-------	------------	------------

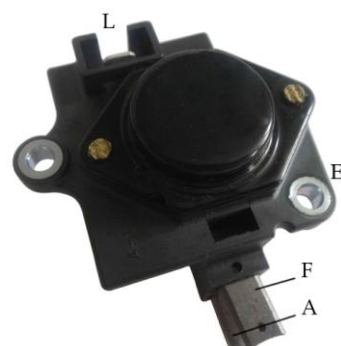

13404500 / 04-130

FEATURES

A-Circuit
Voltage Set Point **14.50 V**

Original & X-References..

LADA	2108-3701500
------	--------------

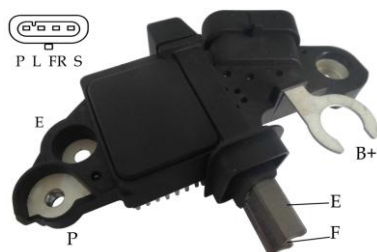

13440600 / 04-131

FEATURES

B-Circuit
 Voltage Set Point **14.70 V**
 Soft Start **30 %** LRC **5 sec**
 Field Shorted Circuit Protection
 Under/ Over Voltage Indication
 DFM Function

Original & X-References..

BOSCH F00M 145330

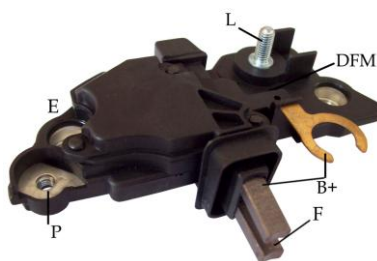

13423300 / 04-133

FEATURES

A-Circuit
 Voltage Set Point **14.70 V**
 Soft Start **30 %** LRC **5 sec**
 Field Shorted Circuit Protection
 Under/ Over Voltage Indication
 DFM Function

Original & X-References..

BOSCH F00M 145227
 MOBILETRON VR-B265
 LESTER 13805
 TRANSPO IB227

For use on: (2005-00) Saturn

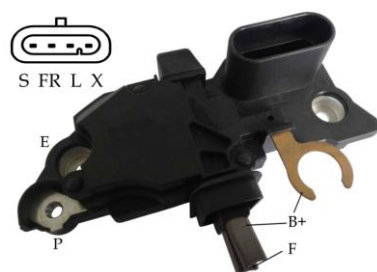

13423400 / 04-134

FEATURES

A-Circuit
 Voltage Set Point **14.60 V**
 Soft Start **30 %**
 LRC **5 sec**
 Field Shorted Circuit Protection
 Under Voltage Indication
 Over Voltage Indication
 DFM Function

Original & X-References..

BOSCH F00M 145224
 F00M 145241
 LESTER 13770 13771 13860
 TRANSPO IB241

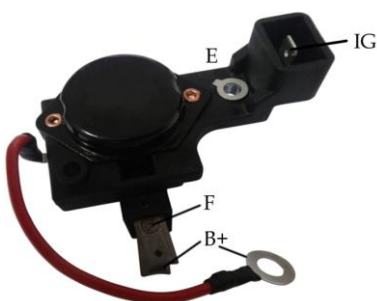

13412800 / 04-136

FEATURES

A-Circuit (**Helmet Steel**)
 Voltage Set Point **14.10 V**

Original & X-References..

LADA 2105-3701500-10

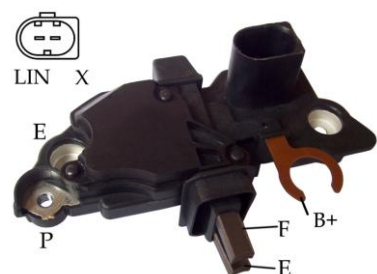

13430200 / 04-140

FEATURES

B-Circuit
 Voltage Set Point **14.00 V**
 LRC **3 sec**
 Self Exciting Function

Original & X-References..

BOSCH F00M 145698 F00M144150
 F00M 145665
 CARGO 235809

LIN Regulator

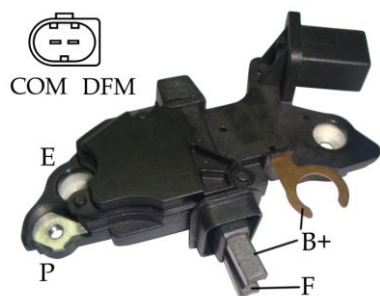

13423500 / 04-141

FEATURES

A-Circuit
Voltage Set Point **14.80 V**
Soft Start **17 %**
LRC **4 sec**
Self Exciting Function

BSS Regulator

Original & X-References..

BOSCH	F00M 145292
F00M144108	F00M 144132
F00M145374	F00M 145884
CARGO	237736

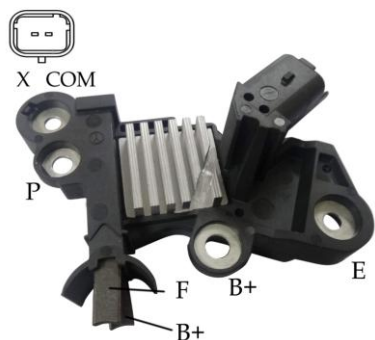

13440700 / 04-142

FEATURES

A-Circuit
Voltage Set Point **14.80 V**
Soft Start **17 %**
LRC **4 sec**
Self Exciting Function

BSS Regulator

Original & X-References..

BOSCH	F00M 346066
-------	-------------

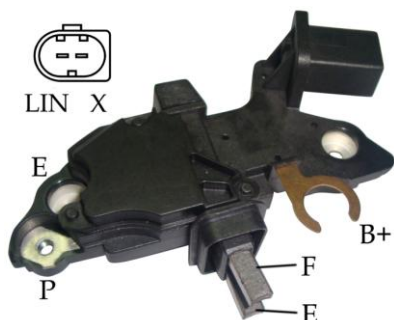

13430300 / 04-143

FEATURES

B-Circuit
Voltage Set Point **14.00 V**
LRC **3 sec**
Self Exciting Function

LIN Regulator

Original & X-References..

BOSCH	F00M 144157
	F00M 145309
	F00M 145377
	F00M 145885
LESTER	11215
TRANSPO	IB885

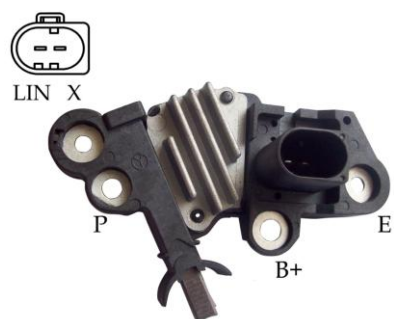

13450700 / 04-144

FEATURES

B-Circuit
Voltage Set Point **14.00 V**
LRC **3 sec**
Self Exciting Function

LIN Regulator

Original & X-References..

BOSCH	F00M 346074
-------	-------------

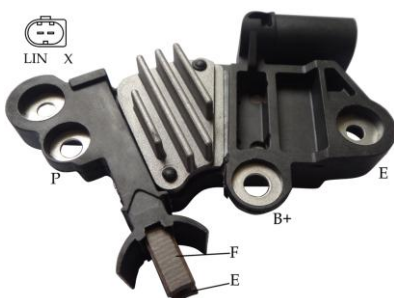

13450800 / 04-145

FEATURES

B-Circuit
Voltage Set Point **14.00 V**
LRC **3 sec**
Self Exciting Function

LIN Regulator

Original & X-References..

BOSCH	
F00M 346021	F00M 346037
F00M 346047	F00M 346080



L DFM

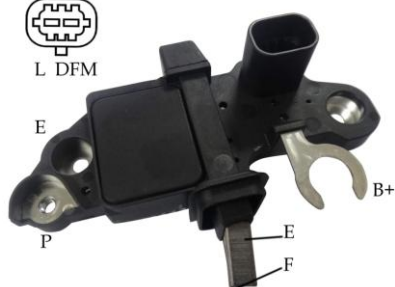

E

P

E

F

B+

13430400 / 04-146

FEATURES

B-Circuit
 RVC=0 $V_{set}=13.80V$
 RC=70% $V_{set}=14.45V$
 Soft Start 18.75 %
 LRC 2.5 sec
 DFM function

RVC Regulator

Original & X-References..

BOSCH
 F00M 145314 F00M 145328
 F00M145696
 LESTER 11075 11125
 11126 11127 11185 11234
 TRANSPO IB314 IB696



COM X

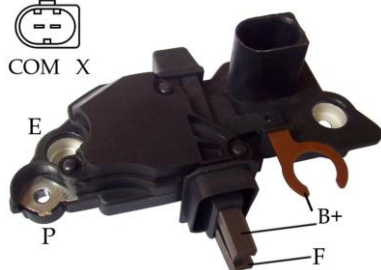

E

P

B+

F

13423600 / 04-147

FEATUERS

A-Circuit
 Voltage Set Point 14.80 V
 Soft Start 17 %
 LRC 4 sec
 Self Exciting Function

BSS Regulator

Original & X-References..

BOSCH F00M A45219
 F00M 145280
 F00M 145679



13413100 / 04-148

FEATUERS

A-Circuit
 Voltage Set Point 28.50 V

Original & X-References..



S L



B+

13413200 / 04-149

FEATUERS

A-Circuit
 Voltage Set Point 14.40 V
 Soft Start 30 %
 LRC 5 sec
 Field Shorted Circuit Protection
 Under/ Over Voltage Indication

Original & X-References..

BHSCH 9-190-067-018
 MOBILETRON VRB-392
 CARGO 136555
 WAI 35-9115
 TRANSPO IB392

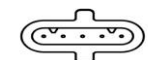

W L IG S DFM

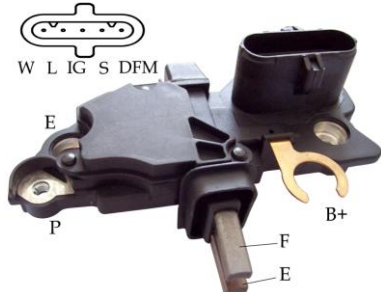

E

P

B+

F

E

13423700 / 04-150

FEATUERS

B-Circuit
 Voltage Set Point 28.50V
 Soft Start 30 %
 LRC 5 sec
 Field Shorted Circuit Protection
 IG Open Indication
 Under Voltage Indication
 Over Voltage Indication
 DFM function

Original & X-References..

BOSCH
 F00M 144106 F00M 144122
 F00M 145294 F00M 145300
 LESTER 23883
 TRANSPO IB5300

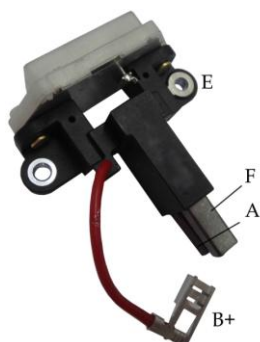

13404800 / 04-152

FEATUERS

A-Circuit
Voltage Set Point 28.50V

Original & X-References..



13440800 / 04-155

FEATUERS

B-Circuit
Voltage Set Point 14.50 V
Soft Start 30 % LRC 5 sec
Field Shorted Circuit Protection
L Terminal Drives Choke
Under/ Over Voltage Indication
DFM Function
Self Exciting Function

Original & X-References..

BOSCH 0272220706
0272220707



13450900 / 04-156

FEATUERS

B-Circuit
Voltage Set Point 14.00 V
LRC 3 sec
Self Exciting Function

Original & X-References..

BOSCH F00M346139

LIN Regulator



13413500 / 04-158

FEATUERS

A-Circuit
Voltage Set Point 28.50 V
Slip Ring OD: 28mm

Original & X-References..

BOSCH 9190087018
9190087014
0192053006.

13413400 / 04-157

A-Circuit
Voltage Set Point 14.40 V

BOSCH 9190087016
9190087019 9190087023
9190087031



13440900 / 04-160

FEATUERS

B-Circuit
Voltage Set Point 14.10 V

Original & X-References..

VALEO 097163
CARGO 130675
MOBILETRON VRB190
TRANSPO IB305

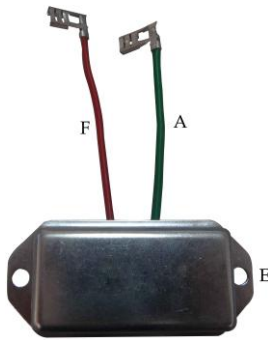

13441000 / 04-161

FEATUERS

B-Circuit
Voltage Set Point **14.10 V**

Original & X-References..

BOSH	9-190-457-002
CARGO	131297
MOBILETRON	VRB213
TRANSPO	1B400

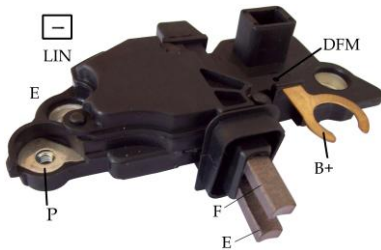

13424000/04-162

FEATUERS

B-Circuit
Voltage Set Point **14.00 V**
LRC **3 sec**
Self Exciting Function

Original & X-References..

BOSCH	F00MA45212
-------	------------

LIN Regulator



13417500

FEATUERS

A-Circuit
Voltage Set Point **14.50 V**

Original & X-References..

A20-298Y

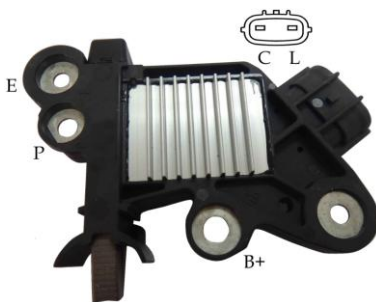

13451100

FEATUERS

B -Circuit
Voltage Set Point **14.50 V**
Soft Start **12.5 %** LRC **5 sec**
Field Shorted Circuit Protection
Over Voltage Indication

Original & X-References..

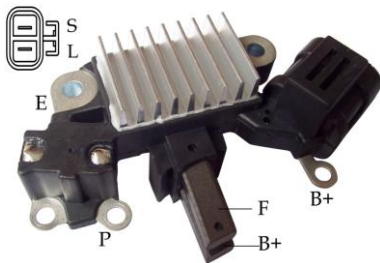

13500100 / 05-001

FEATURES

A-Circuit
 Voltage Set Point **14.40 V**
 Soft Start **30 %**
 Field Shorted Circuit Protection
 Under Voltage Indication
 Over Voltage Indication

Original & X-References..

HITACHI	LR180-756B
	LR1100-702
MOBILETRON	VR-H2000-44
CARGO	234612
TRANSPO	IH738

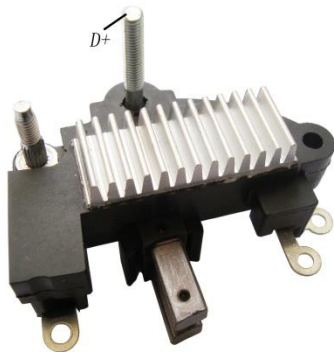

13506700 / 05-002

FEATURES

A-Circuit
 Voltage Set Point **14.70 V**

Original & X-References..



13506600 / 05-003

FEATURES

A-Circuit
 Voltage Set Point **28.60 V**

Original & X-References..

ISUZU	8-9711264-6
-------	-------------

13526500 / 05-024

B-Circuit
 Voltage Set Point **14.70V**

ISUZU	8-97062649-0
HITACHI	LR180G-2315
CARGO	137584

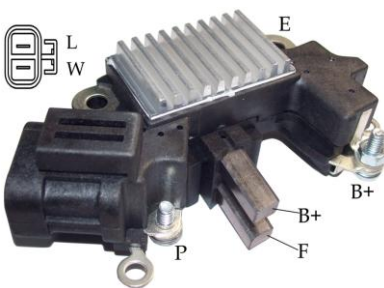

13500200 / 05-004

FEATURES

A-Circuit
 Voltage Set Point **14.40 V**
 Soft Start **30 %**
 Field Shorted Circuit Protection
 Under Voltage Indication
 Over Voltage Indication

Original & X-References..

HITACHI	L170G-3319
	L170G-6308
	L170G-7315
MOBILETRON	VR-H2000-41
CARGO	139980
UNIPOINT	YR-713
TRANSPO	IH776

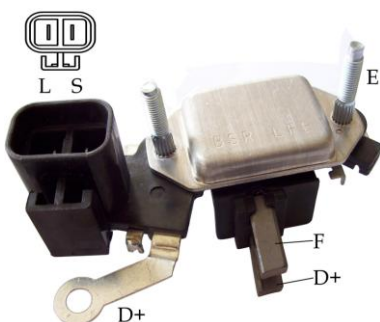

13520300 / 05-007

FEATURES

A-Circuit
 Voltage Set Point **14.70 V**

Original & X-References..

HITACHI	L150-93155
	L160-23153
MOBILETRON	VR-H2000-30
CARGO	137189
WAI	35-8136
TRANSPO	IH205

13521300 / 05-032

A-Circuit
 Voltage Set Point **28.40 V**

HITACHI	L225-9315
CARGO	234701

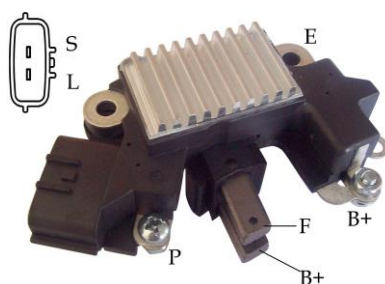

13500300 / 05-008

FEATURES

A-Circuit
 Voltage Set Point **14.50 V**
 Soft Start **30 %**
 Field Shorted Circuit Protection
 Sense Open Indication
 Under Voltage Indication
 Over Voltage Indication

Original & X-References..

HITACHI	L1100G-3340
	L1110G-9340
	L1125G-1340
MOBILETRON	VR-H2000-28
CARGO	138717
WAI	35-8127
UNIPOINT	YR-715
TRANSPO	IH766

13502000 / 05-059

Without Brush Holder

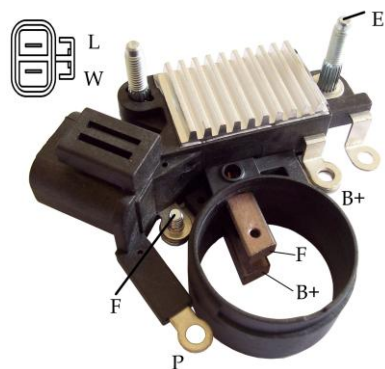

13500400 / 05-009

FEATURES

A-Circuit
 Voltage Set Point **14.50 V**
 Soft Start **30 %**
 Under Voltage Indication
 Over Voltage Indication

Original & X-References..

HITACHI	TR1E-123
LR1100	501
	502B
CARGO	230433

13502500 / 05-089

Without Brush Holder

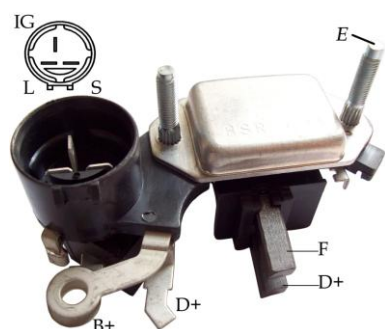

13520400 / 05-010

FEATURES

A-Circuit
 Voltage Set Point **14.70 V**

Original & X-References..

HITACHI	L150-33155
CARGO	133544
TRANSPO	IH252V

13522200 / 05-048

Without Capacitor

For use on: Industrial

MOBILETRON	VR-H2000-29
CARGO	133544
TRANSPO	IH252



13520500 / 05-011

FEATURES

A-Circuit
 Voltage Set Point **14.70 V**

Original & X-References..

HITACHI	FA8065A
	L170-G1315
TRANSPO	IH254V

13522500 / 05-056

Without Capacitor

For use on: Isuzu and Opel
 Vauxhall Astra 1.7D Ventra

MOBILETRON	VR-H2000-40
CARGO	137841
TRANSPO	IH254

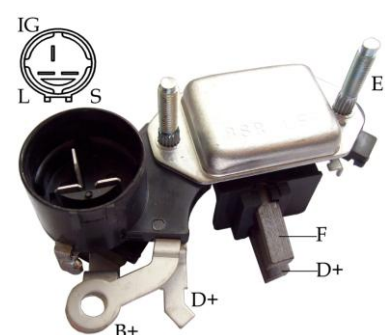

13520600 / 05-012

FEATURES

A-Circuit
 Voltage Set Point **28.40 V**

Original & X-References..

HITACHI	TR2Z-49
TRANSPO	IH253V

13521900 / 05-044

Without Capacitor

For use on: Nissan Forklift

MOBILETRON	VR-H2000-29B
CARGO	233893
TRANSPO	IH253

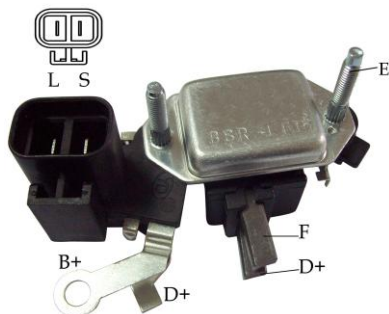

13520700 / 05-013

FEATURES

A-Circuit
Voltage Set Point **14.60 V**

Original & X-References..

HITACHI	LR170-406
MOBILETRON	VR-H2000-30
CARGO	133543 137189
TRANSPO	IH205

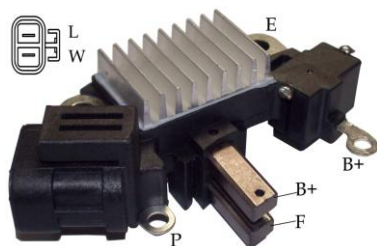

13500500 / 05-014

FEATURES

A-Circuit
Voltage Set Point **14.40 V**
Soft Start **30 %**
Field Shorted Circuit Protection
Under Voltage Indication
Over Voltage Indication

Original & X-References..

HITACHI	LR150-511
	LR1100-502F
	LR170-509E
MOBILETRON	VR-H2000-50
CARGO	232443
TRANSPO	IH769

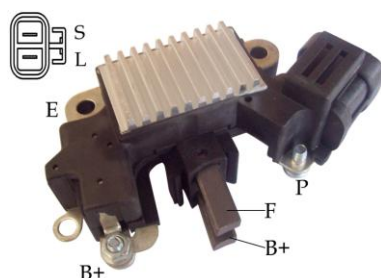

13500600 / 05-015

FEATURES

A-Circuit
Voltage Set Point **14.50 V**
Soft Start **30 %**
Field Shorted Circuit Protection
Sense Open Indication
Under Voltage Indication
Over Voltage Indication

Original & X-References..

HITACHI	L170G-5315
	L170G-6315
	L180G-23401
WAI	35-8126
MOBILETRON	VR-H2000-38
CARGO	138727
UNIPOINT	YR-714
TRANSPO	IH767

13501600 / 05-047

Without Brush Holder

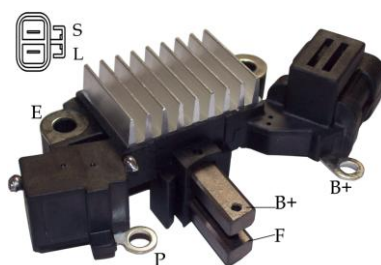

13500700 / 05-016

FEATURES

A-Circuit
Voltage Set Point **28.40 V**
Soft Start **30 %**
Field Shorted Circuit Protection
Sense Open Indication
Under/ Over Voltage Indication

Original & X-References..

HITACHI	LR280-508
ISUZU	8972489141
MOBILETRON	VR-H2000-70B

13501400 / 05-042

Voltage Set Point **14.40 V**
NO Sense Open Indication

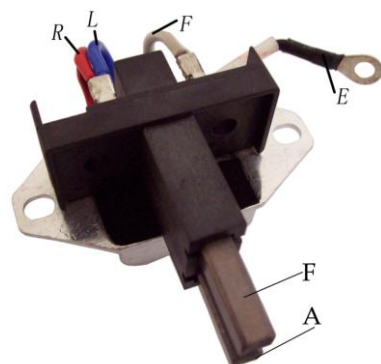

13530100 / 05-017

FEATURES

A-Circuit
Voltage Set Point **28.10 V**

Original & X-References..

HINO	27050-1112A
------	-------------

For use on:
Nissan Bus, Truck & Industrial,
Hino, Bus, Truck & Industrial

13547400 / 05-021

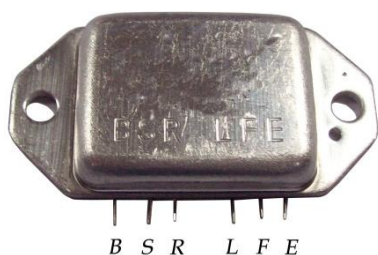

B S R L F E

FEATURES

A-Circuit
Voltage Set Point 14.70 V

Original & X-References..

HITACHI	L15023155
TR1Z-62	TR1Z64
TR1Z-53	TR1Z43
MOBILETRON	VR-H-2000-3
USI	71-50011
CARGO	136284
	131287
WAI	35-8101
TRANSP0	IH212

13547600 / 05-023



B S R L F E

A-Circuit
Voltage Set Point 14.70 V

For use on: Isuzu Pickup Diesel,
Nissan Maxima Diesel, Sentara, Pickup

13547500 / 05-022

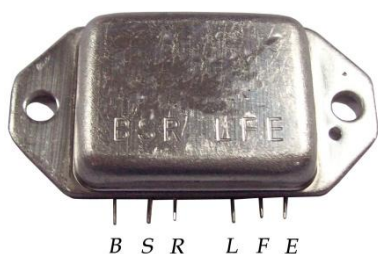

B S R L F E

FEATURES

A-Circuit
Voltage Set Point 28.40 V

Original & X-References..

HITACHI	TR2Z-37	R2Z-49
MOBILETRON	VR-H200-2	
USI	71-50012	
WAI	35-8139	
CARGO	132292	
TRANSP0	IH716	

13500900 / 05-025

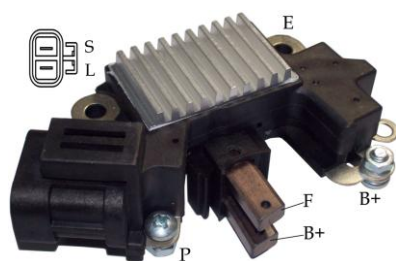

FEATURES

A-Circuit
Voltage Set Point 14.50 V
Soft Start 30 %
Field Shorted Circuit Protection
Sense Open Indication
Under/ Over Voltage Indication

Original & X-References..

HITACHI	L185G-4340
MOBILETRON	VR-H2000-27
WAI	35-8128
TRANSP0	IH765

13500800 / 05-018

Without Brush Holder

13506900 / 05-026

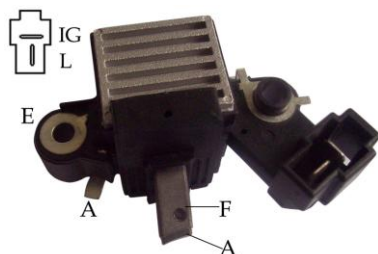

FEATURES

A-Circuit
Voltage Set Point 14.40 V

Original & X-References..

HITACHI	LR140-708
	LR140-708C
CARGO	234276
TRANSP0	IH258

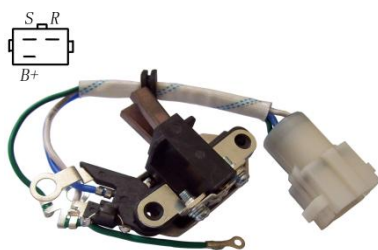

13530200 / 05-027

FEATURES

A-Circuit
Voltage Set Point 14.70 V

Original & X-References..

HITACHI	LR15078B
TRANSPO	IH204

13521500 / 05-034

Without wire plug

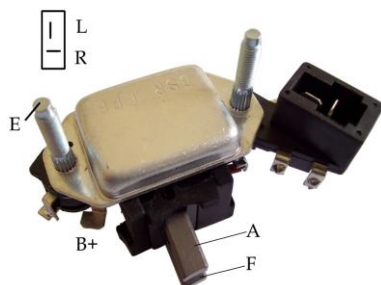

13521000 / 05-028

FEATURES

A-Circuit
Voltage Set Point 14.70 V

Original & X-References..

HITACHI	L150-73154
MOBILETRON	VR-H2000-36
CARGO	132432

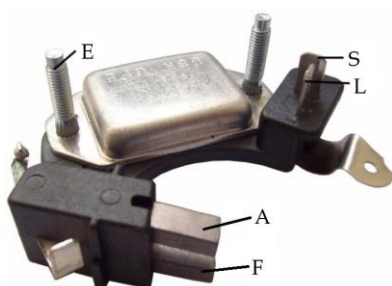

13521100 / 05-030

FEATURES

A-Circuit
Voltage Set Point 14.70 V

Original & X-References..

HITACHI	IR1Z-27
WAI	35-8100 35-8114
MOBILETRON	VR-H2000-31
CARGO	132432
TRANSPO	IH201

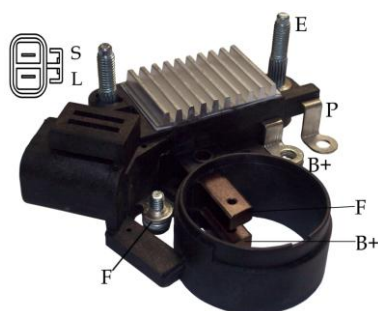

13501000 / 05-035

FEATURES

A-Circuit
Voltage Set Point 14.50 V
Soft Start 30 %
Field Shorted Circuit Protection
Sense Open Indication
Under Voltage Indication
Over Voltage Indication

Original & X-References..

HITACHI	LR170-502
MOBILETRON	VR-H2000-39

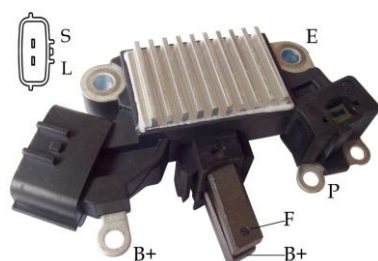

13501100 / 05-036

FEATURES

A-Circuit
Voltage Set Point 14.40 V
Soft Start 30 %
Field Shorted Circuit Protection
Under Voltage Indication
Over Voltage Indication
For use on:
1995-97 Nissan Maxima 3.0L
1998-99 Nissan Maxima SE 3.0L
1998-99 Nissan Maxima 130 3.0L

Original & X-References..

MOBILETRON	VR-H2000-46
CARGO	231534
TRANSPO	IH774

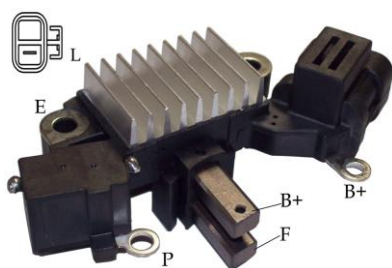

13501200 / 05-037

FEATURES

A-Circuit
Voltage Set Point **28.40 V**
Soft Start **30 %**
Field Shorted Circuit Protection
Under Voltage Indication
Over Voltage Indication

Original & X-References..

13501500 / 05-043

Voltage Set Point **14.40 V**

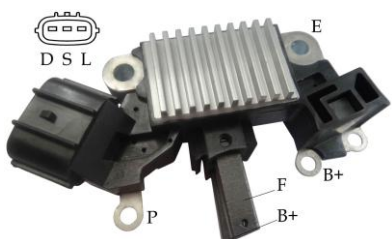

13501300 / 05-041

FEATURES

A-Circuit
Voltage Set Point **14.50 V**
Soft Start **30 %** LRC **5 sec**
Field Shorted Circuit Protection
Under Voltage Indication
Over Voltage Indication
DFM Function
Self exciting function
For use on: (2001) Subaru

Original & X-References..

MOBILETRON	VR-H2000-63
LESTER	13829
TRANSPO	IH742

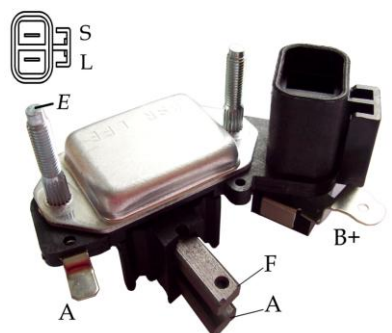

13522100 / 05-046

FEATURES

A-Circuit
Voltage Set Point **14.70 V**
With Capacitor

Original & X-References..

13520100 / 05-005

Voltage Set Point **28.50 V**

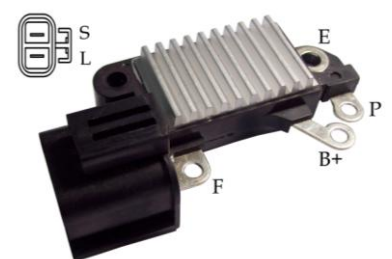

13510100 / 05-052

FEATURES

A-Circuit
Voltage Set Point **14.30 V**
Field Lamp Shorted Circuit Protection
Sense Open Indication
Under Voltage Indication
Over Voltage Indication

Original & X-References..

HITACHI	L180G-2340
NISSAN	23215-85L00
MOBILETRON	VR-H2000-16
USI	71-50004
WAI	35-8120
CARGO	135021
TRANSPO	IH761

Alternators: Hitachi LR165-708C,
LR170-738C,LR170-744,LR180-731B
Nissan 23100-OE700,23100-OE705

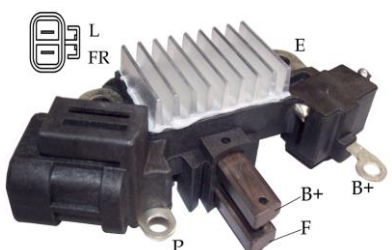

13501700 / 05-053

FEATURES

A-Circuit
Voltage Set Point **14.50 V**
Soft Start **30 %**
Field Shorted Circuit Protection
Under Voltage Indication
Over Voltage Indication

Original & X-References..

HITACHI	LR1100-508
LR1100-502MD	LR1100-508F
LESTER	23802
TRANSPO	IH669

13501800 / 05-054

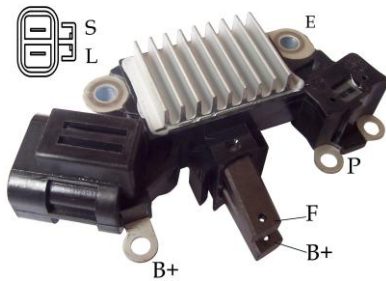

FEATURES

A-Circuit
 Voltage Set Point **14.40 V**
 Soft Start **30 %**
 Field Shorted Circuit Protection
 Under Voltage Indication
 Over Voltage Indication

Original & X-References..

HITACHI	L185G-5340
TRANSPO	IH744

For use on: 1999-2000 Honda
 Passport 3.2L 1999-2000 Isuzu Rodeo
 3.2L Mid 1998-2000 Isuzu Amigo 3.2L

13501900 / 05-055

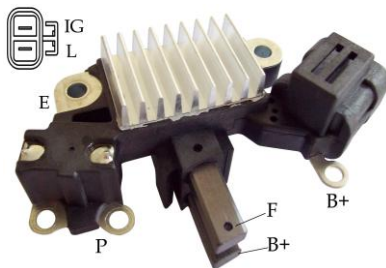

FEATURES

A-Circuit
 Voltage Set Point **14.40 V**
 Soft Start **30 %**
 Field Shorted Circuit Protection
 Under Voltage Indication
 Over Voltage Indication

Original & X-References..

HITACHI	L190G-5340
	23215-0W402
CARGO	234314
MOBILETRON	VR-H2000-43
TRANSPO	IH782

13531400 / 05-060



FEATURES

A-Circuit
 Voltage Set Point **28.10V**

Original & X-References..

HITACHI	27700-1370
	27700-1510
CARGO	133516
TRANSPO	IH708

For use on: Nissan
 Bus Truck & Industrial Hino

13522600 / 05-063

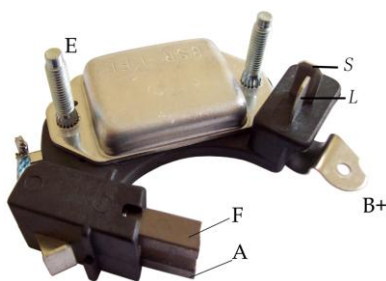

FEATURES

A-Circuit
 Voltage Set Point **28.40 V**

Original & X-References..

13502100 / 05-065

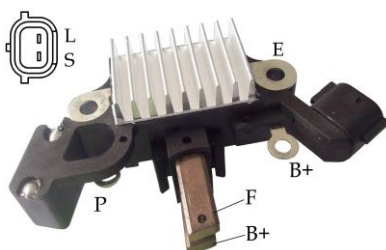

FEATURES

A-Circuit
 Voltage Set Point **14.40 V**
 Soft Start **30 %**
 Field Shorted Circuit Protection
 Under Voltage Indication
 Over Voltage Indication

Original & X-References..

HITACHI	LR170-760
LR170-767B	LR160-734B

05-066/ 13547800



FEATURES

A-Circuit
Voltage Set Point **14.70 V**

Original & X-References..

HITACHI	TR1Z-27	TR1Z-33
	TR1Z-47	TR1Z-48
MOBILETRON	VR-H2000-1	
CARGO	130834	
TRANSPO	IH210	

13523300 / 05-076

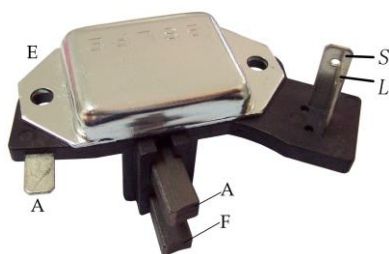

FEATURES

A-Circuit
Voltage Set Point **14.30 V**

Original & X-References..

HITACHI	L15043151
	L15063151
WAI	35-8134
CARGO	130832
BOSCH	0986192028
TRANSPO	IH203

13502300 / 05-083

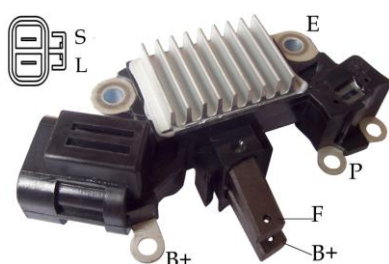

FEATURES

A-Circuit
Voltage Set Point **28.40 V**
Soft Start **30 %**
Field Shorted Circuit Protection
Sense Open Indication
Under Voltage Indication
Over Voltage Indication

Original & X-References..

HITACHI	LR250-708E
	898075-0260

13510200 / 05-088

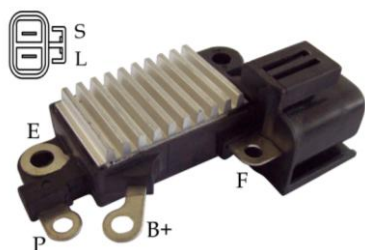

FEATUERS

A-Circuit
Voltage Set Point **14.30 V**
Field Lamp Shorted Circuit Protection
Sense Open Indication
Under Voltage Indication
Over Voltage Indication

Original & X-References..

HITACHI	L180-5340
	L180G-5340
USI	71-50003
CARGO	135022
WAI	35-8123
TRANSPO	IH762

Alternators: Hitachi LR165-708C,
LR170-738C,LR170-744,LR180-731B
Nissan 23100-OE700,23100-OE705

13502700 / 05-091

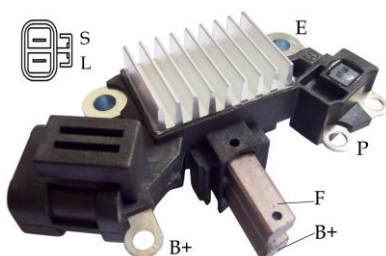

FEATUERS

A-Circuit
Voltage Set Point **14.40 V**
Soft Start **30 %**
Field Lamp Shorted Circuit Protection
Under/ Over Voltage Indication

Original & X-References..

HITACH	LR1110-712
LESTER	13900

13502900 / 05-095

Voltage Set Point **28.40 V**
Field Shorted Circuit Protection
Sense Open Indication

13503000 / 05-096

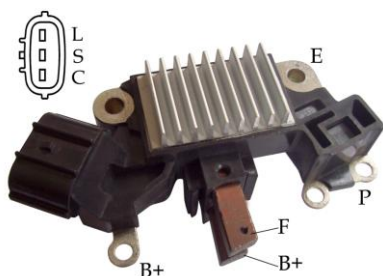

FEATUERS

A-Circuit
 Voltage Set Point **14.30 V**
 Soft Start **26 %**
 LRC **4 sec**
 Vset of "C" is controlled by duty cycle

Original & X-References..

HITACH	LR1110-724	-724B
	LR1110-725	-725B
LESTER	11119	11121
TRANSPO		IH741

13510300 / 05-097

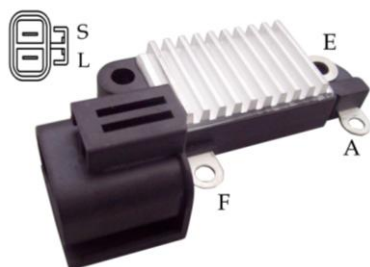

FEATUERS

A-Circuit
 Voltage Set Point **14.60 V**

Original & X-References..

HITACH	L170-33152
NISSIAN	23215-50Y05
MOBILETRON	VR-H2000-14
WAI	35-8119
TRANSPO	IH760

13503100 / 05-099

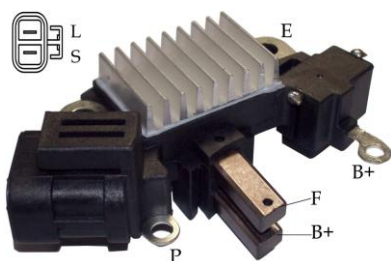

FEATURES

A-Circuit
 Voltage Set Point **14.40 V**
 Soft Start **30 %**
 Field Shorted Circuit Protection
 Sense Open Indication
 Under Voltage Indication
 Over Voltage Indication

Original & X-References..

HITACH	21505-10753
--------	-------------

13503200 / 05-100

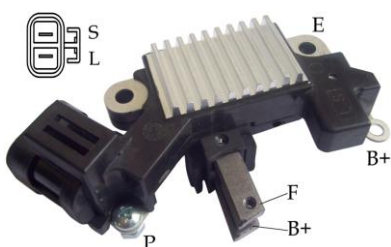

FEATURES

A-Circuit
 Voltage Set Point **14.40 V**

Original & X-References..

13510400 / 05-101

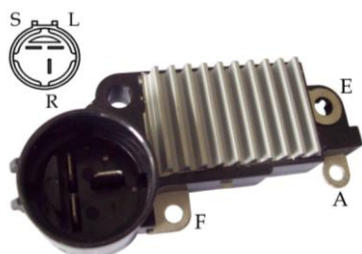

FEATURES

A-Circuit
 Voltage Set Point **14.50 V**

Original & X-References..

CARGO	232442
WAI	35-8125
TRANSPO	IH251

For use on:
 HONDA ISUZU PICKUP

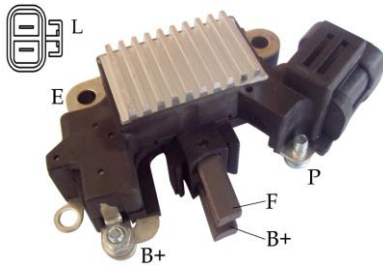

13503300 / 05-103

FEATURES

A-Circuit
 Voltage Set Point **28.25 V**
 Soft Start **30 %**
 Lamp Shorted Circuit Protection
 Under Voltage Indication
 Over Voltage Indication

Original & X-References..

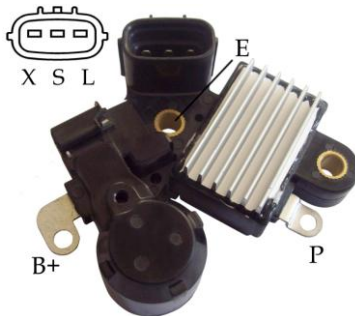

13503700 / 05-107

FEATUERS

A-Circuit
 Voltage Set Point **14.45 V**
 Soft Start **30 %**
 Field Lamp Shorted Circuit Protection
 Under Voltage Indication
 Over Voltage Indication

Original & X-References..

For use on: NISSAN TIIDA

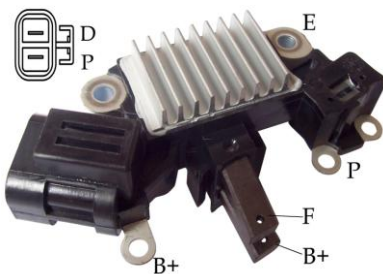

13503900 / 05-109

FEATURES

PD Regulator

Original & X-References..

HITACHI	LR170-758
MOBILETRON	VR-H2000-51
LESTER	13788
TRANSPO	IH758

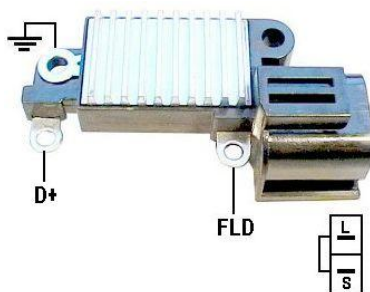

13510600 / 05-110

FEATURES

A-Circuit
 Voltage Set Point **14.30 V**

Original & X-References..

HITACHI	L180-8315
CARGO	135158
MOBILETRON	VR-H2000-17
USI	71-50002
WAI	35-8116
TRANSPO	IH248



13504000 / 05-111

FEATURES

A-Circuit
 Voltage Set Point **14.30 V**
 Soft Start **26 %**
 LRC **4 sec**
 Vset of "C" is controlled by duty cycle

Original & X-References..

13504100 / 05-112

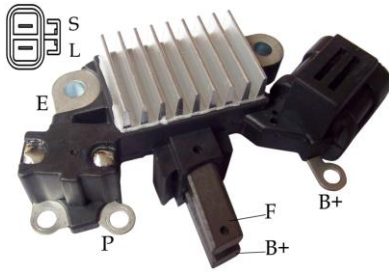

FEATURES

A-Circuit
 Voltage Set Point **14.40 V**
 Soft Start **30 %**
 LRC **10 sec**
 Field Shorted Circuit Protection
 Under Voltage Indication
 Over Voltage Indication

Original & X-References..

MOBILETRON	VR-H2000-45
LESTER	13937
TRANSPO	IH737

For use on: NISSAN SENTRA 180

13504200 / 05-113

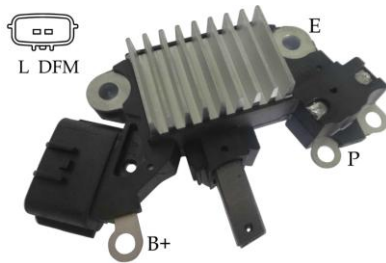

FEATURES

A-Circuit
 Voltage Set Point **14.30 V**
 Soft Start **30 %**
 LRC **5 sec**
 Field Shorted Circuit Protection
 Under Voltage Indication
 Over Voltage Indication

Original & X-References..

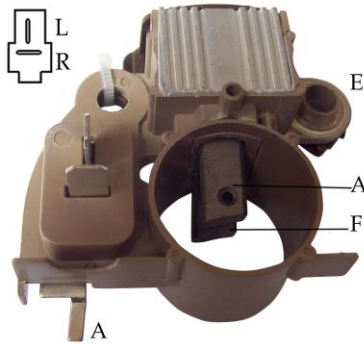

13600100 / 06-001

FEATURES

A-Circuit
Voltage Set Point **14.70 V**

Original & X-References..

MITSUBISHI	
A866X04870	A866X04871
A866X04872	A866X05470
A866X05471	A866X05472
A866X06072	E35618W70
MD611032	MD611146
MOBILETRON	VR-H2009-4H
TRANSPO	IM216HD

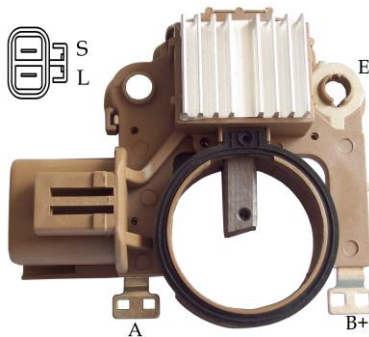

13600200 / 06-002

FEATURES

A-Circuit
Voltage Set Point **14.50V**

Original & X-References..

MITSUBISHI	A 866X25572
	MD618735
	MD619167
MOBILETRON	VR-H2009-67
CARGO	137075
TRANSPO	IM847

13605400 / 06-086

Voltage Set Point **28.50 V**

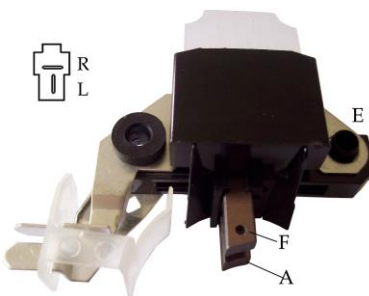

13610100 / 06-003

FEATURES

A-Circuit
Voltage Set Point **28.50 V**

Original & X-References..

For use on: Chrysler, Hyundai, Mazda, Mitsubishi

MITSUBISHI	
A866X04872	A866X05471
A866X05472	E35618W70
MD611032	MD611146
MOBILETRON	VR-H2009-12
WAI	35-8301
CARGO	131517
TRANSPO	IM213HD

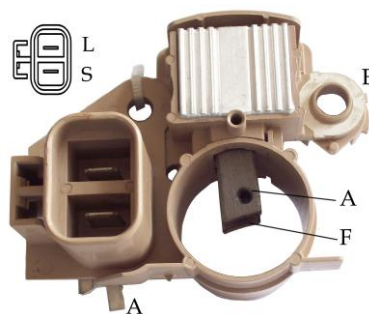

13600300 / 06-004

FEATURES

A-Circuit
Voltage Set Point **14.50V**

Original & X-References..

For use on: Nissan, Dodge

MITSUBISHI	
A866X05272	A866X09071
A866X09072	A866X09771
A866X09782	MD611432
MOBILETRON	VR-H2009-6H
WAI	35-8302
TRANSPO	IM217HD

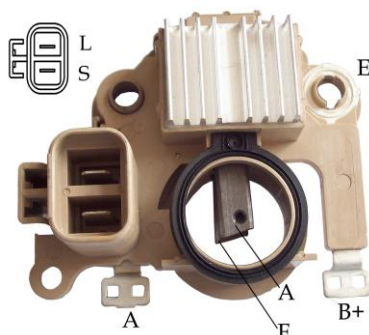

13600500 / 06-006

FEATURES

A-Circuit
Voltage Set Point **14.50V**

Original & X-References..

For: Mitsubishi IR/IF Alternators

MITSUBISHI	A866X22272
MOBILETRON	VR-H2009-38
WAI	35-8339
LESTER	12311 13430
13439 13450	13596 13597
CARGO	136649
TRANSPO	IM222

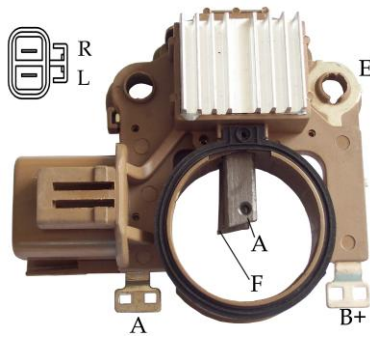

13600700 / 06-008

FEATURES

A-Circuit
Voltage Set Point **28.70V**

Original & X-References..

MITSUBISHI	A866X28372
	ME701399
MOBILETRON	VR-H2009-80B
CARGO	234304
TRANSPO	IM846

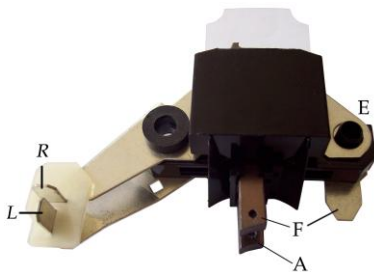

13610300 / 06-009

FEATURES

A-Circuit
Voltage Set Point **14.60 V**

Original & X-References..

MITSUBISHI	A866T03070	A866T1827
	A866T03470	MD618302
	MD607619	

13611900 / 06-064

Voltage Set Point **28.50 V**

MOBILETRON	VR-H2009-18
WAI	35-8304
CARGO	131290
TRANSPO	IM205

For use on: Chrysler D50 Diesel
Pick-Up

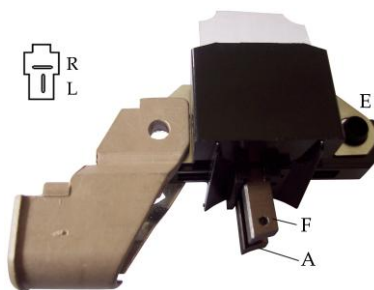

13610500 / 06-011

FEATURES

A-Circuit
Voltage Set Point **28.50 V**

Original & X-References..

MITSUBISHI	A866T06870
	ME700635
MOBILETRON	VR-H2009-47
CARGO	137396
TRANSPO	IM212

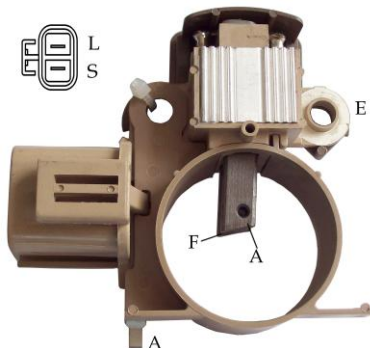

13601000 / 06-013

FEATURES

A-Circuit
Voltage Set Point **14.50 V**

Original & X-References..

MITSUBISHI	A866X09171
	MD611481
MOBILETRON	VR-H2009-28
WAI	35-8355
CARGO	131471
TRANSPO	IM281

For use on: Mitsubishi Pajero 2500
Diesel, Delica 2300 Van Diesel, Mirage
1800 Diesel, Galant 1800 Diesel, Sava
1800 Diesel, Shariot 1800 Diesel

13606800 / 06-105

Voltage Set Point **28.50 V**

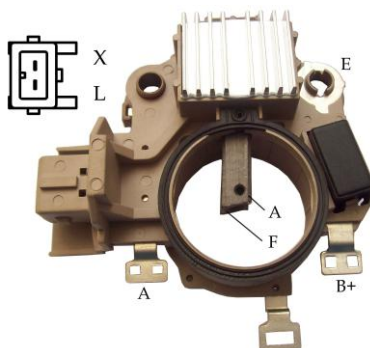

13601100 / 06-014

FEATURES

A-Circuit
Voltage Set Point **14.40 V**

Original & X-References..

MITSUBISHI	A866X40371
MOBILETRON	VR-H2009-82
CARGO	230985
TRANSPO	IM757

For use on: Ford Transit Unit
A3TN1791

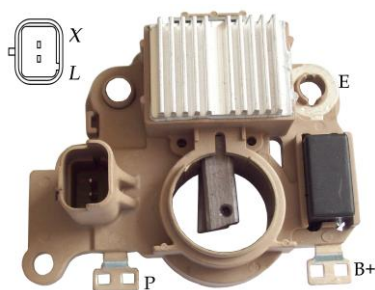

13601300 / 06-016

FEATURES

A-Circuit
Voltage Set Point **14.50 V**
Field Shorted Circuit Protection
Over Voltage Indication
Without Trio Diode Application

Original & X-References..

ALTERNATOR REFERENCES	
AZTB6481	
CARGO	CA1652IR

For use on: Renault 2001-01 Clio II 1.5L

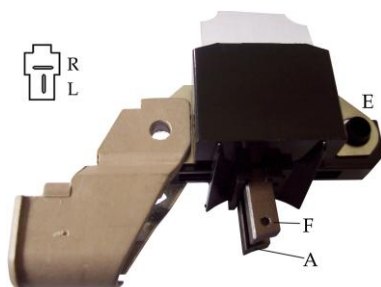

13610700 / 06-018

FEATURES

A-Circuit
Voltage Set Point **14.60 V**

Original & X-References..

MITSUBISHI	A866T08570
	ME700556
MOBILETRON	VR-H2009-46
WAI	35-8344
TRANSPO	IM208

For use on: Fuso Trucks

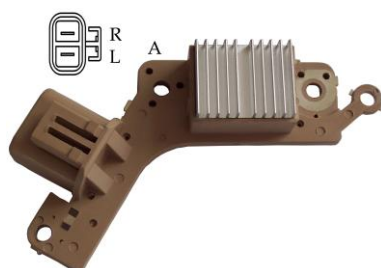

13660100 / 06-019

FEATURES

A-Circuit
Voltage Set Point **28.60 V**

Original & X-References..

For use on: Mitsubishi
Motors Industrial
Fuso Large Truck

MITSUBISHI	A866X26070
	A866X26072
	ME701302
MOBILETRON	VR-H2009-77
TRANSPO	IM843

13660200 / 06-026

Voltage Set Point **14.80 V**

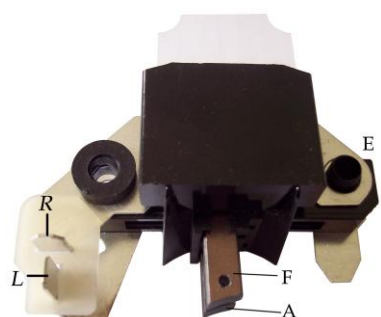

13610900 / 06-020

FEATURES

A-Circuit
Voltage Set Point **14.60 V**

Original & X-References..

For use on: Chrysler

MITSUBISHI	
A866T00470	A866T00670
A866T01970	A866T02770
MOBILETRON	VR-H2009
WAI	35-8300
CARGO	130835
TRANSPO	IM204

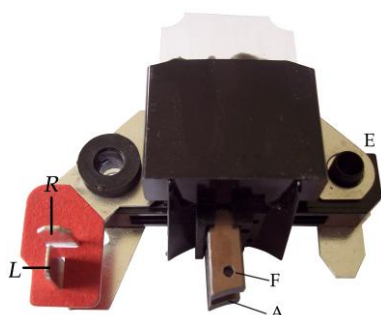

13611300 / 06-027

FEATURES

A-Circuit
Voltage Set Point **28.50 V**

Original & X-References..

MITSUBISHI	A866T02070
MOBILETRON	VR-H2009-21
CARGO	137397
TRANSPO	IM203

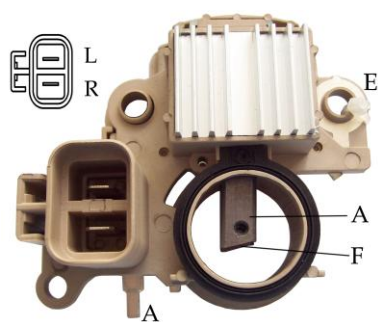

13601500 / 06-028

FEATURES

A-Circuit
Voltage Set Point **14.40 V**

Original & X-References..

KIA	37370-02500
	37370-21330
	37370-24510
VALEO	TA500C0041
CARGO	234286

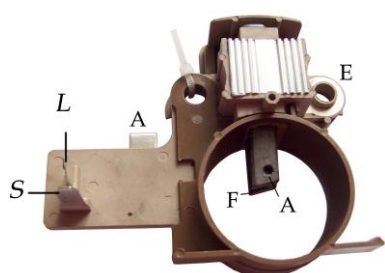

13601600 / 06-029

FEATURES

A-Circuit
Voltage Set Point **14.50 V**

Original & X-References..

KIA	37300-42000
	37340-42540
MOBILETRON	VR-MD01
TRANSPO	IY422

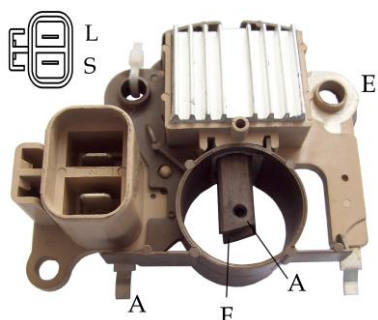

13601700 / 06-030

FEATURES

A-Circuit
Voltage Set Point **14.50V**

Original & X-References..

MITSUBISHI	A866X00170
	A866X17072
MOBILETRON	VR-H2009-33
WAI	35-8324
CARGO	135032
TRANSPO	IM280

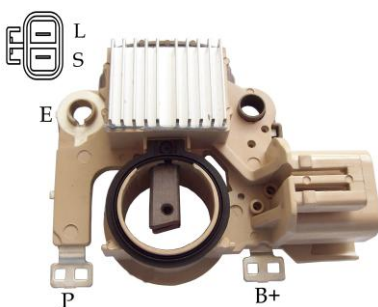

13601800 / 06-031

FEATURES

A-Circuit
Voltage Set Point **14.40 V**
Sense Open Indication
Under Voltage Indication
Over Voltage Indication

Original & X-References..

MITSUBISHI	
	A002T33493A
	A002T35791
	A2T82491
MOBILETRON	VR-H2009-45
WAI	35-8343
CARGO	137182
TRANSPO	IM292

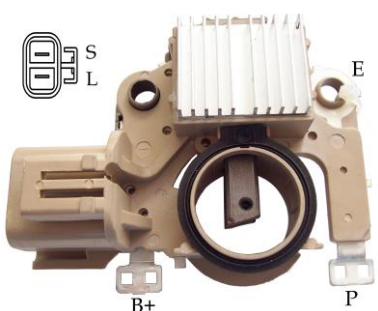

13601900 / 06-032

FEATURES

A-Circuit
Voltage Set Point **14.40 V**
Sense Open Indication
Under Voltage Indication
Over Voltage Indication

Original & X-References..

MITSUBISHI	
	A866X20472
	B64J18W70A
MOBILETRON	VR-H2009-22
WAI	35-8333
CARGO	135233
TRANSPO	IM830

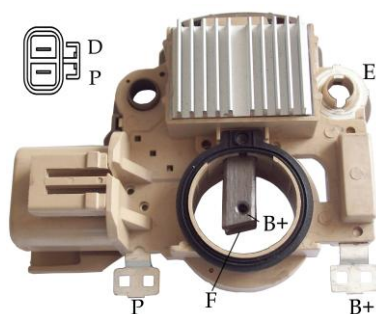

1360200 / 06-034

FEATURES

Original & X-References..

MITSUBISHI	A866X35472
MOBILETRON	VR-H2009-95
CARGO	138872
TRANSPO	IM345

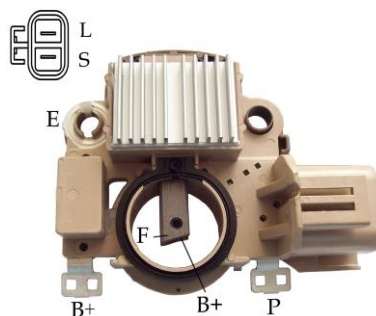

13602100 / 06-035

FEATURES

Original & X-References..

A-Circuit
 Voltage Set Point **14.40 V**
 Soft Start **30 %**
 LRC **5 Sec**
 Field Shorted Circuit Protection
 Sense Open Indication
 Under Voltage Indication
 Over Voltage Indication

MITSUBISHI	A866X36272
MOBILETRON	VR-H2009-118
CARGO	230043
TRANSPO	IM362

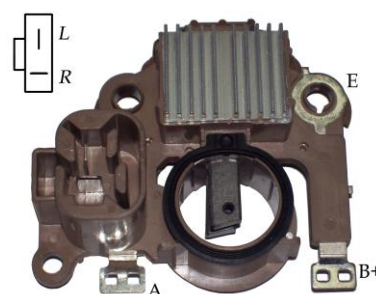

13602200 / 06-036

FEATURES

Original & X-References..

A-Circuit
 Voltage Set Point **14.40 V**

MITSUBISHI	A866X26172
	MD618845
MOBILERON	VR-H2009-63
CARGO	138309
TRANSPO	IM290

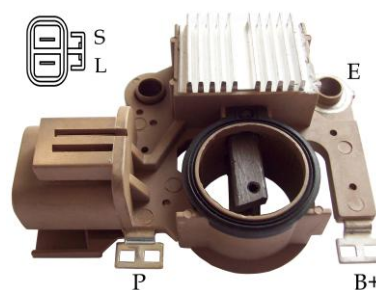

13602300 / 06-037

FEATURES

Original & X-References..

A-Circuit
 Voltage Set Point **14.40V**
 Soft Start **30 %**
 LRC **5 Sec**
 Field Shorted Circuit Protection
 Sense Open Indication
 Under Voltage Indication
 Over Voltage Indication

MITSUBISHI	A866X34272
LESTER	11096
TRANSPO	IM342

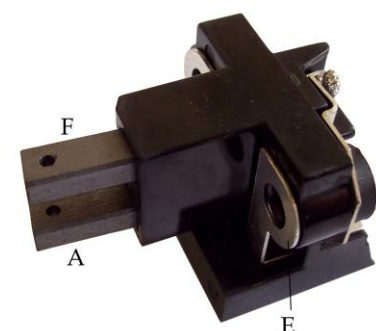

13340600 / 06-039

FEATURES

Original & X-References..

A-Circuit
 Voltage Set Point **28.50 V**

MITSUBISHI	A866 T 01070
	A866 X 01070
	ME700091
WAI	35-8328
CARGO	131518
TRANSPO	IM215

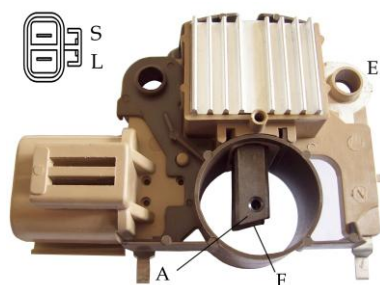

13602400 / 06-041

FEATURES

A-Circuit
Voltage Set Point **14.50V**

Original & X-References..

MITSUBISHI	A866X14570
MOBILETRON	VR-H2009-26
WAI	35-8326
CARGO	134088
TRANSP0	IM278

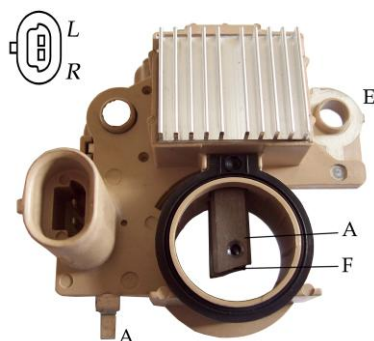

13602500 / 06-043

FEATURES

A-Circuit
Voltage Set Point **14.40 V**

Original & X-References..

CARGO	235205
-------	--------

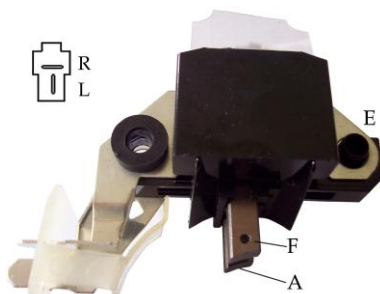

13611500 / 06-044

FEATURES

A-Circuit
Voltage Set Point **14.60 V**

Original & X-References..

MITSUBISHI	A 00522578
MOBILETRON	VR-H2009-48
UNIPOINT	YR-562
WAI	35-8360
TRANSP0	IM207

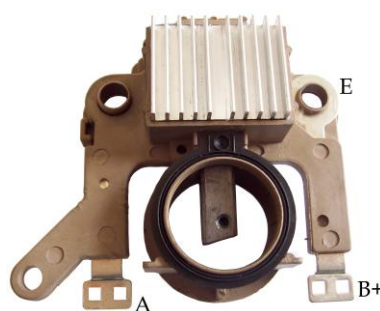

13602700 / 06-046

FEATURES

A-Circuit
Voltage Set Point **14.80 V**

Original & X-References..

MITSUBISHI	A 2T2094B
MOBILETRON	VR-H2009-58

13602600 / 06-045

A-Circuit
Voltage Set Point **14.40 V**

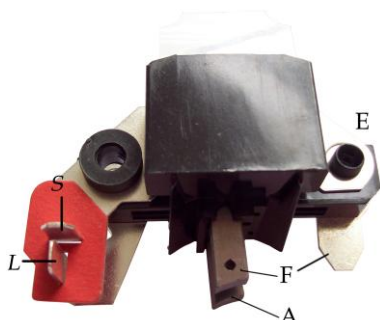

13611700 / 06-049

FEATURES

A-Circuit
Voltage Set Point **14.50V**

Original & X-References..

MITSUBISHI	A866T00870
	A866T02270
	A866T02970
MOBILETRON	VR-H2009-3
CARGO	131289
TRANSP0	IM225

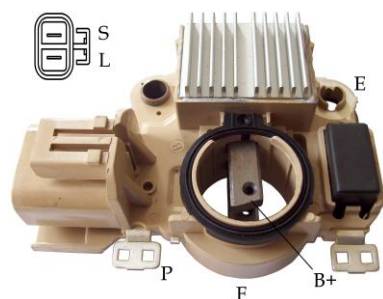

13602800 / 06-050

FEATURES

A-Circuit
 Voltage Set Point **14.40V**
 Soft Start **30 %** LRC **5 Sec**
 Field Shorted Circuit Protection
 Sense Open Indication
 Under / Over Voltage Indication

Original & X-References..

MITSUBISHI	A866X7672
MOBILETRON	VR-H2009-99
LESTER	11051
TRANSPO	IM476

13603800 / 06-063

Without Sense Open Indication, Others Function are the same as 06-050

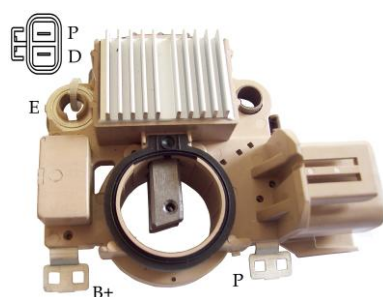

13602900 / 06-051

FEATURES

P D Terminals

Original & X-References..

MITSUBISHI	A866X46572
	GY0118W70
	A3TG0081
MOBILETRON	VR-H2009-100
TRANSPO	IM465

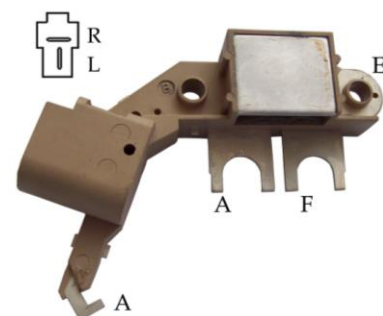

13660300 / 06-052

FEATURES

A-Circuit
 Voltage Set Point **28.70 V**

Original & X-References..

MITSUBISHI	A866X08871	A866X19972
	ME7000783	ME701196
MOBILETRON		VR-H2009-69B
TRANSPO		IM286

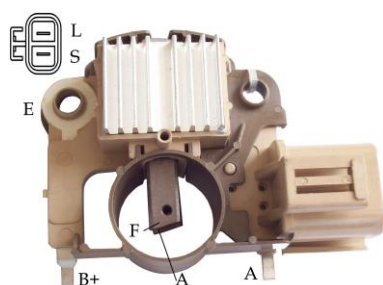

13603000 / 06-053

FEATURES

A-Circuit
 Voltage Set Point **14.50V**

Original & X-References..

MITSUBISHI	A866X17470
	A866X21472
	A866X13272
	A866X15170
CARGO	135030
TRONSPO	IM284 IM271

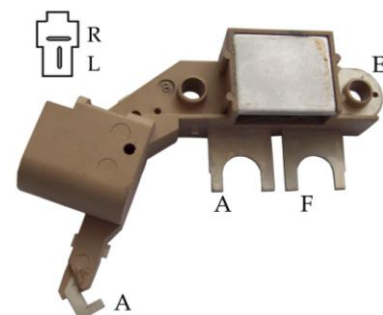

13660400 / 06-055

FEATURES

A-Circuit
 Voltage Set Point **14.80V**

Original & X-References..

MITSUBISHI	A866X08971
	A866X23972
	ME7000799
	ME701260
MOBILETRON	VR-H2009-69
TRANSPO	IM294

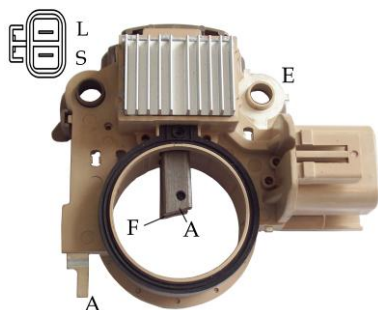

13603200 / 06-056

FEATURES

A-Circuit
Voltage Set Point **14.50V**

Original & X-References..

ALTERNATOR REFERENCES
HYUNDAI 3730042451
MANDO AF175363

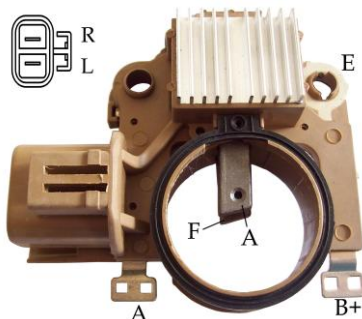

13603400 / 06-059

FEATURES

A-Circuit
Voltage Set Point **28.65 V**

Original & X-References..

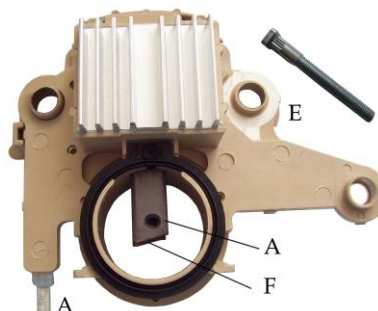

13603500 / 06-060

FEATURES

A-Circuit
Voltage Set Point **14.50V**

Original & X-References..

13605700 / 06-089

With B+ Bolt

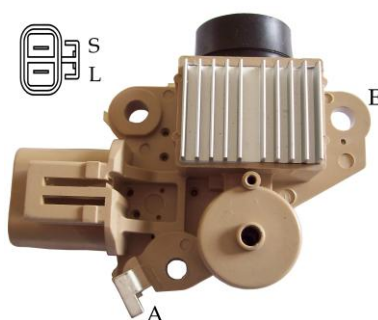

13603900 / 06-065

FEATURES

A-Circuit
Voltage Set Point **A 14.50V**

Original & X-References..

VALEO 231425
CARGO 231425
MOBILETRON VR-MD07
TRANSPO IY094

For use on : Alternators Mando
AB170094 OK2A218300

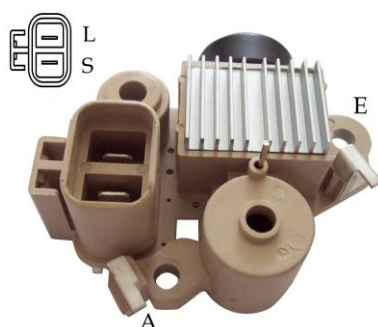

13604000 / 06-066

FEATURES

A-Circuit
Voltage Set Point **14.50V**

Original & X-References..

HYUNDAI 37370-22600
MADNO TA500-C09001
MOBILETRON VR-MD06
TRANSPO IY028

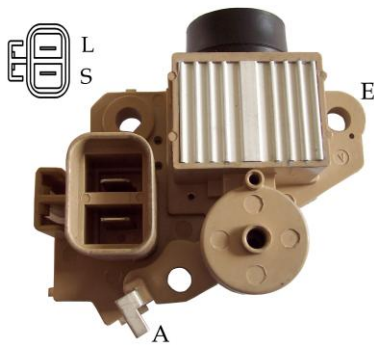

13604100 / 06-067

FEATURES

A-Circuit
Voltage Set Point **14.50V**

For use on : Alternators
3730022200 AB190058

Original & X-References..

HYUNDAI	37300-22200
MOBILETRON	VR-H2009-86
CARGO	138204
TRANSPO	IY058



13640100 / 06-068

FEATURES

A-Circuit
Voltage Set Point **14.50V**

Original & X-References..

KIA	62124520
-----	----------



13640200 / 06-069

FEATURES

A-Circuit
Voltage Set Point **14.50V**

Original & X-References..

KIA	055318300B
-----	------------



13640300 / 06-070

FEATURES

A-Circuit
Voltage Set Point **14.80V**

Original & X-References..

POONG SUNG	02121-8207
	02121-9012
	121500-0011
MOBILETRON	VR-K01
CARGO	139469
TRANSPO	PG101

13640400 / 06-079

A-Circuit
Voltage Set Point **28.60V**

KIA	K61A-24-520
MOBILETRON	VR-K01B
TRANSPO	PG133

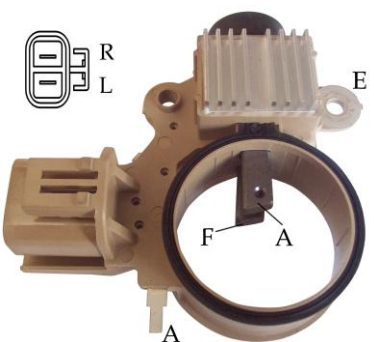

13604200 / 06-072

FEATURES

A-Circuit
Voltage Set Point **28.65V**

Original & X-References..

HYUNDAI	37300-41701
---------	-------------

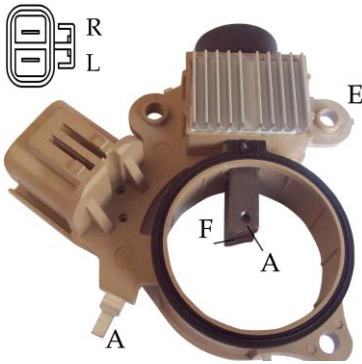

13604300 / 06-073

FEATURES

A-Circuit
Voltage Set Point 28.65V

Original & X-References..

HYUNDAI AC270542
37300-9300

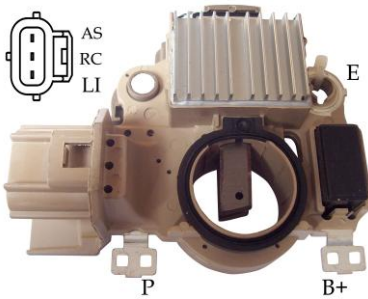

13604400 / 06-074

FEATURES

A-Circuit
RC=0 $V_s=13.50V$
RC=55% $V_s=14.25V$
AS-RC-LI Terminals

Original & X-References..

MITSUBISHI A866X50372
MOBILETRON VR-H2009-102
CARGO 331005 235843
TRANSPO IM503

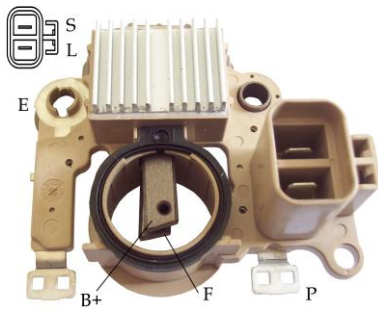

13604500 / 06-075

FEATURES

A-Circuit
Voltage Set Point 14.50 V
Soft Start 30 %
LRC 5 sec
Field Lamp Shorted Circuit Protection
Under Voltage Indication
Over Voltage Indication

Original & X-References..

MITSUBISHI A3TB1999
A3TA6098A

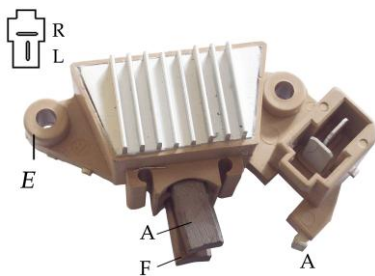

13604800 / 06-078

FEATURES

A-Circuit
Voltage Set Point 14.60V

Original & X-References..

TRANSPO IY510

For use on : KIA TICO

13605200 / 06-084

A-Circuit
Voltage Set Point 28.60V

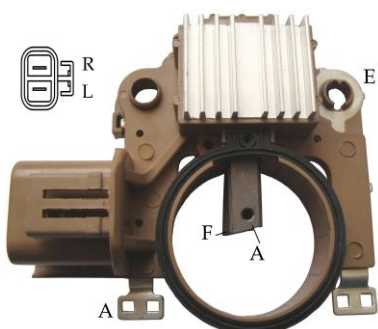

13604900 / 06-080

FEATURES

A-Circuit
Voltage Set Point 14.80V

Original & X-References..

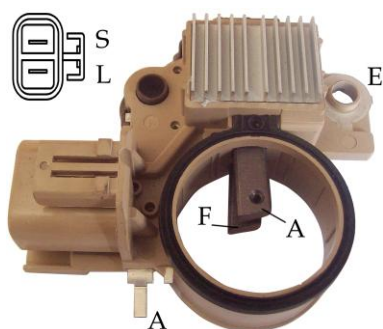

13605000 / 06-081

FEATURES

A-Circuit
Voltage Set Point 14.50V

Original & X-References..

HYUNDAI	37370-47301
	IVR408
TRANSPO	IY702

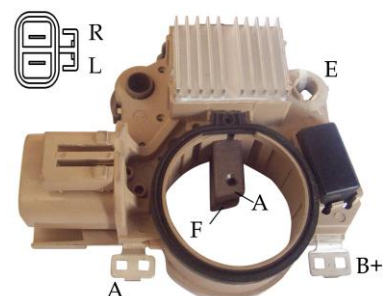

13605100 / 06-082

FEATURES

A-Circuit
Voltage Set Point 28.65V

Original & X-References..

MITSUBISHI	A866X28372
CARGO	234304

13606100 / 06-094

Voltage Set Point 28.70V

13606600 / 06-103

Voltage Set Point 14.80V

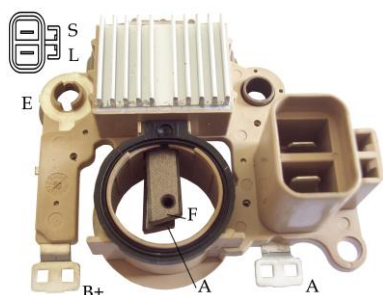

13605300 / 06-085

FEATURES

A-Circuit
Voltage Set Point 14.40V
Sense Open Indication
Under Voltage Indication
Over Voltage Indication

Original & X-References..

MITSUBISHI	A866X27572
	ME701363
CARGO	139110
TRANSPO	IM854

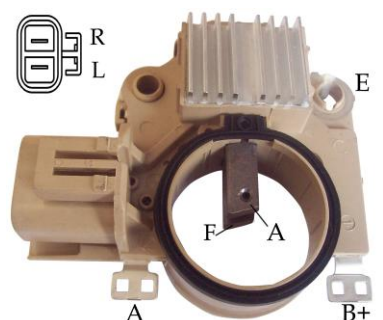

13605400 / 06-086

FEATURES

A-Circuit
Voltage Set Point 28.50 V

Original & X-References..

28241239

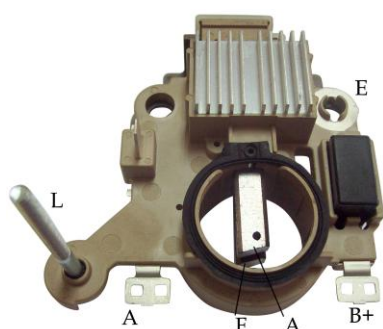

13605500 / 06-087

FEATURES

A-Circuit
Voltage Set Point 14.30V

Original & X-References..

MOBILETRON	VR-H2009-153
TRANSPO	IM518

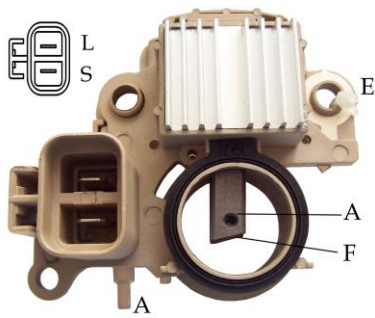

13605600 / 06-088

FEATURES

A-Circuit
Voltage Set Point **14.50 V**

Original & X-References..

MITSUBISHI	A866T09780
	A866T09782
MOBILETRON	VR-H2009-78
LSTER	13289
TRANSP0	IM831

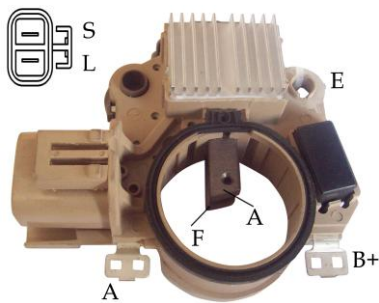

13605800 / 06-090

FEATURES

A-Circuit
Voltage Set Point **14.50V**

Original & X-References..

MITSUBISHI	A866X41072
CARGO	235541

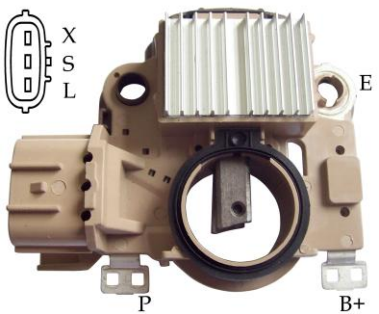

13605900 / 06-092

FEATURES

A-Circuit
Voltage Set Point **14.40 V**
Soft Start **30 %**
LRC **5 Sec**
Field Shorted Circuit Protection
Sense Open Indication
Under Voltage Indication
Over Voltage Indication

Original & X-References..

MITSUBISHI	A2TB2891
	A2TB2991
SUBARU	23815-AA140
MOBILETRON	VR-H2009-107
CARGO	235102
TRANSP0	IM848

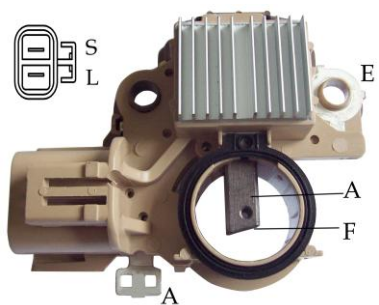

13606000 / 06-093

FEATURES

A-Circuit
Voltage Set Point **14.50 V**

Original & X-References..

MOBILETRON	VR-H2009-116
MANDO	AB170036
KIA	OK201-18-300B
TRANSP0	IY794

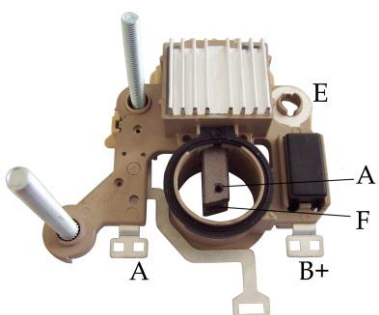

13650100 / 06-095

FEATURES

A-Circuit
Voltage Set Point **28.35 V**

Original & X-References..

MITSUBISHI	A0037A859
------------	-----------

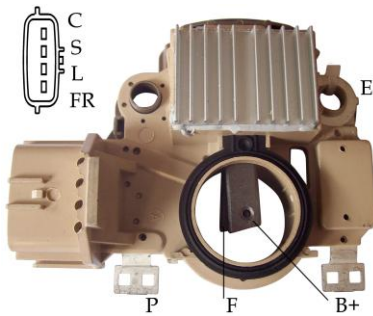

13606200 / 06-096

FEATURES

A-Circuit
 Voltage Set Point **14.60 V**
 Soft Start **30 %**
 Field, Lamp Shorted Circuit Protection
 Sense Loss Indication
 Under Voltage Indication
 Over Voltage Indication
 DFM function

Original & X-References..

MITSUBISHI	A866X34172
MOBILETRON	VR-H2009-70A
CARGO	138340
TRANSP0	IM341

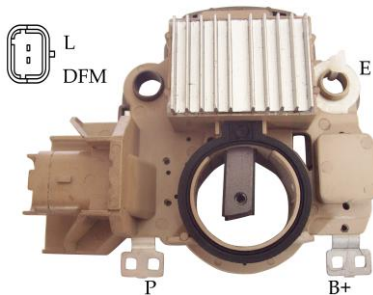

13606300 / 06-097

FEATURES

A-Circuit
 Voltage Set Point **14.50 V**
 Soft Start **30 %**
 LRC **5 sec**
 Field, Lamp Shorted Circuit Protection
 Under Voltage Indication
 Over Voltage Indication
 DFM function

Original & X-References..

MITSUBISHI	A866X49872
MOBILETRON	VR-H2009-105
TRANSP0	IM498



13606400 / 06-098

FEATURES

A-Circuit
 Voltage Set Point **28.50 V**
 Soft Start **30 %**
 Field, Lamp Shorted Circuit Protection
 IG Open Indication
 Sense Loss Indication
 Under Voltage Indication
 Over Voltage Indication

Original & X-References..

MITSUBISHI	A4TA8191
LESTER	20921
TRANSP0	IM691

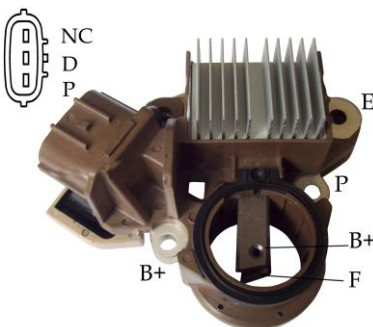

13620100 / 06-100

FEATURES

Works with PCM
 Traditional test method will immediately damage P-D

Original & X-References..

MITSUBISHI	A866X50572
MOBILETRON	VR-H2009-114
TRANSP0	IM505

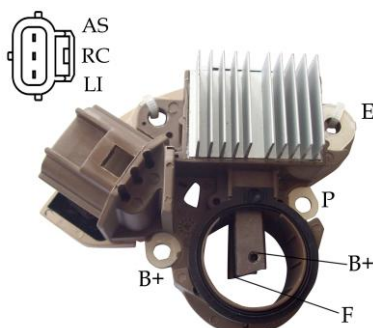

13620200 / 06-101

FEATURES

A-Circuit
 RC=0 $V_s=13.50V$
 RC=55% $V_s=14.25V$

Original & X-References..

MITSUBISHI	A866T52970
MOBILETRON	VR-H2009-98
TRANSP0	IM529

PCM Regulator

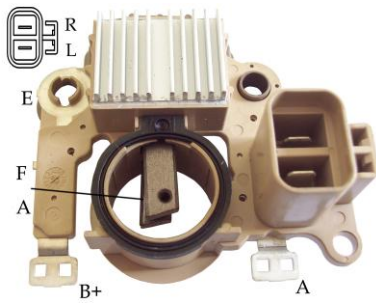

13606500 / 06-102

FEATURES

A-Circuit
Voltage Set Point **28.70 V**

Original & X-References..

MITSUBISHI	ME108147
	A003TA8199
LESTER	20059

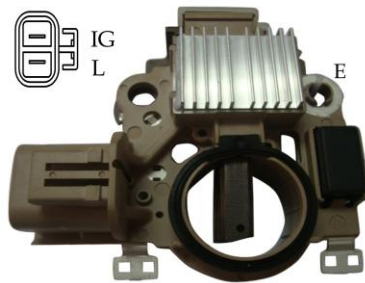

13606900 / 06-106

FEATURES

A-Circuit
Voltage Set Point **28.50 V**

Original & X-References..

MITSUBISHI	ME192607
	MITA3TN5188

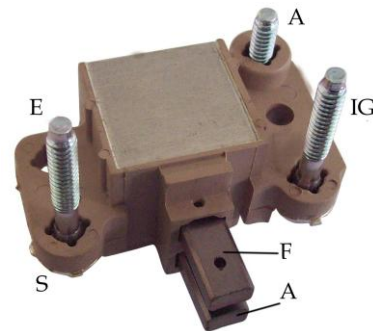

13650200 / 06-107

FEATURES

A-Circuit
Voltage Set Point **14.60 V**

Original & X-References..

MOBILETRON	VR-H2009-75
TRANSPO	IM288
CARGO	136742

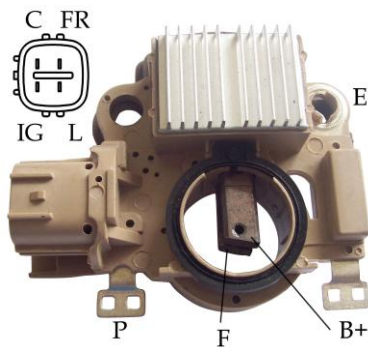

13607000 / 06-108

FEATURES

A-Circuit
Voltage Set Point **14.60 V**
Soft start
LRC **5 sec**
Stator activated

Original & X-References..

HONDA	31150-PLC-004
MITSUBISHI	A866X48782
LESTER	13893 13966
MOBILETRON	VR-H2009-94
TRANSPO	IM851

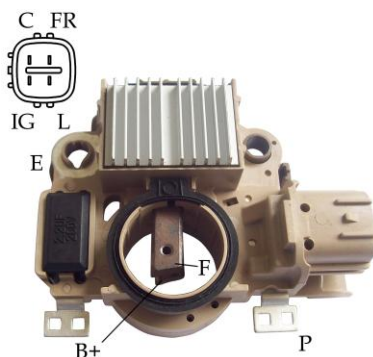

13607100 / 06-109

FEATURES

A-Circuit
Voltage Set Point **14.60 V**
Soft start
LRC **5 sec**
Stator activated

Original & X-References..

MOBILETRON	VR-H2009-113
TRANSPO	IM558

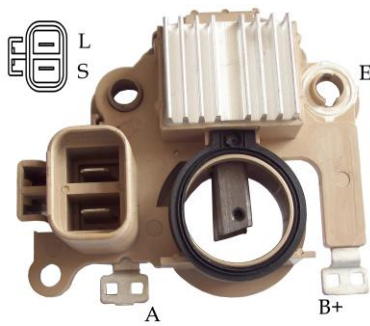

13607200 / 06-110

FEATURES

A-Circuit
Voltage Set Point **14.50V**

For: Mitsubishi IR/IF Alternators

Original & X-References..

MITSUBISHI	A002T34892
	A866X23172
MOBILETRON	VR-H2009-37
WAI	35-8336
TRANSP0	IM832

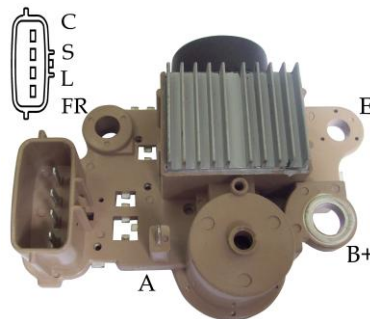

13620300 / 06-111

FEATURES

A -Circuit
Voltage Set Point **14.50 V**
DFM function

Original & X-References..

MANDO	TA500C07101
MOBILETRON	VR-H2009-106
TRANSP0	IY126

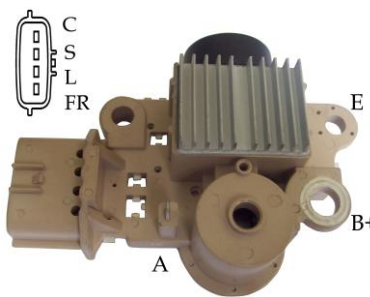

13620400 / 06-112

FEATURES

A -Circuit
Voltage Set Point **14.50 V**
DFM function

Original & X-References..

LESTER	13967
TRANSP0	IY146

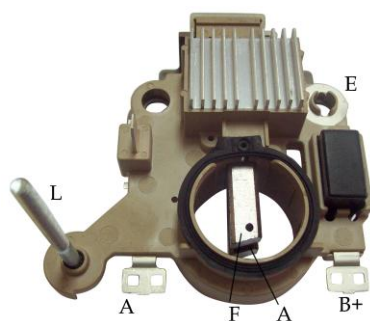

13650300 / 06-113

FEATURES

A-Circuit
Voltage Set Point **28.35 V**

Original & X-References..

MITSUBISHI	A4TR5188
------------	----------

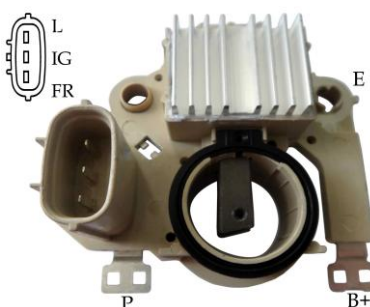

13607300 / 06-114

FEATURES

A-Circuit
Voltage Set Point **14.70 V**
Under Voltage Indication

Original & X-References..

MOBILETRON	VR-H2009-62
MITSUBISHI	A866X31882
TRANSP0	IM318

For use on: Honda

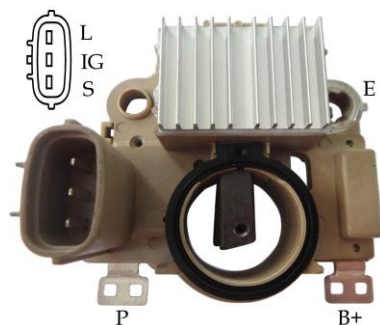

13607400 / 06-115

FEATURES

A-Circuit
 Voltage Set Point **28.50 V**
 Soft Start **30 %**
 IG / Sense Open Indication
 L Terminal Drives Choke
 Under/ Over Voltage Indication

Original & X-References..

MOBILETRON	VR-H2009-135B
CARGO	238949

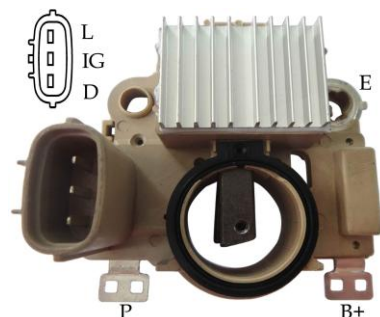

13607500 / 06-116

FEATURES

A-Circuit
 Voltage Set Point **14.70 V**
 Soft Start **30 %**
 LRC **5 sec**
 Field Lamp Shorted Circuit Protection
 Under/ Over Voltage Indication

Original & X-References..

MITSUBISHI	A866X42572
MOBILETRON	VR-H2009-90
TRANSP0	IM381

For use on: Chev Tracker, Suzuki Vitara

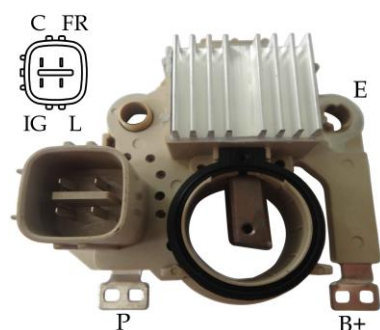

13607600 / 06-117

FEATURES

A-Circuit
 Voltage Set Point **14.50 V**
 Under Voltage Indication

Original & X-References..

HONDA	31150-P2E-A01
MOBILETRON	VR-H2009-71
CARGO	230260
USI	71-60037
LESTER	13649 13762
TRANSP0	IM850

For use on: Honda

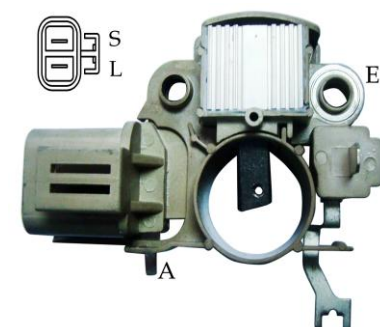

13607700 / 06-118

FEATURES

A-Circuit
 Voltage Set Point **14.50 V**

Original & X-References..

MITSUBISHI	A866X12770
A866X12772	A866X12782
CARGO	132101
USI	71-60027
MOBILETRON	VR-H2009-7H
WAI	35-8308
TRANSP0	IM265 IM265HD

For use on: Ford Probe, Mazda

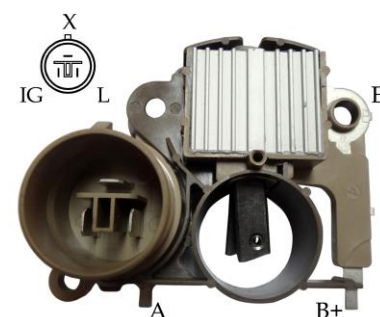

13607800 / 06-119

FEATURES

A-Circuit
 Voltage Set Point **14.50 V**

Original & X-References..

MITSUBISHI	A866X11870 11872
MOBILETRON	VR-H2009-14N
LESTER	13213 13416
WAI	35-8321
TRANSP0	IM275

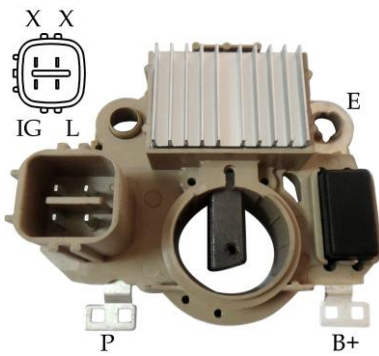

13607900 / 06-120

FEATURES

A-Circuit
 Voltage Set Point **14.50 V**
 Soft Start **30 %**
 LRC **5 sec**
 Field Lamp Shorted Circuit Protection
 Under Voltage Indication
 Over Voltage Indication

Original & X-References..

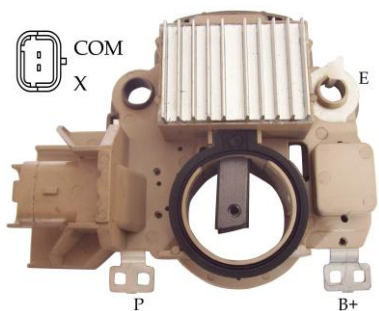

13608000 / 06-121

FEATURES

A-Circuit
 Voltage Set Point **14.80 V**
 Soft Start **17 %**
 LRC **4 sec**
 Self Exciting Function

Original & X-References..

BSS Regulator

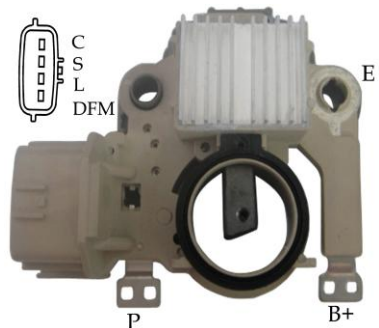

13620500 / 06-122

FEATURES

A-Circuit
 Voltage Set Point **14.50 V**
 Sense Open Indication
 Under/ Over Voltage Indication
 DFM Function

Original & X-References..

MITSUBISHI	A866X28572
MOBILETRON	VR-H2009-73
LESTER	13585 13586 13587
WAI	35-8346
TRANSPO	IM845

For use on: (1999-95) Eagle, Mitsubishi

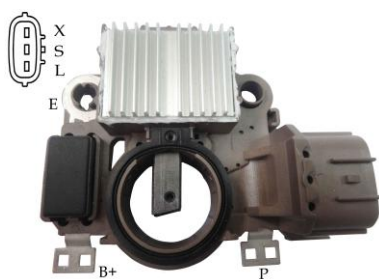

13608100 / 06-123

FEATURES

A-Circuit
 Voltage Set Point **14.50 V**
 Soft Start **30 %**
 LRC **5 Sec**
 Field Shorted Circuit Protection
 Sense Open Indication
 Under Voltage Indication
 Over Voltage Indication

Original & X-References..

MITSUBISHI	A2TG1081ZT
	A3TG2681AE
MOBILETRON	VRH2009-123

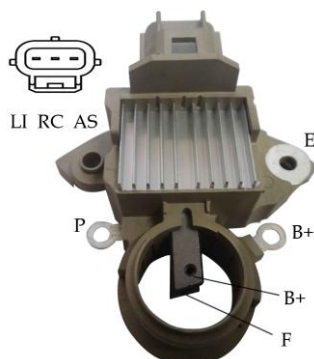

13620600 / 06-124

FEATURES

A-Circuit
 RC=0 Vs=13.50V
 RC=55% Vs=14.25V

Original & X-References..

MOBILETRON	VR-H2009-140
------------	--------------

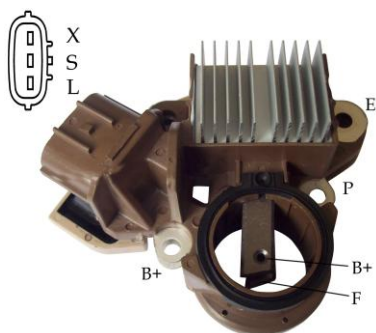

13620700 / 06-125

FEATURES

A-Circuit
 Voltage Set Point **14.50V**
 Soft Start **30 %**
 LRC **5 Sec**
 Field Shorted Circuit Protection
 Sense Open Indication
 Under / Over Voltage Indication

For use on: (2008-07) Nissan

Original & X-References..

MITSUBISHI	A2TJ0281
MOBILETRON	VR-H2009-148
LESTER	11343
TRANSPO	IM564

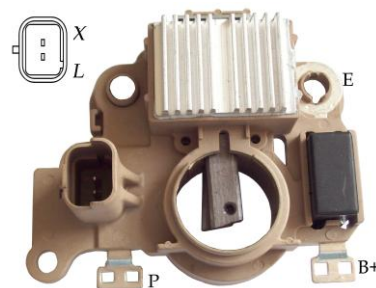

13608500 / 06-131

FEATURES

A-Circuit
 Voltage Set Point **14.50 V**
 Field Shorted Circuit Protection
 Over Voltage Indication
 Without Trio Diode Application

Original & X-References..

MITSUBISHI	A2TC0391
------------	----------

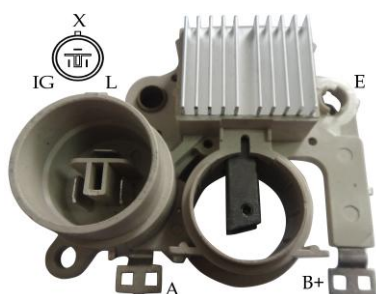

13608700 / 06-134

FEATURES

A-Circuit
 Voltage Set Point **14.50 V**

Original & X-References..

MITSUBISHI	A866X26641
MOBILETRON	VR-H2009-50
WAI	35-8354
LESTER	13608 13700
TRANSPO	IM835

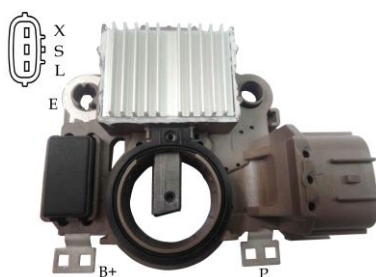

13609200 / 06-139

FEATURES

A-Circuit
 Voltage Set Point **14.50 V**
 Soft Start **30 %**
 LRC **5 Sec**
 Field Shorted Circuit Protection
 Sense Open Indication
 Under Voltage Indication
 Over Voltage Indication

Original & X-References..

TRANSPO	IM481
---------	-------

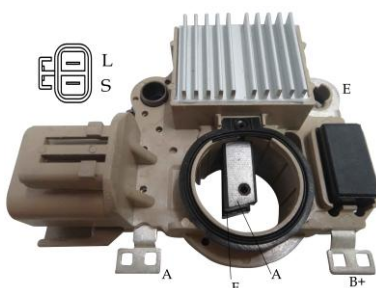

13609300 / 06-140

FEATURES

A-Circuit
 Voltage Set Point **14.50 V**

Original & X-References..

MITSUBISHI	A866X24072
	A866X27472
MOBILETRON	VRH2009-129

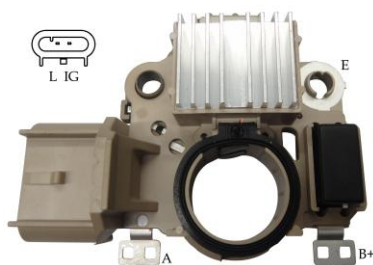

1360C200

FEATURES

A-Circuit
Voltage Set Point **14.50 V**

Original & X-References..

MITSUBISHI A5TB1191ZT



1360CF00

FEATURES

A-Circuit
Voltage Set Point **28.50 V**
Soft Start **30 %**
Field, Lamp Shorted Circuit Protection
IG Open Indication
Sense Loss Indication
Under Voltage Indication
Over Voltage Indication

Original & X-References..

MITSUBISHI A4TR5491
A4TR5591
MOBILETRON VR-H2009-132
VR-H2009-183B

13700100 / 07-001

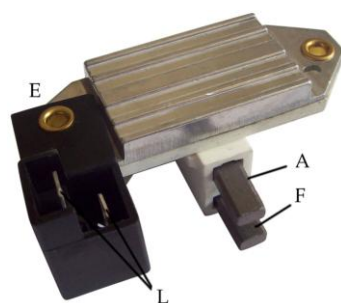

FEATURES

A-Circuit
Voltage Set Point **14.50 V**

For use on: 633-200 And 633-210
Series Magneti-Marelli
Alternators On late Fiat Models

Original & X-References..

MAGNETI MARELLI	
58120022	79707161
797 074 81	RTT 119 A
RTT 119 AAC	RTT 119 AC
83600151	
WAI	35-9304
MOBILETRON	VR-F119
CARGO	131283
TRANSPO	IX110

13700300 / 07-005

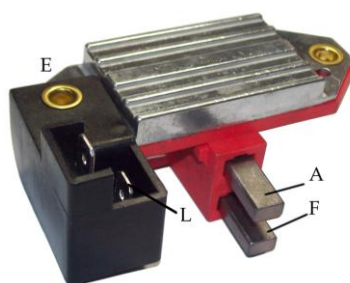

FEATURES

A-Circuit
Voltage Set Point **28.50 V**

For use on:
Fiat Tractors And Other
Fiat Applications

Original & X-References..

MAGNETI MARELLI	
79707441	RTT 117 B
MOBILETRON	VR-F119B
CARGO	131286
TRANSPO	IX111

13710100 / 07-006

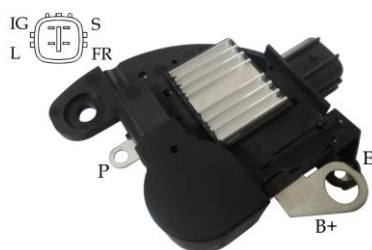

FEATURES

B-Circuit
Voltage Set Point **14.20 V**
Soft Start **30 %** LRC **5 sec**
Field Shorted Circuit Protection
Sense Open Indication
Under/ Over Voltage Indication
DFM Function

Original & X-References..

13710800 / 07-014

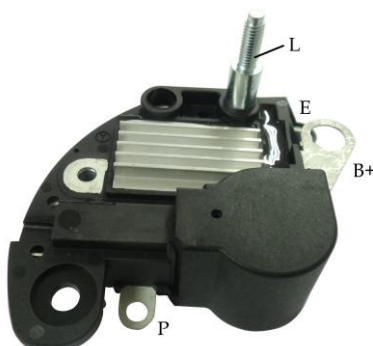

FEATURES

A-Circuit
Voltage Set Point **14.50 V**
Soft Start **32 %** LRC **5 sec**
Field Shorted Circuit Protection
Under /Over Voltage Indication
Self-exciting

Original & X-References..

MAGNETI	
RTM151A	83611361
MOBILETRON	VR-F151A
CARGO	136432
UNIPOINT	YR-388
TRANSPO	IX 121

13711600 / 07-023

For use on: Fiat Punto 62
Cabrio Selcta Punto 75 ELX
HSD S SX

13700400 / 07-015

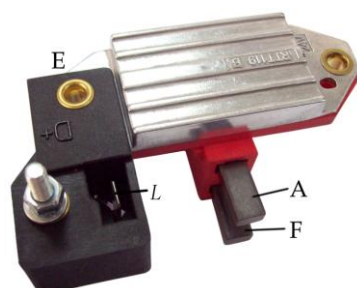

FEATURES

A-Circuit
Voltage Set Point **28.50 V**

Original & X-References..

FIAT	83606411
CARGO	138796

13711000 / 07-017

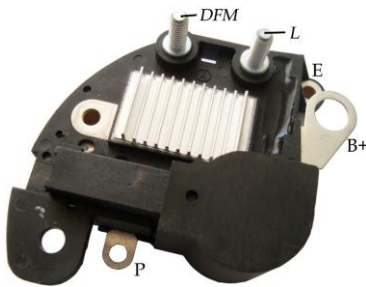

FEATURES

A-Circuit
 Voltage Set Point **14.50 V**
 Soft Start **32 %**
 LRC **5 sec**
 Field Shorted Circuit Protection
 Under Voltage Indication
 Over Voltage Indication
 DFM function
 Self-exciting

Original & X-References..

MAGNETI MARELLI	85563491
CARGO	238265
MOBILETRON	VR-F157



13711300 / 07-019

FEATUERS

A-Circuit
 RC=0 $V_s=13.50V$
 RC=55% $V_s=14.25V$
 PCM Regulator

Original & X-References..

MARELLI	85582601010
MOBILETRON	VR-F156
CARGO	230790
TRANSPO	IX131

13711400 / 07-020



FEATURES

A-Circuit
 Voltage Set Point **14.50 V**
 Soft Start **32 %** LRC **5 sec**
 Field Shorted Circuit Protection
 Under / Over Voltage Indication
 DFM function
 Cut-in Speed: 1200rpm
 Self-exciting

Original & X-References..

MARELLI	85552506
MOBILETRON	VR-F159
CARGO	239983
TRANSPO	IX595

13720300 / 07-021

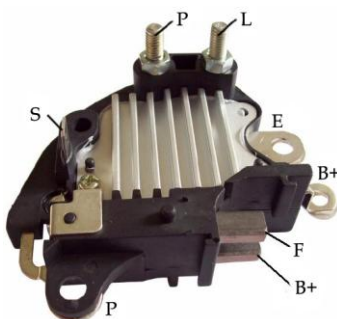

FEATURES

A-Circuit
 Voltage Set Point **14.60 V**
 Soft Start **32 %**
 LRC **5 sec**
 Field Shorted Circuit Protection
 Under Voltage Indication
 Over Voltage Indication
 With Trio Diode Application

Original & X-References..

FIAT	83614251	99946065
LESTER	12045	12072 12088
	12094	20693 20694
CARGO		136457
TRANSPO		IX127

13720400 / 07-022

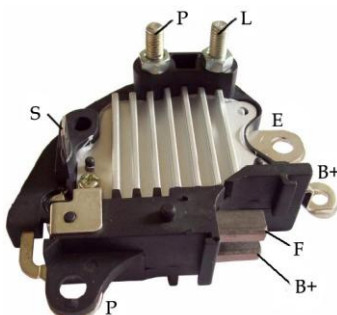

FEATURES

A-Circuit
 Voltage Set Point **28.50 V**
 Soft Start **30 %**
 Under Voltage Indication
 Over Voltage Indication

Original & X-References..

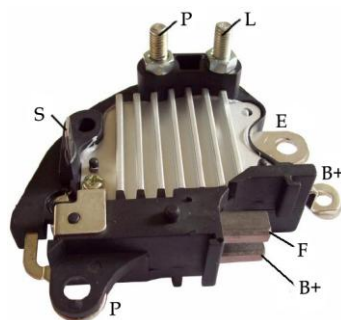

13720500 / 07-024

FEATURES

A-Circuit
 Voltage Set Point **14.60 V**
 Soft Start **32 %**
 LRC **5 sec**
 Field Shorted Circuit Protection
 Under Voltage Indication
 Over Voltage Indication
 With Trio Diode Application

Original & X-References..

MARELLI	28010B	28018A
WAI	35-9305	
MOBILETRON	VR-F121	
CAGRO	136457	
TRANSPO	IX128	

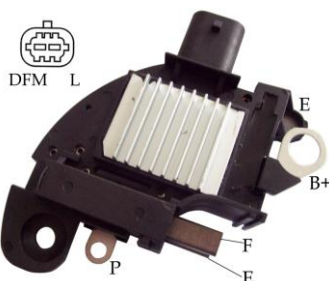

13711900 / 07-027

FEATURES

B-Circuit
 Voltage Set Point **14.50 V**
 Soft Start **30 %**
 LRC **5 sec**
 Under / Over Voltage Indication
 DFM function
 Self-exciting

Original & X-References..

13712200 / 07-032



FEATURES

A-Circuit
 Voltage Set Point **14.50 V**
 Soft Start **30 %** LRC **5 sec**
 Field Shorted Circuit Protection
 Under / Over Voltage Indication
 Self-exciting

Original & X-References..

MARELLI	83617181,	85561921,
		RTM153B
MOBILETRON	VR-F153A	
CARGO	138789	
WAI	35-9306	
TRANSPO	IX 123	

13712100 / 07-029

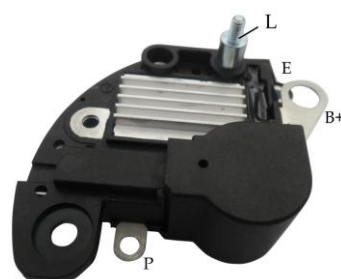

13712400 / 07-034

FEATURES

A-Circuit
 Voltage Set Point **14.50 V**
 Soft Start **32 %** LRC **5 sec**
 Field Shorted Circuit Protection
 Under /Over Voltage Indication
 Self-exciting

Original & X-References..

MARELLI	83615921,	RTM150B
MOBILETRON	VR-F150A	
CARGO	138798	

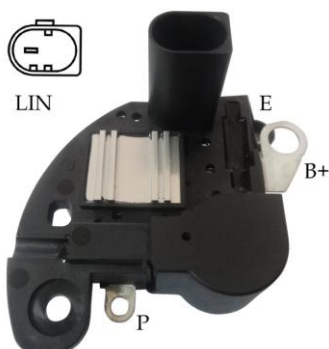

13712700 / 07-037

FEATURES

B-Circuit
 Voltage Set Point **13.70 V**
 LRC **3 sec**
 Self Exciting Function

Original & X-References..

LIN Regulator

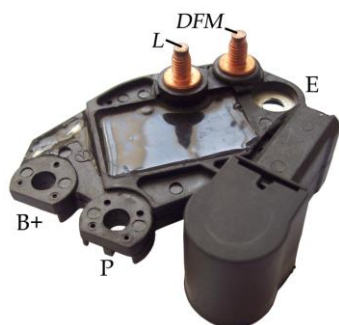

13800100 / 08-001

FEATURES

B-Circuit
 Voltage Set Point **14.50 V**
 Soft Start **30 %** LRC **5 sec**
 Field Shorted Circuit Protection
 Under/ Over Voltage Indication
 DFM function with duty cycle limitation
 Self exciting function

Original & X-References..

VALEO	593529
MOBILETRON	VR-PR3529
CARGO	234982
TRANSPO	M562

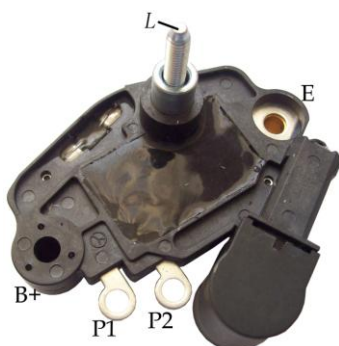

13800300 / 08-004

FEATURES

B-Circuit
 Voltage Set Point **14.50 V**
 Soft Start **30 %**
 LRC **5 sec**
 Field Shorted Circuit Protection
 Under Voltage Indication
 Over Voltage Indication
 Self exciting function

Original & X-References..

VALEO	593290	593310	593349
CARGO	139456	230784	230785
MOBILETRON		VR-PR002H	
TRANSPO		M517	

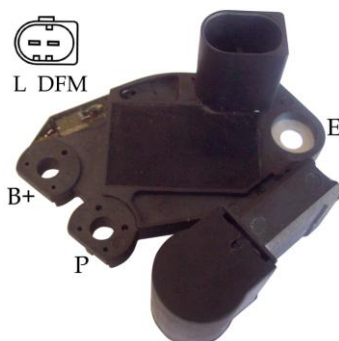

13800400 / 08-006

FEATURES

B-Circuit
 Voltage Set Point **14.50 V**
 Soft Start **30 %**
 LRC **5 sec**
 Field Shorted Circuit Protection
 Under Voltage Indication
 Over Voltage Indication
 DFM function
 Self exciting function

Original & X-References..

VALEO	2542292
MOBILETRON	VR-PR2292
CARGO	231103
TRANSPO	M521

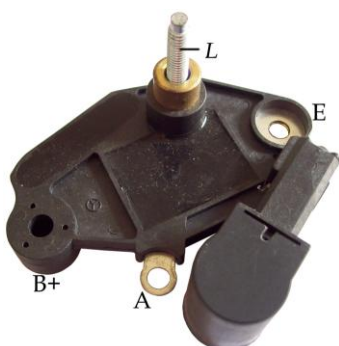

13800500 / 08-007

FEATURES

A-Circuit
 Voltage Set Point **14.50 V**

Original & X-References..

VALEO	2541715	2808323
		5931138
MOBILETRON		VR-PR1669
CARGO		136546
TRANSPO		M514

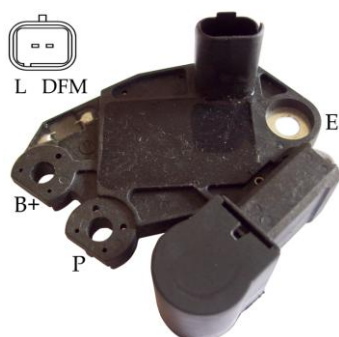

13800600 / 08-008

FEATURES

B-Circuit
 Voltage Set Point **14.50 V**
 Soft Start **30 %** LRC **5 sec**
 Field Shorted Circuit Protection
 Under Voltage Indication
 Over Voltage Indication
 DFM Function
 Self exciting function

Original & X-References..

VALEO	2542299
	593384
	593396
MOBILETRON	VR-PR2299H
CARGO	232962

13800700 / 08-009



FEATURES

B-Circuit
 Voltage Set Point **14.50 V**
 Soft Start **30 %**
 LRC **5 sec**
 Field Shorted Circuit Protection
 Under Voltage Indication
 Over Voltage Indication
 Self exciting function

Original & X-References..

VALEO	593284	2541834
VALEO	A14V115	A14V116
	A14V127	A14V135
	A14V141	
TRANSPO	M519	

13800800 / 08-010



FEATURES

A-Circuit
 Voltage Set Point **14.50 V**

Original & X-References..

VALEO	2521335	590939
HUCO	130696	
MOBILETRON	VR-VW010	
CARGO	133988	134475
TRANSPO	M511	

13800900 / 08-012

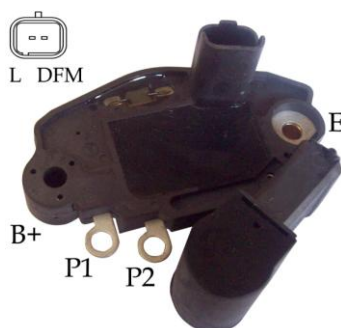

FEATURES

B-Circuit
 Voltage Set Point **14.50 V**
 Soft Start **30 %** LRC **5 sec**
 Field, Lamp Shorted Circuit Protection
 Under / Over Voltage Indication
 DFM Function
 Self exciting function

Original & X-References..

VALEO	593316	2541952
	YM1620	
MOBILETRON	VR-PR1620	
CARGO	139440	139441
TRANSPO	M516	

13801900 / 08-037

Voltage Set Point **14.05 V**

13820400 / 08-014

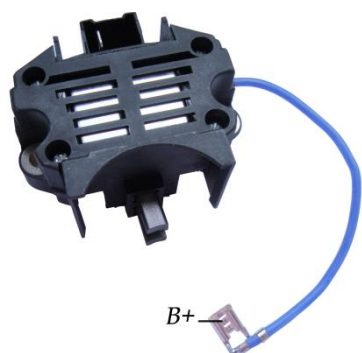

FEATURES

A-Circuit
 Voltage Set Point **14.60 V**

Original & X-References..

LUCAS	21225183	21225371
VALEO	092897	092902
	300820	
MOBILETRON	VR-PR1925H	
WAI	35-9401	
CARGO	130661	131552
TRANSPO	IP125	

13820500 / 08-015

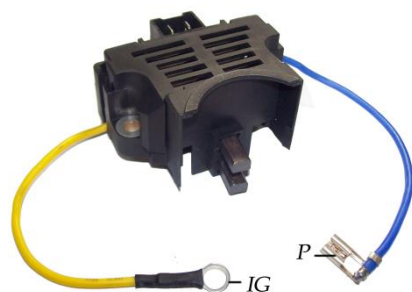

FEATURES

A-Circuit
 Voltage Set Point **14.50 V**

Original & X-References..

LUCAS	21225345	UCB218
VALEO	182046	2590588
MOBILETRON	VR-PR1652H	
WAI	35-9405	35-9405-1
CARGO	130657	
TRANSPO	IP1652	

For use on : AMC, Renault, Volvo



13801000 / 08-016

FEATURES

B-Circuit
 Voltage Set Point **14.50 V**
 Soft Start **30 %**
 LRC **5 sec**
 Field Shorted Circuit Protection
 Under Voltage Indication
 Over Voltage Indication
 DFM function
 Self exciting function

Original & X-References..

VALEO	593362
	YM 1610F
CARGO	234533



13820600 / 08-017

FEATURES

A-Circuit
 Voltage Set Point **14.20 V**

Original & X-References..

VALEO	2521766	2523190	2521760
	2522339	2522939	2940328
	2941121		

13820800 / 08-028

A-Circuit
 Voltage Set Point **14.50 V**

MOBILETRON	VR-VW005N
CARGO	135393 131224
TRANSPO	M506

TRANSPO	M507
---------	------

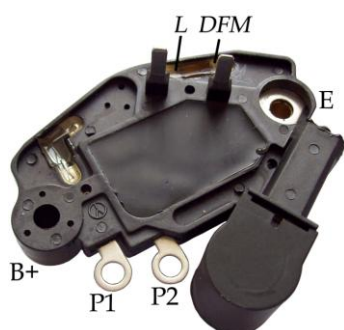

13801100 / 08-018

FEATURES

B-Circuit
 Voltage Set Point **14.50 V**
 Soft Start **30 %** LRC **5 sec**
 Field Shorted Circuit Protection
 Under/ Over Voltage Indication
 DFM function with duty cycle limitation
 Self exciting

Original & X-References..

VALEO	593419
MOBILETRON	VR-V3419
CARGO	233633
TRANSPO	M564

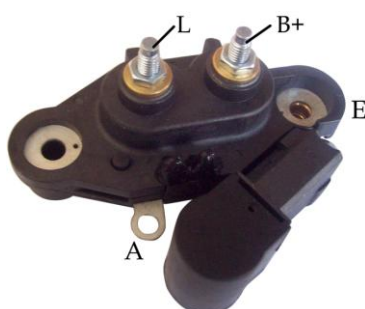

13801200 / 08-019

FEATURES

A-Circuit
 Voltage Set Point **14.50 V**

Original & X-References..

For use on: Fiat, Audi

VALEO	2541406	2541496	592793	9RC2055
	9RC2062		A808239A	
MOBILETRON	VR-PR1667			
CARGO	135434			
TRANSPO	M513			

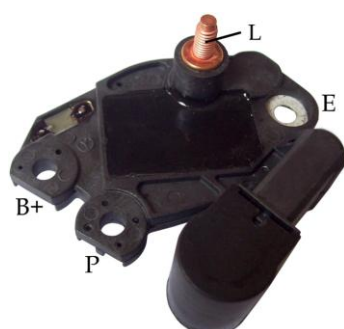

13801300 / 08-020

FEATURES

B-Circuit
 Voltage Set Point **14.50 V**
 Soft Start **30 %**
 LRC **5 sec**
 Field Shorted Circuit Protection
 Under Voltage Indication
 Over Voltage Indication
 Self exciting function

Original & X-References..

VALEO	593534	593477	593505
MOBILETRON	VR-PR3534		
CARGO	234115		
TRANSPO	M551		

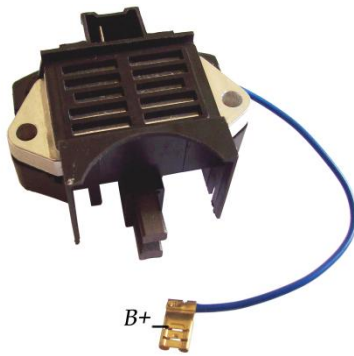

13820700 / 08-021

FEATURES

A-Circuit
Voltage Set Point **28.50 V**

Original & X-References..

VALEO	590640
MOBILETRON	VR-PR128B
CARGO	131120
TRANSPO	IP126



13830100 / 08-022

FEATURES

A-Circuit
Voltage Set Point **28.10 V**

Original & X-References..

VALEO	593260
	ZV3960H
	CA13102R
MOBILETRON	VR-PR3960
CARGO	137489

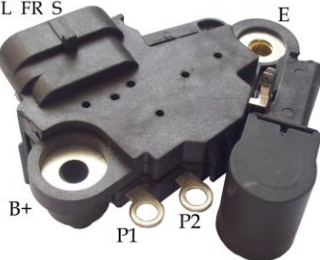
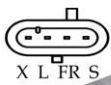

13810100 / 08-023

FEATURES

B-Circuit
Voltage Set Point **14.80 V**
Soft Start **30 %**
LRC **5 sec**
Field Shorted Circuit Protection
Sense Open Indication
Under Voltage Indication
Over Voltage Indication
DFM function

Original & X-References..

VALEO	2542339B
MOBILETRON	VR-PR2339
TRANSPO	M533



13801400 / 08-024

FEATURES

A-Circuit
Voltage Set Point **14.50 V**

Original & X-References..

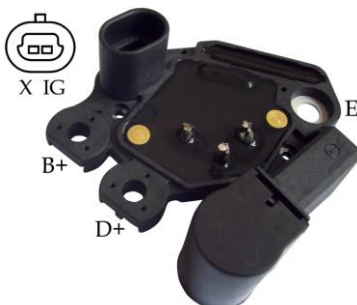

13830200 / 08-025

FEATURES

B-Circuit
Voltage Set Point **14.70 V**

Original & X-References..

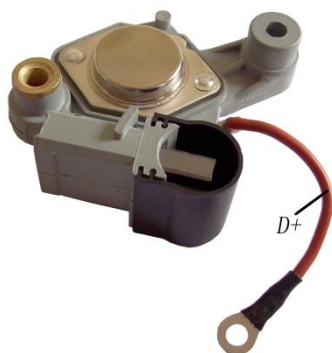

13830300 / 08-026

FEATURES

A-Circuit
Voltage Set Point **14.50 V**

Original & X-References..



13830400 / 08-027

FEATURES

A-Circuit
Voltage Set Point **14.70 V**

Original & X-References..

VALEO	593434	
	593466	YM1658
CARGO	235079	

13830500 / 08-034

A-Circuit
Voltage Set Point **28.50 V**

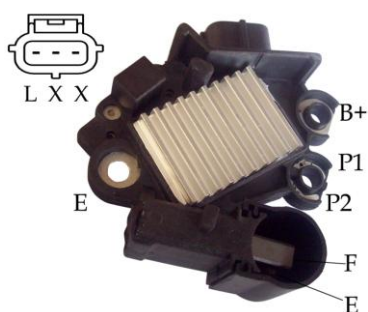

13801500 / 08-031

FEATUERS

B-Circuit
Voltage Set Point **14.50 V**
Soft Start **32 %**
LRC **5 sec**
Field Shorted Circuit Protection
Under Voltage Indication
Over Voltage Indication
Self exciting function

Original & X-References..

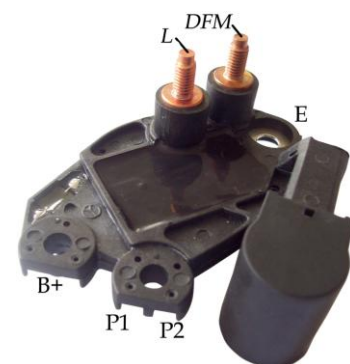

13801600 / 08-032

FEATURES

B-Circuit
Voltage Set Point **14.50 V**
Soft Start **30 %**
LRC **5 sec**
Field Shorted Circuit Protection
Under Voltage Indication
Over Voltage Indication
DFM function
Self exciting function

Original & X-References..

VALEO	593529
MOBILETRON	VR-PR3529
CAGRO	234982
TRANSPO	M562

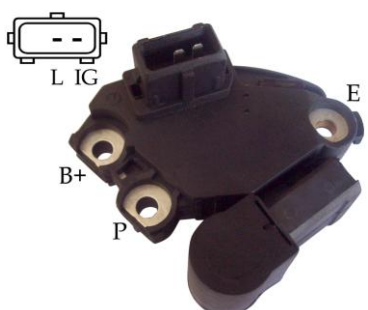

13801700 / 08-033

FEATUERS

B-Circuit
Voltage Set Point **14.80 V**
Soft Start **32 %**
LRC **5 sec**
Field, Shorted Circuit Protection
Under Voltage Indication
Over Voltage Indication

Original & X-References..

VALEO	2542378B	2543325B
	593423	
MOBILETRON	VR-PR2206	
LESTER	13971	
TRANSPO	M523	



L DFM

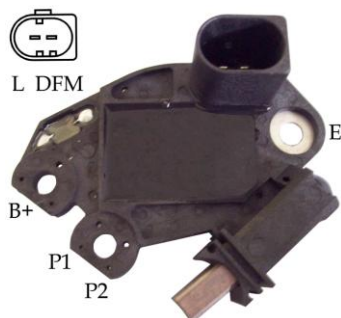

13801800 / 08-035

FEATUERS

Original & X-References..

B-Circuit
Voltage Set Point **14.50 V**
Soft Start **30 %**
LRC **5 sec**
Field Shorted Circuit Protection
Under Voltage Indication
Over Voltage Indication
DFM function
Self exciting function



L IG

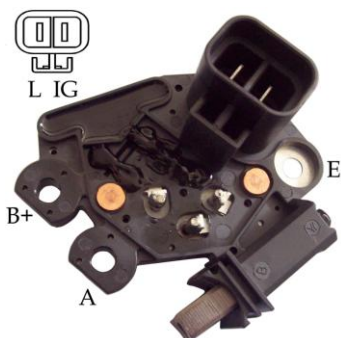

13830600 / 08-036

FEATUERS

Original & X-References..

A-Circuit
Voltage Set Point **14.50 V**

13830800 / 08-042

A-Circuit
Voltage Set Point **14.60 V**



IG L

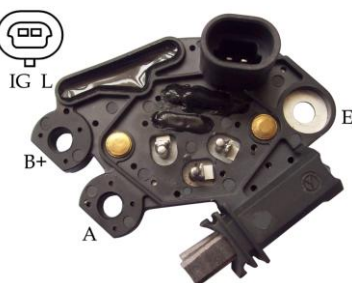

13830700 / 08-038

FEATUERS

Original & X-References..

A-Circuit
Voltage Set Point **14.50V**



L DFM S



13802000 / 08-039

FEATUERS

Original & X-References..

B-Circuit
Voltage Set Point **14.45 V**
Soft Start **30 %**
LRC **5 sec**
Field Shorted Circuit Protection
Sense Open Indication
Under Voltage Indication
Over Voltage Indication
DFM function

VALEO	2542499
MOBILETRON	VR-V2499
LESTER	13943
TRANSPO	M520



X L IG



13802100 / 08-040

FEATURES

Original & X-References..

B-Circuit
Voltage Set Point **14.30 V**
Soft Start **32 %**
LRC **5 sec**
Field, Shorted Circuit Protection
Under Voltage Indication
Over Voltage Indication
Self Exciting Function

VALEO	593333
MOBILETRON	VR-PR3617H
CARGO	230944
LESTER	13848
TRANSPO	M527

138023000 / 08-043

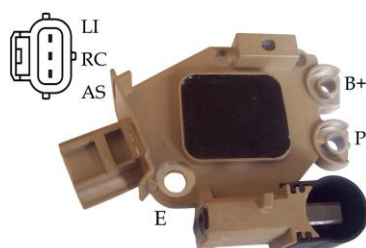

FEATUERS

A-Circuit
 RC=0 $V_s=13.50V$
 RC=55% $V_s=14.25V$

Original & X-References..

VALEO	599121
	TG9C013
MOBILETRON	VR-PR4920
CARGO	234820

13802400 / 08-044



FEATUERS

B-Circuit
 Voltage Set Point **14.80 V**
 Soft Start **15 %**
 LRC **2.5 sec**
 Self exciting function

Original & X-References..

VALEO	599101	593780
	595458	
MOBILETRON	VR-V3780	
CARGO	236597	

COM regulator

13810300 / 08-045

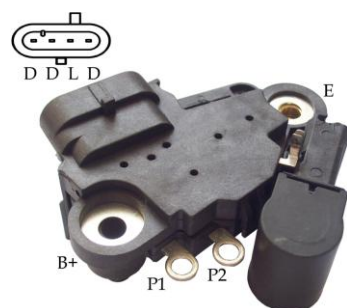

FEATURES

B-Circuit
 Voltage Set Point **14.80 V**
 Soft Start **30 %**
 LRC **5 sec**
 Field Shorted Circuit Protection
 Sense Open Indication
 Under Voltage Indication
 Over Voltage Indication
 DFM function

Original & X-References..

VALEO	254366C
	2546493C
MOBILETRON	VR-PR6366
TRANSP0	M515

13802700 / 08-048

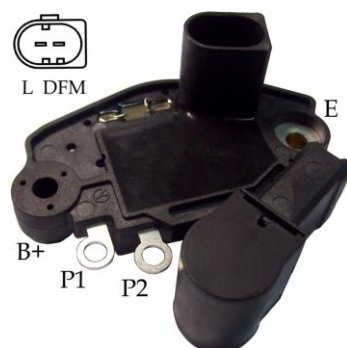

FEATURES

B-Circuit
 Voltage Set Point **14.50 V**
 Soft Start **30 %**
 LRC **5 sec**
 Field Shorted Circuit Protection
 Under Voltage Indication
 Over Voltage Indication
 DFM function
 Self exciting function

Original & X-References..

VALEO	593406
CARGO	235369
TRANSP0	M553

13802800 / 08-049



FEATUERS

B-Circuit
 Voltage Set Point **14.80 V**
 Soft Start **15 %**
 LRC **2.5 sec**
 Self exciting function

Original & X-References..

VALEO	595253	
	2543208	2604774
LESTER	20453	23359
	24030	24108
TRANSP0	M571	

COM regulator

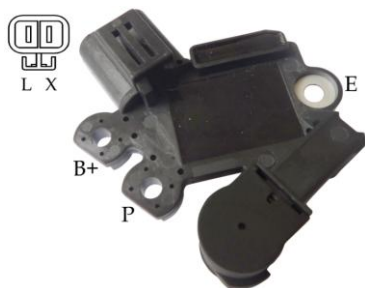

13802900/ 08-050

FEATURES

B-Circuit
 Voltage Set Point **14.50 V**
 Soft Start **30 %**
 LRC **5 sec**
 Field Shorted Circuit Protection
 Sense Open Indication
 Under / Over Voltage Indication
 DFM function
 Self exciting function

Original & X-References..

TG8S019

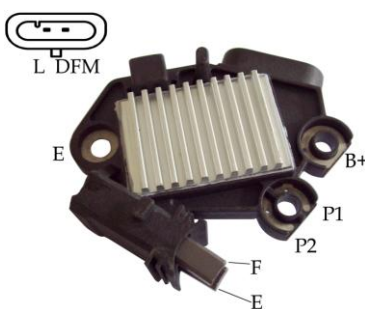

13803000 / 08-051

FEATURES

B-Circuit
 Voltage Set Point **14.50 V**
 Soft Start **30 %**
 LRC **5 sec**
 Field Shorted Circuit Protection
 Sense Open Indication
 Under / Over Voltage Indication
 DFM function
 Self exciting function

Original & X-References..

VALEO	2542765
MOBILETRON	VR-PR2765
TRANSPO	M524

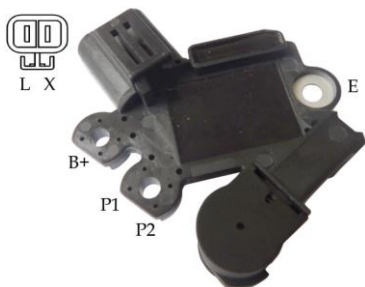

13803100 / 08-052

FEATURES

B-Circuit
 Voltage Set Point **14.50 V**
 Soft Start **30 %**
 LRC **5 sec**
 Field Shorted Circuit Protection
 Under Voltage Indication
 Over Voltage Indication
 Self exciting function

Original & X-References..

VALEO	20051012	2655001
	2655479	
MOBILETRON	VR-V5001	
LESTER	11015	11020
TRANSPO	M531	

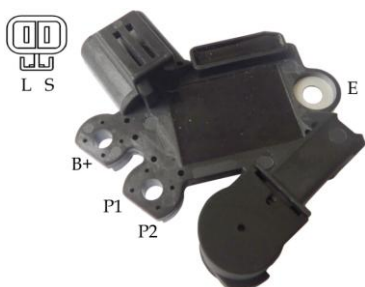

13803200 / 08-053

FEATURES

B-Circuit
 Voltage Set Point **14.50 V**
 Soft Start **30 %**
 LRC **5 sec**
 Field Shorted Circuit Protection
 Sense Open Indication
 Under Voltage Indication
 Over Voltage Indication
 DFM function
 Self exciting function

Original & X-References..

VALEO	2650030C
MOBILETRON	VR-V0030
LESTER	11017
TRANSPO	M534

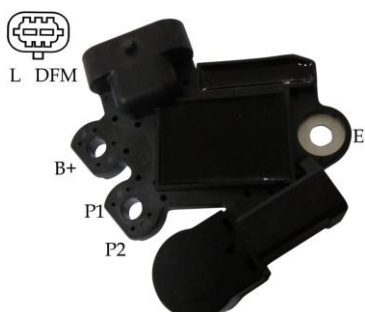

13803300 / 08-054

FEATURES

B-Circuit
 RVC=0 Vset=**13.80V**
 RC=**70%** Vset=**14.45V**
 Soft Start **18.75 %**
 LRC **2.5 sec**
 DFM function

Original & X-References..

VALEO	2650441	2650561
LESTER	11021	11023 11148
	11265	11266
TRANSPO	M540	

RVC Regulator

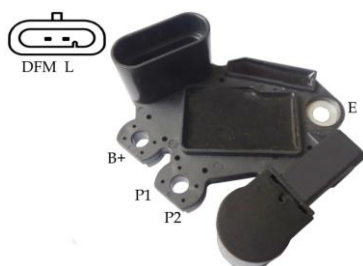

13803400 / 08-055

FEATURES

B-Circuit
 Voltage Set Point **14.50 V**
 Soft Start **30 %**
 LRC **5 sec**
 Field Shorted Circuit Protection
 Under Voltage Indication
 Over Voltage Indication
 DFM function
 Self exciting function

Original & X-References..

VALEO	2650473
LESTER	11142
TRANSPO	M558

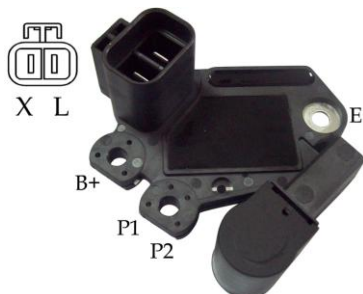

13803600 / 08-057

FEATURES

B-Circuit
 Voltage Set Point **14.50 V**
 Soft Start **30 %**
 LRC **5 sec**
 Field Shorted Circuit Protection
 Under Voltage Indication
 Over Voltage Indication
 Self exciting function

Original & X-References..

VALEO	2455023
CARGO	236224
MOBILETRON	VR-PR5023



13803700 / 08-058

FEATURES

A-Circuit
 Voltage Set Point **14.80 V**
 Soft Start **17 %**
 LRC **4 sec**
 Self Exciting Function

Original & X-References..

VALEO	593771	595256
	593538	2609956
LESTER	21338	24100
TRANSPO		M575

BSS Regulator



13803900 / 08-060

FEATURES

A-Circuit
 Voltage Set Point **14.70 V**

Original & X-References..

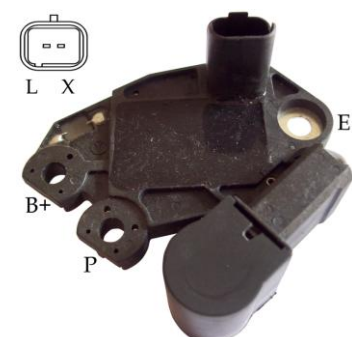

13804000 / 08-061

FEATURES

B-Circuit
 Voltage Set Point **14.50 V**
 Soft Start **30 %** LRC **5 sec**
 Field Shorted Circuit Protection
 Under Voltage Indication
 Over Voltage Indication
 Self exciting Function

Original & X-References..

VALEO	TG85019
-------	---------



13804200 / 08-063

FEATURES

B-Circuit
 Voltage Set Point **14.50 V**
 Soft Start **30 %** LRC **5 sec**
 Field Shorted Circuit Protection
 Under/ Over Voltage Indication
 DFM Function
 Self Exciting Function

Original & X-References..

VALEO	20071017	20080622
LESTER	11012	11013
MOBILETRON		VR-PR5011
TRANSPO		M563

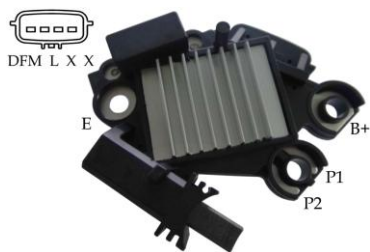

13804300 / 08-064

FEATURES

B-Circuit
 Voltage Set Point **14.50 V**
 Soft Start **30 %** LRC **5 sec**
 Field Shorted Circuit Protection
 Under/ Over Voltage Indication
 DFM Function
 Self Exciting Function

Original & X-References..

VALEO	20030410	
	20031203	20050725
LESTER	11014	
TRANSPO	M536	

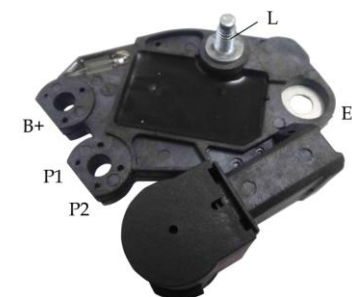

13804400 / 08-065

FEATUERS

B-Circuit
 Voltage Set Point **14.50 V**
 Soft Start **30 %** LRC **5 sec**
 Field Shorted Circuit Protection
 Under Voltage Indication
 Over Voltage Indication
 DFM Function
 Self exciting function
 For use on: Citroen Xantia

Original & X-References..

VALEO	593532	
LESTER	21785	21788
TRANSPO	M561	

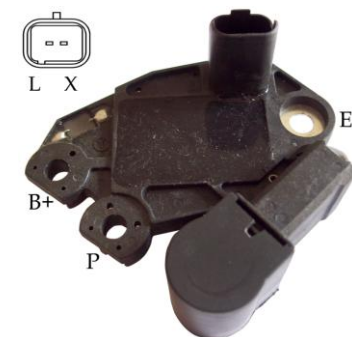

13804500 / 08-066

FEATUERS

B-Circuit
 Voltage Set Point **14.50 V**
 Soft Start **30 %** LRC **5 sec**
 Field Shorted Circuit Protection
 Under / Over Voltage Indication
 Self exciting function
 DFM function
 For use on: Mitsubishi, Nissan, Opel,
 Renault, Volvo (Europe)

Original & X-References..

VALEO	593546	593689
	2542299	2542638
MOBILETRON	VR-V3689	
LESTER	20506	22990
	23174	23893
TRANSPO	M546	

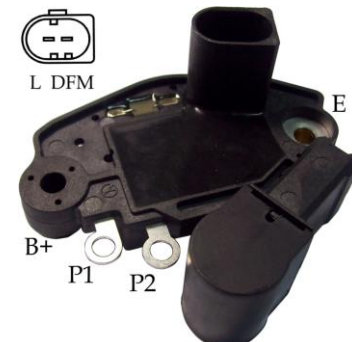

13804600 / 08-067

FEATURES

B-Circuit
 Voltage Set Point **14.50 V**
 Soft Start **30 %** LRC **5 sec**
 Field Shorted Circuit Protection
 Under Voltage Indication
 Over Voltage Indication
 DFM Function
 Self exciting function

Original & X-References..

VALEO	593406	
MOBILETRON	VR-V3406SE	

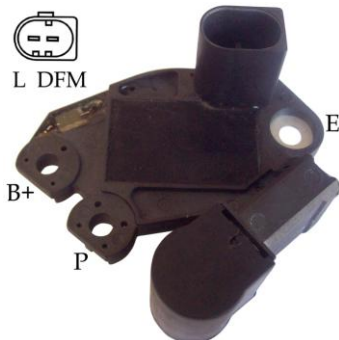

13804700 / 08-068

FEATURES

B-Circuit
 Voltage Set Point **14.50 V**
 Soft Start **30 %** LRC **5 sec**
 Field Shorted Circuit Protection
 Under Voltage Indication
 Over Voltage Indication
 DFM Function
 Self exciting function

Original & X-References..

VALEO	593813		
LESTER	11019	11070	11149
	11161	13946	13947
TRANSPO		M547	

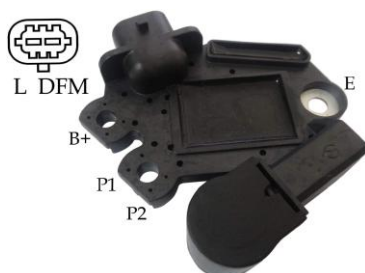

13804800 / 08-069

FEATURES

B-Circuit
 RVC=0 Vset=**13.80V**
 RC=**70%** Vset=**14.45V**
 Soft Start **18.75 %**
 LRC **2.5 sec**
 DFM function

Original & X-References..

VALEO	TG12C70
	2605581

RVC Regulator

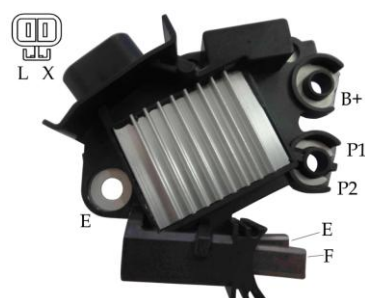

13804900 / 08-070

FEATURES

B-Circuit
 Voltage Set Point **14.50 V**
 Soft Start **30 %** LRC **5 sec**
 Field Shorted Circuit Protection
 Under/ Over Voltage Indication
 Self Exciting Function

Original & X-References..

VALEO	TG8C011	
	439490	437455
	2542694	

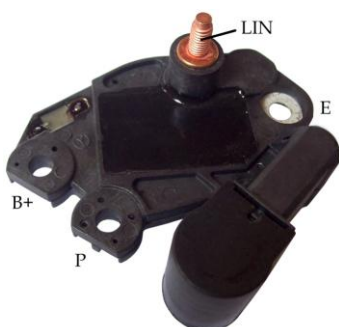

13805200 / 08-073

FEATURES

B-Circuit
 Voltage Set Point **14.00 V**
 LRC **3 sec**
 Self Exciting Function

Original & X-References..

VALEO	593970	2543298
LESTER		23896
TRANSPO		M576

LIN Regulator



13805300 / 08-074

FEATURES

B-Circuit
 Voltage Set Point **14.00 V**
 LRC **3 sec**
 Self Exciting Function

Original & X-References..

VALEO	595305
-------	--------

LIN Regulator



LIN X



B+

P

13805400 / 08-075

FEATURES

B-Circuit
Voltage Set Point **14.00 V**
LRC **3 sec**
Self Exciting Function

Original & X-References..

VALEO	595325	2542604
	595243	2543279
LESTER	11306	11309
TRANSPO		M573

LIN Regulator



LIN X

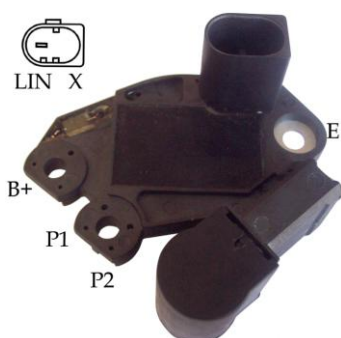

B+

P1

P2

13805500 / 08-076

FEATURES

B-Circuit
Voltage Set Point **14.00 V**
LRC **3 sec**
Self Exciting Function

Original & X-References..

VALEO	2614772
-------	---------

LIN Regulator



B+

P

LIN

13805600 / 08-077

FEATURES

B-Circuit
Voltage Set Point **14.00 V**
LRC **3 sec**
Self Exciting Function

Original & X-References..

VALEO	2614772
-------	---------

LIN Regulator

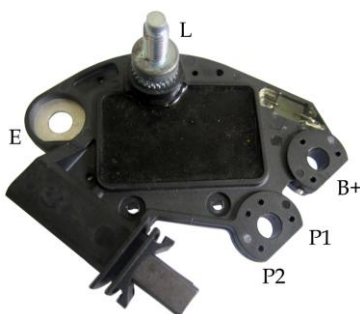

E

B+

P1

P2

L

13805800 / 08-079

FEATURES

B-Circuit
Voltage Set Point **14.50 V**
Soft Start **30 %**
LRC **5 sec**
Field Shorted Circuit Protection
Under Voltage Indication
Over Voltage Indication
Self exciting function

Original & X-References..

VALEO	SG7S062
-------	---------



L IG

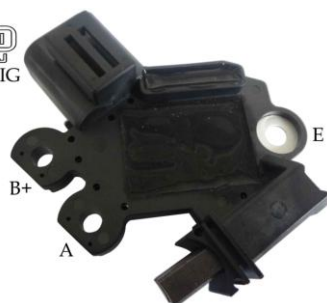

B+

A

13806100 / 08-082

FEATURES

A-Circuit
Voltage Set Point **14.50 V**

Original & X-References..

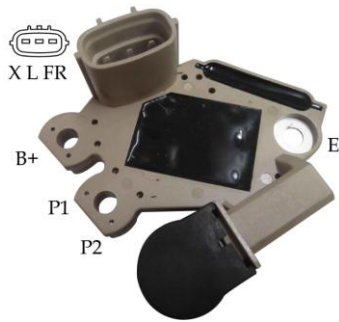

13806400 / 08-085

FEATURES

B-Circuit
 Voltage Set Point **14.50 V**
 Soft Start **30 %**
 LRC **5 sec**
 Field Shorted Circuit Protection
 Under Voltage Indication
 Over Voltage Indication
 Self exciting function

Original & X-References..

VALEO	20080710
	133421122
CARGO	330917
LESTER	11311
TRANSPO	M544



13806500 / 08-086

FEATURES

B-Circuit
 Voltage Set Point **14.80 V**
 Soft Start **17 %**
 LRC **4 sec**
 Self exciting function

Original & X-References..

VALEO	2543591
-------	---------

COM regulator



13806600 / 08-087

FEATURES

B-Circuit
 Voltage Set Point **14.50 V**
 Soft Start **30 %** LRC **5 sec**
 Field Shorted Circuit Protection
 Under Voltage Indication
 Over Voltage Indication
 Self exciting function

Original & X-References..

VALEO	SG9S130
-------	---------

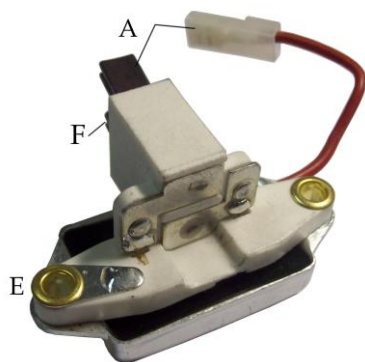

13413600 / 10-001

FEATURES

A-Circuit
Voltage Set Point **14.50 V**

For SKODA Series Alternators

Original & X-References..

MAGNETON-PAL
0134291 0134541
443930134291
443930136111
443930136131
LESTER 12140
LUCAS VCB901
CARGO 133417
TRANSPO MP291

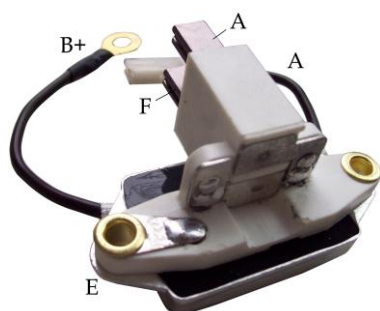

13413700 / 10-003

FEATUERS

A-Circuit
Voltage Set Point **14.40 V**

Original & X-References..

CARGO 137357

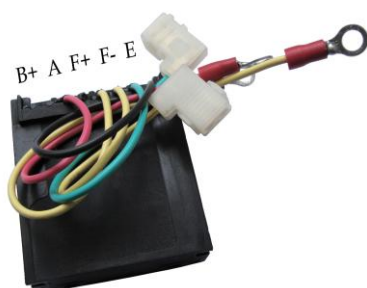

13910100 / 11-001

FEATURES

A-Circuit
Voltage Set Point **28.20 V**

Original & X-References..

FOR MILITARY VEHICLE
5 Wiring Application

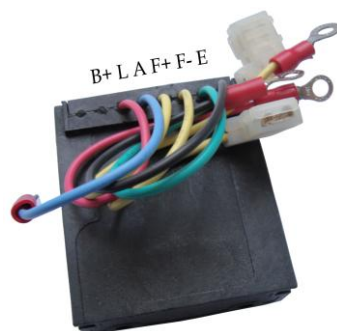

13910200 / 11-002

FEATURES

A-Circuit
Voltage Set Point **28.20 V**

Original & X-References..

FOR MILITARY VEHICLE
6 Wiring Application



13530300 / 12-001

FEATURES

A-Circuit
Voltage Set Point **28.80 V**

Original & X-References..

FOR HINO SERIES ALTERNATORS

13548100 / 12-002

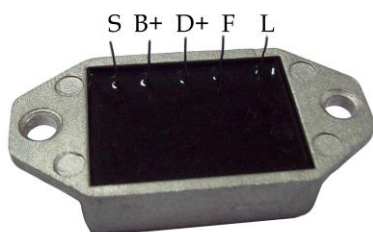

FEATURES

A-Circuit
Voltage Set Point 29.30 V

Original & X-References..

FOR KOMATSU GRAB
CARGO 135296
TRANSPO IZ228

13530400 / 12-003

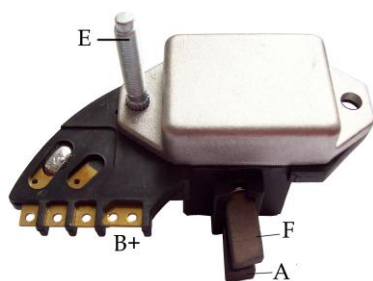

FEATURES

A-Circuit
Voltage Set Point 29.30 V

Original & X-References..

13530600 / 12-008

Voltage Set Point 28.50 V

13530700 / 12-009

With One Diode

13548200 / 12-005

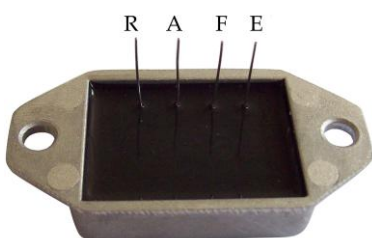

FEATURES

A-Circuit
Voltage Set Point 28.40 V
With 4 pins

Original & X-References..

FOR KOMATSU GRAB

13548300 / 12-006

Voltage Set Point 14.50 V
With 4 pins

13540500 / 12-007



FEATURES

A-Circuit
Voltage Set Point 28.80 V

Original & X-References..

NIKKO 1440000580 1440000730
ISUZU 1812510040 1812510240
5812510120
MOBLETRON VR-H2003-1B
TRANSPO IZ226

13530800 / 12-010

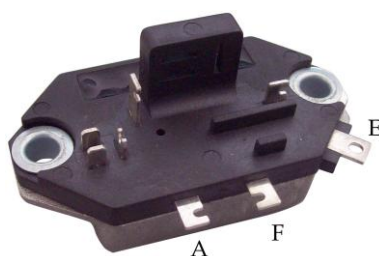

FEATUERS

A-Circuit
Voltage Set Point 29.30 V

Original & X-References..

NIKKO 600821830
S6D155

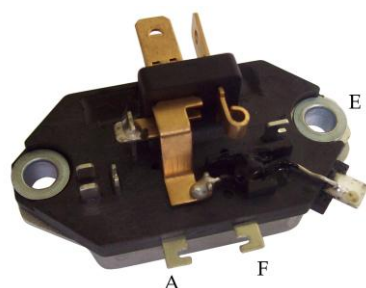

13530900 / 12-011

FEATUERS

A-Circuit
Voltage Set Point 29.20 V

Original & X-References..

NIKKO 7-44000-0900
CARGO 135321
KM156

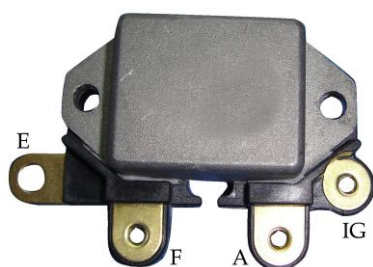

13531000 / 12-012

FEATUERS

A-Circuit
Voltage Set Point 28.40 V

Original & X-References..

NIKKO 0-37519-0150
0-37519-0151
CARGO 234999



13540800 / 12-016

FEATUERS

A-Circuit
Voltage Set Point 14.50 V

Original & X-References..



13531401

FEATUERS

A-Circuit
Voltage Set Point 14.50 V

Original & X-References..

NIKKO N35719-0010



13900100 / 14-001

FEATURES

A-Circuit
Voltage Set Point **14.20 V**

For LEECE NEVILLE
Series Alternator

Original & X-References..

LEECE NEVILLE	102200	L79000LH
WAI	35-500	
TRANSPO	L79000LH	

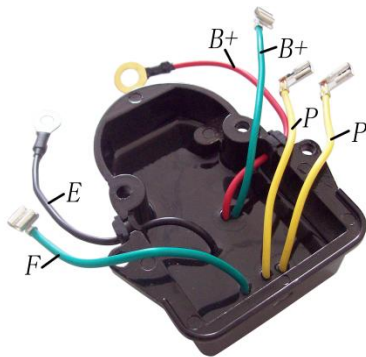

13900200 / 14-002

FEATURES

A-Circuit
Voltage Set Point **14.50 V**

Original & X-References..

MOTOROLA	105292	8RG2029A
	110434	110555
	8LAH2070V	8LHA2027
TRANSPO		M5-292A

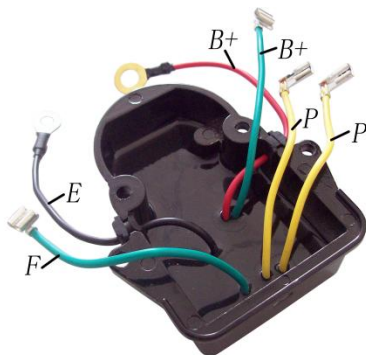

13903900 / 14-0021

FEATURES

A-Circuit
Voltage Set Point **28.20 V**
Field, Lamp Shorted Circuit Protection
Over Voltage Indication
With Battery Operation

Original & X-References..

PRESTOLITE	8RG2101A
8RG2112	105329
105360	
TRANSPO	M5-329A

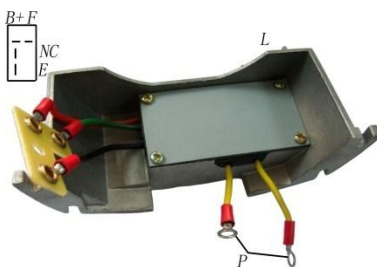

13900300 / 14-003

FEATURES

A-Circuit
Voltage Set Point **28.20 V**
Field, Lamp Shorted Circuit Protection
Over Voltage Indication
With Battery Operation

Original & X-References..

PRESTOLITE	8RL3108C
------------	----------

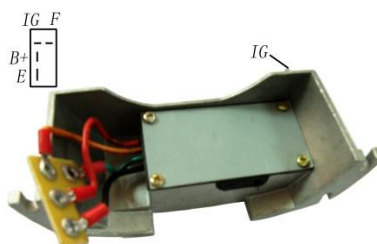

13900500 / 14-004

FEATURES

A-Circuit
Voltage Set Point **27.50V**
Field Shorted Circuit Protection
Over Voltage Indication
Without Battery Operation

Original & X-References..

PRESTOLITE	105229	105246	105351	105396
	8RL3007		8RL3011	
	8RL3023C			
MOBILETRON	VR-VW006			
TRANSPO	M5-396			

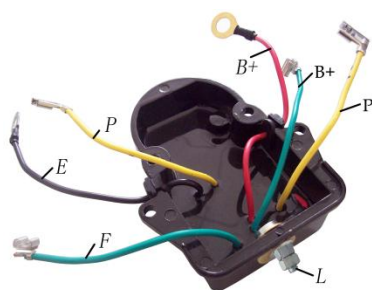

13900600 / 14-006

FEATURES

Original & X-References..

A-Circuit
 Voltage Set Point **28.00V**
 Field, Lamp Shorted Circuit Protection
 Over Voltage Indication
 With Battery Operation

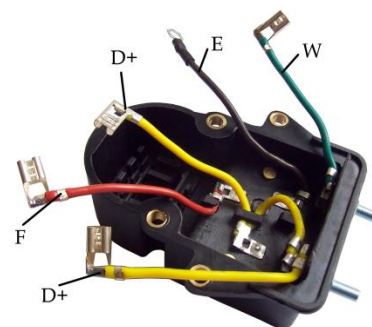

13901000 / 14-015

FEATUERS

Original & X-References..

A-Circuit
 Voltage Set Point **28.50 V**
 Field, Shorted Circuit Protection

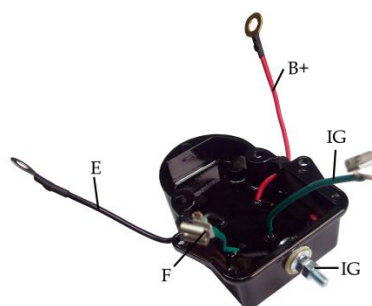

13901100 / 14-016

FEATUERS

Original & X-References..

A-Circuit
 Voltage Set Point **27.50 V**
 Field, Shorted Circuit Protection



12400100 / BHP11201 (Y)

FEATURES

Diodes: 6-50A Avalanche
 Diameter OD: 112mm
 With M8×30mm Battery Post
 With Trio

Original & X-References..

BOSCH	1127319552	1127320852
WAI		31-9121
CARGO	135176	138077 230242
MOBILETRON		RB-22H
TRANSPO		IBR852

12400600 / BHP11203 (Y)

Diodes: 8-50A Avalanche

BOSCH	1127320850
CARGO	135439
TRANSPO	IBR850



12400700 / BHP11204 (Y)

FEATURES

Diodes: 6-50A Avalanche
 Diameter OD: 112mm
 With M8×30mm Battery Post
 With Trio

Original & X-References..

BOSCH	1 127 319 593
	1 127 320 807
WAI	31-9126
CARGO	135175 137333

12400300 / BHP11202

Diodes: 8-50A Avalanche

MOBILETRON	RB-121H
TRANSPO	IBR844

12400320 / BHP11202B

Diodes: 8-35A Avalanche
 For 24V Alternators

BOSCH	1 127 319 637
-------	---------------



12400800 / BHP11205 (Y)

FEATURES

Diodes: 8-50A Avalanche
 Diameter OD: 112mm
 With M8×30mm Battery Post
 With Trio

Original & X-References..

BOSCH	1 127 319 560
	1 127 319 011
	1 127 319 746
CARGO	135440
MOBILETRON	RB-134H

12400900 / BHP11205-2

Diodes: 6-50A Avalanche



12401000 / BHP11206 (Y)

FEATURES

Diodes: 6-50A Avalanche
 Diameter OD: 112mm
 With M8×30mm Battery Post
 With Trio

Original & X-References..

BOSCH	1 127 319 021
	1 127 319 673
CARGO	135546

12401100 / BHP11206-1

Diodes: 8-50A Avalanche



12401400 / BHP11207 (Y)

FEATURES

Diodes: 6-35A Avalanche
 Diameter OD: 112mm
 With M6×30mm Battery Post
 With Trio
 With 1.2 Kilohm Resistor

Original & X-References..

BOSCH	1127319570
CARGO	137507
TRANSPO	IBR570

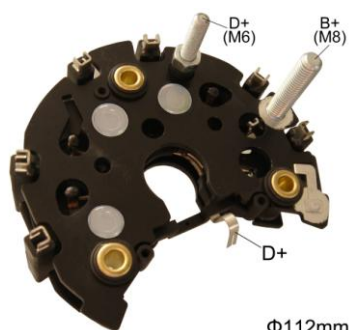

Φ112mm

12401600 / BHP11209 (Y)

FEATURES

Diodes: 6-35A Avalanche
 Diameter OD: 112mm
 With M8×40.5mm Battery Post
 With Trio

Original & X-References..

BOSCH	1 127 319 623
	1 127 320 882
CARGO	137257
MOBILERTRON	RB-101H
UNIPOINT	REC 243

12401700 / BHP11209-1

Diodes: 8-35A Avalanche



Φ112mm

12401800 / BHP11210B (Y)

FEATURES

Diodes: 8-50A Avalanche
 Diameter OD: 112mm
 With M8 Battery Post
 Without Trio
 For 24V Alternators
 For use on : 0 123 325 5500

Original & X-References..

BOSCH	1 127 319 792
LESTER	23512



Φ112mm

12401900 / BHP11211 (Y)

FEATURES

Diodes: 8-35A Avalanche
 Diameter OD: 112mm
 With M6×30mm Battery Post
 With Trio

Original & X-References..

BOSCH	1127319584
CARGO	135444
MOBILERTRON	RB-160H

12402000 / BHP11211-1

Diodes: 6-35A Avalanche



Φ112mm

12402100 / BHP11213 (Y)

FEATURES

Diodes: 8-50A Avalanche
 Diameter OD: 112mm
 With M6 Battery Post
 With Trio

Original & X-References..

BOSCH	1 127 319 671
CARGO	139571
TRANSPO	IBR671



Φ112mm

12402200 / BHP11214 (Y)

FEATURES

Diodes: 8-50A Avalanche
 Diameter OD: 112mm
 With M8×40.5mm Battery Post
 Without Trio

Original & X-References..

BOSCH	1 127 319 514
	1 127 319 563
	1 127 319 564
	1 127 319 698
CARGO	139030



12402300 / BHP11215 (Y)

FEATURES

Diodes: 6-50A Avalanche
 Diameter OD: 112mm
 With M8 Battery Post
 With Trio

Original & X-References..

BOSCH	1 127 319 694
TRANSPO	IBR694
MOBILERTRON	RB-36H

12402400 / BHP11215-1

Diodes: 8-50A Avalanche

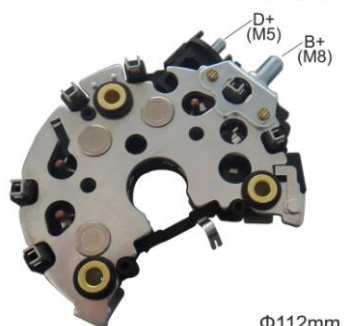

12402700 / BHP11219A

FEATURES

Diodes: 6-35A Avalanche
 Diameter OD: 112mm
 With M8 x 20mm Battery Post
 With Trio

Original & X-References..

With Capacitor

12402800 / BHP11220A

Diodes: 8-60A Avalanche

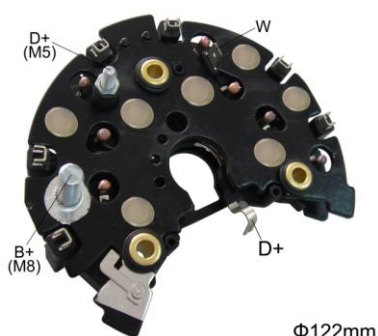

12402900 / BHP12201 (Y)

FEATURES

Diodes: 14-50A Avalanche
 Diameter OD: 122mm
 With M8 x 30mm Battery Post
 With Trio
 For use on : Mercedes Benz

Original & X-References..

BOSCH	1 127 319 552
	1 127 320 852
MOBILERTRON	RB-29H
WAI	31-9121
CARGO	135605
TRANSPO	IBR834

12402910 / BHP12201B

14-35 A Avalanche
 For 24V Alternators



12403000 / BHP12201-1 (Y)

FEATURES

Diodes: 12-50A Avalanche
 Diameter OD: 122mm
 With M8 x 30mm Battery Post
 With Trio
 For use on : Mercedes Benz

Original & X-References..

BOSCH	1127319029
	1127319639
	1127320824
TRANSPO	IBR824



12403100 / BHP12202 (Y)

FEATURES

Diodes: 8-50A Avalanche
 Diameter OD: 122mm
 With M8 x 30mm Battery Post
 With Trio
 For use on : VW Corado , Golf, Passat,
 Jetta, Eurovan

Original & X-References..

BOSCH	1 127 319 576
WAI	31-9127
CARGO	138074
TRANSPO	IBR854

12403200 / BHP12202-1

Diodes: 12-50A Avalanche



Φ122mm

12403300 / BHP12204 (Y)

FEATURES	Original & X-References..	
Diodes: 12-50A Avalanche	BOSCH	1 127 319 690
Diameter OD: 122mm		1 127 320 860
With M8×30mm Battery Post	CARGO	137259
With Trio	TRANSPO	IBR860

For use on :1991-00 BMW w/140A

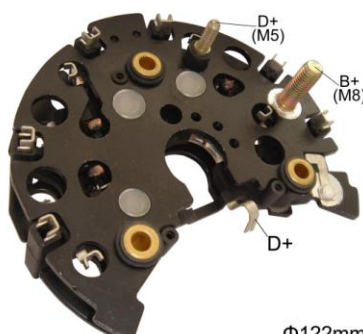

Φ122mm

12403400 / BHP12205 (Y)

FEATURES	Original & X-References..	
Diodes: 6-50A Avalanche	BOSCH	1 127 319 744
Diameter OD: 122mm	CARGO	230241
With M8×30mm Battery Post		230174
With Trio	MOBILERTRON	RB-33H
	TRANSPO	IBR744

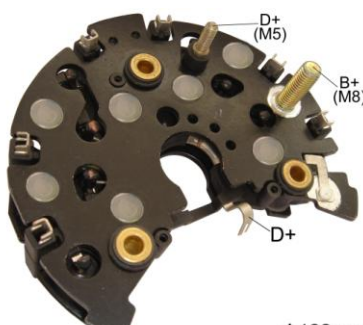

Φ122mm

12403500 / BHP12206 (Y)

FEATURES	Original & X-References..	
Diodes: 14-50A Avalanche	BOSCH	1 127 319 712
Diameter OD: 122mm		1 127 319 641
With M8×30mm Battery Post		
With Trio		

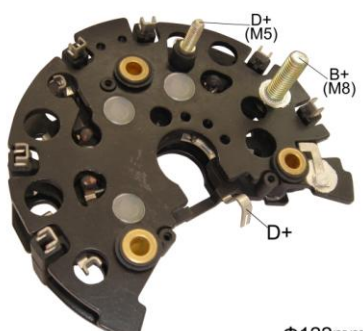

Φ122mm

12403600 / BHP12207 (Δ)

FEATURES	Original & X-References..	
Diodes: 6-50A Avalanche	BOSCH	1 127 319 802
Diameter OD: 122mm	CARGO	231643
With M8×30mm Battery Post		
With Trio		



Φ122mm

12403700 / BHP12208 (Δ)

FEATURES	Original & X-References..	
Diodes: 12-50A Avalanche	BOSCH	1127319700
Diameter OD: 122mm		F00M 053201
With M8×30mm Battery Post	CARGO	237268
With Trio	LESTER	11108 13773
		13779 13792

12403720 / BHP12208B	TRANSPO	IBR700
-----------------------------	---------	--------

For 24V Alternators



Φ122mm

12403800 / BHP12208-1 (Δ)

FEATURES

Diodes: 12-50A Avalanche
 Diameter OD: 122mm
 With M8×30mm Battery Post
 With “W” terminal
 With Trio

Original & X-References..

12403810 / BHP12208B-1

For 24V Alternators



Φ122mm

12403900 / BHP12209 (Δ)

FEATURES

Diodes: 6-50A Avalanche
 Diameter OD: 122mm
 With M8×30mm Battery Post
 With Trio

Original & X-References..

BOSCH	1 127 319 734
	1 127 319 572
CARGO	230093



Φ122mm

12404000 / BHP12210 (Y)

FEATURES

Diodes: 8-50A Avalanche
 Diameter OD: 122mm
 With M8×30mm Battery Post
 With Trio

Original & X-References..

BOSCH	1 127 319 501
	1 127 319 578
	1 127 319 752
CARGO	230173
TRANSP0	IBR501



Φ122mm

12404100 / BHP12211B (Y)

FEATURES

Diodes: 8-50A Avalanche
 Diameter OD: 122mm
 With M8×40.5mm Battery Post
 Without Trio
 For 24V Alternators

Original & X-References..

BOSCH	1 127 319 721
CARGO	234357



Φ122mm

12404300 / BHP12212 (Y)

FEATURES

Diodes: 12-50A Avalanche
 Diameter OD: 122mm
 With M8×40.5mm Battery Post
 Without Trio

Original & X-References..

BOSCH	1 127 319 692
CARGO	139252
TRANSP0	IBR692



Φ122mm

12404400 / BHP12213B (Y)

FEATURES	Original & X-References..	
Diodes: 8-50A Avalanche	BOSCH	1 127 319794
Diameter OD: 122mm	CARGO	234333
With M8 Battery Post		
Without Trio		
For 24V Alternators		



Φ122mm

12404700 / BHP12215 (Y)

FEATURES	Original & X-References..	
Diodes: 8-50A Avalanche		
Diameter OD: 122mm		
With M8×30mm Battery Post		
With Trio		
12404720 / BHP12215B		
Diodes: 8-50A Avalanche		
For 24V Alternators		



Φ122mm

12404800 / BHP12216 (Y)

FEATURES	Original & X-References..	
Diodes: 8-50A Avalanche	BOSCH	1 127 319 568
Diameter OD: 122mm		1 127 319 732
With M8×30mm Battery Post	CARGO	138080
With Trio		

12404900 / BHP12216-1

With M6×30mm Battery Post



Φ122mm

12405000 / BHP12218 (Δ)

FEATURES	Original & X-References..	
Diodes: 12-50A Avalanche	BOSCH	1 127 319 771
Diameter OD: 122mm	CARGO	233923
With M8×30mm Battery Post		
With Trio		



Φ122mm

12405100 / BHP12219 (Δ)

FEATURES	Original & X-References..	
Diodes: 12-50A Avalanche	BOSCH	1127319631
Diameter OD: 122mm	CARGO	138081
With M8×30mm Battery Post		
With Trio		



12405200 / BHP12220 (Y)

FEATURES	Original & X-References..	
Diodes: 12-50A Avalanche	BOSCH	1127319689
Diameter OD: 122mm	1127319690	1127320860
With M8×40.5mm Battery Post	CARGO	137259
With Trio	LESTER	13471 13526
	MOBILERTRON	
12405300 / BHP12220-1	TRANSPO	IBR860
Diodes: 14-50A Avalanche		

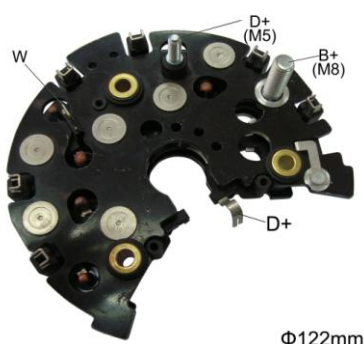

12405400 / BHP12226 (Δ)

FEATURES	Original & X-References..	
Diodes: 12-60A Avalanche	BOSCH	1127319782
Diameter OD: 122mm	CARGO	234839
With M8×30mm Battery Post	LESTER	12381
With Trio	TRANSPO	IBR709



12405500 / BHP12228A (Y)

FEATURES	Original & X-References..	
Diodes: 14-50A Avalanche	BOSCH	1127319805
Diameter: 122mm		1127319806
With M8×30mm Battery Post		
With Trio		



1242B200 / BHP9001

FEATURES	Original & X-References..	
Diodes : 6-35 Ampere	BOSCH	1 690 521 2
Diameter OD : 90mm	1 127 320 152	1 127 320 192
With Trio	1 127 320 319	
	CARGO	130597
For use on : Agrifur, Fiat, Lancia, Marshall Tractor, Same, Styer	MOBILETRON	RB-10H
	TRANSPO	IBR318



1242B300 / BHP9002

FEATURES	Original & X-References..	
Diodes : 6-35 Ampere		
Diameter OD : 90mm		
With M6×52mm Batter Post		
With M5×28mm Trio Post		
With M5×48mm W-Post		
With Trio		



1242B400 / BHP9003

FEATURES

Diodes : 6-35 Ampere
 Diameter OD : 90 mm
 With M6×52mm Battery Post
 With Trio

For use on : John Deere, IH

Original & X-References..

BOSCH	169 05254
1 127 320 115	1 127 320 116
1 127 320 141	1 127 320 142
WAI	31-9144
CARGO	132670
MOBILETRON	RB-13J
TRANSPO	IBR307

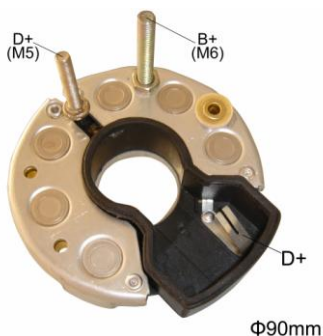

1242B500 / BHP9005

FEATURES

Diodes : 6-35Ampere
 Diameter OD : 90mm
 With M6×52mm Battery Post
 With M5×28mm Trio Post
 With Trio

Original & X-References..

1242B600 / BHP9006

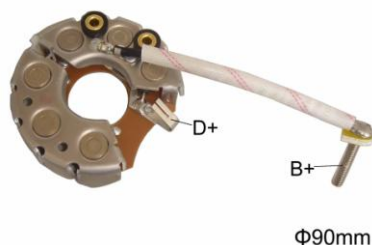

FEATURES

Diodes: 6-35A Ampere
 Diameter OD: 90mm
 With M6×37mm Battery Post
 With Trio

Original & X-References..

BOSCH	9 121 080 595
GAUSS	GA1959
TRANSPO	IBR595



12420100 / BHP11401

FEATURES

Diodes: 6-35 Ampere
 Diameter OD: 114mm
 With M6×52.5mm Battery Post
 With M4×42mm Trio Post
 With M5×48mm W-Post
 With Trio
 For use on : DAF, Mercedes Benz

Original & X-References..

BOSCH	1 127 011 098	1 127 011 101
1 127 320 344	1 127 320 363	
1 127 320 366	1 127 320 367	
WAI	31-9139	
CARGO	133138	
MOBILETRON	RB-08H	
TRANSPO	IBR313	

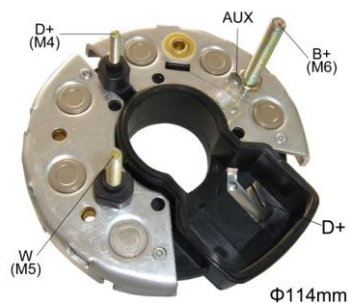

12420200 / BHP11402

FEATURES

Diodes: 6-35 Ampere
 Diameter OD: 114mm
 With M6×52.5mm Battery Post
 With M4×42mm Trio Post
 With M5×48mm W-Post
 With Trio

Original & X-References..

BOSCH	1 127 011 095	1 127 011 096
1 127 011 097	1 127 011 103	
MOBILETRON	RB-07H	
WAI	31-9140	
CARGO	131468	
TRANSPO	IBR314	

12420400 / BHP11403

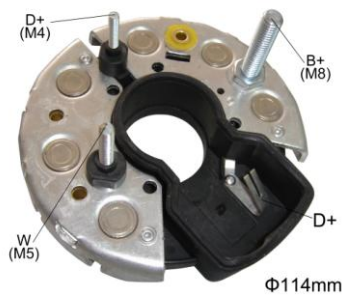

FEATURES

Diodes: 6-35 Ampere
 Diameter OD: 114mm
 With M8×52.5mm Battery Post
 With M4×42mm Trio Post
 With M5×48mm W-Post
 With Trio
 For use on : Mercedes Benz Trucks

Original & X-References..

BOSCH	1 127 320 909
	1 127 041 132
CARGO	133995
MOBILETRON	RB-14H
TRANSPO	IBR315

12420410 / BHP11403B

Diodes:6-35A Avalanche
 For 24V Alternators

12420600 / BHP11404

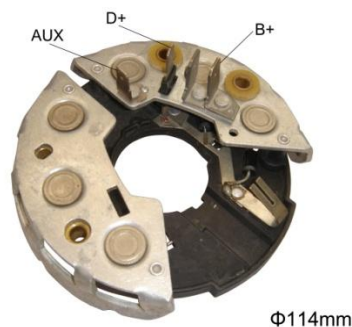

FEATURES

Diodes: 6-35 Ampere
 Diameter OD: 114mm
 With Trio

Original & X-References..

BOSCH	1 127 011 112	1 127 011 113
	1 127 011 114	1 127 011 115
	1 127 011 135	1 127 320 101
	1 127 320 103	1 127 320 502
WAI	31-9100	
CARGO	130603	
MOBILETRON	RB-01HA	
TRANSPO	IBR303	

12420800 / BHP11406

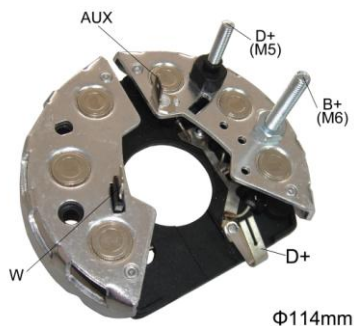

FEATURES

Diodes: 6-35 Ampere
 Diameter OD: 114mm
 With M6×50.4mm Battery Post
 With M5×47.2mm Trio Post
 With Trio

Original & X-References..

BOSCH	1 127 320 665
CARGO	132667
TRANSPO	IBR311

12421200 / BHP11411

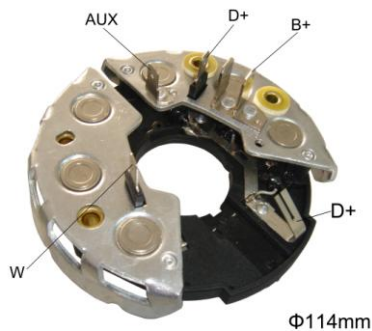

FEATURES

Diodes: 6-35 Ampere
 Diameter OD: 114mm
 With Trio
 For use on : Audi, VW Diesel

Original & X-References..

BOSCH	1 127 011 116	1 127 320 506
	1 127 320 614	1 127 320 648
WAI	31-9108	
CARGO	131559	
MOBILETRON	RB-03HA	
TRANSPO	IBR302	

12421300 / BHP11412



FEATURES

Diodes: 6-35 Ampere
 Diameter OD: 114mm
 With M6×52.5mm Battery Post
 With Trio
 For use on: Volvo Diesel

Original & X-References..

BOSCH	1 127 011 131
WAI	31-9116
CARGO	134341
MOBILETRON	RB-16H
TRANSPO	IBR301

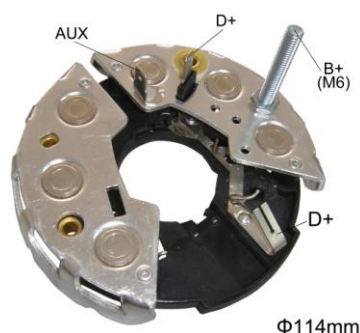

12421500 / BHP11413

FEATURES

Diodes: 6-35 Ampere
 Diameter OD: 114mm
 With M6×52.5mm Battery Post
 With Trio

Original & X-References..

BOSCH
 1 127 011 138 1 127 320 501
 1 127 320 511 1 127 320 620
 WAI 31-9101
 CARGO 130602

12421510 / BHP11413A

Diodes: 6-35A Avalanche

MOBILETRON RB-02H
 TRANSPON IBR304



12421600 / BHP11414

FEATURES

Diodes: 6-35 Ampere
 Diameter OD: 114mm
 With M8×52.5mm Battery Post
 With M5×47.2mm Trio Post
 With Trio
 For use on : Audi Saab Scania, VW

Original & X-References..

BOSCH
 1 127 320 601 1 127 320 661
 1 127 320 662 1 127 320 691
 CARGO 132668
 230361
 MOBILETRON RB-05H
 TRANSPON IBR316



12421700 / BHP11415

FEATURES

Diodes: 6-35 Ampere
 Diameter OD: 114mm
 With M5×47.2mm W-Post
 With Trio
 For use on : Ford Cortina, Granada,
 Scorio + Cargo Van

Original & X-References..

BOSCH
 1 127 011 139 1 127 320 372
 1 127 320 580 1 127 320 652
 CARGO 132669
 MOBILETRON RB-06HA
 TRANSPON IBR317



12421800 / BHP11416

FEATURES

Diodes: 6-35 Ampere
 Diameter OD: 114mm
 With M6×52.5mm Battery Post
 With M5×47.2mm Trio Post
 With M5×47.2mm W-Post
 With Trio

Original & X-References..

BOSCH 9 121 147 302
 CARGO 133997
 MOBILETRON RB-17H
 TRANSPON IBR320
 For use on : Various

12421810 / BHP11416A

Diodes: 6-35 Avalanche



12421900 / BHP11417

FEATURES

Diodes: 6-35 Ampere
 Diameter OD: 114mm
 With (M8+M6) ×54.6 Battery Post
 With M5×47.2mm Trio Post
 With Trio

Original & X-References..

BOSCH 1 127 320 651
 1 127 320 677
 CARGO 133996
 MOBILETRON RB-19H
 TRANSPON IBR321

12422000 / BHP11418



FEATURES

Diodes: 6-35 Ampere
 Diameter OD: 114mm
 With (M8+M6) ×54.6mm Battery Post
 With M5 ×47.2mm Trio Post
 With Trio

Original & X-References..

BOSCH	1 127 320 914
GM	90 350 009
CARGO	133998
MOBILETRON	RB-18H
TRANSPO	IBR322

12422100 / BHP11419



FEATURES

Diodes: 6-35 Ampere
 Diameter OD: 114mm
 With M6 ×52.5mm Battery Post
 With M4 ×42mm Trio Post
 With M5 ×47.2mm W-Post
 With Trio

Original & X-References..

BOSCH	1 127 320 667
FORD	6156187
	86AB10304AA
CARGO	135890
MOBILETRON	RB-38H
TRANSPO	IBR667

12422200 / BHP11420



FEATURES

Diodes: 6-35 Ampere
 Diameter OD: 114mm
 With Trio
 For use on : 1988-91 Ford Sierra 1.8L

Original & X-References..

BOSCH	1 127 320 903
CARGO	137726
MOBILETRON	RB-86H
TRANSPO	IBR903

12422300 / BHP11421

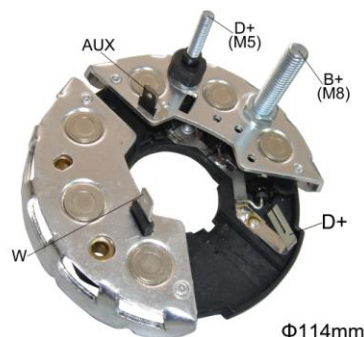

FEATURES

Diodes: 6-35 Ampere
 Diameter OD: 114mm
 With M8 ×52.5mm Battery Post
 With M5 ×47.2mm Trio Post
 With Trio
 For use on: Audi, VW Diesel

Original & X-References..

BOSCH	1 127 320 664
	1 127 320 665
	1 127 320 666
WAI	31-9114
CARGO	132667
MOBILETRON	RB-04H
TRANSPO	IBR311

12422310 / BHP11421A

Diodes: 6-35 A Avalanche

12422400 / BHP11422



FEATURES

Diodes: 6-35 Ampere
 Diameter OD: 114mm
 With M6 ×52.5mm Battery Post
 With M4 ×42mm Trio Post
 With Trio
 For use on : VW

Original & X-References..

BOSCH	1 127 320 668
WAI	31-9145
CARGO	133994
MOBILETRON	RB-15H
TRANSPO	IBR319



12422500 / BHP11424

FEATURES

Diodes: 6-35 Ampere
 Diameter OD: 114mm
 With M6×52.5mm Battery Post
 With Trio
 For use on : Komatsu 1982-89 Audi
 Quatro Turbo

Original & X-References..

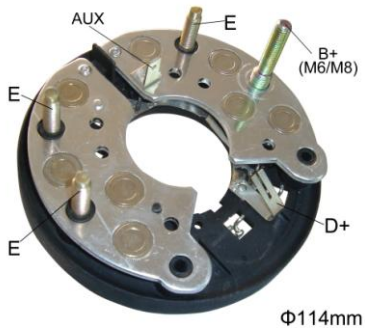

12422600 / BHP11425

FEATURES

Diodes: 8-50 Ampere
 Diameter OD: 114mm
 With (M8+M6) ×48mm Battery Post
 With Trio

Original & X-References..

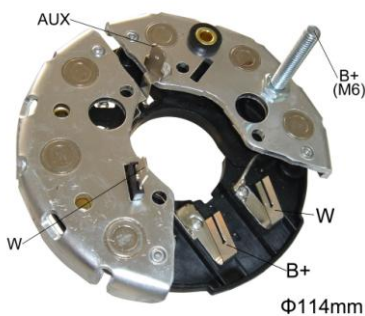

12422710 / BHP11426A

FEATURES

Diodes: 6-50A Avalanche
 Diameter OD: 114mm
 With M6×50mm Battery Post
 Without Trio

12422700 / BHP11426

Diodes: 6-50A Ampere

12422800 / BHP11426-1

Diodes: 8-50A Ampere

Original & X-References..

BOSCH	9 120 067 027
	9 121 067 379
	9 121 067 385
CARGO	136591
MOBILETRON	RB-84H
TRANSPO	IBR388

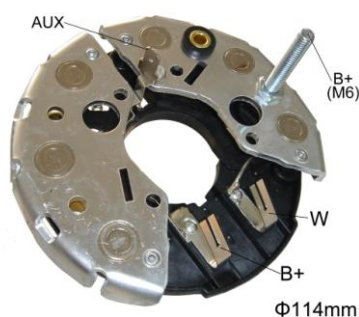

12422810 / BHP11426A-1

FEATURES

Diodes: 6-50A Avalanche
 Diameter OD: 114mm
 With M6×50mm Battery Post
 Without Trio
 Without "W" Terminal

Original & X-References..

BOSCH	9 121067 379
TRANSPO	IBR323



12423500 / BHP11427

FEATURES

Diodes: 8-50 Ampere
 Diameter OD: 114mm
 With M8×52.5mm Battery Post
 With M5×48mm Trio Post
 With Trio

12423510 / BHP11427A

Diodes: 8-50 A Avalanche

Original & X-References..

BOSCH	1 127 320 692
CARGO	138165
TRANSPO	IBR324

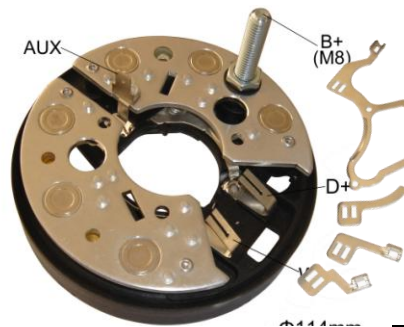

12423600 / BHP11428A

FEATURES

Diodes: 6-35 A Avalanche
 Diameter OD: 114mm
 With M8×52mm Battery Post
 Without Trio

Original & X-References..

BOSCH	9 120 067 027
	9 121 067 379
	9 121 067 385
CARGO	136591
MOBILETRON	RB-84H
TRANSPO	IBR388

12423900 / BHP11432A

Diodes:8-35 A Avalanche

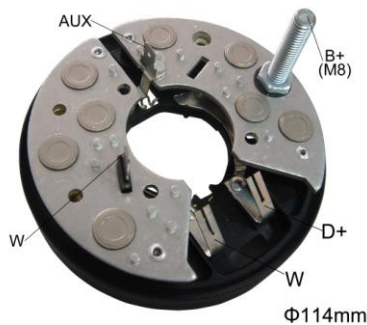

12423700 / BHP11430A

FEATURES

Diodes: 8-35A Avalanche
 Diameter OD: 114mm
 With M8×52mm Battery Post
 Without Trio

Original & X-References..

BOSCH	9 121 067 067
	9 121 067 388
	9 121 067 364
MOBILETRON	RB-84H
CARGO	234953
TRANSPO	IBR308

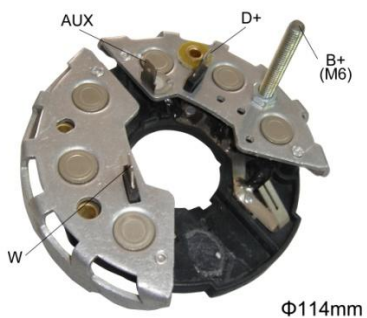

12423800 / BHP11431

FEATURES

Diodes: 6-35 Ampere
 Diameter OD: 114mm
 With M8×52.5mm Battery Post
 With Trio

Original & X-References..



12424000 / BHP11433A

FEATURES

Diodes: 8-50A Avalanche
 Diameter OD: 114mm
 With M6×52.5mm Battery Post
 With Trio

Original & X-References..

BOSCH	F010LD1067	F010LD0001
WAGNER		W060-69
TRANSPO		IBR276



12424300 / BHP11435

FEATURES

Diodes: 8-50A Ampere
 Diameter OD: 114mm
 With M6×50mm Battery Post
 Without Trio

Original & X-References..

FORD	E9YJ-10304A
CARGO	136556
MOBILETRON	MFRX00711
	RB-81H
TRANSPO	IBR347

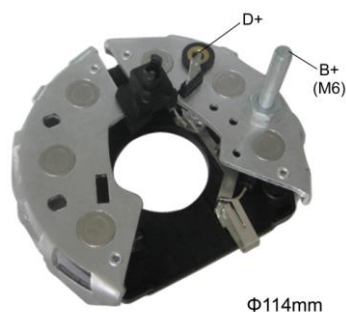

12424800 / BHP11440

FEATURES

Diodes: 6-35A Ampere
 Diameter OD: 114mm
 With M6×50.4mm Battery Post
 With Trio

Original & X-References..

BOSCH 0120488313
 0120488312
 0120488311

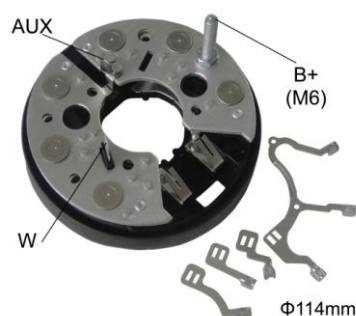

12425300 / BHP11445A

FEATURES

Diodes: 6-35A Avalanche
 Diameter OD: 114mm
 With M6×52.5 Battery Post

Original & X-References..

BOSCH 9120061105

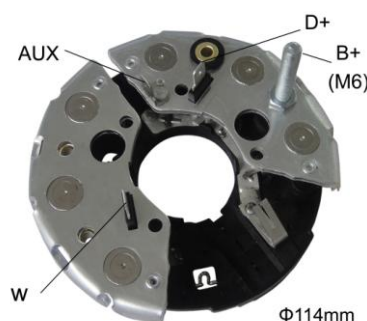

12425400 / BHP11446

FEATURES

Diodes: 6-50 A Ampere
 Diameter OD: 114mm
 With M6×50mm Battery Post
 With Trio

Original & X-References..

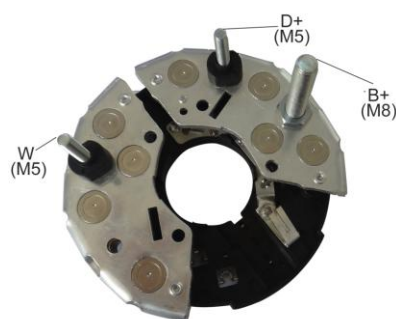

12425900 / BHP11451A

FEATURES

Diodes OD: 8-50A Avalanche
 Diameter: 114mm
 With M8×55.5mm Battery Post
 With M5×39mm Trio Post
 With M5×39mm W-Post
 With Trio

Original & X-References..

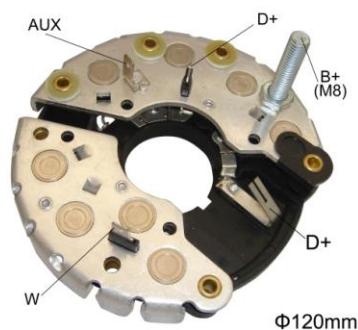

12426200 / BHP121001

FEATURES

Diodes: 8-35 Ampere
 Diameter OD: 120mm
 With M8×52mm Battery Post
 With Trio
 For use on : Audi, VW

Original & X-References..

AUDI/VW 068 903 359 A
 BOSCH 1 127 320 701
 WAI 31-9138
 CARGO 134000
 MOBILETRON RB-76H
 TRANSPO IBR350

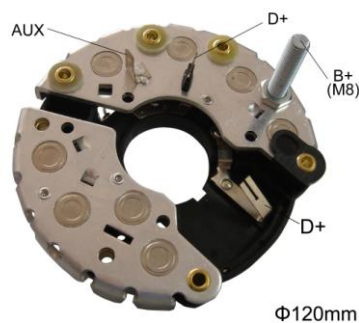

12426300 / BHP121002

FEATURES

Diodes: 8-35 Ampere
 Diameter OD: 120mm
 With M8×52mm Battery Post
 With Trio

FOR USE ON: Audi, Fiat, Ford

Original & X-References..

BOSCH	1 127 320 700
	1 127 320 730
WAI	31-9106
CARGO	132103
MOBILETRON	RB-51H
TRANSPO	IBR351

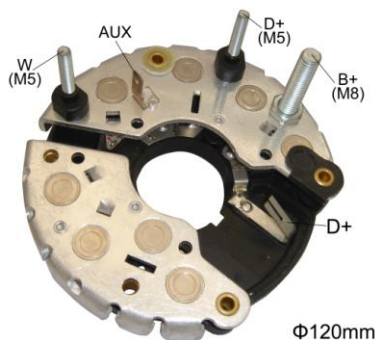

12426500 / BHP121004

FEATURES

Diodes: 8-35 Ampere
 Diameter OD: 120mm
 With M8×52mm Battery Post
 With M5×48mm Trio Post
 With M5×48mm W-Post
 With Trio

For use on : BMW, Ford, Merkur

Original & X-References..

BOSCH	1 127 320 706
CARGO	134002
MOBILETRON	RB-53H
TRANSPO	IBR353

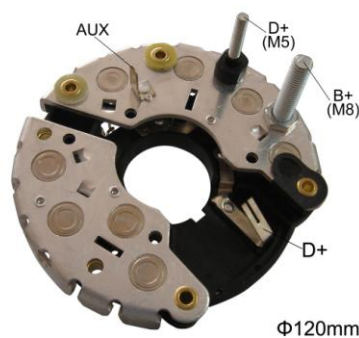

12426600 / BHP121005

FEATURES

Diodes: 8-35 Ampere
 Diameter OD: 120mm
 With M8×52mm Battery Post
 With M5×48mm Trio Post
 With Trio

For use on : Audi, BMW, Mercedes Benz, Opel, VW

Original & X-References..

BOSCH		
	1 127 320 705	1 127 320 710
	1 127 320 723	1 127 320 728
	1 127 320 732	1 127 320 739
	1 127 320 745	1 127 320 749
MOBILETRON		RB-54H
CARGO		138082
TRANSPO		IBR354

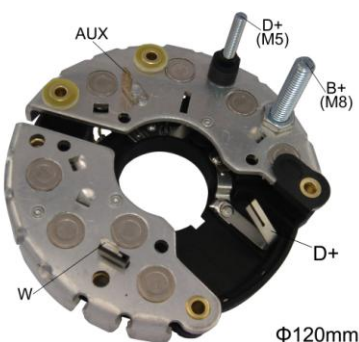

12426700 / BHP121006

FEATURES

Diodes: 8-35 Ampere
 Diameter OD: 120mm
 With M8×52mm Battery Post
 With M5×48mm Trio Post
 With Trio
 Without Capacitor

12427600 / BHP121015

With Capacitor

Original & X-References..

BOSCH	1 127 320 708
	1 127 320 731
WAI	31-9133
CARGO	134003
MOBILETRON	RB-56H
TRANSPO	IBR357



12426800 / BHP121007

FEATURES

Diodes: 8-35 Ampere
 Diameter OD: 120mm
 With (M8+M6) ×54.6 Battery Post
 With M5×48mm Trio Post
 With Trio

For use on : Volvo

Original & X-References..

BOSCH	1 127 320 712
	1 127 320 735
WAI	31-9132
CARGO	139169
MOBILETRON	RB-58H
TRANSPO	IBR712

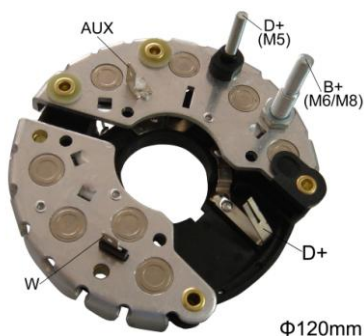

12426900 / BHP121008

FEATURES

Diodes: 8-35 Ampere
 Diameter OD: 120mm
 With (M8+M6) $\times 54.6$ Battery Post
 With M5 $\times 48\text{mm}$ Trio Post
 With Trio
 For use on : Volvo 240 ,740 ,760 ,940 Series

Original & X-References..

BOSCH	1 127 320 716
VOLVO	3515707

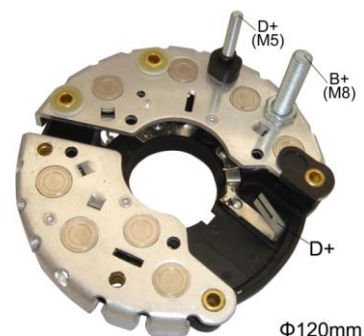

12427000 / BHP121009

FEATURES

Diodes: 8-35 Ampere
 Diameter OD: 120mm
 With M8 $\times 52\text{mm}$ Battery Post
 With M5 $\times 48\text{mm}$ Trio Post
 With Trio

Original & X-References..

BOSCH	1 127 320 720
	1 127 320 741
	1 127 320 911
MOBILETRON	RB-77H
CARGO	136372
TRANSPO	IBR720

For use on : BMW 525i,735i



12427100 / BHP121010

FEATURES

Diodes: 6-35 Ampere
 Diameter OD: 120mm
 With (M8+M6) $\times 54.6\text{mm}$ Battery Post
 With M5 $\times 48\text{mm}$ Trio Post
 With Trio

Original & X-References..

BOSCH	1 127 320 713
CARGO	138620
MOBILETRON	RB-59H
TRANSPO	IBR713

For use on : Volvo 740, 760, 780, 940 Series

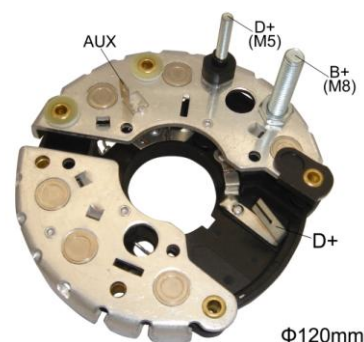

12427200 / BHP121011

FEATURES

Diodes: 6-35 Ampere
 Diameter OD: 120mm
 With M8 $\times 52\text{mm}$ Battery Post
 With M5 $\times 48\text{mm}$ Trio Post
 With Trio

Original & X-References..

BOSCH	1 127 320 702
	1 127 320 709
	1 127 320 722
WAI	31-9109
MOBILETRON	RB-55H
TRANSPO	IBR355

For use on : BMW, Opel, Saab



12427300 / BHP121012

FEATURES

Diodes: 6-35 Ampere
 Diameter OD: 120mm
 With (M8+M6) $\times 54.6\text{mm}$ Battery Post
 Without Trio
 For use on : Chrysler, Dodge, Plymouth

Original & X-References..

BOSCH	1 127 320 718
	1 127 320 719
WAI	31-9110
	31-9146
CARGO	138987
MOBILETRON	RB-75H
TRANSPO	IBR329

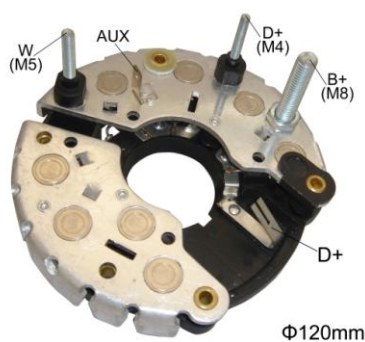

Φ120mm

12427400 / BHP121013

FEATURES

Diodes: 8-35 Ampere
 Diameter OD: 120mm
 With M8×52mm Battery Post
 With M4×48mm Trio Post
 With M5×48mm W-Post
 With Trio

12427410 / BHP121013A

Diodes: 8-35 A Avalanche
12427420 / BHP121013B
 For 24V Alternators

Original & X-References..

BOSCH	1 127 320 750	1 127 320 753
TRANSPO		IBR753
CARGO		231451

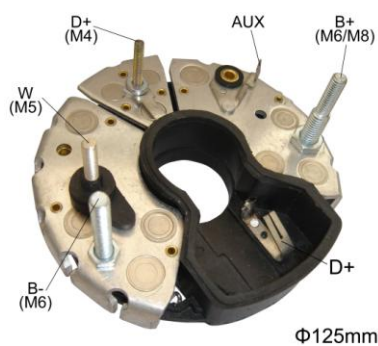

Φ125mm

12429500 / BHP12501

FEATURES

Diodes: 8-50 Ampere
 Diameter OD: 125mm
 With (M8+M6) ×54.6mm Battery Post
 With M4×32.5mm Trio Post
 With M6×52mm Ground Post
 With Trio

12429600 / BHP12501-1

Diodes: 8-50 Ampere
 With black positive heat sink

Original & X-References..

BOSCH	1 127 320 590	1 127 320 977
CARGO		134609
MOBILETRON		RB-63H
TRANSPO		IBR590

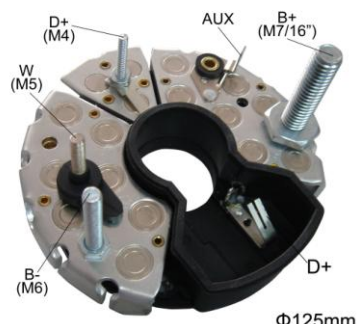

Φ125mm

12429700 / BHP12503

FEATURES

Diodes: 14-50 Ampere
 Diameter OD: 125mm
 With 7/16" Battery Post
 With M4×32.5mm Trio Post
 With M6×52mm Ground Post
 With M5 W-Post
 With Trio

Original & X-References..

BOSCH	1127320954
CARGO	136737
MOBILETRON	RB-67H
TRANSPO	IBR954

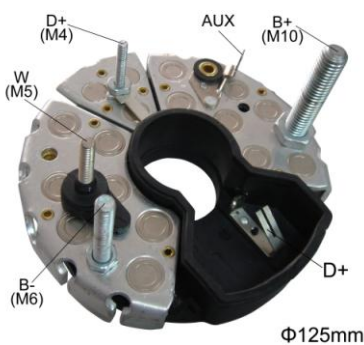

Φ125mm

12429800 / BHP12504

FEATURES

Diodes: 14-50 Ampere
 Diameter OD: 125mm
 With M10×63mm Battery Post
 With M4×32.5mm Trio Post
 With M6×52mm Ground Post
 With M5 W-Post
 With Trio

12429810 / BHP12504A

Diodes: 14-50 A Avalanche

Original & X-References..

BOSCH	1127320920
CARGO	136737
MOBILETRON	RB-67H
TRANSPO	IBR954

TRANSPO	IBR954A
---------	---------



Φ125mm

12429920 / BHP12505B

FEATURES

Diodes: 8-35 A Avalanche
 Diameter OD: 125mm
 With 7/16" Battery Post
 With M4×32.5mm Trio Post
 With M6×52mm Ground Post
 With M5 W-Post
 With Trio
 For 24V Alternators

Original & X-References..

BOSCH	1127320957
TRANSPO	IBR957

12429900 / BHP12505

Diodes: 8-50 Ampere

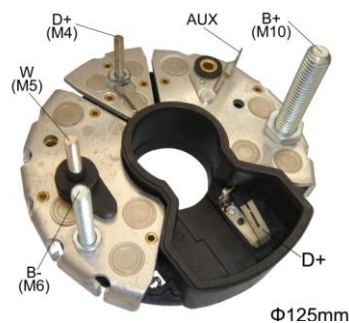

Φ125mm

1242A200 / BHP12506

FEATURES

Diodes: 8-50 Ampere
 Diameter OD: 125mm
 With M10×63mm Battery Post
 With M4×32.5mm Trio Post
 With M6×52mm Ground Post
 With M5 W-Post
 With Trio

Original & X-References..

BOSCH 9127337304

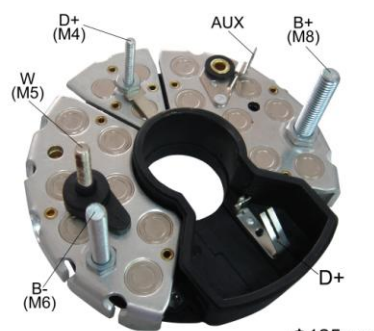

Φ125mm

1242A400 / BHP12509

FEATURES

Diodes: 14-50 Ampere
 Diameter OD: 125mm
 With M8×52mm Battery Post
 With M4×32.5mm Trio Post
 With M6×52mm Ground Post
 With M5 W-Post
 With Trio
 For use on : DAF, Mercedes, Saab
 scania, Volvo-White Truck

Original & X-References..

BOSCH
 1 127 320 959 1 127 320 961
 WAI 31-9142
 CARGO 131468
 MOBILETRON RB-62H
 TRANSPO IBR341

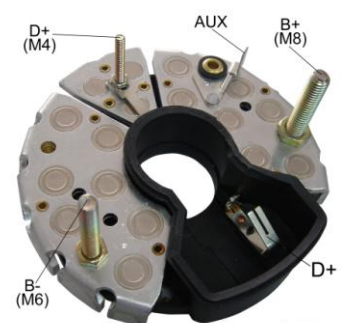

Φ125mm

1242A700 / BHP12510

FEATURES

Diodes: 14-50 Ampere
 Diameter OD: 125mm
 With M8×52mm Battery Post
 With M4×32.5mm Trio Post
 With M6×52mm Ground Post
 With Trio
 For use on : Mercedes, Saab scania,
 Volvo Truck

Original & X-References..

BOSCH 1 127 320 361
 1 127 320 543
 WAI 31-9115
 CARGO 133530
 MOBILETRON RB-72H
 TRANSPO IBR340

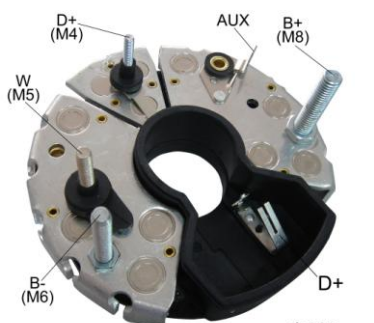

Φ125mm

1242A800 / BHP12511

FEATURES

Diodes: 8-50 Ampere
 Diameter OD: 125mm
 With M8×52mm Battery Post
 With M4×32.5mm Trio Post
 With M6×52mm Ground Post
 With M5 W-Post
 With Trio

Original & X-References..

BOSCH
 1 127 320 602 1 127 320 924
 1 127 320 951 1 127 320 955
 1 127 320 956 1 127 320 980
 1 127 320 981
 TRANSPO IBR955
 BOSCH 1 127 320 989
 CARGO 136832
 TRANSPO IBR989

1242A810 / BHP12511A

Diodes: 8-50 A Avalanche

1242A820 / BHP12511B

Diodes: 8-35 A Avalanche

For 24V Alternators

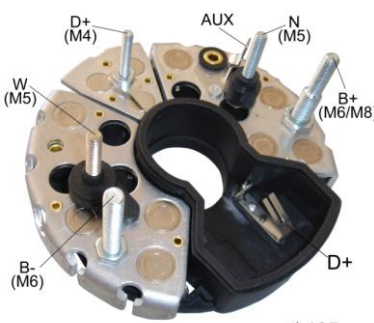

Φ125mm

1242AG00 / BHP12517

FEATURES

Diodes: 8-50 Ampere
 Diameter OD: 125mm
 With (M8+M6) ×54.6 Battery Post
 With M4×32.5mm Trio Post
 With M6×52mm Ground Post
 With M5×25mm N-Post
 With M5 W-Post
 With Trio

Original & X-References..



1242AH00 / BHP12519

FEATURES

Diodes: 8-50 Ampere
 Diameter OD: 125mm
 With (M8+M6) ×54.6mm Battery Post
 With M4×32.5mm Trio Post
 With M6×52mm Ground Post
 With Trio

Original & X-References..

BOSCH	1 127 320 517
	1 127 320 603
CARGO	231218
TRANSPO	IBR517

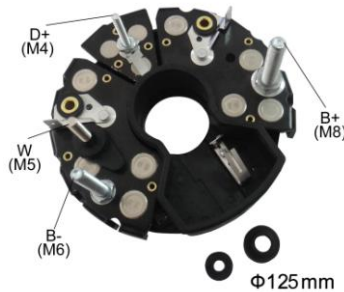

1242AK00 / BHP12522B

FEATURES

Diodes: 8-50 A Avalanche
 Diameter: 125mm
 With M8×52mm Battery Post
 With M4×32.5mm Trio Post
 With M6×52mm Ground Post
 With M5 W-Post
 With Trio For 24V Alternator

Original & X-References..

1242AL00 / BHP14501



FEATURES

Diodes: 12-50 Ampere
 Diameter OD: 145mm
 With M8×52mm Battery Post
 With M5×34.5mm Trio Post
 With M8×52mm Ground Post
 With 3-35A Diode Trio
 For use on : Bus, Industrial

Original & X-References..

BOSCH	1 127 320 550
MOBILETRON	RB-78HA
CARGO	136581
TRANSPO	IBR973 / IBR550

1242B900 / BHP14501B

Diodes: 12-35A Avalanche
 For 24V Alternators

MOBILETRON	RB-78H
------------	--------



1242AM00 / BHP14502

FEATURES

Diodes: 14-50 Ampere
 Diameter OD: 145mm
 With M8×52mm Battery Post
 With M8×52mm Ground Post
 With M5×34.5mm Trio Post
 With M5×25mm "W" Post

Original & X-References..

BOSCH	1 127 320 547
	1 127 320 571
CARGO	136581
MOBILETRON	RB-78H
TRANSPO	IBR547

1242BA00 / BHP14502B

Diodes: 14-35 A Avalanche
 With M5×29.8mm "W" Post

For use on: MAN Buses



1242AY00 / BHP14507

FEATURES

Diodes: 14-50 Ampere
 Diameter OD: 145mm
 With M8×52mm Battery Post
 With M8×52mm Ground Post
 With M5×34.5mm Trio Post
 With M6 "W" Post

Original & X-References..

BOSCH	1127320973
TRANSPO	IBR973

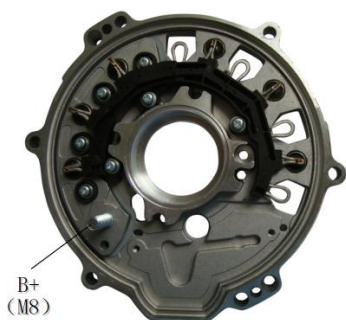

12444200 / BHP14508A1

FEATURES	Original & X-References..	
Diodes: 6-60A Avalanche	LESTER	13815
With M8×30mm Battery Post	TRANSPO	IBR2201



1243AS00 / BHP12015 (Y)

FEATURES	Original & X-References..	
Diodes: 6-50A Avalanche	BOSCH	F00M 123202
Diameter OD: 120mm	0 124 415 001	0 124 415 002
With M8×32mm Battery Post(L)	0 124 415 005	0 124 415 006
With M8×22mm Battery Post(R)	0 124 415 008	0 124 415 009
For use on : Opel Astra, Corsa, Zafira, Ford Modeo	MOBILETRON	RB-115H
	CARGO	230360
	TRANSPO	IBR202

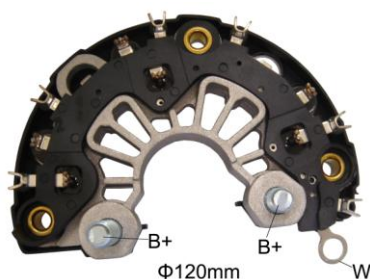

12430200 / BHP12016B (Δ)

FEATURES	Original & X-References..	
Diodes: 6-35A Avalanche		
Diameter OD: 120mm		
With M8×32mm Battery Post(L)		
With M8×22mm Battery Post(R)		
For 24V Alternators		
12435700 / BHP12069B	BOSCH	F00M 133224
Diodes: 6-35 A Avalanche	TRANSPO	IBR224
For 24V Alternators	CARGO	235051

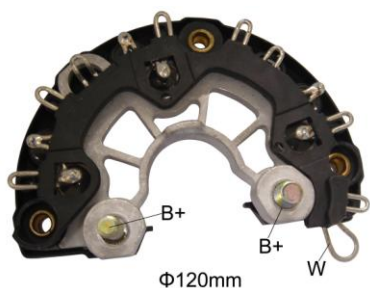

12430400 / BHP12017 (Y)

FEATURES	Original & X-References..	
Diodes: 6-50A Avalanche	BOSCH	0 124 315 019
Diameter OD: 120mm		0 124 315 027
With M6×35mm Battery Post(L)		0 124 325 100
With M8×22mm Battery Post(R)		IBR233
12431900 / BHP12027	TRANSPO	
Diodes: 8-50A Avalanche		
12433900 / BHP12048		
Diodes: 6-50A Avalanche		
With M8×38mm Battery Post(L)		
With M8×22mm Battery Post(R)		



12430600 / BHP12019 (Y)

FEATURES	Original & X-References..	
Diodes: 6-50A Avalanche	CARGO	231714
Diameter OD: 120mm		
With M8×32mm Battery Post(L)		
With M8×22mm Battery Post(R)		

12430700 / BHP12019-1
Diodes: 8-50A Avalanche

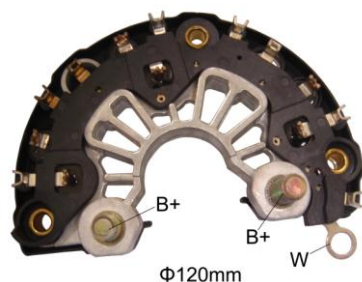
12430800 / BHP12020 (Y)**FEATURES**

Diodes: 6-50A Avalanche
 Diameter OD: 120mm
 With M8×22mm Battery Post(L)
 With M8×32mm Battery Post(R)

Original & X-References..

BOSCH	0 124 325 051
	F00M 123226
MOBILETRON	RB-926H
CARGO	235546
TRANSPO	IBR229

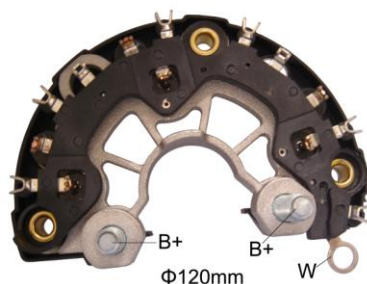
12430900 / BHP12021 (Y)**FEATURES**

Diodes: 6-50A Avalanche
 Diameter OD: 120mm
 With M8×22mm Battery Post(L)
 With M8×32mm Battery Post(R)

Original & X-References..**12431200 / BHP12024**

Diodes: 8-50A Avalanche

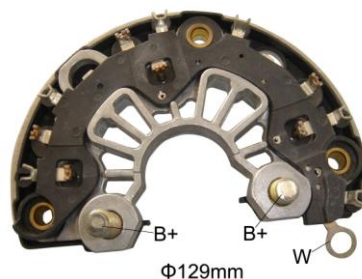
12431010 / BHP12022HD (△)**FEATURES**

Diodes: 6-50A Avalanche
 Diameter OD: 129mm
 With M8×32mm Battery Post(L)
 With M8×22mm Battery Post(R)
 With 129 mm Negative heat sink

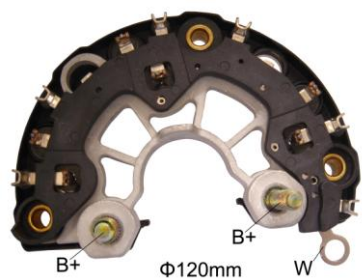
Original & X-References..**12431100 / BHP12023 (△)****FEATURES**

Diodes: 6-50A Avalanche
 Diameter OD: 120mm
 With M8×22mm Battery Post(L)
 With M6×35mm Battery Post(R)

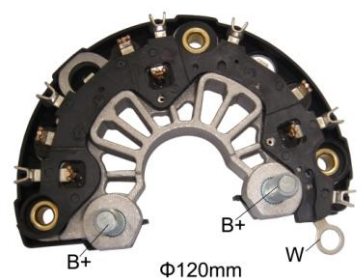
Original & X-References..**12431300 / BHP12025 (△)****FEATURES**

Diodes: 6-50A Avalanche
 Diameter OD: 120mm
 With M8×32mm Battery Post(L)
 With M8×32mm Battery Post(R)

Original & X-References..**12431310 / BHP12025B**

Diodes: 6-35A Avalanche
 For 24V Alternators

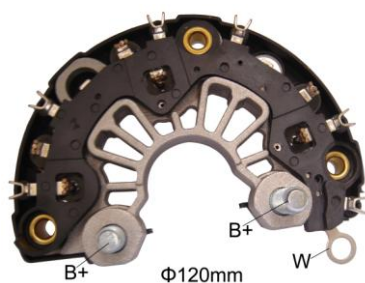
**12431400 / BHP12025-1** (△)**FEATURES**

Diodes: 6-50A Avalanche
 Diameter OD: 120mm
 With M8×22mm Battery Post(L)
 With M8×32mm Battery Post(R)
12434000 / BHP12049HD
 Diodes: 6-60A Avalanche
 With M8×22mm Battery Post(L)
 With M6×47mm Battery Post(R)

Original & X-References..

BOSCH	F00M 133201
F00M 133205	F00M 133228
F00M 133241	F00M 133246
MOBILETRON	RB-119H
CARGO	133921
TRANSPO	IBR201

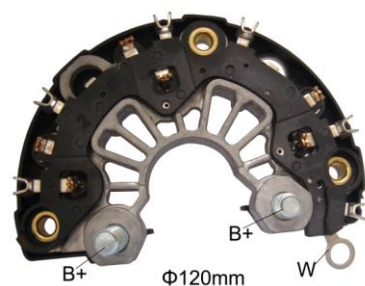
**12431500 / BHP12025-2** (△)**FEATURES**

Diodes: 6-50A Avalanche
 Diameter OD: 120mm
 With M8×32mm Battery Post(L)
 With M8×22mm Battery Post(R)
12433800 / BHP12047HD
 Diodes: 6-50A Avalanche
 With M6×38mm Battery Post(L)
 With M8×22mm Battery Post(R)

Original & X-References..

BOSCH	F00M 133200
TRANSPO	IBR200

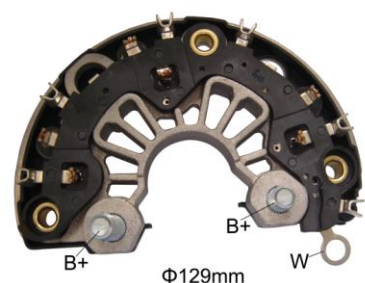
**12431700 / BHP12026** (△)**FEATURES**

Diodes: 6-50A Avalanche
 Diameter OD: 129mm
 With M8×22mm Battery Post(L)
 With M8×32mm Battery Post(R)
 With 129 mm Negative heat sink

Original & X-References..**12431720 / BHP12026B** (△)**FEATURES**

Diodes: 6-50A Avalanche
 Diameter OD: 129mm
 With M8×34.5mm Battery Post(L)
 With M8×22mm Battery Post(R)
 For 24V Alternators
 With 129 mm Negative heat sink

Original & X-References..

BOSCH	F00M 133291
	F00M 133223

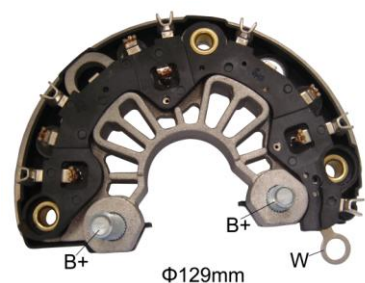
**12438200 / BHP12092B**

With M8×34.5mm Battery Post(L)
 With M8×34.5mm Battery Post(R)
 For 24V Alternators

**12432000 / BHP12030** (△)**FEATURES**

Diodes: 6-50A Avalanche
 Diameter OD: 120mm
 With M8×22mm Battery Post(L)
 With M8×32mm Battery Post(R)
12432010 / BHP12030HD
 Diodes: 6-60A Avalanche

Original & X-References..

BOSCH	F00M 133207
0 124 515 035	0 124 515 057
CARGO	230374
TRANSPO	IBR207

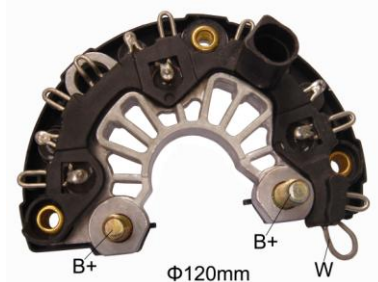
12432100 / BHP12031 (Y)**FEATURES**

Diodes: 6-50A Avalanche
 Diameter OD: 120mm
 With M8×22mm Battery Post(L)
 With M8×32mm Battery Post(R)

Original & X-References..**12435500 / BHP12067**

Diodes: 8-50A Avalanche

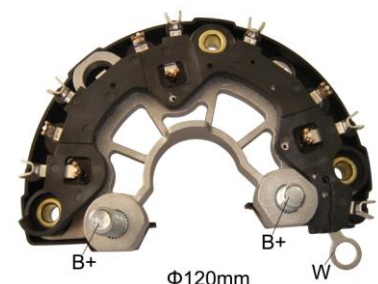
12432200 / BHP12032 (Δ)**FEATURES**

Diodes: 6-50A Avalanche
 Diameter OD: 120mm
 With M8×32mm Battery Post(L)
 With M8×22mm Battery Post(R)

Original & X-References..

BOSCH	F00M 123237
TRANSPO	IBR2237

12432300 / BHP12033 (Y)**FEATURES**

Diodes: 6-50A Avalanche
 Diameter OD: 120mm
 With M8×22mm Battery Post(L)
 With M8×34.5mm Battery Post(R)

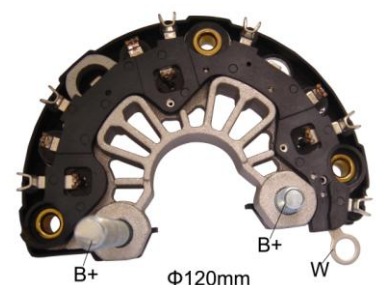
Original & X-References..**12432510 / BHP12035HD (Δ)****FEATURES**

Diodes: 6-60Ampere
 Diameter OD: 120mm
 With M8×59.5mm Battery Post(L)
 With M8×22mm Battery Post(R)

Original & X-References..

BOSCH	F00M 133225
MOBILETRON	RB-180HV
TRANSPO	IBR256

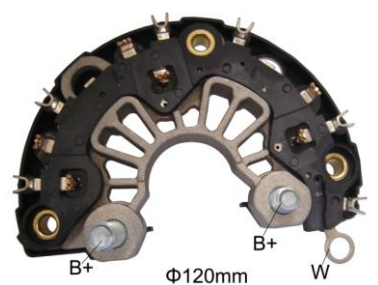
12432600 / BHP12036B (Δ)**FEATURES**

Diodes: 6-35A Avalanche
 Diameter OD: 120mm
 With M8×34.5mm Battery Post(L)
 With M8×22mm Battery Post(R)
 For 24V Alternators

Original & X-References..**12432620/BHP12036BHD**

Diodes: 6-50A Avalanche

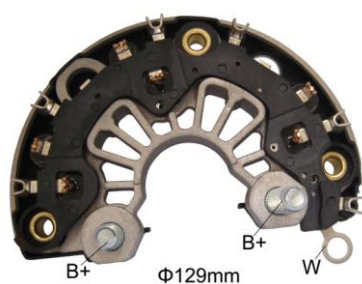
**12432700 / BHP12037** (△)**FEATURES**

Diodes: 6-50A Avalanche
 Diameter OD: 129mm
 With M8×22mm Battery Post(L)
 With M8×38mm Battery Post(R)
 With 129 mm Negative heat sink

Original & X-References..

BOSCH F00M 133237
 F00M 133340
 TRANSPO IBR237

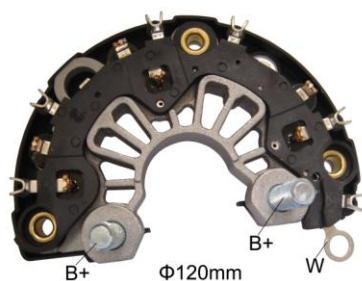
**12432800 / BHP12038B** (△)**FEATURES**

Diodes: 6-50A Avalanche
 Diameter OD: 120mm
 With M8×34.5mm Battery Post(L)
 With M8×38mm Battery Post(R)
 For 24V Alternators

Original & X-References..**1243290 / BHP12039B** (△)**FEATURES**

Diodes: 6-50A Avalanche
 Diameter OD: 120mm
 With M8×34.5mm Battery Post(L)
 With M8×34.5mm Battery Post(R)
 For 24V Alternators

Original & X-References..

BOSCH F00M 133223
 MOBILETRON RB-115H
 CARGO 231524
 TRANSPO IBR223

**12433000 / BHP12040** (△)**FEATURES**

Diodes: 6-50A Avalanche
 Diameter OD: 129mm
 With M8×22mm Battery Post(L)
 With M8×34.5mm Battery Post(R)
 With 129 mm Negative heat sink

Original & X-References..**12433200 / BHP12041** (△)**FEATURES**

Diodes: 6-50A Avalanche
 Diameter OD: 120mm
 With M8×38mm Battery Post(L)
 With M8×22mm Battery Post(R)

Original & X-References..

BOSCH F00M 133202
 MOBILETRON RB-117HV
 TRANPO IBR225

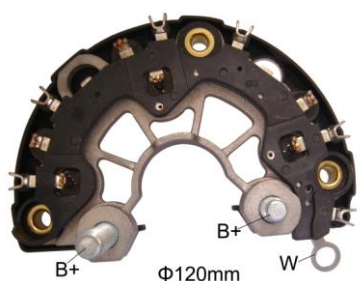

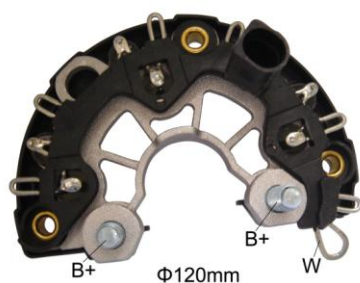
**12433300 / BHP12042 (Δ)****FEATURES**

Diodes: 6-50A Avalanche
 Diameter OD: 120mm
 With M8×32mm Battery Post(L)
 With M8×22mm Battery Post(R)

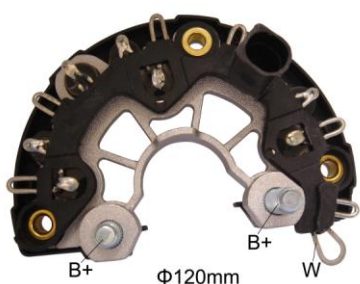
Original & X-References..**12433400 / BHP12043 (Y)****FEATURES**

Diodes: 8-50A Avalanche
 Diameter OD: 120mm
 With M8×32mm Battery Post(L)
 With M8×22mm Battery Post(R)

Original & X-References..**12433510 / BHP12044HD (Δ)****FEATURES**

Diodes: 6-50A Avalanche
 Diameter OD: 129mm
 With M8×22mm Battery Post(L)
 With M8×50mm Battery Post(R)
 With 129 mm Negative heat sink

Original & X-References..

BOSCH	F00M 133226
TRANSPO	IBR226

**12433710 / BHP12046HD (Δ)****FEATURES**

Diodes: 6-50A Avalanche
 Diameter OD: 129mm
 With M8×22mm Battery Post(L)
 With M6×51mm Battery Post(R)
 With 129 mm Negative heat sink

Original & X-References..

BOSCH	F00M 133277
MOBILETRON	RB-954H
TRANSPO	IBR277

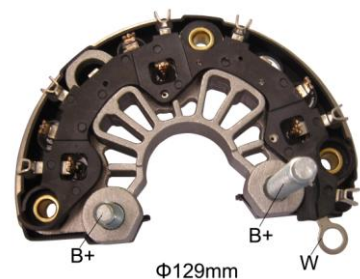
**12434200 / BHP12051HD (Δ)****FEATURES**

Diodes: 6-50A Avalanche
 Diameter OD: 129mm
 With M8×26mm Battery Post(L)
 With M8×50mm Battery Post(R)
 With 129 mm Negative heat sink

Original & X-References..

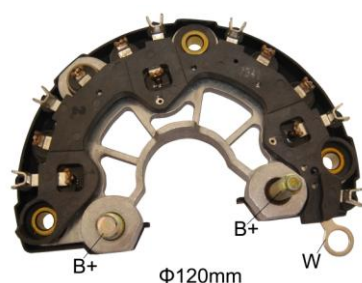
**12434300 / BHP12052 (Y)****FEATURES**

Diodes: 6-50A Avalanche
 Diameter OD: 120mm
 With M8×22mm Battery Post(L)
 With M6×35mm Battery Post(R)
 With big insulator hole

Original & X-References..

BOSCH F00M 123234
 F00M 123335
 CARGO 235052
 TRANSPO IBR234

12432400 / BHP12034

Diodes: 8-50A Avalanche

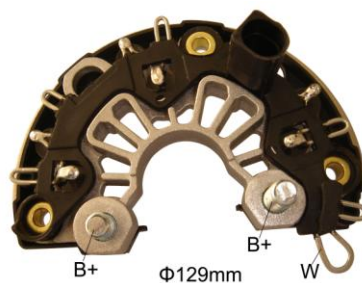
**12434400 / BHP12053 (Δ)****FEATURES**

Diodes: 6-50A Avalanche
 Diameter OD: 129mm
 With M8×22mm Battery Post(L)
 With M8×32mm Battery Post(R)
 With 129 mm Negative heat sink

Original & X-References..**12434520 / BHP12054HD (Δ)****FEATURES**

Diodes: 6-50A Avalanche
 Diameter OD: 129mm
 With M8×34.5mm Battery Post(L)
 With M8×34.5mm Battery Post(R)
 With 129 mm Negative heat sink

Original & X-References..

BOSCH F00M 133237
 TRANSPO IBR237

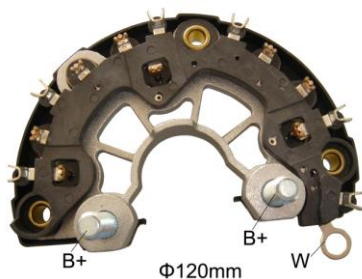
12434600 / BHP12055 (Y)**FEATURES**

Diodes: 8-50A Avalanche
 Diameter OD: 120mm
 With M8×32mm Battery Post(L)
 With M8×32mm Battery Post(R)

Original & X-References..**12435400 / BHP12066**

Diodes: 6-50A Avalanche

**12431740 / BHP12056 (Δ)****FEATURES**

Diodes: 6-50A Avalanche
 Diameter OD: 129mm
 With M8×34.5mm Battery Post(L)
 With M8×22mm Battery Post(R)
 With 129 mm Negative heat sink

Original & X-References..

BOSCH F00M 133257
 F00M 133293
 LESTER 11217
 TRANSPO IBR257

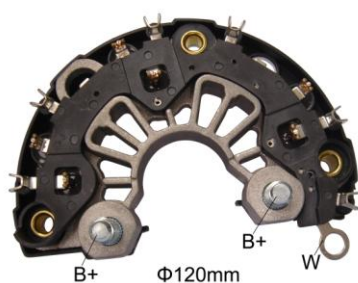
**12430310 / BHP12057 (Δ)****FEATURES**

Diodes: 6-50Ampere
 Diameter OD: 120mm
 With M8×26mm Battery Post(L)
 With M8×22mm Battery Post(R)

Original & X-References..**12434800 / BHP12059 (Y)****FEATURES**

Diodes: 8-50A Avalanche
 Diameter OD: 120mm
 With M8×26mm Battery Post(L)
 With M8×34.5mm Battery Post(R)

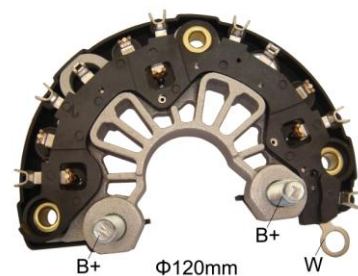
Original & X-References..**12435000 / BHP12062 (Y)****FEATURES**

Diodes: 6-50A Avalanche
 Diameter OD: 120mm
 With M8×32mm Battery Post(L)
 With M8×32mm Battery Post(R)

Original & X-References..**12434900 / BHP12060B**

Diodes: 8-35A Avalanche
 For 24V Alternators

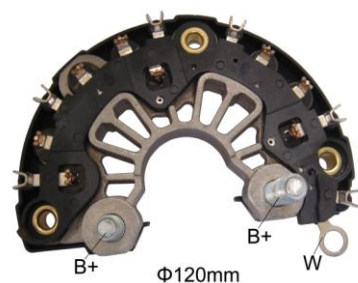
**12435100 / BHP12063 (Y)****FEATURES**

Diodes: 8-50A Avalanche
 Diameter OD: 120mm
 With M8×22mm Battery Post(L)
 With M8×38mm Battery Post(R)

Original & X-References..**12439200 / BHP120103**

With M8×26mm Battery Post(L)
 With M8×22mm Battery Post(R)

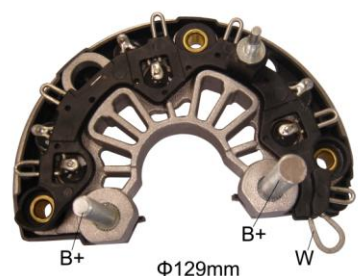
**12435220 / BHP12064HD (Δ)****FEATURES**

Diodes: 6-50A Avalanche
 Diameter OD: 129mm
 With M6×47mm Battery Post(L)
 With M8×47mm Battery Post(R)
 With 129 mm negative heat sink

Original & X-References..**12435210 / BHP12064B**

Diodes: 6-50A Avalanche
 For 24V Alternators

BOSCH	F00M 133279
TRANSPO	IBR279
FIT REGULATOR	IB260
FIT COVER	C-006



Φ120mm

12435310 / BHP12065HD (Δ)

FEATURES

Diodes: 6-50A Avalanche
 Diameter OD: 120mm
 With M8×34.5mm Battery Post(L)
 With M8×34.5mm Battery Post(R)

Original & X-References..

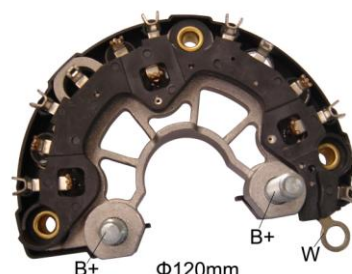

B+ Φ120mm W

12435800 / BHP12070 (Y)

FEATURES

Diodes: 6-50A Avalanche
 Diameter OD: 120mm
 With M8×22mm Battery Post(L)
 With M8×32mm Battery Post(R)

Original & X-References..

BOSCH	F00M 123227
	F00M 123244
	F00M 123201
MOBILETRON	RB-116H
TRANSPO	IBR244

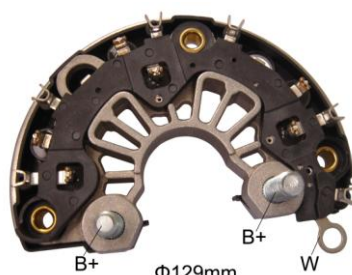

B+ Φ129mm W

12436100 / BHP12072 (Δ)

FEATURES

Diodes: 6-50A Avalanche
 Diameter OD: 129mm
 With M8×26mm Battery Post(L)
 With M8×34.5mm Battery Post(R)
 With 129 mm Negative heat sink

Original & X-References..

BOSCH	F00M 133265
-------	-------------

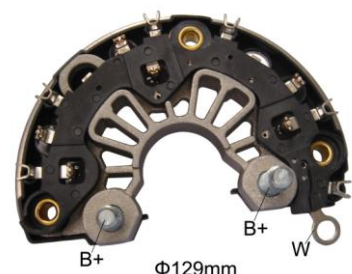

B+ Φ129mm W

12436200 / BHP12073 (Δ)

FEATURES

Diodes: 6-60A Ampere
 Diameter OD: 129mm
 With M8×22mm Battery Post(L)
 With M8×32mm Battery Post(R)
 With 129 mm Negative heat sink

Original & X-References..

BOSCH	F00M 133215
F00M 133218	F00M 133247
MOBILETRON	RB-929H
CARGO	235218
TRANSPO	IBR215

12436320 / BHP12073HD

Diodes: 6-70A Avalanche

MOBILETRON	RB-954HV
------------	----------

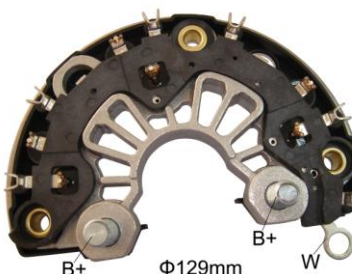

B+ Φ129mm W

12436400 / BHP12074 (Δ)

FEATURES

Diodes: 6-50A Avalanche
 Diameter OD: 129mm
 With M8×28.5mm Battery Post(L)
 With M8×26mm Battery Post(R)
 With 129 mm Negative heat sink

Original & X-References..

BOSCH	F00M 133208
	F00M133266
	F00M133347
LESTER	23302 20005
	21790 21791 23228
CARGO	233469
TRANSPO	IBR266



Φ120mm

12436500 / BHP12075 (Y)**FEATURES**

Diodes: 8-50A Avalanche
 Diameter OD: 120mm
 With M8×32mm Battery Post(L)
 With M8×32mm Battery Post(R)

Original & X-References..

Φ129mm

12436600 / BHP12076 (Δ)**FEATURES**

Diodes: 6-50A Avalanche
 Diameter OD: 129mm
 With M8×26mm Battery Post(L)
 With M8×26mm Battery Post(R)
 With 129 mm Negative heat sink

Original & X-References..

BOSCH	F00M 133208
F00M133266	F00M133347
LESTER	23302 20005
21790	21791 23228
CARGO	233469
TRANSPO	IBR266



Φ120mm

12436800 / BHP12077 (Y)**FEATURES**

Diodes: 6-50A Avalanche
 Diameter OD: 120mm
 With M8×22mm Battery Post(L)
 With M8×32mm Battery Post(R)

Original & X-References..

BOSCH	F00M 113200
CARGO	139915
MOBILETRON	RB-118H
TRANSPO	IBR1200



Φ129mm

12437110 / BHP12080HD (Δ)**FEATURES**

Diodes: 6-50A Avalanche
 Diameter OD: 129mm
 With M8×38mm Battery Post(L)
 With M8×22mm Battery Post(R)
 With 129 mm Negative heat sink

Original & X-References..

BOSCH	F00M 133274
F00M 133292	
TRANSPO	IBR274



Φ120mm

12437200 / BHP12081A (Δ)**FEATURES**

Diodes: 6-50A Avalanche
 Diameter OD: 120mm
 With M8×32mm Battery Post(L)
 With M8×32mm Battery Post(R)

Original & X-References..

BOSCH	F00M 133209
-------	-------------

12437400 / BHP12083HD (△)



Φ120mm

FEATURES

Diodes: 6-50A Avalanche
 Diameter OD: 120mm
 With M6×35mm Battery Post(L)
 With M6×35mm Battery Post(R)

Original & X-References..

BOSCH	
F00M 123233	F00M 123234
F00M 123254	F00M 123335
CARGO	233524
TRANSP0	IBR233-2

12437700 / BHP12086 (Y)



B+ Φ120mm W

FEATURES

Diodes : 6-50 Avalanche
 Diameter OD: 120mm
 With M8×22mm Battery Post (L)
 With M8×34.5mm Battery Post (R)

Original & X-References..

BOSCH	F00M 144002
-------	-------------

12438400 / BHP12094 (△)

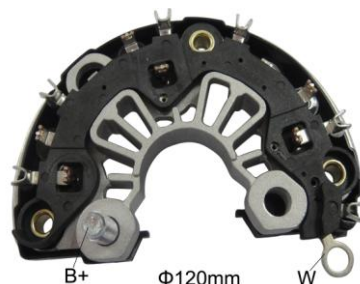

B+ Φ120mm W

FEATURES

Diodes: 6-50A Avalanche
 Diameter OD: 129mm
 With M8×32mm Battery Post(L)
 With 129 mm Negative heat sink

Original & X-References..

BOSCH	F00M 133298
TRANSP0	IBR212

12438500 / BHP12095 (Y)



B+ Φ120mm W

FEATURES

Diodes: 8-50A Avalanche
 Diameter OD: 120mm
 With M8×26mm Battery Post(L)
 With M8×26mm Battery Post(R)

Original & X-References..

BOSCH	F00M 113230
-------	-------------

12438900 / BHP12099 (Y)



B+ Φ120mm W

FEATURES

Diodes : 8-50A Avalanche
 Diameter OD:120mm
 With M8×22mm Battery Post (L)
 With M8×34.5mm Battery Post (R)

Original & X-References..

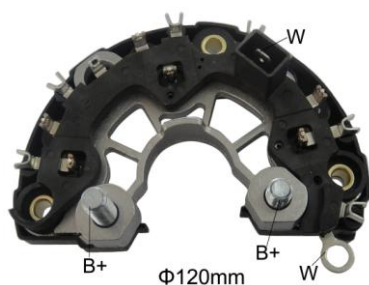

12439000 / BHP120100 (Y)

FEATURES

Diodes : 6-50A Avalanche
 Diameter OD:120mm
 With M8×32mm Battery Post (L)
 With M8×22mm Battery Post (R)

Original & X-References..



12439100 / BHP120101B (Δ)

FEATURES

Diodes : 6-50A Avalanche
 Diameter OD:120mm
 With M8×26mm Battery Post (L)
 With M8×26mm Battery Post (R)
 For 24V Alternators

Original & X-References..

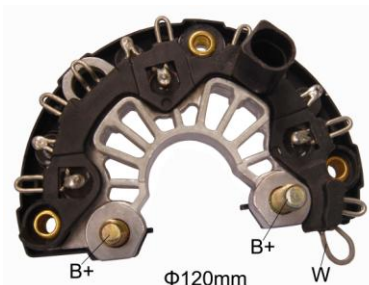

12439700 / BHP120109 (Δ)

FEATURES

Diodes: 6-50A Avalanche
 Diameter OD: 120mm
 With M8×22mm Battery Post(L)
 With M8×34.5mm Battery Post(R)

Original & X-References..

BOSCH	F00M 123255
TRANSPO	IBR208



1243A600 / BHP120120B (Δ)

FEATURES

Diodes: 6-50A Avalanche
 Diameter OD: 129mm
 With M8×34.5mm Battery Post(L)
 With M8×38mm Battery Post(R)
 For 24V Alternators

Original & X-References..



1243AE00 / BHP120133A (Y)

FEATURES

Diodes: 6-50A Avalanche
 Diameter OD: 120mm
 With M6×35mm Battery Post(L)
 With M8×22mm Battery Post(R)

Original & X-References..

BOSCH	0124325064
MOBILETRON	RB-161H



Φ120mm

1243AG00 / BHP120135A (Y)

FEATURES	Original & X-References..	
Diodes: 6-50A Avalanche	BOSCH	0124325067
Diameter OD: 120mm		
With M8×32mm Battery Post(L)		
With M8×22mm Battery Post(R)		



Φ129mm

1243AH00 / BHP120136A (Δ)

FEATURES	Original & X-References..	
Diodes: 6-60A Avalanche	BOSCH	F00M 133287
Diameter OD: 129mm	LESTER	12714
With M8×34.5mm Battery Post (L)	TRANSP0	IBR287
With M8×22mm Battery Post (R)		
With 129mm Negative heat sink		



Φ120mm

1243AI00 / BHP120137A (Δ)

FEATURES	Original & X-References..	
Diodes: 6-50A Avalanche		
Diameter OD: 120mm		
With M8×22mm Battery Post (L)		
With M8×34.5mm Battery Post (R)		



Φ129mm

1243AN00 / BHP120143A (Δ)

FEATURES	Original & X-References..	
Diodes: 6-60 A Avalanche	BOSCH	F00M 133235
Diameter: 129mm		
With M8×22mm Battery Post (L)		
With M8×34.5mm Battery Post (R)		

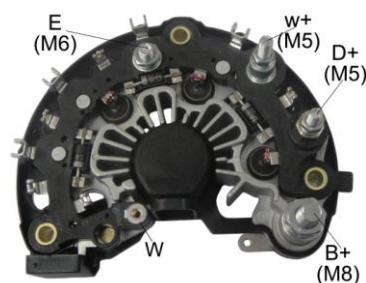
**12439310 / BHP120104HD**

FEATURES	Original & X-References..	
Diodes : 6-60AAvalanche		
With M8×40mm Battery Post		
With M6×32.5mm Ground Post		
With M5 W-Post		
With Trio		
With Capacitor		

1243CD00

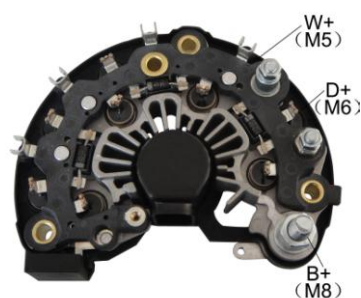

FEATURES

Diodes: 8-50 A Avalanche
 With M8×24mm Battery Post
 With M5 W-Post
 With Trio
 With Capacitor

Original & X-References..

ISKRA 11 204 260

12440500 / BHP12801-006

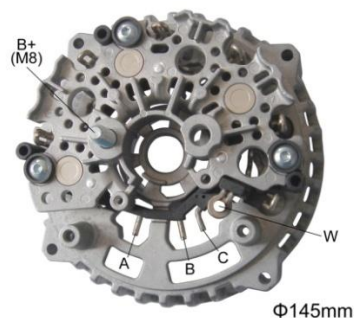

FEATURES

Diodes: 6-50A Avalanche
 Diameter OD: 145mm
 With M8×32mm Battery Post
 With "W" Terminal

Original & X-References..

BOSCH F00M 314001
 0121615003

Customer provide Negative heat sink

12441400 / BHP12804-163

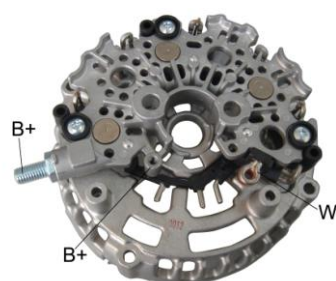

FEATURES

Diodes: 6-60A Avalanche
 With M8×15.5mm Battery Post

Original & X-References..

Customer provide Negative heat sink

12441700 / BHP12805-163

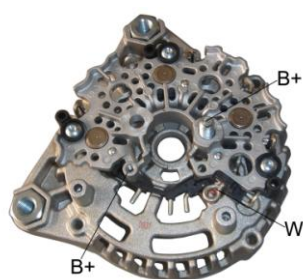

FEATURES

Diodes: 6-60A Avalanche
 With M8×32mm Battery Post

Original & X-References..

Customer provide Negative heat sink

12441800 / BHP12806-163

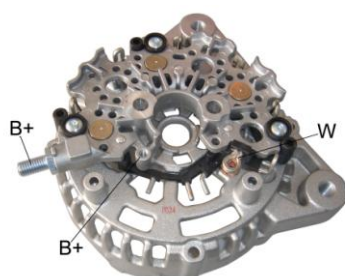

FEATURES

Diodes: 6-60A Avalanche
 With M8×15.5mm Battery Post

Original & X-References..

Customer provide Negative heat sink

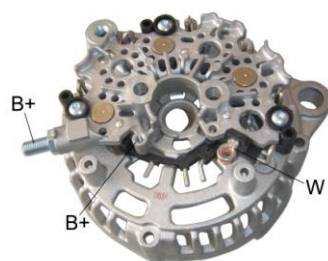
**12441900 / BHP12807-163****FEATURES**

Diodes: 6-60A Avalanche
With M8×15.5mm Battery Post

Original & X-References..

BOSCH F00M 314004

Customer provide Negative heat sink

**12442200 / BHP12811-197****FEATURES**

Diodes:6-50A Avalanche
With M8×32mm Battery Post

Original & X-References..

Customer provide Negative heat sink

**12442800 / BHP12815A****FEATURES**

Diodes: 6-60A Avalanche
Diameter OD: 128mm
With M8×23.5mm Battery Post

Original & X-References..

BOSCH F00M346135

**12449400 / BHP12828AH****FEATURES**

Diodes: 3-60A Avalanche
Diameter: 128mm
With M8×23.5mm Battery Post

Original & X-References..

BOSCH F00M346135

**12443300 / BHP12820A****FEATURES**

Diodes:6-50 A Avalanche
Without Trio

Original & X-References..

12105600 / DC5302-1



FEATURES

Diodes: 6-35A Avalanche Press-Fit
With Aluminum Heat sinks
For: CS121,CS130 Alternators

Original & X-References..

DELCO	10457236	10472597
	10470730	10457690
	1989658	
WAI	31-113-1	31-136
CARGO		131880

12105500 / DC5301-1

Diodes: 6-50A Avalanche Press-Fit

TRANSPO	DR4000
TRANSPO	DR4000HD

12105300 / DC5302D-1



FEATURES

Diodes: 6-35A Avalanche Press-Fit
With M8×46mm Battery Post
With Aluminum Heat sinks
For use on: GM-Vehicles

Original & X-References..

DELCO	10475758
	10492837
	1047578
WAI	31-120
	31-133
	31-133-1
TRANSPO	DR4200
TRANSPO	DR4200HD

12105400 / DC5301D-1

Diodes: 6-50A Avalanche Press-Fit

TRANSPO	DR4200
TRANSPO	DR4200HD

12100900 / DC5164-2D



FEATURES

Diodes: 6-35A Avalanche Press-Fit
With M8×48mm Battery Post
With Aluminum Heat sinks

Original & X-References..

12101400 / DC5263D



FEATURES

Diodes: 6-50A Avalanche
With (M8+M6)×46mm Battery Post

Original & X-References..

DELCO	10480228
TRANSPO	DR4220

For use on: Acura CL 3.0L Honda Accord 3.0L

12101500 / DC5300



FEATURES

Diodes: 6-50A Avalanche

For use on: WAI 1998-2000 Saturn
31-213 SC1,SL Sedan,SW Wagon 1.9L

Original & X-References..

DELCO	10492300
WAI	31-123
CARGO	232070
MOBILETRON	RD-25A
TRANSPO	DR1200



12102600 / DC5304

FEATURES

Diodes: 6-50A Avalanche
With Trio

Original & X-References..



12103000 / DCE5170

FEATURES

Diodes: 6-35A Avalanche
With M8×47.3mm Battery post installed
With Aluminum Heat sinks
With Trio

12103020 / DCE5173

Diodes: 6-50A Avalanche
12103100 / DCE5171
With Copper Negative Heat sink

Original & X-References..

DELCO	10475034
	1205464
	589714
WAI	31-131
CARGO	136595
MOBILETRON	RD-04B
TRANSPO	DER2000
	DER2000V



12103900 / DCE5177

FEATURES

Diodes: 6-50A Avalanche
With M8×46mm Battery Post Installed
With Aluminum Heat sinks
For use on: Opel Corsa, Omega, Vectra,
Astra, Fontera, Tigra

12103700 / DCE5175

With Copper Negative Heat sink

Original & X-References..

DELCO	10493596	3472020
	3472820	3478687
CARGO		231797
TRANSPO		DER2010
DELCO		10493596



12104100 / DCE5179

FEATURES

Diodes: 6-50A Avalanche
With M8×46mm Battery Post Installed
With Aluminum Heat sinks
With Trio

12104000 / DCE5178

Diodes: 6-50A Avalanche
With Copper Negative Heat sink

Original & X-References..

DELCO	10475034
	1205464
	589714
WAI	31-131
CARGO	136595
MOBILETRON	RD-04B
TRANSPO	DER2000
	DER2000V

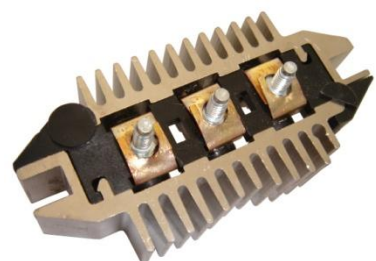

12122800 / DCE1003

FEATURES

Diodes: 6-25 Ampere Button

For use on: Opel, Vauxhall

Original & X-References..

DELCO	3472813
CARGO	131458
TRANSPO	DER1003

12122810 / DCE1004

Diodes: 6-35 Ampere Button

DELCO	3493008
WAI	31-129
CARGO	132931
TRANSPO	DER1004

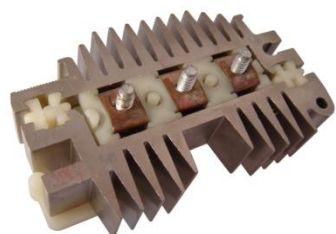
12120100 / DC5070

FEATURES	Original & X-References..		
Diodes: 6-25 Ampere Button	DELCO	1975313	1985313
		D3919	D3913
For use on: GM Vehicles	WAI		31-104
	CARGO		131875
	MOBILETRON		RD-14
	TRANSPO		DR5070

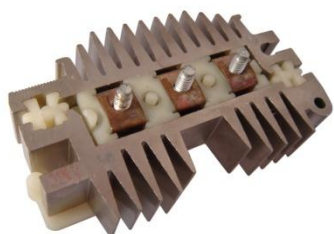
12120300 / DC5072

FEATURES	Original & X-References..		
Diodes: 6-50 Ampere Button	DELCO	1975313	1985313
		D3919	D3913
For use on: GM Vehicles	WAI		31-104-1
	MOBILETRON		RD-14
	TRANSPO		DR5072

12120400 / DC5075

Diodes: 6-50 Ampere Button			
NOTE: Positive Ground Version of DC5072	TRANSPO		DR5075

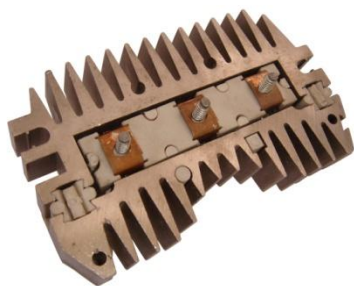
12120500 / DC5085

FEATURES	Original & X-References..		
Diodes: 6-50 Ampere Button	DELCO	1852744	1875812
NOTE: Positive Ground Version of 12121520	TRANSPO		DR5085

12120600 / DC5170

FEATURES	Original & X-References..		
Diodes: 6-25 Ampere Button	DELCO		1985801
For 17SI 97-108A Alternators			D3985
For use on: GM Vehicles, Cadillac	TRANSPO		DR5170

12120610 / DC5172

Diodes: 6-50 Ampere Button

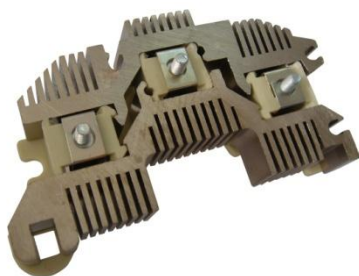
12120700 / DC5180

FEATURES	Original & X-References..		
Diodes: 3-50A Avalanche	DELCO		10467052
3-50A Ampere Button			D3990
With Late Saw-Fin Design			1989774
For use on: GM P Series Step-up Van,	WAI		31-115
Chevy Corvette, Buick Regal, Cadillac,	CARGO		131881
Chevy Blazer, CK-Series Trucks, GMC Suburban	TRANSPO		DR5176

12120900 / DC5181



FEATURES

Diodes: 6-50A Avalanche Button
With Late Saw-Fin Design

For use on: GM Truck B6 Series,
B7 Series, P6 Series, Kodiak

12120910 / DC5181B

Diodes: 6-50A Avalanche
For 24V Alternators

Original & X-References..

DELCO	10470609
	D3992
WAI	31-116
CARGO	231062
MOBILETRON	RD-06A
TRANSP0	DR5177

12130220 / DC5181AP



FEATURES

Diodes: 6-50A Avalanche Press fit
For use on: GM Truck B6 Series,
B7 Series, P6 Series, Kodiak

12130240 / DC5181BP

Diodes: 6-50A Avalanche

Original & X-References..

DELCO	10470609
	D3992
WAI	31-116
CARGO	231062
MOBILETRON	RD-06A
TRANSP0	DR5177PF

12121200 / DC5182



FEATURES

Diodes: 6-50A Jumbo Avalanche Button
With Recessed Mounting Hole
For 140A Alternators

For use on: Buick Riveria, Roadmaster,
Olds Toronado, Chevy Truck, Cadillac

Commercial, Fleetwood Brougham,
Chevy Camaro, Impala, Lumina,
Pontiac, Firebird

Original & X-References..

DELCO	10475800
WAI	31-118
CARGO	232068
MOBILETRON	RD-07
TRANSP0	DR5178

12121300 / DC5183



FEATURES

Diodes: 6-50A Jumbo Avalanche Button
For 124-140A Alternators

See 12121200 for Recessed Mtg.Hole

For use on: Cadillac Deville, Eldorado,
Seville

Original & X-References..

DELCO	10472095
WAI	31-117
CARGO	232069
MOBILETRON	RD-08
TRANSP0	DR5179

12121500 / DC5184

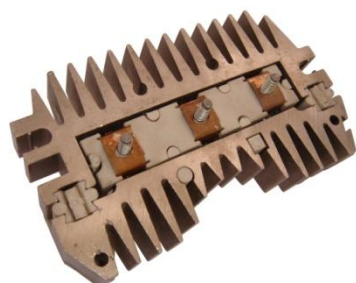

FEATURES

Diodes: 6-25 Ampere Button
For use on: GM Passenger Car, Heavy
Truck

12121510 / DC5184-1

Diodes: 6-35 Ampere Button

12121520 / DC5184HD

Diodes: 6-50 Ampere Button

Original & X-References..

DELCO	1875645	1892914
WAI	31-109	31-109-1
CARGO		30555
MOBILETRON	RD-17	RD-17H
TRANSP0	DR5080	DR5082

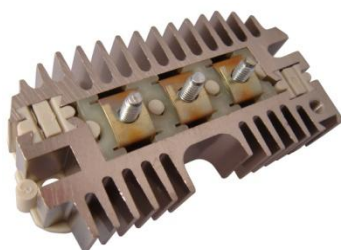
12121700 / DC5185**FEATURES**

Diodes: 6-25 Ampere Button
For use on: GM Vehicles

Original & X-References..

DELCO	1852209	1875627
	1891055	1984638
WAI	31-101	31-101-3
MOBILETRON		RD-09
TRANSPO	DR5040	
TRANSPO	DR5042	
TRANSPO	DR5045	

12121710 / DC5185HD

Diodes: 6-50 Ampere Button

12121800 / DC5185-1

Diodes: 6-25 Ampere Button

NOTE: Positive Ground Version of
12121700

12122200 / DC5187**FEATURES**

Diodes: 6-50 Ampere Button

Original & X-References..

DELCO		1988976
		D3987
WAI		31-106
CARGO		131877
MOBILETRON		RD-05
TRANSPO		DR5173

12122210 / DC5188

Diodes: 6-50A Avianlanche
For 12V Alternators

12122220 / DC5188B

Diodes: 6-50A Avianlanche
For 24V Alternators

12130300 / DC5187P**FEATURES**

Diodes: 6-50Ampere press fit diodes

Original & X-References..

DELCO		1988976
		D3987
WAI		31-106
CARGO		131877
MOBILETRON		RD-05
TRANSPO		DR5173PF

12122300 / DC5189**FEATURES**

Diodes: 3-50 Ampere Button
3-50A Jumbo Avalanche Button

Original & X-References..

TRANSPO		DR5175
---------	--	--------

For use on: Navistar, Cummings
Engine, Detroit Diesel Engine, Ford
Truck B, F Series, Mack, Volvo
3-50A Jumbo Avalanche Button

12122400 / DC5190**FEATURES**

Diodes: 6-25 Ampere Button
For 56-78A Alternators
For use on: GM Vehicles, Agricultural,
Industrial

Original & X-References..

DELCO		1984454
		D3924
WAI		31-102
CARGO		131873
MOBILETRON		RD-12
TRANSPO		DR5050

12122410 / DC5191

Diodes: 6-50 Ampere Button

TRANSPO		DR5052
---------	--	--------

12122500 / DC5192

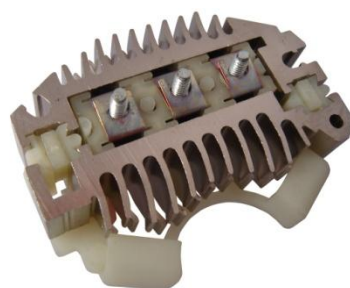

FEATURES

Diodes: 6-50 Ampere Button
With Bi-Directional Heatsinks

For use on: GM Vehicles, Jeep

Original & X-References..

DELCO	1987061
	D3986
WAI	31-103
CARGO	131874
MOBILETRON	RD-13HV
TRANSPO	DR5054
TRANSPO	DR5056

12122510 / DC5193

Diodes: 6-70 Ampere Button



FEATURES

Diodes: 6-60A Avalanche press fit
diodes

Original & X-References..

DELCO	35SI
	2371,10512371
TRANSPO	DR5186

12140800 / DC1101



FEATURES

Diodes: 6-35A Avalanche
With M8×47.5mm Battery Post
Without Trio

For 11SI Alternators

12141100 / DC1105

Diodes: 6-35A Avalanche
With M6×21mm Battery Post
Without Trio

Original & X-References..

TRANSPO	DR2910
---------	--------

12140900 / DC1102

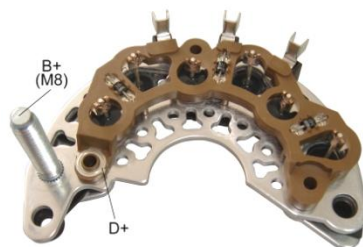

FEATURES

Diodes: 6-35A Avalanche
With M8×47.5mm Battery Post
With Trio

For 7SI Alternators

Original & X-References..

12141000 / DC1103

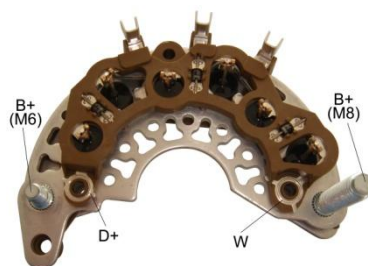

FEATURES

Diodes: 6-35A Avalanche
With M8×47.5mm Battery Post
With M6×21mm Battery Post
With Trio

For 11SI Alternators

Original & X-References..

TRANSPO	DR2206
---------	--------

12141400 / DC1122A



FEATURES

Diodes: 6-50A Avalanche
With M8×47.5mm Battery Post
With Trio

Original & X-References..

TRANSPO DR2295

12910100 / DC1670 (Positive)



FEATURES

Diodes: 3-35 Ampere

For use on: Heavy Duty Truck,
Industrial

Original & X-References..

WAI 31-108
CARGO 131879
TRANSPO DR1670

12910200 / DC1867 (Negative)



FEATURES

Diodes: 3-35 Ampere

For use on: Heavy Duty Truck,
Industrial

Original & X-References..

WAI 31-107
CARGO 131876
TRANSPO DR1867

12141500 / DC4100



FEATURES

Diodes: 6-35A Avalanche
With M8 Battery Post
With Trio
For use on: 1999-00 Daewoo
Leganza 2.2L w/Delphi

Original & X-References..

DELCO 96206871
CARGO 234307
TRANSPO DR6871

12141600 / DC4108

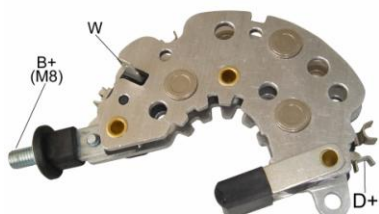

FEATURES

Diodes: 6-60A Avalanche
With M8 Battery Post
With Trio

Original & X-References..

12142000 / DC9410

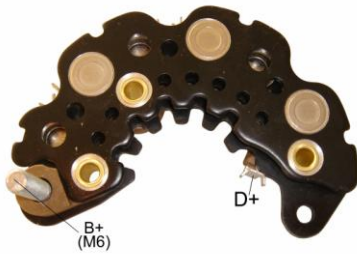

FEATURES

Diodes: 6-50A Avalanche
With M6×38mm Battery Post
With Trio

Original & X-References..

DELCO	0601-0003
19020601	19020612
MOBILETRON	RD-32
CARGO	235139
TRANSP0	DR9410

For use on:2000-UP Mercury w/GM V8

12142100 / DC9411

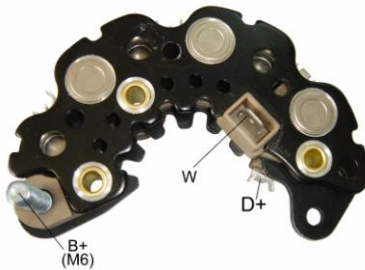

FEATURES

Diodes: 6-50A Avalanche
With M6x38mm Battery Post
With Trio
With P-Terminal
For use on: Crusader Marine , Hyster ,
Indmar Marine , Mercury Marine

Original & X-References..

CARGO	235028
TRANSP0	DR9411

12140700



FEATURES

Diodes: 8-35A Ampere
With M6×29mm Battery Post
With Trio

Original & X-References..

12145300



FEATURES

Diodes: 8-35A Ampere
With M6 Battery Post
With Trio

Original & X-References..

DELCO	19020706
WAI	8470N

12110100 / DC6100

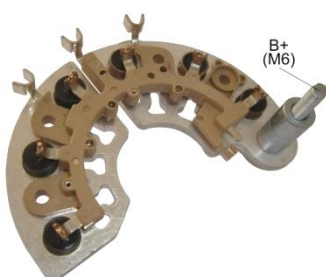

FEATURES

Diodes: 6-50A Avalanche
With M6×53.5mm Battery Post

Original & X-References..

WAI	31-135
MOBILETRON	RD-26
TRANSP0	DR4400

12110110 / DC6100HD

Diodes: 6-60A Avalanche

TRANSP0	DR4400HD-1
---------	------------

12110200 / DC6102

Diodes: 6-50A Avalanche
With M8×53.5mm Battery Post

12110300 / DC6103



FEATURES

Diodes: 6-50A Avalanche
With M6×53mm Battery Post

Original & X-References..

DELCO 10494503
TRANSPO DR4402

12110330 / DC6103HD

Diodes: 6-60A Avalanche

MOBILETRON RD-26HD
TRANSPO DR4402HD

12110500 / DC6104



FEATURES

Diodes: 6-50A Avalanche
With 5/16" ×45mm Battery Post
With insulator

Original & X-References..

DELCO 10502870
MOBILETRON RD-38A
CARGO 331012
TRANSPO DR2400

12110520 / DC6104B

FOR 24V ALTERNATOR

MOBILETRON RD-38
TRANSPO DR2400

12110700 / DC6106

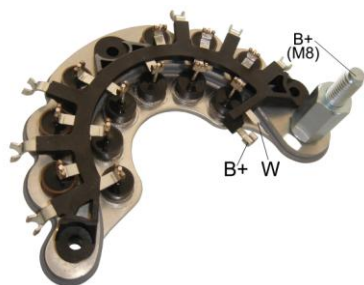

FEATURES

Diodes: 12-50A Avalanche
With M8×52.5mm Battery Post

For Mercedes Water Cooling Alternator

Original & X-References..

ALTERNATOR NO:
MERCEDES 001500850
DELPHI 10480403
CARGO CA 1677IR

12410100



FEATURES

Diodes OD: 8-35A Ampere
Diameter: 104mm
With M6 Battery Post
With Trio
With Capacitor
With 51 Ohm Resistor

Original & X-References..

12150510 / DC6109AH



FEATURES

Diodes: 3-60A Avalanche
With M6×46.5mm Battery Post
Without negative heat sink as DC6109A

Original & X-References..

MOBILETRON RD-40H
TRANSPO DR3581

**12150400 / DC6109A****FEATURES**

Diodes: 6-60A Avalanche
With M6×46.5mm Battery Post

Original & X-References..

DELCO	10503581
	10510904
MOBILETRON	RD-40AH
TRANSPO	DR3580

**12150700 / DC6111A****FEATURES**

Diodes: 6-60A Avalanche
With M8×49mm Battery Post

Original & X-References..

DELCO	8400219
	8400218

**12150900 / DC6112A****FEATURES**

Diodes: 6-60A Avalanche
With M8×49mm Battery Post

Original & X-References..

Customer provide Negative heat sink

**12152500****FEATURES**

Diodes: 6-60A Avalanche
With M8×49mm Battery Post

Original & X-References..

DELCO	8400156	8400158
	8400218	
CARGO	114512	CA2017IR

Customer provide Negative heat sink

**12150300 / DC1124AH****FEATURES**

Diodes: 3-50A Avalanche
With M8×28.5mm Battery Post(L)
With M8×35mm Battery Post(R)

Original & X-References..

LESTER	8486
--------	------

Without negative heat sink as **DC1124A**



12150200 / DC1124A

FEATURES

Diodes: 6-50A Avalanche
 With M8×28.5mm Battery Post(L)
 With M8×35mm Battery Post(R)

Original & X-References..

LESTER 8486

Customer provide Negative heat sink



12153400

FEATURES

Diodes: 6-50A Avalanche
 With M8×28.5mm Battery Post(L)
 With M8×35mm Battery Post(R)

Original & X-References..

Customer provide Negative heat sink

12240100 / FD1001

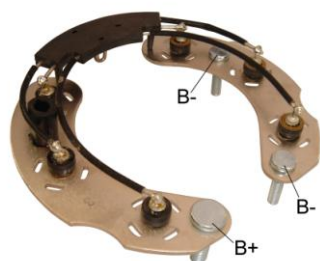

FEATURES	Original & X-References..	
Diodes: 6-25 Ampere Button	FORD	D6AZ10304A
For 40-65A Alternators		GY-1327
Aluminum Heat Sinks with Cooling		D9VY-10304-A
Slots Fine Thread Studs	WAI	31-200-12
Unique Copper Insert Design	CARGO	131421
	MOBILETRON	RF-08H
For use on :Ford, Mercury, Light Trucks	TRANSPO	FR1070

12240200 / FD1002

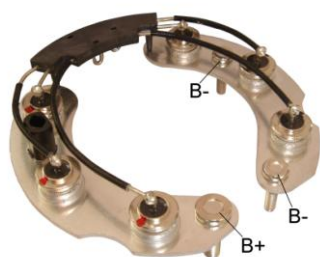

FEATURES	Original & X-References..	
Diodes: 6-35 Ampere Press-Fit	FORD	GY-1327
For 40-65A Alternators		GY-1306A
Aluminum Heat Sinks		D6AZ10304A
Fine Thread Studs	WAI	31-200-12
	CARGO	131421
For use on: Ford, Mercury, Light Truck	MOBILETRON	RF-08H
12240310 / FD1002HD	TRANSPO	FR1040
Diodes: 6-50Ampere	TRANSPO	FR1046

12240400 / FD1004



FEATURES	Original & X-References..	
Diodes: 6-25 Ampere Button	FORD	GY1306A
For 40-65A Alternators	WAI	31-200
Aluminum Heat Sinks with Cooling		31-200-4
Slots Fine Thread Studs	MOBILETRON	RF-07H
High Temp Circuit Board	CARGO	130517
For use on :Ford, Mercury, Light Trucks	TRANSPO	FR1080
12240410 / FD1004HD		
Diodes: 6-50Ampere	TRANSPO	FR1085

12240500 / FD1005

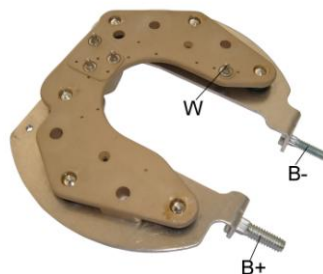

FEATURES	Original & X-References..	
Diodes: 6-35 Ampere Press-Fit	FORD	GY-1026
For 70-100A Alternators		D2OZ10304A
Aluminum Heat Sinks	WAI	31-201
OE-Type High Temp Circuit Board		31-202
For use on: For Passenger Car, Light Truck	CARGO	131422
	MOBILETRON	RF-09H
	TRANSPO	FR1270

12240600 / FD1007



FEATURES	Original & X-References..	
Diodes: 6-50 Ampere Press-Fit	FORD	
For 70-100A Alternators	E9DZ10304A	GY-1345-A
Copper Heat Sinks	F0HZ-10304A	GY-1302-B
OE-Type High Temp Circuit Board	WAI	31-202
For use on: Ford Passenger Car, Light Truck	CARGO	131430
	MOBILETRON	RF-16HV
	TRANSPO	FR1290

12250110 / FD2001

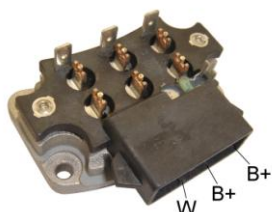

FEATURES	Original & X-References..	
Diodes: 6-35 Ampere	FORD	E6DZ10304
Nickel Plated Brass Terminals		E6DZ10304A
Hi-Temp BBS Receptacle	WAI	31-206 31-203-3
Thermally Conductive Encapsulation	CARGO	131882 137048
For 40-65A Application	MOBILETRON	RF-02
For use on: Ford, Mercury, Light Truck	TRANSPO	FR192PF
12250100 / FD2001HD	WAI	31-206-1 31-206-2
Diodes: 6-50Ampere	TRANSPO	FR192PXD

12250200 / FD2004

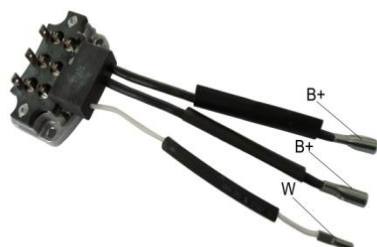

FEATURES	Original & X-References..	
Diodes : 6-50A Ampere	TRANSPO	FR192BBS
Crimp-weld diode terminations		
For 40-80A Application		
For use on: Ford, Mercury, Light Truck		

12200100 / FD3001DW

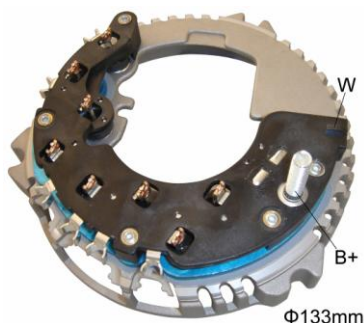

FEATURES	Original & X-References..	
Diodes: 8-35 Ampere	FORD	F5A2-10304BA
Diameter OD: 133mm	WAI	31-207-1
Drop-down Stator Terminals	CARGO	136209
	TRANSPO	FR2013
For use on: Ford Passenger Car, Light Truck		

12200200 / FD3002DW

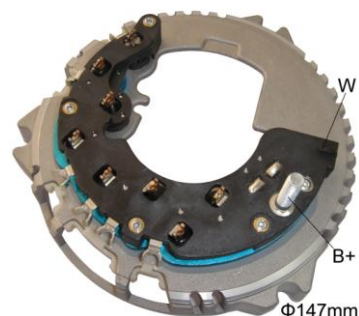

FEATURES	Original & X-References..	
Diodes: 8-50 Ampere	WAI	31-208
Diameter OD: 146mm		31-208-1
Drop-down Stator Terminals	CARGO	136210
	MOBILETRON	RF-053
For use on: Ford Passenger Car, Light Truck	TRANSPO	FR2023

12210100 / FD4001DW



FEATURES	Original & X-References..	
Diodes: 8-60 Ampere	SAS COMPONENTS	10210
Diameter OD: 133mm	FORD	F6LU-10300CA
OE-Style Leadframe	F5OZ-10300FA	F6OU-10300AA
For 130A Applications	F6ZU-10300BB	F6DU-10300BB
	WAI	31-210
For use on: Ford Lincoln, Mercury	CARGO	139668
	MOBILETRON	RF-06
	TRANSPO	FR3003

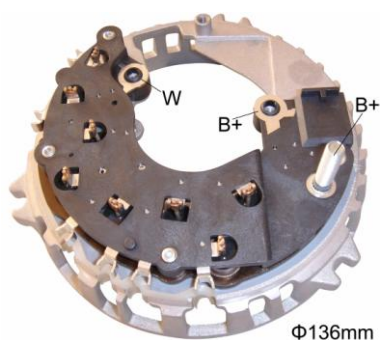

12220200 / FD6000DW

FEATURES

Diodes: 8-35 Ampere
 Diameter OD: 136mm
 Drop-down Stator Terminals

For use on: 1998-2004 Ford Series,
 Excursion, F series Dickup, Focus,
 Mustang, Windstar.

Original & X-References..

FORD	F8 WV10A 366 AAZP
WAI	31-213
CARGO	230842
TRANSPO	FR6003

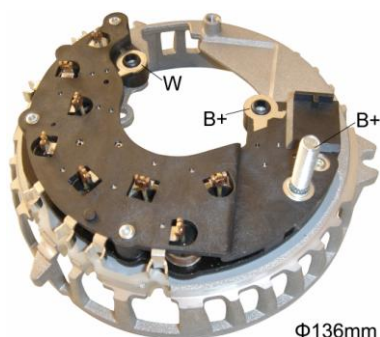

12220400 / FD6001DW

FEATURES

Diodes: 8-35 Ampere
 Diameter OD: 136mm
 Drop-down Stator Terminals

For use on: 1998-2003 Ford Contor,
 Focus, Mercury, Cougar, Mystique 2.0L

Original & X-References..

WAI	31-216
CARGO	233208
MOBILETRON	RF-113
TRANSPO	FR6013

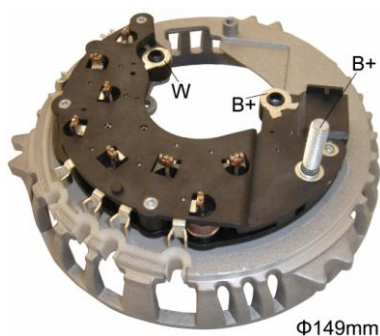

12220700 / FD6002DW

FEATURES

Diodes: 8-50 Ampere
 Diameter OD: 149mm
 Drop-down Stator Terminals For
 Improved Stator-Wire Attachment
 For use on: 1998-2003 Ford, Lincoln,
 Mercury.

Original & X-References..

FORD	F8AU-10A366AIP
WAI	31-212-1 31-212
MOBILETRON	RF-12
CARGO	230870
TRANSPO	FR6023

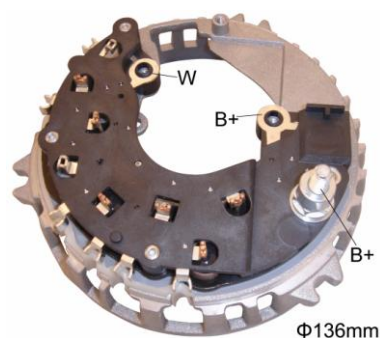

12221000 / FD6011DW

FEATURES

Diodes: 6-35 Ampere
 Diameter OD: 136mm
 Drop-down Stator Terminals For
 Improved Stator-Wire Attachment

Original & X-References..

WAI	31-218-1 31-217
CARGO	233207
MOBILETRON	RF-133
TRANSPO	FR6073

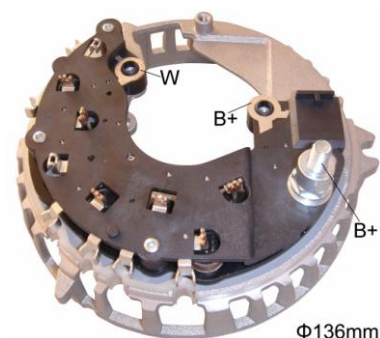

12221200 / FD6012DW

FEATURES

Diodes: 6-35 Ampere
 Diameter OD: 136mm
 Drop-down Stator Terminals For
 Improved Stator-Wire Attachment
 For use on:
 2001-2003 Ford Escape 2.0L
 2001-2003 Mazda Tribute 2.0L

Original & X-References..

FORD	1L8Z-10346AB
	1125500588
WAI	31-219-1
CARGO	232210
MOBILETRON	RF-153
TRANSPO	FR6083

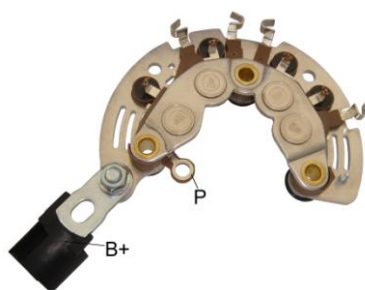
12230100 / FD61001A**FEATURES**

Diodes: 8-50A Avalanche
 Diameter OD: 114mm
 With M6×16.4mm Battery Post

Original & X-References..

MOBLETRON	RF-18HV
CARGO	235019
TRANSPO	FR6102

12230200 / FD61002A**FEATURES**

Diodes: 8-50A Avalanche
 Diameter OD: 114mm
 With M6×39mm Battery Post

Original & X-References..

FORD INDIA	RF-19H
MOBILETRON	3N2110300BB
VALEO	FR6100
TRANSPO	

12230300 / FD61003A**FEATURES**

Diodes:8-50A Avalanche
 Diameter OD:105mm
 With M6×39mm Battery Post

Original & X-References..

TRANSPO	FR6104
---------	--------

For Ford/Visteon RC28 European 104A alternator

Used On: Ford Fiesta, Ka(Europe)

12230400 / FD61004A**FEATURES**

Diodes:8-50A Avalanche
 Diameter OD:105mm
 With M6×16.4mm Battery Post
 For Ford/Visteon RC28 European 110A alternator

Original & X-References..

TRANSPO	FR6106
---------	--------

12530100 / HIF5001



FEATURES

Diodes: 6-25 Ampere Button
With M5×32.6mm Mounting Bolt

For use on: Nissan, Isuzu, Subaru,
Yanmar, Nissan Forklifts

Original & X-References..

HITACHI	
L125-6320	L125-8320
L140-6320	L140-7320
L160-13201	L140-9320
WAI	31-8100-3
CARGO	130618
MOBILETRON	RH-49
TRANSPO	IHR1000
	IHR1000HD

12530300 / HIF5002

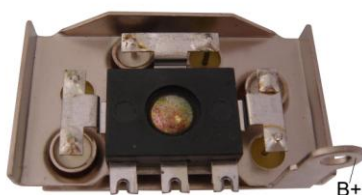

FEATURES

Diodes: 6-35 Ampere
With M5×32.6mm Mounting Bolt

For use on: Nissan, Isuzu, Subaru,
Yanmar, Nissan Forklifts

Original & X-References..

MOBILETRON	RH-49C
TRANSPO	IHR1000HD

The Same as **HIF5001**
Except Using TIN-CAN Diode

12530400 / HIF5003

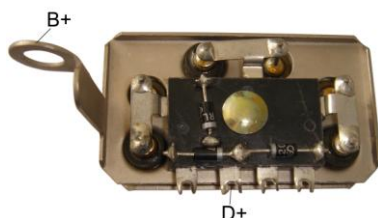

FEATURES

Diodes: 6-25 Ampere Button
With M5×36mm Mounting Bolt
With Trio

For use on: Nissan, Isuzu, Subaru

Original & X-References..

HITACHI	L135-N13201	
	L150-N13202	
WAI	31-8103	
CARGO	131549	131548
MOBILETRON	RH-51	
TRANSPO	IHR1001	

12530500 / HIF5004

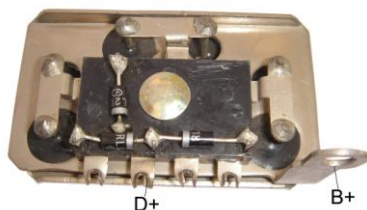

FEATURES

Diodes: 6-35 Ampere
With M5×36mm Mounting Bolt
With Trio

For use on: Nissan

Original & X-References..

LUCAS	21511112	UBJ105
WAI	31-8104	
CARGO	134386	
MOBILETRON	RH-50	
TRANSPO	IHR1002	

12510200 / HI10001F



FEATURES

Diodes: 6-35 Ampere
Diameter OD: 100mm
With M5×31mm Mounting Bolt
With Trio

12510210 / HI10001Fg

Diodes: 6-35 Ampere Dish
For use on: Nissan

Original & X-References..

HITACHI	L135-6320
WAI	31-8147
CARGO	135466
MOBILETRON	RH-19
TRANSPO	IHR733

12510400 / HI10002F

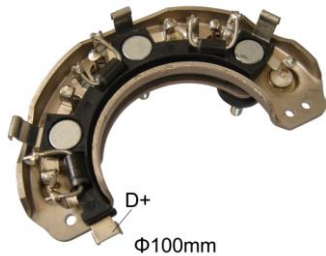

FEATURES

Diodes: 6-35 Ampere Dish Diameter
 OD: 100mm
 With M5×43mm Battery Post
 With M5×31mm Mounting Bolt
 With Trio

12510420 / HI10002Fg

Diodes: 6-35Ampere Dish
 For use on: Industrial, Yanmar

Original & X-References..

HITACHI	L135-3320
	L135-332000
WAI	31-8135
CARGO	132406
MOBILETRON	RH-20
TRANSP0	IHR734

12510700 / HI10003F

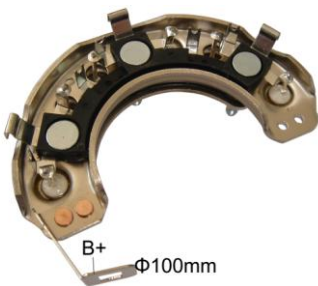

FEATURES

Diodes: 6-35 Ampere
 Diameter OD: 100mm
 With M5×31mm Mounting Bolt

12510710 / HI10003Fg

Diodes: 6-35Ampere Dish
 For use on: Isuzu Diesel, Mazda Diesel

Original & X-References..

HITACHI	L140-23201
CARGO	132410
MOBILETRON	RH-16
TRANSP0	IHR727

12511010 / HI10004Fg

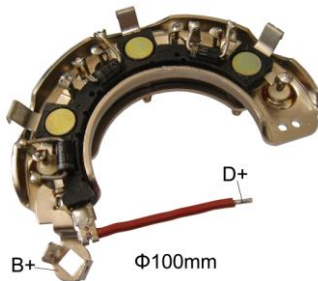

FEATURES

Diodes: 6-35 Ampere Dish
 Diameter OD: 100mm
 With M5×31mm Mounting Bolt
 With Trio

For use on: Chevy Luv Diesel, Isuzu Pickup Diesel

Original & X-References..

HITACHI	L140-53201
WAI	31-8119
CARGO	135757
MOBILETRON	RH-17
TRANSP0	IHR728

12518300 / HI10013FE

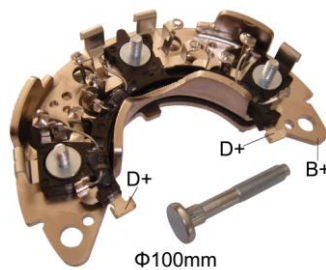

FEATURES

Diodes: 6-50 Ampere
 Diameter OD: 100mm
 With M6×44.4mm Battery Post
 With (M5+M4)×39.8mm Mounting Bolt
 With Trio

For use on: Nissan 200SX, Nissan Sentra, Subaru

Original & X-References..

HITACHI	LR150-704
	L170-9320
NISSAN	2310051S00
	23230-51500
CARGO	132098
MOBILETRON	RH-39C
TRANSP0	IHR719

12518400 / HI10014FE

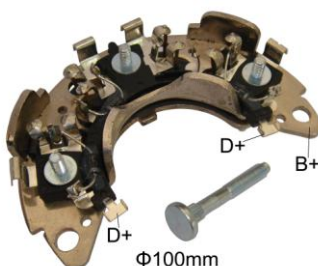

FEATURES

Diodes: 8-50 Ampere
 Diameter OD: 100mm
 With M6×44.4mm Battery Post
 With (M5+M4)×39.8mm Mounting Bolt
 With Trio

For use on: Subaru XT Coupe, Nissan Axxess

Original & X-References..

HITACHI	L165-6320
	L165-7320
	L170-7302
NISSAN	2323077A00
CARGO	133377
MOBILETRON	RH-40C
TRANSP0	IHR720

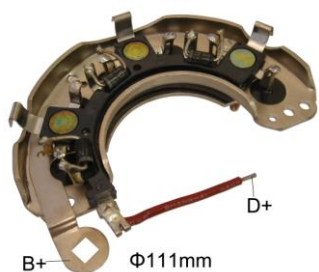

12511900 / HI11101F

FEATURES	Original & X-References..	
Diodes: 6-35 Ampere	HITACHI	L150-13204
Diameter OD: 111mm	WAI	31-8106
With M5×31mm Mounting Bolt	CARGO	131599
With Trio	MOBILETRON	RH-02
	TRANSPO	IHR604

12511600 / HI11101

With Aluminum Heat sinks



12512400 / HI11102F

FEATURES	Original & X-References..	
Diodes: 6-35 Ampere	HITACHI	L150-13206
Diameter OD: 111mm	WAI	31-8107
With M5×43mm Battery Post	CARGO	131600
With M5×31mm Mounting Bolt	MOBILETRON	RH-03
With Trio	TRANSPO	IHR710 IHR709
		IHR710HD

12512420 / HI11102Fg

Diodes: 6-35Ampere Dish

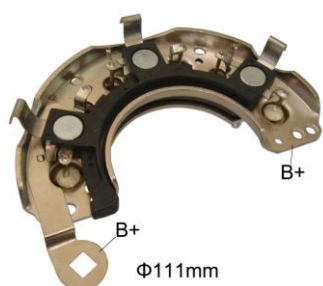

12512600 / HI11103F

FEATURES	Original & X-References..	
Diodes: 6-35 Ampere	HITACHI	L150-13205
Diameter OD: 111mm	WAI	31-8140
With M5×31mm Mounting Bolt	CARGO	131602
	MOBILETRON	RH-06
	TRANSPO	IHR711



12512800 / HI11104F

FEATURES	Original & X-References..	
Diodes: 6-35 Ampere	HITACHI	L150-93201
Diameter OD: 111mm		
With M5×31mm Mounting Bolt		
With Trio		

12512820 / HI11104Fg

Diodes: 6-35Ampere Dish

For use on: Nissan Pick-up



12513000 / HI11105FE

FEATURES	Original & X-References..	
Diodes: 6-35 Ampere Dish	HITACHI	L150-13202
Diameter OD: 111mm	WAI	31-8139
With M5×43mm Battery Post	CARGO	132051
With M5×31mm Mounting Bolt	MOBILETRON	RH-09
	TRANSPO	IHR715

Diodes: 6-35Ampere Dish

For use on: Subaru

12513400 / HI11106F

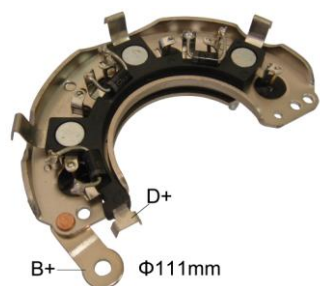

FEATURES

Diodes: 6-35 Ampere
 Diameter OD: 111mm
 With M5×31mm Mounting Bolt
 With Trio

12513100 / HI11106

With Aluminum Heat sinks
12513430 / HI11106Fg

Diodes: 6-35Ampere Dish

Original & X-References..

HITACHI	
L140-13202	L140-53202
L150-83201	L150-83202
WAI	31-8113
CARGO	131603
MOBILETRON	RH-04
TRANSPO	IHR723
	IHR723HD

12513800 / HI11107FE



FEATURES

Diodes: 6-35Ampere
 Diameter OD: 111mm
 With M5×39mm Mounting Bolt
 With Trio

12513810 / HI11107Fg

Diodes: 6-35Ampere Dish

Original & X-References..

12514000 / HI11108g



FEATURES

Diodes: 6-35 Ampere dish
 Diameter OD: 111mm
 With M5×39mm Mounting Bolt
 With M5×31mm Mounting Bolt

For use on: IHC, Nissan Diesel, Isuzu Diesel

Original & X-References..

HITACHI	L150-M13201
	L150-M13202
	L155-M13202
WAI	31-8111
CARGO	131601
TRANSPO	IHR712
	IHR712HD

12520100 / HI11116



FEATURES

Diodes: 6-35 Ampere Press Fit Diode
 Diameter OD: 111mm
 With M5×33.5mm Mounting Bolt
 With Trio
 With Aluminum Heat sinks

Original & X-References..

HITACHI	
L140-13202	L140-53202
L150-83201	L150-83202
WAI	31-8113
CARGO	131603
MOBILETRON	RH-04
TRANSPO	IHR723
	IHR723HD

12514700 / HI11124F

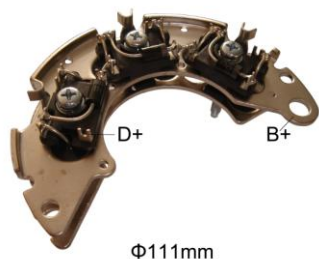

FEATURES

Diodes: 6-35 Ampere
 Diameter OD: 111mm
 With M5×43mm Mounting Post
 With M5×23mm Mounting Bolt
 With Trio

Original & X-References..

12515000 / HI11128F



FEATURES

Diodes: 6-35 Ampere
 Diameter OD: 111mm
 With M5×43mm Battery Bolt
 With M5×31mm Mounting Bolt

Original & X-References..

12515100 / HI11129F



FEATURES

Diodes: 6-35 Ampere
 Diameter OD: 111mm
 With M5×39mm Mounting Bolt
 With Trio

Original & X-References..

12518900 / HI11130F



FEATURES

Diodes: 6-50 Ampere
 Diameter OD: 111mm
 With M6×35.2mm Battery Post
 With M5×31mm Mounting Bolt
 With M5×43mm Battery Bolt
 With Trio

Original & X-References..

12516500 / HI11801F

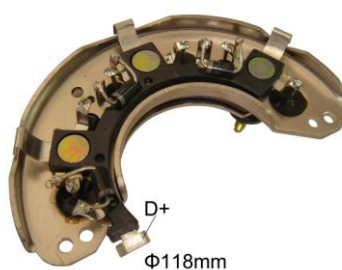

FEATURES

Diodes: 6-35Ampere
 Diameter OD: 118mm
 With M5×43mm Battery Post
 With M5×31mm Mounting Bolt
 With Trio
 For use on: Nissan, Subaru DL/GL/RX
 Hatchback, Sedan & Wagon, Subaru
 Loyale

Original & X-References..

HITACHI	L150-13203
	L150-13230
	L160-3320
WAI	31-8105
CARGO	131598
MOBILETRON	RH-01
TRANSPO	IHR603
	IHR603HD

12516600 / HI11802F

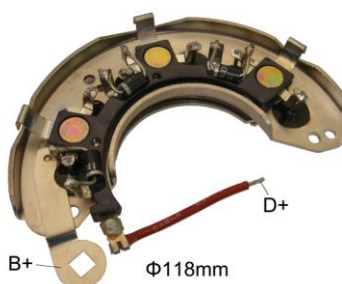

FEATURES

Diodes: 6-35 Ampere
 Diameter OD: 118mm
 With M5×31mm Mounting Bolt
 With Trio
 For use on: Isuzu & Nissan Diesel
 Applications, Maxima Diesel

Original & X-References..

HITACHI	L160-23201
WAI	31-8112
CARGO	132053
MOBILETRON	RH-14
TRANSPO	IHR607
	IHR607HD

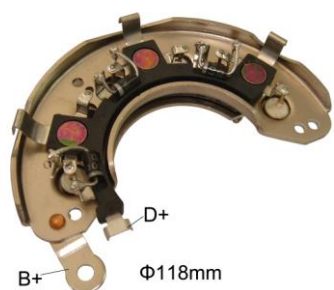

12516800 / HI11803F

FEATURES

Diodes: 6-35 Ampere
 Diameter OD: 118mm
 With M5×31mm Mounting Bolt
 With Trio
 For use on: Nissan with 70 Ampere
 Alternators, Isuzu NPR

12516700 / HI11803

Diodes: 6-35Ampere
 With Aluminum Heat sinks

Original & X-References..

HITACHI	L160-23202
WAI	31-8133
CARGO	135037
MOBILETRON	RH-15
TRANSPO	IHR721 IHR721HD
HITACHI	L160-43202

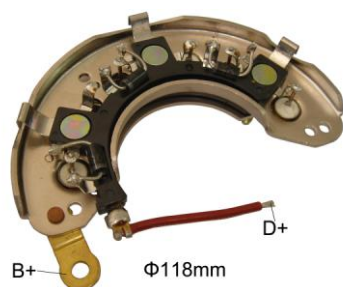

12516900 / HI11804F

FEATURES

Diodes: 6-35Ampere
 Diameter OD: 118mm
 With M5×31mm Mounting Bolt
 With Trio
 The Same As **HI11803** Except Adding
 A Wire

Original & X-References..

HITACHI	L160-3320
	L150-13203
WAI	31-8105
CARGO	131598
MOBILETRON	RH-11
TRANSPO	IHR605
	IHR605HD

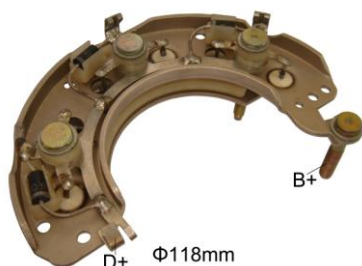

12517000 / HI11805F

FEATURES

Diodes: 6-35 Ampere
 Diameter OD: 118mm
 With M6×35.2mm Battery Post
 With M5×46.5mm Mounting Bolt
 With M5×41mm Mounting Bolt
 With Trio
 For use on: Nissan, Subaru DL/GL/RX
 Hatchback, Sedan & Wagon, Subaru
 Loyale

Original & X-References..

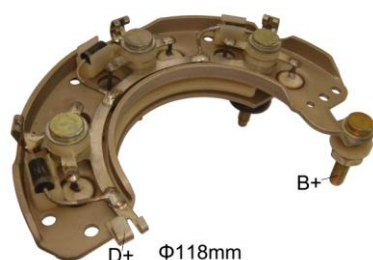

12517100 / HI11806F

FEATURES

Diodes: 6-35 Ampere
 Diameter OD: 118mm
 With M6×35.2mm Battery Post
 With M5×46.5mm Mounting Bolt
 With M5×41mm Mounting Bolt
 With Trio

Original & X-References..

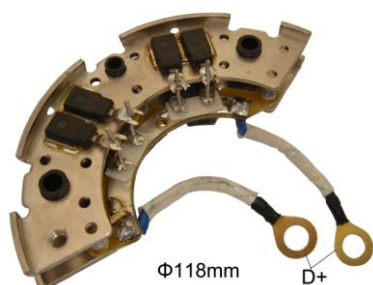

12517200 / HI11810F

FEATURES

Diodes: 8-30 Ampere
 Diameter OD: 118mm
 With Trio

Original & X-References..



12517300 / HI12601

FEATURES

Diodes: 6-25 Ampere
 Diameter OD: 126mm
 With M5×21mm Mounting Bolt
 With Trio

Original & X-References..

NIKKO	0337302190
CARGO	135681



12517400 / HI12602

FEATURES

Diodes : 6-25A Ampere
 Diameter OD : 126mm
 With M5×48.5mm Battery Post
 With M5×53.5mm Trio Post
 With Trio
 With 150 Ohm Resistor

Original & X-References..



12517500 / HI12603

FEATURES

Diodes : 6-25A Ampere
 Diameter OD : 126mm
 With M5×30mm Battery Post
 With Trio
 With Capacitor
 With 150 Ohm Resistor

Original & X-References..

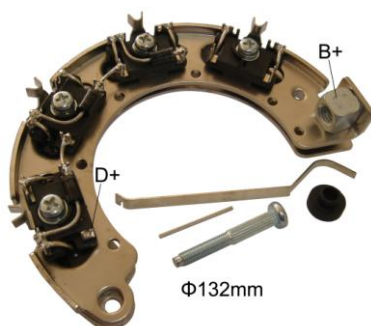

12517600 / HI13201

FEATURES

Diodes: 8-25 Ampere
 Diameter OD: 132mm
 With M6×33.5mm Battery Post
 With Trio

Original & X-References..

ISUZU	1812191070
NIKKO	0357300270
	0357300300
	0357300460
CARGO	234578

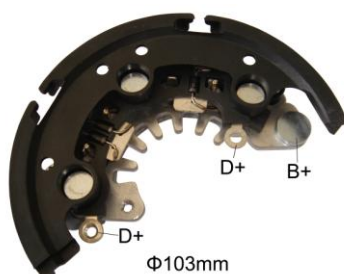

1250AR00 / HI10301

FEATURES

Diodes: 6-35 Ampere
 Diameter OD: 103 mm
 With M5×16.6mm Battery Post
 With Trio

Original & X-References..

HITACHI	L180-13202
WAI	31-8123
CARGO	135040
MOBILETRON	RH-23
TRANSPO	IHR752

For use on: Nissan Pickup, Pathfinder,
 Subaru Legacy

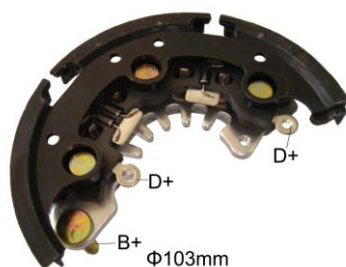
1250AS00 / HI10302**FEATURES**

Diodes: 6-35 Ampere
 Diameter OD: 103mm
 With M6×34mm Battery Post
 With M5×31.6mm Mounting Bolt
 With Trio

Original & X-References..

HITACHI	LR150-711
CARGO	138695
MOBILETRON	RH-28
TRANSPO	IHR757

For use on: Honda, Isuzu, Nissan Sentra

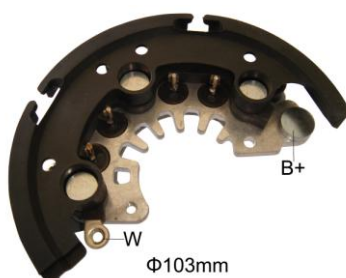
1250AT00 / HI10303**FEATURES**

Diodes: 8-35 Ampere
 Diameter OD: 103 mm
 With M5×16.6mm Battery Post
 Without Trio

Original & X-References..

HITACHI	L170-23203
CARGO	135039
MOBILETRON	RH-24
TRANSPO	IHR753

For use on: Nissan Pulsar, Sentra

1250AU00 / HI10304**FEATURES**

Diodes: 6-35Ampere
 Diameter OD: 103 mm
 With M5×16.6mm Battery Post
 With M5×31.6mm Mounting Bolt
 Without Trio
 For use on: Nissan Altima, Axess

Original & X-References..

HITACHI	L180G-7320
LR180-725C	LR180-736B
LR180-725B	LR170-739
WAI	31-8132
	31-8132-1
CARGO	139464
MOBILETRON	RH-29
TRANSPO	IHR758

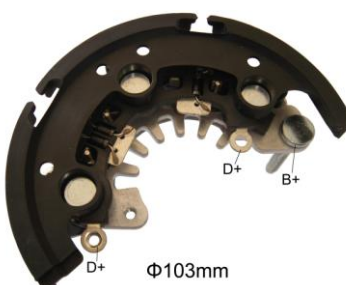
1250AV00 / HI10305**FEATURES**

Diodes: 6-35 Ampere
 Diameter OD: 103 mm
 With M6×43mm Battery Post
 With Trio

Original & X-References..

HITACHI	L170-43202
WAI	31-8127
CARGO	136650
MOBILETRON	RH-22
TRANSPO	IHR751

For use on: Nissan Pickup, Pathfinder

1250AW00 / HI10306**FEATURES**

Diodes: 8-35 Ampere
 Diameter OD: 103mm
 With M6×43mm Battery Post
 With M5×31.6mm Mounting Bolt
 Without Trio

Original & X-References..

HITACHI	L170-G2320
WAI	31-8129
CARGO	135318
MOBILETRON	RH-25
TRANSPO	IHR754

For use on: Nissan Sentra

1250B000 / HI10310

With M6×34mm Battery Post

1250AX00 / HI10307

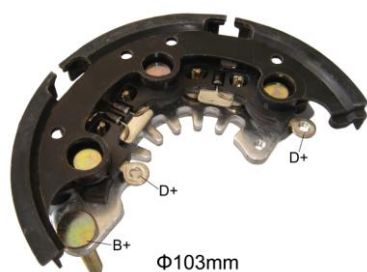

FEATURES

Diodes: 8-35 Ampere
 Diameter OD: 103mm
 With M6×43mm Battery Post
 With M5×31.6mm Mounting Bolt
 With Trio

Original & X-References..

HITACHI	L170-G1320
WAI	31-8125
CARGO	136976
MOBILETRON	RH-26
TRANSPO	IHR755

For use on: Honda, Isuzu, Nissan Sentra

1250AY00 / HI10308

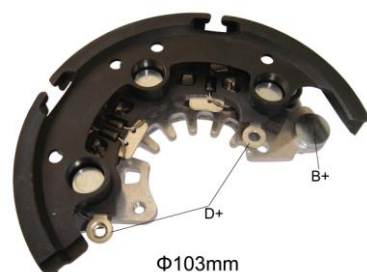

FEATURES

Diodes: 6-35 Ampere
 Diameter OD: 103 mm
 With M5×16.6mm Battery Post
 With M5×31.6mm Mounting Bolt
 With Trio
 For use on: Infiniti G20, Nissan Sentra,
 NX2000

Original & X-References..

HITACHI	L180-13202
WAI	31-8123
CARGO	135040
MOBILETRON	RH-23
TRANSPO	IHR756
	IHR752

1250AZ00 / HI10309

Diodes: 8-35 Ampere

1250B100 / HI10311



FEATURES

Diodes: 8-35 Ampere
 Diameter OD: 103mm
 With M5×31.6mm Mounting Bolt
 For use on: Subaru Legacy 2.2L 70Amp

Original & X-References..

HITACHI	L170-33202
WAI	31-8117
CARGO	135038
MOBILETRON	RH-21
TRANSPO	IHR750

12500110 / HI11301A

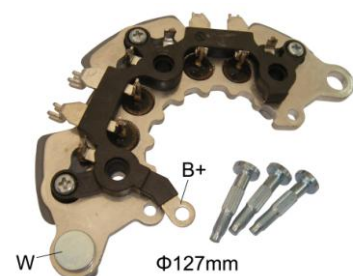

FEATURES

Diodes: 8-35 A Avalanche
 Diameter OD: 127mm
 With M8×45.6mm Battery Post
 With M5×31.6mm Mounting Bolt
 For use on: 1999-up Opel Astra, Vectra
 1.7L, 1999-up Opel Corsa, W/AC1.7L

Original & X-References..

HITACHI	0901-0021
CARGO	235729
MOBILETRON	RH-73
TRANSPO	IHR769

12500100 / HI11301

Diodes: 8-35 Ampere

12500400 / HI11302



FEATURES

Diodes: 8-35 Ampere
 Diameter OD: 113mm
 With M8×45.6mm Battery Post
 With M5×31.6mm Mounting Bolt

Original & X-References..

12501600 / HI11302B

Diodes: 8-35A Avalanche
 With M6×51mm Battery Post
 For 24V Alternator

12500410 / HI11302A

Diodes: 8-35 A Avalanche

12501700 / HI11303A



FEATURES

Diodes: 8-60 A Avalanche
 Diameter OD: 119mm
 With M6×20.3mm Battery Post
 With M5×31.6mm Mounting Bolt

For use on: Nissan Maxima 3.0L
 DOHC, Infiniti 130

Original & X-References..

HITACHI	L1125G-2320
	L1110G-4320
WAI	31-8142
CARGO	138718
MOBILETRON	RH-35
TRANSPO	IHR773

12504800 / HI11304A



FEATURES

Diodes: 8-35 A Avalanche
 Diameter OD: 119mm
 With M6×20.3mm Battery Post
 With M5×31.6mm Mounting Bolt

For use on: 95-97 Nissan Maxima 3.0L
 DOHC, 98-99 Nissan Maxima
 SE3.0L, 98-99 Infiniti 3.0L

Original & X-References..

HITACHI	LR1110-709B
	LR1110-707G
	LR1110-710F
NISSAN	231000L701
MOBILETRON	RH-77
CARGO	234027
TRANSPO	IHR770

12501800 / HI11305A



FEATURES

Diodes: 6-35 A Avalanche
 Diameter OD: 119mm
 With M6×20.3mm Battery Post
 With M5×31.6mm Mounting Bolt
 Mates to Regulators with Integral Brush
 Holder
 For use on: 98-99 Nissan Maxima 3.0L

Original & X-References..

HITACHI	LR1110711
	LR1110711B
	L1100G-23201
NISSAN	231000L700
MOBILETRON	RH-71
TRANSPO	IHR771

12501900 / HI11306



FEATURES

Diodes: 6-35 Ampere
 Diameter OD: 119mm
 With M8×50.5mm Battery Post
 With M5×36.5mm Mounting Bolt

12502000 / HI11307

Diodes: 8-35 Ampere

Original & X-References..

12502100 / HI11308B



FEATURES

Diodes: 8-35A Avalanche
 Diameter OD: 127mm
 With M6×51mm Battery Post

For 24V Alternators

Original & X-References..

HITACHI	LR280-508
---------	-----------

**12502700 / HI11315A****FEATURES**

Diodes: 6-60A Avalanche
 Diameter OD :127mm
 With M8×45.6mm Battery Post
 With M5×35mm Mounting Post

Original & X-References..

HITACHI	LR1100-502MD
MOBILETRON	RH-85
TRANSPO	IHR669

12502800 / HI11315A-1

Diodes: 8-60A Avalanche

**12502900 / HI11318A****FEATURES**

Diodes: 8-35A Avalanche
 Diameter OD :127mm
 With M6×20.3mm Battery Post
 With M5×31.6mm Mounting Post

Original & X-References..**12502910 / HI11318B**

Diodes: 8-35A Avalanche
 For 24V Alternators

12503000 / HI11318A-1

With M8×50.5mm Battery Post

**12503600 / HI11322A****FEATURES**

Diodes : 12-35A Avalanche
 Diameter OD : 113mm
 With M6×20.3mm Battery Post
 With M5×31.6mm Mounting Bolt
 For 12V Alternators

Original & X-References..

MOBILETRON	RH-102
TRANSPO	IHR765

**12503700 / HI11323A****FEATURES**

Diodes : 8-35 A Avalanche
 Diameter OD : 119mm
 With M8×50.5mm Battery Post
 With M5×31.6mm Mounting Bolt

Original & X-References..**12505300 / HI11401****FEATURES**

Diodes: 6-35 Ampere
 Diameter OD: 115mm
 With M8×45.6mm Battery Post
 With M5×31.6mm Mounting Bolt
 For use on: Opel Corsa, Vectra

Original & X-References..

HITACHI	L170G-23203
GM	97122644
CARGO	230094
MOBILETRON	RH-48
TRANSPO	IHR749

12505310 / HI11401A

Diodes: 6-35A Avalanche

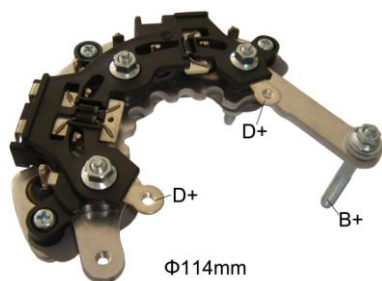

12505400 / HI11402

FEATURES

Diodes: 8-35 Ampere
 Diameter OD: 114mm
 With M6×51mm Battery Post
 With M5×42.5mm Mounting Bolt
 With Trio
 For use on: 8-97083286-0

Original & X-References..

HITACHI	L180G-8320
MOBILETRON	RH-74A
CARGO	333052



12505600 / HI11403

FEATURES

Diodes: 8-35 Ampere
 Diameter OD: 114mm
 With M8×45.6mm Battery Post
 With M5×31.6mm Mounting Bolt
 For use on: Nissan Sentra, 200SX,
 200SX Turbo

Original & X-References..

HITACHI	LR170-748
	LR170-748B
	LR190-729
	LR180-751
WAI	31-8141
CARGO	138732
TRANSPO	IHR746

12505610 / HI11403A

Diodes: 8-35A Avalanche



12506100 / HI11405

FEATURES

Diodes: 6-35 Ampere
 Diameter OD: 114mm
 With M6×20.3mm Battery Post
 For use on: Nissan Altima

Original & X-References..

HITACHI	LR160-727
LR180-741H	LR180-744
NISSAN	231001E800
CARGO	230662
MOBILETRON	RH-32
TRANSPO	IHR778

12506110 / HI11405A

Diodes: 6-35A Avalanche

12506500 / HI11405-1

Diodes: 8-35 Ampere

TRANSPO IHR783

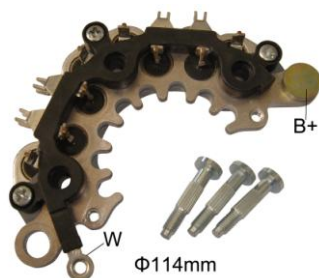

12506900 / HI11406

FEATURES

Diodes: 8-35 Ampere
 Diameter OD: 114mm
 With M5×18.5mm Battery Post
 With M5×31.6mm Mounting Bolt

Original & X-References..

12506910 / HI11406A

Diodes: 8-35A Avalanche



12507000 / HI11407

FEATURES

Diodes: 8-35 Ampere
 Diameter OD: 114mm
 With M6×20.3mm Battery Post
 With M5×31.6mm Mounting Bolt
 For use on: Nissan 240 SX

Original & X-References..

HITACHI	LR185-701H
LR190-724	LR180-724C
NISSAN	2310070F05
MOBILETRON	RH-33
TRANSPO	IHR775

12507010 / HI11407A

Diodes: 8-35A Avalanche

HITACHI	0901-0027
TRANSPO	IHR744

**12507100 / HI11407-1****FEATURES**

Diodes: 6-35 Ampere
 Diameter OD: 114mm
 With M6×20.3mm Battery Post
 With M5×31.6mm Mounting Bolt
 For use on: Nissan 240 SX

Original & X-References..

MOBILETRON	RH-78
CARGO	235889
TRANSPO	IHR741

**12507400 / HI11407A-161****FEATURES**

Diodes: 8-35A Avalanche
 Diameter OD: 114mm
 With M6×51mm Battery Post
 With M5×31.6mm Mounting Bolt
 For use on: Nissan 240 SX

Original & X-References..

MOBILTERON	RH-66A
TRANSPO	IHR780

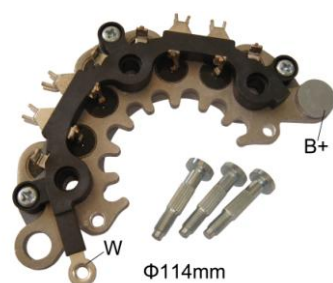
**12507700 / HI11408****FEATURES**

Diodes: 8-35 Ampere
 Diameter OD: 114mm
 With M6×20.3mm Battery Post
 With M5×31.6mm Mounting Bolt
 For use on: 1977-2000 Nisan puthfinder 3.3L

Original & X-References..

HITACHI	L190G-43205
J&N	172-44066
MOBILTERON	RH-76
CARGO	234315
TRANSPO	IHR737

12507710 / HI11408A

Diodes: 8-35A Avalanche

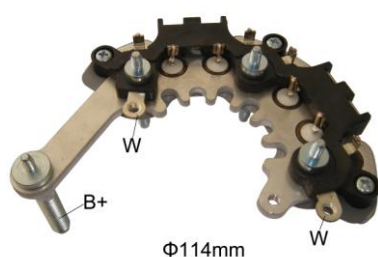
**12507900 / HI11409****FEATURES**

Diodes: 8-35 Ampere
 Diameter OD: 114mm
 With (M8 +M4)×55.4mm Battery Post
 With (M5+M4)×41.8mm Mounting Bolt

Original & X-References..

HITACHI	L1100-501B
CARGO	231081

12507910 / HI11409A

Diodes: 8-35A Avalanche

1250A100 / HI11416

Diodes: 6-35Ampere

**12508100 / HI11410****FEATURES**

Diodes: 8-35 Ampere
 Diameter OD: 114mm
 With M6×20.3mm Battery Post
 With M5×31.6mm Mounting Bolt
 For use on: 1998-2002 Nissan Forntier 2.4L, 2000-2002 Nissan Xterra 2.4L

Original & X-References..

HITACHI	LR170-757B
	L190G-13205
NISSAN	231003S500
MOBILETRON	RH-70
TRANSPO	IHR738

12508110 / HI11410A

Diodes: 8-35A Avalanche

MOBILETRON	RH-69
TRANSPO	IHR739

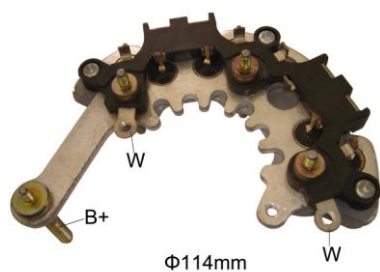

12508600 / HI11411

FEATURES	Original & X-References..	
Diodes: 6-35 Ampere	HITACHI	L190G-33201
Diameter OD: 114mm		L190G-83204
With M6×51mm Battery Post	NISSAN	2323086N00
With (M5+M4)×41.8mm Mounting Bolt	CARGO	138617

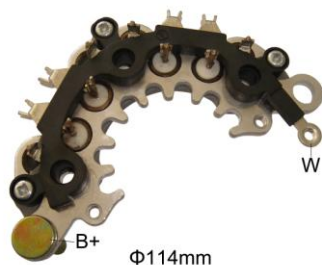

12508800 / HI11412

FEATURES	Original & X-References..	
Diodes: 8-35Ampere	HITACHI	L160G-53201
Diameter OD: 114mm	LR160-728B	LR160-732
With M8×45.6mm Battery Post	MOBILETRON	RH-65

12508810 / HI11412A

Diodes: 8-35A Avalanche



12509100 / HI11413

FEATURES	Original & X-References..	
Diodes: 8-35A Ampere		
Diameter OD: 114mm		
With M6×48mm Battery Post		
With Trio		

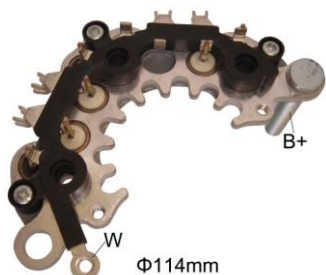

1250A000 / HI11414

FEATURES	Original & X-References..	
Diodes: 6-35 Ampere	HITACHI	LR170-745
Diameter OD: 114mm		LR160-727
With M8×49mm Battery Post	MOBILETRON	RH-30
	LESTER	13643
For use on: Nissan Pick-up, Pathfinder	TRANSP0	IHR745



1250A200 / HI11417

FEATURES	Original & X-References..	
Diodes: 8-35 Ampere	CARGO	235226
Diameter OD: 114mm		
With M6×48mm Battery Post		
With M5×31.6mm Mounting Bolt		
1250A300 / HI11417-1		
With M8×49mm Battery Post		

1250A400 / HI11418A



FEATURES

Diodes: 6-35A Avalanche
 Diameter OD: 114mm
 With M6×51mm Battery Post
 With M5×31.6mm Mounting Bolt

Original & X-References..

HITACHI	LR160-730
J&N	172-44064
LESTER	13745
	13757
TRANSPO	IHR781

1250A500 / HI11418A-1



FEATURES

Diodes: 6-35A Avalanche
 Diameter OD: 114mm
 With M6×51mm Battery Post
 With M5×31.6mm Mounting Bolt

Original & X-References..

HITACHI	LR160-729C
J&N	172-44065
CARGO	234909
LESTER	13744
TRANSPO	IHR782

1250AB00 / HI11423

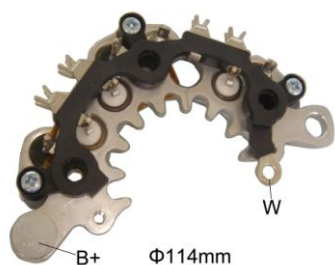

FEATURES

Diodes : 6-35A Ampere
 Diameter OD : 114mm
 With M6×20.3mm Battery Post
1250AC00 / HI11423-1
 Diodes : 8-35A Ampere
1250AD00 / HI11423-2
 Diodes : 6-35A Ampere
 With M8×45.6mm Battery Post

Original & X-References..

HIACHI	LR170-758
	LR180-766
HONDA	BP4W18300B
	BP4W1830-0BC
LESTER	13788 13895
TRANSPO	IHR762

1250AE00 / HI11424

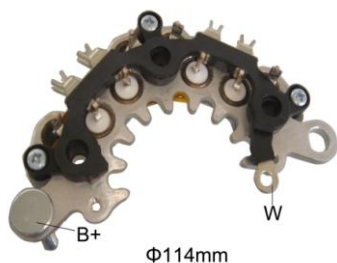

FEATURES

Diodes : 8-35A Ampere
 Diameter OD : 114mm
 With M6×48mm Battery Post

Original & X-References..

HIACHI	LR190-744
	LR190-761
ISUZU	2902768300
LESTER	13825 13935
MOBILETRON	RH-82
CARGO	234829
TRANSPO	IHR764

11500100 / HI10303ZT

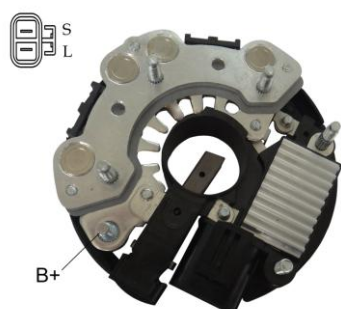

FEATURES

Complete set with
 REC HI10303+REG(05-088H) 14V

Original & X-References..

HITACHI	LR180-734B
CARGO	113421
LESTER	13534
TRANSPO	IHR753+IH762

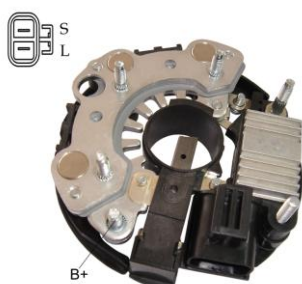

11500200 / HI10304ZT

FEATURES

Diodes: 6-35A Ampere
 Complete set with
 REC **HI10304+REG (05-088H)** 14V

Original & X-References..

HITACHI LR160-724
 LESTER 13531
 TRANSPO IHR758+IH762

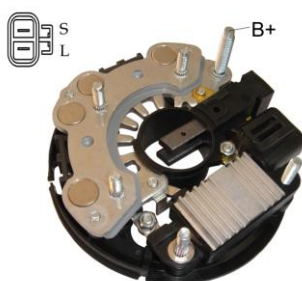

11500600 / HI10310ZT

FEATURES

Diodes: 8-35A Ampere
 Complete set with
 REC **HI10310+REG (05-052)** 14V

Original & X-References..

HITACHI LR170-744
 LESTER 13334
 TRANSPO IHR754+IH761

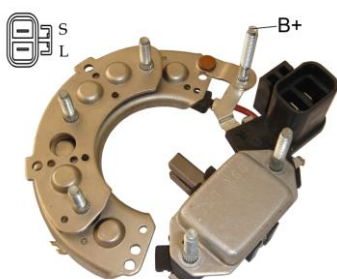

11511900 / HI111ZT21135F

FEATURES

Diodes: 6-35A Ampere
 Complete set with
 REC **HI11106+ REG (05-007H)** 14V

Original & X-References..

HITACHI LR170-417

For use on: NISSAN (DIESEL)

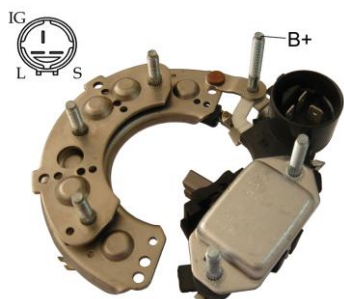

11513010 / HI111ZT31135F

FEATURES

Diodes: 6-35A Ampere
 Complete set with
 REC **HI11106+ REG (05-010H)** 14V

Original & X-References..

HITACHI L140-53202
 L150-83201

For use on: NISSAN (DIESEL)

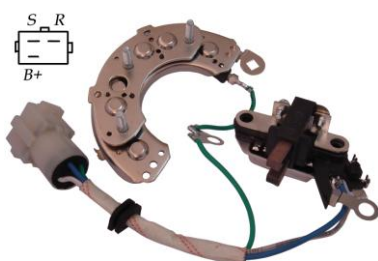

11515200 / HI111ZTN31135F

FEATURES

Diodes: 6-35A Ampere
 Complete set with
 REC **HI11101+ REG (05-027H)** 14V

Original & X-References..

HITACHI L150-13204

For use on: NISSAN (DIESEL)

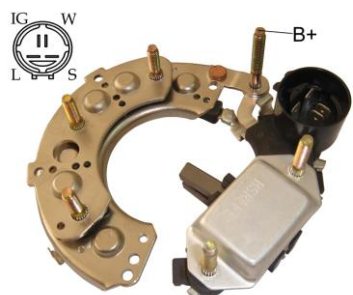

11514310 / HI111ZT41135F

FEATURES

Diodes: 6-35A Ampere
Complete set with
REC HI11106+ REG (05-011H) 14V

Original & X-References..

HITACHI L140-53202
L150-83201

For use on: NISSAN (DIESEL)

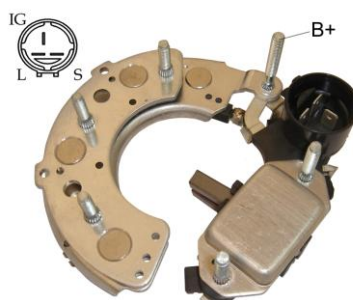

11520100 / HI11116ZT

FEATURES

Diodes: 6-35A Ampere
Complete set with
REC HI11116+ REG (05-010H) 14V

Original & X-References..

HITACHI L140-53202
L150-83201

11520300 / HI11116ZT-2

REC HI11116+ REG (05-012H) 28V

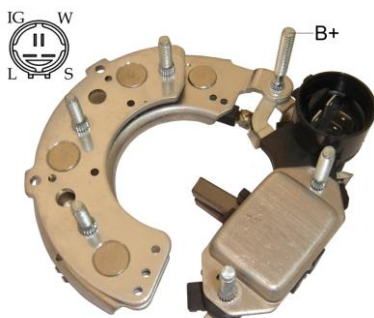

11520200 / HI11116ZT-1

FEATURES

Diodes: 6-35A Ampere
Complete set with
REC HI11116+REG (05-011H) 14V
With 4 pin plug

Original & X-References..



11521000 / HI11146ZT

FEATURES

Diodes: 8-50A Avalanche
Complete set with
REC HI11146+REG (05-100) 14V

Original & X-References..

KIA 37300-27010,27011,27012,27013,27030,27031

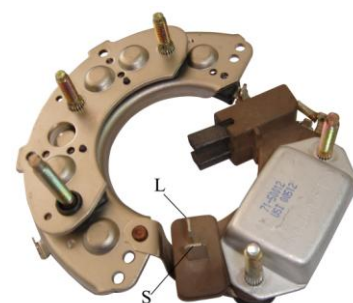

11518000 / HI112ZT21135F

FEATURES

Diodes: 6-35Ampere
Diameter OD: 112mm
Complete set with
REC HI11102F+ REG (05-030H) 14V

Original & X-References..

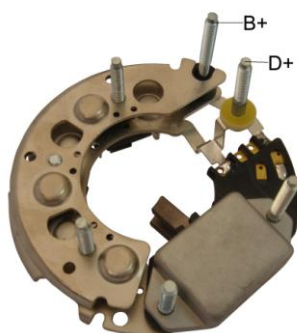

11516100 / HI113ZT12835F

FEATURES	Original & X-References..	
Diodes: 6-35Ampere	CARGO	135680
Complete set with REC HI11124+ REG (12-0031) 28V		

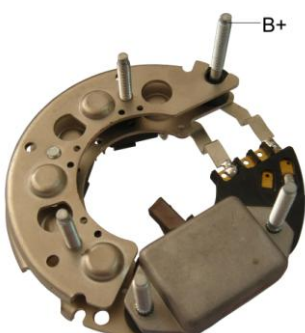

11516500 / HI113ZT22835F

FEATURES	Original & X-References..	
Diodes: 6-35Ampere		
Complete set with REC HI11124+ REG (12-0031) 28V		

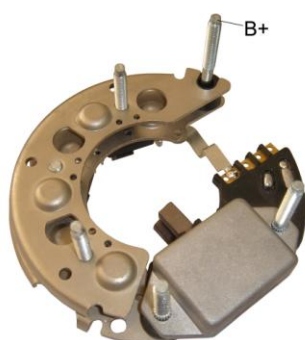

11516600 / HI113ZT32835F

FEATURES	Original & X-References..	
Diodes: 6-35Ampere		
Complete set with REC HI11124+ REG (12-0091) 28V		

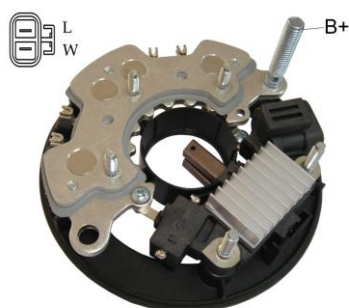

11501100 / HI11301AZT

FEATURES	Original & X-References..	
Diodes: 8-35A Avalanche	HITACHI	LR1100-502E
Complete set with REC HI11301A+REG (05-085) 14V		LR1100-502G
		LR180-501
11501110 / HI11301ZT	TRANSPO	IHR769+IH769
Diodes: 8-35A Ampere	MOBILETRON	RV-H002
Complete set with REC HI11301+REG (05-085) 14V		

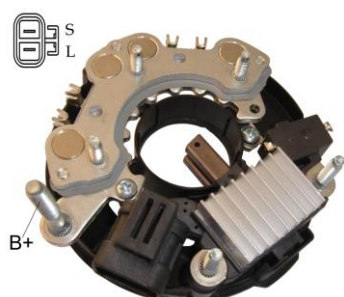

11501500 / HI11302A-1ZT

FEATURES	Original & X-References..	
Diodes: 8-35A Avalanche	NEW ERA	IVR-HIT01
Complete set with REC HI11302A-1+REG(05-042H) 14V		
L.S Terminal		

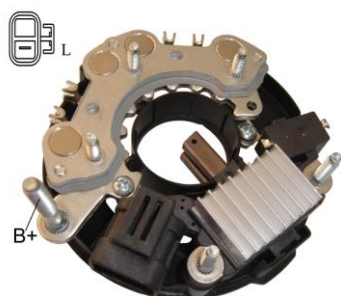
**11502200 / HI11302BZT****FEATURES**

Diodes: 8-35A Avalanche
 Complete set with
 REC **HI11302B+REG (05-037H)** 28V
 L Terminal

Original & X-References..

HITACHI LR250-517
 CARGO 113190

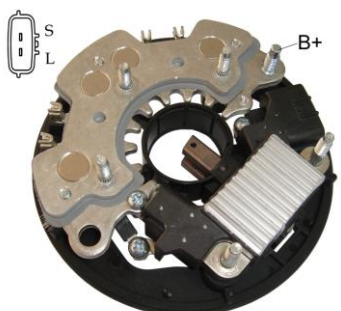
**11502400 / HI11303AZT****FEATURES**

Diodes: 8-60A Avalanche
 Complete set with
 REC **HI11303A+REG (05-0082)** 14V

Original & X-References..

HITACHI LR1110-705
 TRANSPO IHR773+IH766

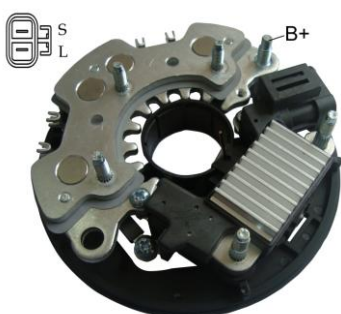
**11502600 / HI11303AZT-2****FEATURES**

Diodes: 8-60A Avalanche
 Complete set with
 REC **HI11303A+REG (05-0251)** 14V

Original & X-References..

LESTER 13939

**11502800 / HI11304AZT****FEATURES**

Diodes: 8-35A Avalanche
 Complete set with
 REC **HI11304A+REG (05-054H)** 14V

Original & X-References..

HITACHI LR1100-734
 TRANSPO IHR770+IH744

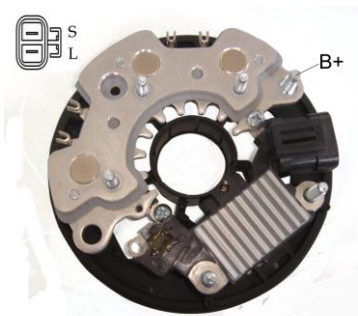
**11502900 / HI11305AZT****FEATURES**

Diodes: 6-35A Avalanche
 Complete set with
 REC **HI11305A+REG (05-054H)** 14V

Original & X-References..

HITACHI LR1110-713C
 TRANSPO IHR771+IH744

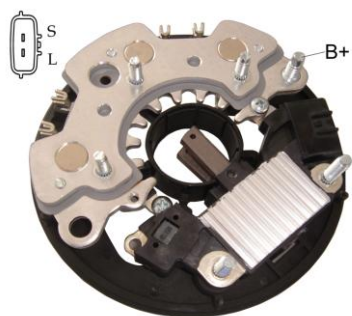

11503000 / HI11305AZT-1

FEATURES

Diodes: 6-35A Avalanche
Complete set with
REC **HI11305A+REG (05-036H)** 14V

Original & X-References..

LESTER 13901
TRANSPO IHR771+IH774



11503100 / HI11305AZT-2

FEATURES

Diodes: 6-35A Avalanche
Complete set with
REC **HI11305A+REG(05-0961)** 14V

Original & X-References..

LESTER 11121
TRANSPO IHR771+IH741

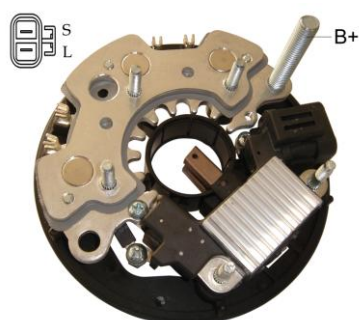

11503200 / HI11306ZT

FEATURES

Diodes: 6-35A Ampere
Complete set with
REC **HI11306+REG (05-0251)** 14V

Original & X-References..

HITACHI LR190-734

11503400 / HI11307ZT

Diodes: 8-35A Ampere
Complete set with
REC **HI11307+REG (05-0251)** 14V



11503700 / HI11308BZT

FEATURES

Diodes: 8-35A Avalanche
With M6×51mm Battery Post
REC **HI11308B+REG (05-016H)** 24V

Original & X-References..

HITACHI LR280-508
MOBILETRON RV-H017B

11503600 / HI11308B-1ZT

With (M8+M4)×55.4mm Battery Post
REC **HI11308B-1+REG(05-016H)**24V

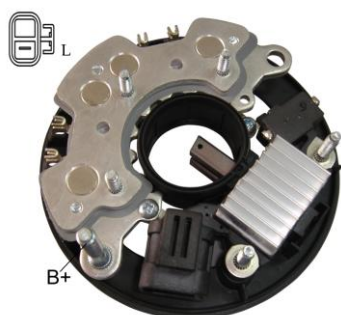

11503800 / HI11308BZT-1

FEATURES

Diodes: 8-35A Avalanche
Complete set with
REC **HI11308B+REG(05-037H)**24V

Original & X-References..

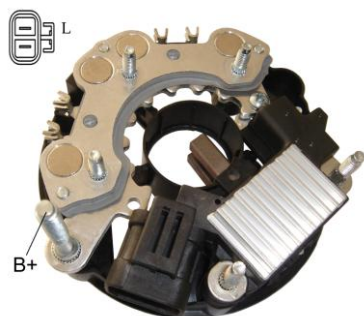
**11503900 / HI11311BZT****FEATURES**

Diodes: 8-35A Avalanche
 Complete set with
 REC **HI11311B+REG (05-1031)** 24V

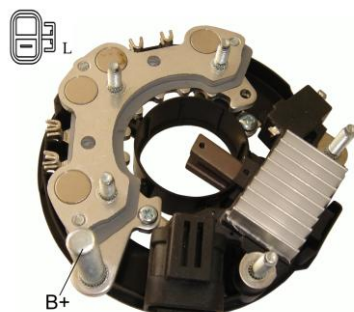
Original & X-References..**11504200 / HI11312ZT****FEATURES**

Diodes: 8-35A Ampere
 Complete set with
 REC **HI11312+REG (05-043H)** 14V
11504100 / HI11312-2ZT
 With M6×48mm Battery Post
 REC **HI11312-2+REG(05-043H)** 14V

Original & X-References..

HITACHI LR180-510

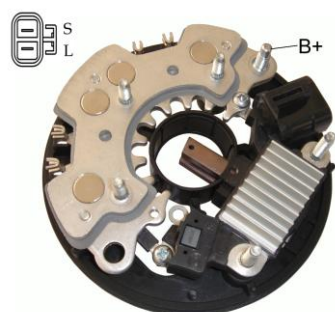
**11504500 / HI11313AZT****FEATURES**

Diodes: 8-60A Avalanche
 Complete set with
 REC **HI11303A+REG (05-0541)** 14V

Original & X-References..

TRANSPO IHR773+IH744

For use on: Nissan Maxima 3.0L
 DOHC, Infiniti 130

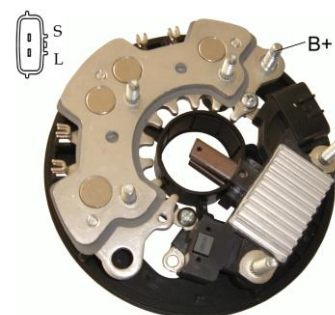
**11504700 / HI11314AZT****FEATURES**

Diodes: 8-35A Avalanche
 Complete set with
 REC **HI11304A+REG (05-036H)** 14V

Original & X-References..

LESTER 13826
 TRANSPO IHR770+IH774

For use on: 95-97 Nissan Maxima 3.0L
 DOHC, 98-99 Nissan Maxima
 SE3.0L, 98-99 Infiniti 3.0L

**11505000 / HI11315AZT****FEATURES**

Diodes: 6-60A Avalanche
 Complete set with
 REC **HI11315A+REG (05-0531)** 14V

Original & X-References..

HITACHI LR1100-502MD
 TRANSPO IHR669+IH669

**11504800 / HI11315A-1ZT****FEATURES**

Diodes: 8-60A Avalanche
 Complete set with
 REC HI11315A-1+REG(05-0141) 14V

Original & X-References..

HITACHI LR1100-502

**11505100 / HI11317AZT****FEATURES**

Diodes: 8-60A Avalanche
 Complete set with
 REC HI11301A+REG (05-0531) 14V

Original & X-References..

HITACHI LR180-508

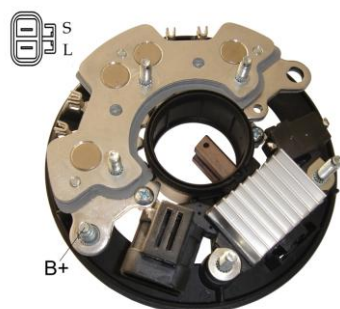
**11505700 / HI11318AZT****FEATURES**

Diodes: 8-35A Avalanche
 Complete set with
 REC HI11318A+REG (05-042H) 14V

Original & X-References..

HITACHI LR1110-501

11505300 / HI11318A-1ZT

With M8×50.5mm Battery Post
 REC HI11318A-1+REG(05-042H)14V

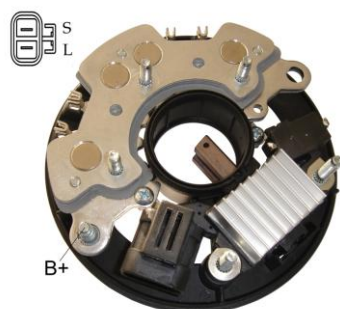
**11505900 / HI11318BZT****FEATURES**

Diodes: 8-35A Avalanche
 Complete set with
 REC HI11318B+REG (05-016H) 24V

Original & X-References..

HITACHI LR280-501

**11506200 / HI11321AZT****FEATURES**

Diodes: 8-35A Avalanche
 Complete set with
 REC HI11321A+REG(05-054H)14V

Original & X-References..

HITACHI LR1100-705
 TRANSPO HI11321A+IH744



11506400 / HI11322AZT

FEATURES

Diodes: 12-35A Avalanche
 Complete set with
 REC HI11322A+REG(05-091)14V

Original & X-References..

HITACHI	LR1130-701
WAI	48-8111
LESTER	11120
TRANSPO	IHR765+IH746



11506500 / HI11322AZT-1

FEATURES

Diodes: 12-35A Avalanche
 Complete set with
 REC HI11322A+REG(05-0961) 14V

Original & X-References..

WAI	48-8113
LESTER	11165
TRANSPO	IHR765+IH747

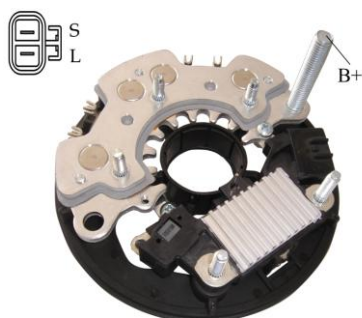

11506700 / HI11323AZT

FEATURES

Diodes: 8-35A Avalanche
 Complete set with
 REC HI11323A+REG(05-054H) 14V

Original & X-References..

HITACHI	LR1100-712
LESTER	13900



11506900 / HI11324AZT

FEATURES

Diodes: 6-35A Avalanche
 Complete set with
 REC HI11324A + REG(05-0961) 14V

Original & X-References..

LESTER	11119
--------	-------



1150BY00

FEATURES

Diodes: 12-35A Avalanche
 Complete set with
 REC 1250BM00+REG(05-1061) 14V

Original & X-References..

HITACHI	LR1130-702
---------	------------



11507500 / HI11332ZT

FEATURES

Diodes: 8-60A Ampere
Complete set with
REC HI11332+REG(05-0251) 14V

Original & X-References..

LESTER 13940



11516700 / HI114ZT

FEATURES

Diodes: 6-35A Ampere
Complete set with
REC HI11123+ REG (05-046) 14V

Original & X-References..

HITACHI LR160-151
LESTER 11460

11516800 / HI114ZT-1

REC HI11123+REG (05-005) 28V

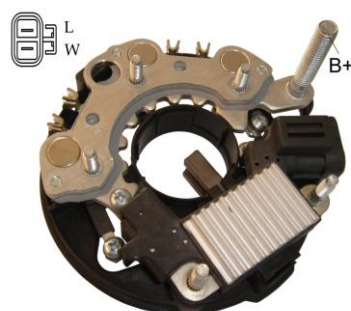

11508510 / HI11401ZT

FEATURES

Diodes: 6-35A Ampere
Complete set with
REC HI11401+REG (05-0041) 14V
For use on: Opel Corsa, Ventra

Original & X-References..

HITACHI LR170-505
LR170-505B
TRANSPO IHR749+IH776

11508500 / HI11401AZT

Diodes: 6-35A Avalanche
REC HI11401A+REG (05-0041) 14V

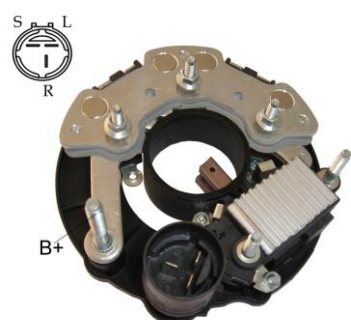

11509100 / HI11402ZT

FEATURES

Diodes: 8-35A Ampere
Complete set with
REC HI11402+REG (05-0031) 24V

Original & X-References..

HITACHI LR235-503C/503B
For use on: 8970832860, 8970832710

11509000 / HI11402-3ZT

Complete set with
REC HI11402+REG (05-0241) 14V

HITACHI LR235-G3320



11509310 / HI11403ZT

FEATURES

Diodes: 8-35A Ampere
Complete set with
REC HI11403+REG (05-0151) 14V
11509300 / HI11403AZT
Diodes: 8-35A Avalanche
Complete set with
REC HI11403A+REG (05-0151) 14V

Original & X-References..

HITACHI LR170-748
LR170-748B
LR180-751
LR190-729
TRANSPO IHR746+IH767

**11509400 / HI11403AZT-1****FEATURES**

Diodes: 8-35A Avalanche
Complete set with
REC **HI11403A+REG(05-001H)** 14V

Original & X-References..

HITACHI LR190-750
LESTER 11027

**1150A010 / HI11405ZT****FEATURES**

Diodes: 6-35A Ampere
Complete set with
REC **HI11405+REG (05-0151)** 14V
1150A000 / HI11405AZT
Diodes: 6-35A Avalanche
Complete set with
REC **HI11405A+REG (05-0151)** 14V

Original & X-References..

HITACHI LR160-727
LR180-741H
LR180-744
TRANSPO IHR778+IH767

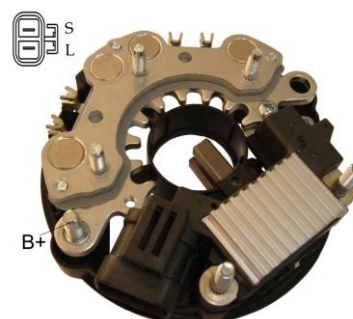
**1150A110 / HI11406ZT****FEATURES**

Diodes: 8-35A Ampere
Complete set with
REC **HI11406+REG (05-0151)** 14V
1150A100 / HI11406AZT
Diodes: 8-35A Avalanche
Complete set with
REC **HI11406A+REG (05-0151)** 14V

Original & X-References..

HITACHI LR160-727
TRANSPO HI11406+IH767
LESTER 13644

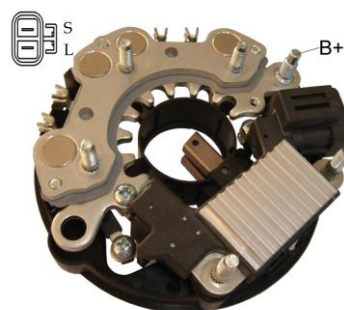
**1150A400 / HI11407AZT****FEATURES**

Diodes: 8-35A Avalanche
Complete set with
REC **HI11407A+REG (05-0251)** 14V
For use on: Subaru Legacy
1150A300 / HI11407A-1ZT
With M8×50.5mm Battery Post
REC **HI11407A-1+REG (05-0251)** 14V

Original & X-References..

LESTER 13645
TRANSPO IHR744+IH765
HITACHI LR160-728
WAI 48-8102
TRANSPO IHR775+IH765

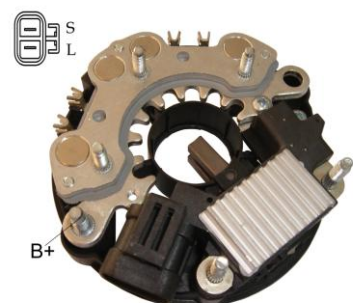
**1150A810 / HI11408ZT****FEATURES**

Diodes: 8-35A Ampere
Complete set with
REC **HI11408+REG (05-0151)** 14V
1150A800 / HI11408AZT
Diodes: 8-35A Avalanche
Complete set with
REC **HI11408A+REG (05-0151)** 14V

Original & X-References..

HITACHI LR190-737
NISSAN 23100-OW001
TRANSPO IHR737+IH767
For use on: 1977-2000 Nisan puthfinder 3.3L



1150AB00 / HI11409ZT

FEATURES

Diodes: 8-35A Ampere
 Complete set with
 REC **HI11409+REG (05-009H)** 14V
1150AA00 / HI11409AZT
 Diodes: 8-35A Avalanche
 Complete set with
 REC **HI11409A+REG (05-009H)** 14V

Original & X-References..

HITACHI LR1100-501B

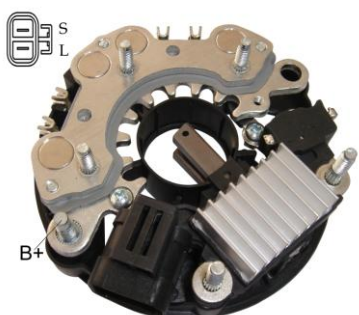

1150AC10 / HI11410ZT

FEATURES

Diodes: 8-35A Ampere
 Complete set with
 REC **HI11410+REG (05-001H)** 14V
1150AC00 / HI11410AZT
 Diodes: 8-35A Avalanche
 Complete set with
 REC **HI11410A+REG (05-001H)** 14V

Original & X-References..

TRANSPO IHR738+IH738
 For use on: 1998-2002 Nissan Forntier 2.4L, 2000-2002 Nissan Xterra 2.4L

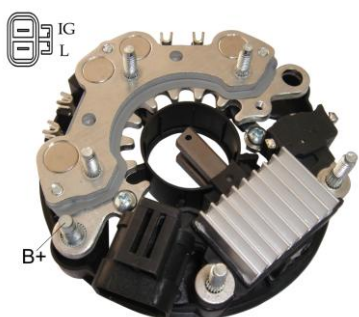

1150AG00 / HI11410AZT-2

FEATURES

Diodes: 8-35A Avalanche
 Complete set with
 REC **HI11410A+REG (05-055H)** 14V

Original & X-References..

HITACHI LR170-757BK

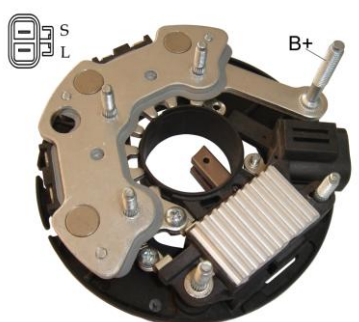

1150AJ00 / HI11411ZT

FEATURES

Diodes: 6-35A Ampere
 Complete set with
 REC **HI11411+REG (05-035H)** 14V
1150AQ00 / HI11416ZT
 With (M8+M4) ×55.4mm Battery Post
 Complete set with
 REC **HI11416+REG (05-035H)** 14V

Original & X-References..

HITACHI LR170-502B



1150AM00 / HI11412ZT

FEATURES

Diodes: 8-35A Ampere
 Complete set with
 REC **HI11412+REG (05-0251)** 14V
1150AL00 / HI11412-1ZT
 With M8×50.5mm Battery Post
 Complete set with
 REC **HI11412-1+REG (05-0251)** 14V

Original & X-References..

HITACHI LR160-728E
 CARGO JA1516IR

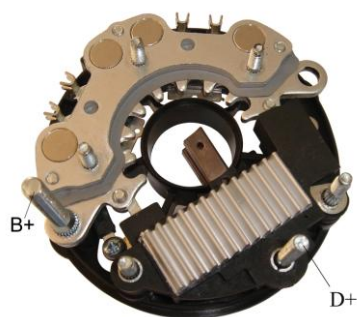

1150AN00 / HI11413ZT

FEATURES

Diodes: 8-35A Ampere
 Complete set with
 REC **HI11413+REG (05-002)** 14V

Original & X-References..



1150AP00 / HI11414ZT

FEATURES

Diodes: 6-35A Ampere
 Complete set with
 REC **HI11414+REG (05-0151)** 14V

Original & X-References..

LESTER	13728
TRANSP0	IHR745+IH767

For use on: Nissan Pick-up, Pathfinder



1150AS00 / HI11417ZT

FEATURES

Diodes: 8-35A Ampere
 Complete set with
 REC **HI11417+REG (05-001H)** 14V

Original & X-References..

1150AR00 / HI11417-1ZT

With M8×49mm Battery Post
 REC **HI11417-1+RE(05-001H)** 14V



1150AT00 / HI11418AZT

FEATURES

Diodes: 6-35A Avalanche
 Complete set with
 REC **HI11418A+REG(05-102)** 14V

Original & X-References..

HITACHI	LR160-730C
LESTER	13745N
TRANSP0	IHR781+IH772



1150AU00 / HI11423-1ZT

FEATURES

Diodes: 8-35A Ampere
 Complete set with
 REC **HI11423-1+REG(05-054H)**14V

Original & X-References..

1150AV00 / HI11423-2ZT

Diodes: 6-35A Ampere
 With M8×45.6mm Battery Bolt
 REC **HI11423-2+REG(05-054H)**14V

HITACHI	LR190-747
---------	-----------



1150AX00 / HI11424ZT

FEATURES

Diodes: 8-35A Ampere
 Complete set with
 REC **HI11424**+REG(**05-054H**)14V

Original & X-References..

HITACHI	LR190-744
LESTER	13825
TRANSPO	IHR764+IH744

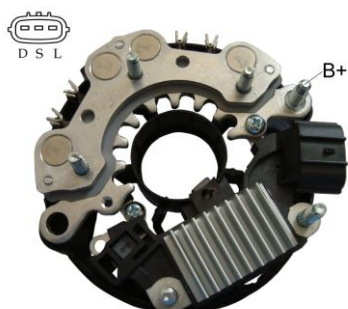

1150AZ00 / HI11427AZT1

FEATURES

Diodes: 8-60A Avalanche
 Complete set with
 REC **HI11427**+REG(**05-041**)14V

Original & X-References..

HITACHI	LR190-742
CARGO	13829
TRANSPO	IHR742+IH742

Customer provide Regulator

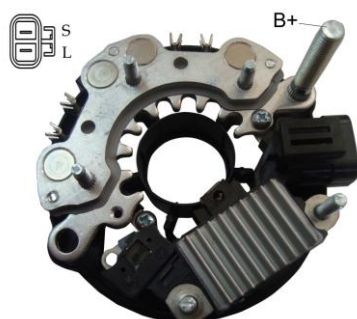

1150B200 / HI11430ZT

FEATURES

Diodes: 8-35A Ampere
 Complete set with
 REC **HI11430**+REG(**05-054H**) 14V

Original & X-References..

HITACHI	LR180-763
YANMAR	12391077210

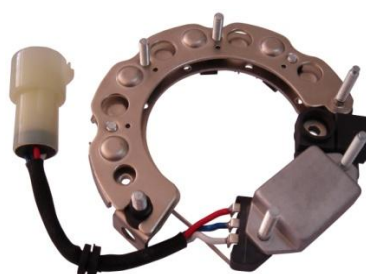

11517400 / HI132ZT

FEATURES

Diodes: 8-25 Ampere
 Diameter OD: 132mm
 Complete set with
 REC **HI13201**+REG (**12-001H**) 28V

Original & X-References..

HITACHI	1-81200-4710-0
	0-3500-3872



12540100 / HI12001A

FEATURES

Diodes:12-35A Avalanche
 With M8×37mm Battery Post
 Without Trio

Original & X-References..

For used on: NISSAN TIIDA

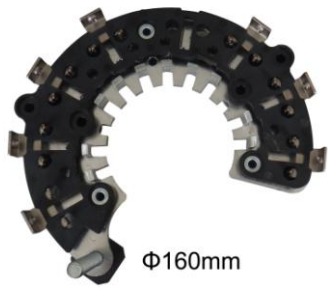

1250B600 / HI16001

FEATURES

Diodes: 12-50A Ampere
Diameter: 160mm
With M8×50.5mm Battery Post
Without Trio

Original & X-References..

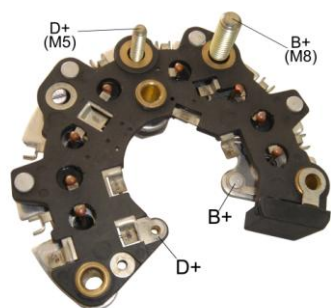

12407200 / ISK001

FEATURES

Diodes: 8-35A Avalanche
 With M8×39.5mm Battery Post
 With M5×28.5mm Trio Post
 With Trio
 With Capacitor

Original & X-References..

ISKRA	16903314
CARGO	231050
MONARK DIESEL	093231050
	93231050

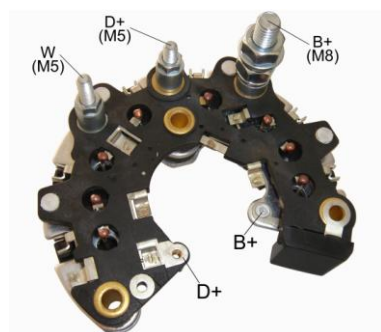

12407400 / ISK002

FEATURES

Diodes: 8-35 A Avalanche
 With M8×54mm Battery Post
 With M5×32mm Trio Post
 With M5×32mm W Post
 With Trio
 With Capacitor

Original & X-References..

ISKRA	16903507
CARGO	231472

12407800 / ISK006

Diodes: 6-35 A Avalanche

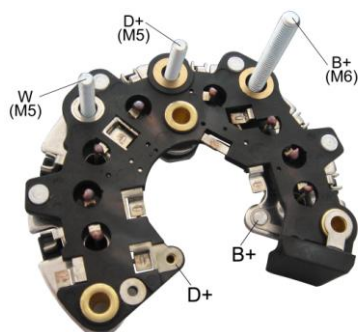

12407500 / ISK003

FEATURES

Diodes: 8-35A Avalanche
 With M6×54mm Battery Post
 With M5×32mm Trio Post
 With M5×32mm W Post
 With Trio
 With Capacitor

Original & X-References..

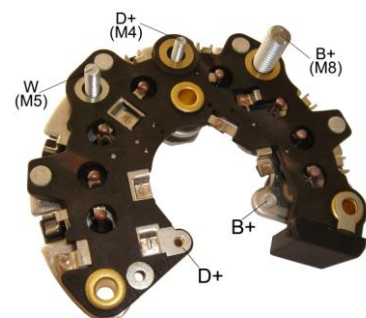

12407600 / ISK004B

FEATURES

Diodes: 8-35A Avalanche
 With M8×35.5mm Battery Post
 With M4×19.8mm Trio Post
 With M5×21.3mm W Post
 With Trio
 With Capacitor
 For 24V Alternators

Original & X-References..

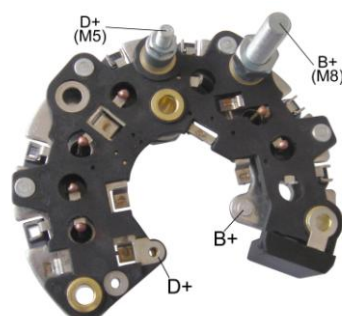

12407700 / ISK005

FEATURES

Diodes: 6-35A Avalanche
 With M8×54mm Battery Post
 With M5×32mm Trio Post
 With Trio
 With Capacitor

Original & X-References..

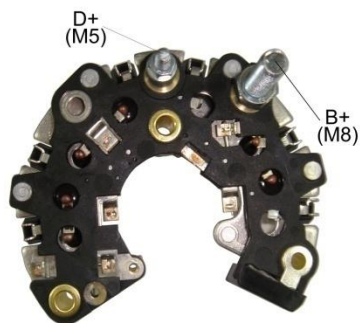

12407900 / ISK007

FEATURES

Original & X-References..

Diodes:8-35A Avalanche
 With M8×39.5mm Battery Post
 With M5×28.5mm Trio Post
 With Trio
 With Capacitor

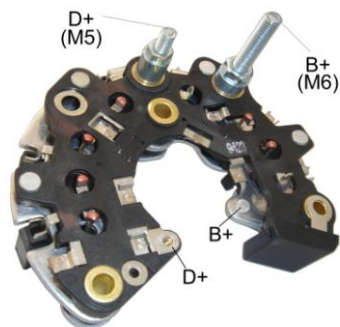

12408000 / ISK008

FEATURES

Original & X-References..

Diodes :6-35A Avalanche
 With M6×54mm Battery Post
 With M5×32mm Trio Post
 With Trio
 With Capacitor

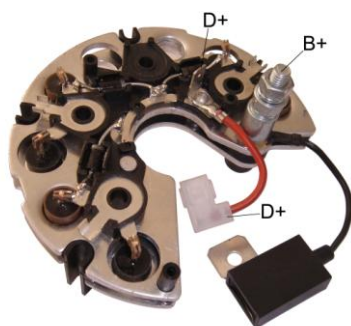

12030200 / LA1102

FEATURES

Diodes: 6-50Avalanche
 With M6×51mm Battery Post
 With Trio/Capacitor
 Without "W" Terminal

Original & X-References..

TR1-105-04

12030500 / LA1104

Diodes: 8-50Avalanche
 Without Capacitor
 Without "W" Terminal

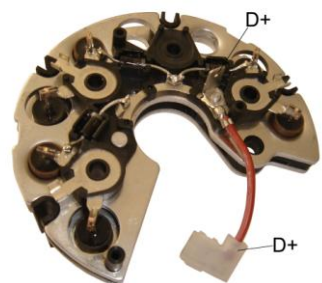

12030300 / LA1103

FEATURES

Diodes: 6-50 A Avalanche
 With Trio
 Without Capacitor
 Without "W" Terminal

Original & X-References..

BVO-1-105

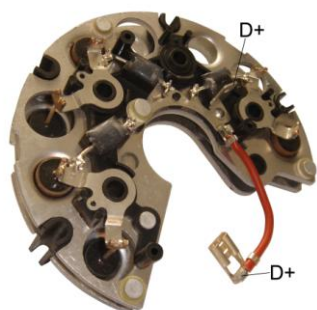

12030700 / LA1107

FEATURES

Diodes: 6-50 A Avalanche
 With Trio
 Without Capacitor
 Without "W" Terminal

Original & X-References..

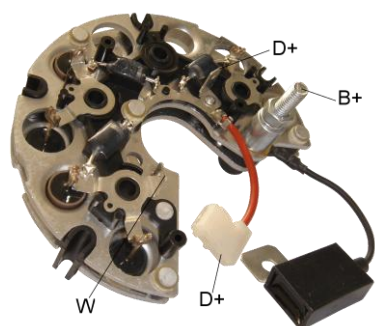

12030800 / LA1107-1

FEATURES

Diodes: 6-50 AAvalanche
 With Trio
 With Capacitor
 With "W" Terminal

Original & X-References..

5B03-105-03

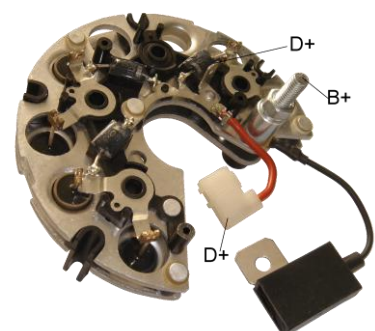

12030900 / LA1107-2

FEATURES

Diodes: 6-50 A Avalanche
 With Trio
 With Capacitor
 Without "W" Terminal

Original & X-References..

6B03-105-01

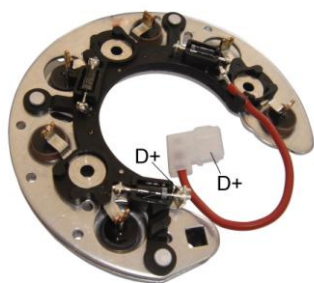

1204010 / LA1114

FEATURES

Diodes: 6-35 Ampere
 With Trio
 Without Capacitor
 Without "W" Terminal

Original & X-References..

56-65-02



12040200 / LA1115

FEATURES

Diodes: 6-35 Ampere
 Without Tiro
 Without Capacitor
 Without "W" Terminal

Original & X-References..

56-65-02e

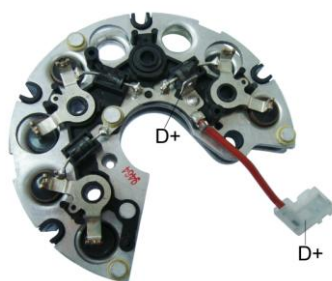

12031900 / LA1125

FEATURES

Diodes:6-50A Avalanche
 With Trio
 Without Capacitor
 Without "W" terminal

Original & X-References..

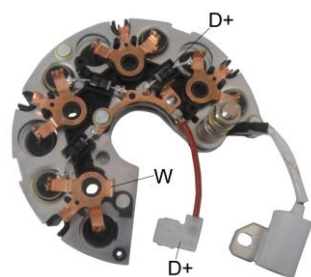

12032100 / LA1128B

FEATURES

Diodes:8-50A Avalanche
 With M6×51mm Battery Post
 With Trio
 With Capacitor
 With "W" terminal
 For 24V Alternators

Original & X-References..



12032300 / LA1130

FEATURES

Diodes:6-35 Avalanche
 With M6×51mm Battery Post
 With Trio
 Without "W" terminal

Original & X-References..

12033100 / LA1139



FEATURES

Diodes: 6-35 A Ampere
With M5×30mm Battery Post
Without Trio
Without Capacitor

Original & X-References..

12912100 / ZLB-07



FEATURES

Diodes: Positive Assembly, 3-50
 Ampere Press Fit 330 Volt
 With Lead Wire 1-125mm
 With Lead Wire 2-85mm

Original & X-References..

LEECE NEVILLE 97084
 MOBILETRON RC-07HV
 WAI 31-505
 CARGO 230752
 LESTER 7613
 TRANSPO LR97084

For use on: 140-160A 2800JB Series,
 7800JB Series

12912400 / ZLB-08



FEATURES

Diodes: Negative Assembly,3-50
 Ampere Press Fit 330 Volt
 With Lead Wire 1-125mm
 With Lead Wire 2-85mm

Original & X-References..

LEECE NEVILLE 97085
 MOBILETRON RC-08HV
 WAI 31-504
 CARGO 230753
 LESTER 7613
 TRANSPO LR97085

For use on: 140-160A 2800JB Series,
 7800JB Series

12912700 / ZLB-09



FEATURES

Diodes: Positive ssembly,3-35
 Ampere Press Fit 330 Volt
 With Lead Wire 3-125mm

Original & X-References..

LEECE NEVILLE 79193
 MOBILETRON RC-05HV
 WAI 31-503
 CARGO 230606
 LESTER 7614
 7767
 7602
 TRANSPO LR79193

For use on: 130A 2700JB Series

12913000 / ZLB-10



FEATURES

Diodes: Negative Assembly,3-35
 Ampere Press Fit 330 Volt
 With Lead Wire 3-134mm

Original & X-References..

LEECE NEVILLE 79415
 MOBILETRON RC-06HV
 WAI 31-502
 CARGO 230607
 LESTER 7706JA
 7711JA
 TRANSPO LR79415

For use on: 130A 2700JB Series

12913400 / ZLB-11



FEATURES

Diodes: Positive Assembly,3-35
 Ampere Button
 Steel Heat Sink
 With 1/4" x 40 Battery Post

Original & X-References..

WAI 31-301-1
 CARGO 131420
 TRANSPO CR3040
 CR3042
 CR3042HD

For use on: Chrysler Square Back



12913600 / ZLB-12

FEATURES

Diodes: Negative Assembly, 3-35
Ampere Button
Aluminum Heat Sink

For use on: Chrysler Square Back

Original & X-References..

WAI	31-300-2
CARGO	131419
TRANSPO	CR3041
	CR3043
	CR3043HD



12914100 / ZLB-17

FEATURES

Diodes: 6-50Ampere
Negative Assembly
10-Gauge Leads with Hi-Temp
Insulation

For use on: EMV, Navistar Trucks

Original & X-References..

LEECE NEVILLE	101425
TRANSPO	LR711425



12914200 / ZLB-18

FEATURES

Diodes: Positive Assembly, 3-35 Ampere
Button
Aluminum Heat Sink
With 1/4" x 40 Battery Post

Original & X-References..

1070-0710



12914300 / ZLB-19N

FEATURES

Diodes: 4-30 Ampere
Negative Assembly
Aluminum Heat Sink

Original & X-References..



12914400 / ZLB-19P

FEATURES

Diodes: 4-30 Ampere
Positive Assembly
Aluminum Heat Sink

Original & X-References..

12010100 / LUS1101

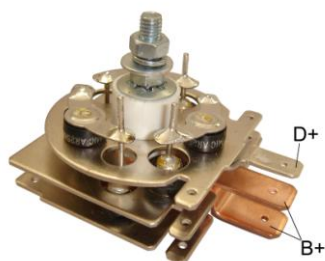

FEATURES

Diodes: 9-25 Ampere Button
 With M5×50mm Mounting Post

 For use on: Austin, Lotus, MG,
 Triumph, Chrysler & Ford Imports

Original & X-References..

LUCAS	83 166	83 334
	83 520	83 842
WAI	31-9200	
CARGO	130643	
MOBILETRON	RL-08HV	
TRANSPO	ILR166	

12010110 / LUS1101HD

Diodes: 9-35Ampere Button

12010200 / LUS1102

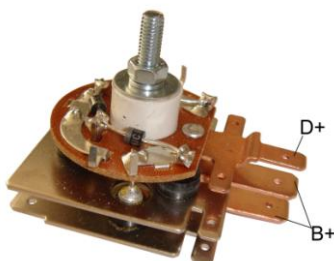

FEATURES

Diodes: 6-25 Ampere Button
 With M5×50mm Mounting Post
 With Trio

Original & X-References..

LUCAS	83 166	
	83 334	83 520
	83 842	83 844
WAI	31-920	
CARGO	130643	

12010300 / LUS1103

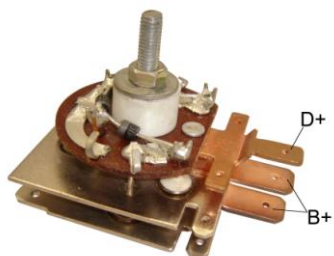

FEATURES

Diodes: 6-35 Ampere Dish Diode
 With M5×50mm Mounting Post
 With Trio

Original & X-References..

For use on: Austin, Lotus, MG,
 Triumph, Chrysler & Ford Imports

12000200 / LUS133

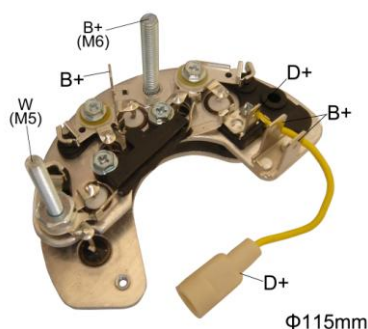

FEATURES

Diodes: 6-35 Ampere
 Diameter OD: 115mm
 With M6×41.7mm Battery Post
 With M5×53.7mm W-Post
 With Lead Wire 110mm
 With Trio

Original & X-References..

LUCAS	84 201	84 422
WAI	31-9208	
CARGO	131304	
MOBILETRON	RL-01H	
TRANSPO	ILR566HD	

For use on: Massey Ferguson, J.I. Case

12000500 / LUS136

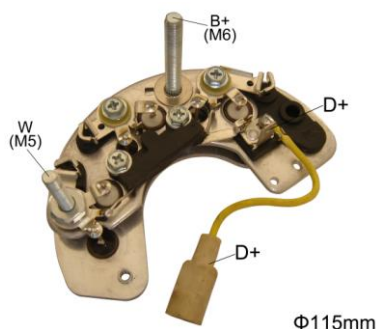

FEATURES

Diodes: 6-35 Ampere
 Diameter OD: 115mm
 With M6×46.5mm Battery Post
 With M5×47.5mm W-Post
 With Lead Wire 110mm
 With Trio

Original & X-References..

LUCAS	84 468	UBB 136
CARGO	132720	
MOBILETRON	RL-11H	
TRANSPO	ILR567HD	

For use on: Ford Tractor

12000600 / LUS137

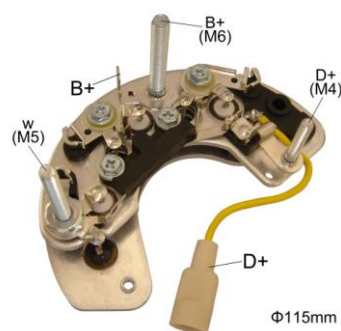

FEATURES

Diodes: 6-35 Ampere
 Diameter OD: 115mm
 With M6×43.7mm Battery Post
 With M5×53.7mm W-Post
 With M4×28mm Trio Post
 With Lead Wire 110mm
 With Trio
 For use on: Ford Tractor, Rover

Original & X-References..

FORD	86AB10304BA
LUCAS	84 469 UBB 137
CARGO	132721
MOBILETRON	RL-09H
TRANSPO	ILR568HD

12000900 / LUS140

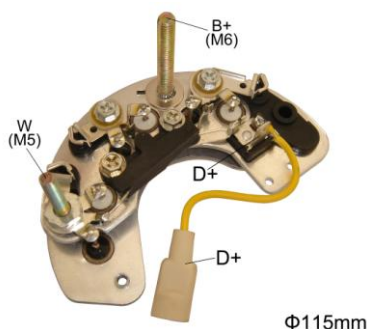

FEATURES

Diodes: 6-35 Ampere
 Diameter OD: 115mm
 With M6×46.5mm Battery Post
 With M5×47.5mm W-Post
 With Lead Wire 110mm
 With Trio

Original & X-References..

LUCAS	UBB 140 84456
WAI	31-9220
CARGO	132718
MOBILETRON	RL-06H
UNIPOINT	REC-834
TRANSPO	ILR570HD

12001000 / LUS143

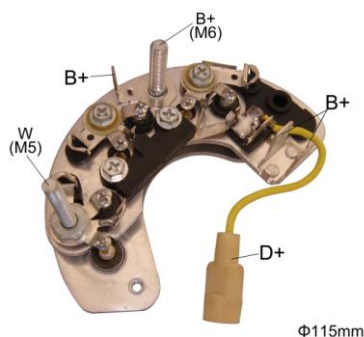

FEATURES

Diodes: 6-35 Ampere
 Diameter OD: 115mm
 With M6×32.5mm Battery Post
 With M5×53.7mm W-Post
 With Lead Wire 110mm
 With Trio
 For use on: Industrial

Original & X-References..

LUCAS	84 889 UBB 143
WAI	31-9208
CARGO	131304
MOBILETRON	RL-01H
UNIPOINT	REC-838
	REC831
TRANSPO	ILR571HD

12001100 / LUS145

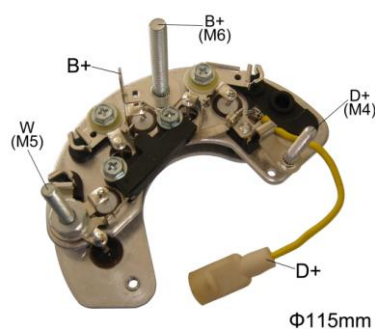

FEATURES

Diodes: 6-35 Ampere
 Diameter OD: 115mm
 With M6×43.7mm Battery Post
 With M5×47.5mm W-Post
 With M4×28mm Trio Post
 With Lead Wire 110mm
 With Trio
 For use on: Ford

Original & X-References..

LUCAS	4572 UBB 145
WAI	31-9222
CARGO	136666
MOBILETRON	RL-21H
UNIPOINT	REC-835
TRANSPO	ILR572HD

12001200 / LUS147

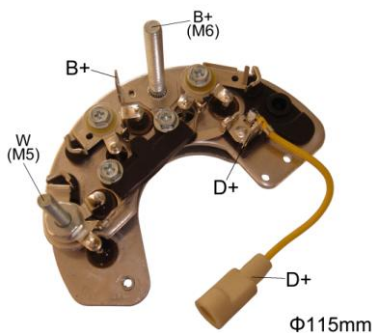

FEATURES

Diodes: 6-35 Ampere
 Diameter OD: 115mm
 With M6×46.5mm Battery Post
 With M5×47.5mm W-Post
 With Trio
 For use on: Industrial

Original & X-References..

LUCAS	84 888 UBB 147
WAI	31-9221
CARGO	133430
MOBILETRON	RL-07H
UNIPOINT	REC836
TRANSPO	ILR574HD

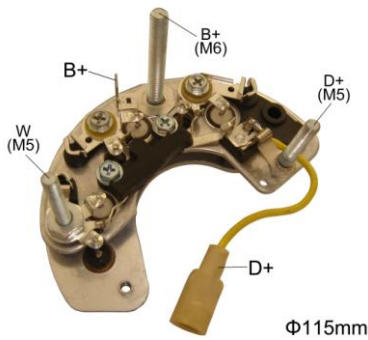

12001300 / LUS148

FEATURES

Diodes: 6-35 Ampere
 Diameter OD: 115mm
 With M6×52mm Battery Post
 With M5×53.7mm W-Post
 With M5×31.5mm Trio Post
 With Lead Wire 110mm
 With Trio

Original & X-References..

LUCAS	84 976	633 285 06
WAI	31-9223	
CARGO	136324	
MOBILETRON	RL-10H	
TRANSPO	ILR576HD	

For use on: Nissan Primera

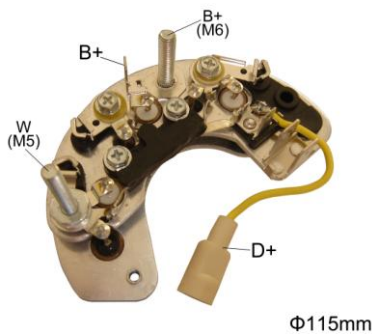

12001400 / LUS149

FEATURES

Diodes: 6-35 Ampere
 Diameter OD: 115mm
 With M6×32.5 mm Battery Post
 With M5×53.7mm W-Post
 With Lead Wire 110mm
 With Trio

Original & X-References..

LUCAS	84 574	UBB 138
CARGO	138808	
MOBILETRON	RL-22H	
TRANSPO	ILR569HD	

For use on: Nissan Industrial, Rover

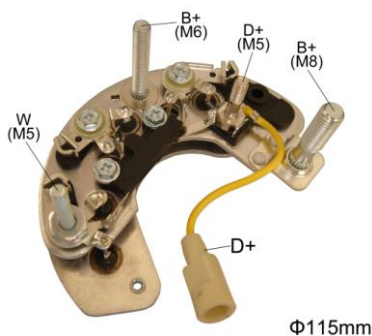

12001500 / LUS152

FEATURES

Diodes: 6-35 Ampere
 Diameter OD: 115mm
 With M6×41.7mm Battery Post
 With M8×38mm Battery Post
 With M5×47.5mm W-Post
 With M5×25mm Trio Post
 With Lead Wire 110mm
 With Trio

Original & X-References..

12020100 / LUS1301A

FEATURES

Diodes: 6-35A Avalanche
 Diameter OD: 120mm
 With M6×43.7mm Battery Post
 With Lead Wire 60mm
 With Trio

Original & X-References..



12720100 / MG6301

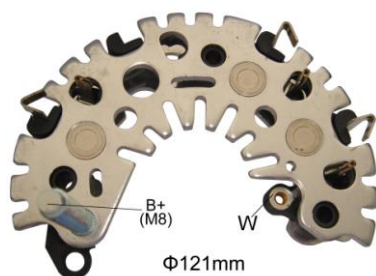

FEATURES

Diodes: 6-50A Avalanche
 Diameter OD: 121mm
 With M8×50mm Battery Post
 Without trio
 For use on: Alfa Romeo 145,146,155
 GTV spider Fiat Bravo, Barchetta,
 Marea, Palio, Punto90, Ducato 1.9TD
 Lancia Nuova, Delta, Dedra K2.4TD

Original & X-References..

MAGNETI MARELLI
 63624201
 63320256
 MOBILETRON RI-23H
 CARGO 138377
 TRANSPO IXR642

12720200 / MG6302

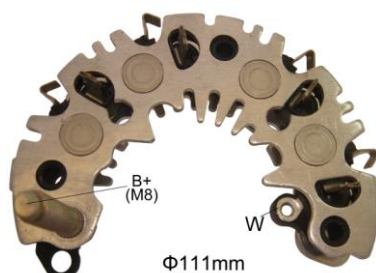

FEATURES

Diodes: 8-50A Avalanche
 Diameter OD: 111mm
 With M8×50mm Battery Post
 For use on: Fiat Punto 55,66,75,90 TDS

Original & X-References..

MAGNETI MARELLI
 63321240
 63623701
 MOBILETRON RI-19H
 WAI 31-9338
 CARGO 138800
 TRANSPO IXR634

12730100 / MG6303

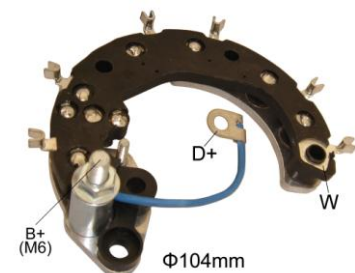

FEATURES

Diodes: 6-35Ampere
 Diameter OD: 104mm
 With M6×41mm Battery Post
 With M4×17mm
 With Trio
12730300 / MG6303-2
 With insulator

Original & X-References..

MAGNETI MARELLI
 84574
 MOBILETRON RI-16H
 CARGO 136740/136458
 TRANSPO IXR542

12720300 / MG6304

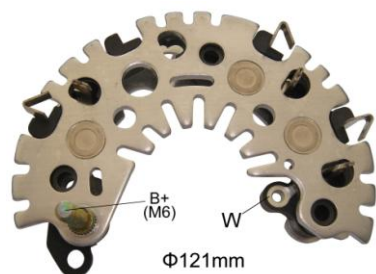

FEATURES

Diodes: 6-50A Avalanche
 Diameter OD: 121mm
 With M6×34.5mm Battery Post

Original & X-References..

MAGNETI MARELLI
 63624202
 MOBILETRON RI-24H
 CARGO 138801
 TRANSPO IXR719

12720500 / MG6305



FEATURES

Diodes: 6-35A Avalanche
 Diameter OD: 111mm
 With M6×39.5mm Battery Post

Original & X-References..

ALTERNAOTR REFERENCES
 CARGO CA1217IR
 FIAT 63341730

12720600 / MG6306

Diodes: 8-50A Avalanche

**12720700 / MG6307****FEATURES**

Diodes: 6-35A Avalanche
 Diameter OD: 111mm
 With M8×50mm Battery Post

Original & X-References..

MAGNETI MARELLI	
63623501	RDD33
MOBILETRON	RI-14H
CARGO	136423
TRANSPO	IXR633

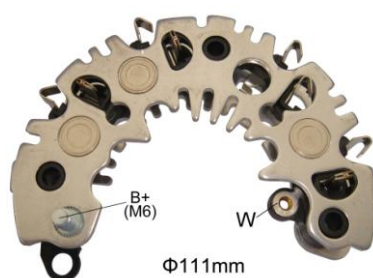
**12720800 / MG6309****FEATURES**

Diodes: 6-35A Avalanche
 Diameter OD: 111mm
 With M6×18.5mm Battery Post

Original & X-References..

CARGO	230119
-------	--------

**12720900 / MG6310****FEATURES**

Diodes: 8-35A Avalanche
 Diameter OD: 111mm
 With M6×18.5mm Battery Post

Original & X-References..**12721000 / MG6311****FEATURES**

Diodes: 6-50A Avalanche
 Diameter OD: 111mm
 With M6×39.5mm Battery Post

Original & X-References..

MAGNETI MARELLI	
	63321636
	CA1488IR

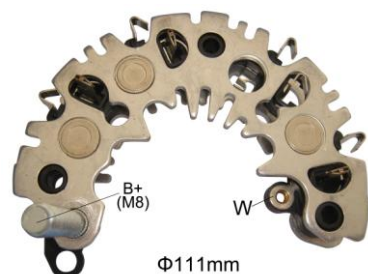
12721100 / MG6312**FEATURES**

Diodes: 6-35A Avalanche
 Diameter OD: 111mm
 With M8×50mm Battery Post
 Without trio
 For use on: Fiat Punto 55,60,75,90 TDS

Original & X-References..

MAGNETI MARELLI		
63624801		
063624701010		063624801010
MOBILETRON		RI-21H
CARGO		138376
TRANSPO		IXR635

12721200 / MG6313

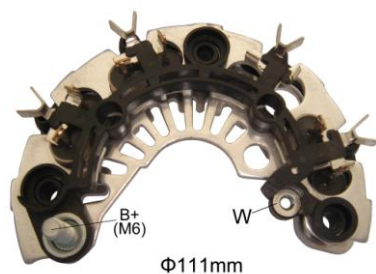

FEATURES

Diodes: 6-35A Avalanche
 Diameter OD: 111mm
 With M6×23.5mm Battery Post

Original & X-References..

MAGNETI MARELLI	1201-0003
CARGO	CA1340IR
FIAT	63321679
	63341679
MOBILETRON	RI-32H
TRANSPO	IXR631

12721300 / MG6314



FEATURES

Diodes: 6-35A Avalanche
 Diameter OD: 111mm
 With M8×50mm Battery Post

Original & X-References..

MAGNETI MARELLI	63625002
CARGO	231025

12721500 / MG6316

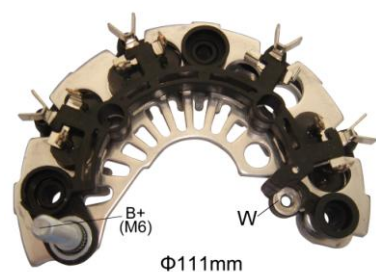

FEATURES

Diodes: 6-35A Avalanche
 Diameter OD: 111mm
 With M6×39.5mm Battery Post

Original & X-References..

TRANSPO	IXR631
---------	--------

12722300 / MG6322A

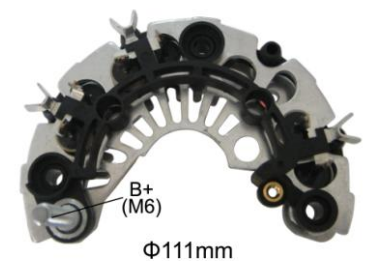

FEATURES

Diodes: 6-50A Avalanche
 Diameter: 111mm
 With M6×39.5mm Battery Post

Original & X-References..

12722500 / MG6324A

With M8×49mm Battery Post

12721600 / MG6317



FEATURES

Diodes: 6-35A Avalanche
 Diameter OD: 121mm
 With M8×46mm Battery Post

Original & X-References..

ALT348

12721700 / MG6318

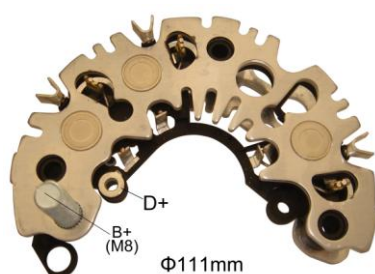

FEATURES

Diodes: 6-35A Avalanche
 Diameter OD: 111mm
 With M8×33.3mm Battery Post
 With Trio

Original & X-References..

12721800 / MG6319

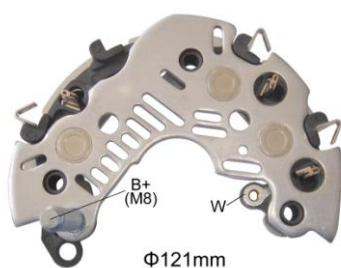

FEATURES

Diodes: 6-50A Avalanche
 Diameter OD: 121mm
 With M8×50mm Battery Post
 Without trio

Original & X-References..

ALTERNATOR NO:	
MAGNETI MARELLI	63377491
DENSO	102211-8661
CARGO	239982

12722900

With M8×46mm Battery Post

12740100 / MG6401

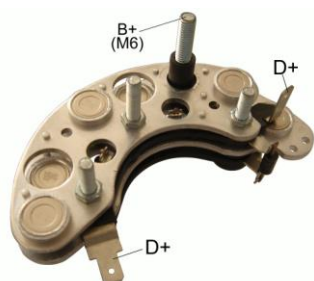

FEATURES

Diodes: 6-35 A Avalanche
 With M6×41.7mm Battery Post
 With Trio

Original & X-References..

MAGNETI MARELLI		
	0135240	0135241
	443930135240	
CARGO	134977	

12740200 / MG6402

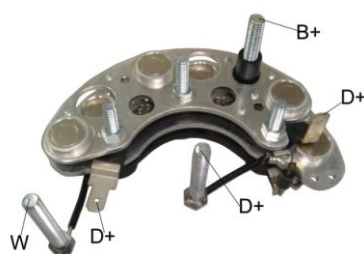

FEATURES

Diodes: 6-35A Avalanche
 With M6×41.7mm Battery Post
 With M5×39mm Trio Post
 With M5×35mm W-Post
 With M5×35mm Mounting Post
 With Trio

Original & X-References..

12740300 / MG6403

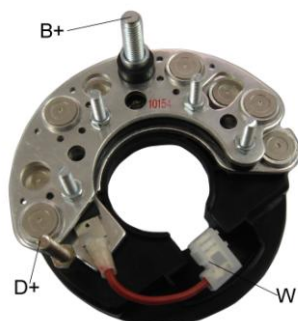

FEATURES

Diodes: 8-50A Avalanche
 With M8×43mm Battery Post
 With M5×28mm Trio Post
 With M5×39mm Mounting Post
 With Trio

Original & X-References..

MAGNETI MARELLI	
	0138801
CARGO	234596

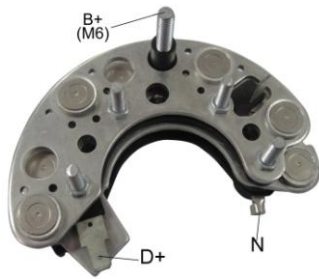

12740500 / MG6405

FEATURES

Diodes: 8-50 Ampere
 With M6×41.7mm Battery Post
 With Trio

Original & X-References..

MAGNETI	MARELLI
0135940	0135941
0140880	0140881
CARGO	231721

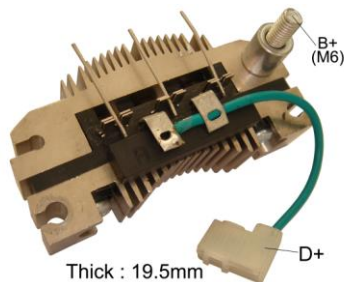

Thick : 19.5mm

12700100 / MG6901

FEATURES

Diodes: 6-25Ampere Button
 With M6×45mm Batter Post
 With M5×25mm Tighting Bolt
 With Trio
 Thick: 19.5mm
 For use on: Fiat

Original & X-References..

FIAT			
4 808 510	4 808 513	4 808 517	
4 808 518	7 541 401	7 542 145	
7 548 004	7 552 382		
MOBILETRON	RI-02		
UNIPOINT	REC-353		
WAI	31-9304		
CARGO	131505		
TRANSPO	IXR 693		

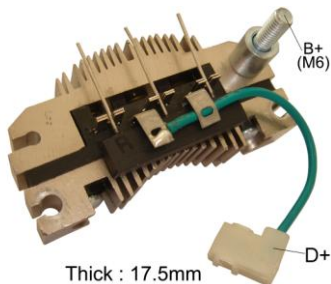

Thick : 17.5mm

12700200 / MG6902

FEATURES

Diodes: 6-25Ampere Button
 With M6×45mm Battery Post
 With Trio
 Thick: 17.5mm
 For use on: Fiat

Original & X-References..

MAGNETI	MARELLI	63621501
LUCAS	21222124	UBB 812
WAI	31-9305	
CARGO	131391	
TRANSPO	IXR692	

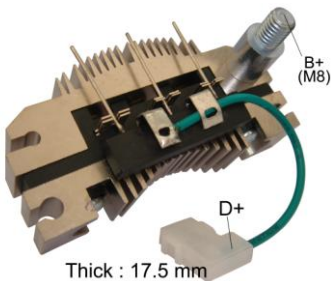

Thick : 17.5 mm

12700300 / MG6903

FEATURES

Diodes: 6-25Ampere Button
 With (M8+M5)×50.5mm Battery Post
 With Trio
 Thick: 17.5 mm

Original & X-References..

MAGNETI	MARELLI	
063622901010	63622901	
CARGO	139218	
TRANSPO	IXR704	

For use on: Fiat

12700310 / MG6903-1

Diodes: 6-35A Ampere Button

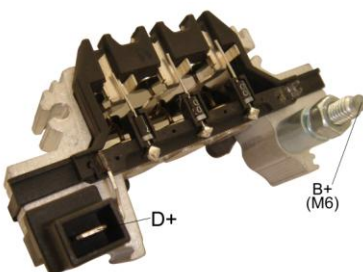

12710100 / MG6904

FEATURES

Diodes: 6-35A Avalanche press fit diode
 With M6×50mm Battery Post
 With Trio

Original & X-References..



12700400 / MG6905

FEATURES

Diodes: 6-35Ampere Button
With Trio
Thick:17.5mm

For use on: Fiat

Original & X-References..

MAGNETI MARELLI	
64826040	64878691
MOBILETRON	RI-01
UNIPOINT	REC-351/352
WAI	31-9302
CARGO	130650
TRANSPO	IXR691



12700500 / MG6906

FEATURES

Diodes: 6-35Ampere Button
Without Trio
Thick:17.5mm
For use on: Peugeot 404,405, Renault R16,R6,Saab

Original & X-References..

MAGNETI MARELLI		
	690971	
VALEO	NC013	NC014
MOBILETRON	RU-01	
UNIPOINT	REC-923	
CARGO	130634	
WAI	31-9400	
TRANSPO	IDR197	

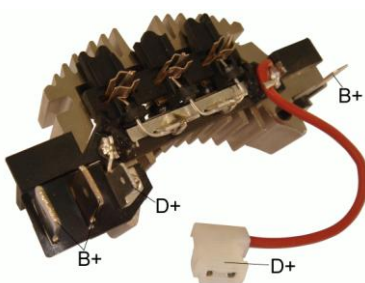

12700600 / MG6907

FEATURES

Diodes: 6-25 Ampere Button
With Trio

Original & X-References..

ISKRA	16906614
MOBILETRON	RT-19H
CARGO	231363



12700800 / MG6908

FEATURES

Diodes: 6-35Ampere Button
With Trio
Thick:17.5mm

Original & X-References..

DELCO	21220366
MOBILETRON	RU-02
TRANSPO	IDR560

For use on: Fiat

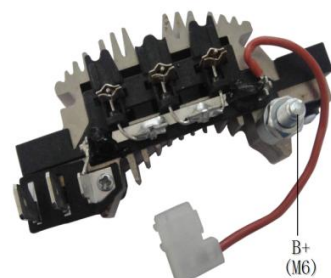

12700900 / MG6911

FEATURES

Diodes: 6-25 Ampere Button
With M6×50mm Battery Post
With Trio

Original & X-References..

ISKARA	11.201.810
--------	------------

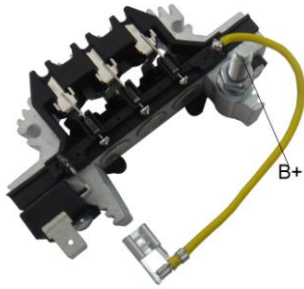

12710200 / MG6913A

FEATURES

Diodes:6-35 A Avalanche
With M6×50mm Battery Post
With Trio

Original & X-References..

12609300 / MIA6501

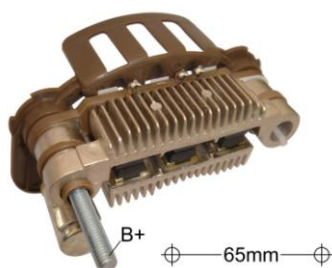

FEATURES

Diodes: 6-30 Ampere
 Mounting Length: 65mm
 With M5×49mm Battery Post
 With Trio

For use on: Ford, Mazda, Mitsubishi,
 Plymouth

Original & X-References..

MITSUBISHI	A 860 T 19870
	A 860 T 11970 A 860 T 13370
MOBILETRON	RM-01 RM-02
	RM-15
WAI	31-8305 31-8316
CARGO	132039 136981
	132715
TRANSPO	IMR6542

12609400 / MIA6502

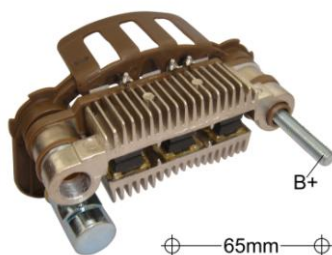

FEATURES

Diodes: 6-30 Ampere
 Mounting Length: 65mm
 With M5×49mm Battery Post
 With Trio

For use on: Subaru Justy

Original & X-References..

12609500 / MIA6503



FEATURES

Diodes: 6-30 Ampere
 Mounting Length: 65mm
 With Trio
 For use on: Hyundai, Mitsubishi, Dodge
 Colt, Hyundai, Mitsubishi Precis,
 Mirage, Plymouth Champ

Original & X-References..

MITSUBISHI	A 860 T 16770
	A 860 T 13770
	MD611254
MOBILETRON	RM-04
WAI	31-8323
CARGO	132791
TRANSPO	IMR6548

12609600 / MIA6504

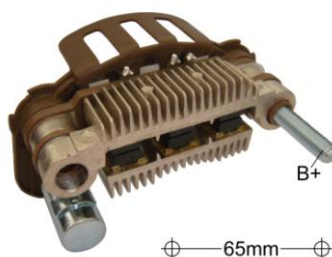

FEATURES

Diodes: 6-30 Ampere
 Mounting Length: 65mm
 With M6×49.5mm Battery Post
 With Trio

For use on: Subaru Justy

Original & X-References..

MITSUBISHI	A 860 T 22770
MOBILETRON	RM-03
WAI	31-8317
CARGO	132789
TRANSPO	IMR6540

12609800 / MIA6506



FEATURES

Diodes : 6-30A Ampere
 Mounting Length : 65mm
 With M8×54mm Battery Post
 With Trio
 With Capacitor

Original & X-References..

1260A300 / MIA7501

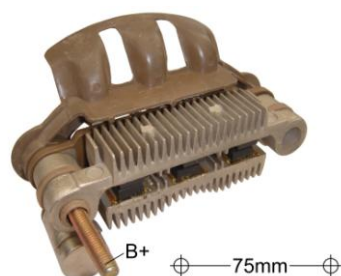

FEATURES

Diodes: 6-30 Ampere
Mounting Length: 75mm
With M5×49mm Battery Post
With Trio

For use on: Mazda 626, B1800, B2000,
Picjup, RX7

Original & X-References..

MITSUBISHI	
A 860 T 17570	A 860 T 17970
A 860 T 24270	A 860 T 13270
MOBILETRON	RM-08
WAI	31-8303
CARGO	132040
TRANSP0	IMR7544

1260A400 / MIA7502

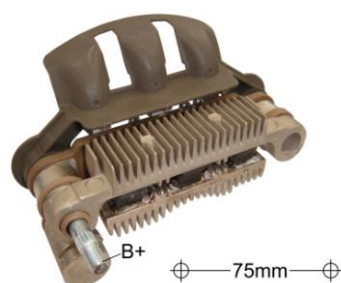

FEATURES

Diodes: 6-30 Ampere
Mounting Length: 75mm
With M5×44mm Battery Post
With Trio

For use on: Mazda 626, Pickup,RX7

Original & X-References..

MITSUBISHI	A 860 T 17570
A 860 T 17970	A 860 T 24270
A 860 T 13270	A 860 T 26970
MOBILETRON	RM-08
WAI	31-8335
CARGO	132040
TRANSP0	IMR7546

1260A500 / MIA7503

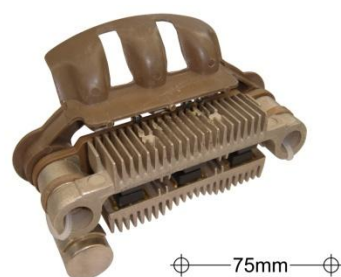

FEATURES

Diodes: 6-30 Ampere
Mounting Length: 75mm
With Trio

For use on: Chrysler Laser, Ford,
Mitsubishi Starion

Original & X-References..

MITSUBISHI	A 860 T 17770
MD611307	A 860 T 17779
MOBILETRON	RM-11
WAI	31-8322
CARGO	133265
UNIPOINT	REC-575
TRANSP0	IMR7550

1260A600 / MIA7504



FEATURES

Diodes: 6-30 Ampere
Mounting Length: 75mm
With M6×49.5mm Battery Post
With Trio

For use on: Mazda 626, MX-6, Ford
Probe, Hyundai, Dodge

Original & X-References..

MITSUBISHI	A 860 T 27170
WAI	31-8320
CARGO	132469
TRANSP0	IMR7556

1260A700 / MIA7505

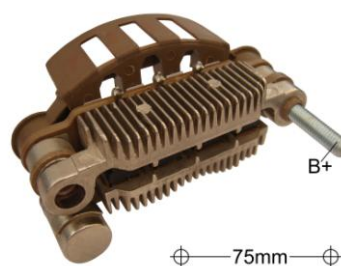

FEATURES

Diodes: 8-30 Ampere
Mounting Length: 75mm
With M6×49.5mm Battery Post
With Trio

For use on: Geo Tracker, Suzuki
Sidekick

Original & X-References..

MITSUBISHI	A 860 T 30370
MOBILETRON	RM-22
WAI	31-8359
CARGO	135215
TRANSP0	IMR7558

1260A900 / MIA7506

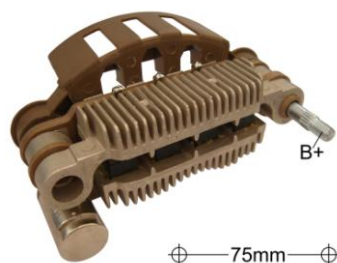

FEATURES

Diodes: 8-30 Ampere
 Mounting Length: 75mm
 With M5×44mm Battery Post
 With Trio

For use on: Mazda Protege

Original & X-References..

MITSUBISHI	A 860 T 32570
MOBILETRON	RM-23
WAI	31-8345
CARGO	134027
TRANSPO	IMR7562

1260AA00 / MIA7507

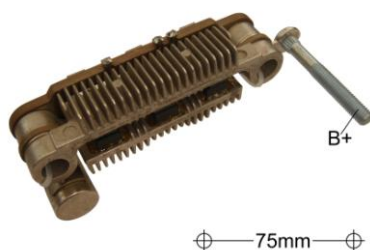

FEATURES

Diodes: 6-30 Ampere
 Mounting Length: 75mm
 With M6×47.5mm Battery Post
 With Trio
 For use on: Mitsubishi Galant, Mirage,
 Pajero

Original & X-References..

MITSUBISHI	A 860 T 22370
	MD611479
MOBILETRON	RM-20HV
WAI	31-8375
CARGO	132468
TRANSPO	IMR7564

1260AB00 / MIA7508



FEATURES

Diodes: 6-30 Ampere
 Mounting Length: 75mm
 With M5×47.5mm Battery Post
 With Trio

For use on: Mitsubishi Mirage Diesel

Original & X-References..

MITSUBISHI	A 860 T 19370
	MD611501
MOBILETRON	RM-18
CARGO	135228
TRANSPO	IMR7568

1260AC00 / MIA7509

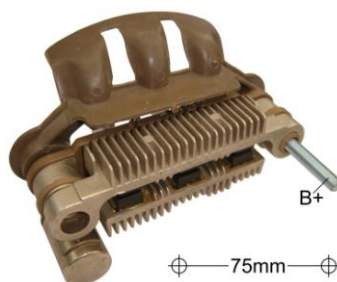

FEATURES

Diodes: 6-30 Ampere
 Mounting Length: 75mm
 With M5×49mm Battery Post
 With Trio
 For use on: Dodge Colt, Mitsubishi
 Mirage 1.5L

Original & X-References..

MITSUBISHI	A 860 T 24570
MOBILETRON	RM-19
WAI	31-8361
CARGO	135248
TRANSPO	IMR7570

1260AD00 / MIA7510

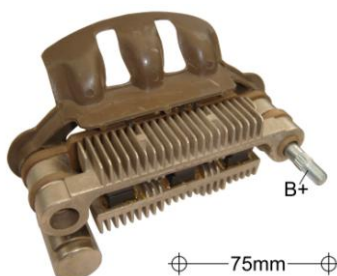

FEATURES

Diodes: 6-30 Ampere
 Mounting Length: 75mm
 With M5×44mm Battery Post
 With Trio
 For use on: Mazda 323

Original & X-References..

MITSUBISHI	A 860 T 27070
MOBILETRON	RM-10 RM-16
WAI	31-8344
CARGO	135247
UNITPOINT	REC-572
TRANSPO	IMR7572

1260AE00 / MIA7512

⊕ — 75mm — ⊕

FEATURES

Diodes: 8-30 Ampere
 Mounting Length: 75mm
 With Trio
 For use on: Honda Civic, Del Sol

Original & X-References..

MITSUBISHI	A5T04292
	A860T38570
MOBILETRON	RM-27
WAI	31-8370
CARGO	232606
TRANSPO	IMR7584

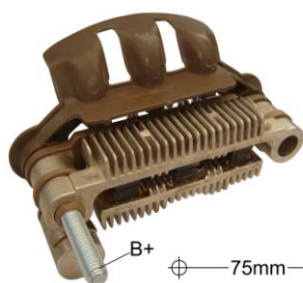
1260AF00 / MIA7513

⊕ — 75mm — ⊕

FEATURES

Diodes: 6-30 Ampere
 Mounting Length: 75mm
 With M6×49.5mm Battery Post
 With Trio
 For use: Mazda 929

Original & X-References..

MITSUBISHI	A860X20099
MOBILETRON	RM-24
WAI	31-8341
CARGO	136733
TRANSPO	IMR7586

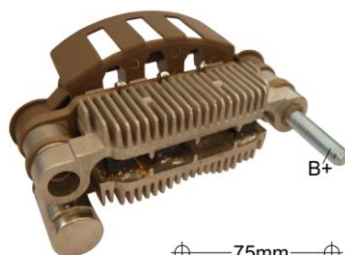
1260AG00 / MIA7514

⊕ — 75mm — ⊕

FEATURES

Diodes: 6-30 Ampere
 Mounting Length: 75mm
 With M6×49.5mm Battery Post
 With Trio
 For use on: Peugeot

Original & X-References..

MITSUBISHI	1901-0002
J&N	172-48098
TRANSPO	IMR7596

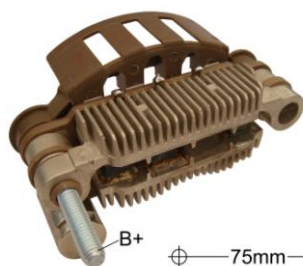
1260AH00 / MIA7515

⊕ — 75mm — ⊕

FEATURES

Diodes: 6-30 Ampere
 Mounting Length: 75mm
 With M6×49.5mm Battery Post
 With Trio

Original & X-References..**1260AI00 / MIA7516**

⊕ — 75mm — ⊕

FEATURES

Diodes: 6-30 Ampere
 Mounting Length: 75mm
 With M8×59.5mm Battery Post
 With Trio

Original & X-References..

MITSUBISHI	A860T46570
	MD61884
CARGO	235890
MOBILETRON	RM-124
TRANSPO	IMR7588

For use on: 1993-94 Mazda Mitsubishi

1260AK00 / MIA7517



FEATURES

Diodes: 6-30 Ampere
Mounting Length: 75mm
With Trio

Original & X-References..

LUCAS 21513132
MITSUBISHI A860T13170
A860T16970
MD607917

For use on: Mitsubishi, Dodge Truck,
Plymouth

MOBILETRON RM-07
WAI 31-8301
CARGO 132466
TRANSPO IMR7542

1260AL00 / MIA7518

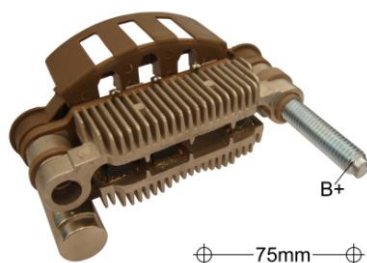

FEATURES

Diodes: 6-30 Ampere
Mounting Length: 75mm
With M8×9.5mm Battery Post
With Trio

Original & X-References..

TRANSPO IMR7588

1260AM00 / MIA7519

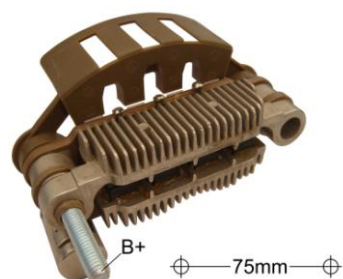

FEATURES

Diodes: 8-30 Ampere
Mounting Length: 75mm
With M6×49.5mm Battery Post
With Trio

Original & X-References..

KIA PRIDE

1260AN00 / MIA7520



FEATURES

Diodes: 6-30 Ampere
Mounting Length: 75mm
With M6×47.5mm Battery Post
With Trio

Original & X-References..

4D55

1260AP00 / MIA7521

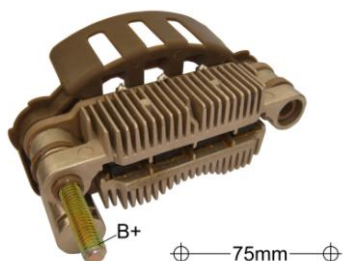

FEATURES

Diodes: 8-30 Ampere
Mounting Length: 75mm
With M6×49.5mm Battery Post
With Trio

Original & X-References..

DAEWOO 96314258
MANDO AB165104

1260B400 / MIA7522

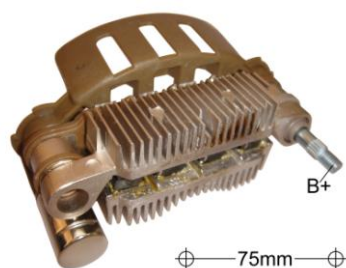

FEATURES

Diodes: 8-30 Ampere
 Mounting Length: 75mm
 With M5×44mm Battery Post
 With Trio
 For use on: Honda Civic

Original & X-References..

MITSUBISHI	A866X45281
	A5T06391
MOBILETRON	RM-28
WAI	31-8371
TRANSP0	IMR7576

1260AQ00 / MIA7523

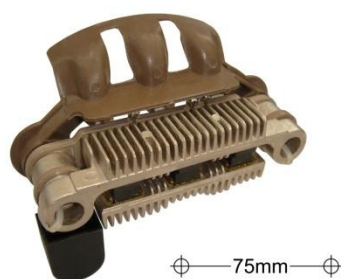

FEATURES

Diodes: 6-30 Ampere
 Mounting Length: 75mm
 With Trio
 For use on: Nissan 200SX, Pulsar,
 Maxima, Stanza

Original & X-References..

MITSUBISHI	A860T17270
MOBILETRON	RM-09
NISSAN	2312408E16
WAI	31-8319
CARGO	132467
TRANSP0	IMR7548

1260AR00 / MIA7524

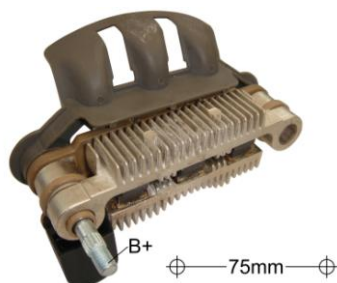

FEATURES

Diodes: 6-30 Ampere
 Mounting Length: 75mm
 With M5×44mm Battery Post
 With Trio
 For use on: Nissan, Mazda323, Mazda
 MX, Mercury Tracer

Original & X-References..

MITSUBISHI	A860T20270
NISSAN	2312458L10
MOBILETRON	RM-12
WAI	31-8324
CARGO	132792
TRANSP0	IMR7552

1260AS00 / MIA7525

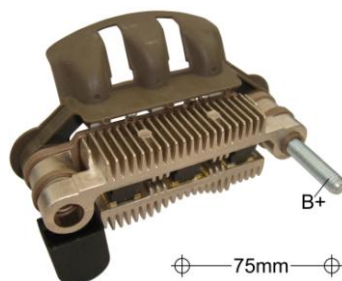

FEATURES

Diodes: 6-30 Ampere
 Mounting Length: 75mm
 With M6×49.5mm Battery Post
 With Trio
 For use on: Nissan 300ZXr

Original & X-References..

MITSUBISHI	A860T16470
NISSAN	2312442L71
MOBILETRON	RM-17
WAI	31-8342
CARGO	133539
TRANSP0	IMR7554

1260AT00 / MIA7526

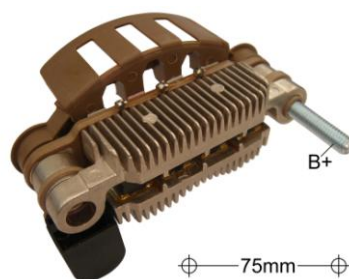

FEATURES

Diodes: 8-30 Ampere
 Mounting Length: 75mm
 With M6×49.5mm Battery Post
 With Trio
 For use on: Nissan Pulsar

Original & X-References..

MITSUBISHI	A860T27270
	A860X27299
MOBILETRON	RM-14
WAI	31-8337
CARGO	134295
TRANSP0	IMR7560

1260AU00 / MIA7527

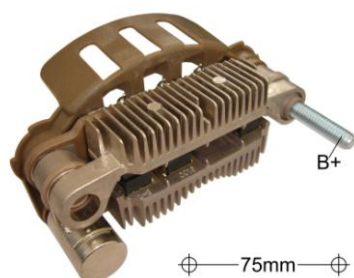

FEATURES

Diodes: 6-30 Ampere
 Mounting Length: 75mm
 With M6×49.5mm Battery Post
 With Trio

Original & X-References..

MITSUBISHI	A5T03391
A5T05091	A5T07091
A5T07092	A5TA0391
A860T39770	
LESTER	13336 13587
	13415
WAI	31-8376
TRANSP0	IMR7582

For use on: Mitsubishi 50-70 Amp IR/IF
 Alternators

1260AV00 / MIA7529

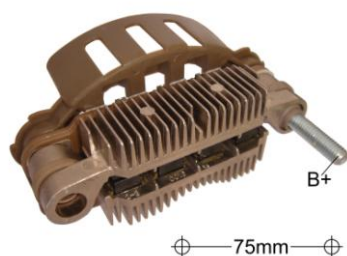

FEATURES

Diodes: 8-30Ampere
 Mounting Length: 75mm
 With M6×49.5mm Battery Post
 Without Trio

Original & X-References..

1260AW00 / MIA7530

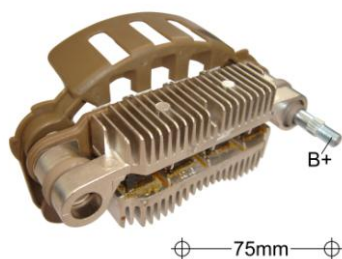

FEATURES

Diodes: 8-30A Avalanche
 Mounting Length: 75mm
 With M5×44mm Battery Post
 Without Trio

Original & X-References..

MITSUBISHI	A005TA6392C
	CA16651IR
CARGO	235526

1260AX00 / MIA7531

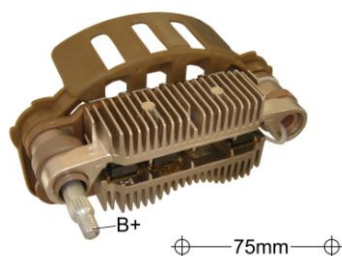

FEATURES

Diodes: 6-30A Avalanche
 Mounting Length: 75mm
 With M5×44mm Battery Post
 Without Trio

Original & X-References..

MITSUBISHI	A001TA3392C
	CA1832IR
CARGO	236741

1260AY00 / MIA7532

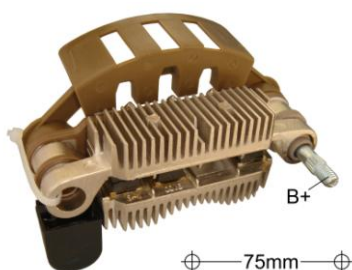

FEATURES

Diodes: 6-30Ampere
 Mounting Length: 75mm
 With M5×44mm Battery Post
 With Trio

Original & X-References..

MITSUBISHI	A5T01577
	A5T03677
MOBILETRON	RM-23
WAI	31-8360
TRANSP0	IMR7580

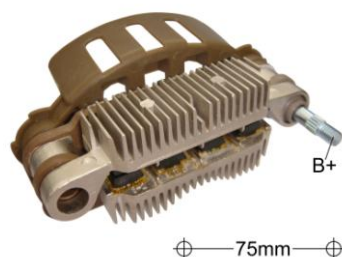
**1260AZ00 / MIA7533****FEATURES**

Diodes: 8-35Ampere
 Mounting Length: 75mm
 With M5×44mm Battery Post
 Without Trio

Original & X-References..

MITSUBISHI	1901-0053
MOBILETRON	RM-145
TRANSPO	IMR7581

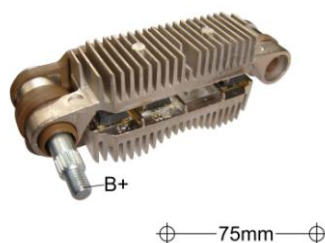
**1260B100 / MIA7535****FEATURES**

Diodes: 6-30A Avalanche
 Mounting Length: 75mm
 With M5×44mm Battery Post
 Without Trio

Original & X-References..

MITSUBISHI	1901-0021
------------	-----------

**1260B200 / MIA7536****FEATURES**

Diodes : 6-30A Avalanche
 Mounting Length : 75mm
 With M5×44mm Battery Post
 Without Trio
 Without Capacitor

Original & X-References..

CARGO	235527
-------	--------

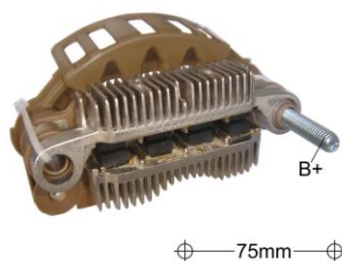
**1260B300 / MIA7537****FEATURES**

Diodes : 8-30A Ampere
 Mounting Length : 75mm
 With M6×49.5mm Battery Post
 Without Trio
 Without Capacitor

Original & X-References..

MITSUBISHI	A5TA7091
GAUSS	GA1383

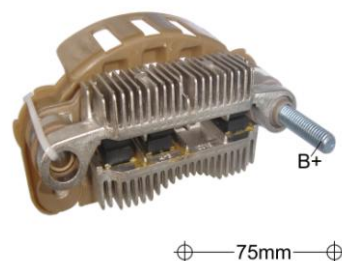
**1260B500 / MIA7538****FEATURES**

Diodes : 6-30A Ampere
 Mounting Length : 75mm
 With M6×49.5mm Battery Post
 Without Trio
 Without Capacitor

Original & X-References..

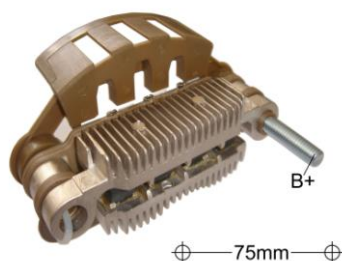
**1260B700 / MIA7540****FEATURES**

Diodes:8-30A Ampere
 Mounting Length : 75mm
 With M6×49.5mm Battery Post
 Without Capacitor
 Without Trio

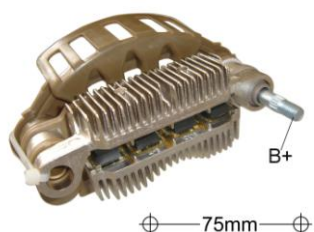
Original & X-References..**1260BC00 / MIA7541****FEATURES**

Diodes:8-30A Ampere
 Mounting Length : 75mm
 With M5×41mm Battery Post
 Without Capacitor
 Without Trio

Original & X-References..

MITSUBISHI	A5TA-7792
TRANSPO	IMR7585

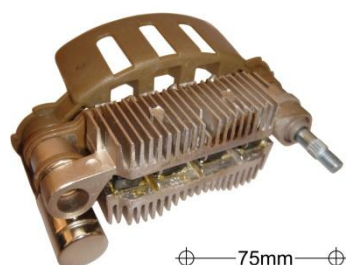
**1260B800 / MIA7542****FEATURES**

Diodes:6-30A Ampere
 Mounting Length : 75mm
 With M5×44mm Battery Post
 With Trio
 With Capacitor

Original & X-References..

MITSUBISHI	1901-0005
MOBILETRON	RM-129
TRANSPO	IMR7590

1260BU00 / MIA7563

The Cover Is Difference With MIA7542

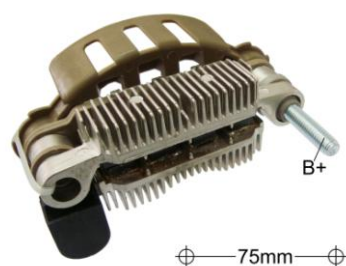
**1260B900 / MIA7543****FEATURES**

Diodes:8-30A Ampere
 Mounting Length : 75mm
 With M6×49.5mm Battery Post
 Without Trio
 Without Capacitor

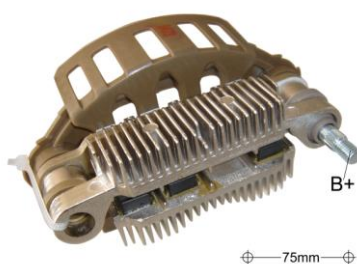
Original & X-References..**1260BA00 / MIA7544****FEATURES**

Diodes: 6-30A Ampere
 Mounting Length: 75mm
 With M5×41mm Battery Post
 Without Trio
 Without Capacitor

Original & X-References..

ALTERNATOR NO	
MITSUBISHI	A005TA7692
CARGO	114129

1260BB00 / MIA7545**FEATURES**

Diodes: 6-30A Ampere
 Mounting Length: 75mm
 With M5×44mm Battery Post
 Without Trio
 Without Capacitor

Original & X-References..

MITSUBISHI	A860X70970
MOBILETRON	RM-129A
CARGO	235892
TRANSPO	IMR75816

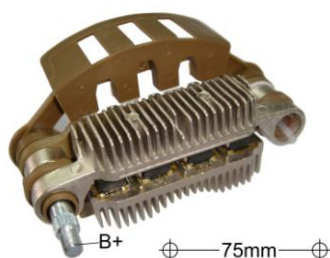
1260BD00 / MIA7546**FEATURES**

Diodes: 8-30A Avalanche
 Mounting Length: 75mm
 With M5×44mm Battery Post
 Without Trio
 Without Capacitor

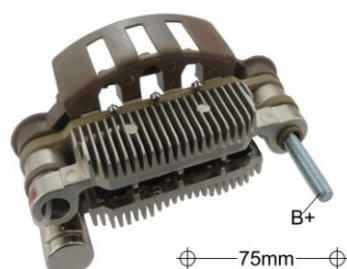
Original & X-References..**1260BG00 / MIA7549****FEATURES**

Diodes: 8-30A Ampere
 Mounting Length: 75mm
 With M5×49mm Battery Post
 With Trio
 With Capacitor

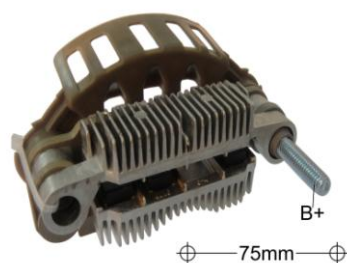
Original & X-References..**1260BH00 / MIA7550****FEATURES**

Diodes: 6-30A Ampere
 Mounting Length: 75mm
 With M6×49.5mm Battery Post
 Without Trio
 Without Capacitor

Original & X-References..

JA1181IR

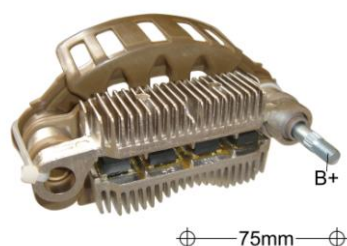
1260B810 / MIA7552**FEATURES**

Diodes: 8-30A Avalanche
 Mounting Length: 75mm
 With M5×41mm Battery Post
 Without Trio
 Without Capacitor

Original & X-References..



1260BI00 / MIA7553

FEATURES

Diodes: 6-30 Ampere
 Diameter OD: 75mm
 With M5×44mm Battery Post
 With Trio/Capacitor

Original & X-References..

TRANSPO IMR7580

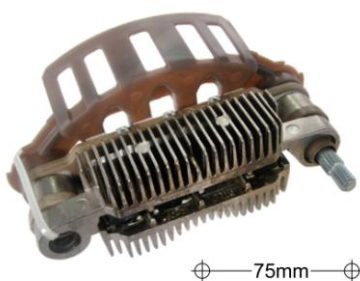

1260BK00 / MIA7555

FEATURES

Diodes : 6-30 A Ampere
 Mounting Length: 75mm
 With M5×41mm Battery Post
 Without Trio

Original & X-References..



1260BN00 / MIA7557

FEATURES

Diodes: 8-30 Ampere
 Mounting Length: 75mm
 With M5×44mm Battery Post
 With Trio/Capacitor

Original & X-References..

MITSUBISHI A860X45281
 CARGO 134027
 MOBILETRON RM-23 RM-28
 LESTER 13700
 TRANSPO IMR7576

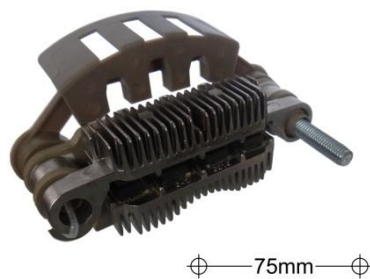

1260BQ00 / MIA7559

FEATURES

Diodes: 8-30 Ampere
 Mounting Length: 75mm
 With M6×49.5mm Battery Post
 Without Trio/Capacitor

Original & X-References..

MITSUBISHI A860X83370
 MOBILETRON RM-136
 CARGO 235297
 TRANSPO IMR7579

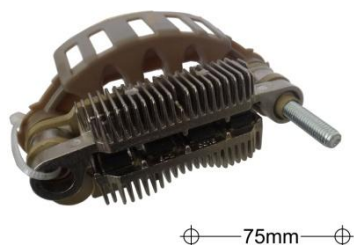

1260BR00 / MIA7560

FEATURES

Diodes: 8-30 Ampere
 Mounting Length: 75mm
 With M6×49.5mm Battery Post
 Without Trio/Capacitor

Original & X-References..

LESTER 13893

1260C200 / MIA7601

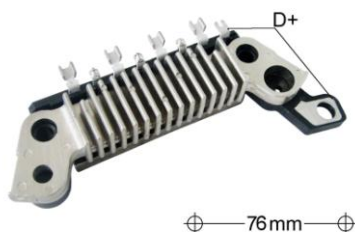

FEATURES

Diodes: 8-30 Ampere
Mounting Length: 76mm
With Trio

Original & X-References..

KOMATSU 6008253160
NIKKO 03500-0402
LESTER 12259

1260DB00 / MIA7602

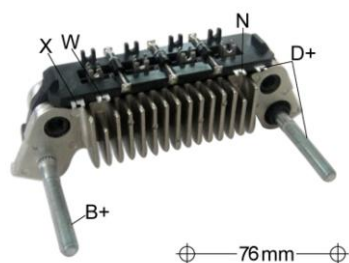

FEATURES

Diodes: 8-30 Ampere
Mounting Length: 76mm
With M5x49mm Battery Post
With Trio

Original & X-References..

KOMATSU 6008216160
0330006511
NIKKO 035730-0510
TRANSPO IVR510

1260BX00 / MIA8501

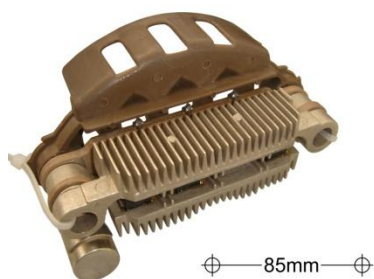

FEATURES

Diodes: 6-30Ampere
Mounting Length: 85mm
With Trio

Original & X-References..

For use on: Ford Tempo, Taurus,
Mercury Topaz, Sable

MITSUBISHI A 860 T 28670
WAI 31-8318
CARGO 134297
MOBILETRON RM-29
TRANSPO IMR8540

1260BY00 / MIA8502

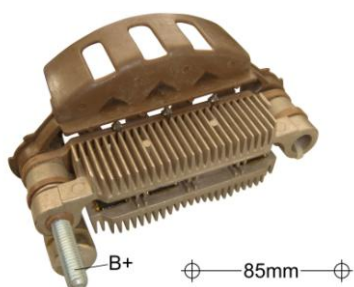

FEATURES

Diodes: 6-30Ampere
Mounting Length: 85mm
With M6x49.5mm Battery Post
With Trio
For use on: Ford Thunderbird

Original & X-References..

1260C900 / MIA8512

Diodes: 8-30 Ampere

MITSUBISHI 1901-0013
TRANSPO IMR85104

1260BZ00 / MIA8503

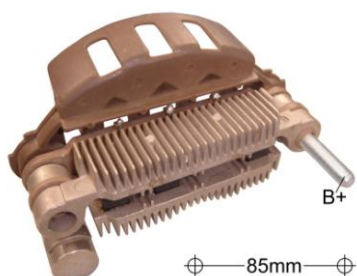

FEATURES

Diodes: 6-30 Ampere
Mounting Length: 85mm
With M6x49.5mm Battery Post
With Trio
For use on: Mazda MPV

Original & X-References..

1260C800 / MIA8511

Diodes: 8-30 Ampere

MITSUBISHI A 860 T 31370 A 860 T 34070
MOBILETRON RM-31
CARGO 135041
TRANSPO IMR8544 IMR8546

TRANSPO IMR8574

1260C100 / MIA8505

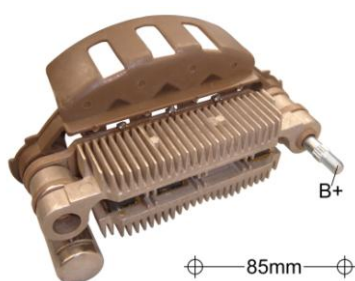

FEATURES

Diodes: 6-30 Ampere
 Mounting Length: 85mm
 With M5×44mm Battery Post
 With Trio
 For use on: Ford Escort, Mazda 323

Original & X-References..

MITSUBISHI	A 860 T 38270
	B36618W60A
WAI	31-8380
CARGO	136977
MOBILETRON	RM-38
TRANSPO	IMR8548

1260C300 / MIA8506

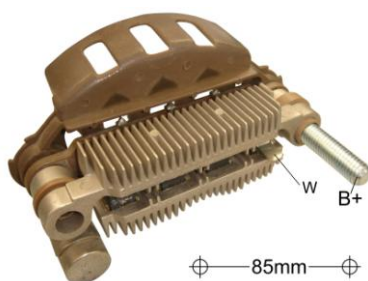

FEATURES

Diodes: 8-30 Ampere
 Mounting Length: 85mm
 With M8×54mm Battery Post
 With Trio

Original & X-References..

1260C400 / MIA8507

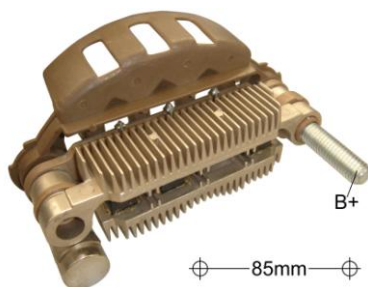

FEATURES

Diodes: 6-30 Ampere
 Mounting Length: 85mm
 With M8×54mm Battery Post
 With Trio
 For use on: Mazda 626, MX6

Original & X-References..

MITSUBISHI	A860T32170
MOBILETRON	RM-37
WAI	31-8350
CARGO	137861
TRANSPO	IMR8580

1260C500 / MIA8508

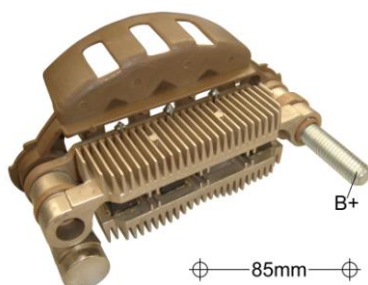

FEATURES

Diodes: 8-30 Ampere
 Mounting Length: 85mm
 With M8×54mm Battery Post
 With Trio
 For use on: Mazda 626, MX6

Original & X-References..

MITSUBISHI	1901-0006
MOBILETRON	RM-57
CARGO	232628
TRANSPO	IMR8582

1260C600 / MIA8509

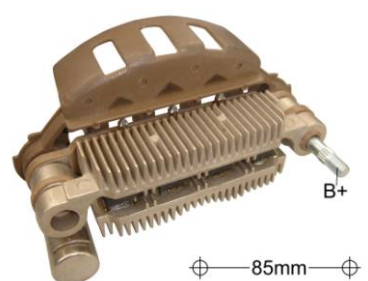

FEATURES

Diodes: 6-30 Ampere
 Mounting Length: 85mm
 With M5×44mm Battery Post
 Without Trio
 For use on: Subaru XT

Original & X-References..

RENARD	11399	19710
WAI	31-8388	
CARGO	135249	
MOBILETRON	RM-33	
TRANSPO	IMR8572	

1260C700 / MIA8510

Diodes: 8-30 Ampere
 With Trio

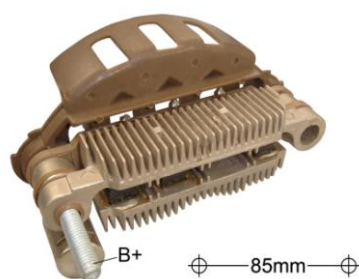
**1260CA00 / MIA8513****FEATURES**

Diodes: 6-30 Ampere
 Mounting Length: 85mm
 With M6×49.5mm Battery Post
 With Trio

Original & X-References..

MITSUBISHI A2T14591
 A2T28792

For use on: Subaru XT

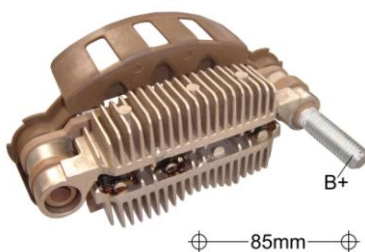
**1260CB00 / MIA8514****FEATURES**

Diodes: 6-30 Ampere
 Mounting Length: 85mm
 With M8×54mm Battery Post
 Without Capacitor
 Without Trio

Original & X-References..

MITSUBISHI A860T57870
 MOBILETRON RM-110HV
 WAI 31-8382
 CARGO 138873
 LESTER 13718
 TRANSPO IMR8566

For use on: Mazda Protege

1260CR00 / MIA8530

Diodes: 8-30 Ampere

TRANSPO IMR85668

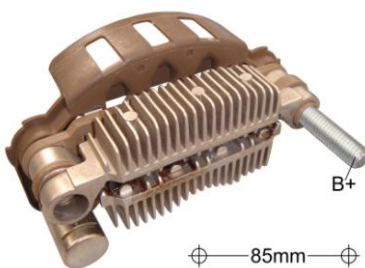
**1260CC00 / MIA8515****FEATURES**

Diodes: 6-30 Ampere
 Mounting Length: 85mm
 With M8×54mm Battery Post
 With Trio

Original & X-References..

MITSUBISHI A2TA08912C
 CARGO 230643
 TRANSPO IMR8588

For use on: Mitsubishi Eclipse, Eagle Talon

1260CE00 / MIA8517

Diodes: 8-30 Ampere

MITSUBISHI A860T42670
 MOBILETRON RM-59
 CARGO 137849
 TRANSPO IMR8594

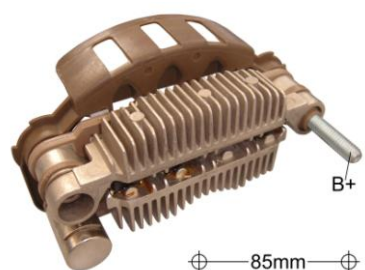
**1260CD00 / MIA8516****FEATURES**

Diodes: 6-30 Ampere
 Mounting Length: 85mm
 With M6×49.5mm Battery Post
 With Trio

Original & X-References..

MITSUBISHI A 860 T 38770
 MD618568
 WAI 31-8367
 CARGO 136979
 MOBILETRON RM-36 RM-57
 TRANSPO IMR8590
 IM832

For use on: Chrysler Imports, Mitsubishi

1260D800 / MIA8547

Diodes: 8-30 Ampere

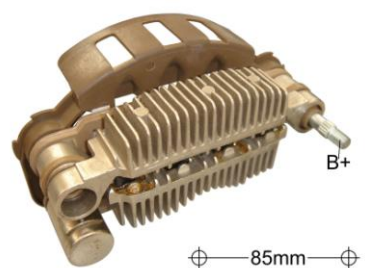
**1260CF00 / MIA8518****FEATURES**

Diodes: 8-30 Ampere
 Mounting Length: 85mm
 With M5×44mm Battery Post
 With Trio

Original & X-References..

MITSUBISHI A860T38970
 WAI 31-8381
 CARGO 135948
 MOBILETRON RM-58
 TRANSPO IMR85100

For use on: Mazda 626

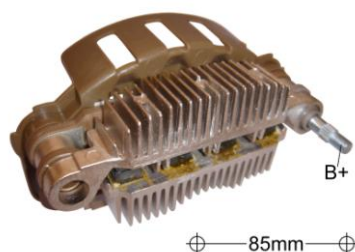
1260CG00 / MIA8519**FEATURES**

Diodes: 8-30 Ampere
 Mounting Length: 85mm
 With M5×44mm Battery Post
 Without Capacitor
 Without Trio

Original & X-References..

LESTER 13889
 TRANSPO IMR8599

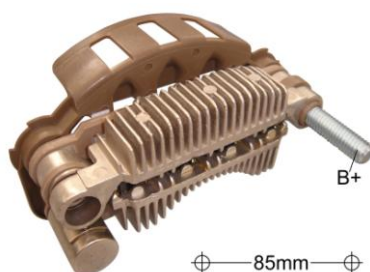
1260CJ00 / MIA8521**FEATURES**

Diodes: 8-30 Ampere
 Mounting Length: 85mm
 With M8×54mm Battery Post
 With Trio

Original & X-References..

MITSUBISHI A860T42670
 CARGO 137076
 TRANSPO IMR8594

1260CM00 / MIA8525

Diodes: 6-30 Ampere

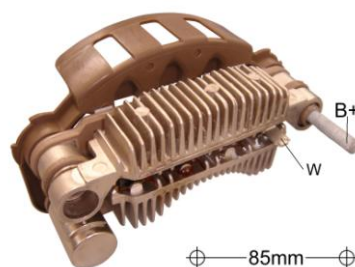
1260CN00 / MIA8526**FEATURES**

Diodes: 6-30 Ampere
 Mounting Length: 85mm
 With M5×49mm Battery Post
 With "W" Terminal
 With Trio
 With Capacitor

Original & X-References..

CARGO 136552

1260CI00 / MIA8520

Without "W" Terminal

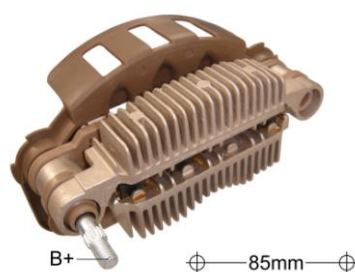
1260EA00 / MIA8527**FEATURES**

Diodes: 6-30 Ampere
 Mounting Length: 85mm
 With M5×44mm Battery Post
 Without Trio/Capacitor

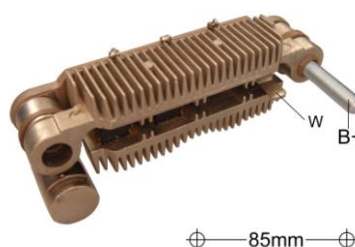
Original & X-References..**1260CP00 / MIA8528****FEATURES**

Diodes: 6-30 Ampere
 Mounting Length: 85mm
 With M6×49.5mm Battery Post
 With "W" Terminal
 With Trio

Original & X-References..

1260CQ00 / MIA8529

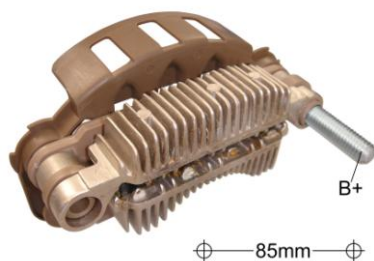

FEATURES

Diodes: 6-30 Ampere
 Mounting Length: 85mm
 With M8×54mm Battery Post
 With Trio
 Without Capacitor

Original & X-References..

1260CS00 / MIA8531

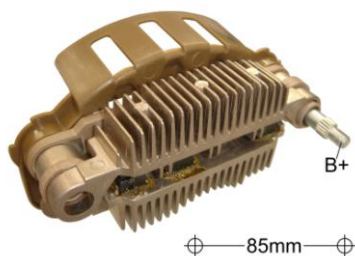

FEATURES

Diodes: 6-30 Ampere
 Mounting Length: 85mm
 With M5×44mm Battery Post
 Without Trio/Capacitor

Original & X-References..

MITSUBISHI	A860X61970
MOBILETRON	RM-130
TRANSPO	IMR8567

1260CT00 / MIA8532

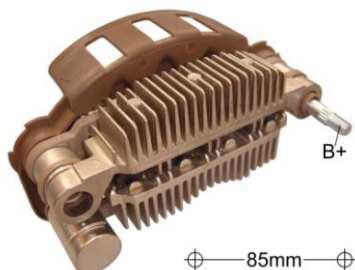

FEATURES

Diodes: 6-35 A Avalanche
 Mounting Length: 85mm
 With M5×44mm Battery Post
 Without Trio

Original & X-References..

1260CU00 / MIA8533

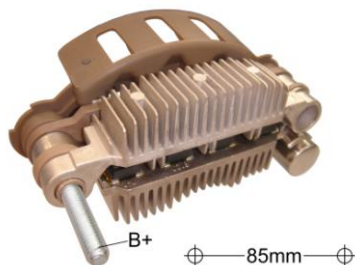

FEATURES

Diodes: 8-30 Ampere
 Mounting Length: 85mm
 With M6×49.5mm Battery Post
 Without Trio
 For use on: Avenger,
 Cirrus, Neon, Sebring

Original & X-References..

MITSUBISHI		
	A2T81192	A2T3791
	A2TA749	A2T7491
WAI		31-8374
TRANSPO		IMR8597

1260CY00 / MIA8537

Diodes: 6-30 Ampere
 With M6×60mm Battery Post

TRANSPO	IMR8596
---------	---------

1260CV00 / MIA8534

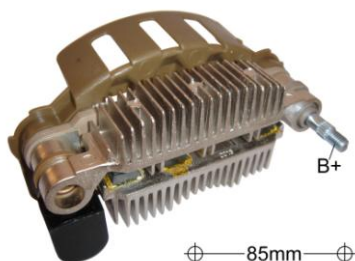

FEATURES

Diodes: 6-30 Ampere
 Mounting Length: 85mm
 With M5×44mm Battery Post
 With Trio
 For use on: Ford, Mazda

Original & X-References..

MITSUBISHI	A860T39170
WAI	31-8351
MOBILETRON	RM-39
CARGO	136978
TRANSPO	IMR8592

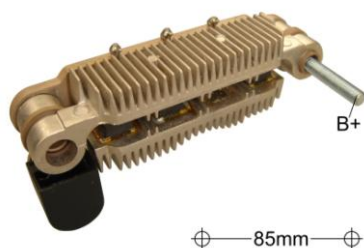
1260CW00 / MIA8535**FEATURES**

Diodes: 6-30 Ampere
 Mounting Length: 85mm
 With M5×49mm Battery Post
 With Trio

Original & X-References..

MITSUBISHI A860T29370
 TRANSPO IMR8578

For use on: Mitsubishi

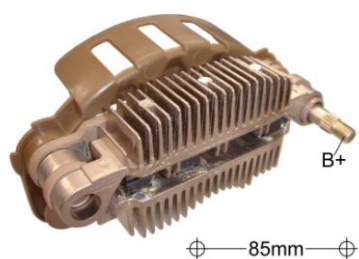
1260CX00 / MIA8536**FEATURES**

Diodes: 6-30 Ampere
 Mounting Length: 85mm
 With M6×43.5mm Battery Post
 Without Trio/Capacitor

Original & X-References..

MITSUBISHI A2TB2991
 MOBILETRON RM-135
 TRANSPO IMR8595

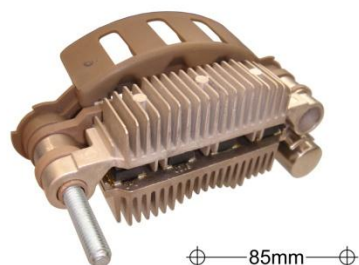
1260CZ00 / MIA8538**FEATURES**

Diodes: 8-30 Ampere
 Mounting Length: 85mm
 With M6×49.5mm Battery Post
 With Trio

Original & X-References..

TRANSPO IMR8598

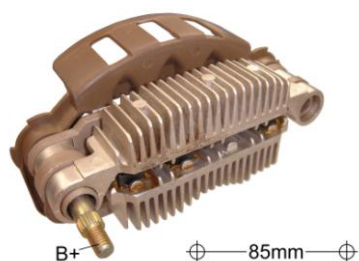
1260D000 / MIA8539**FEATURES**

Diodes: 6-30 Ampere
 Mounting Length: 85mm
 With M5×44mm Battery Post
 Without Trio
 Without Capacitor

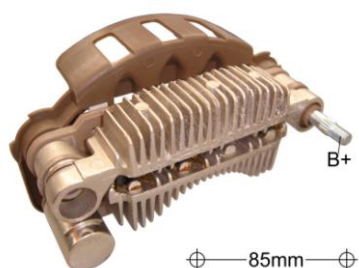
Original & X-References..**1260D100 / MIA8540****FEATURES**

Diodes: 6-30 Ampere
 Mounting Length: 85mm
 With M5×44mm Battery Post
 With Trio

Original & X-References..

1260D200 / MIA8541

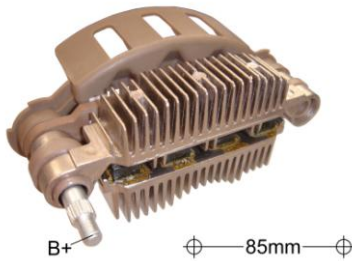

FEATURES

Diodes: 8-30A Avalanche
 Mounting Length: 85mm
 With M5×44mm Battery Post
 Without Trio
 Without Capacitor

Original & X-References..

1260D300 / MIA8542

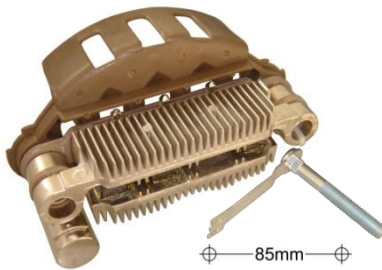

FEATURES

Diodes: 6-30 Ampere
 Mounting Length: 85mm
 With M6×47.5mm Battery Post
 With Trio
 With Capacitor

Original & X-References..

1260D500 / MIA8544

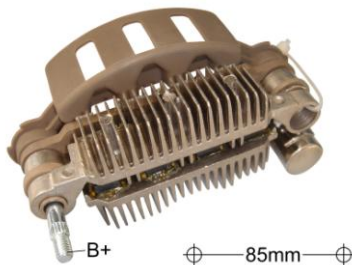

FEATURES

Diodes: 8-30Ampere
 Mounting Length: 85mm
 With M5×44mm Battery Post
 With Trio
 With Capacitor

Original & X-References..

1260D600 / MIA8545

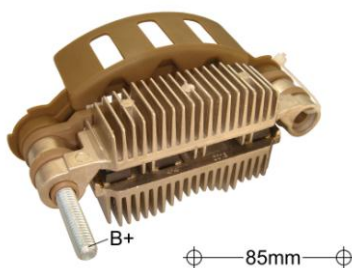

FEATURES

Diodes: 6-30Ampere
 Mounting Length: 85mm
 With M6×49.5mm Battery Post
 With Trio

Original & X-References..

LESTER 13735

1260D700 / MIA8546

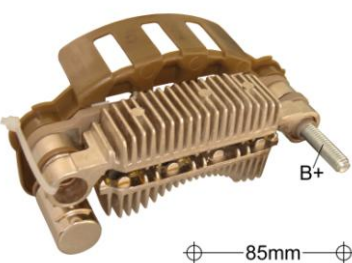

FEATURES

Diodes: 6-30Ampere
 Mounting Length: 85mm
 With M6×49.5mm Battery Post
 With Trio

Original & X-References..

MITSUBISHI A002TN0399
 LESTER 111872

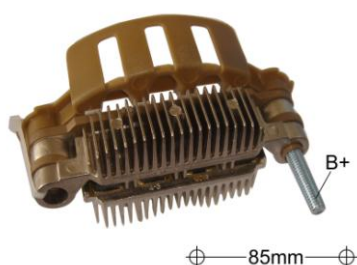

1260DA00 / MIA8549

FEATURES

Diodes : 8-30A Ampere
 Mounting Length :85mm
 With M6×49.5mm Battery Post
 Without Trio
 Without Capacitor

Original & X-References..

HONDA	31127-PGM-004
MOBILETRON	RM-154HV
TRANSPO	IMR8585

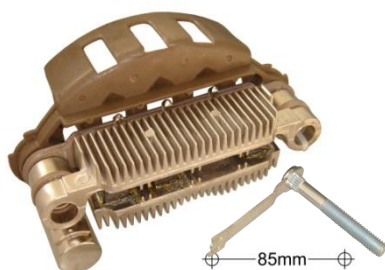

1260DC00 / MIA8551

FEATURES

Diodes : 8-30A Ampere
 Mounting Length :85mm
 With M6×47.5mm Battery Post
 With Trio
 With Capacitor

Original & X-References..

MITSUBISHI	ME701716
CARGO	139111

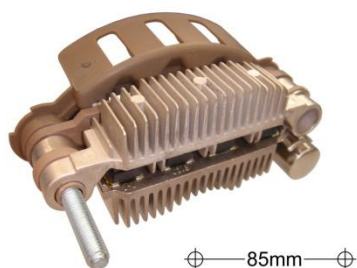

1260DJ00 / MIA8552

FEATURES

Diodes : 8-30A Ampere
 Mounting Length :85mm
 With M6×60mm Battery Post
 Without Trio
 With Capacitor

Original & X-References..

WAGNER	W065-168
CHRYLER	4609101
LESTER	13575
TRANSPO	IMR8597

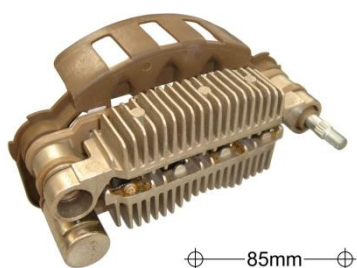

1260DE00 / MIA8553

FEATURES

Diodes:6-30A Ampere
 Mounting Length : 85mm
 With M5×44mm Battery Post
 With Trio
 With Capacitor

Original & X-References..

MITSUBISHI	A860T06870
MOBILETRON	RM-94
CARGO	137860
TRANSPO	IMR85106

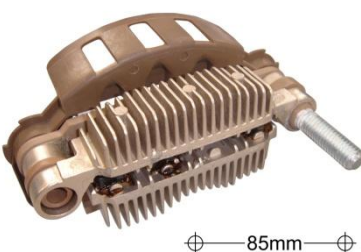

1260DF00 / MIA8554

FEATURES

Diodes:6-30A Avalanche
 Mounting Length : 85mm
 With M8×54mm Battery Post
 Without Capacitor
 Without Trio

Original & X-References..

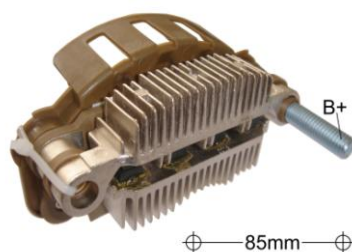
1260DG00 / MIA8555**FEATURES**

Diodes:8-30A Avalanche
 Mounting Length : 85mm
 With M8×54mm Battery Post
 Without Capacitor
 Without Trio

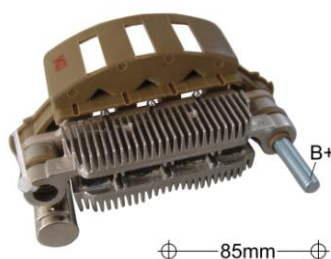
Original & X-References..**1260DH00 / MIA8556****FEATURES**

Diodes :8-30 Ampere
 Mounting Length : 85mm
 With M6×49.5mm Battery Post
 With Trio
 With Capacitor

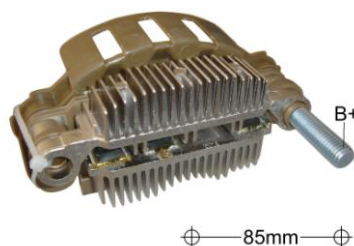
Original & X-References..**1260DL00 / MIA8558****FEATURES**

Diodes:6-30 Ampere
 Mounting Length : 85mm
 With M8×54mm Battery Post
 With Trio

Original & X-References..

MITSUBISHI	A002TA8891
CARGO	GA1340

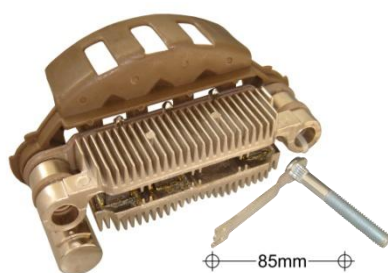
1260DK00 / MIA8559**FEATURES**

Diodes:6-30A Ampere
 Mounting Length : 85mm
 With M8×49mm Battery Post
 With Trio
 With Capacitor

Original & X-References..

MITSUBISHI	ME202971
------------	----------

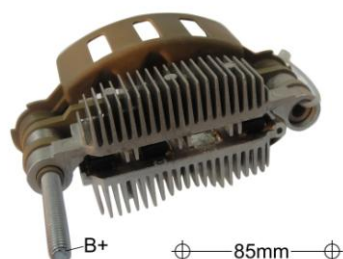
1260DP00 / MIA8564**FEATURES**

Diodes:6-30A Ampere
 Mounting Length: 85mm
 With M6×60mm Battery Post
 Without Trio
 Without Capacitor

Original & X-References..

LESTER	13735
WAI	31-8384
TRANSPO	IMR8568

1260D410 / MIA8565

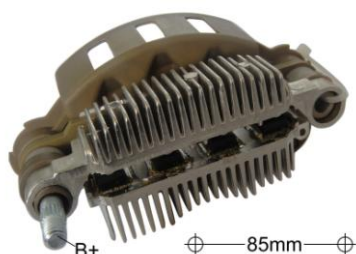

FEATURES

Diodes: 8-30A Ampere
 Mounting Length: 85mm
 With M6×43.5mm Battery Post
 Without Trio
 Without Capacitor

Original & X-References..

MITSUBISHI	A860X45170
CARGO	139197
TRANSPO	IMR8575

1260DQ00 / MIA8567



FEATURES

Diodes: 6-30 Ampere
 Mounting Length: 85mm
 With M6×49.5mm Battery Post
 With Trio/Capacitor

Original & X-References..

1260DR00 / MIA8568

With M5×44mm Battery Post

1260DS00 / MIA8569



FEATURES

Diodes : 8-30 A Ampere
 Mounting Length: 85mm
 With M6×49.5mm Battery Post
 With Trio/Capacitor

Original & X-References..

MITSUBISHI	A4TU3599
LESTER	20111

1260E100 / MIA8570A

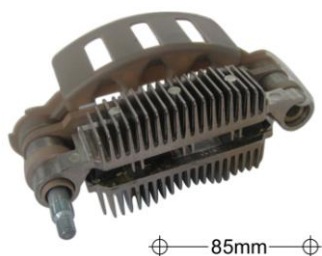

FEATURES

Diodes : 6-30 A Avalanche
 Mounting Length: 85mm
 With M5×44mm Battery Post

Original & X-References..

MITSUBISHI	A2TG1081ZT
NISSAN	23100-2NAOA-1
MOBILETRON	RM-161HV

1260DZ00 / MIA8571

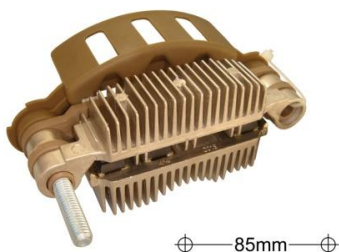

FEATURES

Diodes: 6-30Ampere
 Mounting Length: 85mm
 With M6×60mm Battery Post

Original & X-References..

LESTER	13735
WAI	31-8384
TRANSPO	IMR8568

For use on: (2001-98) Dodge, Plymouth

1260DV00 / MIA8572



FEATURES

Diodes: 8-30A Ampere
 Diameter: 85mm
 With M6×49.5mm Battery Post
 With "W" Terminal
 With Trio/Capacitor

Original & X-References..

DIESEL	A4TU5486
LESTER	12744

1260DW00 / MIA8574

With M5×44mm Battery Post

1260DX00 / MIA8575



FEATURES

Diodes: 8-30 Ampere
 Mounting Length: 85mm
 With M8×59.5mm Battery Post
 With "W" Terminal
 With Trio/Capacitor

Original & X-References..

1260E600 / MIA8581A



FEATURES

Diodes OD: 6-40A Avalanche
 Diameter: 85mm
 With M8×54mm Battery Post
 Without Trio/Capacitor

Original & X-References..

LESTER	11413
TRANSPO	IMR8589

1260E400 / MIA9001

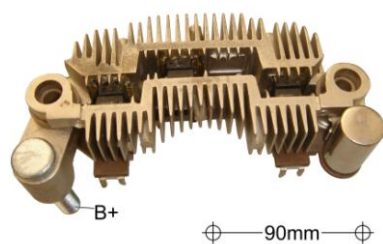

FEATURES

Diodes: 6-30 A Avalanche
 Mounting Length: 90mm
 With M8×45.6mm Battery Post
 With Trio

Original & X-References..

MOBILETRON	RM-132
TRANSPO	IYR9028

1260E500 / MIA9002

Diodes: 8-30A Avalanche

VALEO	TA000A48401
	TA000A48402

1260E520 / MIA9008

Diodes: 8-30A Ampere

MOBILETRON	RM-151
TRANSPO	IYR9003

12600900 / MIA10001

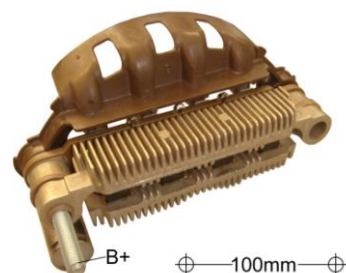

FEATURES

Diodes: 8-30 Ampere
 Mounting Length: 100mm
 With M6×49.5mm Battery Post
 With Trio
 For use on: Ford Thunderbird, Mercury Cougar, Hyundai Alliance

Original & X-References..

MITSUBISHI	A860T35270
FORD	E9PZ10304B
MOBILETRON	RM-41
WAI	31-8329
CARGO	135252
TRANSPO	IMR10040

12601000 / MIA10002

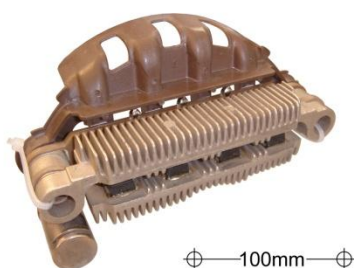

FEATURES

Diodes: 8-30 Ampere
 Mounting Length: 100mm
 With Trio
 For use on: Mitsubishi Van & Wagon,
 Dodge Eagle, Chrysler Imports

Original & X-References..

MITSUBISHI	
A 860 T 23070	A 860 T 28070
MD602227	MD611564
MOBILETRON	RM-40
WAI	31-8325
CARGO	132793
TRANSP0	IMR10042

12601100 / MIA10003

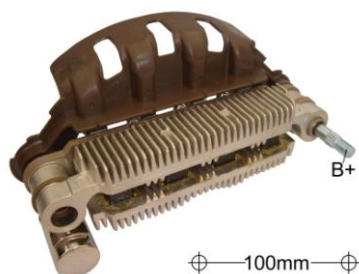

FEATURES

Diodes: 8-30 Ampere
 Mounting Length: 100mm
 With M5×44mm Battery Post
 With Trio

Original & X-References..

MITSUBISHI	A 860 T 30170
MOBILETRON	RM-42
WAI	31-8338
CARGO	135229
TRANSP0	IMR10044

For use on: Subaru XT

12601200 / MIA10004

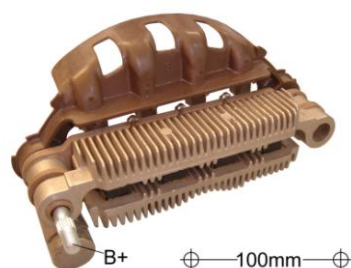

FEATURES

Diodes: 8-30 Ampere
 Mounting Length: 100mm
 With M5×44mm Battery Post
 With Trio
 With Capacitor

Original & X-References..

12607600 / MIA10075

With M6×49.5mm Battery Post

12601300 / MIA10005

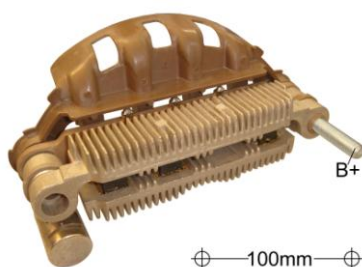

FEATURES

Diodes: 6-30 Ampere
 Mounting Length: 100mm
 With M6×49.5mm Battery Post
 With Trio/Capacitor

Original & X-References..

MITSUBISHI	A 860 T 36070
CARGO	139269
TRANSP0	IMR10048

For use on: Mitsubishi 3000GT,
 Diamante

12601400 / MIA10006

Diodes: 8-30Ampere

MITSUBISHI	A860T23370
MOBILETRON	RM-43
CARGO	137846
TRANSP0	IMR10050

12601500 / MIA10007

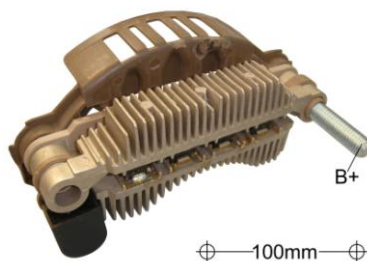

FEATURES

Diodes: 8-30 Ampere
 Mounting Length: 100mm
 With M8×54mm Battery Post
 With Trio/Capacitor
 For use on: Ford Taurus SHO

Original & X-References..

MITSUBISHI	A 860 T 33970
MOBILETRON	RM-48
WAI	31-8358
CARGO	135900
TRANSP0	IMR10060

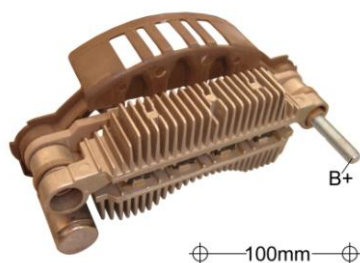
12601600 / MIA10008**FEATURES**

Diodes: 8-30Ampere
 Mounting Length: 100mm
 With M6×49.5mm Battery Post
 With Trio/Capacitor

For use on: Ford Taurus SHO

12604300 / MIA10038

Diodes: 6-30Ampere

Original & X-References..

MITSUBISHI	A 860 T 42070
MOBILETRON	RM-47
WAI	31-8357
TRANSP0	IMR10062

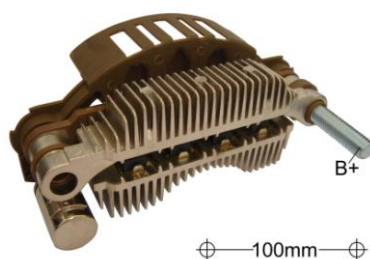
12601700 / MIA10009**FEATURES**

Diodes: 8-30 Ampere
 Mounting Length: 100mm
 With M8×54mm Battery Post
 With Trio/Capacitor
 For use on: Mazda 929

12602000 / MIA10012

Diodes: 6-30Ampere

Original & X-References..

MITSUBISHI	A 860 T 36770
	JE4818W60B
MOBILETRON	RM-45
WAI	31-8355
CARGO	135901
TRANSP0	IMR10066

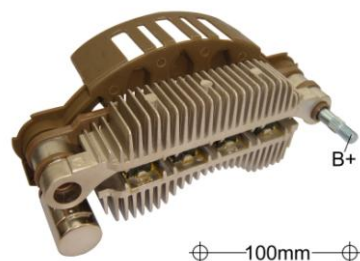
12601800 / MIA10010**FEATURES**

Diodes: 8-30Ampere
 Mounting Length: 100mm
 With M5×44mm Battery Post
 With Trio
 For use on: Mazda RX7 Turbo

Original & X-References..

MITSUBISHI	A860T40270
MOBILETRON	RM-46
WAI	31-8366
CARGO	135882
TRANSP0	IMR10068

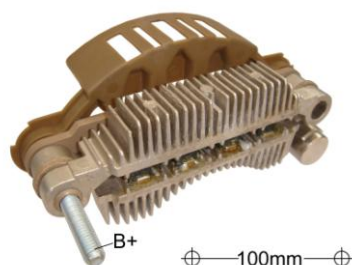
12601900 / MIA10011**FEATURES**

Diodes: 8-30 Ampere
 Mounting Length: 100mm
 With M6×49.5mm Battery Post
 With Trio/Capacitor

Original & X-References..

MITSUBISHI	A 3T14292
MOBILETRON	RM-125HV
WAI	31-8373
TRANSP0	IMR10088

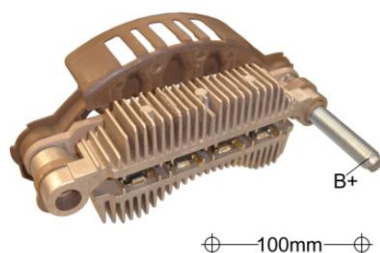
12602100 / MIA10013**FEATURES**

Diodes: 8-30 Ampere
 Mounting Length: 100mm
 With M8×59.5mm Battery Post
 With Trio
 Without Capacitor

Original & X-References..

FORD	98VB10K359BB
MITSUBISHI	A3TN1791
	A860X42970
MOBILETRON	RM-99HV
CARGO	231079
TRANSP0	IMR10057
	IM757

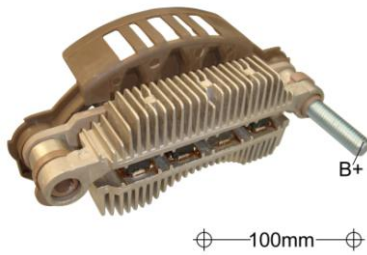

12602200 / MIA10014

FEATURES

Diodes: 6-30 Ampere
 Mounting Length: 100mm
 With M8×54mm Battery Post
 With Trio
 Without Capacitor

Original & X-References..

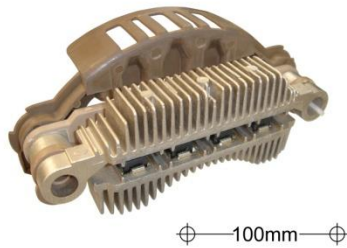

12602300 / MIA10015

FEATURES

Diodes: 8-30 Ampere
 Mounting Length: 100mm
 With Trio
 Without Capacitor
 For use on: Ford Transit

Original & X-References..

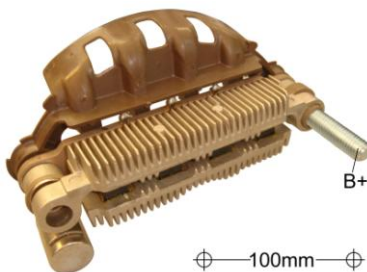

12602500 / MIA10017

FEATURES

Diodes: 8-30 Ampere
 Mounting Length: 100mm
 With M8×54mm Battery Post
 With Trio

Original & X-References..

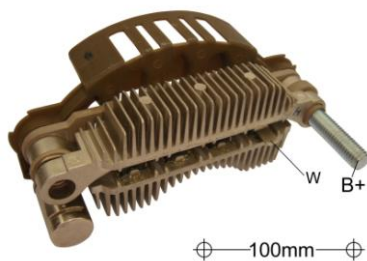

12602600 / MIA10018

FEATURES

Diodes: 8-30 Ampere
 Mounting Length: 100mm
 With M8×54mm Battery Post
 With "W" Terminal
 With Trio

Original & X-References..

MITSUBISHI A3TN6188ZJ

12602900 / MIA10021

Diodes: 6-30Ampere

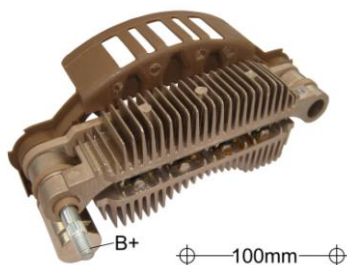

12602800 / MIA10020

FEATURES

Diodes: 8-30 Ampere
 Mounting Length: 100mm
 With M5×44mm Battery Post
 With Trio
 Without Capacitor
 For use on: Ford Ambulance and
 Emergency

Original & X-References..

CARGO 234310
 TRANSPO IMR10052

12603500 / MIA10030

With Capacitor

12603100 / MIA10023

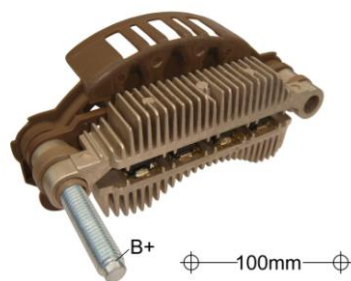

FEATURES

Diodes: 8-30 Ampere
 Mounting Length: 100mm
 With M8×59.5mm Battery Post
 With M5×35mm Mounting Bolt
 With Trio
 Without Capacitor

Original & X-References..

12603200 / MIA10025

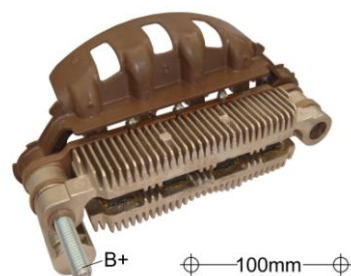

FEATURES

Diodes: 8-30 Ampere
 Mounting Length: 100mm
 With M6×49.5mm Battery Post
 With Trio/ Capacitor

Original & X-References..

12603300 / MIA10028

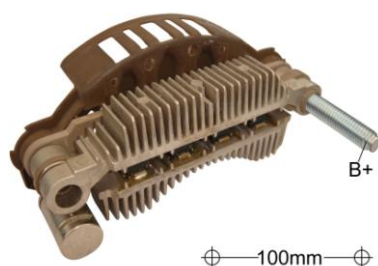

FEATURES

Diodes: 8-30Ampere
 Mounting Length: 100mm
 With M8×59.5mm Battery Post
 With Trio/Capacitor

Original & X-References..

MITSUBISHI	A3TA3791
	A3T12792

12603400 / MIA10029

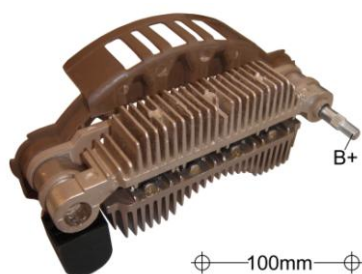

FEATURES

Diodes: 8-30 Ampere
 Mounting Length: 100mm
 With M5×44mm Battery Post
 With Trio
 For use on: Ford Probe, Mazda626,
 Mazda MX6

Original & X-References..

FORD	F32Z10346B
MITSUBISHI	A860T38670
	A860T40270
WAI	31-8356
CARGO	135882
TRANSPO	IMR10064

12603600 / MIA10031

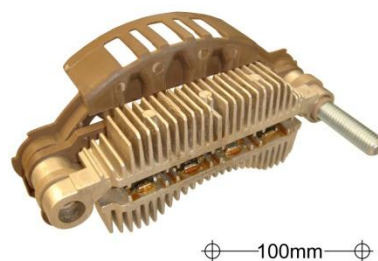

FEATURES

Diodes: 8-35Ampere
 Mounting Length: 100mm
 With M8×54mm Battery Post
 With Trio
 Without Capacitor

Original & X-References..

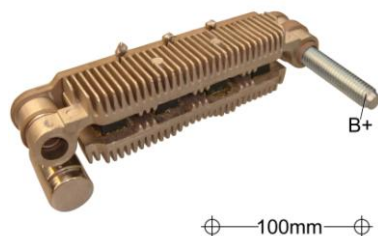
12603700 / MIA10032**FEATURES**

Diodes: 8-30Ampere
 Mounting Length: 100mm
 With M8×59.5mm Battery Post
 With Trio/Capacitor

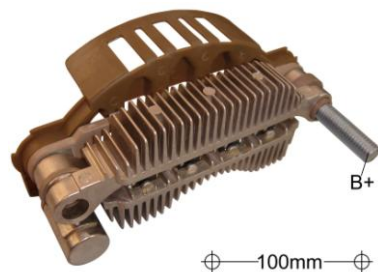
Original & X-References..**12603800 / MIA10033****FEATURES**

Diodes: 8-35 A Avalanche
 Mounting Length: 100mm
 With M8×54mm Battery Post
 Without Trio
 With Capacitor

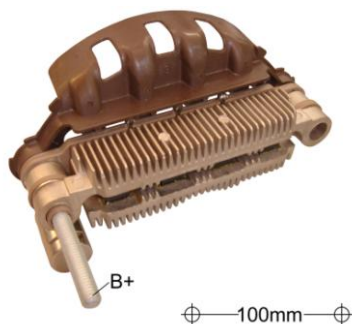
Original & X-References..**12603900 / MIA10034****FEATURES**

Diodes: 8-30Ampere
 Mounting Length: 100mm
 With M6×60mm Battery Post
 With Trio/ Capacitor

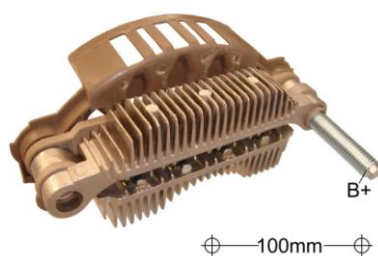
Original & X-References..**12604000 / MIA10035****FEATURES**

Diodes: 8-35 A Avalanche
 Mounting Length: 100mm
 With M8×59.5mm Battery Post
 Without Trio/ Capacitor
 For use on: 1999-2001Mercury Villager
 Van3.3L(125A)

Original & X-References..

MITSUBISHI	A860X64570
NISSAN	23124-4P116
LESTER	11051
CARGO	230884
TRANSPO	IMR10046

12604100 / MIA10036

Diodes:8-30 A Avalanche

MITSUBISHI	A860X58170
MOBILETRON	RM-134
TRANSPO	IMR10058

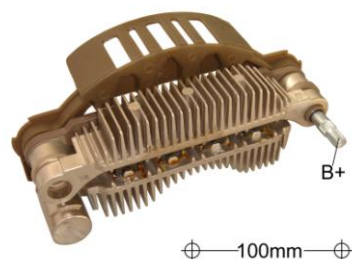
12604200 / MIA10037**FEATURES**

Diodes: 8-30Ampere
 Mounting Length: 100mm
 With M5×44mm Battery Post
 With Trio
 With Capacitor

Original & X-References..

MITSUBISHI	A860T41370
TRANSPO	IMR10070

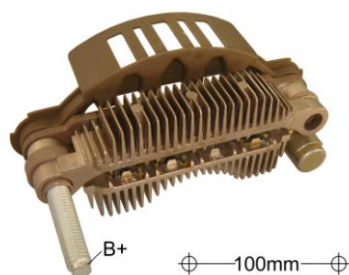
**12604400 / MIA10039****FEATURES**

Diodes: 6-30Ampere
 Mounting Length: 100mm
 With M8×59.5mm Battery Post
 With Trio
 With Capacitor

Original & X-References..

MITSUBISHI	A860X47070
MOBILETRON	RM-116
CARGO	139111

12605400 / MIA10049

Diodes: 8-30Ampere

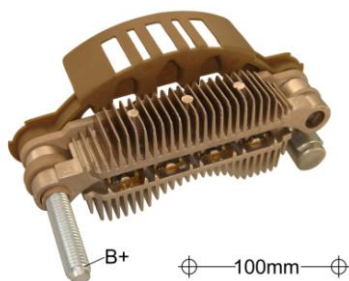
**12604600 / MIA10041****FEATURES**

Diodes: 8-30Ampere
 Mounting Length: 100mm
 With M8×59.5mm Battery Post
 With Trio
 With Capacitor

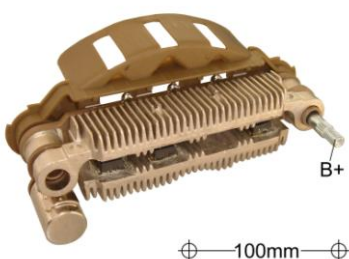
Original & X-References..**12604700 / MIA10042****FEATURES**

Diodes: 6-30Ampere
 Mounting Length: 100mm
 With M5×44mm Battery Post
 With Trio
 With Capacitor

Original & X-References..

MITSUBISHI	A860T29770
CARGO	236816

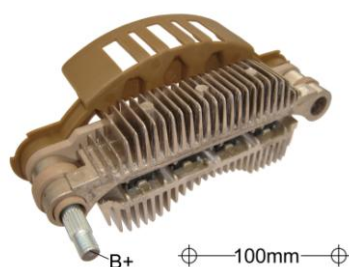
12604800 / MIA10043**FEATURES**

Diodes: 8-30Ampere
 Mounting Length: 100mm
 With M6×44.5mm Battery Post
 Without Trio
 Without Capacitor

Original & X-References..

MITSUBISHI	A860X79470
MOBILETRON	RM-127
TRANSPO	IMR10081

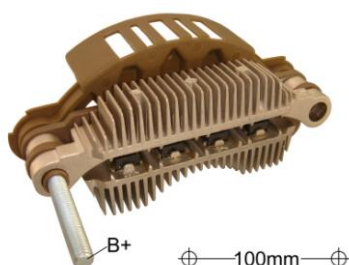
12604900 / MIA10044**FEATURES**

Diodes: 8-30Ampere
 Mounting Length: 100mm
 With M6×60mm Battery Post
 Without Trio/Capacitor

Original & X-References..

MOBILETRON	RM-131HV
TRANSPO	IMR10090

12605000 / MIA10045

Diodes: 8-30Ampere
 With Capacitor

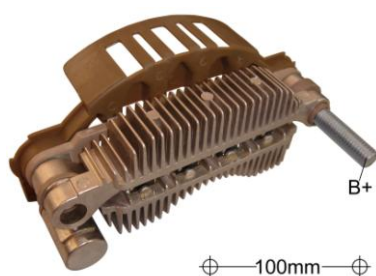
**12605100 / MIA10046****FEATURES**

Diodes: 8-30 A Avalanche
 Mounting Length: 100mm
 With M8×9.5mm Battery Post
 Without Trio
 With Capacitor

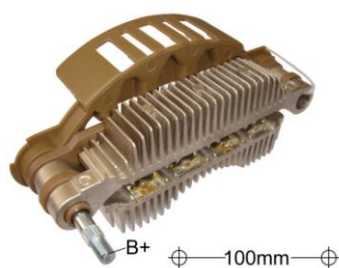
Original & X-References..**12605300 / MIA10048****FEATURES**

Diodes: 8-30 Ampere
 Mounting Length: 100mm
 With M5×44mm Battery Post
 Without Trio/Capacitor

Original & X-References..

MITSUBISHI A3TG0091
 A3TG0081

12605500 / MIA10050**FEATURES**

Diodes : 8-30A Ampere
 Mounting Length : 100mm
 With M6×49.5mm Battery Post
 With Trio
 With Capacitor

Original & X-References..

MITSUBISHI A2T80378

12605900 / MIA10054

With M6×60mm Battery Post

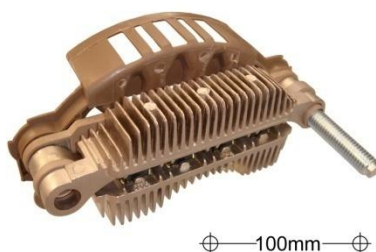
12605600 / MIA10051**FEATURES**

Diodes :8-35A Avalanche
 Mounting Length : 100mm
 With M8×54m Battery Post
 Without Trio
 Without Capacitor

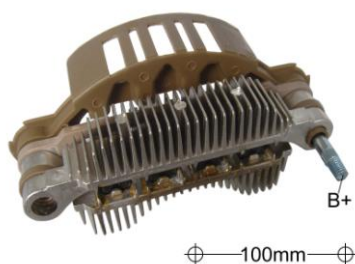
Original & X-References..**12605700 / MIA10052****FEATURES**

Diodes : 8-30 Ampere
 Mounting Length : 100mm
 With M5×44mm Battery Post
 Without Trio
 Without Capacitor

Original & X-References..

MITSUBISHI A860X66270
 MOBILETRON RM-195
 TRANSPON IMR10047

1260F400

Diodes : 8-40 A Avalanche

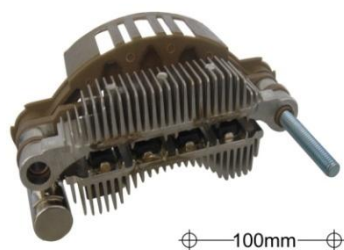
12605800 / MIA10053**FEATURES**

Diodes : 8-30A Ampere
 Mounting Length : 100mm
 With M6×60mm Battery Post
 With Trio
 With Capacitor

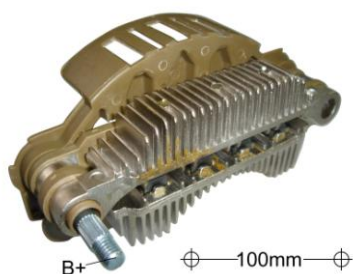
Original & X-References..**12606600 / MIA10062****FEATURES**

Diodes : 8-30A Ampere
 Mounting Length : 100mm
 With M6×44.5mm Battery Post
 Without Trio
 Without Capacitor

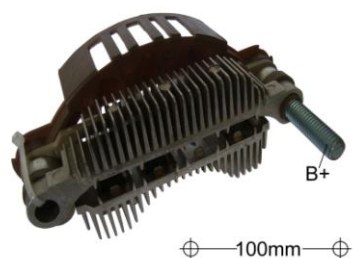
Original & X-References..**12606700 / MIA10063****FEATURES**

Diodes:6-30A Ampere
 Mounting Length : 100mm
 With M8×54mm Battery Post
 Without Trio
 Without Capacitor

Original & X-References..

MITSUBISHI	1901-0030
J&N	172-48104
OBILETRON	RM-139
TRANSP0	IMR10067

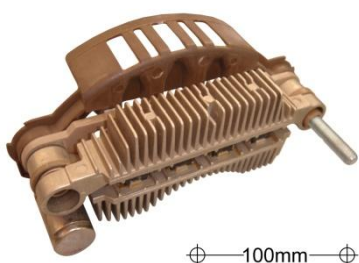
12606900 / MIA10065**FEATURES**

Diodes:8-30 Ampere
 Mounting Length : 100mm
 With M5×44mm Battery Post
 With Trio
 With Capacitor

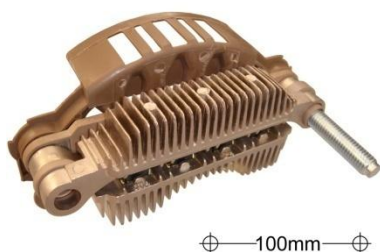
Original & X-References..**12607000 / MIA10067****FEATURES**

Diodes : 6-40A Avalanche
 Mounting Length : 100mm
 With M8×59.5mm Battery Post
 Without Trio
 Without Capacitor

Original & X-References..

MITSUBISHI	A3TG1991
TRANSP0	IMR10045
LESTER	11102

12607300 / MIA10071

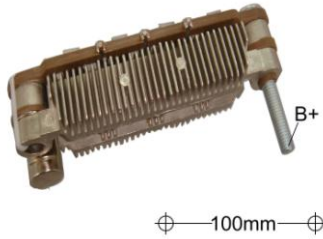

FEATURES

Diodes: 8-30 Ampere
 Mounting Length: 100mm
 With M8×54mm Battery Post
 With "W" Terminal
 With Trio
 With Capacitor

Original & X-References..

12607500 / MIA10074

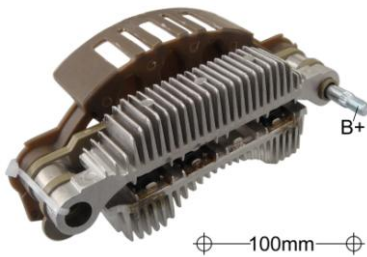

FEATURES

Diodes: 6-30 Ampere
 Diameter OD: 100mm
 With M5×44mm Battery Post
 Without Trio
 Without Capacitor

Original & X-References..

LESTER 11118

12607700 / MIA10076

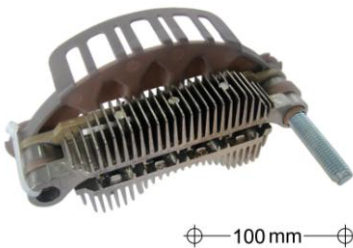

FEATURES

Diodes : 8-30 A Ampere
 Mounting Length: 100mm
 With M8×59.5mm Battery Post
 With Trio

Original & X-References..

MITSUBISHI A4TR5188

12607800 / MIA10078

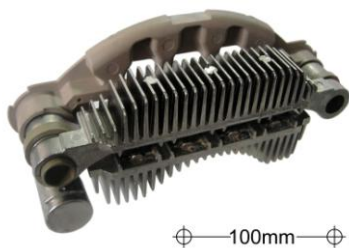

FEATURES

Diodes: 8-30 Ampere
 Mounting Length: 100mm
 With Trio/Capacitor

Original & X-References..

12608000 / MIA10080A



FEATURES

Diodes: 8-30 A Avalanche
 Diameter OD: 100mm
 With M8×50mm Battery Post
 With Trio/Capacitor

Original & X-References..

1260FA00

With M6×50mm Battery Post

12608100 / MIA10082

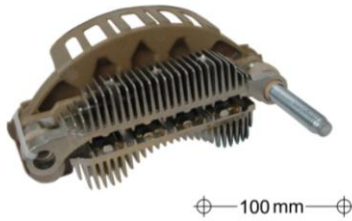

FEATURES

Diodes : 8-30 A Ampere
 Mounting Length: 100mm
 With M8×59.5mm Battery Post

Original & X-References..

MITSUBISHI A4TA8494
 A4TA0594
 A4TA0592

12600310 / MIA10083A



FEATURES

Diodes : 8-35 A Avalanche
 Mounting Length: 100mm
 With M8×59.5mm Battery Post
 With Trio

Original & X-References..

12608200 / MIA10084A

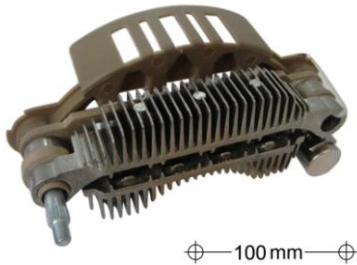

FEATURES

Diodes : 8-35 A Avalanche
 Mounting Length: 100mm
 With M5×44mm Battery Post
 With Trio/Capacitor

Original & X-References..

MITSUBISHI A3TB5099

12608400 / MIA10086

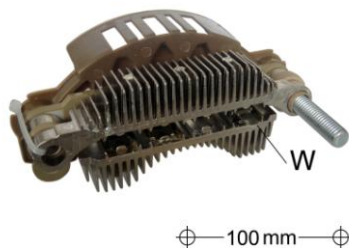

FEATURES

Diodes: 6-30A Ampere
 Diameter: 100mm
 With M8×59.5mm Battery Post
 With Trio
 Without Capacitor

Original & X-References..

12608500 / MIA10087

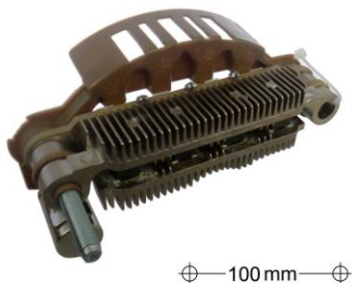

FEATURES

Diodes: 8-30A Ampere
 Diameter: 100mm
 With M6×49.5mm Battery Post
 With Trio/Capacitor

Original & X-References..

12608900 / MIA10092B

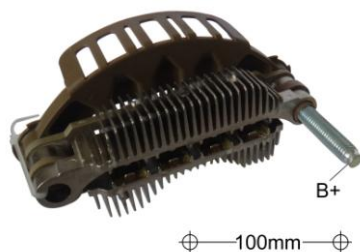

FEATURES

Diodes OD: 8-35A Avalanche
 Diameter: 100mm
 With M8×59.5mm Battery Post
 Without Trio/Capacitor

Original & X-References..

For 24V Alternators

12609100 / MIA10095

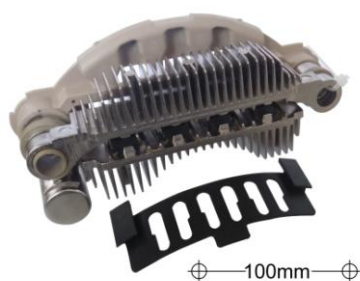

FEATURES

Diodes OD: 8-35A Ampere
 Diameter: 100mm
 With Trio/Capacitor

Original & X-References..

MANDO	AF111364
LESTER	22862
CARGO	112333

12620100 / MIA11401



FEATURES

Diodes: 12-35A Ampere
 Mounting Length: 122mm
 With M8×59.5mm Battery Post
 Without Trio
 Without Capacitor

Original & X-References..

MITSUBSHI	A002TJ0481
LESTER	11231

12620400 / MIA12101



FEATURES

Diodes : 12-35 A Ampere
 Diameter OD: 128mm
 With M5×44mm Battery Post

Original & X-References..

12620600 / MIA12102A



FEATURES

Diodes : 16-35 A Avalanche
 Diameter OD: 128mm
 With M8×59.5mm Battery Po

Original & X-References..

12620700 / MIA12103A**FEATURES**

Diodes : 16-35 A Avalanche
 Diameter OD: 128mm
 With M5×44mm Battery Post

Original & X-References..**12620800 / MIA12104A****FEATURES**

Diodes: 12-60A Ampere
 Mounting Length: 128mm
 With M6×28.5mm Battery Post
 Without Trio
 Without Capacitor

Original & X-References..

MITSUBSHI	A003TJ0891
A003TJ0991	A003TJ2191

12620900 / MIA12105A**FEATURES**

Diodes: 16-35A Avalanche
 Diameter OD: 128mm
 With M8×59.5mm Battery Post

Original & X-References..

MITSUBISHI	90679-A0436-9305H
LESTER	11315 11316
TRANSPO	IMR12806
MOBILEIRON	RM-192

12621100 / MIA12107A**FEATURES**

Diodes: 12-60 A Avalanche
 Diameter OD: 128mm
 With M6×28.5mm Battery Post

Original & X-References..

MITSUBISHI	A3TX0091
LESTER	11271

12621200 / MIA12801**FEATURES**

Diodes: 16-60 A Ampere
 Diameter OD: 135mm
 With M6×41mm Battery Post

Original & X-References..



12621300

FEATURES

Diodes: 12-35A Avalanche
 Diameter: 128mm
 With M8×59.5mm Battery Post

Original & X-References..

TRANSPO IMR12802



12610400 / MIP7001

FEATURES

Diodes: 4-30 Ampere Block
 Mounting Length: 70mm
 Stamped steel heat sink
 Fore use on: MITSUBISHI

Original & X-References..

IW700 2800
 HINO 27700-1700
 SAWAFUJI 1219-008-00XOSF
 NISSAN 23500-E9007

12610500 / MIP7002

Diodes: 6-30Ampere Block



12610700 / MIP7103F

FEATURES

Diodes: 6-35 Ampere Button
 Mounting Length: 71mm
 With Trio
 Without Capacitor
 For use on: Chrysler , Dodge ,Plymouth

Original & X-References..

MITSUBISHI
 3446828100 A001T02871
 A001T22771 A001T23283
 MOBILETRON MR-59
 WAI 31-8308
 CARGO 132087
 TRANSPO IMR7111

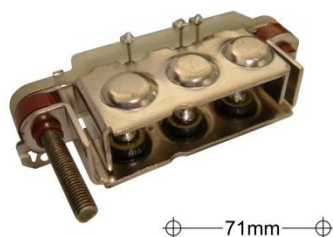

12610800 / MIP7104F

FEATURES

Diodes: 6-35 Ampere Button
 Mounting Length: 71mm
 With M5×43mm Battery Post
 With Trio
 Without Capacitor

Original & X-References..

MITSUBISHI A860T09470
 MOBILETRON RM-88
 WAI 31-8389
 CARGO 138974
 TRANSPO IMR7117

For use on: Nissan Pickup, Pulsar



12611000 / MIP7107F

FEATURES

Diodes: 6-35 Ampere
 Mounting Length: 71mm
 With M5×51mm Battery Post
 With Trio

Original & X-References..

12611700 / MIP8001L

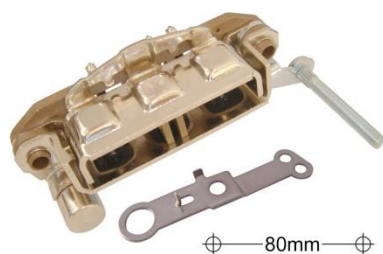

FEATURES

Diodes: 6-35 Ampere
 Mounting Length: 80mm
 With M5×43mm Battery Post
 With Trio
 With Aluminum Heat sinks
12611600 / MIP8001
 Diodes: 6-35Ampere
 With Copper Heat sinks

Original & X-References..

MITSUBISHI	A860T08270
MOBILETRON	RM-65
WAI	31-8313
CARGO	132130
TRANSPO	IMR8041

12612000 / MIP8002L

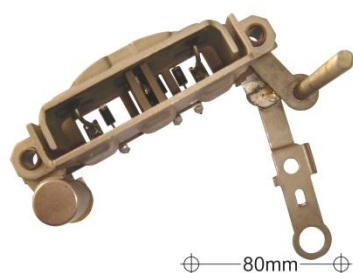

FEATURES

Diodes: 6-35 Ampere
 Mounting Length: 80mm
 With M5×51mm Battery Post
 With Trio
 With metal
 With Aluminum Heat sinks
12611900 / MIP8002
 Diodes: 6-35Ampere
 With Copper Heat sinks

Original & X-References..

12612200 / MIP8003L

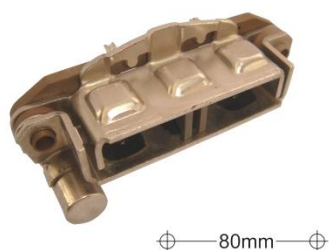

FEATURES

Diodes: 6-35 Ampere
 Mounting Length: 80 mm
 With Trio
 With Aluminum Heat sinks
 For use on: Dodge Trucks, Mazda,
 Mitsubishi, Plymouth
12612100 / MIP8003
 Diodes: 6-35Ampere
 With Copper Heat sinks

Original & X-References..

MITSUBISHI	A 860 T 06070	A 860 T 06082
	MD607568	A 860 T 06470
MOBILETRON		RM-66
WAI		31-8310
CARGO		131221 131541
TRANSPO		IMR8043

12612400 / MIP8004L

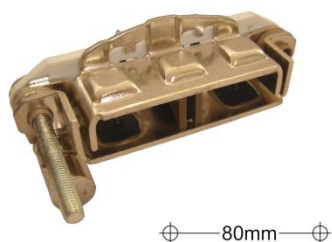

FEATURES

Diodes: 6-35 Ampere
 Mounting Length: 80mm
 With M5×51mm Battery Post
 With Trio
 With Aluminum Heat sinks
 For use on: Mazda GLC
12612300 / MIP8004
 Diodes: 6-35Ampere
 With Copper Heat sinks

Original & X-References..

MITSUBISHI	A 860 T 10770
MOBILETRON	RM-67
WAI	31-8315
CARGO	131532
TRANSPO	IMR8045

12612600 / MIP8005L



FEATURES

Diodes: 6-35 Ampere
 Mounting Length: 80mm
 With Trio
 With Aluminum Heat sinks
 For use on: Nissan Vans, Nissan March
12612500 / MIP8005
 Diodes: 6-35Ampere

Original & X-References..

MITSUBISHI	A 860 T 08470
MOBILETRON	RM-85
WAI	31-8390
CARGO	131543
TRANSPO	IMR8011
	With Copper Heat sinks

12612900 / MIP8007L

⊕—80mm—⊕

FEATURES

Diodes: 6-35 Ampere
Mounting Length: 80mm
With M5×43mm Battery Post
With Trio
With Aluminum Heat sinks
For use on: Mitsubishi Motors

12612800 / MIP8007

Diodes: 6-35Ampere
With Copper Heat sinks

Original & X-References..

MITSUBISHI	ME700555
	A860T14570
MOBILETRON	RM-86
CARGO	136726
TRANSPO	IMR8047

12613100 / MIP8008L

⊕—80mm—⊕

FEATURES

Diodes: 6-35 Ampere
Mounting Length: 80mm
With M5×51mm Battery Post
With Trio
With Aluminum Heat sinks
For use on: Dodge Trucks, Mitsubishi

12613000 / MIP8008

With Copper Heat sinks

Original & X-References..

MITSUBISHI	A 860 T 08270
	MD607616
MOBILETRON	RM-65
WAI	31-8313
CARGO	132130
TRANSPO	IMR8041

12613600 / MIP8501

⊕—85mm—⊕

FEATURES

Diodes: 6-35 Ampere
Mounting Length: 85mm
With Trio
With Copper Heat sinks

For use on: Dodge, Mazda, Mitsubishi,
Plymouth

Original & X-References..

MITSUBISHI	A 860 T 03970	A 860T05170
	MD607370	MD607441
MOBILETRON		RM-68
WAI		31-8314
CARGO		130833
TRANSPO		IMR8511

12613800 / MIP8502

⊕—85mm—⊕

FEATURES

Diodes: 6-35 Ampere
Mounting Length: 85mm
With Trio
With Copper Heat sinks

For use on: Mazda 626, Dodge Truck

Original & X-References..

MITSUBISHI	A 860 T 08370	A 860 T 10470
	MD607693	A 860 T 09370
MOBILETRON		RM-83
WAI		31-8311
CARGO		131545
TRANSPO		IMR8541

12613900 / MIP8503

⊕—85mm—⊕

FEATURES

Diodes: 6-35 Ampere
Mounting Length: 85 mm
With M5×43mm Battery Post
With Trio
With Copper Heat sinks

For use on: Mitsubishi Mirage Turbo,
Mazda Diesel 626

Original & X-References..

MITSUBISHI	2323004D00	A 860 T 08770
	A 860 T 15170	MD607680
MOBILETRON		RM-73
WAI		31-8331
CARGO		132463
TRANSPO		IMR8545

12614000 / MIP8504



⊕—85mm—⊕

FEATURES

Diodes: 6-35 Ampere
 Mounting Length: 85mm
 With Trio
 With Copper Heat Sinks

For use on: Mazda GLC Sedan

Original & X-References..

MITSUBISHI	A002T23471
MOBILETRON	RM-69
WAI	31-8304
CARGO	131544
TRANSPO	IMR8571

12614100 / MIP8505



⊕—85mm—⊕

FEATURES

Diodes: 6-35 Ampere
 Mounting Length: 85mm
 With M5×43mm Battery Post
 With Trio
 With Copper Heat sinks

Original & X-References..

12614200 / MIP8506



⊕—85mm—⊕

FEATURES

Diodes: 6-35 Ampere
 Mounting Length: 85mm
 With M5×43mm Battery Post
 With Trio
 With Aluminum Heat Sinks

Original & X-References..

JA1427IR

12610100 / MIP10001



⊕—100mm—⊕

FEATURES

Diodes: 6-50 Ampere
 Mounting Length: 100mm
 With Trio
 With Copper Heat Sinks

For use on: Mazda 626, Plymouth
 Coquest

Original & X-References..

MITSUBISHI	A003T34077
	A860T10370
MOBILETRON	RM-74
WAI	31-8306
CARGO	131547
TRANSPO	IMR10041

12610200 / MIP10002



⊕—100mm—⊕

FEATURES

Diodes: 6-50 Ampere
 Mounting Length: 100mm
 With Trio
 Without Capacitor

For use on: Dodge, Mazda

Original & X-References..

MITSUBISHI	A860T07370
	A860T04170
MOBILETRON	RM-75
WAI	31-8307
CARGO	131227
TRANSPO	IMR10011

12610300 / MIP10003

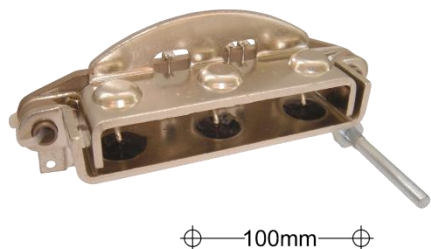

FEATURES

REC MI
 Diodes: 6-50 Ampere
 Mounting Length: 100mm
 With M5×43mm Battery Post
 With Trio
 With Copper Heat Sinks
 For use on: Nissan Bluebird 2000 Diesel

Original & X-References..

MITSUBISHI	A860T11770
MOBILETRON	RM-76
J&N	172-48005
WAI	31-8378
CARGO	132464
TRANSPO	IMR10043

11630100 / MID751ZT



FEATURES

Complete set with
 REC MID751+REG(06-078) 14V

Original & X-References..

TRANSPO	RECTIFIER IYR751
	REGULATOR IY510

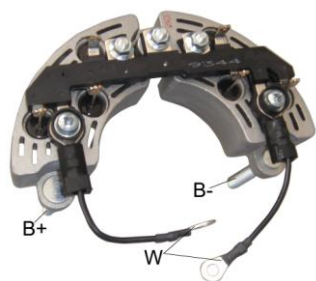

12900700 / MOP3006

FEATURES

Diodes: 6-50 Ampere

Original & X-References..

MOBILETRON	RT-23HD
LESTER	8058 8381
	8387 8397
TRANSPO	MR6206

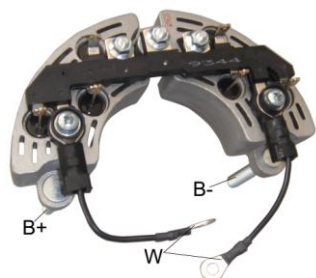

12900710 / MOP3006A

FEATURES

Diodes: 6-50A Avalanche

Original & X-References..

LESTER	8058 8328
	8329 8410
TRANSPO	MR6255

12900720 / MOP3006B

For 24V Alternators



12910500 / MOP6001

FEATURES

Diodes: 3-35 Ampere
Positive Rectifier

Original & X-References..

3109-1018

12910600 / MOP6004

Diodes: 3-35 Ampere
Negative Rectifier

3109-1012

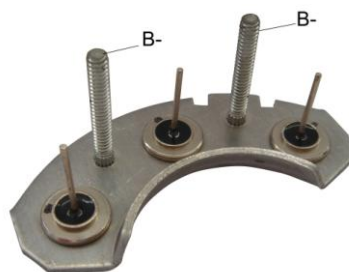

12910700 / MOP6041

FEATURES

Diodes: 3-25 Ampere
With 2—37.2×3/16" Bolt
Negative Rectifier
For: Motorola A/8AL, HA/8HA,
RA/8AR Series Alternators w/Isolation

Original & X-References..

MOTOROLA	101-106 101-107
	101-11
LESTER	7091 7099
	7353 7361
WAI	31-403
CARGO	131888
TRANSPO	MR6041

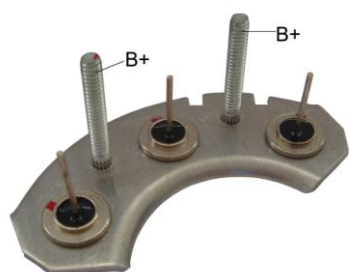

12910800 / MOP6064

FEATURES

Diodes: 3-35 Ampere
With 2—37.2×3/16" Bolt
Positive Rectifier
For: Motorola 60-70 Amp/12 Volt
Alternators
For use on: Farm, Industrial, Marine
Applications

Original & X-References..

MOTOROLA	101-147 101-149
	101-17
LESTER	7376
WAI	31-408
CARGO	131893
TRANSPO	MR6064

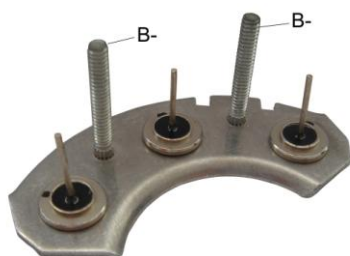

12910900 / MOP6065

FEATURES

Diodes: 3-35Ampere
 With 2—37.2×3/16" Bolt
 Negative Rectifier
 For: Motorola 60-70 Amp/12 Volt
 Alternators
 For use on: Farm, Industrial, Marine
 Applications

Original & X-References..

MOTOROLA	101-148	101-47
LESTER	7376	
WAI	31-407	
CARGO	131892	
TRANSPO	MR6065	

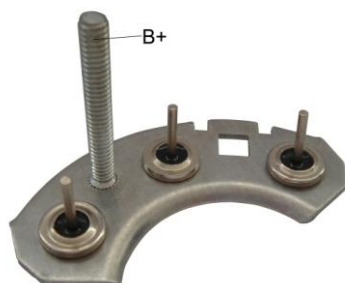

12911000 / MOP6072

FEATURES

Diodes: 3-50Ampere
 With 50.3×1/4" Bolt
 Positive Rectifier
 For: Motorola Alternators
 For use on: Industrial Equipment

Original & X-References..

MOTOROLA	101-162	101-187
LESTER	7417	
WAI	31-406-1	
CARGO	131891	
TRANSPO	MR6072	



12911100 / MOP6300

FEATURES

Diodes: 1-25Ampere
 With 35×1/4" Bolt
 Negative Rectifier

Original & X-References..

MOTOROLA	101-23	101-3
	101-58	37438
LESTER	7356	7357
	7362	7364
CARGO	131885	
TRANSPO	MR6300	



12911200 / MOP6301

FEATURES

Diodes: 2-25Ampere
 With 35×1/4" Bolt
 Negative Rectifier

Original & X-References..

MOTOROLA	101-13	101-29
	101-65	10959
LESTER	7356	7357
	7362	7364
CARGO	131886	
TRANSPO	MR6301	

12314100 / NPD8301



FEATURES

Diodes: 8-35 Ampere
Diameter OD: 83mm
With M6 Battery Post

For use on: Industrial

Original & X-References..

NIPPONDENSO	021580-3110
MOBILETRON	RN-18
WAI	31-8221
CARGO	137872
TRANSPO	INR718

12315600 / NPD8303g

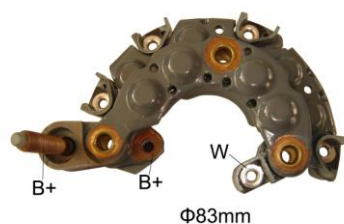

FEATURES

Diodes: 8-35 Ampere Dish Diode
Diameter OD: 83mm
With M6×44mm Battery Post

For use on: Industrial

Original & X-References..

NIPPONDENSO	100211-4640
	100211-1670
	100211-4650
	021580-3450
TOYOTA	1624164011
MOBILETRON	RN-26
TRANSPO	INR716

12310110 / NPD8701

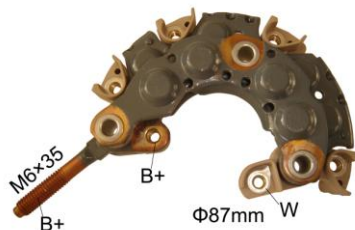

FEATURES

Diodes: 8-35 Ampere
Diameter OD: 87mm
With M6 Battery Post

For use on: Tractors,
TOYOTA 27060-DF020

Original & X-References..

12314700 / NPD8702

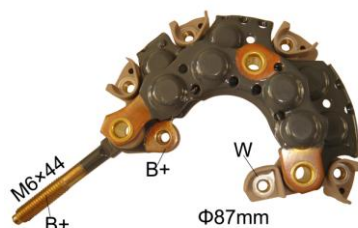

FEATURES

Diodes: 8-35 Ampere
Diameter OD: 87mm
With M6 Battery Post
For use on: Isuzu I-Mark, Toyota Teral ,
4-Runner

Original & X-References..

NIPPONDENSO	021580-3130
TOYOTA	27375-72150
MOBILETRON	RN-15
WAI	31-8200
ISUZU	8-94449-781-1
CARGO	132540
TRANSPO	INR724

12315200 / NPD9001



FEATURES

Diodes: 8-35 Ampere
Diameter OD: 90mm
With M6 Battery Post
Without Mounting Hole for Ground
Strap

For use on: Honda Civic, CRX, Toyota
Tercel, Acura

Original & X-References..

NIPPONDENSO	021580-2250
WAI	31-8205
CARGO	132541
MOBILETRON	RN-16
TOYOTA	27375-6340
TRANSPO	INR725

12315300 / NPD9002



FEATURES	Original & X-References..	
Diodes: 8-35 Ampere	NIPPONDENSO	100211-1220
Diameter OD: 90mm	100211-1330	100211-3720
With M6×44mm Battery Post	021580-2341	
For use on: Geo Spectrum, Isuzu I-Mark	WAI	31-8206
	CARGO	135258
	MOBILETRON	RN-17
	ISUZU	16231-64851
	TRANSP0	INR726

12310600 / NPD10001



FEATURES	Original & X-References..	
Diodes: 8-50 Ampere	NIPPONDENSO	021580-2160
Diameter OD: 100mm	021580-2230	27357-63020
For use on: Acura, Honda, Isuzu, Toyota, Sterling	MOBILETRON	RN-13
	WAI	31-8201
	CARGO	132082
	TRANSP0	INR720

12310700 / NPD10001F

With Steel Heat sinks

12325100 / NPD10001L



FEATURES	Original & X-References..	
Diodes:8-35 Ampere Press-fit Diodes	NIPPONDENSO	021580-2160
Diameter OD: 100mm	021580-2230	27357-63020
With M6 Battery Post	MOBILETRON	RN-13
With Aluminum Heat sinks	WAI	31-8201
	CARGO	132082
	TRANSP0	INR720P

12310800 / NPD10002

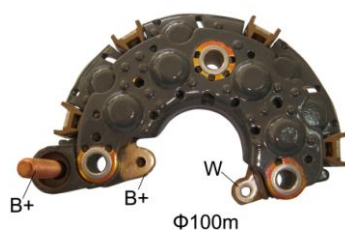

FEATURES	Original & X-References..	
Diodes: 8-50 Ampere	NIPPONDENSO	100211-1070
Diameter OD: 100mm	100211-1100	100211-3120
With M6×40mm Battery Post	021580-2512	
For use on: Geo Strom, Isuzu Impulse, Stylus	MOBILETRON	RN-12
	RENARD	11264
	WAI	31-8211
	CARGO	135250
	TRANSP0	INR401

12325300 / NPD10002L



FEATURES	Original & X-References..	
Diodes:8-35 Ampere Press-fit Diodes	NIPPONDENSO	100211-1070
Diameter OD: 100mm	100211-1100	100211-3120
With M6×40mm Battery Post	MOBILETRON	RN-12
With Aluminum Heat sinks	RENARD	11264
	WAI	31-8211
	CARGO	135250
	TRANSP0	INR401P

12310900 / NPD10003

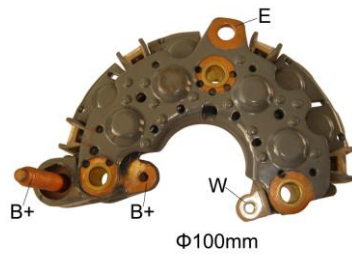

FEATURES

Diodes: 8-50 Ampere
 Diameter OD: 100mm
 With M6×40mm Battery Post
 With Mounting Hole for Ground Strap
 For use on: Geo Strom, Isuzu Impulse, Stylus

Original & X-References..

12311000 / NPD10004

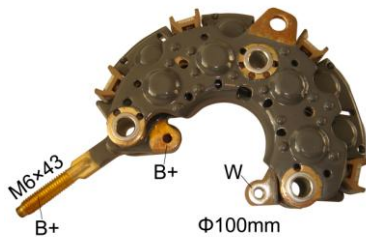

FEATURES

Diodes: 8-50 Ampere
 Diameter OD: 100mm
 With M6 Battery Post
 With Mounting Hole for Ground Strap

Original & X-References..

DENSO	021580-5300
SUZUKI	31621-75F00
CARGO	231236
TRANSPO	INR5028

12311100 / NPD10005

Diodes: 6-35Ampere

TRANSPO	INR502
---------	--------

12325400 / NPD10004L



FEATURES

Diodes: 8-35Ampere Press-fit Diodes
 Diameter OD: 100mm
 With M6 Battery Post
 With Mounting Hole for Ground Strap
 With Aluminum Heat sinks

Original & X-References..

DENSO	021580-5300
SUZUKI	31621-75F00
LESTER	13739L

1232AJ00

Diodes: 6-35Ampere Press-fit Diodes

TRANSPO	INR502P
---------	---------

12311200 / NPD10006

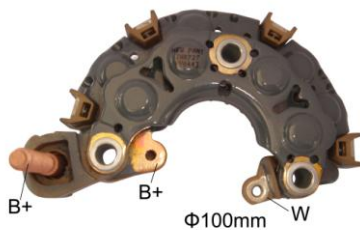

FEATURES

Diodes: 8-50 Ampere
 Diameter OD: 100mm
 With M6×44mm Battery Post

Original & X-References..

NIPPONDENSO	1401-0001
021580-4120	021580-4490
TOYOTA	27357-74120
	27357-74290

For use on: Chrysler Laser, LeBaron, New Yorker, Dodge600, Aires Caravan, Plymouth Acclaim, Reliant, Voyager, Turismo

MOBILETRON	RN-14
WAI	31-8204
CARGO	135415
TRANSPO	INR727

12311300 / NPD10007

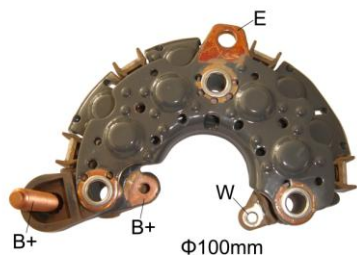

FEATURES

Diodes: 8-50 Ampere
 Diameter OD: 100mm
 With M6×40mm Battery Post
 With Mounting Hole for Ground Strap

Original & X-References..

12311500 / NPD10301

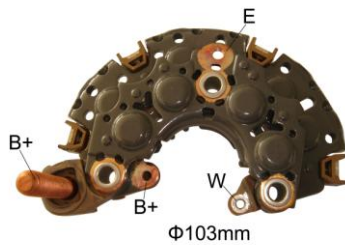

FEATURES	Original & X-References..	
Diodes: 8-50 Ampere	NIPPONDENSO	021580-3640
Diameter OD: 103mm	025180-4660	021580-4670
With M6×44mm Battery Post	025180-4840	
With Ground Screw Hole	MOBILETRON	RN-01
For use on: Chrysler Lebaron ,Dodge Caravan, spirt, Daytona, Omni	WAI	31-8208
		31-8208-1
	CARGO	135417
	TRANSPO	INR729

12325900 / NPD10301L



FEATURES	Original & X-References..	
Diodes: 8-50 Ampere Press-fit Diodes	NIPPONDENSO	021580-3640
Diameter OD: 103mm		025180-4660
With M6×44mm Battery Post		025180-4840
With Ground Screw Hole	MOBILETRON	RN-01
With Aluminum Heat sinks	WAI	31-8208
		31-8208-1
	CARGO	135417
	TRANSPO	INR729P

12311600 / NPD10302

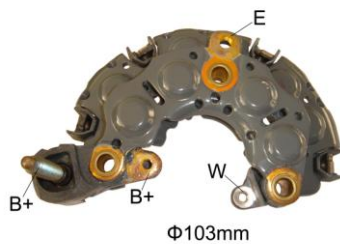

FEATURES	Original & X-References..	
Diodes: 8-50 Ampere	NIPPONDENSO	021580-3640
Diameter OD: 103mm		100211-8810
With M6×44mm Battery Post		121000-3480
With Ground Screw Hole		
For use on: All 1993 Chrysler LH-Cars	WAI	31-8208
	CARGO	135418
	TRANSPO	INR403

12312300 / NPD10311

Diodes: 6-50 Ampere

12326010 / NPD10302L



FEATURES	Original & X-References..	
Diodes: 8-50 Ampere Press-fit Diodes	NIPPONDENSO	100211-8810
Diameter OD: 103mm		121000-3480
With M6×44mm Battery Post		
With Aluminum Heat sinks	WAI	31-8208
With Ground Screw Hole	CARGO	135418
	TRANSPO	INR403P

12311700 / NPD10303

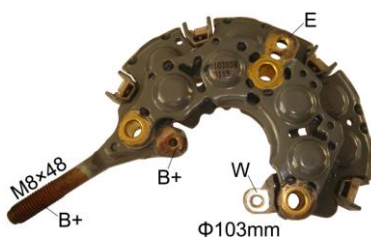

FEATURES	Original & X-References..	
Diodes: 8-50 Ampere	NIPPONDENSO	021580-4640
Diameter OD: 103mm		100211-2400
With M8 Battery Post		101211-5450
With Ground Screw Hole	MOBILETRON	RN-05
For use on: Volvo Turbo Aircon, Lexus	WAI	31-8217
	CARGO	135043
	TRANSPO	INR722

12326100 / NPD10303L**FEATURES**

Diodes: 8-50 Ampere Press-fit Diodes
Diameter OD: 103mm
With M8 Battery Post
With Ground Screw Hole
With Aluminum Heat sinks

Original & X-References..

NIPPONDENSO	100211-2400
	101211-5450
MOBILETRON	RN-05
WAI	31-8217
CARGO	135043
TRANSP0	INR722P

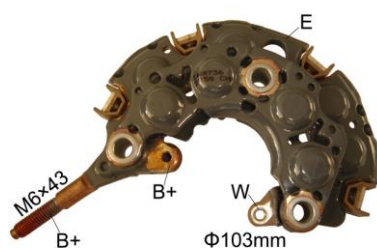
12311900 / NPD10304**FEATURES**

Diodes: 8-50 Ampere
Diameter OD: 103mm
With M6 Battery Post(31 °)

Original & X-References..

NIPPONDENSO	021580-3830
	100211-8050
	100211-8710
WAI	31-8212
RENARD	11227
CARGO	133672
TRANSP0	INR731

12326200 / NPD10304L**FEATURES**

Diodes: 8-50 Ampere Press-fit Diodes
Diameter OD: 103mm
With M6 Battery Post(31 °)
Press-fit Diodes
With Aluminum Heat sinks

Original & X-References..

NIPPONDENSO	100211-8050
	100211-8710
WAI	31-8212
RENARD	11227
CARGO	133672
TRANSP0	INR731P

12326300 / NPD10304L-1

With M6 Battery Post(36 °)

1232AP00**FEATURES**

Diodes:6-50 Ampere Press-fit Diodes
Diameter OD: 103mm
With M6 Battery Post (31 °)
Press-fit Diodes
With Aluminum Heat sinks

Original & X-References..

MOBILETRON	RN-36
TRANSP0	INR406P

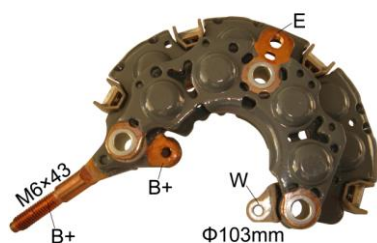
12312000 / NPD10305**FEATURES**

Diodes: 8-50 Ampere
Diameter OD: 103mm
With M6 Battery Post
With Ground Screw Hole
For use on: Geo Prizm, Toyota Celica,
Corolla

Original & X-References..

MOBILETRON	RN-03
RENARD	11262
WAI	31-8212
CARGO	133672
TRANSP0	INR402
CARGO	237663

12326400 / NPD10305L



FEATURES	Original & X-References..	
Diodes:8-50A Ampere Press-fit Diodes	MOBILETRON	RN-03
Diameter OD: 103mm	RENARD	11262
With M6 Battery Post	WAI	31-8212
With Ground Screw Hole	CARGO	133672
With Aluminum Heat sinks	TRANSPO	INR402P
12326600 / NPD10305L-3	CARGO	237663
Diodes:6-50A Avalanche		

12312100 / NPD10306

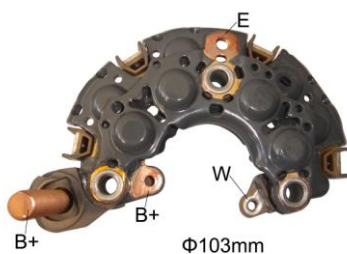

FEATURES	Original & X-References..	
Diodes: 8-50 Ampere	NIPPONDENSO	100211-8620
Diameter OD: 103mm		100211-8630
With M8x50mm Battery Post		100211-8632
With Ground Screw Hole	RENARD	11222
For use on: Volvo 740 Series 2.3L	WAI	31-8218
W/Turbo		31-8222
	CARGO	136741 135418
	TRANSPO	INR739

12327300 / NPD10306L



FEATURES	Original & X-References..	
Diodes:8-50 Ampere Press-fit Diodes	NIPPONDENSO	100211-8620
Diameter OD: 103mm		100211-8630
With M8x50mm Battery Post		100211-8632
With Ground Screw Hole	RENARD	11222
With Aluminum Heat sinks	WAI	31-8218
		31-8222
	CARGO	136741 135418
	TRANSPO	INR739P

12312700 / NPD11301

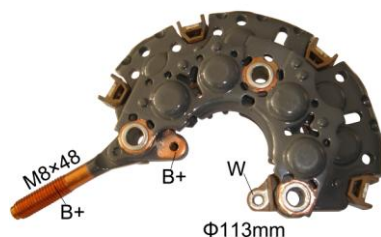

FEATURES	Original & X-References..	
Diodes: 8-50 Ampere	NIPPONDENSO	021580-4100
Diameter OD: 113mm		021580-4610
With M8 Battery Post		021580-4690
	MOBILETRON	RN-08
For use on: Toyota Land Cruiser	WAI	31-8213
	CARGO	137874
	TRANSPO	INR732

12312800 / NPD11302

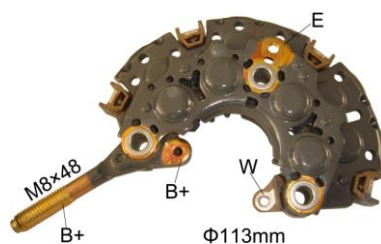

FEATURES	Original & X-References..	
Diodes: 8-50 Ampere	DENSO	021580-4690
Diameter OD: 113mm		021580-4100
With M8 Battery Post	MOBILETRON	RN-11
With Ground Screw Hole	RENARD	11254
For use on: Lexus SC400, Toyota	WAI	31-8214
12313700 / NPD11311	CARGO	137874
Diodes: 8-50 Ampere	TRANSPO	INR733
Nicle Plating		

12327000 / NPD11302L



FEATURES

Diodes: 8-50 Ampere Press-fit Diodes
Diameter OD: 113mm
With M8 Battery Post
With Ground Screw Hole
With Aluminum Heat sinks

Original & X-References..

DENSO	021580-4690
	021580-4100
MOBILETRON	RN-11
RENARD	11254
WAI	31-8214
CARGO	137874
TRANSPO	INR733P

12313000 / NPD11303

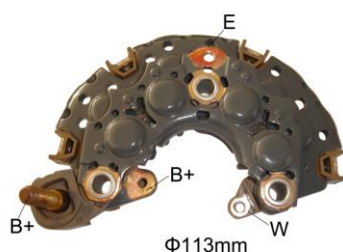

FEATURES

Diodes: 8-50 Ampere
Diameter OD: 113mm
With M6x44mm Battery Post
With Ground Screw Hole

Original & X-References..

NIPPONDENSO	121000-4000
	021580-4820
	121000-4010
MOBILETRON	RN-02
WAI	31-8207
CARGO	135416
TRANSPO	INR734

12327100 / NPD11303L



FEATURES

Diodes: 8-50 Ampere Press-fit Diodes
Diameter OD: 113mm
With M6x44mm Battery Post
With Ground Screw Hole
With Aluminum Heat sinks

Original & X-References..

NIPPONDENSO	121000-4000
	021580-4820
	121000-4010
MOBILETRON	RN-02
WAI	31-8207
CARGO	135416
TRANSPO	INR734P

12313200 / NPD11305

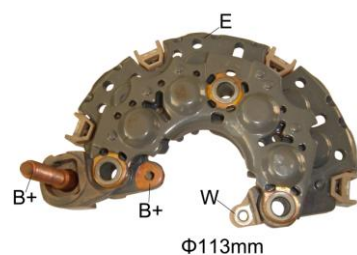

FEATURES

Diodes: 8-50 Ampere
Diameter OD: 113mm
With M6x44mm Battery Post
For use on: Chrysler New Yorker,
Dodge Caravan, Dynasty, Dodge
Truck, Plymouth Voyager, Acclaim

Original & X-References..

NIPPONDENSO	121000-4000
	121000-4010
ISUZU	8 8121 8 0330
MOBILETRON	RN-02
WAI	31-8207
CARGO	135416
TRANSPO	INR728

12327200 / NPD11305L



FEATURES

Diodes: 8-50A Ampere Press-fit Diodes
Diameter OD: 113mm
With M6x44mm Battery Post
With Ground Screw Hole
With Aluminum Heat sinks

Original & X-References..

NIPPONDENSO	121000-4000
	121000-4010
ISUZU	8 8121 8 0330
MOBILETRON	RN-02
WAI	31-8207
CARGO	135416
TRANSPO	INR728P

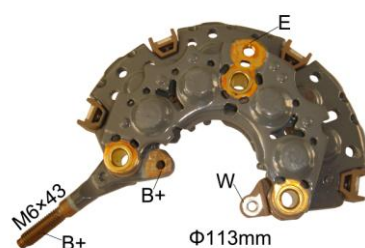
12313300 / NPD11306**FEATURES**

Diodes: 8-50 Ampere
 Diameter OD: 113mm
 With M6 Battery Post
 With Ground Screw Hole
 For use on: Acura

Original & X-References..

NIPPONDENSO	121000-4230
	121000-4250
MOBILETRON	RN-08
WAI	31-8232
TRANSP0	INR735

12327300 / NPD11306L**FEATURES**

Diodes: 8-50 Ampere Press-fit Diodes
 Diameter OD: 113mm
 With M6 Battery Post
 With Ground Screw Hole
 With Aluminum Heat sinks

Original & X-References..

NIPPONDENSO	121000-4230
	121000-4250
MOBILETRON	RN-08
WAI	31-8232
TRANSP0	INR735P

12313500 / NPD11308**FEATURES**

Diodes: 8-50 Ampere
 Diameter OD: 113mm
 With M8x47mm Battery Post
 With Ground Screw Hole

Original & X-References..

DENSO	021580-2500
021580-4250	021580-4590
MOBILETRON	RN-16
WAI	31-8215
CARGO	233246
TRANSP0	INR736

12327400 / NPD11308L**FEATURES**

Diodes: 8-50 Ampere Press-fit Diodes
 Diameter OD: 113mm
 With M8x47mm Battery Post
 With Ground Screw Hole
 With Aluminum Heat sinks

Original & X-References..

DENSO	021580-4250
	021580-4590
MOBILETRON	RN-16
WAI	31-8215
CARGO	233246
TRANSP0	INR736P

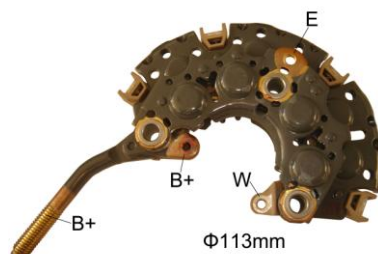
12313600 / NPD11310**FEATURES**

Diodes: 8-50 Ampere
 Diameter OD: 113mm
 With M8 Battery Post
 With Ground Screw Hole

Original & X-References..

FILS LESTER NUMBERS		
13410	13687	13791

12330300 / NPD11401L

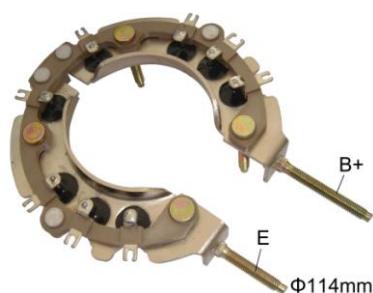

FEATURES

Diodes: 8-35 Ampere
 Diameter OD: 114mm
 With M5×47.5mm Battery Post
 With M5×35mm Ground Post
 With M5×41.5mm Mounting Bolt
 With Aluminum heat sink

Original & X-References..

DENSO	021580-2300
CARGO	132649

12330100 / NPD11401

Diodes: 8-35 Ampere
 With Cooper Heat sinks

12330400 / NPD11402

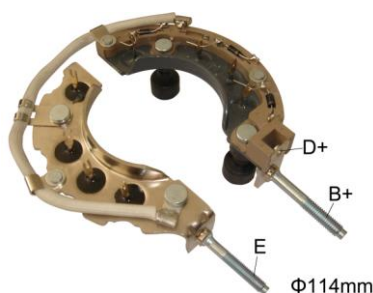

FEATURES

Diodes: 8-35 Ampere
 Diameter OD: 114mm
 With M6×48.5mm Battery Post
 With M5×40mm Battery Mounting Bolt
 With M5×40mm Ground Post
 With M5×35mm Ground Mounting Bolt
 With Trio
 With cooper heat sink

Original & X-References..

12330600 / NPD11404

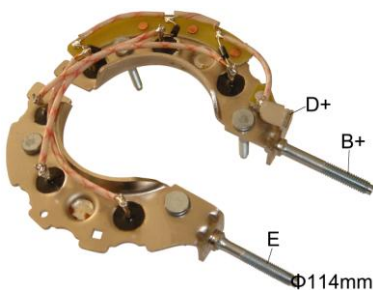

FEATURES

Diodes: 6-50 Ampere
 Diameter OD: 114mm
 With M6×48.5mm Battery Post
 With M5×40mm Ground Post
 With M5×41.5mm Mounting Bolt
 With Trio
 With steel heat sink

Original & X-References..

12330900 / NPD11406L

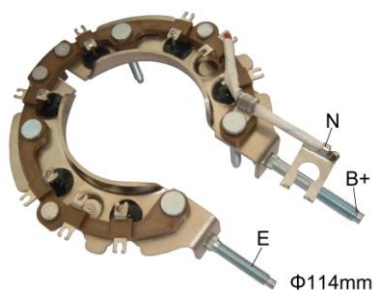

FEATURES

Diodes: 6-35 Ampere
 Diameter OD: 114mm
 With M6×48.5mm Battery Post
 With M5×35mm Ground Post
 With M5×41.5mm Mounting Bolt

Original & X-References..

NIPPONDENSO	021590 1890
	021590 1990
	021590 1910
CARGO	132657

12330700 / NPD11406

Diodes: 6-35 Ampere
 With Cooper Heat sinks

12331000 / NPD11406L-1

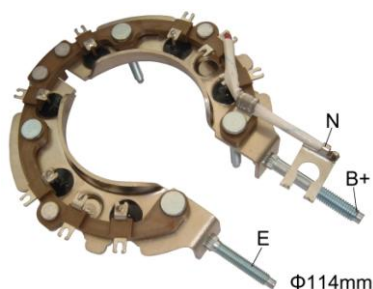

FEATURES

Diodes: 8-35 Ampere
 Diameter OD: 114mm
 With M6×48.5mm Battery Post
 With M5×35mm Ground Post
 With M5×41.5mm Mounting Bolt

Original & X-References..

12330800 / NPD11406-1

With cooper heat sink

12331700/ NPD11412

With M6×40mm Battery Post
 With cooper heatsink

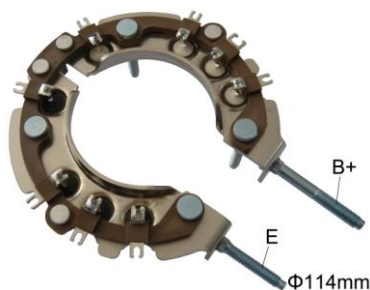
**12331300 / NPD11407L****FEATURES**

Diodes: 8-35 Ampere Diodes
 Diameter OD: 114mm
 With M6×48.5mm Battery Post
 With M5×35mm Ground Post
 With M5×41.5mm Mounting Bolt
 With Aluminum Heat sink

Original & X-References..**12331100 / NPD11407**

Diodes: 8-35 Ampere
 With cooper heat sink

12331200 / NPD11407-1

With M6×40mm Battery Post
 With cooper heat sink

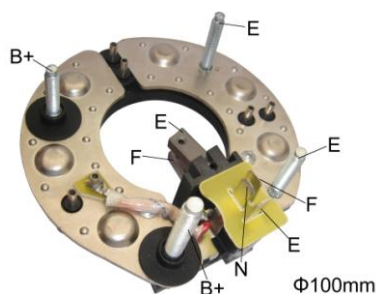
**12331400 / NPD11408****FEATURES**

Diodes: 6-35 Ampere
 Diameter OD: 100mm
 With M6×49.5mm Battery Post
 With M5×36mm Battery Mounting Bolt
 With M5×38mm Ground Post
 With M5×38mm Ground Mounting Bolt

Original & X-References..

NIPPONDENSO 021600-1340

CARGO 135884

TRANSP0 INR400

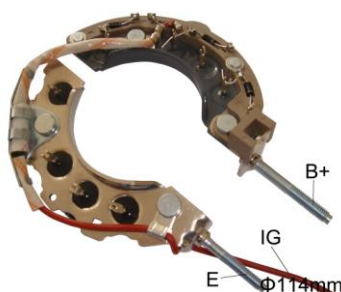
**12331500 / NPD11410****FEATURES**

Diodes: 8-35 Ampere
 Diameter OD: 114mm
 With M6×48.5mm Battery Post
 With M5×40mm Battery Mounting Bolt
 With M5×40mm Ground Post
 With M5×35mm Ground Mounting Bolt
 With Trio
 With cooper heat sink

Original & X-References..

NIPPONDENSO 27357554190

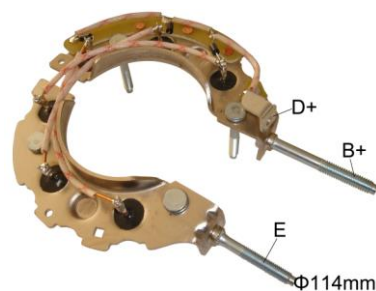
**12331600 / NPD11411****FEATURES**

Diodes: 6-50 Ampere
 Diameter OD: 114mm
 With M6×55mm Battery Post
 With M5×40mm Ground Post
 With M5×41.5mm Mounting Bolt
 With Trio
 With steel heat sink

Original & X-References..**12332200 / NPD11419****FEATURES**

Diodes: 8-35 Ampere
 Diameter OD: 114mm
 With M6×58mm Battery Post
 With M5×47.5mm Ground Post
 With M5×35mm Mounting Bolt
 With Trio

Original & X-References..



12332300

FEATURES

Diodes: 6-35A Ampere
 Diameter OD: 114mm
 With M6×47.5mm Battery Post
 With M5×41.5mm Battery Mounting Bolt
 With M5×47.5mm Ground Post
 With M5×38mm Ground Mounting Bolt

Original & X-References..



12332400

FEATURES

Diodes: 6-35A Ampere
 Diameter OD: 114mm
 With M6×47.5mm Battery Post
 With M5×47.5mm Ground Post
 With M5×38mm Mounting Bolt

Original & X-References..



12300200 / NPD11501A

FEATURES

Diodes :6-50 A Avalanche Press-Fit
 Diameter OD : 113mm
 With M6×33mm Battery Post
 With Aluminum Heat sinks

Original & X-References..

NIPPONDENSO	021580-9220
TRANSPO	INR438
LESTER	23371

12304800

Diodes :6-35 A Avalanche Press-Fit
 With M8×35mm Battery Post



12300300 / NPD11502A

FEATURES

Diodes :6-50 A Avalanche Press-Fit
 Diameter OD : 113mm
 With M8×46mm Battery Post
 With Aluminum Heat sinks

Original & X-References..

NIPPONDENSO	021580-9210
MOBILETRON	RN-64

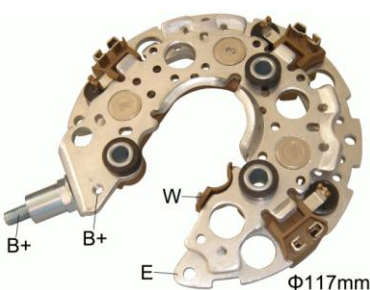

12300600 / NPD11701AL

FEATURES

Diodes: 6-50 A Avalanche Press-Fit
 Diameter OD: 117mm
 With M6×33mm Battery Post
 With Aluminum Heat sinks

Original & X-References..

NIPPONDENSO	021580-6610
TOYOTA	2735703-0070
MOBILETRON	RN-46
TRANSPO	INR430



12300700 / NPD11702AL

FEATURES

Diodes: 12-35 A Avalanche Press-Fit
 Diameter OD: 117mm
 With M6×33mm Battery Post
 With Aluminum Heat sinks
 For use on: 2003 Toyota Tundra Pickup
 4.7L

Original & X-References..

NIPPONDENSO	1401-0009
	104210338
TOYOTA	27060-0F040
MOBILETRON	RN-34
CARGO	237607
TRANSPO	INR422

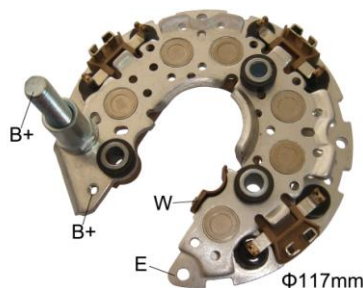

12300800 / NPD11703AL

FEATURES

Diodes: 12-35 A Avalanche Press-Fit
 Diameter OD: 117mm
 With M8×46mm Battery Post
 With Aluminum Heat sinks

Original & X-References..

NIPPONDENSO	421000-0120
	021997-1123
MOBILETRON	RN-30
TRANSPO	INR420

12303000 / NPD11722AL

With M8×40.5mm Battery Post



12300900 / NPD11705AL

FEATURES

Diodes: 6-50 A Avalanche Press-Fit
 Diameter OD: 117mm
 With M6×34.5mm Battery Post
 With Aluminum Heat sinks

Original & X-References..

NIPPONDENSO	021580-6490
HONDA	31127-RAA-A010M
MOBILETRON	RN-48
TRANSPO	INR429



12301100 / NPD11706AL

FEATURES

Diodes: 12-35 A Avalanche Press-Fit
 Diameter OD: 117mm
 With M8×30mm Battery Post
 With Aluminum Heat sinks

Original & X-References..

MOBILETRON	RN-39
CARGO	237607
TRANSPO	INR437

12301000 / NPD11706A-1

With Copper Heat sinks

MOBILETRON	RN-29
TRANSPO	INR421



12301200 / NPD11707A

FEATURES

Diodes: 12-35A Avalanche Press-Fit
 Diameter OD: 117mm
 With M8×46mm Battery Post
 With Copper Heat sinks
 For use on: 2002-01 Acura MDX3.5L
 2004-02 Honda Odyssey 3.5L
 2004-03 Honda Pilot 3.5L

Original & X-References..

NIPPONDENSO	1401-0026
MOBILETRON	RN-33
TRANSPO	INR424

12301400 / NPD11708A

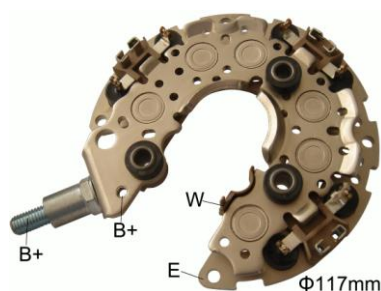

FEATURES

Diodes: 12-35 A Avalanche Press-Fit
 Diameter OD: 117mm
 With M8×40mm Battery Post
 With Copper Heat sinks
12301500 / NPD11708AL

Original & X-References..

MOBILETRON	RN-47
CARGO	235589
TRANSPO	INR433

With Aluminum Heat sinks

12302100 / NPD11711A

With M6×33mm Battery Post
 With Copper Heat sinks

CARGO	236328
-------	--------

12301700 / NPD11709AL

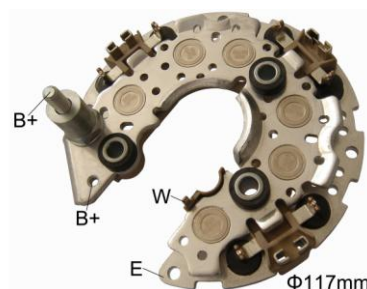

FEATURES

Diodes: 12-35 A Avalanche Press-Fit
 Diameter OD: 117mm
 With M6×34.5mm Battery Post
 With Aluminum Heat sinks

Original & X-References..

For use on :

2001-05 Cadillac Deville FWD4.6L
2001-04 Cadillac Seville 4.6L
2004-05 Pontiac Bonneville 4.6L

MOBILETRON	RN-44
TRANSPO	INR425

12301800 / NPD11710AL

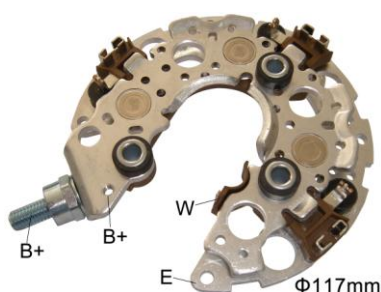

FEATURES

Diodes: 6-50 A Avalanche Press-Fit
 Diameter OD: 117mm
 With M8×30mm Battery Post
 With Aluminum Heat sinks

Original & X-References..

12302200 / NPD11712AL

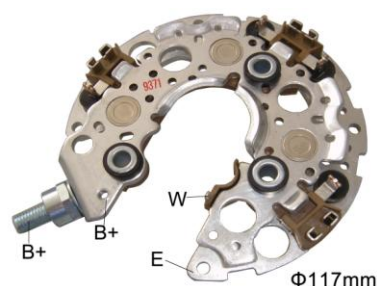

FEATURES

Diodes :7-50 A Avalanche Press-Fit
 Diameter OD : 117mm
 With M8×30mm Battery Post
 With Aluminum Heat sinks

Original & X-References..

NIPPONDENSO	104210-351
	104210-376
MOBILETRON	RN-37
CARGO	237613
TRANSPO	INR431

12302720 / NPD11717L



FEATURES

Diodes: 12-35A Ampere Press-Fit
 Diameter: 117mm
 With M8×40mm Battery Post
 With Aluminum Heat sinks

For use on: (2005-01) Chrysler, Dodge,
 Jeep

Original & X-References..

DENSO	421000001, 421000002, 421000004, 421000006, 421000010, 421000030, 4210000301
LESTER	11063, 13870, 13871, 13912, 13913
MOBILETRON	RN-29
TRANSPO	INR421

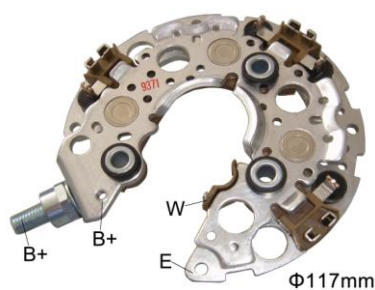
12302900 / NPD11720AL**FEATURES**

Diodes :7-50A Avalanche Press-Fit
 Diameter OD : 117mm
 With M8×40mm Battery Post
 With Aluminum Heat sinks

Original & X-References..

LESTER	13871
	13868
MOBILETRON	RN-55
TRANSPO	INR423

12300820 / NPD11729AL**FEATURES**

Diodes: 12-50 A Avalanche Press-Fit
 Diameter OD: 117mm
 With M8×46mm Battery Post
 With Aluminum Heat sinks

Original & X-References..

LESTER	13918
MOBILETRON	RN-33
TRANSPO	INR424

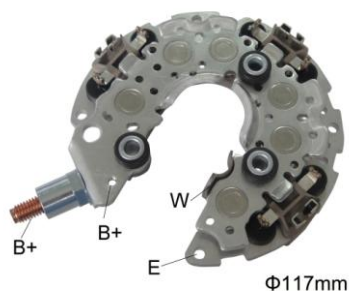
12303300 / NPD11731AL**FEATURES**

Diodes: 12-35 A Avalanche Press-Fit
 Diameter OD: 117mm
 With M8×35mm Battery Post
 With Aluminum Heat sinks

Original & X-References..

CARGO	333401
-------	--------

12303700 / NPD11735AL**FEATURES**

Diodes: 12-60 A Avalanche Press-Fit
 Diameter OD: 117mm
 With M8×46mm Battery Post
 With Aluminum Heat sinks
 HITACHI Type Diodes

Original & X-References..

NIPPONDENSO	021580-6830
	104210-2160
MOBILETRON	RN-54
TRANSPO	INR436

12303800 / NPD11736AL**FEATURES**

Diodes: 12-60 A Avalanche Press-Fit
 Diameter OD: 117mm
 With M6×40mm Battery Post
 With Aluminum Heat sinks
 HITACHI Type Diodes

Original & X-References..

NIPPONDENSO	021580-5920
MOBILETRON	RN-44
TRANSPO	INR425

12822100 / NPD13002

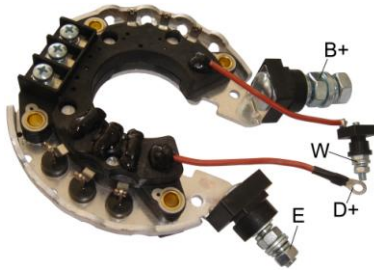

FEATURES

Diodes: 6-35 Ampere
 Diameter OD: 130mm
 With M10×50.5mm Battery Post
 With M6×40mm Ground Post
 With Trio/Capacitor

Original & X-References..

12304100 / NPD13401A

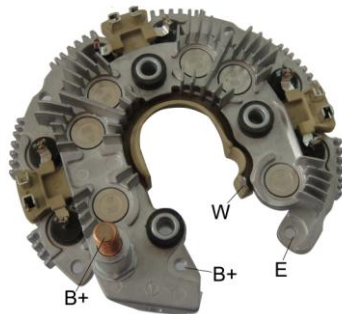

FEATURES

Diodes: 12-50A Avalanche
 With M8×46mm Battery Post

Original & X-References..

NIPPONDENSO	104210-6100
LESTER	11181
TRANSPO	INR435

12327600 / NPD13801

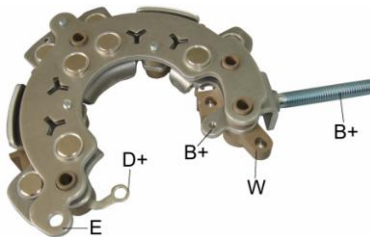

FEATURES

Diodes: 8-50 Ampere Press-Fit
 Diameter OD: 138mm
 With Aluminum Heat sinks
 With 5/16"×60mm Battery Post

Original & X-References..

3146-3800

12327610 / NPD13801B-1

Diodes: 8-50 A Avalanche Press-Fit
 For 24V Alternators

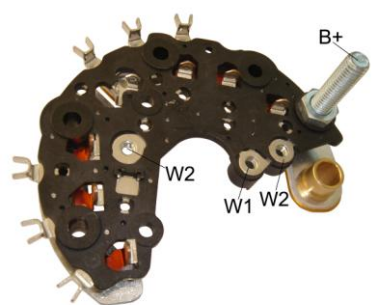

Φ107mm

12810400 / VAL841

FEATURES

Diodes: 8-50A Avalanche
 Diameter OD: 107mm
 With M8×49mm Battery Post
 Without Trio
 Without “W” Terminal
 For use on: Passit
12810200 / VAL840
 Diodes: 6-50A Avalanche

Original & X-References..

VALEO	593174	593306
	593329	
CARGO	138303	
TRANSPO	IPR841	
12810600 / VAL842		
Diodes: 8-50A Avalanch		
With “W” Terminal		

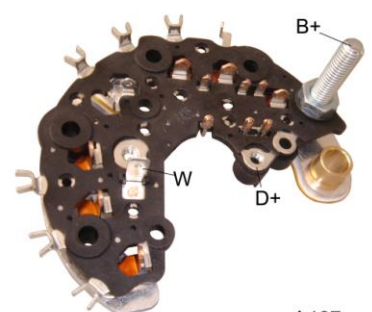

Φ107mm

12810800 / VAL844

FEATURES

Diodes: 6-50A Avalanche
 Diameter OD: 107mm
 With M8×49mm Battery Post
 With Trio
 With “W” Terminal
 For use on: Renault, Peugeot

Original & X-References..

VALEO	2546062	2546076
	592844	592917
MOBILETRON	RP-14	
CARGO	135427	
TRANSPO	IPR844	
12812500 / VAL856		
Diodes: 6-50A Avalanche		
With M8×59mm Battery Post		

12811000 / VAL845

Diodes: 8-50A Avalanche

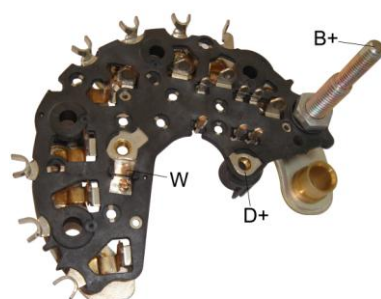

Φ107mm

12811100 / VAL846

FEATURES

Diodes: 8-50 A Avalanche
 Diameter OD: 107mm
 With (M8+M6)×60.8mm Battery Post
 With Trio
 With “W” Terminal
12811200 / VAL846-1
 With (M8+M6)×46mm Battery Post
 For use on: Renault, Peugeot

Original & X-References..

VALEO	2545941	545940
	592846	592847
	A546860A	NF007
MOBILETRON	RP-17	
CARGO	135518	
TRANSPO	IPR846	

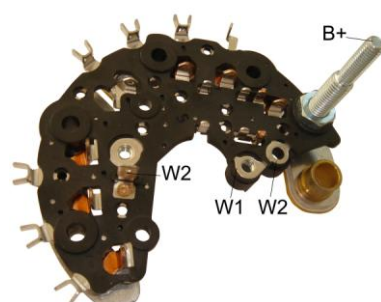

Φ107mm

12811300 / VAL847

FEATURES

Diodes: 6-50A Avalanche
 Diameter OD: 107mm
 With (M8+M6)×60.8mm Battery Post
 Without Trio
 With “W” Terminal
 For use on: Renault, Peugeot
12811500 / VAL850
 Diodes: 8-50A Avalanche

Original & X-References..

VALEO	2545938	545937
MOBILETRON	MFRX03952	
	RP-18	
TRANSPO	IPR847	

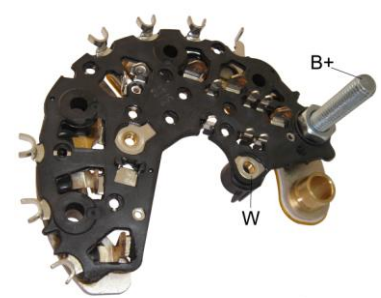

Φ107mm

12811400 / VAL848

FEATURES

Diodes: 6-50A Avalanche
 Diameter OD: 107mm
 With M8×49mm Battery Post
 Without Trio
 Without “W” Terminal
 For use on: Citroen, Peugeot

Original & X-References..

12811700 / VAL852



FEATURES

Diodes: 6-50A Avalanche
 Diameter OD: 107mm
 With M8×60.8mm Battery Post
 Without Trio
 With “W” Terminal

12812200 / VAL855

Diodes: 8-50 A Avalanche
12811800 / VAL852-1
 With(M8+M6) ×50mm Battery Post

Original & X-References..

LESTER 21435

12812000 / VAL853-2

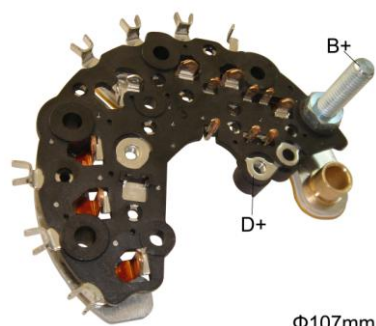

FEATURES

Diodes: 6-50 Ampere
 Diameter OD: 107mm
 With M8×49mm Battery Post
 Without “W” Terminal
 With Trio

12811900 / VAL853

Diodes: 6-50 A Avalanche
12810100 / VAL814

Diodes: 8-50A Avalanche

Original & X-References..

VALEO 592915
 CARGO 231736 135494
 TRANSPO MER592

12812300 / VAL855-1

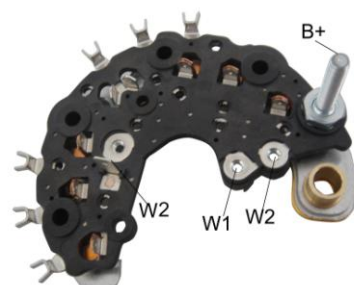

FEATURES

Diodes:6-50A Avalanche
 Diameter OD:107mm
 With (M8+M6) × 46mm Battery Post
 Without Trio
 With “W” Terminal

12812400 / VAL855-2

Diodes: 8-50A Avalanche
 With(M8+M6) ×50mm Battery Post

Original & X-References..

12812600 / VAL857

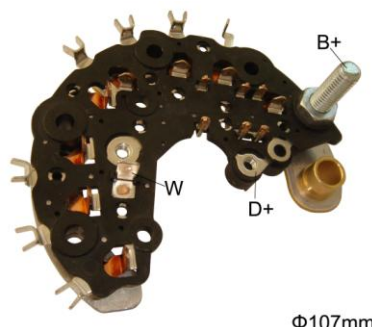

FEATURES

Diodes: 8-50A Avalanche
 Diameter OD: 107mm
 With M8×43mm Battery Post
 With Trio
 With “W” Terminal

12812700 / VAL857-1

With M8×40mm Battery Post
12811600 / VAL851

Diodes: 6-50 A Avalanche

Original & X-References..

VALEO 2546048 546041
 592848 NF009
 MOBILETRON RP-13
 CARGO 135278
 TRANSPO IPR848

12812800 / VAL858B

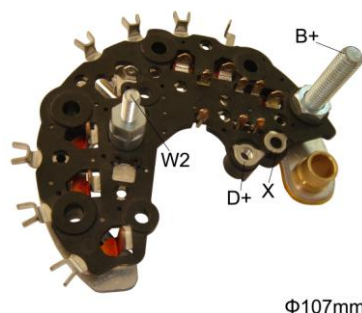

FEATURES

Diodes: 6-50A Avalanche
 Diameter OD: 107mm
 With M8×49mm Battery Post
 With M5×25mm W-post
 With Trio
 For 24V Alternator

Original & X-References..

VALEO 2546423
 MOBILETRON RP-28
 CARGO 139483

12840100 / VAL815P

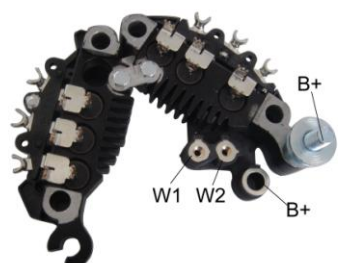

FEATURES

Diodes : 12-35A Avalanche
 With M8×37.5mm Battery Post
 With M4×14mm Mounting Bolt

Original & X-References..

VALEO	593287
CARGO	233614

12840300 / VAL816P



FEATURES

Diodes : 12-35A Avalanche
 With M8×37.5mm Battery Post
 With M4×14mm Mounting Bolt

Original & X-References..

VALEO	593287	593499
	2809019	2809020
CARGO	232199	
TRANSPO	MER1920	

12820100 / VAL103



FEATURES

Diodes: 6-50 Ampere
 Diameter OD: 115mm
 With Trio
 Without Capacitor
 For use on: Renault

Original & X-References..

HUCO	139668
J&N ELECTRIC	172-40036
LANDMAN B.V.	M8060
LECLERCQ	009-0232
LUCAS	21224163
SWS	PR114017
TRANSPO	IPR103

12820200 / VAL135



FEATURES

Diodes: 6-50 Ampere
 Diameter OD: 115mm
 With Capacitor
 Without Trio
 For use on: Renault, Toro, Winnebago

Original & X-References..

VALEO	A103543A
	A180593A NC145
MOBLIETRON	RP-01
WAI	31-9421
CARGO	131228
TRANSPO	IPR135

12820300 / VAL157



FEATURES

Diodes: 6-50 Ampere
 Diameter OD: 115mm
 Without Capacitor
 Without Trio
 For use on: Renault Alliance, 18I Fuego

Original & X-References..

VALEO	105135/54
	NC133 NC216
MOBLIETRON	RP-03
TRANSPO	IPR157

**12820600 / VAL252****FEATURES**

Diodes: 6-50 Ampere
 Diameter OD: 115mm
 With Capacitor
 Without Trio
 Live "W" Circuit
 For use on: Renault

Original & X-References..

VALEO	105690
A523707A	A523724A NC141
MOBLIETRON	RP-07
WAI	31-9442
CARGO	132985
TRANSPO	IPR252

**12820400 / VAL253****FEATURES**

Diodes: 6-50 Ampere
 Diameter OD: 115mm
 With Capacitor
 Without Trio
 Live "W" Circuit

Original & X-References..

PARISPHONE	A13N230
------------	---------

**12820500 / VAL537****FEATURES**

Diodes: 6-50 Ampere
 Diameter OD: 115mm
 With Capacitor
 With Trio
 For use on: Citroen, fiat, peugeot

Original & X-References..

VALEO	592595
	A180537A
	NC144
MOBILETRON	MFRX03782
	RP-04H
TRANSPO	IPR537

**12820800 / VAL538****FEATURES**

Diodes: 6-50 Ampere
 Diameter OD: 115mm
 With Capacitor
 With Trio
 For use on: Peugeot 205, Renault R25

Original & X-References..

VALEO	592747	592749
	NC976	
WAI	31-9434	
CARGO	133882	
TRANSPO	IPR747	

**12820710 / VAL539****FEATURES**

Diodes: 6-50 Ampere
 Diameter OD: 115mm
 With Capacitor
 Without Trio
 For use on: AMC, Peugeot, Renault

Original & X-References..

VALEO	A105901A
	NC139 NC936
LUCAS	21225388
MOBLIETRON	RP-03
WAI	31-9402
CARGO	133689
TRANSPO	IPR539

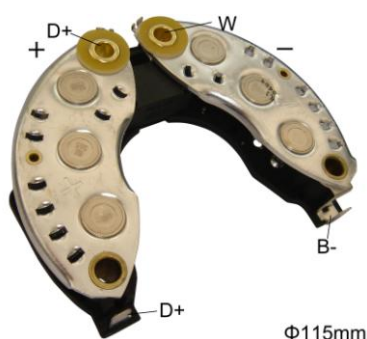

12821300 / VAL551

FEATURES

Diodes: 6-50 Ampere
 Diameter OD: 115mm
 With Capacitor
 With Trio
 Live "W" Circuit

For use on: Volvo Penta

Original & X-References..

VALEO	103551/54
	A523726A
	NC135 NC730
LUCAS	21225388
MOBLIETRON	RP-02
WAI	31-9403
CARGO	131701
TRANSPO	IPR551



12821100 / VAL615

FEATURES

Diodes: 6-50 Ampere
 Diameter OD: 115mm
 With Capacitor
 Without Trio

Original & X-References..

VALEO	106016/28
	NC143 104247
WAI	31-9414
CARGO	131573
TRANSPO	IPR615



12821200 / VAL616

FEATURES

Diodes: 6-50 Ampere
 Diameter OD: 115mm
 With Capacitor
 With Trio

Original & X-References..

VALEO	A103543A
	A180593A
	NC145
WAI	31-9421
CARGO	131228
TRANSPO	IPR135

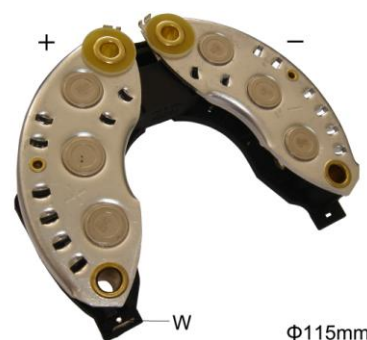

12821000 / VAL687

FEATURES

Diodes: 6-50 Ampere
 Diameter OD: 115mm
 With Capacitor
 With Trio

Original & X-References..

PARISPHONE	A13N269
------------	---------



12821600 / VAL688

FEATURES

Diodes: 6-50 Ampere
 Diameter OD: 115mm
 With Capacitor
 With Trio
 For use on: Peugeot, Renault, Saab

Original & X-References..

VALEO	592596	NC138
LUCAS	21225400	UBB240
MOBLIETRON	RP-04	
WAI	31-9413	
CARGO	131164	
TRANSPO	IPR203	



12821700 / VAL713

FEATURES

Diodes: 6-50 Ampere
 Diameter OD: 115mm
 With Capacitor
 With Trio

For use on: Porsche

Original & X-References..

VALEO	101713	210303
MOBLIETRON	RP-05H	
WAI	31-9405	31-9405-1
CARGO	133687	
TRANSPO	IPR713	



12821800 / VAL773

FEATURES

Diodes: 6-50 Ampere
 Diameter OD: 115mm
 Without Capacitor
 With Trio
 With 82 Ohm Resistor
 For use on: Peugeot Diesel

Original & X-References..

103546/54		
VALEO	NC134	NC217
MOBILETRON	RP-04R	
WAI	31-9401	
CARGO	131569	
TRANSPO	IPR773	



12820900 / VAL813

FEATURES

Diodes: 6-50 Ampere
 Diameter OD: 115mm
 With Capacitor
 With Trio
 With 82 Ohm Resistor

12822000 / VAL813-2

With 200 Ohm Resistor
 For use on: Peugeot

Original & X-References..

VALEO	A521404A	NC142
MOBLIETRON	RP-09R	
WAI	31-9430	
CARGO	133741	
TRANSPO	IPR813	

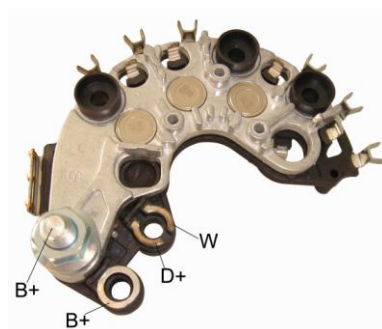

12800300 / VAL201H

FEATURES

Diodes: 3-50 A Avalanche
 With (M8+M6)×44.5mm Battery Post
 With Trio
 Without negative heat sink as VAL201

Original & X-References..

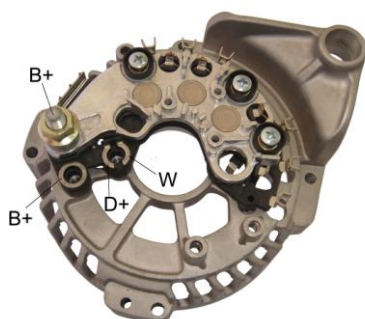

12800100 / VAL201

FEATURES

Diodes: 6-50A Avalanche
 With (M8+M6)×44.5mm Battery Post
 With M5×25mm Mounting Bolt
 With Trio

Original & X-References..

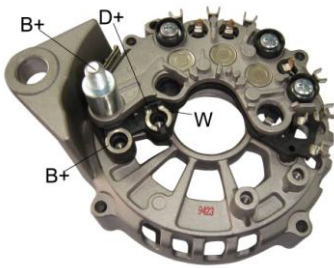

12808100 / VAL216

FEATURES

Diodes : 6-50A Avalanche
 With (M8+M6) ×51.5mm Battery Post
 With M5×25mm Mounting Bolt
 With Trio

Original & X-References..

Customer provide Negative heat sink

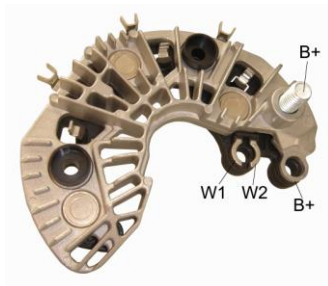

12801800 / VAL202H

FEATURES

Diodes: 3-60 A Avalanche
 With M8×30mm Battery Post
 Without Trio

Original & X-References..

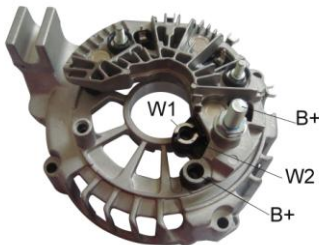

1280AP00 / VAL9015A

FEATURES

Diodes:6-60A Avalanche
 With M8×35mm Battery Post
 With M5×36.5mm Mounting Bolt
 Without Trio

Original & X-References..

TRANSP0 MER5235

Customer provide Negative heat sink



1280AY00 / VAL9021A

FEATURES

Diodes: 6-60A Avalanche
 With M8×30mm Battery Post
 With M5×36.5mm Mounting Bolt

Original & X-References..

Customer provide Negative heat sink



1280B500 / VAL9026A

FEATURES

Diodes: 6-50A Avalanche
 With M8×35mm Battery Post
 With M5×36.5mm Mounting Bolt

Original & X-References..

Customer provide Negative heat sink

**1280BE00 / VAL9032A****FEATURES**

Diodes: 6-80A Avalanche
 With M8×32mm Battery Post
 With M5×36.5mm Mounting Bolt

Original & X-References..

VALEO 593899

Customer provide Negative heat sink

**1280CT00 / VAL9072A****FEATURES**

Diodes: 6-50A Avalanche
 With M8×32mm Battery Post
 With M5×36.5mm Mounting Bolt

Original & X-References..

VALEO TG15C059
 TG15C091
 TG15C125

Custom provide Negative heat sink

**1280D100 / VAL9078A****FEATURES**

Diodes: 6-80A Avalanche
 With M8×32mm Battery Post
 With M5×36.5mm Mounting Post

Original & X-References..

VA0046
 VALEO TG17C041

Customer provide Negative heat sink

**1280D200 / VAL9079A****FEATURES**

Diodes: 6-60A Avalanche
 With M8×32mm Battery Post
 With M5×36.5mm Mounting Post

Original & X-References..

VALEO TG14C011

Customer provide Negative heat sink

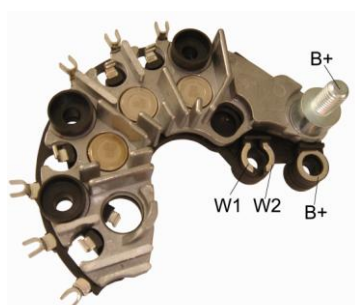
**12802300 / VAL205H****FEATURES**

Diodes: 3-50 A Avalanche
 Without Trio
 With (M8+M6)×44.5mm Battery Post
 Without negative heat sink as **VAL205**

Original & X-References..

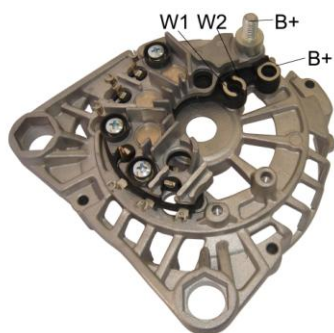

12802000 / VAL205

FEATURES

Diodes: 6-50A Avalanche
 With (M8+M6)×44.5mm Battery Post
 With M5×25mm Mounting Bolt

Original & X-References..

Customer provide Negative heat sink

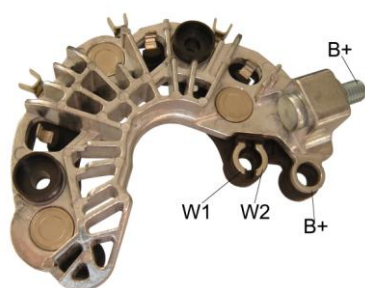

12803200 / VAL206H

FEATURES

Diodes: 3-50 A Avalanche
 Without Trio
 With M8×30mm Battery Post
 Without negative heat sink as VAL206

Original & X-References..

CARGO 332114

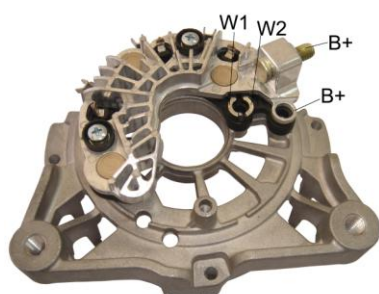

12802400 / VAL206

FEATURES

Diodes: 6-50A Avalanche
 With M8×30mm Battery Post
 With M5×25mm Mounting Bolt

Original & X-References..



12802700 / VAL206A

FEATURES

Diodes: 6-50A Avalanche
 With M8×30mm Battery Post
 With M5×36.5mm Mounting Post

Original & X-References..

Customer provide Negative heat sink

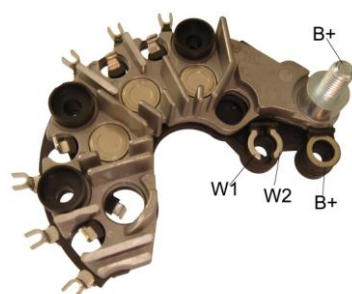

12804300 / VAL208H

FEATURES

Diodes: 3-60 A Avalanche
 Without Trio
 With (M8+M6)×44.5mm Battery Post
 Without negative heat sink as VAL208

Original & X-References..

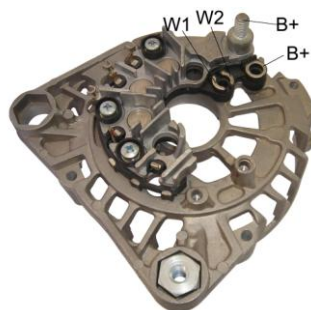
**12803900 / VAL208****FEATURES**

Diodes: 6-60A Avalanche
 With (M8+M6)×44.5mm Battery Post
 With M5×25mm Mounting Bolt

Original & X-References..

CARGO 233615

Customer provide Negative heat sink

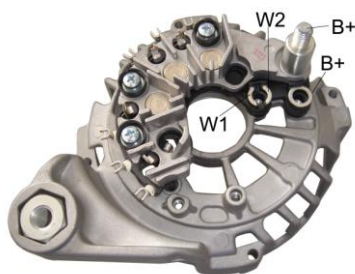
**12804600 / VAL209-2****FEATURES**

Diodes : 6-50A Avalanche
 With (M8+M6) ×51.5mm Battery Post
 With M5×25mm Mounting Bolt

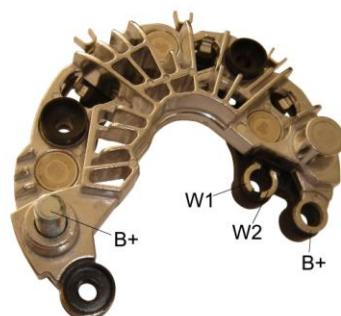
Original & X-References..**12805600 / VAL212H****FEATURES**

Diodes: 3-50 A Avalanche
 Without Trio
 With M8×34.5mm Battery Post
 Without negative heat sink as VAL212

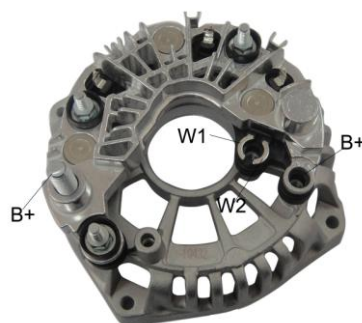
Original & X-References..**12805400 / VAL212****FEATURES**

Diodes: 6-50 A Avalanche
 With M8×34.5mm Battery Post
 With M5×36.5mm Mounting Bolt
 Without Trio

Original & X-References..

Customer provide Negative heat sink

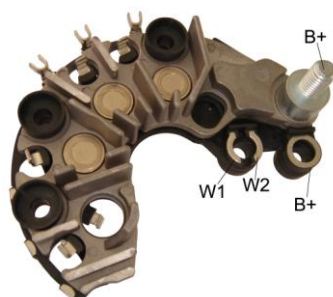
**12806000 / VAL213H****FEATURES**

Diodes: 3-60 A Avalanche
 With (M8+M6)×44.5mm Battery Post
 Without Trio
 Without negative heat sink as VAL213

Original & X-References..

RES08931

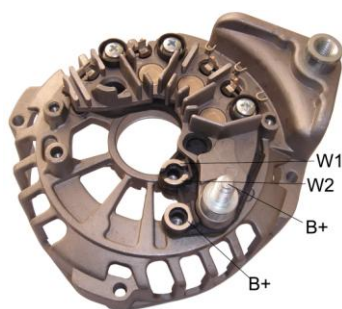

12805800 / VAL213

FEATURES

Diodes: 6-60A Avalanche
 With (M8+M6) ×44.5 mm Battery Post
 With M5 ×25mm Mounting Bolt

Original & X-References..

Customer provide Negative heat sink



1280BT00 / VAL9042A

FEATURES

Diodes: 6-60A Avalanche
 With (M8+M6) ×44.5mm Battery Post
 With M5 ×25mm Mounting Bolt

Original & X-References..

Customer provide Negative heat sink

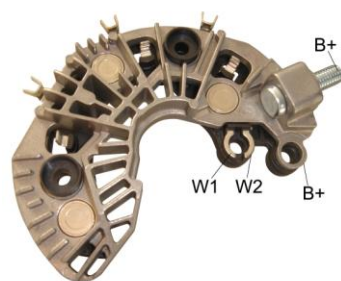

12806700 / VAL214H

FEATURES

Diodes: 3-60 A Avalanche
 Without Trio
 With M8 ×33.3mm Battery Post
 Without negative heat sink as VAL214

Original & X-References..

SG 15S021
 CA 1509IR
 CARGO 235654

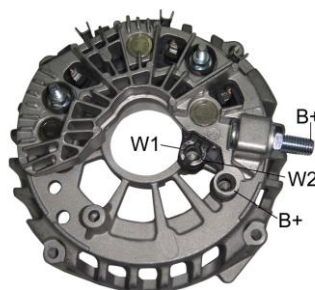

1280B600 / VAL9027A

FEATURES

Diodes:6-50A Avalanche
 With M8 ×35mm Battery Post
 With M5 ×36.5mm Mounting Bolt
 Without Trio

Original & X-References..

Customer provide Negative heat sink



1280C800 / VAL9058A

FEATURES

Diodes: 6-60A Avalanche
 With M8 ×33.3mm Battery Post

Original & X-References..

Customer provide Negative heat sink

**1280AT00 / VAL9018H****FEATURES**

Diodes:3-50A Avalanche
 With M8×40mm Battery Post
 Without Trio

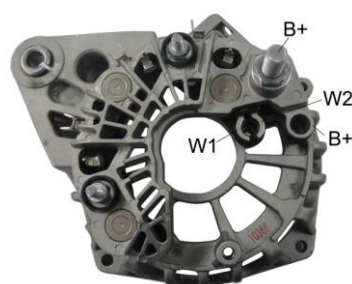
Original & X-References..**12807000 / VAL215-2****FEATURES**

Diodes:6-50A Avalanche
 With M8×40mm Battery Post

Original & X-References..

TRANSPO	MER523
VALEO	2600172

Customer provide Negative heat sink

**1280AA00 / VAL9005A****FEATURES**

Diodes:6-50A Avalanche
 With M8×34.5mm Battery Post
 With M5×36.5mm Mounting Bolt
 Without Trio

Original & X-References..

Customer provide Negative heat sink

**1280B200 / VAL9024A****FEATURES**

Diodes:6-50A Avalanche
 With M8×34.5mm Battery Post
 With M5×36.5mm Mounting Bolt
 Without Trio

Original & X-References..

Customer provide Negative heat sink

**1280C200 / VAL9050A****FEATURES**

Diodes: 6-50A Avalanche
 With M8×40mm Battery Post
 With M5×36.5mm Mounting Bolt

Original & X-References..

Customer provide Negative heat sink

**1280CN00 / VAL9069A****FEATURES**

Diodes: 6-50A Avalanche
 With M8×40mm Battery Post
 With M5×36.5mm Mounting Bolt

Original & X-References..

VALEO A0002655009
 LESTER 11014
 WAI 11014N

Customer provide Negative heat sink

**1280D000 / VAL9077A****FEATURES**

Diodes: 6-50A Avalanche
 With M8×34.5mm Battery Post
 With M5×36.5mm Mounting Post

Original & X-References..

TRANSPO MER5247

Customer provide Negative heat sink

**1280FQ00****FEATURES**

Diodes: 6-50 A Avalanche
 With M8×40mm Battery Post
 With M5×36.5mm Mounting Post

Original & X-References..

VALEO 2655103
 KIA 37300-2A010

Customer provide Negative heat sink

**12808900 / VAL218H****FEATURES**

Diodes:3-50 A Avalanche
 With (M8+M6)×44.5mm Battery Post
 Without Trio

Original & X-References..

Without negative heat sink as VAL218

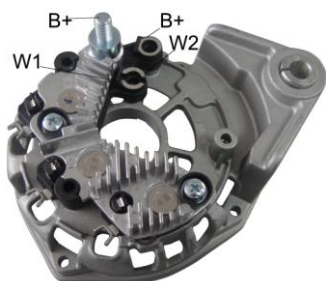
**12808600 / VAL218****FEATURES**

Diodes : 6-50A Avalanche
 With (M8+M6) ×44.5mm Battery Post
 With M5×25mm Mounting Bolt

Original & X-References..

VALEO SG7S012

Customer provide Negative heat sink

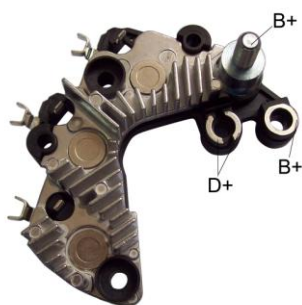

12805100 / VAL211H

FEATURES

Diodes: 3-50 A Avalanche
 With (M8+M6) ×53mm Battery Post
 With Trio

Original & X-References..

Without negative heat sink as VAL211



12804900 / VAL211

FEATURES

Diodes : 6-50A Avalanche
 With (M8+M6) ×53mm Battery Post
 With M5 ×25mm Mounting Bolt
 With Trio

Original & X-References..

Customer provide Negative heat sink

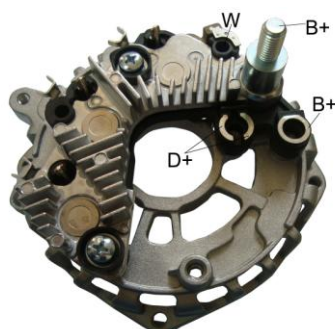

1280A100 / VAL225

FEATURES

Diodes:6-50A Avalanche
 With (M8+M6) ×53mm Battery Post
 With Trio

Original & X-References..

Customer provide Negative heat sink



1280BR00 / VAL9040A

FEATURES

Diodes: 6-50A Avalanche
 With M6 ×47.5mm Battery Post
 With M5 ×25mm Mounting Bolt
 With Trio

Original & X-References..

Customer provide Negative heat sink



12809900 / VAL223H

FEATURES

Diodes : 3-50A Avalanche
 With M6 ×34.5mm Battery Post
 Without Trio

Original & X-References..

Without negative heat sink as VAL223

**12809600 / VAL223****FEATURES**

Diodes : 6-50A Avalanche
 With M6×34.5mm Battery Post
 With M5×36.5mm Mounting Bolt
 Without Trio

Original & X-References..

VALEO TG9C013

Customer provide Negative heat sink

**1280BW00 / VAL9045A****FEATURES**

Diodes: 6-50A Avalanche
 With M6×34.5mm Battery Post
 With M5×36.5mm Mounting Bolt

Original & X-References..

Customer provide Negative heat sink

**1280A500 / VAL230****FEATURES**

Diodes:6-50A Avalanche
 With M8×35mm Battery Post
 With M5×36.5mm Mounting Bolt
 Without Trio

Original & X-References..

VALEO 2650237
 TRANSPO MER524

Customer provide Negative heat sink

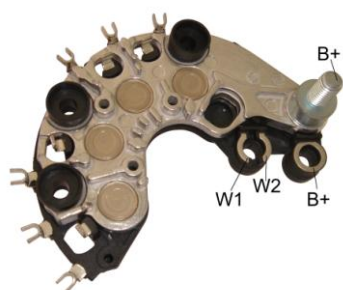
**1280B900 / VAL902H****FEATURES**

Diodes: 4-50 A Avalanche
 Without Trio
 With (M8+M6)×44.5mm Battery Post
 Without negative heat sink as
VAL902-2

Original & X-References..**1280AZ00 / VAL902-2****FEATURES**

Diodes : 8-50A Avalanche
 With (M8+M6) ×44.5mm Battery Post
 With M5×25 mm Mounting Bolt
 Without Trio

Original & X-References..

VALEO SG12B019

Customer provide Negative heat sink

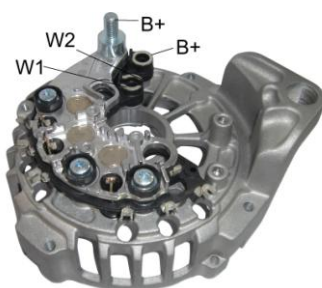

1280C100 / VAL905

FEATURES

Diodes : 6-50A Avalanche
 With (M8+M6) ×44.5mm Battery Post
 With M5×23mm Mounting Bolt

Original & X-References..

Customer provide Negative heat sink



1280CE00 / VAL906-1

FEATURES

Diodes:6-50A Avalanche
 With(M8+M6)×41.5mm Battery Post
 Without Trio

Original & X-References..

VALEO	SG913037
-------	----------

Customer provide Negative heat sink



1280CH00 / VAL9063A

FEATURES

Diodes: 6-50A Avalanche
 With (M8+M6) ×44.5mm Battery Post
 With M5×25mm Mounting Bolt

Original & X-References..

VALEO	SG12S073
LESTER	11050
WAI	11050N

Customer provide Negative heat sink

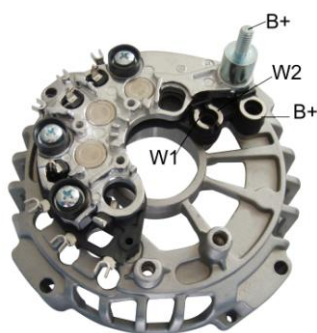

1280AN00 / VAL9014A

FEATURES

Diodes:6-50A Avalanche
 With (M6+M6) ×47.5mm Battery Post
 Without Trio

Original & X-References..

Customer provide Negative heat sink



1280BS00 / VAL9041A

FEATURES

Diodes: 8-50A Avalanche
 With (M8+M6) ×44.5mm Battery Post
 With M5×25mm Mounting Bolt

Original & X-References..

Customer provide Negative heat sink



1280BY00 / VAL9047A

FEATURES

Diodes: 8-50A Avalanche
 With (M8+M6) ×44.5mm Battery Post
 With M5×25mm Mounting Bolt

Original & X-References..

Customer provide Negative heat sink

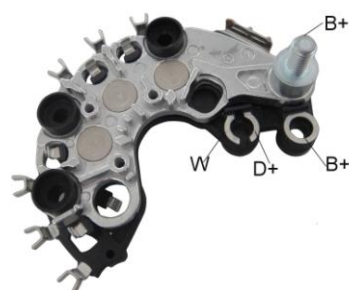

1280BN00 / VAL903H

FEATURES

Diodes : 3-50A Avalanche
 With (M8+M6) ×44.5mm Battery Post
 With Trio

Original & X-References..

VALEO	2547906
	593463
TRANSPO	MER528

Without negative heat sink as VAL903

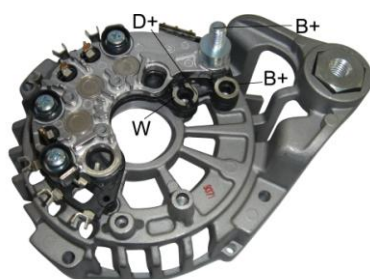

1280BB00 / VAL903

FEATURES

Diodes : 6-50A Avalanche
 With (M8+M6) ×44.5mm Battery Post
 With M5×25mm Mounting Bolt
 With Trio

Original & X-References..

VALEO	2547906
	593463
CARGO	235652
TRANSPO	MER528



1280AD00 / VAL928H

FEATURES

Diodes: 3-50A Avalanche
 With (M8+M6)×44.5mm Battery Post
 Witout Trio

Original & X-References..

Without negative heat sink as VAL928

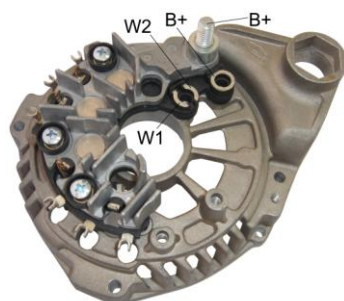

1280DJ00 / VAL927

FEATURES

Diodes: 6-50A Avalanche
 With (M8+M6)×44.5mm Battery Post
 With M5×25mm Mounting Bolt

Original & X-References..

VALEO	SG14B019
	SG14B020
	2549502-M2
LESTER	13970
TRANSPO	MER538

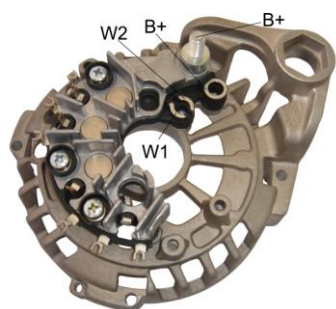

1280DT00 / VAL928

FEATURES

Diodes: 6-50A Avalanche
 With (M8+M6) ×44.5mm Battery Post
 With M5×25mm Mounting Bolt

Original & X-References..



1280B100 / VAL9023A

FEATURES

Diodes:6-50A Avalanche
 With (M8+M6) ×44.5mm Battery Post
 With M5×25mm Mounting Bolt
 Without Trio

Original & X-References..

Customer provide Negative heat sink

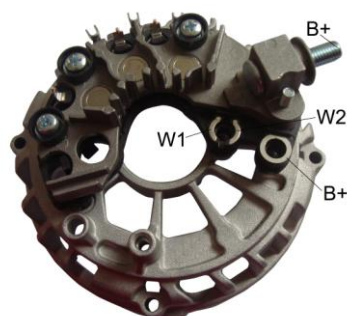

1280AQ00 / VAL9016A

FEATURES

Diodes:6-50A Avalanche
 With M8×35mm Battery Post
 Without Trio

Original & X-References..

Customer provide Negative heat sink

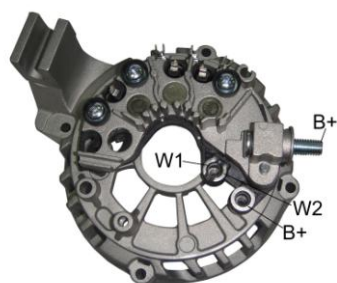

1280B800 / VAL9029A

FEATURES

Diodes:6-50A Avalanche
 With M8×35mm Battery Post
 With M5×25mm Mounting Bolt
 Without Trio

Original & X-References..

Customer provide Negative heat sink



1280C000 / VAL9049A

FEATURES

Diodes: 6-50A Avalanche
 With M8×35mm Battery Post
 With M5×25mm Mounting Bolt

Original & X-References..

VALEO	SG12S084
LESTER	13938
TRANSPO	MER5202

Customer provide Negative heat sink

1280CV00 / VAL9074A**FEATURES**

Diodes: 6-50A Avalanche
With M8×35mm Battery Post
With M5×25mm Mounting Post

Customer provide Negative heat sink

For use on: (2007-01) Buick, Chevrolet,
Oldsmobile, Pontiac

Original & X-References..

VALEO 2542454A, 2542559A,
2650011, 2650017,
2650132A, SG12S056,
SG12S057, SG12S071,
SG12S074, SG12S075,
SG12S083, SG12S104
LESTER 13866, 13943
TRANSP0 MER5204

1280CD00 / VAL9060AH**FEATURES**

Diodes: 3-50A Avalanche
With (M8+M6) ×44.5mm Battery Post
Without Trio

Original & X-References..**1280CK00 / VAL9066AH****FEATURES**

Diodes: 4-50A Avalanche
With Trio
With (M8+M6) ×44.5mm Battery Post

Original & X-References..**1280CQ00 / VAL9070A****FEATURES**

Diodes: 6-50A Avalanche
With M8×35.5mm Battery Post
With M5×36.5mm Mounting Post

Customer provide Negative heat sink

Original & X-References..

TRANSP0 MER5225

1280CX00 / VAL9075A**FEATURES**

Diodes: 6-50 A Avalanche
With (M6+M6) ×47.5mm Battery Post

Customer provide Negative heat sink

Original & X-References..



1280D600 / VAL9083A

FEATURES

Diodes: 6-50 A Avalanche
 With M8×36mm Battery Post
 With M5×36.5mm Mounting Bolt
 Without Trio

Original & X-References..

LESTER	11069
TRANSPO	MER5246

Customer Provide Negative heat sink



1280DD00 / VAL9091A

FEATURES

Diodes: 6-50AAvalanche
 With M8×35.5mm Battery Post
 With M5×36.5mm Mounting Bolt
 Without Trio

Original & X-References..

Customer provide Negative heat sink



12850800

FEATURES

Diodes: 6-50AAvalanche
 With M8×32mm Battery Post
 Without Trio

Original & X-References..

LESTER	20091
TRANSPO	MER530

DISH DIODES**7430****FEATURES**

Diode: POSITIVE, 25Ampere , 300V

Dim(mm): 8.4OD

Lead(mm): 1.5Dia x20L

Original & X-References...

A.I.M.	AT-0749DP
ACE-ELECTRIC	S4305
CPC	ADSG-9P
GAP INT.LTD.	GP9172
HUCO	139419
RAYLOC	01-040-022-0037
CARGO	131509
TRANSP0	7220

7430ADiode: POSITIVE, 25A Avalanche,
24-32V**7431****FEATURES**

Diode: NEGATIVE, 25Ampere , 300V

Dim(mm): 8.4OD

Lead(mm): 1.5Dia x20L

Original & X-References...

A.I.M.	AT-0749DN
ACE-ELECTRIC	S4306
CPC	ADSG-9N
GAP INT.LTD.	GP9171
HUCO	139418
RAYLOC	01-040-022-0038
CARGO	131508
TRANSP0	7221

7431ADiode: NEGATIVE, 25A Avalanche,
24-32V**7432****FEATURES**

Diode: POSITIVE, 35Ampere , 300V

Dim(mm): 9.7OD

Lead(mm):1.5Dia x20L

Original & X-References...

A.I.M.	AT-0787DP
ACE-ELECTRIC	S4307

CPC	ADSG-9LP
GAP INT.LTD.	GP9170
HUCO	139421
CARGO	131511
TRANSP0	7230

7433**FEATURES**

Diode: NEGATIVE,35Ampere , 300V

Dim(mm): 9.7OD

Lead(mm): 1.5Dia x20L

Original & X-References...

A.I.M.	AT-0787DN
ACE-ELECTRIC	S4308
CPC	ADSG-9LN
GAP INT.LTD.	GP9169
HUCO	139420
CARGO	131510
TRANSP0	7231

CAN DIODES**7650****FEATURES**

Diode: POSITIVE, 25Ampere , 300V

Dim(mm): 8.8OD 5/16"

Lead(mm): 1.5Dia x24.6L

Original & X-References...

JUST PAPTS	F1-1460P R
MOBILETRON	MFDD00061
	DD-1011
SOLID STATE	DF7650
WAI	32-702-1
CARGO	131507
TRANSP0	8524

7651**FEATURES**

Diode: NEGATIVE, 25Ampere , 300V

Dim(mm): 8.8OD 5/16"

Lead(mm): 1.5Dia x24.6L

Original & X-References...

MOBILETRON	MFDD00051
	DD-1010
WAI	32-701-1
CARGO	131507
TRANSP0	8525

**7652****FEATURES**

Diode: POSITIVE, 25Ampere , 300V

Dim(mm): 8.8OD 5/16"

Lead(mm): Fork

Original & X-References...

RENARD	7652
SAS COMPONENTS	9922
WAGNER	W04X-30
WAI	32-724
CARGO	131512
TRANSP0	8534

7653**FEATURES**

Diode: NEGATIVE, 25Ampere , 300V

Dim(mm): 8.8OD 5/16"

Lead(mm): Fork

Original & X-References...

RENARD	7653
WAGNER	W04X-31
WAI	32-723
WIEGEL	DIOUN800021
CARGO	131513
TRANSP0	8535

BLOCK DIODES**DB8330****FEATURES**

Diode: POSITIVE, 30Ampere , 200V

Original & X-References...

SAS COMPONENTS	7664
WAI	32-8300
CARGO	133704
TRANSPO	8330

DB8331**FEATURES**

Diode: NEGATIVE, 30Ampere , 200V

Original & X-References...

SAS COMPONENTS	7665
WAI	32-8301
TRANSPO	8331
CARGO	133705

DB8334**FEATURES**

Diode: POSITIVE, 35Ampere , 200V

Original & X-References...

WAI	32-8303
WIEGEL	DIOUN800015
TRANSPO	8334

DB8335**FEATURES**

Diode: NEGATIVE, 35Ampere , 200V

Original & X-References...

WAI	32-8304
WIEGEL	DIOUN800016
TRANSPO	8335

BUTTON DIODES**DB001****FEATURES**

Diode: 25Ampere , 200V

Dim(mm): 8.5OD×6T

Original & X-References...

A.I.M	AD-704D	
ACE-ELECTRIC	S4301	
CPC	ADME-009	DME-009
HUCO	13 9427	
IPM	1A-1462	
WAI	32-734	
TRANSPO	8125	

DB002**FEATURES**

Diode: 35A Avalanche , 24-32V

Dim(mm): 10OD×6T

Original & X-References...

WAI	32-731
WIEGEL	DIOUN800009
TRANSPO	8135

DB003**FEATURES**

Diode: 50Ampere , 200V

Dim(mm): 10OD×6T

Original & X-References...

AMSCO	D2-25
HUCO	13 9422
JUST PARTS	D11463HD
LECLERCQ	009-0095
RENARD	7620
SAS COMPONENTS	1132
WAI	32-735
TRANSPO	8150

DB004**FEATURES**

Diode: 50A Avalanche , 24-32V

Dim(mm): 10OD×6T

TRANSPO	8153
---------	------

AXIAL LEAD DIODES**IN8010****FEATURES**

Diode: 1.0 Ampere , 200V

Original & X-References...

A.I.M	AD-0713D
CARGO	130937
CPC	ADME-0111
J&N ELECTRIC	171-01000
JUST PARTS	D11472
TRANSPO	8010

IN8015**FEATURES**

Diode: 1.5 Ampere , 200V

Original & X-References...

A.I.M	AD-0713D1.5
CPC	ADME-011
J&N ELECTRIC	171-01001
RENARD	7500
WAI	32-8904
WIEGEL	DIOUN800005
TRANSPO	8015

IN8025**FEATURES**

Diode: 2.5 Ampere , 200V

Original & X-References...

RENARD	7502
WAI	32-8908
WIEGEL	DIOUN800006
TRANSPO	8025

IN8030**FEATURES**

Diode: 3.0 Ampere , 200V

Original & X-References...

CARGO	131294
DELCO	1964187
J&N ELECTRIC	171-01002
LECLERCQ	009-0396
WAI	32-8905
SAS COMPONENTS	1088
TRANSPO	8030

STUD MOUNT DIODES



QZ2540

FEATURES

Diode: POSITIVE, 25Ampere , 400V
Stud: 1/4"-28

QZ2541

FEATURES

Diode: NEGATIVE, 25Ampere , 400V
Stud: 1/4"-28

QZ5040

FEATURES

Diode: POSITIVE, 50Ampere , 400V
Stud: 1/4"-28

QZ5041

FEATURES

Diode: NEGATIVE, 50Ampere , 400V
Stud: 1/4"-28

QZ7540

FEATURES

Diode: POSITIVE, 70Ampere , 400V
Stud: 1/4"-28

Original & X-References...

CARGO	133495
LECLERCQ	009-0097
WAI	32-769
TRANSP0	1120

QZ7541

FEATURES

Diode: NEGATIVE, 75Ampere , 400V
Stud: 1/4"-28

Original & X-References...

J&N ELECTRIC	171-06001
WAI	32-768
TRANSP0	1120-R

DELCO TRIOS



14D01300 / DJ1001

FEATURES

DIODE TRIO DR 27SI
For use on: Delco 27SI, Type 100/200
Alternators

Original & X-References...

A.I.M	AO-0727D
ACE-ELECTRIC	S2201
AES	92
AMC	801817 830891
AMSCO	DA-5
BWD	SC116



14D00400 / DJ524

FEATURES

DIODE TRIO DR 11SI
Orange Case
For use on: European & South American
Vehicles With Delco 11 SI Alternators

Original & X-References...

CARGO	130674	132611
CPC	ARDE-112	
DELCO	1984032	3472312
	7982635	DR3901
FILKO	131ZT	
GAPINT.LTD.		GP210
TRANSP0		DET524



14D00800 / DJ527

FEATURES

DIODE TRIO DR 10SI
Orange Case
For use on: Delco 10 , 12 , 15 , 17SI
Alternators

Original & X-References...

A.I.M	AO-0710D
ACE-ELECTRIC	S1390
AES	91
AMSCO	DA-109
ATP	DR10T
CATERPILLAR	9N 1202
CPC	ATDE-690
TRANSP0	D527



14D00300 / DJ528

FEATURES

DIODE TRIO DR 10SI
Black Case
For use on: Delco 10 , 12 , 15 , 17SI
Alternators

Original & X-References...

A.I.M	AO-0710D
ACE-ELECTRIC	S1390
AES	91
AMSCO	DA-109
ATP	DR10T
CATERPILLAR	9N 1202
CPC	ATDE-690
TRANSP0	D528



14D01200 / DJ797

FEATURES

DIODE TRIO DR 30SI

For use on: Delco 30SI Alternators

Original & X-References...

A.I.M	AO-0730D
ACE-ELECTRIC	S2245
AMSCO	DA-5T
BWD	SC228
CARGO	131416
DELCO	10456389 1876797
ECHLIN	AC 63
TRANSPO	D797

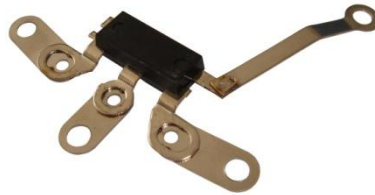

14D00700 / DT182

FEATURES

DIODE TRIO DR 33SI

For use on: Industrial, Agricultural ,
Delco 321-734, 10459114

Original & X-References...

DELCO	10491182
J&N ELECTRIC	171-12106
WAI	33-109
TRANSPO	DT182



14D01400 / LJ79026

FEATURES

Diode: 1A , 200V

For use on: Leece Neville 4400-4700J,
7000-7700J Alternators

Original & X-References...

A.I.M	AX-0705D
ACE-ELECTRIC	S1427
AMSCO	LN-193
JUST PARTS	LN11487
WAI	33-502
TRANSPO	L79026



14D01801 / DJ985

FEATURES

DIODE TRIO DR 21SI

For use on: Delco 17& 21SI Alternators

Original & X-References...

A.I.M	AO-0717D
ACE-ELECTRIC	S1662
AEC	94
AMSCO	DA-234
CARGO	131897
DELCO	1988985 D3927
TRANSPO	D985



14D01100 / DT182-1

FEATURES

DIODE TRIO DR 33SI

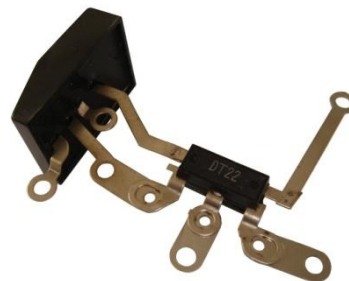

14D01000 / DT22

FEATURES

DIODE TRIO DR 22SI

With Quick-Start Circuit

For use on: Delco 22SI Alternators

Original & X-References...

DELCO	10487805
J&N ELECTRIC	171-12103
LECLERCO	009-0528
WAGNER	D04-08
WAI	33-108
TRANSPO	DT22



14D00500 / LJ79027

FEATURES

Diode: 1A, 200V

For use on: Leece Neville 2300-2800JB
Alternators

Original & X-References...

AES	1054
AMSCO	LN-191
WAI	33-500
TRANSPO	L79027

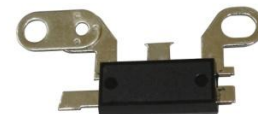

14D01900 / S5231

FEATURES

Diode: 3A , 800V



SJ5231

FEATURES

Diode: 3A, 800V



14D00600 / SJ5260

FEATURES

DIODE TRIO DR 21SI

Original & X-References...

CARGO 233201

PRESS-FIT OJ DIODE



BN354P

FEATURES

Diode: POSITIVE, 35Ampere, 300V
Dim(mm): 12.80(1/2")OD
Lead(mm): 1.3Dia×23L

BN354N

FEATURES

Diode: NEGATIVE, 35Ampere, 300V
Dim(mm): 12.80(1/2")OD
Lead(mm): 1.3Dia×23L

BN35LP

FEATURES

Diode: POSITIVE, 35Ampere,
19-24V Avalanche
Dim(mm): 12.80(1/2")OD
Lead(mm): 1.3Dia×23L

BN35LN

FEATURES

Diode: NEGATIVE, 35Ampere,
19-24V Avalanche
Dim(mm): 12.80(1/2")OD
Lead(mm): 1.3Dia×23L

BN35MP

FEATURES

Diode: POSITIVE, 35Ampere,
24-32V Avalanche
Dim(mm): 12.80(1/2")OD
Lead(mm): 1.3Dia×23L

BN35MN

FEATURES

Diode: NEGATIVE, 35Ampere,
24-32V Avalanche
Dim(mm): 12.80(1/2")OD
Lead(mm): 1.3Dia×23L

BN35HP

FEATURES

Diode: POSITIVE, 35Ampere,
34-42V Avalanche
Dim(mm): 12.80(1/2")OD
Lead(mm): 1.3Dia×23L

BN35HN

FEATURES

Diode: NEGATIVE, 35Ampere,
34-42V Avalanche
Dim(mm): 12.80(1/2")OD
Lead(mm): 1.3Dia×23L

BN504P

FEATURES

Diode: POSITIVE, 50Ampere, 300V
Dim(mm): 12.80(1/2")OD
Lead(mm): 1.3Dia×23L

BN504N

FEATURES

Diode: NEGATIVE, 50Ampere, 300V
Dim(mm): 12.80(1/2")OD
Lead(mm): 1.3Dia×23L

BN50LP

FEATURES

Diode: POSITIVE, 50Ampere,
19-24V Avalanche
Dim(mm): 12.80(1/2")OD
Lead(mm): 1.3Dia×23L

BN50LN

FEATURES

Diode: NEGATIVE, 50Ampere,
19-24V Avalanche
Dim(mm): 12.80(1/2")OD
Lead(mm): 1.3Dia×23L

BN50MP

FEATURES

Diode: POSITIVE, 50Ampere,
24-32V Avalanche
Dim(mm): 12.80(1/2")OD
Lead(mm): 1.3Dia×23L

BN50MN

FEATURES

Diode: NEGATIVE, 50Ampere,
24-32V Avalanche
Dim(mm): 12.80(1/2")OD
Lead(mm): 1.3Dia×23L

BN50HP

FEATURES

Diode: POSITIVE, 50Ampere,
34-42V Avalanche
Dim(mm): 12.80(1/2")OD
Lead(mm): 1.3Dia×23L

BN50HN

FEATURES

Diode: NEGATIVE, 50Ampere,
34-42V Avalanche
Dim(mm): 12.80(1/2")OD
Lead(mm): 1.3Dia×23L

**BN604P****FEATURES**

Diode: POSITIVE, 60Ampere, 300V
 Dim(mm): 12.80(1/2")OD
 Lead(mm): 1.3Dia×23L

BN604N**FEATURES**

Diode: NEGATIVE, 60Ampere, 300V
 Dim(mm): 12.80(1/2")OD
 Lead(mm): 1.3Dia×23L

BN60LP**FEATURES**

Diode: POSITIVE, 60Ampere,
 19-24V Avalanche
 Dim(mm): 12.80(1/2")OD
 Lead(mm): 1.3Dia×23L

BN60LN**FEATURES**

Diode: NEGATIVE, 60Ampere,
 19-24V Avalanche
 Dim(mm): 12.80(1/2")OD
 Lead(mm): 1.3Dia×23L

BN60MP**FEATURES**

Diode: POSITIVE, 60Ampere,
 24-32V Avalanche
 Dim(mm): 12.80(1/2")OD
 Lead(mm): 1.3Dia×23L

BN60MN**FEATURES**

Diode: NEGATIVE, 60Ampere,
 24-32V Avalanche
 Dim(mm): 12.80(1/2")OD
 Lead(mm): 1.3Dia×23L

BN60HP**FEATURES**

Diode: POSITIVE, 60Ampere,
 34-42V Avalanche
 Dim(mm): 12.80(1/2")OD
 Lead(mm): 1.3Dia×23L

BN60HN**FEATURES**

Diode: NEGATIVE, 60Ampere,
 34-42V Avalanche
 Dim(mm): 12.80(1/2")OD
 Lead(mm): 1.3Dia×23L

BN804P**FEATURES**

Diode: POSITIVE, 80Ampere, 300V
 Dim(mm): 12.80(1/2")OD
 Lead(mm): 1.5Dia×23L

BN804N**FEATURES**

Diode: NEGATIVE, 80Ampere, 300V
 Dim(mm): 12.80(1/2")OD
 Lead(mm): 1.5Dia×23L

BN80LP**FEATURES**

Diode: POSITIVE, 80Ampere,
 19-24V Avalanche
 Dim(mm): 12.80(1/2")OD
 Lead(mm): 1.5Dia×23L

BN80LN**FEATURES**

Diode: NEGATIVE, 80Ampere,
 19-24V Avalanche
 Dim(mm): 12.80(1/2")OD
 Lead(mm): 1.5Dia×23L

BN80MP**FEATURES**

Diode: POSITIVE, 80Ampere,
 24-32V Avalanche
 Dim(mm): 12.80(1/2")OD
 Lead(mm): 1.5Dia×23L

BN80MN**FEATURES**

Diode: NEGATIVE, 80Ampere,
 24-32V Avalanche
 Dim(mm): 12.80(1/2")OD
 Lead(mm): 1.5Dia×23L

BN80HP**FEATURES**

Diode: POSITIVE, 80Ampere,
 34-42V Avalanche
 Dim(mm): 12.80(1/2")OD
 Lead(mm): 1.5Dia×23L

BN80HN**FEATURES**

Diode: NEGATIVE, 80Ampere,
 34-42V Avalanche
 Dim(mm): 12.80(1/2")OD
 Lead(mm): 1.5Dia×23L

**RN354P****FEATURES**

Diode: POSITIVE, 35Ampere, 300V
 Dim(mm): 11.80(1/2")OD
 Lead(mm): 1.5Dia×20L

RN354N**FEATURES**

Diode: NEGATIVE, 35Ampere, 300V
 Dim(mm): 11.80(1/2")OD
 Lead(mm): 1.5Dia×20L

RN35LP**FEATURES**

Diode: POSITIVE, 35Ampere,
 19-24V Avalanche
 Dim(mm): 11.80(1/2")OD
 Lead(mm): 1.5Dia×20L

RN35LN**FEATURES**

Diode: NEGATIVE, 35Ampere,
 19-24V Avalanche
 Dim(mm): 11.80(1/2")OD
 Lead(mm): 1.5Dia×20L

RN35MP**FEATURES**

Diode: POSITIVE, 35Ampere,
 24-32V Avalanche
 Dim(mm): 11.80(1/2")OD
 Lead(mm): 1.5Dia×20L

RN35MN**FEATURES**

Diode: NEGATIVE, 35Ampere,
 24-32V Avalanche
 Dim(mm): 11.80(1/2")OD
 Lead(mm): 1.5Dia×20L

RN35HP**FEATURES**

Diode: POSITIVE, 35Ampere,
 34-42V Avalanche
 Dim(mm): 11.80(1/2")OD
 Lead(mm): 1.5Dia×20L

RN35HN**FEATURES**

Diode: NEGATIVE, 35Ampere,
 34-42V Avalanche
 Dim(mm): 11.80(1/2")OD
 Lead(mm): 1.5Dia×20L

RN504P**FEATURES**

Diode: POSITIVE, 50Ampere, 300V
 Dim(mm): 11.80(1/2")OD
 Lead(mm): 1.5Dia×20L

RN504N**FEATURES**

Diode: NEGATIVE, 50Ampere, 300V
 Dim(mm): 11.80(1/2")OD
 Lead(mm): 1.5Dia×20L

RN50LP**FEATURES**

Diode: POSITIVE, 50Ampere,
 19-24V Avalanche
 Dim(mm): 11.80(1/2")OD
 Lead(mm): 1.5Dia×20L

RN50LN**FEATURES**

Diode: NEGATIVE, 50Ampere,
 19-24V Avalanche
 Dim(mm): 11.80(1/2")OD
 Lead(mm): 1.5Dia×23L

RN50MP**FEATURES**

Diode: POSITIVE, 50Ampere,
 24-32V Avalanche
 Dim(mm): 11.80(1/2")OD
 Lead(mm): 1.5Dia×20L

RN50MN**FEATURES**

Diode: NEGATIVE, 50Ampere,
 24-32V Avalanche
 Dim(mm): 11.80(1/2")OD
 Lead(mm): 1.5Dia×20L

RN50HP**FEATURES**

Diode: POSITIVE, 50Ampere,
 34-42V Avalanche
 Dim(mm): 11.80(1/2")OD
 Lead(mm): 1.5Dia×20L

RN50HN**FEATURES**

Diode: NEGATIVE, 50Ampere,
 34-42V Avalanche
 Dim(mm): 11.80(1/2")OD
 Lead(mm): 1.5Dia×20L



QZ3520

FEATURES

Diode: POSITIVE, 35Ampere, 300V
 Dim(mm): 12.75 OD
 Lead(mm): 1.4Dia x29L

QZ3521

FEATURES

Diode: NEGATIVE, 35Ampere, 300V
 Dim(mm): 12.75 OD
 Lead(mm): 1.4Dia x29L



QZ5020

FEATURES

Diode: POSITIVE, 50Ampere, 300V
 Dim(mm): 12.75 OD
 Lead(mm): 2.5Dia x16.2L

QZ5021

FEATURES

Diode: NEGATIVE, 50Ampere, 300V
 Dim(mm): 12.75 OD
 Lead(mm): 2.5Dia x16.2L



S-15B

FEATURES

Diode: POSITIVE, 25Ampere, 300V
 Dim(mm): 11 OD
 Lead(mm): Fork, 2mm x18.5L

S-16B

FEATURES

Diode: NEGATIVE, 25Ampere, 300V
 Dim(mm): 11 OD
 Lead(mm): Fork, 2mm x18.5L



7700

FEATURES

Diode: POSITIVE, 25Ampere, 300V
 Dim(mm): 12.7(1/2")OD
 Lead(mm): 1.5Dia x25L

Original & X-References...

MOBILETRON	DD-1013
NAPA	AC1P
RENARD	7700
TRANSPO	8724

7701

FEATURES

Diode: NEGATIVE, 25Ampere, 300V
 Dim(mm): 12.7(1/2")OD
 Lead(mm): 1.5Dia x25L

Original & X-References...

MOBILETRON	DD-1012
NAPA	AC1N
TRANSPO	8725



7780-B

FEATURES

Diode: POSITIVE, 35Ampere, 300V
 Dim(mm): 12.7 (1/2")OD
 Lead(mm): 1.5Dia x25L

Original & X-References...

MOBILETRON	DD-1015
TRANSPO	8734

7781-B

FEATURES

Diode: NEGATIVE, 35Ampere, 300V
 Dim(mm): 12.7(1/2") OD
 Lead(mm): 1.5Dia x25L

Original & X-References...

MOBILETRON	DD-1014
TRANSPO	8735



7770

FEATURES

Diode: POSITIVE, 50Ampere, 300V
 Dim(mm): 12.7 (1/2")OD
 Lead(mm): 2.5Dia x20.8L

Original & X-References...

WAGNER	W04X-05
WAI	32-755
TRANSPO	8752

7771

FEATURES

Diode: NEGATIVE, 50Ampere, 300V
 Dim(mm): 12.7 (1/2")OD
 Lead(mm): 2.5Dia x20.8L

Original & X-References...

WAI	32-754
TRANSPO	8753



7800

FEATURES

Diode: POSITIVE, 25Ampere, 300V
 Dim(mm): 12.7 (1/2")OD
 Lead(mm): 1.4 Dia×29.3L

7801

FEATURES

Diode: NEGATIVE, 25Ampere, 300V
 Dim(mm): 12.7 (1/2")OD
 Lead(mm): 1.4 Dia×29.3L



7880

FEATURES

Diode: POSITIVE, 35Ampere, 300V
 Dim(mm): 12.7 (1/2")OD
 Lead(mm): 1.4 Dia×29.3L

Original & X-References...

CHRYSLER	3000 047	CH4005
DUBOIS	5003	
TRANSPO	8824	

7881

FEATURES

Diode: NEGATIVE, 35Ampere, 300V
 Dim(mm): 12.7 (1/2")OD
 Lead(mm): 1.4 Dia×29.3L

Original & X-References...

CHRYSLER	3000 046	CH4004
DUBOIS	5004	
TRANSPO	8825	



8624

FEATURES

Diode: POSITIVE, 35Ampere, 300V
 Dim(mm): 13 OD
 Lead(mm): 2Dia×18.5L

Original & X-References...

CARGO	134495
HITACHI	Q06B
WAI	32-8101
TRANSPO	8624

8625

FEATURES

Diode: NEGATIVE, 35Ampere, 300V
 Dim(mm): 13 OD
 Lead(mm): 2Dia×18.5L

Original & X-References...

CARGO	134494
HITACHI	Q05B
WAI	32-8100
TRANSPO	8625



7770-1

FEATURES

Diode: POSITIVE, 50Ampere, 300V
 Dim(mm): 12.7 (1/2")OD
 Lead(mm): 35L

7771-1

FEATURES

Diode: NEGATIVE, 50Ampere, 300V
 Dim(mm): 12.7(1/2") OD
 Lead(mm): 35L



7812

FEATURES

Diode: POSITIVE, 35Ampere, 300V
 Dim(mm): 12.7 (1/2")OD
 Lead(mm): 35L

7813

FEATURES

Diode: NEGATIVE, 35Ampere, 300V
 Dim(mm): 12.7(1/2") OD
 Lead(mm): 35L



7814

FEATURES

Diode: POSITIVE, 35Ampere, 300V
 Dim(mm): 12.7 (1/2")OD
 Lead(mm): 17L

7815

FEATURES

Diode: NEGATIVE, 35Ampere, 300V
 Dim(mm): 12.7 (1/2")OD
 Lead(mm): 17L



7900

FEATURES

Diode: POSITIVE, 25Ampere, 300V
 Dim(mm): 12.75 (1/2")OD
 Lead(mm): 30

Original & X-References...

DELCO	1852929	1959829
WAI		32-108
TRANSPO		8960

7901

FEATURES

Diode: NEGATIVE, 25Ampere, 300V
 Dim(mm): 12.75 (1/2")OD
 Lead(mm): 30

Original & X-References...

DELCO	1852928	1959830
WAI		32-107
TRANSPO		8961



7902

FEATURES

Diode: POSITIVE, 35Ampere, 300V
 Dim(mm): 12.75(1/2")OD
 Lead(mm): 30L

7903

FEATURES

Diode: NEGATIVE, 35Ampere,300V
 Dim(mm): 12.75(1/2")OD
 Lead(mm): 30



7960

FEATURES

Diode: POSITIVE, 35Ampere, 300V
 Dim(mm): 12.7 (1/2")OD
 Lead(mm): 40L

7961

FEATURES

Diode: NEGATIVE, 35Ampere, 300V
 Dim(mm): 12.7(1/2") OD
 Lead(mm): 40L



7980

FEATURES

Diode: POSITIVE, 35Ampere, 300V
 Dim(mm): 12.75 (1/2")OD
 Lead(mm): 30L
 Popular for Delco 25SI

Original & X-References...

CARGO	130672
DELCO	1971672
WAI	32-103
TRANSPO	8980

7981

FEATURES

Diode: NEGATIVE, 35Ampere, 300V
 Dim(mm): 12.75 (1/2")OD
 Lead(mm): 30L
 Popular for Delco 25SI

Original & X-References...

CARGO	133194
DELCO	1971671
WAI	32-102
TRANSPO	8981



14B00100 /YD-T004

For use on : TOYOTA
CARGO 230116
021630-0650



14B00200/YD-T008



14B00300/YD-T010

CARGO 132426
For : HIR252
L150-43303



14B00400/YD-T011



14B00500/YD-T014

Capacitor : 0.47uF . 250V
CARGO 135226
021630-0602



14B00600/YD-T015

Capacitor : 0.47uF . 250V



14B00700/YD-T022

CARGO 135640
1403-0003



14B00800/YD-T025

For : HIR766
L180G-4330



14B00900/YD-T027

For : HIR767
L170G-3330



14B01000/YD-T029

Replacing 903 902 0
Servicing A124N A12M 12V
Complete w/brushes
CARGO 130703 130702 133547
74999461



14B01100/YD-T030

For : HIR776

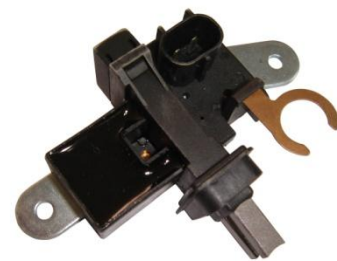

14B01200/B-001

Capacitor : 2.2uF . 250V



14B06900/B-002

Brush Holder Assy
For : FR3G



14B06700/B-003

10475746
For :Delco CS130D Series IR/IF
Alternators WAI 39-109
Components:38-119/120/39-1209
Brush Holder

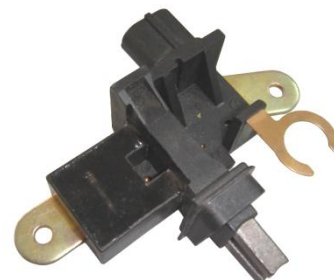

14B01300/B-004

Capacitor : 2.2uF . 250V



14B01400/B-005

For : HI11130



14B01500/B-006



14B01600/B-007



14B01700/B-008



14B01800/B-009

CARGO 135419



14B01900/B-010

Brush Holder Assy.
For: Nippondenso IR/IF Alternators
MOBILTERON BH-ND01
WAI 39-8200 CARGO 132084



14B06600/B-011



14B02000/B-012



14B02100/B-013



14B02200/B-014



14B02300/B-015
021620-2530



14B02400/B-017



14B02500/B-018



14B02600/B-019

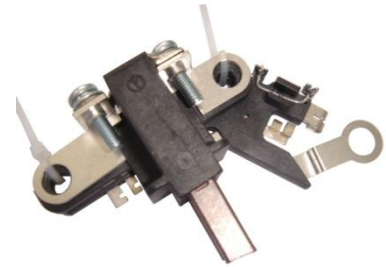

14B02800/B-020



14B02900/B-021

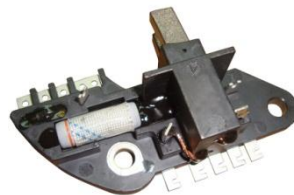

14B03100/B-029



14B03300/B-032



14B03700/B-040



14B03800/B-044



14B04000/B-046



14B04100/B-047



14B04200/B-048



14B04300/B-049

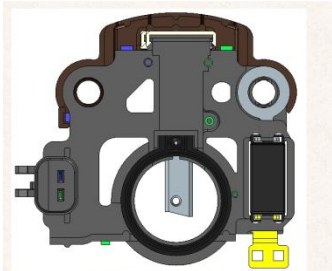

14B04400/B-051



14B04600/B-055



14B04800/B-057



14B05100/B-060
LESTER 11115



14B05400/B-063



14B08900



14B09200



14B09300



14B09400



14R00100/RJ001
Capacitor:2.2uF.250V

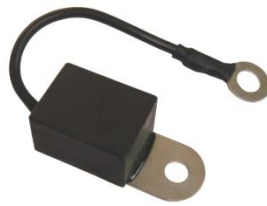

14R00200/RJ002
Capacitor : 2.2Uf/250V



RJ003
2.2uF.250V
CA766 HIR776



14R01500/RJ004
HIR111ZT



14R01600/RJ005
1.5uF.160V
CS144



14R01700/RJ006
1.5uF.220V



14R01800/RJ007
2.2uF.100V



14R01900/RJ008
2.2uF.100V



14R02000/RJ009
2.2uF.160V



14R02100/RJ010
1.5uF.250V
7mm Eyelet, 51mm Lead Length
46-1107-20SI



14R02200/RJ011
1.5uF.250V
4.5mm Eyelet, 50mm Lead Length
46-1101 -10SI



14R02300/RJ012
0.22uF.400V



14R01000/RJ013
0.22uF.400V



RJ014
0.5uF.250V
HI11810ZT



RJ015
0.47uF.250V
YD-T014/5



14R01200/RJ016
0.5uF.200V
46-5101(L96545)



14R00400/RJ019



14R01400/RJ020
Capacitor :2.2uf



14R00500/RJ021



14T02300/RJ025
Capacitor:2.2uF.250V
CARGO 139580
L180G-2318



14T02400/RJ026
Capacitor:2.2uF.250V
CARGO 138731
L180G-1318



14C06700/RJ12015

Capacitor:2.2uF.250V
 CARGO 232833
 FOOM 146 622/0 124 415 005/
 146 718



14C06800/RJ12016

Capacitor:2.2uF.250V
 CARGO 139926
 FOOM 146 609/0 124 225
 001,002,004,009,022,023,024,025



14C06900/RJ12017

Capacitor:2.2Uf.400V
 CARGO 139656
 FOOM 126603



14C07000/RJ12019B

Capacitor:2.2uF.250V
 FOOM 146659



14C07100/RJ12022

Capacitor:2.2Uf.400V
 CARGO 232192
 FOOM 146644



14C07200/RJ408

Capacitor:2.2uF.250V



14C07300/RJ410

Capacitor:2.2uF.250V
 CARGO 139928
 FOOM 146626



14C07400/RJ546



14C00100/1918



14C05600/2564



14C05700/2923



14C00300/C-003



14C00400/C-004
Capacitor:2.2uF.250V



14C00500/C-005



14C01100/C-006
Capacitor:2.2uF.250V



14C01200/C-007



14C01600/C-011
2547772



14C01700/C-012
1615-0007



14C01900/C-014



14C02000/C-015



14C02100/C-016



14C02200/C-017
2548336



14C02400/C-019



14C02500/C-020



14C02600/C-021



14C02900/C-024

Capacitor : 2.2Uf/250V
0124515016



14C03000/C-025

Capacitor : 2.2Uf/250V
A628592A FOOM 146761



14C03100/C-026



14C03300/C-029



14C03400/C-030



14C03500/C-031



14C08500/C-032



14C03700/C-033



14C03800/C-034



14C04000/C-036



14C04100/C-037



14C04200/C-038



14C04300/C-039



14C04400/C-040



14C04500/C-041



14C04600/C-043



14C04700/C-044



14C04800/C-045



14C05000/C-048

FOOM196001
CA1776IR



14C05100/C-049



14C05200/C-050



14C05300/C-051



14C05400/C-052



14C05800/C-056



14C05900/C-057
23100-3TS3A



14C07900



14C08000

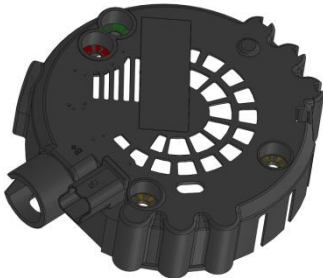

14C08100



14T00100/YD-T001

Capacitor:2.7uF.250V
For use on :NIPPONDENSO
CARGO 234501
026220-0150



14T00200/YD-T002

Capacitor:0.47uF.250V
For use on :NIPPONDENSO
CARGO 231453
126220-0050



14T00300/YD-T003

Capacitor:1uF.100V
For use on :NIPPONDENSO
WAI 46-82201
CARGO 231893
126220-0110



14T00400/YD-T006

Capacitor:1.5uF.100V
For use on :NIPPONDENSO
CARGO 234727
TRANSPO INP421
1405-0008



14T00500/YD-T007

CARGO 232212



14T00600/YD-T012

Capacitor:1.5uF.100V
For use on :NIPPONDENSO
CARGO 235691



14T00700/YD-T013

Capacitor:1.5uF.100V
CARGO 235673
TRANSPO IN420



14T00800/YD-T016

Servicing 633 21711 63341711
Terminal
CARGO 233825
1220-0043



14T01000/YD-T017

CARGO 232464
1920-0044



14T00900/YD-T018

Servicing 633 21679
B+ Terminal
CARGO 232465
MM8047



14T01100/YD-T019

CARGO 233823
1917-0003



14T02200/YD-T021



14T01200/YD-T023

A13V1241
KOPIE
1320-0138



14T01300/YD-T026

CARGO 234069
1920-0057



14T01400/YD-T028

Replacing 593288
CARGO 139451



YD-T032

For: NPR920



14T01500/YD-T033

CARGO 232215
2547987



14T01700/RJ800

Capacitor:2.2uF.250V
CARGO 135514
95-0275



14T01800/RJ802

Capacitor:2.2uF.250V
CARGO 135433



14T01900/RJ808

Capacitor:2.2uF.250V
CARGO 136644



14T02000/RJ814

Capacitor:2.2uF.250V
CARGO 135495
592934



14T02100/RJ844

Capacitor:2.2uF.250V
CARGO 137522
593233



14T02500/T-001

Resistor 460 Ohm/2W
For:HI11810ZT



14T02600/T-002

Capacitor:2.2uF.250V



14T02700/T-003

CARGO: 235458
VALEO: 2542524 2542771
2548655



14T01600/T-005

Servicing A127 54022487
Resistor
CARGO 231353
1220-0044



14T02900/T-006



14T03000/T-007



14T03100/T-008



14T03400/T-010

With M6



14T03500/T-011

With M8



14T03600/T-012

361°



14T03800/T-015



14T03900/T-016



14T04000/T-017



14T04100/T-018



14T04200/T-019

46-82207
TB-ND163



14T04300/T-020

NIPPONDENSO :126220-0230
MOBILETRON :TB-ND167
WAI :46-82205



14T04400/T-021

MOBILETRON :TB-ND165
WAI :46-82208



14T04500/T-022



14T04600/T-023

AVG241607



14A00200/A718-1



14A00300/A1341



14A00100/A1494