

























































455901	1.2 KW	2B	
12 V	60°	9	15 a



2a		Armature Induit Inducido Induzido Armatura
2		Reduction gear assembly Moto réducteur complet Moto reductor completo Moto reductor completo Motoriduttore completo
2b		Pignon drive shaft assembly Arbre lanceur Arbol piñón Pinhão e veio Albero pignone
3		Pinion Drive Lanceur Piñón de arranque Pinhão de arranque Pignone
4		Solenoid switch Contacteur Relé contactor/Relé CED Relé de Contacto / Relé CED Contattore
5		Cap. terminal + moving contacts Contact capot + bornes Contactos relé + Bornes Contactos de relé + Bornes Contatto coperchio + morsetti
6		Serie Coil Bobines série Bobinas serie Bobines em Série Bobine serie
7		Shunt Coil Bobines shunt Bobinas paralelo Bobines em Paralelo Bobine shunt
8		Brushes box washers Rondelles porte-balais Arandelas Porta escobillas Anilha porta-escovas Rondella porta spazzole
9		Brushes and springs set Jeu de balais et ressorts Juego de escobillas y muelles Jogo de Escovas e Molas Kit spazzole e molle
10		Bush kit Jeu de bagues Juego de casquillos Jogo de Casquilhos Kit spazzole
11		Pinion fork set Ensemble de levier de commande Conjunto de horquilla Conjunto da forquilha Kit forcella
12		Armature shim Calage de l'induit Calado del inducido Armadura do induzido Regolazione dell'indotto
13		Commutator end shield, assembly Palier collecteur complet Tapa colector completa Tampa colectora completa Supporto collettore completo
14		Drive end housing Support lanceur Soporte piñón Suporte do pinhão Supporto pignone

15		Pole shoe, screw set Jeu de vis masses polaire Juego de tornillos sujeción masas polares Jogo de parafusos de fixação das massas polares Corredo di viti massa polo
16		Pinion stop assembly Jeu de pièces butée lanceur Juego de piezas retención piñón Jogo de stop do pinhão Corredo sostegno pignone
17		Terminal series coil Borne complète, bobine série Borne completo, Bobinas en Serie Borne completo, Bobines em Série Morsetto completo, bobine serie
18		Brake washer, intermediate housing Rondelle frein, palier intermédiaire Arandela de freno Anilha de freno Rondella freno, supporto intermediario
19		Braided wire or Jumper Connexion tresse Conexión trenzada Ligação transada Connessione treccia
20		Gaskets Set Jeu de joints Juego de juntas Jogo de Juntas Set guarnizioni
21		Terminal series Coil, shunt Coil Borne complète, bobine shunt Borne completo, Bobinas en Paralelo Borne completo, Bobines em Paralelo Morsetto completo, bobine shunt
22		Intermediate housing assembly Palier intermédiaire complet Tapa intermedia completa Tampa intermédia completa Supporto intermediario completo
23		Through bolts Tige d'assemblage Tornillos de montaje Parafusos de montagem Tiranti d'assemblaggio
24		Repair kit Jeu de pièces réparation Juego piezas de reparación Jogo de peças de reparação Kit riparazione
25		Spare part kit Nécessaire de réparation Kit de reparación Kit de reparação Kit ricambi
26		Connection set Alimentation Alimentación Alimentação Kit alimentazione
27		Induction coil Inducteur Bobina de Inducción Bobine de indução Indotto



2a 	Anker Ankerwelle Wirnik Kollektör Якорь	15 	Schroevenset massa-aansluiting Polschuhschraubenset Zestaw śrub nabiegunka Kutup tespit vida takımı Полюсный башмак, набор болтов
2 	Reductieinrichting compleet Untersetzungegetriebe, komplett Przekładnia redukcyną kpl. anżıman sargı kollektör takımı Модуль стартера в сборе	16 	Rondsel stopinrichting Ritzelanschlagset Pierścien czołowy zębnika kpl. Pinyon tahdit bilezik takımı parçaları Передняя защитная втулка
2b 	Rondsels Welle des Ritzels Ośka zębnika kpl. Dişli mili Вал ведущей шестерни в сборе	17 	Aansluitklem veldwikkelingsspoel (serie) Komplette Anschlussplatte, in Serie geschaltete Magnetspulen Zacisk cewki seryjnej Seri bobin-Tüm uçlar Клемма последовательной обмотки
3 	Rondsel Antriebsritzel Zębnik Marş dişlisi Бендикс	18 	Remschijf middelste behuizing Brems Scheibe am Zwischenlager Środkowa podkładka hamująca Frenleme pulu iç kapak Стопорная шайба, промежуточная крышка
4 	Magneeschakelaar Magnetschalter Włącznik marş otomatığı соленоида	19 	Gevlochten kabel Anschlussband Wiązka/łacze Örgü şerit bağlantı Проволока с оплеткой
5 	Magneeschakelaar + sleepingen. Magnetschalterabdeckung + Kontaktplatte + Anschlüsse Osłona zacisku + ruchome styki Bağlantı kapağı + uçlar Сар. Клемма + подвижные контакты	20 	Pakkingset Dichtungssatz Zestaw uszczelkek Conta takımı Набор прокладок
6 	Veldwikkelingsspoel (serie) In Serie geschaltete Magnetspulen Cewka seryjna Seri bobin Последовательная обмотка	21 	Aansluitklem veldwikkelingsspoel (paralel) Komplette Anschlussplatte, überbrückte Magnetspulen Zacisk cewki seryjnej, cewki regenerowanej Şönt bobin-Tüm uçlar Клемма последовательной обмотки, параллельной обмотки
7 	Veldwikkelingsspoel (paralel) Überbrückung der Magnetspulen Cewka regenerowana Şönt bobin Параллельная обмотка	22 	Tussenbehuizing compleet Zwischenlagerhalterung Obudowa środkowa kpl. İç kapak takımı Промежуточная крышка в сборе
8 	Koolborstelhouder-ringen Scheibe, Kohlentträger Obudowa szczotek Kömür taşıyıcı (kapağı) Карзина с щетками	23 	Behuizingsbouten Zuganker Śruby spinające Saplama vida takımı Сквозные болты
9 	Koolborstelset met veren Kohlebürstensatz mit Federn Zestaw szczotek i sprężynek Kömür ve yay takımı Набор щеток с пружинами	24 	Reparatieset Reparatursatz Zestaw naprawczy Tamir takımı Ремонтный набор
10 	Lagerbussenset Ring-Set Zestaw tulejek Burç takımı Набор втулок	25 	Noodzakelijk voor reparatie Reparaturkleinteile Zestaw części zamiennych Tamir takımı Набор запасных частей
11 	Bedieningsvork rondsel Betätigungseinheit Dźwigienka zębnika kpl. Çatal takımı Вилка	26 	Stroomvoorziening Stromversorgung Zestaw podłączeń Besleme seti Набор коннекторов
12 	Ankervulring Justierung des Ankers Podkładka wirnika Köllektör desteği Прокладка якоря	27 	Inductiespoel Erregerwicklung Cewka wzbudzająca Marş motoru gövdesi (indüktör) Индукционная катушка
13 	Behuizing collector compleet Komplettes Hinteres Lagerschild Tylna osłona komutatora kpl. Arka koruma kapak takımı Задняя крышка в сборе		
14 	Rondsel-lager Vorderes Gehäuse des Anlassers Głowica rozrusznika Marş dişli desteği Головка корпуса стартера		

0001107005 1,1 Kw 3(0) ↻

12 V 57° 10 N



BUSHING KIT 10 *595571
Valeo 436019

532004ABC 1 Kw 3(0) ↻

12 V 9



PINION DRIVE 03 611942
Valeo 436019

532008ABC 1 Kw 3(0) ↻

12 V 9



PINION DRIVE 03 611942
Valeo 436019

532009AB 0,9 Kw 3(0) ↻

12 V 9



PINION DRIVE 03 611942
Valeo 436019

533000AB 1,05 Kw 3(3) ↻

12 V 9

Picture not available
Image non disponible
Imagen no disponible
Immagine non disponibile
Nicht verfügbares Bild
Brak zdjęcia
Картина недоступна

Picture not available
Image non disponible
Imagen no disponible
Immagine non disponibile
Nicht verfügbares Bild
Brak zdjęcia
Картина недоступна

PINION DRIVE 03 612355
Valeo 432505/433331

6020 0,9 Kw 2 ↻

12 V 9

Picture not available
Image non disponible
Imagen no disponible
Immagine non disponibile
Nicht verfügbares Bild
Brak zdjęcia
Картина недоступна

Picture not available
Image non disponible
Imagen no disponible
Immagine non disponibile
Nicht verfügbares Bild
Brak zdjęcia
Картина недоступна

BRUSHES AND SPRINGS SET 09 618491
PINION STOP ASSEMBLY 16 020612

6020EF 0

0 0

Picture not available
Image non disponible
Imagen no disponible
Immagine non disponibile
Nicht verfügbares Bild
Brak zdjęcia
Картина недоступна

Picture not available
Image non disponible
Imagen no disponible
Immagine non disponibile
Nicht verfügbares Bild
Brak zdjęcia
Картина недоступна

BRUSHES AND SPRINGS SET 09 618491
PINION STOP ASSEMBLY 16 020612

6092B 0

0 0

Picture not available
Image non disponible
Imagen no disponible
Immagine non disponibile
Nicht verfügbares Bild
Brak zdjęcia
Картина недоступна

Picture not available
Image non disponible
Imagen no disponible
Immagine non disponibile
Nicht verfügbares Bild
Brak zdjęcia
Картина недоступна

BUSHING KIT 10 583372
Valeo 432518/433220

6184AC 0

0 0

Picture not available
Image non disponible
Imagen no disponible
Immagine non disponibile
Nicht verfügbares Bild
Brak zdjęcia
Картина недоступна

Picture not available
Image non disponible
Imagen no disponible
Immagine non disponibile
Nicht verfügbares Bild
Brak zdjęcia
Картина недоступна

BRUSHES AND SPRINGS SET 09 618509

6226A 1,2 Kw 3(0) ↻

12 V 9



PINION DRIVE 03 612355
Valeo 436019

6247AB

0,95 Kw

3(3)



12 V

**PINION DRIVE** 03**Valeo**

612355

436019

D10E47

1,5 Kw

3(0)



12 V



Picture not available
Image non disponible
Imagen no disponible
Immagine non disponibile
Nicht verfügbares Bild
Brak zdjęcia
Картина недоступна

Picture not available
Image non disponible
Imagen no disponible
Immagine non disponibile
Nicht verfügbares Bild
Brak zdjęcia
Картина недоступна

PINION STOP ASSEMBLY 16**SOLENOID SWITCH** 04**Valeo**

073294

182438

436019

D10E48

1,25 Kw

3(1)



12 V



Picture not available
Image non disponible
Imagen no disponible
Immagine non disponibile
Nicht verfügbares Bild
Brak zdjęcia
Картина недоступна

Picture not available
Image non disponible
Imagen no disponible
Immagine non disponibile
Nicht verfügbares Bild
Brak zdjęcia
Картина недоступна

PINION STOP ASSEMBLY 16**SOLENOID SWITCH** 04**Valeo**

073294

182438

432526

D10E54

1,3 Kw

3(1)



12 V



Picture not available
Image non disponible
Imagen no disponible
Immagine non disponibile
Nicht verfügbares Bild
Brak zdjęcia
Картина недоступна

Picture not available
Image non disponible
Imagen no disponible
Immagine non disponibile
Nicht verfügbares Bild
Brak zdjęcia
Картина недоступна

PINION STOP ASSEMBLY 16**SOLENOID SWITCH** 04**Valeo**

073294

182438

432519

D10E57

1,3 Kw

3(1)



12 V



Picture not available
Image non disponible
Imagen no disponible
Immagine non disponibile
Nicht verfügbares Bild
Brak zdjęcia
Картина недоступна

Picture not available
Image non disponible
Imagen no disponible
Immagine non disponibile
Nicht verfügbares Bild
Brak zdjęcia
Картина недоступна

PINION STOP ASSEMBLY 16**Valeo**

073294

432519

D10E59

1,5 Kw

3(3)



12 V



Picture not available
Image non disponible
Imagen no disponible
Immagine non disponibile
Nicht verfügbares Bild
Brak zdjęcia
Картина недоступна

Picture not available
Image non disponible
Imagen no disponible
Immagine non disponibile
Nicht verfügbares Bild
Brak zdjęcia
Картина недоступна

PINION DRIVE 03**PINION STOP ASSEMBLY** 16**Valeo**

096555

073294

432523

D10E63

1,25 Kw

3(1)



12 V



Picture not available
Image non disponible
Imagen no disponible
Immagine non disponibile
Nicht verfügbares Bild
Brak zdjęcia
Картина недоступна

Picture not available
Image non disponible
Imagen no disponible
Immagine non disponibile
Nicht verfügbares Bild
Brak zdjęcia
Картина недоступна

PINION STOP ASSEMBLY 16**SOLENOID SWITCH** 04**Valeo**

073294

182438

096639

D10E64

1,25 Kw

3(1)



12 V



Picture not available
Image non disponible
Imagen no disponible
Immagine non disponibile
Nicht verfügbares Bild
Brak zdjęcia
Картина недоступна

Picture not available
Image non disponible
Imagen no disponible
Immagine non disponibile
Nicht verfügbares Bild
Brak zdjęcia
Картина недоступна

PINION STOP ASSEMBLY 16**SOLENOID SWITCH** 04**Valeo**

073294

182438

432519

D10E65

1,25 Kw

3(1)



12 V



Picture not available
Image non disponible
Imagen no disponible
Immagine non disponibile
Nicht verfügbares Bild
Brak zdjęcia
Картина недоступна

Picture not available
Image non disponible
Imagen no disponible
Immagine non disponibile
Nicht verfügbares Bild
Brak zdjęcia
Картина недоступна

PINION STOP ASSEMBLY 16**Valeo**

073294

432519

D10E66

1,5 Kw

3(0)



12 V



Picture not available
Image non disponible
Imagen no disponible
Immagine non disponibile
Nicht verfügbares Bild
Brak zdjęcia
Картина недоступна

Picture not available
Image non disponible
Imagen no disponible
Immagine non disponibile
Nicht verfügbares Bild
Brak zdjęcia
Картина недоступна

PINION STOP ASSEMBLY 16**Valeo**

097804

436019



D10E68	2,15 Kw	2(0)	
24 V			
Picture not available Image non disponible Imagen no disponible Immagine non disponibile Nicht verfügbares Bild Brak zdjęcia Картина недоступна	Picture not available Image non disponible Imagen no disponible Immagine non disponibile Nicht verfügbares Bild Brak zdjęcia Картина недоступна		
PINION STOP ASSEMBLY 16	Valeo	073294 097571	
D10E69	2,15 Kw	3(3)	
24 V			
Picture not available Image non disponible Imagen no disponible Immagine non disponibile Nicht verfügbares Bild Brak zdjęcia Картина недоступна	Picture not available Image non disponible Imagen no disponible Immagine non disponibile Nicht verfügbares Bild Brak zdjęcia Картина недоступна		
ARMATURE 02a		098332	
PINION DRIVE 03		096555	
PINION STOP ASSEMBLY 16	Valeo	073294 098195	
D10E72	1,65 Kw	3(3)	
12 V			
Picture not available Image non disponible Imagen no disponible Immagine non disponibile Nicht verfügbares Bild Brak zdjęcia Картина недоступна	Picture not available Image non disponible Imagen no disponible Immagine non disponibile Nicht verfügbares Bild Brak zdjęcia Картина недоступна		
PINION STOP ASSEMBLY 16	Valeo	097804 436019	
D10E73	1,5 Kw	3(0)	
12 V			
Picture not available Image non disponible Imagen no disponible Immagine non disponibile Nicht verfügbares Bild Brak zdjęcia Картина недоступна	Picture not available Image non disponible Imagen no disponible Immagine non disponibile Nicht verfügbares Bild Brak zdjęcia Картина недоступна		
PINION STOP ASSEMBLY 16	Valeo	073294 182438 436019	
SOLENOID SWITCH 04			
D10E74	1,75 Kw	3(0)	
12 V			
Picture not available Image non disponible Imagen no disponible Immagine non disponibile Nicht verfügbares Bild Brak zdjęcia Картина недоступна	Picture not available Image non disponible Imagen no disponible Immagine non disponibile Nicht verfügbares Bild Brak zdjęcia Картина недоступна		
PINION STOP ASSEMBLY 16	Valeo	097804 436019	

D10E75	1,4 Kw	2(1)	
12 V			
Picture not available Image non disponible Imagen no disponible Immagine non disponibile Nicht verfügbares Bild Brak zdjęcia Картина недоступна	Picture not available Image non disponible Imagen no disponible Immagine non disponibile Nicht verfügbares Bild Brak zdjęcia Картина недоступна		
PINION STOP ASSEMBLY 16	Valeo	097804 432522/433262	
D10E76	1,25 Kw	3(1)	
12 V			
Picture not available Image non disponible Imagen no disponible Immagine non disponibile Nicht verfügbares Bild Brak zdjęcia Картина недоступна	Picture not available Image non disponible Imagen no disponible Immagine non disponibile Nicht verfügbares Bild Brak zdjęcia Картина недоступна		
PINION STOP ASSEMBLY 16	Valeo	073294 432526	
D10E79	1,75 Kw	3(2)	
12 V			
Picture not available Image non disponible Imagen no disponible Immagine non disponibile Nicht verfügbares Bild Brak zdjęcia Картина недоступна	Picture not available Image non disponible Imagen no disponible Immagine non disponibile Nicht verfügbares Bild Brak zdjęcia Картина недоступна		
PINION STOP ASSEMBLY 16	Valeo	097804 432525	
D10E80	1,25 Kw	3(1)	
12 V			
Picture not available Image non disponible Imagen no disponible Immagine non disponibile Nicht verfügbares Bild Brak zdjęcia Картина недоступна	Picture not available Image non disponible Imagen no disponible Immagine non disponibile Nicht verfügbares Bild Brak zdjęcia Картина недоступна		
PINION STOP ASSEMBLY 16	Valeo	073294 182438 432526	
SOLENOID SWITCH 04			
D10E81	1,4 Kw	2(1)	
12 V			
Picture not available Image non disponible Imagen no disponible Immagine non disponibile Nicht verfügbares Bild Brak zdjęcia Картина недоступна	Picture not available Image non disponible Imagen no disponible Immagine non disponibile Nicht verfügbares Bild Brak zdjęcia Картина недоступна		
PINION STOP ASSEMBLY 16	Valeo	097804 432522/433262	

D10E83 1,4 Kw 2(1) ↻

12 V 9

Picture not available
Image non disponible
Imagen no disponible
Immagine non disponibile
Nicht verfügbares Bild
Brak zdjęcia
Картина недоступна

Picture not available
Image non disponible
Imagen no disponible
Immagine non disponibile
Nicht verfügbares Bild
Brak zdjęcia
Картина недоступна

PINION STOP ASSEMBLY 16 097804
Valeo 432522/433262

D10E84 1,25 Kw 2(0) ↻

12 V 9

Picture not available
Image non disponible
Imagen no disponible
Immagine non disponibile
Nicht verfügbares Bild
Brak zdjęcia
Картина недоступна

Picture not available
Image non disponible
Imagen no disponible
Immagine non disponibile
Nicht verfügbares Bild
Brak zdjęcia
Картина недоступна

PINION STOP ASSEMBLY 16 097804
SOLENOID SWITCH 04 182438

D10E84 1,25 Kw 2(0) ↻

12 V 9

Picture not available
Image non disponible
Imagen no disponible
Immagine non disponibile
Nicht verfügbares Bild
Brak zdjęcia
Картина недоступна

Picture not available
Image non disponible
Imagen no disponible
Immagine non disponibile
Nicht verfügbares Bild
Brak zdjęcia
Картина недоступна

PINION STOP ASSEMBLY 16 097804
SOLENOID SWITCH 04 182438
Valeo 436019

D10E85 2,15 Kw 3(3) ↻

12 V 11

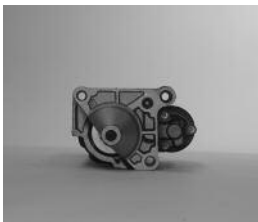

BRUSHES AND SPRINGS SET 09 300841
PINION DRIVE 03 103611
PINION STOP ASSEMBLY 16 097804
REPAIR KIT 24 182060
PINION FORK SET 11 300838
SOLENOID SWITCH 04 182460
Valeo 436019

D10E86 2,15 Kw 3(0) ↻

24 V 9

Picture not available
Image non disponible
Imagen no disponible
Immagine non disponibile
Nicht verfügbares Bild
Brak zdjęcia
Картина недоступна

Picture not available
Image non disponible
Imagen no disponible
Immagine non disponibile
Nicht verfügbares Bild
Brak zdjęcia
Картина недоступна

PINION FORK SET 11 182058
Valeo 183388

D10E87 2,15 Kw 3(3) ↻

12 V 9

Picture not available
Image non disponible
Imagen no disponible
Immagine non disponibile
Nicht verfügbares Bild
Brak zdjęcia
Картина недоступна

Picture not available
Image non disponible
Imagen no disponible
Immagine non disponibile
Nicht verfügbares Bild
Brak zdjęcia
Картина недоступна

BRUSHES AND SPRINGS SET 09 300841
PINION STOP ASSEMBLY 16 097804
REPAIR KIT 24 182060
PINION FORK SET 11 300838
SOLENOID SWITCH 04 182462
Valeo 432523

D10E88 2,15 Kw 3(3) ↻

12 V 9

Picture not available
Image non disponible
Imagen no disponible
Immagine non disponibile
Nicht verfügbares Bild
Brak zdjęcia
Картина недоступна

Picture not available
Image non disponible
Imagen no disponible
Immagine non disponibile
Nicht verfügbares Bild
Brak zdjęcia
Картина недоступна

BRUSHES AND SPRINGS SET 09 300841
PINION STOP ASSEMBLY 16 097804
REPAIR KIT 24 182060
PINION FORK SET 11 300838
SOLENOID SWITCH 04 182461
Valeo 436019

D10E881 2,15 Kw 3(3) ↻

12 V 9

Picture not available
Image non disponible
Imagen no disponible
Immagine non disponibile
Nicht verfügbares Bild
Brak zdjęcia
Картина недоступна

Picture not available
Image non disponible
Imagen no disponible
Immagine non disponibile
Nicht verfügbares Bild
Brak zdjęcia
Картина недоступна

BRUSHES AND SPRINGS SET 09 300841
PINION STOP ASSEMBLY 16 097804
REPAIR KIT 24 182060
PINION FORK SET 11 300838
SOLENOID SWITCH 04 182461
Valeo 436019



D10E882 2,15 Kw 3(3) ↻

12 V 9

Picture not available
Image non disponible
Imagen no disponible
Immagine non disponibile
Nicht verfügbares Bild
Brak zdjęcia
Картина недоступна

Picture not available
Image non disponible
Imagen no disponible
Immagine non disponibile
Nicht verfügbares Bild
Brak zdjęcia
Картина недоступна

BRUSHES AND SPRINGS SET 09 300841
PINION STOP ASSEMBLY 16 097804
REPAIR KIT 24 182060
PINION FORK SET 11 300838
SOLENOID SWITCH 04 182461
Valeo 436019

D10E89 2,15 Kw 3(3) ↻

12 V 9

Picture not available
Image non disponible
Imagen no disponible
Immagine non disponibile
Nicht verfügbares Bild
Brak zdjęcia
Картина недоступна

Picture not available
Image non disponible
Imagen no disponible
Immagine non disponibile
Nicht verfügbares Bild
Brak zdjęcia
Картина недоступна

BRUSHES AND SPRINGS SET 09 300841
PINION STOP ASSEMBLY 16 097804
REPAIR KIT 24 182060
PINION FORK SET 11 300838
SOLENOID SWITCH 04 182461
Valeo 432525

D10E90 2,15 Kw 3(3) ↻

12 V 9

Picture not available
Image non disponible
Imagen no disponible
Immagine non disponibile
Nicht verfügbares Bild
Brak zdjęcia
Картина недоступна

Picture not available
Image non disponible
Imagen no disponible
Immagine non disponibile
Nicht verfügbares Bild
Brak zdjęcia
Картина недоступна

BRUSHES AND SPRINGS SET 09 300841
PINION STOP ASSEMBLY 16 097804
REPAIR KIT 24 182060
PINION FORK SET 11 300838
SOLENOID SWITCH 04 182461
Valeo 432526

D10E92 2,15 Kw 3(3) ↻

12 V 11

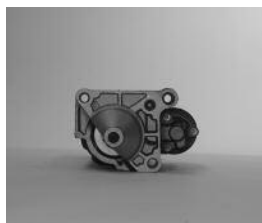

BRUSHES AND SPRINGS SET 09 300841
PINION DRIVE 03 103611
PINION STOP ASSEMBLY 16 097804
REPAIR KIT 24 182060
PINION FORK SET 11 300838
SOLENOID SWITCH 04 182460
Valeo 436019

D10E921 2,15 Kw 3(3) ↻

12 V 11

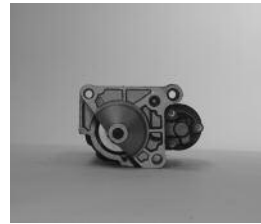

BRUSHES AND SPRINGS SET 09 300841
PINION STOP ASSEMBLY 16 097804
REPAIR KIT 24 182060
PINION FORK SET 11 300838
SOLENOID SWITCH 04 182460
Valeo 436019

D10E922 2,15 Kw 3(3) ↻

12 V 11



BRUSHES AND SPRINGS SET 09 300841
PINION DRIVE 03 103611
PINION STOP ASSEMBLY 16 097804
REPAIR KIT 24 182060
PINION FORK SET 11 300838
SOLENOID SWITCH 04 182460
Valeo 436019

D10E96 0

0 0

Picture not available
Image non disponible
Imagen no disponible
Immagine non disponibile
Nicht verfügbares Bild
Brak zdjęcia
Картина недоступна

Picture not available
Image non disponible
Imagen no disponible
Immagine non disponibile
Nicht verfügbares Bild
Brak zdjęcia
Картина недоступна

PINION STOP ASSEMBLY 16 097804
Valeo 181341

D10E99 1,4 Kw 3(3) ↻

12 V 16

Picture not available
Image non disponible
Imagen no disponible
Immagine non disponibile
Nicht verfügbares Bild
Brak zdjęcia
Картина недоступна

Picture not available
Image non disponible
Imagen no disponible
Immagine non disponibile
Nicht verfügbares Bild
Brak zdjęcia
Картина недоступна

ARMATURE 02a 594147
PINION STOP ASSEMBLY 16 097804
REPAIR KIT 24 182060

D11E108 6,5 Kw 3(0)

24 V

Picture not available
Image non disponible
Imagen no disponible
Immagine non disponibile
Nicht verfügbares Bild
Brak zdjęcia
Картина недоступна

Picture not available
Image non disponible
Imagen no disponible
Immagine non disponibile
Nicht verfügbares Bild
Brak zdjęcia
Картина недоступна

POLE SHOE, SCREWS SET 15 182041
Valeo 070527

D11E118 2,6 Kw 3(0)

12 V

Picture not available
Image non disponible
Imagen no disponible
Immagine non disponibile
Nicht verfügbares Bild
Brak zdjęcia
Картина недоступна

Picture not available
Image non disponible
Imagen no disponible
Immagine non disponibile
Nicht verfügbares Bild
Brak zdjęcia
Картина недоступна

POLE SHOE, SCREWS SET 15 182041
PINION DRIVE 03 073301
PINION STOP ASSEMBLY 16 059452
SOLENOID SWITCH 04 182438
Valeo 436019

D11E119 2,9 Kw 3(0)

12 V

Picture not available
Image non disponible
Imagen no disponible
Immagine non disponibile
Nicht verfügbares Bild
Brak zdjęcia
Картина недоступна

Picture not available
Image non disponible
Imagen no disponible
Immagine non disponibile
Nicht verfügbares Bild
Brak zdjęcia
Картина недоступна

POLE SHOE, SCREWS SET 15 182041
BRUSHES AND SPRINGS SET 09 182114
SOLENOID SWITCH 04 182438
Valeo 436019

D11E120 2,6 Kw 3(0)

12 V

Picture not available
Image non disponible
Imagen no disponible
Immagine non disponibile
Nicht verfügbares Bild
Brak zdjęcia
Картина недоступна

Picture not available
Image non disponible
Imagen no disponible
Immagine non disponibile
Nicht verfügbares Bild
Brak zdjęcia
Картина недоступна

POLE SHOE, SCREWS SET 15 182041
PINION DRIVE 03 075379
PINION STOP ASSEMBLY 16 059453
SOLENOID SWITCH 04 182438
Valeo 436019

D11E122T 4,7 Kw 3(0)

24 V

Picture not available
Image non disponible
Imagen no disponible
Immagine non disponibile
Nicht verfügbares Bild
Brak zdjęcia
Картина недоступна

Picture not available
Image non disponible
Imagen no disponible
Immagine non disponibile
Nicht verfügbares Bild
Brak zdjęcia
Картина недоступна

POLE SHOE, SCREWS SET 15 182041
BRUSHES AND SPRINGS SET 09 182145
PINION STOP ASSEMBLY 16 059454
Valeo 436019

D11E128 4,7 Kw 3(0)

24 V

Picture not available
Image non disponible
Imagen no disponible
Immagine non disponibile
Nicht verfügbares Bild
Brak zdjęcia
Картина недоступна

Picture not available
Image non disponible
Imagen no disponible
Immagine non disponibile
Nicht verfügbares Bild
Brak zdjęcia
Картина недоступна

POLE SHOE, SCREWS SET 15 182041
BRUSHES AND SPRINGS SET 09 182145
PINION STOP ASSEMBLY 16 059454
Valeo 072838

D11E129T 2,9 Kw 3(0)

12 V

Picture not available
Image non disponible
Imagen no disponible
Immagine non disponibile
Nicht verfügbares Bild
Brak zdjęcia
Картина недоступна

Picture not available
Image non disponible
Imagen no disponible
Immagine non disponibile
Nicht verfügbares Bild
Brak zdjęcia
Картина недоступна

POLE SHOE, SCREWS SET 15 182041
BRUSHES AND SPRINGS SET 09 182114
SOLENOID SWITCH 04 182438
Valeo 076539

D11E131 2,9 Kw 3(0)

12 V

Picture not available
Image non disponible
Imagen no disponible
Immagine non disponibile
Nicht verfügbares Bild
Brak zdjęcia
Картина недоступна

Picture not available
Image non disponible
Imagen no disponible
Immagine non disponibile
Nicht verfügbares Bild
Brak zdjęcia
Картина недоступна

POLE SHOE, SCREWS SET 15 182041
BRUSHES AND SPRINGS SET 09 182114
PINION DRIVE 03 075379
PINION STOP ASSEMBLY 16 059453
SOLENOID SWITCH 04 182438
Valeo 436019



D11E137

2,9 Kw

3(0)



12 V



Picture not available
Image non disponible
Imagen no disponible
Immagine non disponibile
Nicht verfügbares Bild
Brak zdjęć
Картина недоступна

Picture not available
Image non disponible
Imagen no disponible
Immagine non disponibile
Nicht verfügbares Bild
Brak zdjęć
Картина недоступна

POLE SHOE, SCREWS SET 15

182041

BRUSHES AND SPRINGS SET 09

182114

SOLENOID SWITCH 04

182438

Valeo**436019****D11E138T**

6 Kw

3(0)



24 V



Picture not available
Image non disponible
Imagen no disponible
Immagine non disponibile
Nicht verfügbares Bild
Brak zdjęć
Картина недоступна

Picture not available
Image non disponible
Imagen no disponible
Immagine non disponibile
Nicht verfügbares Bild
Brak zdjęć
Картина недоступна

POLE SHOE, SCREWS SET 15

182041

PINION STOP ASSEMBLY 16

059454

Valeo**094152****D11E139**

3,2 Kw

3(0)



24 V

30°



N

Picture not available
Image non disponible
Imagen no disponible
Immagine non disponibile
Nicht verfügbares Bild
Brak zdjęć
Картина недоступна

Picture not available
Image non disponible
Imagen no disponible
Immagine non disponibile
Nicht verfügbares Bild
Brak zdjęć
Картина недоступна

POLE SHOE, SCREWS SET 15

182041

PINION DRIVE 03

073301

Valeo**436019****D11E139T**

3,2 Kw

3(0)



24 V



Picture not available
Image non disponible
Imagen no disponible
Immagine non disponibile
Nicht verfügbares Bild
Brak zdjęć
Картина недоступна

Picture not available
Image non disponible
Imagen no disponible
Immagine non disponibile
Nicht verfügbares Bild
Brak zdjęć
Картина недоступна

POLE SHOE, SCREWS SET 15

182041

PINION DRIVE 03

073301

Valeo**436019****D11E141**

2,9 Kw

3(0)



12 V



Picture not available
Image non disponible
Imagen no disponible
Immagine non disponibile
Nicht verfügbares Bild
Brak zdjęć
Картина недоступна

Picture not available
Image non disponible
Imagen no disponible
Immagine non disponibile
Nicht verfügbares Bild
Brak zdjęć
Картина недоступна

POLE SHOE, SCREWS SET 15

182041

BRUSHES AND SPRINGS SET 09

182114

SOLENOID SWITCH 04

182438

Valeo**432571****D11E142**

1,95 Kw

3(0)



12 V

**POLE SHOE, SCREWS SET** 15

182041

PINION STOP ASSEMBLY 16

059453

SOLENOID SWITCH 04

182435

Valeo**436019****D11E143**

1,95 Kw

3(0)



12 V



Picture not available
Image non disponible
Imagen no disponible
Immagine non disponibile
Nicht verfügbares Bild
Brak zdjęć
Картина недоступна

Picture not available
Image non disponible
Imagen no disponible
Immagine non disponibile
Nicht verfügbares Bild
Brak zdjęć
Картина недоступна

POLE SHOE, SCREWS SET 15

182041

PINION STOP ASSEMBLY 16

059453

SOLENOID SWITCH 04

182435

Valeo**432533****D11E144**

2 Kw

3(0)



12 V



Picture not available
Image non disponible
Imagen no disponible
Immagine non disponibile
Nicht verfügbares Bild
Brak zdjęć
Картина недоступна

Picture not available
Image non disponible
Imagen no disponible
Immagine non disponibile
Nicht verfügbares Bild
Brak zdjęć
Картина недоступна

POLE SHOE, SCREWS SET 15

182041

PINION DRIVE 03

054335

PINION STOP ASSEMBLY 16

059452

SOLENOID SWITCH 04

182442

Valeo**092029**

D11E146 2,9 Kw 3(0) ↻

12 V 9

Picture not available
Image non disponible
Imagen no disponible
Immagine non disponibile
Nicht verfügbares Bild
Brak zdjęcia
Картина недоступна

Picture not available
Image non disponible
Imagen no disponible
Immagine non disponibile
Nicht verfügbares Bild
Brak zdjęcia
Картина недоступна

POLE SHOE, SCREWS SET 15 182041
BRUSHES AND SPRINGS SET 09 182114
PINION DRIVE 03 073301
PINION STOP ASSEMBLY 16 059452
SOLENOID SWITCH 04 182438
Valeo 436019

D11E153T 2,9 Kw 3(0) ↻

12 V 9

Picture not available
Image non disponible
Imagen no disponible
Immagine non disponibile
Nicht verfügbares Bild
Brak zdjęcia
Картина недоступна

Picture not available
Image non disponible
Imagen no disponible
Immagine non disponibile
Nicht verfügbares Bild
Brak zdjęcia
Картина недоступна

POLE SHOE, SCREWS SET 15 182041
BRUSHES AND SPRINGS SET 09 182114
PINION DRIVE 03 095442
PINION STOP ASSEMBLY 16 059453
SOLENOID SWITCH 04 182438
Valeo 436019

D11E148 2,5 Kw 4(0) ↻

12 V 9

Picture not available
Image non disponible
Imagen no disponible
Immagine non disponibile
Nicht verfügbares Bild
Brak zdjęcia
Картина недоступна

Picture not available
Image non disponible
Imagen no disponible
Immagine non disponibile
Nicht verfügbares Bild
Brak zdjęcia
Картина недоступна

POLE SHOE, SCREWS SET 15 182041
PINION STOP ASSEMBLY 16 059452
SOLENOID SWITCH 04 182448
Valeo 436019

D11E154 2,9 Kw 3(0) ↻

12 V 10

Picture not available
Image non disponible
Imagen no disponible
Immagine non disponibile
Nicht verfügbares Bild
Brak zdjęcia
Картина недоступна

Picture not available
Image non disponible
Imagen no disponible
Immagine non disponibile
Nicht verfügbares Bild
Brak zdjęcia
Картина недоступна

POLE SHOE, SCREWS SET 15 182041
BRUSHES AND SPRINGS SET 09 182114
Valeo 436019

D11E149 6 Kw 3(0) ↻

24 V 11

Picture not available
Image non disponible
Imagen no disponible
Immagine non disponibile
Nicht verfügbares Bild
Brak zdjęcia
Картина недоступна

Picture not available
Image non disponible
Imagen no disponible
Immagine non disponibile
Nicht verfügbares Bild
Brak zdjęcia
Картина недоступна

POLE SHOE, SCREWS SET 15 182041
PINION STOP ASSEMBLY 16 059454
Valeo 094955

D11E155 2,9 Kw 3(0) ↻

12 V 10

Picture not available
Image non disponible
Imagen no disponible
Immagine non disponibile
Nicht verfügbares Bild
Brak zdjęcia
Картина недоступна

Picture not available
Image non disponible
Imagen no disponible
Immagine non disponibile
Nicht verfügbares Bild
Brak zdjęcia
Картина недоступна

POLE SHOE, SCREWS SET 15 182041
BRUSHES AND SPRINGS SET 09 182114
Valeo 432571

D11E153 2,9 Kw 3(0) ↻

12 V 9

Picture not available
Image non disponible
Imagen no disponible
Immagine non disponibile
Nicht verfügbares Bild
Brak zdjęcia
Картина недоступна

Picture not available
Image non disponible
Imagen no disponible
Immagine non disponibile
Nicht verfügbares Bild
Brak zdjęcia
Картина недоступна

POLE SHOE, SCREWS SET 15 182041
BRUSHES AND SPRINGS SET 09 182114
PINION DRIVE 03 095442
PINION STOP ASSEMBLY 16 059453
SOLENOID SWITCH 04 182438
Valeo 436019

D11E156 2,5 Kw 3(0) ↻

12 V 9



POLE SHOE, SCREWS SET 15 182041
PINION STOP ASSEMBLY 16 059452
SOLENOID SWITCH 04 182438
Valeo 436019

D11E158 2,6 Kw 3(0) ↻

12 V 9

Picture not available
Image non disponible
Imagen no disponible
Immagine non disponibile
Nicht verfügbares Bild
Brak zdjęcia
Картина недоступна

Picture not available
Image non disponible
Imagen no disponible
Immagine non disponibile
Nicht verfügbares Bild
Brak zdjęcia
Картина недоступна

POLE SHOE, SCREWS SET 15 182041
PINION DRIVE 03 095976
PINION STOP ASSEMBLY 16 059453
SOLENOID SWITCH 04 182438
Valeo 436019

D11E159 1,95 Kw 3(0) ↻

12 V 9



POLE SHOE, SCREWS SET 15 182041
ARMATURE 02a 095981
PINION STOP ASSEMBLY 16 059453
SOLENOID SWITCH 04 182435
Valeo 436019

D11E161 2,5 Kw 4(1) ↻

12 V 9

Picture not available
Image non disponible
Imagen no disponible
Immagine non disponibile
Nicht verfügbares Bild
Brak zdjęcia
Картина недоступна

Picture not available
Image non disponible
Imagen no disponible
Immagine non disponibile
Nicht verfügbares Bild
Brak zdjęcia
Картина недоступна

POLE SHOE, SCREWS SET 15 182041
ARMATURE 02a 095955
PINION STOP ASSEMBLY 16 059452
SOLENOID SWITCH 04 182448
Valeo 436019

D11E163 2,2 Kw 3(3) ↻

12 V 9



POLE SHOE, SCREWS SET 15 182041
PINION STOP ASSEMBLY 16 073294
REPAIR KIT 24 182126
Valeo 436019

D11E164 2,2 Kw 3(3) ↻

12 V 9

Picture not available
Image non disponible
Imagen no disponible
Immagine non disponibile
Nicht verfügbares Bild
Brak zdjęcia
Картина недоступна

Picture not available
Image non disponible
Imagen no disponible
Immagine non disponibile
Nicht verfügbares Bild
Brak zdjęcia
Картина недоступна

POLE SHOE, SCREWS SET 15 182041
PINION STOP ASSEMBLY 16 073294
REPAIR KIT 24 182126
Valeo 436019

D11E165 1,95 Kw 3(0) ↻

12 V 9

Picture not available
Image non disponible
Imagen no disponible
Immagine non disponibile
Nicht verfügbares Bild
Brak zdjęcia
Картина недоступна

Picture not available
Image non disponible
Imagen no disponible
Immagine non disponibile
Nicht verfügbares Bild
Brak zdjęcia
Картина недоступна

POLE SHOE, SCREWS SET 15 182041
ARMATURE 02a 095981
PINION STOP ASSEMBLY 16 059453
SOLENOID SWITCH 04 182435
Valeo 432533

D11E167T 2,6 Kw 3(0) ↻

12 V 9

Picture not available
Image non disponible
Imagen no disponible
Immagine non disponibile
Nicht verfügbares Bild
Brak zdjęcia
Картина недоступна

Picture not available
Image non disponible
Imagen no disponible
Immagine non disponibile
Nicht verfügbares Bild
Brak zdjęcia
Картина недоступна

POLE SHOE, SCREWS SET 15 182041
PINION DRIVE 03 097394
PINION STOP ASSEMBLY 16 059452
SOLENOID SWITCH 04 182438
Valeo 436019

D11E169 2,9 Kw 3(3) ↻

12 V 9



POLE SHOE, SCREWS SET 15 182041
BRUSHES AND SPRINGS SET 09 182114
PINION STOP ASSEMBLY 16 097804
REPAIR KIT 24 182126
Valeo 436019

D11E170

2,2 Kw

3(0)



12 V



POLE SHOE, SCREWS SET 15
PINION STOP ASSEMBLY 16
REPAIR KIT 24
SOLENOID SWITCH 04

Valeo

182041
059453
182126
182438
436019

D11E172

2,5 Kw

3(1)



12 V



POLE SHOE, SCREWS SET 15
PINION DRIVE 03
PINION STOP ASSEMBLY 16
REPAIR KIT 24

Valeo

182041
099738
097804
182126
436019

D11E176

2,8 Kw

3(3)



12 V



POLE SHOE, SCREWS SET 15
BRUSHES AND SPRINGS SET 09
PINION STOP ASSEMBLY 16
REPAIR KIT 24

Valeo

182041
182114
097804
182126
436019

D11E177

2,4 Kw

3(3)



12 V



POLE SHOE, SCREWS SET 15
PINION STOP ASSEMBLY 16
REPAIR KIT 24
SPARE PART KIT 25

Valeo

182041
097804
182126
182322
436019

D11E178

2,8 Kw

3(0)



12 V



Picture not available
Image non disponible
Imagen no disponible
Immagine non disponibile
Nicht verfügbares Bild
Brak zdjęcia
Картина недоступна

Picture not available
Image non disponible
Imagen no disponible
Immagine non disponibile
Nicht verfügbares Bild
Brak zdjęcia
Картина недоступна

POLE SHOE, SCREWS SET 15
BRUSHES AND SPRINGS SET 09
PINION STOP ASSEMBLY 16
REPAIR KIT 24

Valeo

182041
182114
097804
182126
101503

D11E180

2,2 Kw

3(0)



12 V



Picture not available
Image non disponible
Imagen no disponible
Immagine non disponibile
Nicht verfügbares Bild
Brak zdjęcia
Картина недоступна

Picture not available
Image non disponible
Imagen no disponible
Immagine non disponibile
Nicht verfügbares Bild
Brak zdjęcia
Картина недоступна

POLE SHOE, SCREWS SET 15
PINION STOP ASSEMBLY 16
REPAIR KIT 24
SOLENOID SWITCH 04

Valeo

182041
059453
182126
182438
099198

D11E181

7 Kw

3(0)



48 V



Picture not available
Image non disponible
Imagen no disponible
Immagine non disponibile
Nicht verfügbares Bild
Brak zdjęcia
Картина недоступна

Picture not available
Image non disponible
Imagen no disponible
Immagine non disponibile
Nicht verfügbares Bild
Brak zdjęcia
Картина недоступна

POLE SHOE, SCREWS SET 15

Valeo

182041
102827

D11E184

2,5 Kw

3(0)



12 V



POLE SHOE, SCREWS SET 15
PINION STOP ASSEMBLY 16
SOLENOID SWITCH 04

Valeo

182041
097804
182438
436019



D11E187 2,4 Kw 3(3) ↻

12 V ⚙️9



POLE SHOE, SCREWS SET 🛠️ 15

182041

PINION STOP ASSEMBLY 🛠️ 16

097804

REPAIR KIT 🛠️ 24

182126

Valeo 436019

D11E188 2,5 Kw 4(1) ↻

12 V ⚙️10



POLE SHOE, SCREWS SET 🛠️ 15

182041

PINION STOP ASSEMBLY 🛠️ 16

097804

SOLENOID SWITCH 🛠️ 04

182448

Valeo 436019

D11E191 2,5 Kw 3(0) ↻

12 V ⚙️10



POLE SHOE, SCREWS SET 🛠️ 15

182041

PINION STOP ASSEMBLY 🛠️ 16

097804

SOLENOID SWITCH 🛠️ 04

182438

Valeo 436019

D11E192 2,5 Kw 4(1) ↻

12 V ⚙️10



POLE SHOE, SCREWS SET 🛠️ 15

182041

PINION STOP ASSEMBLY 🛠️ 16

097804

SOLENOID SWITCH 🛠️ 04

182448

Valeo 436019

D11E193 3,2 Kw 3(0) ↻

24 V ⚙️9

Picture not available
Image non disponible
Imagen no disponible
Immagine non disponibile
Nicht verfügbares Bild
Brak zdjęcia
Картина недоступна

Picture not available
Image non disponible
Imagen no disponible
Immagine non disponibile
Nicht verfügbares Bild
Brak zdjęcia
Картина недоступна

POLE SHOE, SCREWS SET 🛠️ 15

182041

PINION DRIVE 🛠️ 03

073301

Valeo 436019

D11E195 2,5 Kw 3(0) ↻

12 V ⚙️9



POLE SHOE, SCREWS SET 🛠️ 15

182041

PINION STOP ASSEMBLY 🛠️ 16

097804

SOLENOID SWITCH 🛠️ 04

182438

Valeo 436019

D11E198 2,5 Kw 3(0) ↻

24 V ⚙️9

Picture not available
Image non disponible
Imagen no disponible
Immagine non disponibile
Nicht verfügbares Bild
Brak zdjęcia
Картина недоступна

Picture not available
Image non disponible
Imagen no disponible
Immagine non disponibile
Nicht verfügbares Bild
Brak zdjęcia
Картина недоступна

POLE SHOE, SCREWS SET 🛠️ 15

182041

PINION STOP ASSEMBLY 🛠️ 16

594067

Valeo 181352

D11E202 0

0

Picture not available
Image non disponible
Imagen no disponible
Immagine non disponibile
Nicht verfügbares Bild
Brak zdjęcia
Картина недоступна

Picture not available
Image non disponible
Imagen no disponible
Immagine non disponibile
Nicht verfügbares Bild
Brak zdjęcia
Картина недоступна

POLE SHOE, SCREWS SET 🛠️ 15

182041

PINION DRIVE 🛠️ 03

097394

PINION STOP ASSEMBLY 🛠️ 16

059453

SOLENOID SWITCH 🛠️ 04

182438

Valeo 181516

D11E272

2,5 Kw

3(1)



12 V

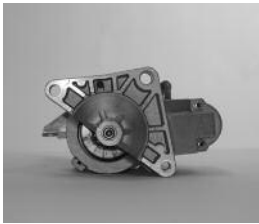

POLE SHOE, SCREWS SET 15
PINION STOP ASSEMBLY 16
REPAIR KIT 24

Valeo

182041
 097804
 182126
 436019

D11E74

2 Kw

3(0)



12 V



Picture not available
 Image non disponible
 Imagen no disponible
 Immagine non disponibile
 Nicht verfügbares Bild
 Brak zdjęcia
 Картина недоступна

Picture not available
 Image non disponible
 Imagen no disponible
 Immagine non disponibile
 Nicht verfügbares Bild
 Brak zdjęcia
 Картина недоступна

POLE SHOE, SCREWS SET 15
BRAIDED WIRE OR JUMPER 19
PINION DRIVE 03
PINION STOP ASSEMBLY 16
SOLENOID SWITCH 04

182041
 182190
 054335
 059452
 182442

D11E74T

2 Kw

3(0)



12 V



Picture not available
 Image non disponible
 Imagen no disponible
 Immagine non disponibile
 Nicht verfügbares Bild
 Brak zdjęcia
 Картина недоступна

Picture not available
 Image non disponible
 Imagen no disponible
 Immagine non disponibile
 Nicht verfügbares Bild
 Brak zdjęcia
 Картина недоступна

POLE SHOE, SCREWS SET 15
BRAIDED WIRE OR JUMPER 19
PINION DRIVE 03
PINION STOP ASSEMBLY 16
SOLENOID SWITCH 04

182041
 182190
 054335
 059452
 182442

D11E78

2 Kw

3(0)



12 V



Picture not available
 Image non disponible
 Imagen no disponible
 Immagine non disponibile
 Nicht verfügbares Bild
 Brak zdjęcia
 Картина недоступна

Picture not available
 Image non disponible
 Imagen no disponible
 Immagine non disponibile
 Nicht verfügbares Bild
 Brak zdjęcia
 Картина недоступна

POLE SHOE, SCREWS SET 15
PINION STOP ASSEMBLY 16
SOLENOID SWITCH 04

Valeo

182041
 059452
 182442
 054591

D11E84

2 Kw

3(0)



12 V



Picture not available
 Image non disponible
 Imagen no disponible
 Immagine non disponibile
 Nicht verfügbares Bild
 Brak zdjęcia
 Картина недоступна

Picture not available
 Image non disponible
 Imagen no disponible
 Immagine non disponibile
 Nicht verfügbares Bild
 Brak zdjęcia
 Картина недоступна

POLE SHOE, SCREWS SET 15
PINION DRIVE 03
PINION STOP ASSEMBLY 16
SOLENOID SWITCH 04

Valeo

432567/436071

D11E89TE

5,65 Kw

3(0)



24 V



Picture not available
 Image non disponible
 Imagen no disponible
 Immagine non disponibile
 Nicht verfügbares Bild
 Brak zdjęcia
 Картина недоступна

Picture not available
 Image non disponible
 Imagen no disponible
 Immagine non disponibile
 Nicht verfügbares Bild
 Brak zdjęcia
 Картина недоступна

POLE SHOE, SCREWS SET 15
BRUSHES AND SPRINGS SET 09
PINION STOP ASSEMBLY 16

Valeo

436019

D11E90T

5,65 Kw

3(0)



24 V



Picture not available
 Image non disponible
 Imagen no disponible
 Immagine non disponibile
 Nicht verfügbares Bild
 Brak zdjęcia
 Картина недоступна

Picture not available
 Image non disponible
 Imagen no disponible
 Immagine non disponibile
 Nicht verfügbares Bild
 Brak zdjęcia
 Картина недоступна

POLE SHOE, SCREWS SET 15
BRUSHES AND SPRINGS SET 09
PINION STOP ASSEMBLY 16

Valeo

057537

D11E92

2,2 Kw

3(0)



12 V



N

Picture not available
 Image non disponible
 Imagen no disponible
 Immagine non disponibile
 Nicht verfügbares Bild
 Brak zdjęcia
 Картина недоступна

Picture not available
 Image non disponible
 Imagen no disponible
 Immagine non disponibile
 Nicht verfügbares Bild
 Brak zdjęcia
 Картина недоступна

POLE SHOE, SCREWS SET 15
BRUSHES AND SPRINGS SET 09
PINION DRIVE 03
SOLENOID SWITCH 04

Valeo

182041
 182114
 056328
 *182434
 055592

D11E98TE 5,65 Kw 3(0)

24 V

Picture not available
Image non disponible
Imagen no disponible
Immagine non disponibile
Nicht verfügbares Bild
Brak zdjęć
Картина недоступна

Picture not available
Image non disponible
Imagen no disponible
Immagine non disponibile
Nicht verfügbares Bild
Brak zdjęć
Картина недоступна

POLE SHOE, SCREWS SET 182041
BRUSHES AND SPRINGS SET 182145
PINION STOP ASSEMBLY 059454
Valeo 072885

D13E105 8,4 Kw 3(0)

24 V 135°

Picture not available
Image non disponible
Imagen no disponible
Immagine non disponibile
Nicht verfügbares Bild
Brak zdjęć
Картина недоступна

Picture not available
Image non disponible
Imagen no disponible
Immagine non disponibile
Nicht verfügbares Bild
Brak zdjęć
Картина недоступна

ARMATURE 059724
DRIVE END HOUSING 300812
FIELD SERIES COIL SET 094442
PINION DRIVE 589077
Valeo 436019

D13E107TE 8,8 Kw 4(0)

24 V

Picture not available
Image non disponible
Imagen no disponible
Immagine non disponibile
Nicht verfügbares Bild
Brak zdjęć
Картина недоступна

Picture not available
Image non disponible
Imagen no disponible
Immagine non disponibile
Nicht verfügbares Bild
Brak zdjęć
Картина недоступна

COVER AND MOVING CONTACT 182148
PINION DRIVE 101598
SOLENOID SWITCH 181142
Valeo 436019

D13E109TE 8,8 Kw 3(0)

24 V

Picture not available
Image non disponible
Imagen no disponible
Immagine non disponibile
Nicht verfügbares Bild
Brak zdjęć
Картина недоступна

Picture not available
Image non disponible
Imagen no disponible
Immagine non disponibile
Nicht verfügbares Bild
Brak zdjęć
Картина недоступна

POLE SHOE, SCREWS SET 182041
ARMATURE 075914
BRAKE WASHER, INTERMEDIATE HOUSING 182197
BRUSH HOLDER PLATE ASSEMBLY 075907
BRUSHES AND SPRINGS SET 182146
BUSHING KIT 182158
COVER AND MOVING CONTACT 182148
FIELD SERIES COIL SET 182228
INTERMEDIATE HOUSING ASSEMBLY 300815
BRAIDED WIRE OR JUMPER 182159
PINION DRIVE 101598
PINION FORK SET 182156
SOLENOID SWITCH 181142
ARMATURE SHIM 079101
Valeo 097997

D13E110TE 8,8 Kw 3(0)

24 V

Picture not available
Image non disponible
Imagen no disponible
Immagine non disponibile
Nicht verfügbares Bild
Brak zdjęć
Картина недоступна

Picture not available
Image non disponible
Imagen no disponible
Immagine non disponibile
Nicht verfügbares Bild
Brak zdjęć
Картина недоступна

POLE SHOE, SCREWS SET 182041
ARMATURE 075914
BRAKE WASHER, INTERMEDIATE HOUSING 182197
BRUSH HOLDER PLATE ASSEMBLY 075907
BRUSHES AND SPRINGS SET 182146
BUSHING KIT 182158
COVER AND MOVING CONTACT 182148
FIELD SERIES COIL SET 182228
INTERMEDIATE HOUSING ASSEMBLY 300815
BRAIDED WIRE OR JUMPER 182159
PINION DRIVE 101598
PINION FORK SET 182156
SOLENOID SWITCH 181142
ARMATURE SHIM 079101
Valeo 436019

























D13E111 8,4 Kw 3(0)























24 V

Picture not available
Image non disponible
Imagen no disponible
Immagine non disponibile
Nicht verfügbares Bild
Brak zdjęć
Картина недоступна

Picture not available
Image non disponible
Imagen no disponible
Immagine non disponibile
Nicht verfügbares Bild
Brak zdjęć
Картина недоступна

ARMATURE 059724
FIELD SERIES COIL SET 094442
PINION DRIVE 589077
PINION FORK SET 182154
SOLENOID SWITCH 182424
SPARE PART KIT 182341
Valeo 436019

D13E116	0	0	
0		0	
<p>Picture not available Image non disponible Imagen no disponible Immagine non disponibile Nicht verfügbares Bild Brak zdjęcia Картина недоступна</p>		<p>Picture not available Image non disponible Imagen no disponible Immagine non disponibile Nicht verfügbares Bild Brak zdjęcia Картина недоступна</p>	
PINION DRIVE  03			097147
SOLENOID SWITCH  04			182424
Valeo			105677
D13E117TE	8,8 Kw	4(0)	
24 V		 12	
<p>Picture not available Image non disponible Imagen no disponible Immagine non disponibile Nicht verfügbares Bild Brak zdjęcia Картина недоступна</p>		<p>Picture not available Image non disponible Imagen no disponible Immagine non disponibile Nicht verfügbares Bild Brak zdjęcia Картина недоступна</p>	
SOLENOID SWITCH  04			181142
Valeo			436019
D13E118TE	8,8 Kw	4(0)	
24 V		 12	
<p>Picture not available Image non disponible Imagen no disponible Immagine non disponibile Nicht verfügbares Bild Brak zdjęcia Картина недоступна</p>		<p>Picture not available Image non disponible Imagen no disponible Immagine non disponibile Nicht verfügbares Bild Brak zdjęcia Картина недоступна</p>	
SOLENOID SWITCH  04			181142
Valeo			436019
D13E123TE	8,8 Kw	4	
24 V		 12	
<p>Picture not available Image non disponible Imagen no disponible Immagine non disponibile Nicht verfügbares Bild Brak zdjęcia Картина недоступна</p>		<p>Picture not available Image non disponible Imagen no disponible Immagine non disponibile Nicht verfügbares Bild Brak zdjęcia Картина недоступна</p>	
POLE SHOE, SCREWS SET  15			182041
ARMATURE  02a			106062
BRAKE WASHER, INTERMEDIATE HOUSING  18			182197
BRUSH HOLDER PLATE ASSEMBLY  08			184630
BRUSHES AND SPRINGS SET  09			182037
BUSHING KIT  10			182158
FIELD SERIES COIL SET  06			182039
GASKET SET  20			182038
BRAIDED WIRE OR JUMPER  19			182159
PINION DRIVE  03			103066
SERIE COIL'S TERMINAL  17			182180
PINION FORK SET  11			182036
SOLENOID SWITCH  04			181142
ARMATURE SHIM  12			182160
Valeo			436019

D13E77	7,4 Kw	3(0)	
24 V		 12	
<p>Picture not available Image non disponible Imagen no disponible Immagine non disponibile Nicht verfügbares Bild Brak zdjęcia Картина недоступна</p>		<p>Picture not available Image non disponible Imagen no disponible Immagine non disponibile Nicht verfügbares Bild Brak zdjęcia Картина недоступна</p>	
COVER AND MOVING CONTACT  05			182148
SOLENOID SWITCH  04			181142
Valeo			075606
D13E81	7,7 Kw	3(0)	
24 V		 10	
<p>Picture not available Image non disponible Imagen no disponible Immagine non disponibile Nicht verfügbares Bild Brak zdjęcia Картина недоступна</p>		<p>Picture not available Image non disponible Imagen no disponible Immagine non disponibile Nicht verfügbares Bild Brak zdjęcia Картина недоступна</p>	
PINION DRIVE  03			097147
SOLENOID SWITCH  04			182424
Valeo			436019
D13E82T	7,7 Kw	3(0)	
24 V		 10	
<p>Picture not available Image non disponible Imagen no disponible Immagine non disponibile Nicht verfügbares Bild Brak zdjęcia Картина недоступна</p>		<p>Picture not available Image non disponible Imagen no disponible Immagine non disponibile Nicht verfügbares Bild Brak zdjęcia Картина недоступна</p>	
POLE SHOE, SCREWS SET  15			182041
BRUSH HOLDER PLATE ASSEMBLY  08			182187
BRUSHES AND SPRINGS SET  09			182145
BUSHING KIT  10			182157
COVER AND MOVING CONTACT  05			182149
FIELD SHUNT COIL SET  07			072177
GASKET SET  20			072175
PINION STOP ASSEMBLY  16			059454
SERIE COIL'S TERMINAL  17			589161
PINION FORK SET  11			182156
SHUNT COIL'S TERMINAL  21			070926
ARMATURE SHIM  12			182155
Valeo			076580

D13E90TE 8,4 Kw 3(0)

24 V 10 N

Picture not available
Image non disponible
Imagen no disponible
Immagine non disponibile
Nicht verfügbares Bild
Brak zdjęcia
Картина недоступна

Picture not available
Image non disponible
Imagen no disponible
Immagine non disponibile
Nicht verfügbares Bild
Brak zdjęcia
Картина недоступна

- POLE SHOE, SCREWS SET** 15 182041
 - BRAKE WASHER, INTERMEDIATE HOUSING** 18 182197
 - BUSHING KIT** 10 182158
 - FIELD SERIES COIL SET** 06 094442
 - FIELD SHUNT COIL SET** 07 072177
 - BRAIDED WIRE OR JUMPER** 19 182159
 - PINION DRIVE** 03 589123
 - PINION STOP ASSEMBLY** 16 059454
 - PINION FORK SET** 11 182154
 - SHUNT COIL'S TERMINAL** 21 070926
 - ARMATURE SHIM** 12 079101
- Valeo** **079826**

D13E95 8,4 Kw 3(0)

24 V 12 N

Picture not available
Image non disponible
Imagen no disponible
Immagine non disponibile
Nicht verfügbares Bild
Brak zdjęcia
Картина недоступна

Picture not available
Image non disponible
Imagen no disponible
Immagine non disponibile
Nicht verfügbares Bild
Brak zdjęcia
Картина недоступна

- ARMATURE** 02a 059724
 - FIELD SERIES COIL SET** 06 094442
 - PINION DRIVE** 03 589077
 - PINION FORK SET** 11 182154
 - SOLENOID SWITCH** 04 182424
 - SPARE PART KIT** 25 182341
- Valeo** **436019**

D13E96TE 8,8 Kw 3(0)

24 V 12 N

Picture not available
Image non disponible
Imagen no disponible
Immagine non disponibile
Nicht verfügbares Bild
Brak zdjęcia
Картина недоступна

Picture not available
Image non disponible
Imagen no disponible
Immagine non disponibile
Nicht verfügbares Bild
Brak zdjęcia
Картина недоступна

- COVER AND MOVING CONTACT** 05 182148
 - PINION DRIVE** 03 101598
 - SOLENOID SWITCH** 04 181142
- Valeo** **094773**

D13HP601 7,2 Kw 3(0)

24 V 70° 11 N

Picture not available
Image non disponible
Imagen no disponible
Immagine non disponibile
Nicht verfügbares Bild
Brak zdjęcia
Картина недоступна

Picture not available
Image non disponible
Imagen no disponible
Immagine non disponibile
Nicht verfügbares Bild
Brak zdjęcia
Картина недоступна

- BRUSH HOLDER PLATE ASSEMBLY** 08 594301
 - BRUSHES AND SPRINGS SET** 09 594286
 - DRIVE END HOUSING** 14 594299
 - INDUCTION COIL** 27 594221
 - INTERMEDIATE HOUSING ASSEMBLY** 22 594201
 - PINION DRIVE** 03 594295
 - COVER AND MOVING CONTACT** 05 594297
 - REPAIR KIT** 24 594302
 - SOLENOID SWITCH** 04 594296
- Valeo** **436019**

D13HP605 6,6 Kw 4(0)

24 V 45° 12 N

Picture not available
Image non disponible
Imagen no disponible
Immagine non disponibile
Nicht verfügbares Bild
Brak zdjęcia
Картина недоступна

Picture not available
Image non disponible
Imagen no disponible
Immagine non disponibile
Nicht verfügbares Bild
Brak zdjęcia
Картина недоступна

- ARMATURE** 02a 594219
 - REPAIR KIT** 24 594200
 - BRUSH HOLDER PLATE ASSEMBLY** 08 594222
 - BRUSHES AND SPRINGS SET** 09 594286
 - COMMUTATOR END SHIELD, ASSEMBLY** 13 594223
 - DRIVE END HOUSING** 14 594204
 - INDUCTION COIL** 27 594221
 - INTERMEDIATE HOUSING ASSEMBLY** 22 594201
 - PINION DRIVE** 03 103066
 - PINION FORK SET** 11 182036
 - SOLENOID SWITCH** 04 594220
- Valeo** **436019**

D13HP607 6,6 Kw 3(0)

24 V 60° 12 N

Picture not available
Image non disponible
Imagen no disponible
Immagine non disponibile
Nicht verfügbares Bild
Brak zdjęcia
Картина недоступна

Picture not available
Image non disponible
Imagen no disponible
Immagine non disponibile
Nicht verfügbares Bild
Brak zdjęcia
Картина недоступна

- ARMATURE** 02a 594219
 - REPAIR KIT** 24 594200
 - BRUSH HOLDER PLATE ASSEMBLY** 08 594222
 - BRUSHES AND SPRINGS SET** 09 594286
 - COMMUTATOR END SHIELD, ASSEMBLY** 13 594223
 - DRIVE END HOUSING** 14 594218
 - INDUCTION COIL** 27 594221
 - INTERMEDIATE HOUSING ASSEMBLY** 22 594201
 - PINION DRIVE** 03 103066
 - PINION FORK SET** 11 182036
 - SOLENOID SWITCH** 04 594220
- Valeo** **436019**

D13HP608 7,2 Kw 3(0) ↻

24 V 55° 12 N

Picture not available
Image non disponible
Imagen no disponible
Immagine non disponibile
Nicht verfügbares Bild
Brak zdjęcia
Картина недоступна

Picture not available
Image non disponible
Imagen no disponible
Immagine non disponibile
Nicht verfügbares Bild
Brak zdjęcia
Картина недоступна

- ARMATURE** 02a 594219
 - REPAIR KIT** 24 594200
 - BRUSH HOLDER PLATE ASSEMBLY** 08 594222
 - BRUSHES AND SPRINGS SET** 09 594286
 - COMMUTATOR END SHIELD, ASSEMBLY** 13 594223
 - COVER AND MOVING CONTACT** 05 594292
 - DRIVE END HOUSING** 14 594205
 - INDUCTION COIL** 27 594221
 - INTERMEDIATE HOUSING ASSEMBLY** 22 594201
 - PINION DRIVE** 03 103066
 - PINION FORK SET** 11 594293
 - SOLENOID SWITCH** 04 594220
- Valeo** 436019

D13HP609 7,2 Kw 3(0) ↻

24 V 28° 12 N

Picture not available
Image non disponible
Imagen no disponible
Immagine non disponibile
Nicht verfügbares Bild
Brak zdjęcia
Картина недоступна

Picture not available
Image non disponible
Imagen no disponible
Immagine non disponibile
Nicht verfügbares Bild
Brak zdjęcia
Картина недоступна

- ARMATURE** 02a 594219
 - REPAIR KIT** 24 594200
 - BRUSH HOLDER PLATE ASSEMBLY** 08 594329
 - BRUSHES AND SPRINGS SET** 09 594286
 - COMMUTATOR END SHIELD, ASSEMBLY** 13 594223
 - DRIVE END HOUSING** 14 594226
 - INDUCTION COIL** 27 594221
 - INTERMEDIATE HOUSING ASSEMBLY** 22 594201
 - PINION DRIVE** 03 103066
 - BUSHING KIT** 10 594202
 - COVER AND MOVING CONTACT** 05 594328
 - PINION FORK SET** 11 594293
 - SOLENOID SWITCH** 04 594193
- Valeo** 436019

D13HP613 7,2 Kw 3(0) ↻

24 V 55° 11 N

Picture not available
Image non disponible
Imagen no disponible
Immagine non disponibile
Nicht verfügbares Bild
Brak zdjęcia
Картина недоступна

Picture not available
Image non disponible
Imagen no disponible
Immagine non disponibile
Nicht verfügbares Bild
Brak zdjęcia
Картина недоступна

- ARMATURE** 02a 594219
 - REPAIR KIT** 24 594200
 - BRUSH HOLDER PLATE ASSEMBLY** 08 594301
 - BRUSHES AND SPRINGS SET** 09 594286
 - DRIVE END HOUSING** 14 594205
 - INDUCTION COIL** 27 594221
 - INTERMEDIATE HOUSING ASSEMBLY** 22 594201
 - PINION DRIVE** 03 594291
 - PINION FORK SET** 11 594293
 - SOLENOID SWITCH** 04 181142
- Valeo** 436019

D13HP701 7,7 Kw 3(0) ↻

24 V 140° 12

Picture not available
Image non disponible
Imagen no disponible
Immagine non disponibile
Nicht verfügbares Bild
Brak zdjęcia
Картина недоступна

Picture not available
Image non disponible
Imagen no disponible
Immagine non disponibile
Nicht verfügbares Bild
Brak zdjęcia
Картина недоступна

- REPAIR KIT** 24 594200
 - BRUSH HOLDER PLATE ASSEMBLY** 08 594076
 - BRUSHES AND SPRINGS SET** 09 182037
 - COMMUTATOR END SHIELD, ASSEMBLY** 13 594198
 - INDUCTION COIL** 27 594195
 - INTERMEDIATE HOUSING ASSEMBLY** 22 594201
 - PINION DRIVE** 03 103066
 - BUSHING KIT** 10 594202
 - PINION FORK SET** 11 182036
 - SOLENOID SWITCH** 04 594193
- Valeo** 436019

D13HP702 7,7 Kw 3(0) ↻

24 V 60° 12 N

Picture not available
Image non disponible
Imagen no disponible
Immagine non disponibile
Nicht verfügbares Bild
Brak zdjęcia
Картина недоступна

Picture not available
Image non disponible
Imagen no disponible
Immagine non disponibile
Nicht verfügbares Bild
Brak zdjęcia
Картина недоступна

- ARMATURE** 02a 594192
 - REPAIR KIT** 24 594200
 - BRUSH HOLDER PLATE ASSEMBLY** 08 594076
 - BRUSHES AND SPRINGS SET** 09 182037
 - COMMUTATOR END SHIELD, ASSEMBLY** 13 594198
 - DRIVE END HOUSING** 14 594218
 - INDUCTION COIL** 27 594195
 - INTERMEDIATE HOUSING ASSEMBLY** 22 594201
 - PINION DRIVE** 03 103066
 - PINION FORK SET** 11 182036
 - SOLENOID SWITCH** 04 594075
- Valeo** 436019

D13HP703 7,7 Kw 4(0) ↻

24 V 45° 12 N

Picture not available
Image non disponible
Imagen no disponible
Immagine non disponibile
Nicht verfügbares Bild
Brak zdjęcia
Картина недоступна

Picture not available
Image non disponible
Imagen no disponible
Immagine non disponibile
Nicht verfügbares Bild
Brak zdjęcia
Картина недоступна

- ARMATURE** 02a 594192
 - REPAIR KIT** 24 594200
 - BRUSH HOLDER PLATE ASSEMBLY** 08 184630
 - BRUSHES AND SPRINGS SET** 09 182037
 - DRIVE END HOUSING** 14 594204
 - INDUCTION COIL** 27 594195
 - INTERMEDIATE HOUSING ASSEMBLY** 22 594201
 - PINION DRIVE** 03 103066
 - PINION FORK SET** 11 182036
 - SOLENOID SWITCH** 04 181142
- Valeo** 436019



D13HP704	7,7 Kw	3(0)	↻
24 V	146°	12	
<p>Picture not available Image non disponible Imagen no disponible Immagine non disponibile Nicht verfügbares Bild Brak zdjęcia Картина недоступна</p>		<p>Picture not available Image non disponible Imagen no disponible Immagine non disponibile Nicht verfügbares Bild Brak zdjęcia Картина недоступна</p>	
ARMATURE 02a		594192	
REPAIR KIT 24		594200	
BRUSH HOLDER PLATE ASSEMBLY 08		594076	
BRUSHES AND SPRINGS SET 09		182037	
COMMUTATOR END SHIELD, ASSEMBLY 13		594198	
DRIVE END HOUSING 14		594226	
INDUCTION COIL 27		594195	
INDUCTION COIL 27		594224	
INTERMEDIATE HOUSING ASSEMBLY 22		594201	
PINION DRIVE 03		103066	
BUSHING KIT 10		594202	
PINION FORK SET 11		594225	
SOLENOID SWITCH 04		594193	
Valeo		436019	

D13HP705	7,7 Kw	3(0)	↻
24 V		12	
<p>Picture not available Image non disponible Imagen no disponible Immagine non disponibile Nicht verfügbares Bild Brak zdjęcia Картина недоступна</p>		<p>Picture not available Image non disponible Imagen no disponible Immagine non disponibile Nicht verfügbares Bild Brak zdjęcia Картина недоступна</p>	
ARMATURE 02a		594192	
BRUSH HOLDER PLATE ASSEMBLY 08		594076	
BRUSHES AND SPRINGS SET 09		182037	
COMMUTATOR END SHIELD, ASSEMBLY 13		594198	
INDUCTION COIL 27		594195	
PINION DRIVE 03		103066	
PINION FORK SET 11		182036	
SOLENOID SWITCH 04		594075	
Valeo		436019	

D13HP709	8 Kw	3(0)	↻
24 V		11	
<p>Picture not available Image non disponible Imagen no disponible Immagine non disponibile Nicht verfügbares Bild Brak zdjęcia Картина недоступна</p>		<p>Picture not available Image non disponible Imagen no disponible Immagine non disponibile Nicht verfügbares Bild Brak zdjęcia Картина недоступна</p>	
ARMATURE 02a		594192	
REPAIR KIT 24		594200	
BRUSH HOLDER PLATE ASSEMBLY 08		594076	
BRUSHES AND SPRINGS SET 09		182037	
COMMUTATOR END SHIELD, ASSEMBLY 13		594198	
COVER AND MOVING CONTACT 05		594292	
DRIVE END HOUSING 14		594205	
INDUCTION COIL 27		594195	
INTERMEDIATE HOUSING ASSEMBLY 22		594201	
PINION DRIVE 03		594291	
PINION FORK SET 11		594293	
SOLENOID SWITCH 04		594075	
Valeo		436019	

D15E30	9,2 Kw	3	↻
24 V	140°	12	
<p>Picture not available Image non disponible Imagen no disponible Immagine non disponibile Nicht verfügbares Bild Brak zdjęcia Картина недоступна</p>		<p>Picture not available Image non disponible Imagen no disponible Immagine non disponibile Nicht verfügbares Bild Brak zdjęcia Картина недоступна</p>	
SPARE PART KIT 25		182341	
Valeo		436019	

D15E30TE	9,2 Kw	3(0)	↻
24 V	140°	12	
<p>Picture not available Image non disponible Imagen no disponible Immagine non disponibile Nicht verfügbares Bild Brak zdjęcia Картина недоступна</p>		<p>Picture not available Image non disponible Imagen no disponible Immagine non disponibile Nicht verfügbares Bild Brak zdjęcia Картина недоступна</p>	

POLE SHOE, SCREWS SET 15		182041	
BRAKE WASHER, INTERMEDIATE HOUSING 18		182197	
BRUSH HOLDER PLATE ASSEMBLY 08		182467	
BRUSHES AND SPRINGS SET 09		182162	
GASKET SET 20		182277	
INTERMEDIATE HOUSING ASSEMBLY 22		079148	
PINION DRIVE 03		589173	
PINION STOP ASSEMBLY 16		094786	
PINION FORK SET 11		182163	
SOLENOID SWITCH 04		182430	
ARMATURE SHIM 12		182165	
THROUGH BOLTS SET 23		092368	
Valeo		436019	

D6G1	1,3 Kw	2(1)	↻
12 V	75°	9	N



ARMATURE 02a		594650	
BRUSH HOLDER PLATE ASSEMBLY 08		594651	
DRIVE END HOUSING 14		594643	
INDUCTION COIL 27		594648	
PINION DRIVE 03		594644	
PIGNON DRIVE SHAFT ASSEMBLY 02b		595660	
REPAIR KIT 24		594647	
PINION FORK SET 11		594645	
SOLENOID SWITCH 04		594646	
Valeo		436019	

D6G2 1,2 Kw 2(0) ↻

12 V 37° 9 N



ARMATURE 02a 594650
BRUSH HOLDER PLATE ASSEMBLY 08 594674
DRIVE END HOUSING 14 594684
INDUCTION COIL 27 594687
PINION DRIVE 03 594685
PIGNON DRIVE SHAFT ASSEMBLY 02b 594688
REPAIR KIT 24 594647
PINION FORK SET 11 594645
SOLENOID SWITCH 04 594686
Valeo 436019

D6G3 1,3 Kw 3(1) ↻

12 V 55° 9 N



ARMATURE 02a 594650
BRUSH HOLDER PLATE ASSEMBLY 08 594706
DRIVE END HOUSING 14 594705
INDUCTION COIL 27 594648
PINION DRIVE 03 594644
PIGNON DRIVE SHAFT ASSEMBLY 02b 595660
REPAIR KIT 24 594647
PINION FORK SET 11 594645
SOLENOID SWITCH 04 594348
Valeo 436019

D6G32 1,3 Kw 2(1) ↻

12 V 75° 9 N



ARMATURE 02a 594650
BRUSH HOLDER PLATE ASSEMBLY 08 594651
DRIVE END HOUSING 14 594754
INDUCTION COIL 27 594648
PINION DRIVE 03 594644
PIGNON DRIVE SHAFT ASSEMBLY 02b 595660
REPAIR KIT 24 594647
PINION FORK SET 11 594645
SOLENOID SWITCH 04 594646
Valeo 436019

D6G321 1,3 Kw 2(1) ↻

12 V 75° 9 N



ARMATURE 02a 594650
BRUSH HOLDER PLATE ASSEMBLY 08 594651
INDUCTION COIL 27 594648
PINION DRIVE 03 594644
PIGNON DRIVE SHAFT ASSEMBLY 02b 595721
REPAIR KIT 24 594647
PINION FORK SET 11 594645
Valeo 436019

D6G33 1,2 Kw 2(1) ↻

12 V 75° 9 N

Picture not available
 Image non disponible
 Imagen no disponible
 Immagine non disponibile
 Nicht verfügbares Bild
 Brak zdjęcia
 Картина недоступна

Picture not available
 Image non disponible
 Imagen no disponible
 Immagine non disponibile
 Nicht verfügbares Bild
 Brak zdjęcia
 Картина недоступна

ARMATURE 02a 594650
BRUSH HOLDER PLATE ASSEMBLY 08 594774
DRIVE END HOUSING 14 594754
INDUCTION COIL 27 594648
PINION DRIVE 03 594644
PIGNON DRIVE SHAFT ASSEMBLY 02b 595660
REPAIR KIT 24 594647
PINION FORK SET 11 594645
Valeo 436019

D6G332 1,3 Kw 2(1) ↻

12 V 75° 9 N

Picture not available
 Image non disponible
 Imagen no disponible
 Immagine non disponibile
 Nicht verfügbares Bild
 Brak zdjęcia
 Картина недоступна

Picture not available
 Image non disponible
 Imagen no disponible
 Immagine non disponibile
 Nicht verfügbares Bild
 Brak zdjęcia
 Картина недоступна

ARMATURE 02a 594650
INDUCTION COIL 27 594648
PINION DRIVE 03 594644
Valeo 436019



D6G5

1,25 Kw

2(0)



12 V

38°



N

**ARMATURE** 02a

594650

BRUSH HOLDER PLATE ASSEMBLY 08

594706

DRIVE END HOUSING 14

594723

INDUCTION COIL 27

594648

PINION DRIVE 03

594644

PIGNON DRIVE SHAFT ASSEMBLY 02b

595722

REPAIR KIT 24

594647

PINION FORK SET 11

594645

SOLENOID SWITCH 04

594724

Valeo**436019****D6GS11**

1,1 Kw

3(0)



12 V

44°



N

**BRUSH HOLDER PLATE ASSEMBLY** 08

594674

PINION DRIVE 03

594665

REPAIR KIT 24

594669

SOLENOID SWITCH 04

*595726

Valeo**436019****D6GS11M**

1,1 Kw

3(0)



12 V

42°



N

**BRUSH HOLDER PLATE ASSEMBLY** 08

594674

PINION DRIVE 03

594665

REPAIR KIT 24

594669

SOLENOID SWITCH 04

*595726

Valeo**436019****D6GS12**

1,1 Kw

2(0)



12 V

41°



N

**BRUSH HOLDER PLATE ASSEMBLY** 08

594674

DRIVE END HOUSING 14

594662

REPAIR KIT 24

594669

SOLENOID SWITCH 04

*595726

Valeo**436019****D6GS12M**

1,1 Kw

2(0)



12 V

41°



N

**BRUSH HOLDER PLATE ASSEMBLY** 08

594674

REPAIR KIT 24

594669

SOLENOID SWITCH 04

*595726

Valeo**436019****D6GS13**

1,1 Kw

2(0)



12 V

41°



N

**BRUSH HOLDER PLATE ASSEMBLY** 08

594674

DRIVE END HOUSING 14

594663

PINION DRIVE 03

594665

REPAIR KIT 24

594669

SOLENOID SWITCH 04

*595726

Valeo**436019****D6GS13M**

1,1 Kw

2(0)



12 V

41°



N

**BRUSH HOLDER PLATE ASSEMBLY** 08

594674

PINION DRIVE 03

594665

REPAIR KIT 24

594669

SOLENOID SWITCH 04

*595726

Valeo**436019****D6GS14**

1,1 Kw

2(0)



12 V

42°



N

**BRUSH HOLDER PLATE ASSEMBLY** 08

594674

DRIVE END HOUSING 14

594664

PINION DRIVE 03

594666

REPAIR KIT 24

594669

SOLENOID SWITCH 04

*595726

Valeo**436019**

D6GS14M 1,1 Kw 3(0) ↻

12 V 42° ↻ 10 N



- BRUSH HOLDER PLATE ASSEMBLY** 🛠️08 594674
 - PINION DRIVE** 🛠️03 594666
 - REPAIR KIT** 🛠️24 594669
 - SOLENOID SWITCH** 🛠️04 *595726
- Valeo** 436019

D6GS19 1,1 Kw 3(2) ↻

12 V 31° ↻ 9 N

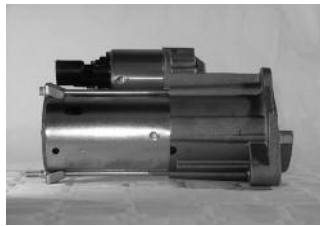

- ARMATURE** 🛠️02a 594650
 - BRUSH HOLDER PLATE ASSEMBLY** 🛠️08 594720
 - DRIVE END HOUSING** 🛠️14 594715
 - PINION DRIVE** 🛠️03 594716
 - PIGNON DRIVE SHAFT ASSEMBLY** 🛠️02b 594719
 - REPAIR KIT** 🛠️24 594717
 - SOLENOID SWITCH** 🛠️04 594617
- Valeo** 436019

D6RA10 1,2 Kw 3(1) ↻

12 V 9 N



- ARMATURE** 🛠️02a 594526
 - BRUSHES AND SPRINGS SET** 🛠️09 594064
 - CONNECTION SET** 🛠️26 594072
 - INDUCTION COIL** 🛠️27 594534
 - PIGNON DRIVE SHAFT ASSEMBLY** 🛠️02b 594538
 - REDUCTION GEAR ASSEMBLY** 🛠️02 594019
 - REPAIR KIT** 🛠️24 594084
 - PINION FORK SET** 🛠️11 594068
 - SOLENOID SWITCH** 🛠️04 594045
- Valeo** 436019

D6RA100 1,4 Kw 3(1) ↻

12 V 55° ↻ 10 N



- ARMATURE** 🛠️02a 594530
 - BRUSHES AND SPRINGS SET** 🛠️09 594423
 - CONNECTION SET** 🛠️26 594424
 - DRIVE END HOUSING** 🛠️14 594595
 - INDUCTION COIL** 🛠️27 594535
 - PINION DRIVE** 🛠️03 594252
 - PIGNON DRIVE SHAFT ASSEMBLY** 🛠️02b 594549
 - REDUCTION GEAR ASSEMBLY** 🛠️02 594412
 - REPAIR KIT** 🛠️24 594242
 - PINION FORK SET** 🛠️11 594068
 - SOLENOID SWITCH** 🛠️04 594426
- Valeo** 436019

D6RA104 1,4 Kw 3(3) ↻

12 V 32° ↻ 11 N



- ARMATURE** 🛠️02a 594530
 - BRUSHES AND SPRINGS SET** 🛠️09 594386
 - CONNECTION SET** 🛠️26 594385
 - DRIVE END HOUSING** 🛠️14 594596
 - INDUCTION COIL** 🛠️27 594535
 - PINION DRIVE** 🛠️03 594382
 - PIGNON DRIVE SHAFT ASSEMBLY** 🛠️02b 594543
 - REDUCTION GEAR ASSEMBLY** 🛠️02 594384
 - PINION FORK SET** 🛠️11 594255
 - SOLENOID SWITCH** 🛠️04 594383
- Valeo** 436019

D6RA105 1,3 Kw 3(3) ↻

12 V 56° ↻ 11 N



- ARMATURE** 🛠️02a 594530
 - BRUSHES AND SPRINGS SET** 🛠️09 594443
 - CONNECTION SET** 🛠️26 594442
 - DRIVE END HOUSING** 🛠️14 594597
 - INDUCTION COIL** 🛠️27 594535
 - PINION DRIVE** 🛠️03 594382
 - PIGNON DRIVE SHAFT ASSEMBLY** 🛠️02b 594543
 - REDUCTION GEAR ASSEMBLY** 🛠️02 594384
 - PINION FORK SET** 🛠️11 594255
 - SOLENOID SWITCH** 🛠️04 594411
- Valeo** 436019



D6RA107 1,3 Kw 3(0) ↻

12 V 0° ↻ 10 N



- ARMATURE 02a 594530
 - BRUSHES AND SPRINGS SET 09 594423
 - CONNECTION SET 26 594424
 - DRIVE END HOUSING 14 594598
 - INDUCTION COIL 27 594535
 - PINION DRIVE 03 594252
 - PIGNON DRIVE SHAFT ASSEMBLY 02b 594543
 - REDUCTION GEAR ASSEMBLY 02 594412
 - REPAIR KIT 24 594242
 - PINION FORK SET 11 594255
 - SOLENOID SWITCH 04 594188
 - SOLENOID SWITCH 04 594613
- Valeo** 436019

D6RA108 1,3 Kw 3(2) ↻

12 V 31° ↻ 9 N



- ARMATURE 02a 594530
 - BRUSHES AND SPRINGS SET 09 594430
 - CONNECTION SET 26 594429
 - INDUCTION COIL 27 594535
 - PIGNON DRIVE SHAFT ASSEMBLY 02b 594549
 - REPAIR KIT 24 594242
 - PINION FORK SET 11 594068
 - SOLENOID SWITCH 04 594428
- Valeo** 436019

D6RA109 1,4 Kw 3(3) ↻

12 V 55° ↻ 10 N



- ARMATURE 02a 594530
 - BRUSHES AND SPRINGS SET 09 594423
 - CONNECTION SET 26 594424
 - DRIVE END HOUSING 14 594600
 - INDUCTION COIL 27 594535
 - PINION DRIVE 03 594252
 - PIGNON DRIVE SHAFT ASSEMBLY 02b 594549
 - REDUCTION GEAR ASSEMBLY 02 594412
 - REPAIR KIT 24 594242
 - SOLENOID SWITCH 04 594188
- Valeo** 436019

D6RA11 1,2 Kw 3(0) ↻

12 V 9

Picture not available
Image non disponible
Imagen no disponible
Immagine non disponibile
Nicht verfügbares Bild
Brak zdjęcia
Картина недоступна

Picture not available
Image non disponible
Imagen no disponible
Immagine non disponibile
Nicht verfügbares Bild
Brak zdjęcia
Картина недоступна

- ARMATURE 02a 594526
 - DRIVE END HOUSING 14 594558
 - PINION DRIVE 03 594106
 - REPAIR KIT 24 594084
 - PINION FORK SET 11 594068
- Valeo** 594100

D6RA110 1,4 Kw 4(2) ↻

12 V 37° ↻ 11 N



- ARMATURE 02a 594530
 - BRUSHES AND SPRINGS SET 09 594386
 - CONNECTION SET 26 594385
 - DRIVE END HOUSING 14 594601
 - INDUCTION COIL 27 594535
 - PINION DRIVE 03 594382
 - PIGNON DRIVE SHAFT ASSEMBLY 02b 594554
 - REDUCTION GEAR ASSEMBLY 02 *594448
 - REPAIR KIT 24 594242
 - PINION FORK SET 11 594255
 - SOLENOID SWITCH 04 594449
- Valeo** 436019

D6RA114 1,4 Kw 3(3) ↻

12 V 55° ↻ 10 N

Picture not available
Image non disponible
Imagen no disponible
Immagine non disponibile
Nicht verfügbares Bild
Brak zdjęcia
Картина недоступна

Picture not available
Image non disponible
Imagen no disponible
Immagine non disponibile
Nicht verfügbares Bild
Brak zdjęcia
Картина недоступна

- ARMATURE 02a 594530
 - BRUSHES AND SPRINGS SET 09 594423
 - CONNECTION SET 26 594424
 - DRIVE END HOUSING 14 594740
 - INDUCTION COIL 27 594535
 - PINION DRIVE 03 594252
 - PIGNON DRIVE SHAFT ASSEMBLY 02b 594543
 - REDUCTION GEAR ASSEMBLY 02 594384
 - REPAIR KIT 24 594242
 - PINION FORK SET 11 594255
 - SOLENOID SWITCH 04 594188
- Valeo** 436019

D6RA115 1,3 Kw 3(3) ↻

12 V 56° 11 N



ARMATURE 02a 594530
BRUSHES AND SPRINGS SET 09 594443
CONNECTION SET 26 594464
DRIVE END HOUSING 14 594597
INDUCTION COIL 27 594535
PINION DRIVE 03 594382
PIGNON DRIVE SHAFT ASSEMBLY 02b 594543
REDUCTION GEAR ASSEMBLY 02 594384
PINION FORK SET 11 594255
SOLENOID SWITCH 04 594411
Valeo 436019

D6RA12 1,2 Kw 3(1) ↻

12 V 9 N



ARMATURE 02a 594526
BRUSHES AND SPRINGS SET 09 594060
CONNECTION SET 26 594070
DRIVE END HOUSING 14 594584
INDUCTION COIL 27 594534
PINION DRIVE 03 594029
PIGNON DRIVE SHAFT ASSEMBLY 02b 594538
REDUCTION GEAR ASSEMBLY 02 594019
REPAIR KIT 24 594084
PINION FORK SET 11 594068
SOLENOID SWITCH 04 594183
Valeo 436019

D6RA13 1,2 Kw 3(0) ↻

12 V 9 N



ARMATURE 02a 594526
BRUSHES AND SPRINGS SET 09 594127
CONNECTION SET 26 594129
INDUCTION COIL 27 594534
PINION DRIVE 03 594032
PIGNON DRIVE SHAFT ASSEMBLY 02b 594538
REDUCTION GEAR ASSEMBLY 02 594019
REPAIR KIT 24 594084
PINION FORK SET 11 594068
SOLENOID SWITCH 04 594045
Valeo 436019

D6RA133 1,2 Kw 4(4) ↻

12 V 32° 10 N



ARMATURE 02a 594526
BRUSHES AND SPRINGS SET 09 594169
CONNECTION SET 26 594132
DRIVE END HOUSING 14 594569
INDUCTION COIL 27 594534
PINION DRIVE 03 594252
PIGNON DRIVE SHAFT ASSEMBLY 02b 594542
REDUCTION GEAR ASSEMBLY 02 594233
REPAIR KIT 24 594084
PINION FORK SET 11 594255
SOLENOID SWITCH 04 594208
Valeo 436019

D6RA137 1,3 Kw 3(0) ↻

12 V 33° 9 N



ARMATURE 02a 594529
CONNECTION SET 26 594416
DRIVE END HOUSING 14 594603
PINION DRIVE 03 594214
PIGNON DRIVE SHAFT ASSEMBLY 02b 594544
REPAIR KIT 24 594242
PINION FORK SET 11 594255
SOLENOID SWITCH 04 594414
Valeo 436019

D6RA138 1,3 Kw 3(0) ↻

12 V 33° 9 N



ARMATURE 02a 594529
BRUSHES AND SPRINGS SET 09 594377
CONNECTION SET 26 594416
DRIVE END HOUSING 14 594689
INDUCTION COIL 27 594534
INDUCTION COIL 27 594535
PINION DRIVE 03 594214
PIGNON DRIVE SHAFT ASSEMBLY 02b 594541
PIGNON DRIVE SHAFT ASSEMBLY 02b 594544
PIGNON DRIVE SHAFT ASSEMBLY 02b 594609
REDUCTION GEAR ASSEMBLY 02 594176
REDUCTION GEAR ASSEMBLY 02 594409
REPAIR KIT 24 594084
REPAIR KIT 24 594242
PINION FORK SET 11 594255
SOLENOID SWITCH 04 594414
Valeo 436019

D6RA141 1,3 Kw 3(3) ↻

12 V 30° 9 N



- BRUSHES AND SPRINGS SET 09 594127
 - CONNECTION SET 26 594129
 - DRIVE END HOUSING 14 594572
 - INDUCTION COIL 27 594534
 - PINION DRIVE 03 594214
 - PIGNON DRIVE SHAFT ASSEMBLY 02b 594541
 - REDUCTION GEAR ASSEMBLY 02 594176
 - REPAIR KIT 24 594084
 - PINION FORK SET 11 594255
 - SOLENOID SWITCH 04 594208
- Valeo** 436019

D6RA15 1,2 Kw 3(0) ↻

12 V 45° 9 N

Picture not available
Image non disponible
Imagen no disponible
Immagine non disponibile
Nicht verfügbares Bild
Brak zdjęć
Картина недоступна

Picture not available
Image non disponible
Imagen no disponible
Immagine non disponibile
Nicht verfügbares Bild
Brak zdjęć
Картина недоступна

- ARMATURE 02a 594526
 - BRUSHES AND SPRINGS SET 09 594127
 - CONNECTION SET 26 594129
 - DRIVE END HOUSING 14 594556
 - INDUCTION COIL 27 594534
 - PINION DRIVE 03 594033
 - PIGNON DRIVE SHAFT ASSEMBLY 02b 594536
 - REDUCTION GEAR ASSEMBLY 02 594022
 - REPAIR KIT 24 594084
 - PINION FORK SET 11 594068
 - SOLENOID SWITCH 04 594045
- Valeo** 432586/455632

D6RA16 1,2 Kw 3(3) ↻

12 V 9



- ARMATURE 02a 594526
 - BRUSHES AND SPRINGS SET 09 594060
 - CONNECTION SET 26 594070
 - INDUCTION COIL 27 594534
 - PINION DRIVE 03 594029
 - PIGNON DRIVE SHAFT ASSEMBLY 02b 594538
 - REDUCTION GEAR ASSEMBLY 02 594019
 - REPAIR KIT 24 594084
 - PINION FORK SET 11 594068
 - SOLENOID SWITCH 04 594183
- Valeo** 436019

D6RA161 1 Kw 3(3) ↻

12 V 9



- INDUCTION COIL 27 594534
 - PINION DRIVE 03 594214
 - PIGNON DRIVE SHAFT ASSEMBLY 02b 594541
 - REDUCTION GEAR ASSEMBLY 02 594176
 - PINION FORK SET 11 594255
 - SOLENOID SWITCH 04 594183
- Valeo** 436019

D6RA162 1,1 Kw 2(0) ↻

12 V 75° 10 N



- ARMATURE 02a 594526
 - BRUSHES AND SPRINGS SET 09 594377
 - CONNECTION SET 26 594376
 - DRIVE END HOUSING 14 594579
 - INDUCTION COIL 27 594534
 - PINION DRIVE 03 594252
 - PIGNON DRIVE SHAFT ASSEMBLY 02b 594542
 - REDUCTION GEAR ASSEMBLY 02 594233
 - REPAIR KIT 24 594084
 - PINION FORK SET 11 594374
 - SOLENOID SWITCH 04 594117
- Valeo** 436019

D6RA163 1,1 Kw 2(0) ↻

12 V 75° 10 N



- ARMATURE 02a 594529
 - BRUSHES AND SPRINGS SET 09 594317
 - CONNECTION SET 26 594637
 - DRIVE END HOUSING 14 594579
 - INDUCTION COIL 27 594534
 - PINION DRIVE 03 594252
 - PIGNON DRIVE SHAFT ASSEMBLY 02b 594541
 - REDUCTION GEAR ASSEMBLY 02 594176
 - REPAIR KIT 24 594084
 - PINION FORK SET 11 594374
 - SOLENOID SWITCH 04 594117
- Valeo** 436019

D6RA167 1 Kw 2(0) ↻

12 V 78° 9 N



ARMATURE 02a 594528
BRUSHES AND SPRINGS SET 09 594317
CONNECTION SET 26 594318
DRIVE END HOUSING 14 594582
REPAIR KIT 24 594242
PINION FORK SET 11 594255
SOLENOID SWITCH 04 594405
Valeo 436019

D6RA168 1,3 Kw 3(0) ↻

12 V 31° 9 N



ARMATURE 02a 594529
BRUSHES AND SPRINGS SET 09 594261
CONNECTION SET 26 594260
DRIVE END HOUSING 14 594583
INDUCTION COIL 27 594534
PINION DRIVE 03 594248
PIGNON DRIVE SHAFT ASSEMBLY 02b 594548
REPAIR KIT 24 594242
PINION FORK SET 11 594259
SOLENOID SWITCH 04 594271
Valeo 436019

D6RA169 1,1 Kw 2(0) ↻

12 V 75° 10 N



ARMATURE 02a 594529
BRUSHES AND SPRINGS SET 09 594317
CONNECTION SET 26 594637
DRIVE END HOUSING 14 594579
INDUCTION COIL 27 594534
PINION DRIVE 03 594252
PIGNON DRIVE SHAFT ASSEMBLY 02b 594541
REDUCTION GEAR ASSEMBLY 02 594176
REPAIR KIT 24 594084
PINION FORK SET 11 594374
SOLENOID SWITCH 04 594117
Valeo 436019

D6RA17 1,2 Kw 2(0) ↻

12 V 9

Picture not available
 Image non disponible
 Imagen no disponible
 Immagine non disponibile
 Nicht verfügbares Bild
 Brak zdjęcia
 Картина недоступна

Picture not available
 Image non disponible
 Imagen no disponible
 Immagine non disponibile
 Nicht verfügbares Bild
 Brak zdjęcia
 Картина недоступна

ARMATURE 02a 594526
BRUSHES AND SPRINGS SET 09 594127
CONNECTION SET 26 594129
DRIVE END HOUSING 14 594560
PINION DRIVE 03 594034
REPAIR KIT 24 594084
PINION FORK SET 11 594068
SOLENOID SWITCH 04 594087
Valeo 594081/455636

D6RA18 1,2 Kw 3(3) ↻

12 V 9



ARMATURE 02a 594526
BRUSHES AND SPRINGS SET 09 594060
CONNECTION SET 26 594070
INDUCTION COIL 27 594534
PINION DRIVE 03 594029
PIGNON DRIVE SHAFT ASSEMBLY 02b 594538
REDUCTION GEAR ASSEMBLY 02 594019
REPAIR KIT 24 594084
PINION FORK SET 11 594068
SOLENOID SWITCH 04 594087
Valeo 436019

D6RA180 1 Kw 2(0) ↻

12 V 50° 9 N

Picture not available
 Image non disponible
 Imagen no disponible
 Immagine non disponibile
 Nicht verfügbares Bild
 Brak zdjęcia
 Картина недоступна

Picture not available
 Image non disponible
 Imagen no disponible
 Immagine non disponibile
 Nicht verfügbares Bild
 Brak zdjęcia
 Картина недоступна

ARMATURE 02a 594528
BRUSHES AND SPRINGS SET 09 594360
REPAIR KIT 24 594242
PINION FORK SET 11 594255
SOLENOID SWITCH 04 594405
Valeo 436019

D6RA181

1 Kw

2(0)



12 V

58°



N

Picture not available
Image non disponible
Imagen no disponible
Immagine non disponibile
Nicht verfügbares Bild
Brak zdjęcia
Картина недоступна

Picture not available
Image non disponible
Imagen no disponible
Immagine non disponibile
Nicht verfügbares Bild
Brak zdjęcia
Картина недоступна

ARMATURE 02a	594528
BRUSHES AND SPRINGS SET 09	594360
PINION DRIVE 03	594361
REDUCTION GEAR ASSEMBLY 02	594363
REPAIR KIT 24	594242
PINION FORK SET 11	594255
Valeo	436019

D6RA185

1,3 Kw

2(0)



12 V



Picture not available
Image non disponible
Imagen no disponible
Immagine non disponibile
Nicht verfügbares Bild
Brak zdjęcia
Картина недоступна

Picture not available
Image non disponible
Imagen no disponible
Immagine non disponibile
Nicht verfügbares Bild
Brak zdjęcia
Картина недоступна

ARMATURE 02a	594529
BRUSHES AND SPRINGS SET 09	594366
CONNECTION SET 26	594605
DRIVE END HOUSING 14	594606
INDUCTION COIL 27	594534
PINION DRIVE 03	594214
PIGNON DRIVE SHAFT ASSEMBLY 02b	594609
REDUCTION GEAR ASSEMBLY 02	594238
REPAIR KIT 24	594242
PINION FORK SET 11	594255
SOLENOID SWITCH 04	594414
Valeo	438029

D6RA187

1,3 Kw

3(0)



12 V

33°



N



ARMATURE 02a	594529
DRIVE END HOUSING 14	594603
PINION DRIVE 03	594214
PIGNON DRIVE SHAFT ASSEMBLY 02b	594609
REDUCTION GEAR ASSEMBLY 02	594440
REPAIR KIT 24	594242
PINION FORK SET 11	594255
SOLENOID SWITCH 04	594414
Valeo	436019

D6RA188

1,3 Kw

3(0)



12 V

33°



N



ARMATURE 02a	594529
DRIVE END HOUSING 14	594689
PINION DRIVE 03	594214
PIGNON DRIVE SHAFT ASSEMBLY 02b	594609
REDUCTION GEAR ASSEMBLY 02	594440
REPAIR KIT 24	594242
PINION FORK SET 11	594255
SOLENOID SWITCH 04	594414
Valeo	436019

D6RA19

1,2 Kw

2(0)



12 V



Picture not available
Image non disponible
Imagen no disponible
Immagine non disponibile
Nicht verfügbares Bild
Brak zdjęcia
Картина недоступна

Picture not available
Image non disponible
Imagen no disponible
Immagine non disponibile
Nicht verfügbares Bild
Brak zdjęcia
Картина недоступна

ARMATURE 02a	594526
BRUSHES AND SPRINGS SET 09	594127
CONNECTION SET 26	594129
DRIVE END HOUSING 14	594561
PINION DRIVE 03	594034
REPAIR KIT 24	594084
PINION FORK SET 11	594068
SOLENOID SWITCH 04	594087
Valeo	594082/455635

D6RA190

1,4 Kw

3(3)



12 V

55°



N



ARMATURE 02a	594528
BRUSHES AND SPRINGS SET 09	594423
CONNECTION SET 26	594424
DRIVE END HOUSING 14	594770
INDUCTION COIL 27	594535
PINION DRIVE 03	594214
PIGNON DRIVE SHAFT ASSEMBLY 02b	594543
REPAIR KIT 24	594769
PINION FORK SET 11	594255
SOLENOID SWITCH 04	594188
Valeo	436019

D6RA20

1,2 Kw

3(1)



12 V

**ARMATURE** 02a

594526

BRUSHES AND SPRINGS SET 09

594060

CONNECTION SET 26

594070

INDUCTION COIL 27

594534

PINION DRIVE 03

594029

PIGNON DRIVE SHAFT ASSEMBLY 02b

594538

REDUCTION GEAR ASSEMBLY 02

594019

REPAIR KIT 24

594084

PINION FORK SET 11

594068

SOLENOID SWITCH 04

594045

Valeo**436019****D6RA21**

1,2 Kw

3(0)



12 V



Picture not available
Image non disponible
Imagen no disponible
Immagine non disponibile
Nicht verfügbares Bild
Brak zdjęcia
Картина недоступна

Picture not available
Image non disponible
Imagen no disponible
Immagine non disponibile
Nicht verfügbares Bild
Brak zdjęcia
Картина недоступна

ARMATURE 02a

594526

BRUSHES AND SPRINGS SET 09

594127

CONNECTION SET 26

594129

DRIVE END HOUSING 14

594562

PIGNON DRIVE SHAFT ASSEMBLY 02b

594537

REDUCTION GEAR ASSEMBLY 02

594024

REPAIR KIT 24

594084

PINION FORK SET 11

594068

SOLENOID SWITCH 04

594046

Valeo**432599****D6RA210**

1,2 Kw

3(0)



12 V

40°



N

Picture not available
Image non disponible
Imagen no disponible
Immagine non disponibile
Nicht verfügbares Bild
Brak zdjęcia
Картина недоступна

Picture not available
Image non disponible
Imagen no disponible
Immagine non disponibile
Nicht verfügbares Bild
Brak zdjęcia
Картина недоступна

BRUSHES AND SPRINGS SET 09

594437

CONNECTION SET 26

594434

DRIVE END HOUSING 14

594562

PIGNON DRIVE SHAFT ASSEMBLY 02b

594552

REPAIR KIT 24

594084

PINION FORK SET 11

594255

SOLENOID SWITCH 04

594178

Valeo**432599****D6RA22**

1,2 Kw

2(0)



12 V



Picture not available
Image non disponible
Imagen no disponible
Immagine non disponibile
Nicht verfügbares Bild
Brak zdjęcia
Картина недоступна

Picture not available
Image non disponible
Imagen no disponible
Immagine non disponibile
Nicht verfügbares Bild
Brak zdjęcia
Картина недоступна

ARMATURE 02a

594526

BRUSHES AND SPRINGS SET 09

594127

CONNECTION SET 26

594129

DRIVE END HOUSING 14

594563

INDUCTION COIL 27

594534

PINION DRIVE 03

594086

PIGNON DRIVE SHAFT ASSEMBLY 02b

594538

REDUCTION GEAR ASSEMBLY 02

594019

REPAIR KIT 24

594084

PINION FORK SET 11

594068

SOLENOID SWITCH 04

594087

Valeo**594085****D6RA23**

1,2 Kw

3(3)



12 V



Picture not available
Image non disponible
Imagen no disponible
Immagine non disponibile
Nicht verfügbares Bild
Brak zdjęcia
Картина недоступна

Picture not available
Image non disponible
Imagen no disponible
Immagine non disponibile
Nicht verfügbares Bild
Brak zdjęcia
Картина недоступна

ARMATURE 02a

594526

BRUSHES AND SPRINGS SET 09

594127

CONNECTION SET 26

594129

INDUCTION COIL 27

594534

PINION DRIVE 03

594029

REPAIR KIT 24

594084

PINION FORK SET 11

594068

SOLENOID SWITCH 04

594087

Valeo**432592****D6RA249**

1,1 Kw

2(0)



12 V

75°



N

Picture not available
Image non disponible
Imagen no disponible
Immagine non disponibile
Nicht verfügbares Bild
Brak zdjęcia
Картина недоступна

Picture not available
Image non disponible
Imagen no disponible
Immagine non disponibile
Nicht verfügbares Bild
Brak zdjęcia
Картина недоступна

ARMATURE 02a

594526

BRUSHES AND SPRINGS SET 09

594377

CONNECTION SET 26

594376

DRIVE END HOUSING 14

594579

INDUCTION COIL 27

594534

PINION DRIVE 03

594252

PIGNON DRIVE SHAFT ASSEMBLY 02b

594542

REDUCTION GEAR ASSEMBLY 02

594233

REPAIR KIT 24

594084

PINION FORK SET 11

594374

SOLENOID SWITCH 04

594117

Valeo**436019**

D6RA25	1,2 Kw	2(0)	↻
12 V	45°↙	9	N



ARMATURE 🛠️02a	594526
BRUSHES AND SPRINGS SET 🛠️09	594127
CONNECTION SET 🛠️26	594130
DRIVE END HOUSING 🛠️14	594564
INDUCTION COIL 🛠️27	594534
REPAIR KIT 🛠️24	594084
PINION FORK SET 🛠️11	594068
Valeo	436019

D6RA26	1,2 Kw	3(0)	↻
12 V	38°↙	9	N

Picture not available
Image non disponible
Imagen no disponible
Immagine non disponibile
Nicht verfügbares Bild
Brak zdjęcia
Картина недоступна

Picture not available
Image non disponible
Imagen no disponible
Immagine non disponibile
Nicht verfügbares Bild
Brak zdjęcia
Картина недоступна

ARMATURE 🛠️02a	594526
BRUSHES AND SPRINGS SET 🛠️09	594127
CONNECTION SET 🛠️26	594129
DRIVE END HOUSING 🛠️14	594565
INDUCTION COIL 🛠️27	594534
PINION DRIVE 🛠️03	594029
PIGNON DRIVE SHAFT ASSEMBLY 🛠️02b	594538
REDUCTION GEAR ASSEMBLY 🛠️02	594019
REPAIR KIT 🛠️24	594084
PINION FORK SET 🛠️11	594068
SOLENOID SWITCH 🛠️04	594138
Valeo	436019

D6RA27	1,2 Kw	2(0)	↻
12 V	45°↙	9	N

Picture not available
Image non disponible
Imagen no disponible
Immagine non disponibile
Nicht verfügbares Bild
Brak zdjęcia
Картина недоступна

Picture not available
Image non disponible
Imagen no disponible
Immagine non disponibile
Nicht verfügbares Bild
Brak zdjęcia
Картина недоступна

ARMATURE 🛠️02a	594526
BRUSHES AND SPRINGS SET 🛠️09	594127
CONNECTION SET 🛠️26	594129
DRIVE END HOUSING 🛠️14	594566
PINION DRIVE 🛠️03	594034
REPAIR KIT 🛠️24	594084
PINION FORK SET 🛠️11	594068
SOLENOID SWITCH 🛠️04	594087
Valeo	594090

D6RA28	1,2 Kw	2(0)	↻
12 V	45°↙	9	N



ARMATURE 🛠️02a	594526
BRUSHES AND SPRINGS SET 🛠️09	594127
CONNECTION SET 🛠️26	594130
DRIVE END HOUSING 🛠️14	594560
INDUCTION COIL 🛠️27	594534
REPAIR KIT 🛠️24	594084
PINION FORK SET 🛠️11	594068

D6RA28	1,2 Kw	2(0)	↻
12 V	45°↙	9	N



ARMATURE 🛠️02a	594526
BRUSHES AND SPRINGS SET 🛠️09	594127
CONNECTION SET 🛠️26	594130
DRIVE END HOUSING 🛠️14	594560
INDUCTION COIL 🛠️27	594534
REPAIR KIT 🛠️24	594084
PINION FORK SET 🛠️11	594068
Valeo	436019

D6RA29	1,2 Kw	2(0)	↻
12 V	45°↘	9	N

Picture not available
Image non disponible
Imagen no disponible
Immagine non disponibile
Nicht verfügbares Bild
Brak zdjęcia
Картина недоступна

Picture not available
Image non disponible
Imagen no disponible
Immagine non disponibile
Nicht verfügbares Bild
Brak zdjęcia
Картина недоступна

ARMATURE 🛠️02a	594526
BRUSHES AND SPRINGS SET 🛠️09	594127
CONNECTION SET 🛠️26	594129
DRIVE END HOUSING 🛠️14	594567
PINION DRIVE 🛠️03	594034
REPAIR KIT 🛠️24	594084
PINION FORK SET 🛠️11	594068
SOLENOID SWITCH 🛠️04	594087
Valeo	594091

D6RA293 1,3 Kw 2(0) ↻

12 V 75° 10 N



- ARMATURE 02a 594529
- BRUSHES AND SPRINGS SET 09 594317
- CONNECTION SET 26 594637
- DRIVE END HOUSING 14 594579
- INDUCTION COIL 27 594534
- PINION DRIVE 03 594252
- PIGNON DRIVE SHAFT ASSEMBLY 02b 594541
- REDUCTION GEAR ASSEMBLY 02 594176
- REPAIR KIT 24 594084
- PINION FORK SET 11 594374
- SOLENOID SWITCH 04 594636

Valeo

436019

D6RA30 1,2 Kw 4(4) ↻

12 V 48° 11 N



- ARMATURE 02a 594526
- BRUSHES AND SPRINGS SET 09 594127
- CONNECTION SET 26 594129
- DRIVE END HOUSING 14 594568
- INDUCTION COIL 27 594534
- PINION DRIVE 03 594107
- PIGNON DRIVE SHAFT ASSEMBLY 02b 594538
- REDUCTION GEAR ASSEMBLY 02 594019
- REPAIR KIT 24 594084
- PINION FORK SET 11 594068
- SOLENOID SWITCH 04 594138

Valeo

436019

D6RA32 1,1 Kw 3(0) ↻

12 V 10



- ARMATURE 02a 594526
- BRUSHES AND SPRINGS SET 09 594127
- CONNECTION SET 26 594130
- INDUCTION COIL 27 594534
- PINION DRIVE 03 594108
- PIGNON DRIVE SHAFT ASSEMBLY 02b 594538
- REDUCTION GEAR ASSEMBLY 02 594019
- REPAIR KIT 24 594084
- PINION FORK SET 11 594068
- SOLENOID SWITCH 04 594117

Valeo

436019

D6RA33 1,2 Kw 4(4) ↻

12 V 10



- ARMATURE 02a 594526
 - BRUSHES AND SPRINGS SET 09 594169
 - CONNECTION SET 26 594132
 - DRIVE END HOUSING 14 594569
 - INDUCTION COIL 27 594534
 - PINION DRIVE 03 594108
 - PIGNON DRIVE SHAFT ASSEMBLY 02b 594538
 - REDUCTION GEAR ASSEMBLY 02 594019
 - REPAIR KIT 24 594084
 - PINION FORK SET 11 594068
 - SOLENOID SWITCH 04 594208
- Valeo** 594526
594169
594132
594569
594534
594108
594538
594019
594084
594068
594208
436019

D6RA34 1,1 Kw 2(0) ↻

12 V 9

Picture not available
Image non disponible
Imagen no disponible
Imagine non disponibile
Nicht verfügbares Bild
Brak zdjęcia
Картина недоступна

Picture not available
Image non disponible
Imagen no disponible
Imagine non disponibile
Nicht verfügbares Bild
Brak zdjęcia
Картина недоступна

- ARMATURE 02a 594526
 - BRUSHES AND SPRINGS SET 09 594127
 - CONNECTION SET 26 594129
 - DRIVE END HOUSING 14 594570
 - PINION DRIVE 03 594034
 - REPAIR KIT 24 594084
 - PINION FORK SET 11 594068
 - SOLENOID SWITCH 04 594087
- Valeo** 594087
594082

D6RA37	1,2 Kw	3(1)	↻
12 V	35°	9	N



ARMATURE 02a	594526
BRUSHES AND SPRINGS SET 09	594169
CONNECTION SET 26	594132
INDUCTION COIL 27	594534
PINION DRIVE 03	594029
PIGNON DRIVE SHAFT ASSEMBLY 02b	594538
REDUCTION GEAR ASSEMBLY 02	594019
REPAIR KIT 24	594084
PINION FORK SET 11	594068
SOLENOID SWITCH 04	594181
Valeo	436019

D6RA38	1,2 Kw	3(3)	↻
12 V		9	



ARMATURE 02a	594526
BRUSHES AND SPRINGS SET 09	594060
CONNECTION SET 26	594129
INDUCTION COIL 27	594534
PINION DRIVE 03	594029
PIGNON DRIVE SHAFT ASSEMBLY 02b	594538
REDUCTION GEAR ASSEMBLY 02	594019
REPAIR KIT 24	594084
PINION FORK SET 11	594068
SOLENOID SWITCH 04	594183
Valeo	436019

D6RA39	1,2 Kw	3(2)	↻
12 V	45°	10	N



ARMATURE 02a	594526
BRUSHES AND SPRINGS SET 09	594127
CONNECTION SET 26	594129
DRIVE END HOUSING 14	594571
INDUCTION COIL 27	594534
PINION DRIVE 03	594108
PIGNON DRIVE SHAFT ASSEMBLY 02b	594538
REDUCTION GEAR ASSEMBLY 02	594019
REPAIR KIT 24	594084
PINION FORK SET 11	594068
SOLENOID SWITCH 04	594145
Valeo	436019

D6RA40	1,2 Kw	3(0)	↻
12 V	60°	9	N

Picture not available
Image non disponible
Imagen no disponible
Immagine non disponibile
Nicht verfügbares Bild
Brak zdjęcie
Картина недоступна

Picture not available
Image non disponible
Imagen no disponible
Immagine non disponibile
Nicht verfügbares Bild
Brak zdjęcie
Картина недоступна

ARMATURE 02a	594526
BRUSHES AND SPRINGS SET 09	594127
CONNECTION SET 26	594129
DRIVE END HOUSING 14	594558
INDUCTION COIL 27	594534
PINION DRIVE 03	594106
REPAIR KIT 24	594084
PINION FORK SET 11	594068
SOLENOID SWITCH 04	099845
SOLENOID SWITCH 04	594604
Valeo	594100

D6RA41	1,2 Kw	3(3)	↻
12 V		9	



ARMATURE 02a	594526
BRUSHES AND SPRINGS SET 09	594127
CONNECTION SET 26	594129
DRIVE END HOUSING 14	594572
INDUCTION COIL 27	594534
PINION DRIVE 03	594029
PIGNON DRIVE SHAFT ASSEMBLY 02b	594538
REDUCTION GEAR ASSEMBLY 02	594019
REPAIR KIT 24	594084
PINION FORK SET 11	594068
SOLENOID SWITCH 04	594208
Valeo	436019

D6RA42	1,2 Kw	2(0)	↻
12 V	38°	9	N



ARMATURE 02a	594526
BRUSHES AND SPRINGS SET 09	594127
CONNECTION SET 26	594129
PINION DRIVE 03	594109
PIGNON DRIVE SHAFT ASSEMBLY 02b	594537
REDUCTION GEAR ASSEMBLY 02	594024
REPAIR KIT 24	594084
PINION FORK SET 11	594068
SOLENOID SWITCH 04	594045
Valeo	436019

D6RA421 1,2 Kw 2(0) ↻

12 V 38° ∇ 9 N



- ARMATURE 🛠️02a 594529
 - BRUSHES AND SPRINGS SET 🛠️09 594127
 - CONNECTION SET 🛠️26 594129
 - DRIVE END HOUSING 🛠️14 594552
 - PINION DRIVE 🛠️03 594755
 - PIGNON DRIVE SHAFT ASSEMBLY 🛠️02b 594552
 - REPAIR KIT 🛠️24 594084
 - PINION FORK SET 🛠️11 594255
 - SOLENOID SWITCH 🛠️04 594269
- Valeo** 436019

D6RA43 1,2 Kw 2(0) ↻

12 V 9



Picture not available
Image non disponible
Imagen no disponible
Immagine non disponibile
Nicht verfügbares Bild
Brak zdjęcia
Картина недоступна

- ARMATURE 🛠️02a 594526
 - BRUSHES AND SPRINGS SET 🛠️09 594127
 - CONNECTION SET 🛠️26 594129
 - PIGNON DRIVE SHAFT ASSEMBLY 🛠️02b 594537
 - REDUCTION GEAR ASSEMBLY 🛠️02 594024
 - REPAIR KIT 🛠️24 594084
 - PINION FORK SET 🛠️11 594068
- Valeo** 436019

D6RA431 1,2 Kw 2(0) ↻

12 V 36° ∇ 9 N



Picture not available
Image non disponible
Imagen no disponible
Immagine non disponibile
Nicht verfügbares Bild
Brak zdjęcia
Картина недоступна

- ARMATURE 🛠️02a 594529
 - BRUSHES AND SPRINGS SET 🛠️09 594127
 - CONNECTION SET 🛠️26 594129
 - DRIVE END HOUSING 🛠️14 594552
 - PINION DRIVE 🛠️03 594757
 - PIGNON DRIVE SHAFT ASSEMBLY 🛠️02b 594552
 - REPAIR KIT 🛠️24 594084
 - PINION FORK SET 🛠️11 594255
- Valeo** 436019

D6RA44 1,2 Kw 2(0) ↻

12 V 36° ∇ 10 N



- ARMATURE 🛠️02a 594526
 - BRUSHES AND SPRINGS SET 🛠️09 594127
 - CONNECTION SET 🛠️26 594129
 - PIGNON DRIVE SHAFT ASSEMBLY 🛠️02b 594537
 - REDUCTION GEAR ASSEMBLY 🛠️02 594024
 - REPAIR KIT 🛠️24 594084
 - PINION FORK SET 🛠️11 594068
 - SOLENOID SWITCH 🛠️04 594087
- Valeo** 436019

D6RA441 1,2 Kw 2(0) ↻

12 V 36° ∇ 10 N



- ARMATURE 🛠️02a 594529
 - BRUSHES AND SPRINGS SET 🛠️09 594127
 - CONNECTION SET 🛠️26 594129
 - DRIVE END HOUSING 🛠️14 594552
 - PINION DRIVE 🛠️03 594758
 - PIGNON DRIVE SHAFT ASSEMBLY 🛠️02b 594552
 - REPAIR KIT 🛠️24 594084
 - PINION FORK SET 🛠️11 594255
 - SOLENOID SWITCH 🛠️04 594087
- Valeo** 436019

D6RA45 1,2 Kw 3(3) ↻

12 V 9



- BRUSHES AND SPRINGS SET 🛠️09 594060
 - CONNECTION SET 🛠️26 594070
 - DRIVE END HOUSING 🛠️14 594573
 - INDUCTION COIL 🛠️27 594534
 - PINION DRIVE 🛠️03 594029
 - PIGNON DRIVE SHAFT ASSEMBLY 🛠️02b 594539
 - REPAIR KIT 🛠️24 594084
 - PINION FORK SET 🛠️11 594068
 - SOLENOID SWITCH 🛠️04 594208
- Valeo** 436019



D6RA46

1,1 Kw

4(4)



12 V



ARMATURE 02a 594526
 BRUSHES AND SPRINGS SET 09 594127
 CONNECTION SET 26 594129
 DRIVE END HOUSING 14 594569
 INDUCTION COIL 27 594534
 REPAIR KIT 24 594084
 PINION FORK SET 11 594068
 SOLENOID SWITCH 04 594178
Valeo 436019

D6RA47

1,1 Kw

3(3)



12 V

32°



N



ARMATURE 02a 594526
 BRUSHES AND SPRINGS SET 09 594169
 CONNECTION SET 26 594132
 DRIVE END HOUSING 14 594574
 INDUCTION COIL 27 594534
 PIGNON DRIVE SHAFT ASSEMBLY 02b 594536
 REDUCTION GEAR ASSEMBLY 02 594022
 REPAIR KIT 24 594084
 PINION FORK SET 11 594068
 SOLENOID SWITCH 04 594138
Valeo 436019

D6RA48

1,1 Kw

3(0)



12 V



ARMATURE 02a 594526
 BRUSHES AND SPRINGS SET 09 594127
 CONNECTION SET 26 594130
 INDUCTION COIL 27 594534
 PINION DRIVE 03 594108
 PIGNON DRIVE SHAFT ASSEMBLY 02b 594538
 REDUCTION GEAR ASSEMBLY 02 594019
 REPAIR KIT 24 594084
 PINION FORK SET 11 594068
Valeo 436019

D6RA5

1,2 Kw

3(1)



12 V

35°



N



ARMATURE 02a 594526
 BRUSHES AND SPRINGS SET 09 594060
 CONNECTION SET 26 594070
 INDUCTION COIL 27 594534
 PINION DRIVE 03 594029
 PIGNON DRIVE SHAFT ASSEMBLY 02b 594538
 REDUCTION GEAR ASSEMBLY 02 594019
 REPAIR KIT 24 594084
 PINION FORK SET 11 594068
 SOLENOID SWITCH 04 594045
Valeo 436019

D6RA50

1,2 Kw

2(0)



12 V

45°



N

Picture not available
 Image non disponible
 Imagen no disponible
 Immagine non disponibile
 Nicht verfügbares Bild
 Brak zdjęcia
 Картина недоступна

Picture not available
 Image non disponible
 Imagen no disponible
 Immagine non disponibile
 Nicht verfügbares Bild
 Brak zdjęcia
 Картина недоступна

BRUSHES AND SPRINGS SET 09 594127
 CONNECTION SET 26 594129
 DRIVE END HOUSING 14 594561
 PINION DRIVE 03 594034
 REDUCTION GEAR ASSEMBLY 02 594150
 REPAIR KIT 24 594084
 PINION FORK SET 11 594068
 SOLENOID SWITCH 04 594087
Valeo 594082/455635

D6RA51

1,2 Kw

3(3)



12 V



BRUSHES AND SPRINGS SET 09 594169
 CONNECTION SET 26 594132
 DRIVE END HOUSING 14 594575
 INDUCTION COIL 27 594534
 PINION DRIVE 03 594029
 PIGNON DRIVE SHAFT ASSEMBLY 02b 594539
 REPAIR KIT 24 594084
 PINION FORK SET 11 594068
 SOLENOID SWITCH 04 594181
Valeo 436019

D6RA511 1 Kw 3(3) ↻

12 V 55° 9 N



- BRUSHES AND SPRINGS SET** 09 594169
 - CONNECTION SET** 26 594132
 - DRIVE END HOUSING** 14 594575
 - INDUCTION COIL** 27 594534
 - PINION DRIVE** 03 594214
 - PIGNON DRIVE SHAFT ASSEMBLY** 02b 594541
 - REDUCTION GEAR ASSEMBLY** 02 594176
 - REPAIR KIT** 24 594084
 - PINION FORK SET** 11 594255
 - SOLENOID SWITCH** 04 594181
- Valeo** 436019

D6RA52 1,2 Kw 2(0) ↻

12 V 40° 9 N

Picture not available
Image non disponible
Imagen no disponible
Immagine non disponibile
Nicht verfügbares Bild
Brak zdjęcia
Картина недоступна

Picture not available
Image non disponible
Imagen no disponible
Immagine non disponibile
Nicht verfügbares Bild
Brak zdjęcia
Картина недоступна

- BRUSHES AND SPRINGS SET** 09 594127
 - CONNECTION SET** 26 594129
 - DRIVE END HOUSING** 14 594563
 - INDUCTION COIL** 27 594534
 - PINION DRIVE** 03 594086
 - PIGNON DRIVE SHAFT ASSEMBLY** 02b 594539
 - REPAIR KIT** 24 594084
 - PINION FORK SET** 11 594068
 - SOLENOID SWITCH** 04 594087
- Valeo** 594085/455634

D6RA53 1,05 Kw 3(3) ↻

12 V 58° 9 N



- DRIVE END HOUSING** 14 594573
 - INDUCTION COIL** 27 594534
 - PINION DRIVE** 03 594214
 - PIGNON DRIVE SHAFT ASSEMBLY** 02b 594541
 - REDUCTION GEAR ASSEMBLY** 02 594176
 - REPAIR KIT** 24 594084
 - PINION FORK SET** 11 594068
 - SOLENOID SWITCH** 04 594208
- Valeo** 436019

D6RA54 1,2 Kw 2(0) ↻

12 V 45° 9 N

Picture not available
Image non disponible
Imagen no disponible
Immagine non disponibile
Nicht verfügbares Bild
Brak zdjęcia
Картина недоступна

Picture not available
Image non disponible
Imagen no disponible
Immagine non disponibile
Nicht verfügbares Bild
Brak zdjęcia
Картина недоступна

- BRUSHES AND SPRINGS SET** 09 594127
 - CONNECTION SET** 26 594129
 - DRIVE END HOUSING** 14 594570
 - PINION DRIVE** 03 594034
 - REDUCTION GEAR ASSEMBLY** 02 594150
 - REPAIR KIT** 24 594084
 - PINION FORK SET** 11 594068
 - SOLENOID SWITCH** 04 594087
- Valeo** 432681

D6RA55 1,2 Kw 2(0) ↻

12 V 9

Picture not available
Image non disponible
Imagen no disponible
Immagine non disponibile
Nicht verfügbares Bild
Brak zdjęcia
Картина недоступна

Picture not available
Image non disponible
Imagen no disponible
Immagine non disponibile
Nicht verfügbares Bild
Brak zdjęcia
Картина недоступна

- BRUSHES AND SPRINGS SET** 09 594127
 - CONNECTION SET** 26 594129
 - DRIVE END HOUSING** 14 594576
 - PINION DRIVE** 03 594172
 - REPAIR KIT** 24 594084
 - PINION FORK SET** 11 594068
 - SOLENOID SWITCH** 04 594173
- Valeo** 432635

D6RA56 1,2 Kw 4(4) ↻

12 V 32° 10 N



- BRUSHES AND SPRINGS SET** 09 594127
 - CONNECTION SET** 26 594129
 - DRIVE END HOUSING** 14 594569
 - INDUCTION COIL** 27 594534
 - PINION DRIVE** 03 594252
 - PIGNON DRIVE SHAFT ASSEMBLY** 02b 594541
 - REDUCTION GEAR ASSEMBLY** 02 594176
 - REPAIR KIT** 24 594084
 - PINION FORK SET** 11 594255
 - SOLENOID SWITCH** 04 594178
- Valeo** 436019

D6RA57

1,2 Kw

3(1)



12 V



BRUSHES AND SPRINGS SET	594169
CONNECTION SET	594132
DRIVE END HOUSING	594577
INDUCTION COIL	594534
PINION DRIVE	594029
PIGNON DRIVE SHAFT ASSEMBLY	594539
REPAIR KIT	594084
PINION FORK SET	594068
SOLENOID SWITCH	594181
Valeo	436019

D6RA571

1,2 Kw

3(1)



12 V

35°



N



BRUSHES AND SPRINGS SET	594169
CONNECTION SET	594132
DRIVE END HOUSING	594577
INDUCTION COIL	594534
PINION DRIVE	594214
PIGNON DRIVE SHAFT ASSEMBLY	594541
REDUCTION GEAR ASSEMBLY	594176
REPAIR KIT	594084
PINION FORK SET	594255
SOLENOID SWITCH	594181
Valeo	436019

D6RA572

1,2 Kw



12 V

35°



N



BRUSHES AND SPRINGS SET	594366
CONNECTION SET	594367
DRIVE END HOUSING	594577
INDUCTION COIL	594534
PINION DRIVE	594214
PIGNON DRIVE SHAFT ASSEMBLY	594541
REDUCTION GEAR ASSEMBLY	594176
REPAIR KIT	594084
PINION FORK SET	594255
PINION FORK SET	594374
SOLENOID SWITCH	594365
BRUSHES AND SPRINGS SET	594366
CONNECTION SET	594367
DRIVE END HOUSING	594577
INDUCTION COIL	594534
PINION DRIVE	594214
PIGNON DRIVE SHAFT ASSEMBLY	594541
REDUCTION GEAR ASSEMBLY	594176
REPAIR KIT	594084
PINION FORK SET	594255
PINION FORK SET	594374
SOLENOID SWITCH	594365
Valeo	436019

D6RA59

1,2 Kw

3(1)



12 V

40°



N



ARMATURE	594526
BRUSHES AND SPRINGS SET	594127
CONNECTION SET	594129
DRIVE END HOUSING	594578
INDUCTION COIL	594534
PINION DRIVE	594108
PIGNON DRIVE SHAFT ASSEMBLY	594538
REDUCTION GEAR ASSEMBLY	594019
REPAIR KIT	594084
PINION FORK SET	594068
Valeo	436019

D6RA6

1,2 Kw

4(4)



12 V



ARMATURE 02a 594526
BRUSHES AND SPRINGS SET 09 594060
CONNECTION SET 26 594070
INDUCTION COIL 27 594534
PINION DRIVE 03 594029
PIGNON DRIVE SHAFT ASSEMBLY 02b 594538
REDUCTION GEAR ASSEMBLY 02 594019
REPAIR KIT 24 594084
PINION FORK SET 11 594068
SOLENOID SWITCH 04 594046
Valeo 436019

D6RA60

1,2 Kw

2(0)



12 V

45°



N

Picture not available
 Image non disponible
 Imagen no disponible
 Immagine non disponibile
 Nicht verfügbares Bild
 Brak zdjęcia
 Картина недоступна

Picture not available
 Image non disponible
 Imagen no disponible
 Immagine non disponibile
 Nicht verfügbares Bild
 Brak zdjęcia
 Картина недоступна

BRUSHES AND SPRINGS SET 09 594127
CONNECTION SET 26 594129
DRIVE END HOUSING 14 594560
PINION DRIVE 03 594034
REDUCTION GEAR ASSEMBLY 02 594150
REPAIR KIT 24 594084
PINION FORK SET 11 594068
SOLENOID SWITCH 04 594087
Valeo 594081/455636

D6RA61

1,2 Kw

4(4)



12 V

32°



N



ARMATURE 02a 594526
BRUSHES AND SPRINGS SET 09 594060
CONNECTION SET 26 594070
DRIVE END HOUSING 14 594569
INDUCTION COIL 27 594534
PINION DRIVE 03 594108
PIGNON DRIVE SHAFT ASSEMBLY 02b 594538
REDUCTION GEAR ASSEMBLY 02 594019
REPAIR KIT 24 594084
PINION FORK SET 11 594068
SOLENOID SWITCH 04 594046
Valeo 436019

D6RA62

1,1 Kw

3(0)



12 V



ARMATURE 02a 594526
BRUSHES AND SPRINGS SET 09 594264
CONNECTION SET 26 594263
DRIVE END HOUSING 14 594579
INDUCTION COIL 27 594534
PINION DRIVE 03 594252
PIGNON DRIVE SHAFT ASSEMBLY 02b 594542
REDUCTION GEAR ASSEMBLY 02 594233
REPAIR KIT 24 594084
PINION FORK SET 11 594255
SOLENOID SWITCH 04 594117
Valeo 436019

D6RA63

1,1 Kw

3(3)



12 V



ARMATURE 02a 594529
BRUSHES AND SPRINGS SET 09 594127
CONNECTION SET 26 594129
DRIVE END HOUSING 14 594580
INDUCTION COIL 27 594534
PINION DRIVE 03 594214
PIGNON DRIVE SHAFT ASSEMBLY 02b 594544
REDUCTION GEAR ASSEMBLY 02 594238
PINION FORK SET 11 594255
SOLENOID SWITCH 04 594208
ARMATURE 02a 594529
BRUSHES AND SPRINGS SET 09 594127
CONNECTION SET 26 594129
DRIVE END HOUSING 14 594580
INDUCTION COIL 27 594534
PINION DRIVE 03 594214
PIGNON DRIVE SHAFT ASSEMBLY 02b 594544
REDUCTION GEAR ASSEMBLY 02 594238
PINION FORK SET 11 594255
SOLENOID SWITCH 04 594208
Valeo 436019

D6RA64	1,2 Kw	3(2)	↻
12 V	46°	9	N

Picture not available
Image non disponible
Imagen no disponible
Immagine non disponibile
Nicht verfügbares Bild
Brak zdjęcia
Картина недоступна

Picture not available
Image non disponible
Imagen no disponible
Immagine non disponibile
Nicht verfügbares Bild
Brak zdjęcia
Картина недоступна

BRUSHES AND SPRINGS SET 09	594258
INDUCTION COIL 27	594534
PINION DRIVE 03	594029
PIGNON DRIVE SHAFT ASSEMBLY 02b	594539
REPAIR KIT 24	594084
PINION FORK SET 11	594068
SOLENOID SWITCH 04	594087
Valeo	432592

D6RA66	1,2 Kw	3(3)	↻
12 V		9	



BRUSHES AND SPRINGS SET 09	594127
CONNECTION SET 26	594129
INDUCTION COIL 27	594534
PINION DRIVE 03	594029
PIGNON DRIVE SHAFT ASSEMBLY 02b	594539
REPAIR KIT 24	594084
PINION FORK SET 11	594068
SOLENOID SWITCH 04	594183
Valeo	436019

D6RA661	1 Kw	3(3)	↻
12 V	55°	9	N



BRUSHES AND SPRINGS SET 09	594127
CONNECTION SET 26	594129
INDUCTION COIL 27	594534
PINION DRIVE 03	594214
PIGNON DRIVE SHAFT ASSEMBLY 02b	594541
REDUCTION GEAR ASSEMBLY 02	594176
REPAIR KIT 24	594084
PINION FORK SET 11	594255
SOLENOID SWITCH 04	594183
Valeo	436019

D6RA67	1 Kw	2(0)	↻
12 V	78°	9	N



ARMATURE 02a	594528
BRUSHES AND SPRINGS SET 09	594317
CONNECTION SET 26	594318
DRIVE END HOUSING 14	594582
REPAIR KIT 24	594242
PINION FORK SET 11	594255
SOLENOID SWITCH 04	594357
Valeo	436019

D6RA68	1,3 Kw	3(0)	↻
12 V	31°	9	N



ARMATURE 02a	594526
BRUSHES AND SPRINGS SET 09	594261
CONNECTION SET 26	594260
DRIVE END HOUSING 14	594583
INDUCTION COIL 27	594534
PINION DRIVE 03	594248
PIGNON DRIVE SHAFT ASSEMBLY 02b	594546
REPAIR KIT 24	594242
PINION FORK SET 11	594259
SOLENOID SWITCH 04	594271
Valeo	436019

D6RA7	1,2 Kw	3(0)	↻
12 V		9	

Picture not available
Image non disponible
Imagen no disponible
Immagine non disponibile
Nicht verfügbares Bild
Brak zdjęcia
Картина недоступна

Picture not available
Image non disponible
Imagen no disponible
Immagine non disponibile
Nicht verfügbares Bild
Brak zdjęcia
Картина недоступна

CONNECTION SET 26	594129
DRIVE END HOUSING 14	594556
INDUCTION COIL 27	594534
PINION DRIVE 03	594030
PIGNON DRIVE SHAFT ASSEMBLY 02b	594536
REDUCTION GEAR ASSEMBLY 02	594022
REPAIR KIT 24	594084
PINION FORK SET 11	594068
SOLENOID SWITCH 04	594045
Valeo	432586/455632

D6RA72 1,2 Kw 3(2) ↻

12 V 9 N

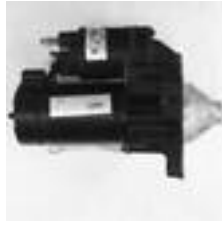

- BRUSHES AND SPRINGS SET** 🛠️09 594127
 - CONNECTION SET** 🛠️26 594129
 - DRIVE END HOUSING** 🛠️14 594584
 - INDUCTION COIL** 🛠️27 594534
 - PINION DRIVE** 🛠️03 594029
 - PIGNON DRIVE SHAFT ASSEMBLY** 🛠️02b 594539
 - REPAIR KIT** 🛠️24 594084
 - PINION FORK SET** 🛠️11 594068
 - SOLENOID SWITCH** 🛠️04 594183
- Valeo** 436019

D6RA721 1,2 Kw 3(2) ↻

12 V 9

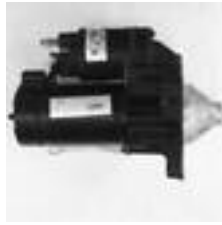

- ARMATURE** 🛠️02a 594529
 - BRUSHES AND SPRINGS SET** 🛠️09 594127
 - CONNECTION SET** 🛠️26 594129
 - DRIVE END HOUSING** 🛠️14 594584
 - INDUCTION COIL** 🛠️27 594534
 - PINION DRIVE** 🛠️03 594214
 - PIGNON DRIVE SHAFT ASSEMBLY** 🛠️02b 594547
 - REDUCTION GEAR ASSEMBLY** 🛠️02 594237
 - REPAIR KIT** 🛠️24 594084
 - PINION FORK SET** 🛠️11 594255
 - SOLENOID SWITCH** 🛠️04 594183
- Valeo** 436019

D6RA73 1,1 Kw 3(3) ↻

12 V 10



- ARMATURE** 🛠️02a 594526
 - BRUSHES AND SPRINGS SET** 🛠️09 594060
 - CONNECTION SET** 🛠️26 594569
 - DRIVE END HOUSING** 🛠️14 594534
 - INDUCTION COIL** 🛠️27 594252
 - PINION DRIVE** 🛠️03 594542
 - PIGNON DRIVE SHAFT ASSEMBLY** 🛠️02b 594233
 - REDUCTION GEAR ASSEMBLY** 🛠️02 594084
 - REPAIR KIT** 🛠️24 594255
 - PINION FORK SET** 🛠️11 594255
- Valeo** 436019

D6RA74 0,85 Kw 3(3) ↻

12 V 55° 9 N



- BRUSHES AND SPRINGS SET** 🛠️09 594258
 - CONNECTION SET** 🛠️26 594418
 - DRIVE END HOUSING** 🛠️14 594585
 - INDUCTION COIL** 🛠️27 594534
 - PINION DRIVE** 🛠️03 594214
 - PIGNON DRIVE SHAFT ASSEMBLY** 🛠️02b 594541
 - REDUCTION GEAR ASSEMBLY** 🛠️02 594176
 - REPAIR KIT** 🛠️24 594084
 - PINION FORK SET** 🛠️11 594255
 - SOLENOID SWITCH** 🛠️04 594183
- Valeo** 436019

D6RA75 1,1 Kw 2(0) ↻

12 V 9

Picture not available
Image non disponible
Imagen no disponible
Imagine non disponibile
Nicht verfügbares Bild
Brak zdjęcia
Картина недоступна

Picture not available
Image non disponible
Imagen no disponible
Imagine non disponibile
Nicht verfügbares Bild
Brak zdjęcia
Картина недоступна

- BRUSHES AND SPRINGS SET** 🛠️09 594127
 - CONNECTION SET** 🛠️26 594387
 - DRIVE END HOUSING** 🛠️14 594576
 - PINION DRIVE** 🛠️03 594284
 - PIGNON DRIVE SHAFT ASSEMBLY** 🛠️02b 594545
 - REPAIR KIT** 🛠️24 594084
 - PINION FORK SET** 🛠️11 594255
 - SOLENOID SWITCH** 🛠️04 594173
- Valeo** 432635

D6RA76 1,3 Kw 3(0) ↻

12 V 54° 8 N



- ARMATURE** 🛠️02a 594528
 - BRUSHES AND SPRINGS SET** 🛠️09 594258
 - CONNECTION SET** 🛠️26 594257
 - DRIVE END HOUSING** 🛠️14 594586
 - INDUCTION COIL** 🛠️27 594534
 - PINION DRIVE** 🛠️03 594247
 - PIGNON DRIVE SHAFT ASSEMBLY** 🛠️02b 594543
 - REDUCTION GEAR ASSEMBLY** 🛠️02 594236
 - REPAIR KIT** 🛠️24 594242
 - PINION FORK SET** 🛠️11 594255
 - PINION FORK SET** 🛠️11 594374
 - SOLENOID SWITCH** 🛠️04 594269
- Valeo** 436019



D6RA78

1,1 Kw

3(0)



12 V



Picture not available
Image non disponible
Imagen no disponible
Immagine non disponibile
Nicht verfügbares Bild
Brak zdjęcia
Картина недоступна

Picture not available
Image non disponible
Imagen no disponible
Immagine non disponibile
Nicht verfügbares Bild
Brak zdjęcia
Картина недоступна

ARMATURE 02a 594528
BRUSHES AND SPRINGS SET 09 594317
CONNECTION SET 26 594323
INDUCTION COIL 27 594534
PINION DRIVE 03 594247
PIGNON DRIVE SHAFT ASSEMBLY 02b 594543
REDUCTION GEAR ASSEMBLY 02 594236
REPAIR KIT 24 594242
PINION FORK SET 11 594255
Valeo 436019

D6RA79

1,1 Kw

3(0)



12 V



Picture not available
Image non disponible
Imagen no disponible
Immagine non disponibile
Nicht verfügbares Bild
Brak zdjęcia
Картина недоступна

Picture not available
Image non disponible
Imagen no disponible
Immagine non disponibile
Nicht verfügbares Bild
Brak zdjęcia
Картина недоступна

ARMATURE 02a 594528
BRUSHES AND SPRINGS SET 09 594317
CONNECTION SET 26 594323
INDUCTION COIL 27 594534
PINION DRIVE 03 594247
PIGNON DRIVE SHAFT ASSEMBLY 02b 594543
REDUCTION GEAR ASSEMBLY 02 594236
REPAIR KIT 24 594242
PINION FORK SET 11 594255
Valeo 436019

D6RA8

1,2 Kw

3(3)



12 V



ARMATURE 02a 594526
BRUSHES AND SPRINGS SET 09 594064
CONNECTION SET 26 594072
INDUCTION COIL 27 594534
PIGNON DRIVE SHAFT ASSEMBLY 02b 594538
REDUCTION GEAR ASSEMBLY 02 594019
REPAIR KIT 24 594084
PINION FORK SET 11 594068
SOLENOID SWITCH 04 594087
Valeo 436019

D6RA80

1 Kw

2(0)



12 V



ARMATURE 02a 594528
BRUSHES AND SPRINGS SET 09 594360
REPAIR KIT 24 594242
PINION FORK SET 11 594255
SOLENOID SWITCH 04 594357
Valeo 436019

D6RA81

1 Kw

2(0)



12 V



ARMATURE 02a 594528
BRUSHES AND SPRINGS SET 09 594360
PINION DRIVE 03 594361
REDUCTION GEAR ASSEMBLY 02 594363
REPAIR KIT 24 594242
PINION FORK SET 11 594255
Valeo 436019

D6RA811

1,1 Kw

2(0)



12 V

58°



N

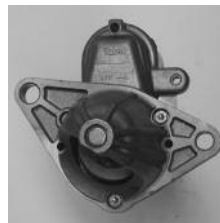

ARMATURE 02a 594530
BRUSHES AND SPRINGS SET 09 594317
CONNECTION SET 26 594771
INDUCTION COIL 27 594535
PINION DRIVE 03 594361
PIGNON DRIVE SHAFT ASSEMBLY 02b 594772
REPAIR KIT 24 594242
PINION FORK SET 11 594255
SOLENOID SWITCH 04 594145
Valeo 436019



D6RA82 1,1 Kw 2(1) ↻

12 V 10



ARMATURE 02a 594526
BRUSHES AND SPRINGS SET 09 594312
CONNECTION SET 26 594311
DRIVE END HOUSING 14 594591
INDUCTION COIL 27 594534
PINION DRIVE 03 594252
REPAIR KIT 24 594084
PINION FORK SET 11 594255
SOLENOID SWITCH 04 594117
Valeo 436019

D6RA83 1,1 Kw 2(0) ↻

12 V 38° 10 N



ARMATURE 02a 594529
BRUSHES AND SPRINGS SET 09 594404
DRIVE END HOUSING 14 594592
INDUCTION COIL 27 594534
PINION DRIVE 03 594252
PIGNON DRIVE SHAFT ASSEMBLY 02b 594551
PIGNON DRIVE SHAFT ASSEMBLY 02b 594660
REDUCTION GEAR ASSEMBLY 02 594402
REPAIR KIT 24 594242
PINION FORK SET 11 594255
SOLENOID SWITCH 04 594401
Valeo 436019

D6RA84 1,3 Kw 2(0) ↻

12 V 9

Picture not available
 Image non disponible
 Imagen no disponible
 Immagine non disponibile
 Nicht verfügbares Bild
 Brak zdjęcia
 Картина недоступна

Picture not available
 Image non disponible
 Imagen no disponible
 Immagine non disponibile
 Nicht verfügbares Bild
 Brak zdjęcia
 Картина недоступна

ARMATURE 02a 594529
BRUSHES AND SPRINGS SET 09 594437
CONNECTION SET 26 594608
DRIVE END HOUSING 14 594606
INDUCTION COIL 27 594534
PINION DRIVE 03 594214
PIGNON DRIVE SHAFT ASSEMBLY 02b 594609
REPAIR KIT 24 594242
PINION FORK SET 11 594255
SOLENOID SWITCH 04 594607
Valeo 438029

D6RA87 1,3 Kw 3(3) ↻

12 V 33° 9 N



ARMATURE 02a 594529
BRUSHES AND SPRINGS SET 09 594377
CONNECTION SET 26 594416
DRIVE END HOUSING 14 594593
INDUCTION COIL 27 594534
PINION DRIVE 03 594214
PIGNON DRIVE SHAFT ASSEMBLY 02b 594609
REDUCTION GEAR ASSEMBLY 02 594409
REPAIR KIT 24 594242
PINION FORK SET 11 594255
SOLENOID SWITCH 04 594414
Valeo 436019

D6RA91 1 Kw 2(0) ↻

12 V 53° 9 N



ARMATURE 02a 594528
BRUSHES AND SPRINGS SET 09 594360
DRIVE END HOUSING 14 594594
REDUCTION GEAR ASSEMBLY 02 594446
REPAIR KIT 24 594242
PINION FORK SET 11 594255
Valeo 436019

D6RA93 1,3 Kw 2(0) ↻

12 V 75° 10 N



ARMATURE 02a 594526
BRUSHES AND SPRINGS SET 09 594317
CONNECTION SET 26 594637
DRIVE END HOUSING 14 594579
INDUCTION COIL 27 594534
PINION DRIVE 03 594252
PIGNON DRIVE SHAFT ASSEMBLY 02b 594542
REDUCTION GEAR ASSEMBLY 02 594233
REPAIR KIT 24 594084
PINION FORK SET 11 594374
SOLENOID SWITCH 04 594636
Valeo 436019



D6RAD183 1,3 Kw 2(0) ↻

12 V 37° ↙ ⚙️10 N



- ARMATURE ⚙️02a 594529
 - BRUSHES AND SPRINGS SET ⚙️09 594404
 - DRIVE END HOUSING ⚙️14 594592
 - SOLENOID SWITCH ⚙️04 594461
 - INDUCTION COIL ⚙️27 594534
 - PINION DRIVE ⚙️03 594252
 - PIGNON DRIVE SHAFT ASSEMBLY ⚙️02b 594551
 - REDUCTION GEAR ASSEMBLY ⚙️02 594402
 - REPAIR KIT ⚙️24 594242
 - PINION FORK SET ⚙️11 594460
- Valeo** 436019

D7E1 0,85 Kw 2(1) ↻

12 V 37° ↙ ⚙️9 N



- ARMATURE ⚙️02a 594518
 - BRUSH HOLDER PLATE ASSEMBLY ⚙️08 594290
 - BUSHING KIT ⚙️10 594456
 - DRIVE END HOUSING ⚙️14 594506
 - INDUCTION COIL ⚙️27 594522
 - PINION DRIVE ⚙️03 594287
 - PINION FORK SET ⚙️11 594289
 - SOLENOID SWITCH ⚙️04 594288
- Valeo** 436019

D7E15 0,85 Kw 3(3) ↻

12 V 38° ↙ ⚙️8 N



- ARMATURE ⚙️02a 594519
 - BRUSH HOLDER PLATE ASSEMBLY ⚙️08 594351
 - BUSHING KIT ⚙️10 594457
 - DRIVE END HOUSING ⚙️14 594509
 - INDUCTION COIL ⚙️27 594477
 - PINION DRIVE ⚙️03 594345
 - PINION FORK SET ⚙️11 594289
 - SOLENOID SWITCH ⚙️04 594407
- Valeo** 436019

D7E16 0,8 Kw 3(1) ↻

12 V 55° ↘ ⚙️9 N



- ARMATURE ⚙️02a 594518
 - BRUSH HOLDER PLATE ASSEMBLY ⚙️08 594290
 - BUSHING KIT ⚙️10 594456
 - DRIVE END HOUSING ⚙️14 594507
 - INDUCTION COIL ⚙️27 594522
 - PINION DRIVE ⚙️03 594287
 - PINION FORK SET ⚙️11 594289
 - SOLENOID SWITCH ⚙️04 594348
- Valeo** 436019

D7E18 1 Kw 2(0) ↻

12 V 32° ↙ ⚙️8 N



- ARMATURE ⚙️02a 594519
 - BRUSH HOLDER PLATE ASSEMBLY ⚙️08 594351
 - BUSHING KIT ⚙️10 594457
 - DRIVE END HOUSING ⚙️14 594508
 - INDUCTION COIL ⚙️27 594477
 - PINION DRIVE ⚙️03 594345
 - PINION FORK SET ⚙️11 594417
 - SOLENOID SWITCH ⚙️04 594421
- Valeo** 436019

D7E19 0,85 Kw 3(3) ↻

12 V 50° ↘ ⚙️8 N



- ARMATURE ⚙️02a 594518
 - BRUSH HOLDER PLATE ASSEMBLY ⚙️08 594351
 - BUSHING KIT ⚙️10 594457
 - DRIVE END HOUSING ⚙️14 594510
 - INDUCTION COIL ⚙️27 594477
 - PINION DRIVE ⚙️03 594436
 - PINION FORK SET ⚙️11 594289
 - SOLENOID SWITCH ⚙️04 594438
- Valeo** 436019

D7E20	0,85 Kw	3(3)	↻
12 V	38°	8	N



ARMATURE 02a 594518
BRUSH HOLDER PLATE ASSEMBLY 08 594351
BUSHING KIT 10 594457
DRIVE END HOUSING 14 594509
INDUCTION COIL 27 594477
PINION DRIVE 03 594436
PINION FORK SET 11 594289
SOLENOID SWITCH 04 594407
Valeo 436019

D7E22	0,85 Kw	3(3)	↻
12 V	50°	8	N



ARMATURE 02a 594518
BRUSH HOLDER PLATE ASSEMBLY 08 594351
BUSHING KIT 10 594457
DRIVE END HOUSING 14 594510
INDUCTION COIL 27 594477
PINION DRIVE 03 594436
PINION FORK SET 11 594289
SOLENOID SWITCH 04 594355
Valeo 436019

D7E23	0,85 Kw	3(1)	↻
12 V	55°	9	N

Picture not available
 Image non disponible
 Imagen no disponible
 Immagine non disponibile
 Nicht verfügbares Bild
 Brak zdjęcia
 Картина недоступна

Picture not available
 Image non disponible
 Imagen no disponible
 Immagine non disponibile
 Nicht verfügbares Bild
 Brak zdjęcia
 Картина недоступна

ARMATURE 02a 594518
BRUSH HOLDER PLATE ASSEMBLY 08 594351
BRUSH HOLDER PLATE ASSEMBLY 08 594479
BUSHING KIT 10 594457
INDUCTION COIL 27 594477
INDUCTION COIL 27 594478
PINION DRIVE 03 594287
PINION FORK SET 11 594289
SOLENOID SWITCH 04 594348
Valeo 438129

D7E26	0,75 Kw	3(3)	↻
12 V	50°	9	N



ARMATURE 02a 594518
BRUSHES AND SPRINGS SET 09 594450
BUSHING KIT 10 594456
DRIVE END HOUSING 14 594511
PINION DRIVE 03 594287
PINION FORK SET 11 594289
SOLENOID SWITCH 04 594438
Valeo 436019

D7E27	0,85 Kw	3(3)	↻
12 V	50°	8	N



ARMATURE 02a 594518
BRUSH HOLDER PLATE ASSEMBLY 08 594351
BUSHING KIT 10 594457
DRIVE END HOUSING 14 594510
INDUCTION COIL 27 594477
PINION DRIVE 03 594436
PINION FORK SET 11 594289
SOLENOID SWITCH 04 594653
Valeo 436019

D7E29	0,7 Kw	2(1)	↻
12 V	35°	8	N



ARMATURE 02a 594519
BRUSH HOLDER PLATE ASSEMBLY 08 594290
BUSHING KIT 10 594456
DRIVE END HOUSING 14 594512
INDUCTION COIL 27 594522
PINION DRIVE 03 594451
PINION FORK SET 11 594289
SOLENOID SWITCH 04 594452
Valeo 436019

D7E30 0,7 Kw 2(1) ↻

12 V 35° 8 N

Picture not available
Image non disponible
Imagem no disponbile
Immagine non disponibile
Nicht verfügbares Bild
Brak zdjęcia
Картина недоступна

Picture not available
Image non disponible
Imagem no disponbile
Immagine non disponibile
Nicht verfügbares Bild
Brak zdjęcia
Картина недоступна

ARMATURE 02a 594519
BRUSH HOLDER PLATE ASSEMBLY 08 594290
BUSHING KIT 10 594456
INDUCTION COIL 27 594522
PINION DRIVE 03 594451
PINION FORK SET 11 594289
SOLENOID SWITCH 04 594452
Valeo 436019

D7E31 0,7 Kw 2(1) ↻

12 V 54° 8 N



ARMATURE 02a 594519
BRUSH HOLDER PLATE ASSEMBLY 08 594290
BUSHING KIT 10 594456
INDUCTION COIL 27 594522
PINION DRIVE 03 594451
PINION FORK SET 11 594289
SOLENOID SWITCH 04 594452
Valeo 436019

D7E32 0,7 Kw 2(1) ↻

12 V 35° 8 N



ARMATURE 02a 594519
BRUSH HOLDER PLATE ASSEMBLY 08 594290
BUSHING KIT 10 594456
INDUCTION COIL 27 594522
PINION DRIVE 03 594451
PINION FORK SET 11 594289
SOLENOID SWITCH 04 594481
Valeo 436019

D7E38 1 Kw 2(0) ↻

12 V 32° 8 N

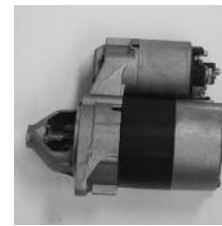

ARMATURE 02a 594518
BRUSH HOLDER PLATE ASSEMBLY 08 594351
BUSHING KIT 10 594457
DRIVE END HOUSING 14 594508
INDUCTION COIL 27 594477
PINION DRIVE 03 594436
PINION FORK SET 11 594289
SOLENOID SWITCH 04 594727
Valeo 436019

D7E39 0,85 Kw 2(1) ↻

12 V 37° 9 N



ARMATURE 02a 594518
BRUSH HOLDER PLATE ASSEMBLY 08 594290
BUSHING KIT 10 594456
DRIVE END HOUSING 14 594506
INDUCTION COIL 27 594522
PINION DRIVE 03 594287
PINION FORK SET 11 594289
SOLENOID SWITCH 04 594698
Valeo 436019

D7E4 1 Kw 2(0) ↻

12 V 8

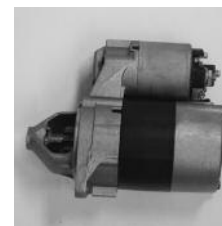

ARMATURE 02a 594519
BRUSH HOLDER PLATE ASSEMBLY 08 594351
BUSHING KIT 10 594457
CED + SHIFT LEVER ASSEMBLY 04 + 11 594447
DRIVE END HOUSING 14 594508
INDUCTION COIL 27 594477
PINION DRIVE 03 594345
Valeo 436019

D7E40 0,7 Kw 2(1) ↻

12 V 35° 8 N

Picture not available
Image non disponible
Imagen no disponible
Immagine non disponibile
Nicht verfügbares Bild
Brak zdjęcia
Картина недоступна

Picture not available
Image non disponible
Imagen no disponible
Immagine non disponibile
Nicht verfügbares Bild
Brak zdjęcia
Картина недоступна

ARMATURE 02a 594518
BRUSH HOLDER PLATE ASSEMBLY 08 594290
BUSHING KIT 10 594456
DRIVE END HOUSING 14 594697
INDUCTION COIL 27 594522
PINION DRIVE 03 *595733
PINION FORK SET 11 594289
SOLENOID SWITCH 04 594452
Valeo 436019

D7E41 0,7 Kw 2(1) ↻

12 V 54° 8 N



ARMATURE 02a 594518
BRUSH HOLDER PLATE ASSEMBLY 08 594290
BUSHING KIT 10 594456
INDUCTION COIL 27 594522
PINION DRIVE 03 *595733
PINION FORK SET 11 594289
SOLENOID SWITCH 04 594452
Valeo 436019

D7E42 0,7 Kw 2(1) ↻

12 V 35° 8 N



ARMATURE 02a 594518
BRUSH HOLDER PLATE ASSEMBLY 08 594290
BUSHING KIT 10 594457
INDUCTION COIL 27 594522
PINION DRIVE 03 *595733
PINION FORK SET 11 594289
SOLENOID SWITCH 04 594481
Valeo 436019

D7E47 0,85 Kw 3(3) ↻

12 V 50° 8 N



ARMATURE 02a 594518
BRUSH HOLDER PLATE ASSEMBLY 08 594351
BUSHING KIT 10 594457
DRIVE END HOUSING 14 594510
INDUCTION COIL 27 594477
PINION DRIVE 03 594436
PINION FORK SET 11 594289
SOLENOID SWITCH 04 594653
Valeo 436019

D7E5 0,85 Kw 3(1) ↻

12 V 9



SOLENOID SWITCH 04 594348
Valeo 436019

D7E52 0,9 Kw 2(1) ↻

12 V 47° 9 N

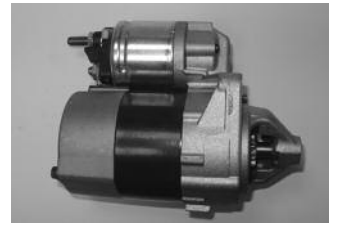

ARMATURE 02a 594518
BRUSH HOLDER PLATE ASSEMBLY 08 594351
BRUSH HOLDER PLATE ASSEMBLY 08 594479
BUSHING KIT 10 594457
DRIVE END HOUSING 14 594514
INDUCTION COIL 27 594477
INDUCTION COIL 27 594478
PINION DRIVE 03 594287
PINION FORK SET 11 594289
SOLENOID SWITCH 04 594459
Valeo 436019



D7E6

0,85 Kw

3(3)

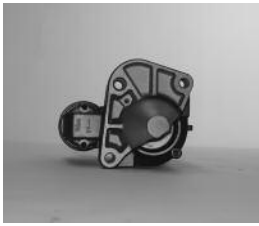

12 V

**ARMATURE** 02a

594519

BRUSH HOLDER PLATE ASSEMBLY 08

594351

BUSHING KIT 10

594457

DRIVE END HOUSING 14

594510

INDUCTION COIL 27

594477

PINION DRIVE 03

594345

PINION FORK SET 11

594289

SOLENOID SWITCH 04

594355

Valeo**436019****D7E62**

0,8 Kw

3(3)



12 V

70°



N

**ARMATURE** 02a

594518

BRUSH HOLDER PLATE ASSEMBLY 08

594479

BUSHING KIT 10

594457

DRIVE END HOUSING 14

594764

INDUCTION COIL 27

594478

PINION DRIVE 03

594287

PINION FORK SET 11

594289

SOLENOID SWITCH 04

594763

Valeo**436019****D7E70**

0,8 Kw

4(4)



12 V

48°



N

**ARMATURE** 02a

594518

BRUSH HOLDER PLATE ASSEMBLY 08

594351

BUSHING KIT 10

594457

DRIVE END HOUSING 14

594762

INDUCTION COIL 27

594477

PINION DRIVE 03

594760

PINION FORK SET 11

594289

SOLENOID SWITCH 04

594761

Valeo**436019****D7E79**

0,8 Kw

3(2)



12 V

45°



N

**ARMATURE** 02a

594518

BRUSH HOLDER PLATE ASSEMBLY 08

594479

BUSHING KIT 10

594457

DRIVE END HOUSING 14

594766

INDUCTION COIL 27

594478

PINION DRIVE 03

594287

PINION FORK SET 11

594289

SOLENOID SWITCH 04

594765

Valeo**436019****D7E8**

1 Kw

2(0)



12 V

32°

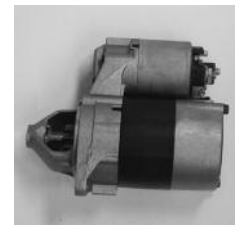

N

**ARMATURE** 02a

594519

BRUSH HOLDER PLATE ASSEMBLY 08

594351

BUSHING KIT 10

594457

CED + SHIFT LEVER ASSEMBLY 04 + 11

594447

DRIVE END HOUSING 14

594508

INDUCTION COIL 27

594477

PINION DRIVE 03

594345

Valeo**436019****D7ED28**

0,8 Kw

2(0)



12 V

32°



N

**ARMATURE** 02a

594519

BRUSH HOLDER PLATE ASSEMBLY 08

594351

BUSHING KIT 10

594457

DRIVE END HOUSING 14

594508

SOLENOID SWITCH 04

594463

INDUCTION COIL 27

594477

PINION DRIVE 03

594345

PINION FORK SET 11

594462

Valeo**436019**

D7ED281	0,8 Kw	2(0)	↻
12 V	32°	8	N



ARMATURE 02a 594518
BRUSH HOLDER PLATE ASSEMBLY 08 594351
BUSHING KIT 10 594457
DRIVE END HOUSING 14 594508
SOLENOID SWITCH 04 594463
INDUCTION COIL 27 594477
PINION DRIVE 03 594436
PINION FORK SET 11 594462
Valeo 436019

D7ES2	0,9 Kw	3(1)	↻
12 V	85°	8	N

Picture not available
 Image non disponible
 Imagen no disponible
 Immagine non disponibile
 Nicht verfügbares Bild
 Brak zdjęcia
 Картина недоступна

Picture not available
 Image non disponible
 Imagen no disponible
 Immagine non disponibile
 Nicht verfügbares Bild
 Brak zdjęcia
 Картина недоступна

BRUSH HOLDER PLATE ASSEMBLY 08 594381
BUSHING KIT 10 594458
SOLENOID SWITCH 04 594413
Valeo 436019

D7ES4	0,9 Kw	3(1)	↻
12 V	85°	8	N

Picture not available
 Image non disponible
 Imagen no disponible
 Immagine non disponibile
 Nicht verfügbares Bild
 Brak zdjęcia
 Картина недоступна

Picture not available
 Image non disponible
 Imagen no disponible
 Immagine non disponibile
 Nicht verfügbares Bild
 Brak zdjęcia
 Картина недоступна

BRUSH HOLDER PLATE ASSEMBLY 08 594381
BUSHING KIT 10 594458
SOLENOID SWITCH 04 594413
Valeo 436019

D7ES5	0,9 Kw	3(0)	↻
12 V	40°	9	N



BRUSH HOLDER PLATE ASSEMBLY 08 594381
ARMATURE 02a *595727
DRIVE END HOUSING 14 594517
PINION FORK SET 11 594455
SOLENOID SWITCH 04 594413
Valeo 436019

D7ES7	0,9 Kw	3(0)	↻
12 V	40°	9	N



BRUSH HOLDER PLATE ASSEMBLY 08 594381
ARMATURE 02a *595727
DRIVE END HOUSING 14 594517
PINION FORK SET 11 594455
SOLENOID SWITCH 04 594767
Valeo 436019

D7G11	2 Kw	4(3)	↻
12 V	32°	10	N



ARMATURE 02a 594621
DRIVE END HOUSING 14 594656
PINION DRIVE 03 594657
PINION FORK SET 11 594466
SOLENOID SWITCH 04 594658
Valeo 436019

D7G13	1,5 Kw	3(0)	↻
12 V	90°	10	N

Picture not available
 Image non disponible
 Imagen no disponible
 Immagine non disponibile
 Nicht verfügbares Bild
 Brak zdjęcia
 Картина недоступна

Picture not available
 Image non disponible
 Imagen no disponible
 Immagine non disponibile
 Nicht verfügbares Bild
 Brak zdjęcia
 Картина недоступна

ARMATURE 02a 594621
DRIVE END HOUSING 14 594713
INDUCTION COIL 27 594469
PINION DRIVE 03 594465
REPAIR KIT 24 594714
PINION FORK SET 11 594616
SOLENOID SWITCH 04 594454
Valeo 436019

D7G14 2,2 Kw 3(0) ↻

12 V 25° ↙ ☀10 N

Picture not available
Image non disponible
Imagen no disponible
Immagine non disponibile
Nicht verfügbares Bild
Brak zdjęcia
Картина недоступна

Picture not available
Image non disponible
Imagen no disponible
Immagine non disponibile
Nicht verfügbares Bild
Brak zdjęcia
Картина недоступна

ARMATURE 🛠️02a 594683
DRIVE END HOUSING 🛠️14 594728
INDUCTION COIL 🛠️27 594708
PINION DRIVE 🛠️03 594729
PIGNON DRIVE SHAFT ASSEMBLY 🛠️02b 594732
PINION FORK SET 🛠️11 594730
SOLENOID SWITCH 🛠️04 594731
Valeo 436019

D7G15 2,2 Kw 3(0) ↻

12 V 25° ↘ ☀10 N

Picture not available
Image non disponible
Imagen no disponible
Immagine non disponibile
Nicht verfügbares Bild
Brak zdjęcia
Картина недоступна

Picture not available
Image non disponible
Imagen no disponible
Immagine non disponibile
Nicht verfügbares Bild
Brak zdjęcia
Картина недоступна

ARMATURE 🛠️02a 594683
DRIVE END HOUSING 🛠️14 594737
INDUCTION COIL 🛠️27 594708
PINION DRIVE 🛠️03 594729
PIGNON DRIVE SHAFT ASSEMBLY 🛠️02b 594732
PINION FORK SET 🛠️11 594730
SOLENOID SWITCH 🛠️04 594739
Valeo 436019

D7G18 2,2 Kw 3(0) ↻

12 V 25° ↘ ☀10 N



ARMATURE 🛠️02a 594683
DRIVE END HOUSING 🛠️14 594737
INDUCTION COIL 🛠️27 594708
PINION DRIVE 🛠️03 594729
PIGNON DRIVE SHAFT ASSEMBLY 🛠️02b 594732
PINION FORK SET 🛠️11 594730
SOLENOID SWITCH 🛠️04 594738
Valeo 436019

D7G26 2,2 Kw 4(2) ↻

12 V 38° ↙ ☀11 N

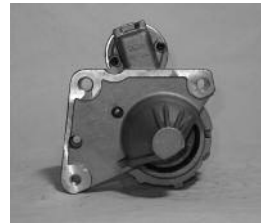

ARMATURE 🛠️02a 594683
DRIVE END HOUSING 🛠️14 594707
INDUCTION COIL 🛠️27 594708
PINION DRIVE 🛠️03 594631
PIGNON DRIVE SHAFT ASSEMBLY 🛠️02b 594709
PINION FORK SET 🛠️11 594710
SOLENOID SWITCH 🛠️04 595731
Valeo 436019

D7G3 1,5 Kw 4(2) ↻

12 V 37° ↙ ☀11 N



ARMATURE 🛠️02a 594621
DRIVE END HOUSING 🛠️14 594630
PINION DRIVE 🛠️03 594631
REPAIR KIT 🛠️24 594633
PINION FORK SET 🛠️11 594466
SOLENOID SWITCH 🛠️04 595731
Valeo 436019

D7G4 1,6 Kw 3(2) ↻

12 V 90° ↙ ☀10 N



ARMATURE 🛠️02a 594621
DRIVE END HOUSING 🛠️14 594504
INDUCTION COIL 🛠️27 594469
PINION DRIVE 🛠️03 594465
REPAIR KIT 🛠️24 594468
PINION FORK SET 🛠️11 594466
SOLENOID SWITCH 🛠️04 594467
Valeo 436019

D7G6 1,7 Kw 3(2) ↻

12 V 27° 9 N



ARMATURE 02a 594621
DRIVE END HOUSING 14 594614
INDUCTION COIL 27 594619
PINION DRIVE 03 594616
PINION FORK SET 11 *595617
SOLENOID SWITCH 04 436019
Valeo

D7GS10 2 Kw 2(0) ↻

12 V 48° 11 N



ARMATURE 02a 594683
DRIVE END HOUSING 14 594676
INDUCTION COIL 27 *595623
PINION DRIVE 03 594678
PIGNON DRIVE SHAFT ASSEMBLY 02b 594682
REPAIR KIT 24 594625
PINION FORK SET 11 594679
SOLENOID SWITCH 04 594617
Valeo 436019

D7GS17 1,7 Kw 3(2) ↻

12 V 27° 9 N



ARMATURE 02a 594621
DRIVE END HOUSING 14 594639
INDUCTION COIL 27 594619
PINION DRIVE 03 594640
REPAIR KIT 24 594625
PINION FORK SET 11 594616
SOLENOID SWITCH 04 594624
Valeo 436019

D7GS7 1,7 Kw 3(2) ↻

12 V 39° 9 N



ARMATURE 02a 594621
INDUCTION COIL 27 594619
PINION DRIVE 03 594640
REPAIR KIT 24 594625
PINION FORK SET 11 594616
SOLENOID SWITCH 04 594624
Valeo 436019

D7GS8 2 Kw 3(0) ↻

12 V 45° 11 N



ARMATURE 02a 594683
DRIVE END HOUSING 14 594675
PINION DRIVE 03 594677
PIGNON DRIVE SHAFT ASSEMBLY 02b 594681
REPAIR KIT 24 594669
PINION FORK SET 11 594679
SOLENOID SWITCH 04 594617
Valeo 436019

D7GS9 1,7 Kw 3(0) ↻

12 V 54° 9 N

Picture not available
Image non disponible
Imagen no disponible
Immagine non disponibile
Nicht verfügbares Bild
Brak zdjęcia
Картина недоступна

Picture not available
Image non disponible
Imagen no disponible
Immagine non disponibile
Nicht verfügbares Bild
Brak zdjęcia
Картина недоступна

DRIVE END HOUSING 14 594691
INDUCTION COIL 27 594619
PINION DRIVE 03 594640
PIGNON DRIVE SHAFT ASSEMBLY 02b 594694
PINION FORK SET 11 594616
SOLENOID SWITCH 04 594617
Valeo 436019

D7R1

1,4 Kw

3(1)



12 V

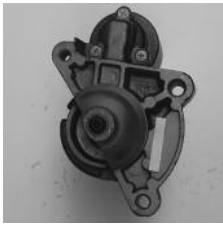

ARMATURE 02a 594112
DRIVE END HOUSING 14 594483
INDUCTION COIL 27 594115
PINION DRIVE 03 594136
PIGNON DRIVE SHAFT ASSEMBLY 02b 594141
REPAIR KIT 24 594116
PINION FORK SET 11 594262
SOLENOID SWITCH 04 594426
Valeo 436019

D7R11

1,4 Kw

3(1)



12 V



ARMATURE 02a 594112
INDUCTION COIL 27 594115
PINION DRIVE 03 594136
PIGNON DRIVE SHAFT ASSEMBLY 02b 594187
REPAIR KIT 24 594210
PINION FORK SET 11 594262
SOLENOID SWITCH 04 594426
Valeo 436019

D7R12

1,7 Kw

3(3)



12 V



ARMATURE 02a 594112
DRIVE END HOUSING 14 594487
PINION DRIVE 03 594185
PIGNON DRIVE SHAFT ASSEMBLY 02b 594187
REPAIR KIT 24 594210
PINION FORK SET 11 594262
SOLENOID SWITCH 04 594188
Valeo 436019

D7R13

1,6 Kw

3(3)



12 V



ARMATURE 02a 594112
DRIVE END HOUSING 14 594488
INDUCTION COIL 27 594115
PINION DRIVE 03 594185
PIGNON DRIVE SHAFT ASSEMBLY 02b 594187
REPAIR KIT 24 594210
PINION FORK SET 11 594262
SOLENOID SWITCH 04 594275
Valeo 436019

D7R14

2,5 Kw

2(0)



12 V



Picture not available
 Image non disponibile
 Imagen no disponible
 Immagine non disponibile
 Nicht verfügbares Bild
 Brak zdjęcie
 Картина недоступна

Picture not available
 Image non disponibile
 Imagen no disponible
 Immagine non disponibile
 Nicht verfügbares Bild
 Brak zdjęcie
 Картина недоступна

ARMATURE 02a 594112
DRIVE END HOUSING 14 594489
PINION DRIVE 03 594308
PIGNON DRIVE SHAFT ASSEMBLY 02b 594307
REPAIR KIT 24 594310
PINION FORK SET 11 594262
SOLENOID SWITCH 04 594309
Valeo 436019

D7R15

1,7 Kw

3(1)



12 V



ARMATURE 02a 594112
DRIVE END HOUSING 14 594483
INDUCTION COIL 27 594115
PINION DRIVE 03 594136
PIGNON DRIVE SHAFT ASSEMBLY 02b 594187
REPAIR KIT 24 594210
PINION FORK SET 11 594262
SOLENOID SWITCH 04 594426
Valeo 436019

D7R151 1,7 Kw 3(1) ↻

12 V 55° 10 N



ARMATURE 02a 594112
DRIVE END HOUSING 14 594483
INDUCTION COIL 27 594115
PINION DRIVE 03 594136
PIGNON DRIVE SHAFT ASSEMBLY 02b 594187
REPAIR KIT 24 594210
PINION FORK SET 11 594262
SOLENOID SWITCH 04 594426
Valeo 436019

D7R16 1,7 Kw 3(3) ↻

12 V 11



ARMATURE 02a 594112
DRIVE END HOUSING 14 594490
INDUCTION COIL 27 594115
PINION DRIVE 03 594185
PIGNON DRIVE SHAFT ASSEMBLY 02b 594187
REPAIR KIT 24 594210
PINION FORK SET 11 594262
Valeo 436019

D7R17 1,5 Kw 3(0) ↻

12 V 10



ARMATURE 02a 594112
DRIVE END HOUSING 14 594491
INDUCTION COIL 27 594115
PINION DRIVE 03 594303
PIGNON DRIVE SHAFT ASSEMBLY 02b 594283
REPAIR KIT 24 594210
SOLENOID SWITCH 04 594188
Valeo 436019

D7R18 1,7 Kw 3(3) ↻

12 V 11

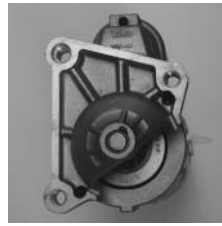

ARMATURE 02a 594112
DRIVE END HOUSING 14 594488
PINION DRIVE 03 594185
PIGNON DRIVE SHAFT ASSEMBLY 02b 594187
REPAIR KIT 24 594210
PINION FORK SET 11 594262
SOLENOID SWITCH 04 594267
Valeo 436019

D7R19 2 Kw 3(0) ↻

12 V 11



ARMATURE 02a 594112
DRIVE END HOUSING 14 594492
PINION DRIVE 03 594279
PIGNON DRIVE SHAFT ASSEMBLY 02b 594283
REPAIR KIT 24 594282
PINION FORK SET 11 594281
SOLENOID SWITCH 04 594271
Valeo 436019

D7R2 1,4 Kw 3(2) ↻

12 V 10



ARMATURE 02a 594112
INDUCTION COIL 27 594115
PINION DRIVE 03 594136
PIGNON DRIVE SHAFT ASSEMBLY 02b 594141
REPAIR KIT 24 594116
PINION FORK SET 11 594262
Valeo 436019



D7R20

1,7 Kw

3(3)



12 V



ARMATURE 02a 594112
DRIVE END HOUSING 14 594487
INDUCTION COIL 27 594353
PINION DRIVE 03 594185
PIGNON DRIVE SHAFT ASSEMBLY 02b 594187
REPAIR KIT 24 594210
PINION FORK SET 11 594262
SOLENOID SWITCH 04 594188
Valeo 436019

D7R22

2,2 Kw

3(3)



12 V



ARMATURE 02a 594112
DRIVE END HOUSING 14 594493
INDUCTION COIL 27 594326
PINION DRIVE 03 594324
PIGNON DRIVE SHAFT ASSEMBLY 02b 594283
REPAIR KIT 24 594327
PINION FORK SET 11 594262
SOLENOID SWITCH 04 594325
Valeo 436019

D7R23

2,4 Kw

3(2)



12 V



ARMATURE 02a 594112
DRIVE END HOUSING 14 594494
INDUCTION COIL 27 594326
PINION DRIVE 03 594324
PIGNON DRIVE SHAFT ASSEMBLY 02b 594283
REPAIR KIT 24 594327
PINION FORK SET 11 594262
SOLENOID SWITCH 04 594325
Valeo 436019

D7R24

1,4 Kw

3(3)



12 V



Picture not available
 Image non disponible
 Imagen no disponible
 Immagine non disponibile
 Nicht verfügbares Bild
 Brak zdjęcia
 Картина недоступна

Picture not available
 Image non disponible
 Imagen no disponible
 Immagine non disponibile
 Nicht verfügbares Bild
 Brak zdjęcia
 Картина недоступна

ARMATURE 02a 594112
DRIVE END HOUSING 14 594487
INDUCTION COIL 27 594115
PINION DRIVE 03 594136
PIGNON DRIVE SHAFT ASSEMBLY 02b 594187
REPAIR KIT 24 594210
PINION FORK SET 11 594262
SOLENOID SWITCH 04 594188
Valeo 438013

D7R25

1,7 Kw

3(3)



12 V



ARMATURE 02a 594112
DRIVE END HOUSING 14 594488
INDUCTION COIL 27 594115
PINION DRIVE 03 594185
PIGNON DRIVE SHAFT ASSEMBLY 02b 594187
REPAIR KIT 24 594210
PINION FORK SET 11 594262
SOLENOID SWITCH 04 594267
Valeo 436019

D7R26

1,4 Kw

3(3)



12 V

34°



N



ARMATURE 02a 594112
DRIVE END HOUSING 14 594487
INDUCTION COIL 27 594115
PINION DRIVE 03 594185
PIGNON DRIVE SHAFT ASSEMBLY 02b 594187
REPAIR KIT 24 594210
PINION FORK SET 11 594262
SOLENOID SWITCH 04 594613
Valeo 436019

D7R27

1,7 Kw

3(3)



12 V

34°



N

**ARMATURE**

594112

DRIVE END HOUSING

594487

PINION DRIVE

594185

PIGNON DRIVE SHAFT ASSEMBLY

594187

REPAIR KIT

594210

PINION FORK SET

594262

SOLENOID SWITCH

594613

Valeo**436019****D7R28**

2,2 Kw

3(0)



12 V

**ARMATURE**

594112

DRIVE END HOUSING

594492

INDUCTION COIL

594354

PINION DRIVE

594279

PIGNON DRIVE SHAFT ASSEMBLY

594283

REPAIR KIT

594282

PINION FORK SET

594281

SOLENOID SWITCH

594271

Valeo**436019****D7R281**

2,2 Kw

3(0)



12 V

30°



N

Picture not available
Image non disponible
Imagen no disponible
Immagine non disponibile
Nicht verfügbares Bild
Brak zdjęcia
Картина недоступна

Picture not available
Image non disponible
Imagen no disponible
Immagine non disponibile
Nicht verfügbares Bild
Brak zdjęcia
Картина недоступна

ARMATURE

594112

DRIVE END HOUSING

594492

INDUCTION COIL

594354

PINION DRIVE

594279

PIGNON DRIVE SHAFT ASSEMBLY

594283

REPAIR KIT

594282

PINION FORK SET

594281

SOLENOID SWITCH

594271

Valeo**438215/ly new****D7R3**

1,4 Kw

3(1)



12 V

**ARMATURE**

594112

INDUCTION COIL

594115

PINION DRIVE

594136

PIGNON DRIVE SHAFT ASSEMBLY

594141

REPAIR KIT

594116

PINION FORK SET

594262

SOLENOID SWITCH

594426

Valeo**436019****D7R33**

2 Kw

3(0)



12 V

**ARMATURE**

594112

DRIVE END HOUSING

594495

PINION DRIVE

594136

REPAIR KIT

594371

PINION FORK SET

594369

SOLENOID SWITCH

594370

Valeo**436019****D7R34**

2 Kw

3(2)



12 V

32°



N

**ARMATURE**

594112

DRIVE END HOUSING

594494

INDUCTION COIL

594115

PINION DRIVE

594410

PIGNON DRIVE SHAFT ASSEMBLY

594187

REPAIR KIT

594327

PINION FORK SET

594262

SOLENOID SWITCH

594188

Valeo**436019**

D7R35 2 Kw 3(3) ↻

12 V 32° ↙ ⚙11 N



ARMATURE ⚙02a 594112
DRIVE END HOUSING ⚙14 594488
INDUCTION COIL ⚙27 594115
PINION DRIVE ⚙03 594185
PIGNON DRIVE SHAFT ASSEMBLY ⚙02b 594187
REPAIR KIT ⚙24 594210
PINION FORK SET ⚙11 594262
SOLENOID SWITCH ⚙04 594388
Valeo 436019

D7R36 2,2 Kw 3(0) ↻

12 V 0° ↙ ⚙10 N



ARMATURE ⚙02a 594112
INDUCTION COIL ⚙27 594354
PIGNON DRIVE SHAFT ASSEMBLY ⚙02b 594505
REPAIR KIT ⚙24 594399
PINION FORK SET ⚙11 594397
SOLENOID SWITCH ⚙04 594398
Valeo 436019

D7R37 2,2 Kw 3(0) ↻

12 V 0° ↙ ⚙10 N



ARMATURE ⚙02a 594112
DRIVE END HOUSING ⚙14 594499
INDUCTION COIL ⚙27 594354
PIGNON DRIVE SHAFT ASSEMBLY ⚙02b 594505
REPAIR KIT ⚙24 594399
PINION FORK SET ⚙11 594397
SOLENOID SWITCH ⚙04 594482
Valeo 436019

D7R39 2,4 Kw 2(0) ↻

12 V 52° ↙ ⚙9 N

Picture not available
 Image non disponible
 Imagen no disponible
 Immagine non disponibile
 Nicht verfügbares Bild
 Brak zdjęcia
 Картина недоступна

Picture not available
 Image non disponible
 Imagen no disponible
 Immagine non disponibile
 Nicht verfügbares Bild
 Brak zdjęcia
 Картина недоступна

ARMATURE ⚙02a 594112
DRIVE END HOUSING ⚙14 594627
PINION DRIVE ⚙03 594628
PIGNON DRIVE SHAFT ASSEMBLY ⚙02b 594307
REPAIR KIT ⚙24 594116
PINION FORK SET ⚙11 594629
SOLENOID SWITCH ⚙04 594309
Valeo 438160

D7R4 1,4 Kw 3(3) ↻

12 V ⚙10

Picture not available
 Image non disponible
 Imagen no disponible
 Immagine non disponibile
 Nicht verfügbares Bild
 Brak zdjęcia
 Картина недоступна

Picture not available
 Image non disponible
 Imagen no disponible
 Immagine non disponibile
 Nicht verfügbares Bild
 Brak zdjęcia
 Картина недоступна

ARMATURE ⚙02a 594112
INDUCTION COIL ⚙27 594115
PINION DRIVE ⚙03 594136
PIGNON DRIVE SHAFT ASSEMBLY ⚙02b 594141
REPAIR KIT ⚙24 594116
PINION FORK SET ⚙11 594262
Valeo 436019

D7R40 2 Kw 3(2) ↻

12 V 27° ↙ ⚙11 N



ARMATURE ⚙02a 594112
DRIVE END HOUSING ⚙14 594497
INDUCTION COIL ⚙27 594115
PINION DRIVE ⚙03 594185
PIGNON DRIVE SHAFT ASSEMBLY ⚙02b 594187
REPAIR KIT ⚙24 594327
PINION FORK SET ⚙11 594262
SOLENOID SWITCH ⚙04 594383
Valeo 436019

D7R41

2,5 Kw

3(0)



12 V

36°



N



ARMATURE 02a 594112
DRIVE END HOUSING 14 594701
PINION DRIVE 03 594628
PIGNON DRIVE SHAFT ASSEMBLY 02b 594307
REPAIR KIT 24 594116
PINION FORK SET 11 594262
SOLENOID SWITCH 04 594045
Valeo 436019

D7R42

1,6 Kw

3(3)



12 V

58°



N



ARMATURE 02a 594112
DRIVE END HOUSING 14 594485
INDUCTION COIL 27 594115
PINION DRIVE 03 594303
PIGNON DRIVE SHAFT ASSEMBLY 02b 594283
REPAIR KIT 24 594327
SOLENOID SWITCH 04 594045
Valeo 436019

D7R43

2,2 Kw

3(0)



12 V

30°



N



ARMATURE 02a 594112
DRIVE END HOUSING 14 594492
INDUCTION COIL 27 594354
PINION DRIVE 03 594185
PIGNON DRIVE SHAFT ASSEMBLY 02b 594187
REPAIR KIT 24 594282
PINION FORK SET 11 594281
SOLENOID SWITCH 04 594271
Valeo 436019

D7R44

1,9 Kw

4(3)



12 V

56°



N



ARMATURE 02a 594112
DRIVE END HOUSING 14 594498
INDUCTION COIL 27 594115
PINION DRIVE 03 594185
PIGNON DRIVE SHAFT ASSEMBLY 02b 594187
REPAIR KIT 24 594327
PINION FORK SET 11 594262
SOLENOID SWITCH 04 594411
SOLENOID SWITCH 04 594638
Valeo 436019

D7R46

2,2 Kw

3(0)



12 V

32°



N



ARMATURE 02a 594112
DRIVE END HOUSING 14 594492
INDUCTION COIL 27 594354
PINION DRIVE 03 594702
PIGNON DRIVE SHAFT ASSEMBLY 02b 594187
REPAIR KIT 24 594327
SOLENOID SWITCH 04 594271
Valeo 436019

D7R47

2,1 Kw

4(3)



12 V

56°



N

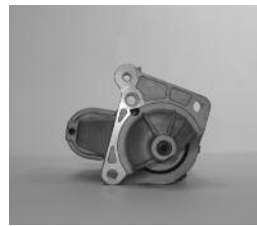

ARMATURE 02a 594112
DRIVE END HOUSING 14 594498
INDUCTION COIL 27 594326
PINION DRIVE 03 594185
PIGNON DRIVE SHAFT ASSEMBLY 02b 594187
REPAIR KIT 24 594327
PINION FORK SET 11 594262
SOLENOID SWITCH 04 594411
Valeo 436019



D7R48 2,1 Kw 4(3) ↻

12 V 56° 11 N



ARMATURE 02a 594112
DRIVE END HOUSING 14 594498
INDUCTION COIL 27 594432
PINION DRIVE 03 594185
PIGNON DRIVE SHAFT ASSEMBLY 02b 594187
REPAIR KIT 24 594327
PINION FORK SET 11 594262
SOLENOID SWITCH 04 594431
Valeo 436019

D7R49 2,1 Kw 4(3) ↻

12 V 56° 11 N



ARMATURE 02a 594112
DRIVE END HOUSING 14 594498
INDUCTION COIL 27 594439
INDUCTION COIL 27 594654
PINION DRIVE 03 594185
PIGNON DRIVE SHAFT ASSEMBLY 02b 594187
REPAIR KIT 24 594327
PINION FORK SET 11 594262
SOLENOID SWITCH 04 594411
Valeo 436019

D7R5 1,7 Kw 3(3) ↻

12 V 11

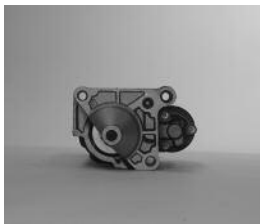

ARMATURE 02a 594112
DRIVE END HOUSING 14 594484
INDUCTION COIL 27 594115
PINION DRIVE 03 594185
PIGNON DRIVE SHAFT ASSEMBLY 02b 594141
PINION FORK SET 11 594262
SOLENOID SWITCH 04 594186
Valeo 436019

D7R53 2,2 Kw 4(3) ↻

12 V 32° 10 N



ARMATURE 02a 594112
DRIVE END HOUSING 14 594494
INDUCTION COIL 27 594439
PINION DRIVE 03 594410
PIGNON DRIVE SHAFT ASSEMBLY 02b 594187
REPAIR KIT 24 594327
PINION FORK SET 11 594262
SOLENOID SWITCH 04 594188
Valeo 436019

D7R53d 2,2 Kw 4(3) ↻

12 V 32° 10 N



ARMATURE 02a 594112
INDUCTION COIL 27 594439
PINION DRIVE 03 594410
REPAIR KIT 24 594327
SOLENOID SWITCH 04 *595664
Valeo 436019

D7R56 2,2 Kw 4(3) ↻

12 V 32° 10 N



ARMATURE 02a 594112
DRIVE END HOUSING 14 594494
INDUCTION COIL 27 594439
PINION DRIVE 03 594410
PIGNON DRIVE SHAFT ASSEMBLY 02b 594187
REPAIR KIT 24 594327
PINION FORK SET 11 594262
SOLENOID SWITCH 04 594188
Valeo 436019

D7R57 2,1 Kw 3(3) ↻

12 V 56° ↙ ⚙10 N



ARMATURE ⚙02a 594112
DRIVE END HOUSING ⚙14 594487
PINION DRIVE ⚙03 594410
PIGNON DRIVE SHAFT ASSEMBLY ⚙02b 594187
REPAIR KIT ⚙24 594327
PINION FORK SET ⚙11 594262
SOLENOID SWITCH ⚙04 594188
Valeo 436019

D7R61 2,5 Kw 3(1) ↻

12 V 35° ↘ ⚙9 N



ARMATURE ⚙02a 594112
DRIVE END HOUSING ⚙14 594655
PINION DRIVE ⚙03 594628
PIGNON DRIVE SHAFT ASSEMBLY ⚙02b 594307
REPAIR KIT ⚙24 594116
PINION FORK SET ⚙11 594262
SOLENOID SWITCH ⚙04 594045
Valeo 436019

D7R64 2,2 Kw 3(3) ↻

12 V 47,5° ↙ ⚙10 N



ARMATURE ⚙02a 594112
DRIVE END HOUSING ⚙14 594741
INDUCTION COIL ⚙27 594354
PINION DRIVE ⚙03 594136
PIGNON DRIVE SHAFT ASSEMBLY ⚙02b 594187
REPAIR KIT ⚙24 594210
PINION FORK SET ⚙11 594390
SOLENOID SWITCH ⚙04 594742
Valeo 436019

D7R65 2,2 Kw 3(0) ↻

12 V 32° ↘ ⚙11 N

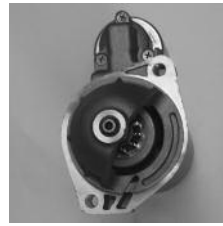

ARMATURE ⚙02a 594112
DRIVE END HOUSING ⚙14 594492
INDUCTION COIL ⚙27 594354
PINION DRIVE ⚙03 594185
PIGNON DRIVE SHAFT ASSEMBLY ⚙02b 594187
REPAIR KIT ⚙24 594282
PINION FORK SET ⚙11 594369
SOLENOID SWITCH ⚙04 594271
Valeo 436019

D7R7 1,6 Kw 3(3) ↻

12 V 58° ↙ ⚙10 N

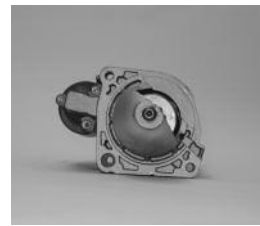

ARMATURE ⚙02a 594112
DRIVE END HOUSING ⚙14 594485
INDUCTION COIL ⚙27 594115
PINION DRIVE ⚙03 594185
PIGNON DRIVE SHAFT ASSEMBLY ⚙02b 594141
REPAIR KIT ⚙24 594116
PINION FORK SET ⚙11 594262
SOLENOID SWITCH ⚙04 594045
Valeo 436019

D7R70 2,2 Kw 3(0) ↻

12 V 35° ↘ ⚙13 N



ARMATURE ⚙02a 594112
INDUCTION COIL ⚙27 594354
PIGNON DRIVE SHAFT ASSEMBLY ⚙02b 594187
REPAIR KIT ⚙24 594282
PINION FORK SET ⚙11 594281
Valeo 436019



D7R8

1,4 Kw

3(3)



12 V



ARMATURE 02a 594112
INDUCTION COIL 27 594115
PINION DRIVE 03 594185
PIGNON DRIVE SHAFT ASSEMBLY 02b 594187
REPAIR KIT 24 594210
PINION FORK SET 11 594262
SOLENOID SWITCH 04 594188
Valeo 436019

D7R9

1,7 Kw

3(3)



12 V



ARMATURE 02a 594112
DRIVE END HOUSING 14 594486
INDUCTION COIL 27 594190
PINION DRIVE 03 594185
PIGNON DRIVE SHAFT ASSEMBLY 02b 594187
REPAIR KIT 24 594210
PINION FORK SET 11 594262
SOLENOID SWITCH 04 594188
Valeo 436019

D7RS129

2 Kw

3(0)



12 V

40°



0



ARMATURE 02a 594112
DRIVE END HOUSING 14 594500
INDUCTION COIL 27 594394
PINION DRIVE 03 594699
REPAIR KIT 24 594393
PINION FORK SET 11 594390
SOLENOID SWITCH 04 594391
Valeo 436019

D7RS130

2 Kw

2(0)



12 V

42°



0



ARMATURE 02a 594112
DRIVE END HOUSING 14 594501
INDUCTION COIL 27 594394
PINION DRIVE 03 594699
REPAIR KIT 24 594393
PINION FORK SET 11 594390
SOLENOID SWITCH 04 594391
Valeo 436019

D7RS131

2 Kw

3(0)



12 V

60-63°



0



ARMATURE 02a 594112
DRIVE END HOUSING 14 594502
INDUCTION COIL 27 594394
PINION DRIVE 03 594699
REPAIR KIT 24 594393
PINION FORK SET 11 594390
SOLENOID SWITCH 04 594392
Valeo 436019

D7RS150

2 Kw

2(0)



12 V

42°



N



ARMATURE 02a 594112
DRIVE END HOUSING 14 594503
INDUCTION COIL 27 594394
PINION DRIVE 03 594700
REPAIR KIT 24 594475
PINION FORK SET 11 594473
SOLENOID SWITCH 04 594474
Valeo 436019

D7RS29 2 Kw 3(0) ↻

12 V 40° ↙ ⚙️11 0



ARMATURE 🛠️02a 594112
DRIVE END HOUSING 🛠️14 594500
INDUCTION COIL 🛠️27 594394
PINION DRIVE 🛠️03 594699
REPAIR KIT 🛠️24 594393
PINION FORK SET 🛠️11 594390
SOLENOID SWITCH 🛠️04 594391
Valeo 436019

D7RS291 2 Kw 3(0) ↻

12 V 42° ↙ ⚙️11 N



ARMATURE 🛠️02a 594112
DRIVE END HOUSING 🛠️14 594500
INDUCTION COIL 🛠️27 594394
PINION DRIVE 🛠️03 594699
REPAIR KIT 🛠️24 594393
PINION FORK SET 🛠️11 594390
SOLENOID SWITCH 🛠️04 594391
Valeo 436019

D7RS30 2 Kw 2(0) ↻

12 V 42° ↙ ⚙️11 0



ARMATURE 🛠️02a 594112
DRIVE END HOUSING 🛠️14 594501
INDUCTION COIL 🛠️27 594394
PINION DRIVE 🛠️03 594699
REPAIR KIT 🛠️24 594393
PINION FORK SET 🛠️11 594390
SOLENOID SWITCH 🛠️04 594391
Valeo 436019

D7RS301 2 Kw 2(0) ↻

12 V 45° ↙ ⚙️11 N

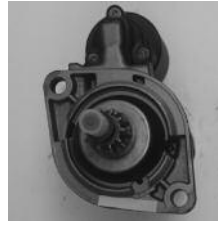

ARMATURE 🛠️02a 594112
DRIVE END HOUSING 🛠️14 594501
INDUCTION COIL 🛠️27 594394
PINION DRIVE 🛠️03 594699
REPAIR KIT 🛠️24 594393
PINION FORK SET 🛠️11 594390
SOLENOID SWITCH 🛠️04 594391
Valeo 436019

D7RS31 2 Kw 3(0) ↻

12 V 60-63° ↙ ⚙️11 0



ARMATURE 🛠️02a 594112
DRIVE END HOUSING 🛠️14 594502
INDUCTION COIL 🛠️27 594394
PINION DRIVE 🛠️03 594699
REPAIR KIT 🛠️24 594393
PINION FORK SET 🛠️11 594473
SOLENOID SWITCH 🛠️04 594392
Valeo 436019

D7RS50 2 Kw 2(0) ↻

12 V 42° ↙ ⚙️11 N



ARMATURE 🛠️02a 594112
DRIVE END HOUSING 🛠️14 594503
INDUCTION COIL 🛠️27 594394
PINION DRIVE 🛠️03 594700
REPAIR KIT 🛠️24 594475
PINION FORK SET 🛠️11 594473
SOLENOID SWITCH 🛠️04 594474
Valeo 436019

D7RSA8 1,4 Kw 2(0) ↻

12 V ⚙️9

Picture not available
Image non disponible
Imagen no disponible
Immagine non disponibile
Nicht verfügbares Bild
Brak zdjęcia
Картина недоступна

Picture not available
Image non disponible
Imagen no disponible
Immagine non disponibile
Nicht verfügbares Bild
Brak zdjęcia
Картина недоступна

SOLENOID SWITCH 🛠️04 594334
Valeo 436019



D7RSA9	1,6 Kw	2(0)	↻
12 V		9	
<p>Picture not available Image non disponible Imagen no disponible Immagine non disponibile Nicht verfügbares Bild Brak zdjęcia Картина недоступна</p>		<p>Picture not available Image non disponible Imagen no disponible Immagine non disponibile Nicht verfügbares Bild Brak zdjęcia Картина недоступна</p>	
SOLENOID SWITCH	04	594334	436019
Valeo			
D8E102	0,9 Kw	3(3)	↻
12 V		9	
<p>Picture not available Image non disponible Imagen no disponible Immagine non disponibile Nicht verfügbares Bild Brak zdjęcia Картина недоступна</p>		<p>Picture not available Image non disponible Imagen no disponible Immagine non disponibile Nicht verfügbares Bild Brak zdjęcia Картина недоступна</p>	
PINION STOP ASSEMBLY	16	073294	
D8E104	0,9 Kw	3(0)	↻
12 V		9	
			
PINION STOP ASSEMBLY	16	073294	
SOLENOID SWITCH	04	182442	436019
Valeo			
D8E106	0,9 Kw	3(0)	↻
12 V		9	
<p>Picture not available Image non disponible Imagen no disponible Immagine non disponibile Nicht verfügbares Bild Brak zdjęcia Картина недоступна</p>		<p>Picture not available Image non disponible Imagen no disponible Immagine non disponibile Nicht verfügbares Bild Brak zdjęcia Картина недоступна</p>	
PINION STOP ASSEMBLY	16	073294	
SOLENOID SWITCH	04	182442	436019
Valeo			
D8E107	0,75 Kw	3(3)	↻
12 V		9	
			
PINION STOP ASSEMBLY	16	073294	436019
Valeo			

D8E108	0,9 Kw	3(0)	↻
12 V		8	
<p>Picture not available Image non disponible Imagen no disponible Immagine non disponibile Nicht verfügbares Bild Brak zdjęcia Картина недоступна</p>		<p>Picture not available Image non disponible Imagen no disponible Immagine non disponibile Nicht verfügbares Bild Brak zdjęcia Картина недоступна</p>	
PINION STOP ASSEMBLY	16	073294	094787/433302
Valeo			
D8E109	0,9 Kw	3(0)	↻
12 V		9	
			
PINION STOP ASSEMBLY	16	073294	436019
Valeo			
D8E110	1,75 Kw	2(0)	↻
24 V		9	
<p>Picture not available Image non disponible Imagen no disponible Immagine non disponibile Nicht verfügbares Bild Brak zdjęcia Картина недоступна</p>		<p>Picture not available Image non disponible Imagen no disponible Immagine non disponibile Nicht verfügbares Bild Brak zdjęcia Картина недоступна</p>	
PINION DRIVE	03	077171	079593
Valeo			
D8E111	0,75 Kw	2(0)	↻
12 V		9	
			
SOLENOID SWITCH	04	182442	436019
Valeo			
D8E112	0,9 Kw	3(0)	↻
12 V		9	
<p>Picture not available Image non disponible Imagen no disponible Immagine non disponibile Nicht verfügbares Bild Brak zdjęcia Картина недоступна</p>		<p>Picture not available Image non disponible Imagen no disponible Immagine non disponibile Nicht verfügbares Bild Brak zdjęcia Картина недоступна</p>	
PINION STOP ASSEMBLY	16	073294	433235
Valeo			

D8E113 0,9 Kw 3(0) ↻

12 V ⚙️9

Picture not available
Image non disponible
Imagen no disponible
Immagine non disponibile
Nicht verfügbares Bild
Brak zdjęcia
Картина недоступна

Picture not available
Image non disponible
Imagen no disponible
Immagine non disponibile
Nicht verfügbares Bild
Brak zdjęcia
Картина недоступна

PINION STOP ASSEMBLY 📏16

073294

SOLENOID SWITCH 📏04

182442

Valeo

436019

D8E114 0,9 Kw 3(0) ↻

12 V ⚙️9



PINION STOP ASSEMBLY 📏16

073294

Valeo

436019

D8E115 0,9 Kw 3(0) ↻

12 V ⚙️9

Picture not available
Image non disponible
Imagen no disponible
Immagine non disponibile
Nicht verfügbares Bild
Brak zdjęcia
Картина недоступна

Picture not available
Image non disponible
Imagen no disponible
Immagine non disponibile
Nicht verfügbares Bild
Brak zdjęcia
Картина недоступна

PINION STOP ASSEMBLY 📏16

073294

Valeo

432556

D8E137 0,9 Kw 3(3) ↻

12 V ⚙️9



PINION STOP ASSEMBLY 📏16

073294

Valeo

436019

D8E139 0,9 Kw 3(0) ↻

12 V ⚙️9



PINION STOP ASSEMBLY 📏16

073294

Valeo

436019

D8E140 9 Kw 3(0) ↻

12 V ⚙️9

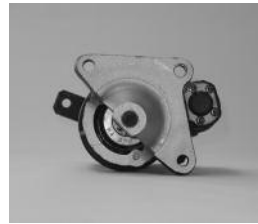

PINION STOP ASSEMBLY 📏16

073294

Valeo

436019

D8E141 1,7 Kw 2(0) ↻

24 V ⚙️9

Picture not available
Image non disponible
Imagen no disponible
Immagine non disponibile
Nicht verfügbares Bild
Brak zdjęcia
Картина недоступна

Picture not available
Image non disponible
Imagen no disponible
Immagine non disponibile
Nicht verfügbares Bild
Brak zdjęcia
Картина недоступна

PINION STOP ASSEMBLY 📏16

073294

Valeo

094443

D8E142 0,9 Kw 3(0) ↻

12 V ⚙️9 0



PINION STOP ASSEMBLY 📏16

073294

Valeo

436019

D8E147 0,9 Kw 3(0) ↻

12 V ⚙️9 0



PINION STOP ASSEMBLY 📏16

073294

Valeo

436019

D8E151 0,9 Kw 3(3) ↻

12 V ⚙️9 0



PINION STOP ASSEMBLY 📏16

073294

Valeo

436019



D8E154 0,75 Kw 2(0) ↻

12 V ⚙️10



PINION STOP ASSEMBLY 🛠️16 073294
Valeo 436019

D8E155 0,9 Kw 3(0) ↻

12 V ⚙️9

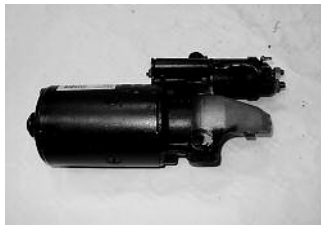

REPAIR KIT 🛠️24 182060
Valeo 436019

D8E157 0,9 Kw 3(0) ↻

12 V ⚙️9



PINION STOP ASSEMBLY 🛠️16 097804
REPAIR KIT 🛠️24 182060
Valeo 436019

D8E158 0,9 Kw 2(0) ↻

12 V ⚙️9



PINION STOP ASSEMBLY 🛠️16 097804
Valeo 436019

D8E21 0,9 Kw 2(0) ↻

12 V ⚙️9

Picture not available
Image non disponible
Imagen no disponible
Immagine non disponibile
Nicht verfügbares Bild
Brak zdjęcia
Картина недоступна

Picture not available
Image non disponible
Imagen no disponible
Immagine non disponibile
Nicht verfügbares Bild
Brak zdjęcia
Картина недоступна

SOLENOID SWITCH 🛠️04 182442

D8E22 0,9 Kw 2(0) ↻

12 V ⚙️9

Picture not available
Image non disponible
Imagen no disponible
Immagine non disponibile
Nicht verfügbares Bild
Brak zdjęcia
Картина недоступна

Picture not available
Image non disponible
Imagen no disponible
Immagine non disponibile
Nicht verfügbares Bild
Brak zdjęcia
Картина недоступна

SOLENOID SWITCH 🛠️04 182442

D8E26 0,75 Kw 2(0) ↻

12 V ⚙️9

Picture not available
Image non disponible
Imagen no disponible
Immagine non disponibile
Nicht verfügbares Bild
Brak zdjęcia
Картина недоступна

Picture not available
Image non disponible
Imagen no disponible
Immagine non disponibile
Nicht verfügbares Bild
Brak zdjęcia
Картина недоступна

SOLENOID SWITCH 🛠️04 182442

D8E27 0,9 Kw 2(0) ↻

12 V ⚙️9

Picture not available
Image non disponible
Imagen no disponible
Immagine non disponibile
Nicht verfügbares Bild
Brak zdjęcia
Картина недоступна

Picture not available
Image non disponible
Imagen no disponible
Immagine non disponibile
Nicht verfügbares Bild
Brak zdjęcia
Картина недоступна

SOLENOID SWITCH 🛠️04 182442

D8E29 0,75 Kw 2(0) ↻

12 V ⚙️9

Picture not available
Image non disponible
Imagen no disponible
Immagine non disponibile
Nicht verfügbares Bild
Brak zdjęcia
Картина недоступна

Picture not available
Image non disponible
Imagen no disponible
Immagine non disponibile
Nicht verfügbares Bild
Brak zdjęcia
Картина недоступна

SOLENOID SWITCH 🛠️04 182442

D8E30 0,9 Kw 2(0) ↻

12 V ⚙️9

Picture not available
Image non disponible
Imagen no disponible
Immagine non disponibile
Nicht verfügbares Bild
Brak zdjęcia
Картина недоступна

Picture not available
Image non disponible
Imagen no disponible
Immagine non disponibile
Nicht verfügbares Bild
Brak zdjęcia
Картина недоступна

SOLENOID SWITCH 🛠️04 182442

D8E54

0,9 Kw

2(0)



12 V

**SOLENOID SWITCH** 04

182442

Valeo

436019

D8E57

0,9 Kw

2(0)



12 V



Picture not available
Image non disponible
Imagen no disponible
Immagine non disponibile
Nicht verfügbares Bild
Brak zdjęcia
Картина недоступна

Picture not available
Image non disponible
Imagen no disponible
Immagine non disponibile
Nicht verfügbares Bild
Brak zdjęcia
Картина недоступна

SOLENOID SWITCH 04

182442

Valeo

433241

D8E58

0,9 Kw

2(0)



12 V



Picture not available
Image non disponible
Imagen no disponible
Immagine non disponibile
Nicht verfügbares Bild
Brak zdjęcia
Картина недоступна

Picture not available
Image non disponible
Imagen no disponible
Immagine non disponibile
Nicht verfügbares Bild
Brak zdjęcia
Картина недоступна

SOLENOID SWITCH 04

182442

Valeo

432569

D8E70

0,9 Kw

2(0)



12 V

**SOLENOID SWITCH** 04

182442

Valeo

436019

D8E71

0,9 Kw

3(0)



12 V

**PINION STOP ASSEMBLY** 16

073294

Valeo

436019

D8E74

0,75 Kw

2(0)



12 V

**SOLENOID SWITCH** 04

182442

Valeo

436019

D8E75

0,9 Kw

3(0)



12 V

**PINION STOP ASSEMBLY** 16

073294

Valeo

436019

D8E76

0,9 Kw

2(0)



12 V

**PINION STOP ASSEMBLY** 16

073294

SOLENOID SWITCH 04

182442

Valeo

436019

D8E77

0,9 Kw

3(0)



12 V



Picture not available
Image non disponible
Imagen no disponible
Immagine non disponibile
Nicht verfügbares Bild
Brak zdjęcia
Картина недоступна

Picture not available
Image non disponible
Imagen no disponible
Immagine non disponibile
Nicht verfügbares Bild
Brak zdjęcia
Картина недоступна

PINION STOP ASSEMBLY 16

073294

Valeo

433236

D8E78

0,9 Kw

3(0)



12 V



Picture not available
Image non disponible
Imagen no disponible
Immagine non disponibile
Nicht verfügbares Bild
Brak zdjęcia
Картина недоступна

Picture not available
Image non disponible
Imagen no disponible
Immagine non disponibile
Nicht verfügbares Bild
Brak zdjęcia
Картина недоступна

PINION STOP ASSEMBLY 16

073294

D8E81

0,9 Kw

3(0)



12 V

**PINION STOP ASSEMBLY** 16

073294

Valeo

436019

D8E82

0,9 Kw

3(0)



12 V



Picture not available
Image non disponible
Imagen no disponible
Immagine non disponibile
Nicht verfügbares Bild
Brak zdjęcia
Картина недоступна

Picture not available
Image non disponible
Imagen no disponible
Immagine non disponibile
Nicht verfügbares Bild
Brak zdjęcia
Картина недоступна

PINION STOP ASSEMBLY 16

073294

Valeo

433242

D8E83

0,9 Kw

3(0)



12 V



Picture not available
Image non disponible
Imagen no disponible
Immagine non disponibile
Nicht verfügbares Bild
Brak zdjęcia
Картина недоступна

Picture not available
Image non disponible
Imagen no disponible
Immagine non disponibile
Nicht verfügbares Bild
Brak zdjęcia
Картина недоступна

PINION STOP ASSEMBLY 16

073294

D8E84

0,9 Kw

2(0)



12 V



Picture not available
Image non disponible
Imagen no disponible
Immagine non disponibile
Nicht verfügbares Bild
Brak zdjęcia
Картина недоступна

Picture not available
Image non disponible
Imagen no disponible
Immagine non disponibile
Nicht verfügbares Bild
Brak zdjęcia
Картина недоступна

PINION STOP ASSEMBLY 16

073294

Valeo

075978

D8E86

0,9 Kw

2(0)



12 V

**SOLENOID SWITCH** 04

182442

Valeo

436019

D8E87

0,9 Kw

3(0)



12 V



Picture not available
Image non disponible
Imagen no disponible
Immagine non disponibile
Nicht verfügbares Bild
Brak zdjęcia
Картина недоступна

Picture not available
Image non disponible
Imagen no disponible
Immagine non disponibile
Nicht verfügbares Bild
Brak zdjęcia
Картина недоступна

PINION STOP ASSEMBLY 16

073294

Valeo

433236

D8E88

0,9 Kw

3(0)



12 V



Picture not available
Image non disponible
Imagen no disponible
Immagine non disponibile
Nicht verfügbares Bild
Brak zdjęcia
Картина недоступна

Picture not available
Image non disponible
Imagen no disponible
Immagine non disponibile
Nicht verfügbares Bild
Brak zdjęcia
Картина недоступна

PINION STOP ASSEMBLY 16

073294

Valeo

433235

D8E90

0,9 Kw

3(0)



12 V



Picture not available
Image non disponible
Imagen no disponible
Immagine non disponibile
Nicht verfügbares Bild
Brak zdjęcia
Картина недоступна

Picture not available
Image non disponible
Imagen no disponible
Immagine non disponibile
Nicht verfügbares Bild
Brak zdjęcia
Картина недоступна

SOLENOID SWITCH 04

182442

D8E94

0,9 Kw

3(3)



12 V



Picture not available
Image non disponible
Imagen no disponible
Immagine non disponibile
Nicht verfügbares Bild
Brak zdjęcia
Картина недоступна

Picture not available
Image non disponible
Imagen no disponible
Immagine non disponibile
Nicht verfügbares Bild
Brak zdjęcia
Картина недоступна

PINION STOP ASSEMBLY 16

073294

SOLENOID SWITCH 04

182442

Valeo

436019

D8E95

0,9 Kw

3(0)



12 V



Picture not available
Image non disponible
Imagen no disponible
Immagine non disponibile
Nicht verfügbares Bild
Brak zdjęcia
Картина недоступна

Picture not available
Image non disponible
Imagen no disponible
Immagine non disponibile
Nicht verfügbares Bild
Brak zdjęcia
Картина недоступна

PINION STOP ASSEMBLY 16

073294

D8E96

0,9 Kw

2(0)



12 V

**PINION STOP ASSEMBLY** 16

073294

SOLENOID SWITCH 04

182442

Valeo**436019****D8E97**

0,9 Kw

3(3)



12 V



Picture not available
Image non disponible
Imagen no disponible
Immagine non disponibile
Nicht verfügbares Bild
Brak zdjęć
Картина недоступна

Picture not available
Image non disponible
Imagen no disponible
Imagen no disponible
Immagine non disponibile
Nicht verfügbares Bild
Brak zdjęć
Картина недоступна

PINION STOP ASSEMBLY 16

073294

SOLENOID SWITCH 04

182442

Valeo**436019****D8E98**

0,9 Kw

2(0)



12 V



Picture not available
Image non disponible
Imagen no disponible
Immagine non disponibile
Nicht verfügbares Bild
Brak zdjęć
Картина недоступна

Picture not available
Image non disponible
Imagen no disponible
Imagen no disponible
Immagine non disponibile
Nicht verfügbares Bild
Brak zdjęć
Картина недоступна

PINION STOP ASSEMBLY 16

073294

SOLENOID SWITCH 04

182442

Valeo**433241****D8E99**

0,75 Kw

2(0)



12 V



Picture not available
Image non disponible
Imagen no disponible
Immagine non disponibile
Nicht verfügbares Bild
Brak zdjęć
Картина недоступна

PINION DRIVE 03

077171

PINION STOP ASSEMBLY 16

073294

SOLENOID SWITCH 04

182442

Valeo**436019****D8L67**

0,75 Kw

2(0)



12 V



Picture not available
Image non disponible
Imagen no disponible
Immagine non disponibile
Nicht verfügbares Bild
Brak zdjęć
Картина недоступна

Picture not available
Image non disponible
Imagen no disponible
Imagen no disponible
Immagine non disponibile
Nicht verfügbares Bild
Brak zdjęć
Картина недоступна

PINION STOP ASSEMBLY 16

073294

D8L79

0,45 Kw

2(0)



6 V



Picture not available
Image non disponible
Imagen no disponible
Immagine non disponibile
Nicht verfügbares Bild
Brak zdjęć
Картина недоступна

Picture not available
Image non disponible
Imagen no disponible
Imagen no disponible
Immagine non disponibile
Nicht verfügbares Bild
Brak zdjęć
Картина недоступна

PINION STOP ASSEMBLY 16

073294

D8L80

0,75 Kw

2(0)



12 V



Picture not available
Image non disponible
Imagen no disponible
Immagine non disponibile
Nicht verfügbares Bild
Brak zdjęć
Картина недоступна

Picture not available
Image non disponible
Imagen no disponible
Imagen no disponible
Immagine non disponibile
Nicht verfügbares Bild
Brak zdjęć
Картина недоступна

PINION STOP ASSEMBLY 16

073294

D8L92

0,75 Kw

2(0)



12 V



Picture not available
Image non disponible
Imagen no disponible
Immagine non disponibile
Nicht verfügbares Bild
Brak zdjęć
Картина недоступна

Picture not available
Image non disponible
Imagen no disponible
Imagen no disponible
Immagine non disponibile
Nicht verfügbares Bild
Brak zdjęć
Картина недоступна

PINION STOP ASSEMBLY 16

073294

D8L93

0,75 Kw

2(0)



12 V



Picture not available
Image non disponible
Imagen no disponible
Immagine non disponibile
Nicht verfügbares Bild
Brak zdjęć
Картина недоступна

Picture not available
Image non disponible
Imagen no disponible
Imagen no disponible
Immagine non disponibile
Nicht verfügbares Bild
Brak zdjęć
Картина недоступна

PINION STOP ASSEMBLY 16

073294

D8R1

2,4 Kw

4(3)



12 V

32°



N

**ARMATURE** 02a

594112

DRIVE END HOUSING 14

594494

INDUCTION COIL 27

594641

PINION DRIVE 03

594410

PIGNON DRIVE SHAFT ASSEMBLY 02b

594187

REPAIR KIT 24

594327

PINION FORK SET 11

594262

SOLENOID SWITCH 04

594188

Valeo**436019**

D8R27	1,9 Kw	3(3)	↻
12 V	56°	11	N



ARMATURE 🛠️02a	594112
DRIVE END HOUSING 🛠️14	594487
INDUCTION COIL 🛠️27	594641
PINION DRIVE 🛠️03	594185
PIGNON DRIVE SHAFT ASSEMBLY 🛠️02b	594187
REPAIR KIT 🛠️24	594210
PINION FORK SET 🛠️11	594262
SOLENOID SWITCH 🛠️04	594613
Valeo	436019

D8R28	2,5 Kw	5(5)	↻
12 V	56°	11	N

Picture not available
Image non disponible
Imagen no disponible
Immagine non disponibile
Nicht verfügbares Bild
Brak zdjęcia
Картина недоступна

Picture not available
Image non disponible
Imagen no disponible
Immagine non disponibile
Nicht verfügbares Bild
Brak zdjęcia
Картина недоступна

ARMATURE 🛠️02a	594112
DRIVE END HOUSING 🛠️14	594745
INDUCTION COIL 🛠️27	594641
PINION DRIVE 🛠️03	594185
PIGNON DRIVE SHAFT ASSEMBLY 🛠️02b	594187
REPAIR KIT 🛠️24	594327
PINION FORK SET 🛠️11	594262
SOLENOID SWITCH 🛠️04	594613
Valeo	436019

D8R29	1,9 Kw	3(3)	↻
12 V	56°	11	N

Picture not available
Image non disponible
Imagen no disponible
Immagine non disponibile
Nicht verfügbares Bild
Brak zdjęcia
Картина недоступна

Picture not available
Image non disponible
Imagen no disponible
Immagine non disponibile
Nicht verfügbares Bild
Brak zdjęcia
Картина недоступна

ARMATURE 🛠️02a	594112
DRIVE END HOUSING 🛠️14	594733
INDUCTION COIL 🛠️27	594641
PINION DRIVE 🛠️03	594185
PIGNON DRIVE SHAFT ASSEMBLY 🛠️02b	594187
REPAIR KIT 🛠️24	594327
PINION FORK SET 🛠️11	594262
SOLENOID SWITCH 🛠️04	594613
Valeo	436019

D8R39	2,7 Kw	3(0)	↻
12 V	52°	9	N

Picture not available
Image non disponible
Imagen no disponible
Immagine non disponibile
Nicht verfügbares Bild
Brak zdjęcia
Картина недоступна

Picture not available
Image non disponible
Imagen no disponible
Immagine non disponibile
Nicht verfügbares Bild
Brak zdjęcia
Картина недоступна

ARMATURE 🛠️02a	594112
DRIVE END HOUSING 🛠️14	594627
INDUCTION COIL 🛠️27	594641
PINION DRIVE 🛠️03	594628
PIGNON DRIVE SHAFT ASSEMBLY 🛠️02b	594307
REPAIR KIT 🛠️24	594116
PINION FORK SET 🛠️11	594629
SOLENOID SWITCH 🛠️04	594768
Valeo	436019

D8R49	2,4 Kw	4(3)	↻
12 V	56°	11	N

Picture not available
Image non disponible
Imagen no disponible
Immagine non disponibile
Nicht verfügbares Bild
Brak zdjęcia
Картина недоступна

Picture not available
Image non disponible
Imagen no disponible
Immagine non disponibile
Nicht verfügbares Bild
Brak zdjęcia
Картина недоступна

ARMATURE 🛠️02a	594112
DRIVE END HOUSING 🛠️14	594498
PINION DRIVE 🛠️03	594185
PIGNON DRIVE SHAFT ASSEMBLY 🛠️02b	594187
REPAIR KIT 🛠️24	594327
PINION FORK SET 🛠️11	594262
SOLENOID SWITCH 🛠️04	594411
Valeo	436019

D9E102	1,2 Kw	2(0)	↻
12 V	↗	9	N

Picture not available
Image non disponible
Imagen no disponible
Immagine non disponibile
Nicht verfügbares Bild
Brak zdjęcia
Картина недоступна

Picture not available
Image non disponible
Imagen no disponible
Immagine non disponibile
Nicht verfügbares Bild
Brak zdjęcia
Картина недоступна

BRUSHES AND SPRINGS SET 🛠️09	594065
Valeo	432579

D9E103	1,05 Kw	2(0)	↻
24 V	↗	9	

Picture not available
Image non disponible
Imagen no disponible
Immagine non disponibile
Nicht verfügbares Bild
Brak zdjęcia
Картина недоступна

Picture not available
Image non disponible
Imagen no disponible
Immagine non disponibile
Nicht verfügbares Bild
Brak zdjęcia
Картина недоступна

BUSHING KIT 🛠️10	182063
PINION STOP ASSEMBLY 🛠️16	097804
REPAIR KIT 🛠️24	182060
PINION FORK SET 🛠️11	182058
Valeo	183054

D9E104

1,2 Kw

3(3)



12 V

**BRUSHES AND SPRINGS SET** 09

594065

Valeo

436019

D9E111

1,2 Kw

2(0)



12 V



Picture not available
Image non disponible
Imagen no disponible
Immagine non disponibile
Nicht verfügbares Bild
Brak zdjęcia
Картина недоступна

Picture not available
Image non disponible
Imagen no disponible
Immagine non disponibile
Nicht verfügbares Bild
Brak zdjęcia
Картина недоступна

BRUSHES AND SPRINGS SET 09

594065

Valeo

436019

D9E130

1,4 Kw

2(0)



24 V



Picture not available
Image non disponible
Imagen no disponible
Immagine non disponibile
Nicht verfügbares Bild
Brak zdjęcia
Картина недоступна

Picture not available
Image non disponible
Imagen no disponible
Immagine non disponibile
Nicht verfügbares Bild
Brak zdjęcia
Картина недоступна

BUSHING KIT 10

182063

PINION STOP ASSEMBLY 16

097804

REPAIR KIT 24

182060

PINION FORK SET 11

182058

Valeo

594209

D9E131

1,2 Kw

3(0)



12 V

**PINION DRIVE** 03

101292

SOLENOID SWITCH 04

594142

Valeo

436019

D9E132

1,05 Kw

3(0)



12 V

**PINION DRIVE** 03

101292

SOLENOID SWITCH 04

594142

Valeo

436019

D9E136

1,05 Kw

3(3)



12 V

**BRUSHES AND SPRINGS SET** 09

594066

BUSHING KIT 10

182063

FIELD SERIES COIL SET 06

101582

PINION DRIVE 03

099931

PINION STOP ASSEMBLY 16

097804

REPAIR KIT 24

182060

PINION FORK SET 11

182058

D9E136

1,05 Kw

3(3)



12 V

**BRUSHES AND SPRINGS SET** 09

594066

BUSHING KIT 10

182063

FIELD SERIES COIL SET 06

101582

PINION DRIVE 03

099931

PINION STOP ASSEMBLY 16

097804

REPAIR KIT 24

182060

PINION FORK SET 11

182058

Valeo

436019

D9E137

1,05 Kw

4(4)



12 V

**ARMATURE** 02a

102380

BRUSHES AND SPRINGS SET 09

594066

BUSHING KIT 10

182063

PINION DRIVE 03

099931

PINION STOP ASSEMBLY 16

097804

REPAIR KIT 24

182060

PINION FORK SET 11

182058

SOLENOID SWITCH 04

182459

Valeo

436019

D9E138 1,2 Kw 4(4) ↻

12 V 9



ARMATURE 02a 102380
BRUSHES AND SPRINGS SET 09 182065
BUSHING KIT 10 182063
PINION DRIVE 03 099931
PINION STOP ASSEMBLY 16 097804
REPAIR KIT 24 182060
PINION FORK SET 11 182058
SOLENOID SWITCH 04 182459
Valeo 436019

D9E140 1,2 Kw 3(0) ↻

12 V 9



BRUSHES AND SPRINGS SET 09 182065
BUSHING KIT 10 182063
PINION STOP ASSEMBLY 16 097804
REPAIR KIT 24 182060
PINION FORK SET 11 182058

D9E140 1,2 Kw 3(0) ↻

12 V 9



BRUSHES AND SPRINGS SET 09 182065
BUSHING KIT 10 182063
PINION STOP ASSEMBLY 16 097804
REPAIR KIT 24 182060
PINION FORK SET 11 182058

D9E140 1,2 Kw 3(0) ↻

12 V 9



BRUSHES AND SPRINGS SET 09 182065
BUSHING KIT 10 182063
PINION STOP ASSEMBLY 16 097804
REPAIR KIT 24 182060
PINION FORK SET 11 182058
Valeo 432605/436022

D9E20 1,15 Kw 3(1) ↻

12 V 9



PINION STOP ASSEMBLY 16 073294
Valeo 097820/433247

D9E238 1,2 Kw 4(4) ↻

12 V 9



ARMATURE 02a 102380
BRUSHES AND SPRINGS SET 09 182065
BUSHING KIT 10 182063
PINION DRIVE 03 099931
PINION STOP ASSEMBLY 16 097804
REPAIR KIT 24 182060
PINION FORK SET 11 182058
Valeo 432621/436058

D9E31 1,05 Kw 3(0) ↻

12 V 9



SOLENOID SWITCH 04 594142
Valeo 432556/433237

D9E32 1,2 Kw 3(0) ↻

12 V 9



SOLENOID SWITCH 04 594142
Valeo 432556/433237



D9E38

1,05 Kw

3(0)



12 V

**BRUSHES AND SPRINGS SET** 09

182066

Valeo

432544/433231

D9E39

1,05 Kw

4(4)



12 V

**ARMATURE** 02a

102380

BRUSHES AND SPRINGS SET 09

594066

BUSHING KIT 10

182063

FIELD SERIES COIL SET 06

101582

PINION DRIVE 03

099931

PINION STOP ASSEMBLY 16

097804

REPAIR KIT 24

182060

PINION FORK SET 11

182058

SOLENOID SWITCH 04

182459

SPARE PART KIT 25

182317

Valeo

432566/433249

D9E43

1,05 Kw

3(0)



12 V

**PINION DRIVE** 03

101292

SOLENOID SWITCH 04

594142

Valeo

432545/433304

D9E44

1,2 Kw

3(0)



12 V

**PINION DRIVE** 03

101292

SOLENOID SWITCH 04

594142

Valeo

432545/433304

D9E54

1,2 Kw

3(0)



12 V

**SOLENOID SWITCH** 04

182464

Valeo

432512/433223

D9E55

1,2 Kw

3(2)



12 V

**ARMATURE** 02a

102380

BRUSHES AND SPRINGS SET 09

182065

BUSHING KIT 10

182063

PINION DRIVE 03

099931

PINION STOP ASSEMBLY 16

097804

REPAIR KIT 24

182060

PINION FORK SET 11

182058

Valeo

432547/433247

D9E57

1,05 Kw

3(3)



12 V

**BRUSHES AND SPRINGS SET** 09

594066

BUSHING KIT 10

182063

PINION DRIVE 03

102846

PINION STOP ASSEMBLY 16

097804

REPAIR KIT 24

182060

PINION FORK SET 11

182058

SOLENOID SWITCH 04

182461

Valeo

432511/433226

D9E61

1,05 Kw

3(0)



12 V



ARMATURE 02a 102380
BRUSHES AND SPRINGS SET 09 594066
BUSHING KIT 10 182063
FIELD SERIES COIL SET 06 101582
PINION DRIVE 03 099931
PINION STOP ASSEMBLY 16 097804
REPAIR KIT 24 182060
PINION FORK SET 11 182058
SOLENOID SWITCH 04 182461

D9E61

1,05 Kw

3(0)



12 V



ARMATURE 02a 102380
BRUSHES AND SPRINGS SET 09 594066
BUSHING KIT 10 182063
FIELD SERIES COIL SET 06 101582
PINION DRIVE 03 099931
PINION STOP ASSEMBLY 16 097804
REPAIR KIT 24 182060
PINION FORK SET 11 182058
SOLENOID SWITCH 04 182461

Valeo**432512/455721****D9E62**

1,2 Kw

3(0)



12 V



N



ARMATURE 02a 102380
BRUSHES AND SPRINGS SET 09 182065
BUSHING KIT 10 182063
PINION DRIVE 03 099931
PINION STOP ASSEMBLY 16 097804
REPAIR KIT 24 182060
PINION FORK SET 11 182058
SOLENOID SWITCH 04 182461

Valeo**432512/433223****D9E64**

1,05 Kw

3(3)



12 V



N



ARMATURE 02a 101923
BRUSHES AND SPRINGS SET 09 594066
BUSHING KIT 10 182063
FIELD SERIES COIL SET 06 101582
PINION DRIVE 03 106009
PINION STOP ASSEMBLY 16 097804
REPAIR KIT 24 182060
PINION FORK SET 11 182058
SOLENOID SWITCH 04 182461

D9E64

1,05 Kw

3(3)



12 V



N



ARMATURE 02a 101923
BRUSHES AND SPRINGS SET 09 594066
BUSHING KIT 10 182063
FIELD SERIES COIL SET 06 101582
PINION DRIVE 03 106009
PINION STOP ASSEMBLY 16 097804
REPAIR KIT 24 182060
PINION FORK SET 11 182058
SOLENOID SWITCH 04 182461

D9E64

1,05 Kw

3(3)



12 V



N



ARMATURE 02a 101923
BRUSHES AND SPRINGS SET 09 594066
BUSHING KIT 10 182063
FIELD SERIES COIL SET 06 101582
PINION DRIVE 03 106009
PINION STOP ASSEMBLY 16 097804
REPAIR KIT 24 182060
PINION FORK SET 11 182058
SOLENOID SWITCH 04 182461



D9E64

1,05 Kw

3(3)



12 V



N



ARMATURE 02a 101923
BRUSHES AND SPRINGS SET 09 594066
BUSHING KIT 10 182063
FIELD SERIES COIL SET 06 101582
PINION DRIVE 03 106009
PINION STOP ASSEMBLY 16 097804
REPAIR KIT 24 182060
PINION FORK SET 11 182058
SOLENOID SWITCH 04 182461

Valeo**432551/433204****D9E70**

1,05 Kw

3(3)



12 V



ARMATURE 02a 102380
BRUSHES AND SPRINGS SET 09 594066
BUSHING KIT 10 182063
FIELD SERIES COIL SET 06 101582
PINION DRIVE 03 099931
PINION STOP ASSEMBLY 16 097804
REPAIR KIT 24 182060
PINION FORK SET 11 182058
SOLENOID SWITCH 04 182461

Valeo**432555/433209****D9E701**

1,05 Kw

3(3)



12 V



N



ARMATURE 02a 102380
BRUSHES AND SPRINGS SET 09 594066
BUSHING KIT 10 182063
FIELD SERIES COIL SET 06 101582
PINION DRIVE 03 099931
PINION STOP ASSEMBLY 16 097804
REPAIR KIT 24 182060
PINION FORK SET 11 182058
SOLENOID SWITCH 04 182461

Valeo**432555/433209****D9E76**

1,05 Kw

4(4)



12 V



ARMATURE 02a 102380
BRUSHES AND SPRINGS SET 09 594066
BUSHING KIT 10 182063
FIELD SERIES COIL SET 06 101582
PINION DRIVE 03 099931
PINION STOP ASSEMBLY 16 097804
REPAIR KIT 24 182060
PINION FORK SET 11 182058
SOLENOID SWITCH 04 182459
SPARE PART KIT 25 182317

Valeo**432566/433249****D9E771**

1,2 Kw

4(4)



12 V



N



ARMATURE 02a 102380
BRUSHES AND SPRINGS SET 09 182065
BUSHING KIT 10 182063
PINION DRIVE 03 099931
PINION STOP ASSEMBLY 16 097804
REPAIR KIT 24 182060
PINION FORK SET 11 182058
SOLENOID SWITCH 04 182459

Valeo**432581/433309****D9E772**

0

0

0

0

Picture not available
 Image non disponible
 Imagen no disponible
 Immagine non disponibile
 Nicht verfügbares Bild
 Brak zdjęcia
 Картина недоступна

Picture not available
 Image non disponible
 Imagen no disponible
 Immagine non disponibile
 Nicht verfügbares Bild
 Brak zdjęcia
 Картина недоступна

BRUSHES AND SPRINGS SET 09 594065
Valeo **432510/436084**

D9E774

0

0

0

0

Picture not available
 Image non disponible
 Imagen no disponible
 Immagine non disponibile
 Nicht verfügbares Bild
 Brak zdjęcia
 Картина недоступна

Picture not available
 Image non disponible
 Imagen no disponible
 Immagine non disponibile
 Nicht verfügbares Bild
 Brak zdjęcia
 Картина недоступна

BRUSHES AND SPRINGS SET 09 594065
Valeo **432510/436084**

D9E776 1,2 Kw 3(3) ↻

12 V 9



BRUSHES AND SPRINGS SET 09 594065
Valeo 432581/433309

D9E78 1,05 Kw 3(2) ↻

12 V 9



ARMATURE 02a 102380
BRUSHES AND SPRINGS SET 09 594066
BUSHING KIT 10 182063
FIELD SERIES COIL SET 06 101582
PINION DRIVE 03 099931
PINION STOP ASSEMBLY 16 097804
REPAIR KIT 24 182060
PINION FORK SET 11 182058
SOLENOID SWITCH 04 182463

D9E78 1,05 Kw 3(2) ↻

12 V 9



ARMATURE 02a 102380
BRUSHES AND SPRINGS SET 09 594066
BUSHING KIT 10 182063
FIELD SERIES COIL SET 06 101582
PINION DRIVE 03 099931
PINION STOP ASSEMBLY 16 097804
REPAIR KIT 24 182060
PINION FORK SET 11 182058
SOLENOID SWITCH 04 182463

D9E78 1,05 Kw 3(2) ↻

12 V 9



ARMATURE 02a 102380
BRUSHES AND SPRINGS SET 09 594066
BUSHING KIT 10 182063
FIELD SERIES COIL SET 06 101582
PINION DRIVE 03 099931
PINION STOP ASSEMBLY 16 097804
REPAIR KIT 24 182060
PINION FORK SET 11 182058
SOLENOID SWITCH 04 182463
Valeo 432565/433246

D9E82 1,05 Kw 3(0) ↻

12 V 9



SOLENOID SWITCH 04 594142
Valeo 432556/433237

D9E83 1,05 Kw 3(0) ↻

12 V 9



PINION DRIVE 03 101292
SOLENOID SWITCH 04 594142
Valeo 432545/433304

D9E85 1,2 Kw 3(3) ↻

12 V 9



ARMATURE 02a 102380
BRUSHES AND SPRINGS SET 09 182065
BUSHING KIT 10 182063
PINION DRIVE 03 099931
PINION STOP ASSEMBLY 16 097804
REPAIR KIT 24 182060
PINION FORK SET 11 182058
SOLENOID SWITCH 04 182461
Valeo 432554/433307



D9E851 1,2 Kw 3(3) ↻

12 V 9



- ARMATURE ↻02a 102380
- BRUSHES AND SPRINGS SET ↻09 182065
- BUSHING KIT ↻10 182063
- PINION DRIVE ↻03 099931
- PINION STOP ASSEMBLY ↻16 097804
- REPAIR KIT ↻24 182060
- PINION FORK SET ↻11 182058
- SOLENOID SWITCH ↻04 182461

Valeo 432554/433307

D9E852 1,2 Kw 3(3) ↻

12 V 9



- ARMATURE ↻02a 102380
- BRUSHES AND SPRINGS SET ↻09 182065
- BUSHING KIT ↻10 182063
- PINION DRIVE ↻03 099931
- PINION STOP ASSEMBLY ↻16 097804
- REPAIR KIT ↻24 182060
- PINION FORK SET ↻11 182058
- SOLENOID SWITCH ↻04 182461

Valeo 432554/433307

D9E86 1,05 Kw 3(0) ↻

12 V 9



- ARMATURE ↻02a 102380
- BRUSHES AND SPRINGS SET ↻09 594066
- BUSHING KIT ↻10 182063
- FIELD SERIES COIL SET ↻06 101582
- PINION DRIVE ↻03 099931
- PINION STOP ASSEMBLY ↻16 097804
- REPAIR KIT ↻24 182060
- PINION FORK SET ↻11 182058
- SOLENOID SWITCH ↻04 182461

D9E86 1,05 Kw 3(0) ↻

12 V 9



- ARMATURE ↻02a 102380
- BRUSHES AND SPRINGS SET ↻09 594066
- BUSHING KIT ↻10 182063
- FIELD SERIES COIL SET ↻06 101582
- PINION DRIVE ↻03 099931
- PINION STOP ASSEMBLY ↻16 097804
- REPAIR KIT ↻24 182060
- PINION FORK SET ↻11 182058
- SOLENOID SWITCH ↻04 182461

Valeo 432555/433209

D9E861 1,05 Kw 3(0) ↻

12 V 9



- ARMATURE ↻02a 102380
- BRUSHES AND SPRINGS SET ↻09 594066
- BUSHING KIT ↻10 182063
- FIELD SERIES COIL SET ↻06 101582
- PINION DRIVE ↻03 099931
- PINION STOP ASSEMBLY ↻16 097804
- REPAIR KIT ↻24 182060
- PINION FORK SET ↻11 182058
- SOLENOID SWITCH ↻04 182461

D9E861 1,05 Kw 3(0) ↻

12 V 9



- ARMATURE ↻02a 102380
- BRUSHES AND SPRINGS SET ↻09 594066
- BUSHING KIT ↻10 182063
- FIELD SERIES COIL SET ↻06 101582
- PINION DRIVE ↻03 099931
- PINION STOP ASSEMBLY ↻16 097804
- REPAIR KIT ↻24 182060
- PINION FORK SET ↻11 182058
- SOLENOID SWITCH ↻04 182461

D9E861

1,05 Kw

3(0)



12 V



ARMATURE 02a 102380
BRUSHES AND SPRINGS SET 09 594066
BUSHING KIT 10 182063
FIELD SERIES COIL SET 06 101582
PINION DRIVE 03 099931
PINION STOP ASSEMBLY 16 097804
REPAIR KIT 24 182060
PINION FORK SET 11 182058
SOLENOID SWITCH 04 182461

Valeo

432555/433307

D9R105

3,1 Kw

3(0)



12 V



REDUCTION GEAR ASSEMBLY 02 182175
INDUCTION COIL 27 182051
PINION DRIVE 03 594040
REPAIR KIT 24 182050
PINION FORK SET 11 182048
SOLENOID SWITCH 04 105489

D9R105

3,1 Kw

3(0)



12 V



REDUCTION GEAR ASSEMBLY 02 182175
INDUCTION COIL 27 182051
PINION DRIVE 03 594040
REPAIR KIT 24 182050
PINION FORK SET 11 182048
SOLENOID SWITCH 04 105489

Valeo

432529/433329

D9R1050

3,1 Kw

3(0)



12 V



REDUCTION GEAR ASSEMBLY 02 182175
INDUCTION COIL 27 182051
PINION DRIVE 03 594040
REPAIR KIT 24 182050
PINION FORK SET 11 182048
SOLENOID SWITCH 04 105489

Valeo

432608/433329

D9R106

3,1 Kw

3(0)



12 V



REDUCTION GEAR ASSEMBLY 02 182175
INDUCTION COIL 27 182051
REPAIR KIT 24 182050
PINION FORK SET 11 182048
SOLENOID SWITCH 04 105489

Valeo

432530/433219

D9R112

3,1 Kw

3(3)



12 V

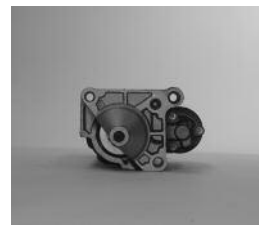

PINION DRIVE 03 182176
REPAIR KIT 24 182050
PINION FORK SET 11 594069
SOLENOID SWITCH 04 594053

Valeo

432629/433332

D9R116

3,1 Kw

3(0)



12 V



Picture not available
 Image non disponible
 Imagen no disponible
 Immagine non disponibile
 Nicht verfügbares Bild
 Brak zdjęcia
 Картина недоступна

Picture not available
 Image non disponible
 Imagen no disponible
 Immagine non disponibile
 Nicht verfügbares Bild
 Brak zdjęcia
 Картина недоступна

REDUCTION GEAR ASSEMBLY 02 182175
INDUCTION COIL 27 594059
PINION DRIVE 03 594043
REPAIR KIT 24 182050
PINION FORK SET 11 182048
SOLENOID SWITCH 04 594054

Valeo

184202/455537



D9R118

3,1 Kw

4(1)



12 V



REDUCTION GEAR ASSEMBLY 02 182175
INDUCTION COIL 27 182051
PINION DRIVE 03 182176
REPAIR KIT 24 182050
PINION FORK SET 11 182048
SOLENOID SWITCH 04 105489

D9R118

3,1 Kw

4(1)



12 V



REDUCTION GEAR ASSEMBLY 02 182175
INDUCTION COIL 27 182051
PINION DRIVE 03 182176
REPAIR KIT 24 182050
PINION FORK SET 11 182048
SOLENOID SWITCH 04 105489

Valeo**432537/436087****D9R119**

2,2 Kw

3(0)



12 V



REDUCTION GEAR ASSEMBLY 02 182175
INDUCTION COIL 27 594157
PINION DRIVE 03 594152
REPAIR KIT 24 182050
PINION FORK SET 11 182048

Valeo**432627/436002****D9R121**

2 Kw

3(3)



12 V



N

Picture not available
Image non disponible
Imagen no disponible
Immagine non disponibile
Nicht verfügbares Bild
Brak zdjęcia
Картина недоступна

Picture not available
Image non disponible
Imagen no disponible
Immagine non disponibile
Nicht verfügbares Bild
Brak zdjęcia
Картина недоступна

PINION DRIVE 03 182052
REPAIR KIT 24 182050
PINION FORK SET 11 182048
SOLENOID SWITCH 04 594098

Valeo**432595/433324****D9R122**

2,1 Kw

3(3)



12 V



N



REDUCTION GEAR ASSEMBLY 02 182175
INDUCTION COIL 27 182051
PINION DRIVE 03 182176
REPAIR KIT 24 182050
PINION FORK SET 11 182048
SOLENOID SWITCH 04 594098

Valeo**436068****D9R126**

3,1 Kw

2(0)



12 V



Picture not available
Image non disponible
Imagen no disponible
Immagine non disponibile
Nicht verfügbares Bild
Brak zdjęcia
Картина недоступна

Picture not available
Image non disponible
Imagen no disponible
Immagine non disponibile
Nicht verfügbares Bild
Brak zdjęcia
Картина недоступна

REDUCTION GEAR ASSEMBLY 02 182175
INDUCTION COIL 27 182051
REPAIR KIT 24 182050
PINION FORK SET 11 182048
SOLENOID SWITCH 04 181069

D9R134

2,2 Kw

3(1)



12 V



PINION DRIVE 03 594245
REPAIR KIT 24 182050
PINION FORK SET 11 594069

Valeo**432580/436061****D9R135**

2 Kw

3(0)



12 V



REDUCTION GEAR ASSEMBLY 02 182175
INDUCTION COIL 27 182051
PINION DRIVE 03 182176
REPAIR KIT 24 182050
PINION FORK SET 11 182048
SOLENOID SWITCH 04 105489

Valeo**432609/433339**

D9R139 2,2 Kw 2(0) ↻

12 V ⚙️11



INDUCTION COIL 🛠️27 182051
REPAIR KIT 🛠️24 182050
PINION FORK SET 🛠️11 182048
Valeo 432612/436041

D9R142 2,2 Kw 3(3) ↻

12 V ⚙️10



INDUCTION COIL 🛠️27 182051
PINION DRIVE 🛠️03 594251
REPAIR KIT 🛠️24 182050
PINION FORK SET 🛠️11 594069
SOLENOID SWITCH 🛠️04 105489
Valeo 432639/455552

D9R144 3,1 Kw 3(0) ↻

12 V ⚙️11

Picture not available
Image non disponible
Imagen no disponible
Immagine non disponibile
Nicht verfügbares Bild
Brak zdjęcia
Картина недоступна

Picture not available
Image non disponible
Imagen no disponible
Immagine non disponibile
Nicht verfügbares Bild
Brak zdjęcia
Картина недоступна

REDUCTION GEAR ASSEMBLY 🛠️02 182175
INDUCTION COIL 🛠️27 594059
PINION DRIVE 🛠️03 594043
REPAIR KIT 🛠️24 182050
PINION FORK SET 🛠️11 182048
SOLENOID SWITCH 🛠️04 594054
Valeo 184202/455537

D9R149 2,2 Kw 3(0) ↻

12 V ⚙️11



REDUCTION GEAR ASSEMBLY 🛠️02 182175
INDUCTION COIL 🛠️27 594157
PINION DRIVE 🛠️03 594152
REPAIR KIT 🛠️24 182050
PINION FORK SET 🛠️11 182048
SOLENOID SWITCH 🛠️04 594266
Valeo 432644/455554

D9R73 3,1 Kw 3(3) ↻

12 V ⚙️12



INDUCTION COIL 🛠️27 182051
PINION DRIVE 🛠️03 182047
REPAIR KIT 🛠️24 182050
PINION FORK SET 🛠️11 182048
SOLENOID SWITCH 🛠️04 105489

D9R73 3,1 Kw 3(3) ↻

12 V ⚙️12



INDUCTION COIL 🛠️27 182051
PINION DRIVE 🛠️03 182047
REPAIR KIT 🛠️24 182050
PINION FORK SET 🛠️11 182048
SOLENOID SWITCH 🛠️04 105489
Valeo 432538/433310

D9R84 2 Kw 3(3) ↻

12 V ⚙️10



PINION DRIVE 🛠️03 182052
REPAIR KIT 🛠️24 182050
PINION FORK SET 🛠️11 182048
SOLENOID SWITCH 🛠️04 105489
Valeo 432561/433305

D9R89 3,1 Kw 3(0) ↻

12 V ⚙️11



REDUCTION GEAR ASSEMBLY 🛠️02 182175
INDUCTION COIL 🛠️27 182051
PINION DRIVE 🛠️03 182176
REPAIR KIT 🛠️24 182050
PINION FORK SET 🛠️11 182048
SOLENOID SWITCH 🛠️04 105489
Valeo 432536/433229



D9R90 3,1 Kw 3(3) ↻

12 V ⚙️11



- REDUCTION GEAR ASSEMBLY** 🛠️02 182175
- INDUCTION COIL** 🛠️27 182051
- PINION DRIVE** 🛠️03 182177
- REPAIR KIT** 🛠️24 182050
- PINION FORK SET** 🛠️11 182048
- SOLENOID SWITCH** 🛠️04 181404

D9R90 3,1 Kw 3(3) ↻

12 V ⚙️11



- REDUCTION GEAR ASSEMBLY** 🛠️02 182175
- INDUCTION COIL** 🛠️27 182051
- PINION DRIVE** 🛠️03 182177
- REPAIR KIT** 🛠️24 182050
- PINION FORK SET** 🛠️11 182048
- SOLENOID SWITCH** 🛠️04 181404

Valeo 432563/433326

D9R91 3,1 Kw 3(0) ↻

12 V ⚙️9



- REDUCTION GEAR ASSEMBLY** 🛠️02 182175
- INDUCTION COIL** 🛠️27 182051
- PINION DRIVE** 🛠️03 594775
- PINION DRIVE** 🛠️03 182178
- REPAIR KIT** 🛠️24 182050
- PINION FORK SET** 🛠️11 182048
- SOLENOID SWITCH** 🛠️04 181069

Valeo 432574/436052

D9R96 3,1 Kw 3(3) ↻

12 V ⚙️12

Picture not available
Image non disponible
Imagen no disponible
Immagine non disponibile
Nicht verfügbares Bild
Brak zdjęcia
Картина недоступна

Picture not available
Image non disponible
Imagen no disponible
Immagine non disponibile
Nicht verfügbares Bild
Brak zdjęcia
Картина недоступна

- REDUCTION GEAR ASSEMBLY** 🛠️02 182175
- INDUCTION COIL** 🛠️27 182051
- REPAIR KIT** 🛠️24 182050
- PINION FORK SET** 🛠️11 182048
- SOLENOID SWITCH** 🛠️04 181404

Valeo 105808

D9R97 3,1 Kw 3(3) ↻

12 V ⚙️11



- REDUCTION GEAR ASSEMBLY** 🛠️02 182175
- PINION DRIVE** 🛠️03 594039
- REPAIR KIT** 🛠️24 182050
- PINION FORK SET** 🛠️11 182048
- SOLENOID SWITCH** 🛠️04 181404

D9R97 3,1 Kw 3(3) ↻

12 V ⚙️11



- REDUCTION GEAR ASSEMBLY** 🛠️02 182175
- PINION DRIVE** 🛠️03 594039
- REPAIR KIT** 🛠️24 182050
- PINION FORK SET** 🛠️11 182048
- SOLENOID SWITCH** 🛠️04 181404

Valeo 432587/433327

D9R99 3,1 Kw 3(3) ↻

12 V ⚙️11

Picture not available
Image non disponible
Imagen no disponible
Immagine non disponibile
Nicht verfügbares Bild
Brak zdjęcia
Картина недоступна

Picture not available
Image non disponible
Imagen no disponible
Immagine non disponibile
Nicht verfügbares Bild
Brak zdjęcia
Картина недоступна

- REDUCTION GEAR ASSEMBLY** 🛠️02 182175
- INDUCTION COIL** 🛠️27 182051
- PINION DRIVE** 🛠️03 182176
- REPAIR KIT** 🛠️24 182050
- PINION FORK SET** 🛠️11 182048
- SOLENOID SWITCH** 🛠️04 105489

Valeo 432577/436063

ESW20ER121 2 Kw 3(0) ↻

12 V 46_°⚙️13 N

Picture not available
Image non disponible
Imagen no disponible
Immagine non disponibile
Nicht verfügbares Bild
Brak zdjęcia
Картина недоступна

Picture not available
Image non disponible
Imagen no disponible
Immagine non disponibile
Nicht verfügbares Bild
Brak zdjęcia
Картина недоступна

- SOLENOID SWITCH** 🛠️04 *595676

Valeo 438254/458414

ESW20ER123 2 Kw 2(0) ↻
12 V 48_ ▽ 13 N

Picture not available
Image non disponible
Imagen no disponible
Immagine non disponibile
Nicht verfügbares Bild
Brak zdjęcia
Картина недоступна

Picture not available
Image non disponible
Imagen no disponible
Immagine non disponibile
Nicht verfügbares Bild
Brak zdjęcia
Картина недоступна

SOLENOID SWITCH 04 *595676
Valeo 438257/458417

ESW20ER20 2 Kw 2(0) ↻
12 V 60,87_ ▽ 13 N

Picture not available
Image non disponible
Imagen no disponible
Immagine non disponibile
Nicht verfügbares Bild
Brak zdjęcia
Картина недоступна

Picture not available
Image non disponible
Imagen no disponible
Immagine non disponibile
Nicht verfügbares Bild
Brak zdjęcia
Картина недоступна

SOLENOID SWITCH 04 *595676
Valeo 438258/458418

ESW20ER25 2 Kw 2(0) ↻
12 V 76_ ▽ 13 N

Picture not available
Image non disponible
Imagen no disponible
Immagine non disponibile
Nicht verfügbares Bild
Brak zdjęcia
Картина недоступна

Picture not available
Image non disponible
Imagen no disponible
Immagine non disponibile
Nicht verfügbares Bild
Brak zdjęcia
Картина недоступна

SOLENOID SWITCH 04 *595676
Valeo 438259/458419

ESW20ER6 2 Kw 2(1) ↻
12 V 0_ & 144_ ▽ 13 N

Picture not available
Image non disponible
Imagen no disponible
Immagine non disponibile
Nicht verfügbares Bild
Brak zdjęcia
Картина недоступна

Picture not available
Image non disponible
Imagen no disponible
Immagine non disponibile
Nicht verfügbares Bild
Brak zdjęcia
Картина недоступна

INDUCTION COIL 27 *595692
SOLENOID SWITCH 04 *595676
Valeo 438260/458420

FS10E10 1,4 Kw 3(3) ↻
12 V 60_ ▽ 9 N

Picture not available
Image non disponible
Imagen no disponible
Immagine non disponibile
Nicht verfügbares Bild
Brak zdjęcia
Картина недоступна

Picture not available
Image non disponible
Imagen no disponible
Immagine non disponibile
Nicht verfügbares Bild
Brak zdjęcia
Картина недоступна

BUSHING KIT 10 *595587
Valeo 438228/458392

FS60PR019 6 Kw 3(0) ↻
24 V 55_ ▽ Z12 N

Picture not available
Image non disponible
Imagen no disponible
Immagine non disponibile
Nicht verfügbares Bild
Brak zdjęcia
Картина недоступна

Picture not available
Image non disponible
Imagen no disponible
Immagine non disponibile
Nicht verfügbares Bild
Brak zdjęcia
Картина недоступна

SOLENOID SWITCH 04 *595616
Valeo 438233/458399

G15R55TE 0 ↻
24 V 0

Picture not available
Image non disponible
Imagen no disponible
Immagine non disponibile
Nicht verfügbares Bild
Brak zdjęcia
Картина недоступна

Picture not available
Image non disponible
Imagen no disponible
Immagine non disponibile
Nicht verfügbares Bild
Brak zdjęcia
Картина недоступна

POLE SHOE, SCREWS SET 15 182041

MF250-671 5,5 Kw ↻
24 V 12 N

Picture not available
Image non disponible
Imagen no disponible
Immagine non disponibile
Nicht verfügbares Bild
Brak zdjęcia
Картина недоступна

Picture not available
Image non disponible
Imagen no disponible
Immagine non disponibile
Nicht verfügbares Bild
Brak zdjęcia
Картина недоступна

SOLENOID SWITCH 04 *594783
Valeo 438208/458293

TS10E1 1 Kw 2(1) ↻
12 V 80° ▽ 8 N



ARMATURE 02a 594721
BRUSH HOLDER PLATE ASSEMBLY 08 594479
BUSHING KIT 10 594457
DRIVE END HOUSING 14 594736
INDUCTION COIL 27 594478
PINION DRIVE 03 594734
PINION FORK SET 11 594289
SOLENOID SWITCH 04 594735
Valeo 438192/458248

TS10E3 0,85 Kw 3(3) ↻

12 V 50° 8 N



- ARMATURE 02a 594721
- BRUSH HOLDER PLATE ASSEMBLY 08 594351
- BUSHING KIT 10 594457
- DRIVE END HOUSING 14 594510
- INDUCTION COIL 27 594477
- PINION DRIVE 03 594436
- PINION FORK SET 11 594289
- SOLENOID SWITCH 04 594653

Valeo 438163/458179

TS10E4 0,85 Kw 3(3) ↻

12 V 50° 8 N



- ARMATURE 02a 594721
- BRUSH HOLDER PLATE ASSEMBLY 08 594351
- BUSHING KIT 10 594457
- DRIVE END HOUSING 14 594510
- INDUCTION COIL 27 594477
- PINION DRIVE 03 594436
- PINION FORK SET 11 594289
- SOLENOID SWITCH 04 594438

Valeo 438110/455974

TS10E5 0,85 Kw 3(3) ↻

12 V 50° 8 N



- ARMATURE 02a 594721
- BRUSH HOLDER PLATE ASSEMBLY 08 594351
- BUSHING KIT 10 594457
- DRIVE END HOUSING 14 594510
- INDUCTION COIL 27 594477
- PINION DRIVE 03 594436
- PINION FORK SET 11 594289
- SOLENOID SWITCH 04 594355

Valeo 438054/455876

TS10E5(b) 0,85 Kw 3(3) ↻

12 V 50° 8 N



- ARMATURE 02a 594721
- BUSHING KIT 10 594457
- INDUCTION COIL 27 594477
- PINION DRIVE 03 594436
- PINION FORK SET 11 594289
- SOLENOID SWITCH 04 594355

Valeo 438054/455876

TS12E30 1,2 Kw 2(0) ↻

12 V 40° 9 N



- ARMATURE 02a 594650
- BRUSH HOLDER PLATE ASSEMBLY 08 *595592
- BUSHING KIT 10 *595595
- DRIVE END HOUSING 14 *595593
- INDUCTION COIL 27 594687
- PINION DRIVE 03 594685
- PIGNON DRIVE SHAFT ASSEMBLY 02b *595594
- REPAIR KIT 24 *595596
- PINION FORK SET 11 594645
- SOLENOID SWITCH 04 *595591

Valeo 438177/458225

TS12E36 1,2 Kw 2(1) ↻

12 V 58° 9 N

Picture not available
Image non disponible
Imagen no disponible
Immagine non disponibile
Nicht verfügbares Bild
Brak zdjęcia
Картина недоступна

Picture not available
Image non disponible
Imagen no disponible
Immagine non disponibile
Nicht verfügbares Bild
Brak zdjęcia
Картина недоступна

- SOLENOID SWITCH 04 *595713

Valeo 438272/458403

TS12E9(b) 1,4 Kw 3(3) ↻

12 V 13,7° 10 N

Picture not available
Image non disponible
Imagen no disponible
Immagine non disponibile
Nicht verfügbares Bild
Brak zdjęcia
Картина недоступна

Picture not available
Image non disponible
Imagen no disponible
Immagine non disponibile
Nicht verfügbares Bild
Brak zdjęcia
Картина недоступна

- ARMATURE 02a 594650
- BRUSH HOLDER PLATE ASSEMBLY 08 *595659
- PINION DRIVE 03 *595656
- PIGNON DRIVE SHAFT ASSEMBLY 02b 595721
- SOLENOID SWITCH 04 *595657

Valeo 438224/458388

TS12ER15 1,2 Kw 2(1) ↻

12 V 166_ ↻ 9 N

Picture not available
Image non disponible
Imagen no disponible
Immagine non disponibile
Nicht verfügbares Bild
Brak zdjęcia
Картина недоступна

Picture not available
Image non disponible
Imagen no disponible
Immagine non disponibile
Nicht verfügbares Bild
Brak zdjęcia
Картина недоступна

BUSHING KIT 🛠️10
PINION DRIVE 🛠️03
SOLENOID SWITCH 🛠️04

Valeo

*595613
594716
*595718
438273/458431

TS12ER15M 1,2 Kw 2(1) ↻

12 V 166_ ↻ 9 N

Picture not available
Image non disponible
Imagen no disponible
Immagine non disponibile
Nicht verfügbares Bild
Brak zdjęcia
Картина недоступна

Picture not available
Image non disponible
Imagen no disponible
Immagine non disponibile
Nicht verfügbares Bild
Brak zdjęcia
Картина недоступна

INDUCTION COIL 🛠️27
PINION DRIVE 🛠️03
SOLENOID SWITCH 🛠️04

Valeo

594718
594716
*595718
438273/458431

TS12ER19 1,2 Kw 3(0) ↻

12 V 4_ ↻ 9 N

Picture not available
Image non disponible
Imagen no disponible
Immagine non disponibile
Nicht verfügbares Bild
Brak zdjęcia
Картина недоступна

Picture not available
Image non disponible
Imagen no disponible
Immagine non disponibile
Nicht verfügbares Bild
Brak zdjęcia
Картина недоступна

ARMATURE 🛠️02a
BUSHING KIT 🛠️10
PINION DRIVE 🛠️03
PIGNON DRIVE SHAFT ASSEMBLY 🛠️02b
SOLENOID SWITCH 🛠️04

Valeo

594650
*595613
594716
594719
*595611
438268/458428

TS12ER20 1,1 Kw 2(0) ↻

12 V 54_ ↻ 10 N

Picture not available
Image non disponible
Imagen no disponible
Immagine non disponibile
Nicht verfügbares Bild
Brak zdjęcia
Картина недоступна

Picture not available
Image non disponible
Imagen no disponible
Immagine non disponibile
Nicht verfügbares Bild
Brak zdjęcia
Картина недоступна

BRUSH HOLDER PLATE ASSEMBLY 🛠️08
BUSHING KIT 🛠️10
DRIVE END HOUSING 🛠️14
PINION DRIVE 🛠️03
REPAIR KIT 🛠️24
SOLENOID SWITCH 🛠️04

Valeo

594674
*595613
*595615
594666
594669
*595611
438219/458372

TS12ER22 1,1 Kw 2(0) ↻

12 V 54,4_ ↻ 11 N

Picture not available
Image non disponible
Imagen no disponible
Immagine non disponibile
Nicht verfügbares Bild
Brak zdjęcia
Картина недоступна

Picture not available
Image non disponible
Imagen no disponible
Immagine non disponibile
Nicht verfügbares Bild
Brak zdjęcia
Картина недоступна

BUSHING KIT 🛠️10
REPAIR KIT 🛠️24
SOLENOID SWITCH 🛠️04

Valeo

*595613
594669
*595726
438262/458422

TS12ER22M 1,1 Kw 2(0) ↻

12 V 54,4_ ↻ 11 N

Picture not available
Image non disponible
Imagen no disponible
Immagine non disponibile
Nicht verfügbares Bild
Brak zdjęcia
Картина недоступна

Picture not available
Image non disponible
Imagen no disponible
Immagine non disponibile
Nicht verfügbares Bild
Brak zdjęcia
Картина недоступна

BRUSH HOLDER PLATE ASSEMBLY 🛠️08
REPAIR KIT 🛠️24
SOLENOID SWITCH 🛠️04

Valeo

594674
594669
*595726
438262/458422

TS12ER25 1,1 Kw 2(0) ↻

12 V 74_ ↻ 10 N

Picture not available
Image non disponible
Imagen no disponible
Immagine non disponibile
Nicht verfügbares Bild
Brak zdjęcia
Картина недоступна

Picture not available
Image non disponible
Imagen no disponible
Immagine non disponibile
Nicht verfügbares Bild
Brak zdjęcia
Картина недоступна

BRUSH HOLDER PLATE ASSEMBLY 🛠️08
BUSHING KIT 🛠️10
DRIVE END HOUSING 🛠️14
PINION DRIVE 🛠️03
SOLENOID SWITCH 🛠️04

Valeo

*595592
*595613
*595612
594666
*595611
438238/458404

TS14E110 1,4 Kw 2(1) ↻

12 V 38° ↻ 11 N



ARMATURE 🛠️02a
COMMUTATOR END SHIELD, ASSEMBLY 🛠️13
DRIVE END HOUSING 🛠️14
INDUCTION COIL 🛠️27
PINION DRIVE 🛠️03
PINION FORK SET 🛠️11
SOLENOID SWITCH 🛠️04

Valeo

594650
*595578
*595579
*595577
*595575
594645
*595576
438133/455982

TS14E7	1,4 Kw	3(0)	↻
12 V	25_°	10	N

Picture not available
Image non disponible
Imagen no disponible
Immagine non disponibile
Nicht verfügbares Bild
Brak zdjęcia
Картина недоступна

Picture not available
Image non disponible
Imagen no disponible
Immagine non disponibile
Nicht verfügbares Bild
Brak zdjęcia
Картина недоступна

SOLENOID SWITCH 04

*595701

Valeo

438264/458424

TS18E1(b)	2 Kw	3(0)	↻
12 V	42°	11	N



ARMATURE 02a

594683

DRIVE END HOUSING 14

*595640

INDUCTION COIL 27

*595623

PINION DRIVE 03

*595639

FIELD SERIES COIL SET 06

*595624

REPAIR KIT 24

*595629

PINION FORK SET 11

*595628

SOLENOID SWITCH 04

*595617

Valeo

438175/458217

TS18E13	1,5 Kw	4(2)	↻
12 V	37°	11	N



BUSHING KIT 10

594752

SOLENOID SWITCH 04

595731

Valeo

438166/458185

TS18E3(b)	2 Kw	2(0)	↻
12 V	42°	11	N



ARMATURE 02a

594683

DRIVE END HOUSING 14

594676

INDUCTION COIL 27

*595623

PINION DRIVE 03

*595641

FIELD SERIES COIL SET 06

*595624

REPAIR KIT 24

*595629

PINION FORK SET 11

*595628

SOLENOID SWITCH 04

*595617

Valeo

438176/458218

TS18E33	1,8 Kw	2(1)	↻
12 V	75°	10	N

Picture not available
Image non disponible
Imagen no disponible
Immagine non disponibile
Nicht verfügbares Bild
Brak zdjęcia
Картина недоступна

Picture not available
Image non disponible
Imagen no disponible
Immagine non disponibile
Nicht verfügbares Bild
Brak zdjęcia
Картина недоступна

BRUSH HOLDER PLATE ASSEMBLY 08

594780

BUSHING KIT 10

594752

INDUCTION COIL 27

*594782

Valeo

438212/458351

TS18E331	2,3 Kw	2(1)	↻
12 V	75°	10	N

Picture not available
Image non disponible
Imagen no disponible
Immagine non disponibile
Nicht verfügbares Bild
Brak zdjęcia
Картина недоступна

Picture not available
Image non disponible
Imagen no disponible
Immagine non disponibile
Nicht verfügbares Bild
Brak zdjęcia
Картина недоступна

BRUSH HOLDER PLATE ASSEMBLY 08

594780

Valeo

438212/458351

TS18E7	1,5 Kw	3(3)	↻
12 V	45°	10	N

Picture not available
Image non disponible
Imagen no disponible
Immagine non disponibile
Nicht verfügbares Bild
Brak zdjęcia
Картина недоступна

Picture not available
Image non disponible
Imagen no disponible
Immagine non disponibile
Nicht verfügbares Bild
Brak zdjęcia
Картина недоступна

ARMATURE 02a

594621

BUSHING KIT 10

594752

DRIVE END HOUSING 14

*595590

INDUCTION COIL 27

594469

PINION DRIVE 03

594465

REPAIR KIT 24

*595589

PINION FORK SET 11

594616

SOLENOID SWITCH 04

594454

Valeo

438213/458364

TS18ER121(b)	2 Kw	3(0)	↻
12 V	42_°	12	N

Picture not available
Image non disponible
Imagen no disponible
Immagine non disponibile
Nicht verfügbares Bild
Brak zdjęcia
Картина недоступна

Picture not available
Image non disponible
Imagen no disponible
Immagine non disponibile
Nicht verfügbares Bild
Brak zdjęcia
Картина недоступна

ARMATURE 02a

*595621

DRIVE END HOUSING 14

*595625

INDUCTION COIL 27

*595623

PINION DRIVE 03

*595622

FIELD SERIES COIL SET 06

*595624

REPAIR KIT 24

*595629

PINION FORK SET 11

*595628

SOLENOID SWITCH 04

*595617

Valeo

438225/458389

TS18ER123 2 Kw 2(0) ↻
12 V 42° ↙ 12 N

Picture not available
Image non disponible
Imagen no disponible
Immagine non disponibile
Nicht verfügbares Bild
Brak zdjęcia
Картина недоступна

Picture not available
Image non disponible
Imagen no disponible
Immagine non disponibile
Nicht verfügbares Bild
Brak zdjęcia
Картина недоступна

SOLENOID SWITCH 04 594617
Valeo 438226/458390

TS18ER123(b) 2 Kw 2(0) ↻
12 V 42° ↙ 12 N

Picture not available
Image non disponible
Imagen no disponible
Immagine non disponibile
Nicht verfügbares Bild
Brak zdjęcia
Картина недоступна

Picture not available
Image non disponible
Imagen no disponible
Immagine non disponibile
Nicht verfügbares Bild
Brak zdjęcia
Картина недоступна

ARMATURE 02a *595621
DRIVE END HOUSING 14 *595635
INDUCTION COIL 27 *595623
PINION DRIVE 03 *595634
FIELD SERIES COIL SET 06 *595624
REPAIR KIT 24 *595629
PINION FORK SET 11 *595628
SOLENOID SWITCH 04 *595617
Valeo 438226/458390

TS18ER20(b) 2 Kw 2(0) ↻
12 V 54,4° ↗ 12 N

Picture not available
Image non disponible
Imagen no disponible
Immagine non disponibile
Nicht verfügbares Bild
Brak zdjęcia
Картина недоступна

Picture not available
Image non disponible
Imagen no disponible
Immagine non disponibile
Nicht verfügbares Bild
Brak zdjęcia
Картина недоступна

ARMATURE 02a *595621
INDUCTION COIL 27 *595623
PINION DRIVE 03 *595634
REPAIR KIT 24 *595629
PINION FORK SET 11 *595628
SOLENOID SWITCH 04 *595617
Valeo 438227/458391

TS18ER22 2 Kw 2(0) ↻
12 V 53° ↗ 12 N

Picture not available
Image non disponible
Imagen no disponible
Immagine non disponibile
Nicht verfügbares Bild
Brak zdjęcia
Картина недоступна

Picture not available
Image non disponible
Imagen no disponible
Immagine non disponibile
Nicht verfügbares Bild
Brak zdjęcia
Картина недоступна

ARMATURE 02a *595621
INDUCTION COIL 27 *595623
PINION DRIVE 03 *595634
REPAIR KIT 24 *595629
PINION FORK SET 11 *595628
SOLENOID SWITCH 04 *595617
Valeo 438252/458412

TS22E20 2,2 Kw 2(0) ↻
12 V 62° ↙ 9 N

Picture not available
Image non disponible
Imagen no disponible
Immagine non disponibile
Nicht verfügbares Bild
Brak zdjęcia
Картина недоступна

Picture not available
Image non disponible
Imagen no disponible
Immagine non disponibile
Nicht verfügbares Bild
Brak zdjęcia
Картина недоступна

ARMATURE 02a 594683
BUSHING KIT 10 594752
PINION FORK SET 11 *595620
Valeo 438274/458446

TS22E26 2,2 Kw 3(1) ↻
12 V 55° ↗ 11 N



ARMATURE 02a 594683
BUSHING KIT 10 594752
PINION DRIVE 03 *595597
SOLENOID SWITCH 04 595731
Valeo 438189/458237

TS22E45 2,2 Kw 2(1) ↻
12 V 18° ↙ 10 N

Picture not available
Image non disponible
Imagen no disponible
Immagine non disponibile
Nicht verfügbares Bild
Brak zdjęcia
Картина недоступна

Picture not available
Image non disponible
Imagen no disponible
Immagine non disponibile
Nicht verfügbares Bild
Brak zdjęcia
Картина недоступна

ARMATURE 02a 594683
BUSHING KIT 10 594752
DRIVE END HOUSING 14 *595607
INDUCTION COIL 27 *595606
PINION DRIVE 03 *595604
PIGNON DRIVE SHAFT ASSEMBLY 02b *595608
REPAIR KIT 24 *595609
SOLENOID SWITCH 04 *595605
Valeo 438232/458397

TS22E5 2,2 Kw 3(3) ↻
12 V 36° ↙ 10 N

Picture not available
Image non disponible
Imagen no disponible
Immagine non disponibile
Nicht verfügbares Bild
Brak zdjęcia
Картина недоступна

Picture not available
Image non disponible
Imagen no disponible
Immagine non disponibile
Nicht verfügbares Bild
Brak zdjęcia
Картина недоступна

ARMATURE 02a 594683
BUSHING KIT 10 594752
DRIVE END HOUSING 14 594751
INDUCTION COIL 27 594750
PINION DRIVE 03 594747
PINION FORK SET 11 594748
SOLENOID SWITCH 04 *595673
Valeo 438202/458291



TS22E8(c)	2,2 Kw	3(3)	↻
12 V	102_°	10	N

Picture not available
Image non disponible
Imagen no disponible
Immagine non disponibile
Nicht verfügbares Bild
Brak zdjęcia
Картина недоступна

Picture not available
Image non disponible
Imagen no disponible
Immagine non disponibile
Nicht verfügbares Bild
Brak zdjęcia
Картина недоступна

ARMATURE 02a 594683
BUSHING KIT 10 594752
INDUCTION COIL 27 594750
PINION DRIVE 03 594747
SOLENOID SWITCH 04 594658
Valeo 438263/458423

TS22ER12	2,2 Kw	2(1)	↻
12 V	6,73_°	12	N

Picture not available
Image non disponible
Imagen no disponible
Immagine non disponibile
Nicht verfügbares Bild
Brak zdjęcia
Картина недоступна

Picture not available
Image non disponible
Imagen no disponible
Immagine non disponibile
Nicht verfügbares Bild
Brak zdjęcia
Картина недоступна

ARMATURE 02a 594683
SOLENOID SWITCH 04 *595598
Valeo 438243/458411

TS24E13	2,4 Kw	3(0)	↻
12 V	73_°	11	N

Picture not available
Image non disponible
Imagen no disponible
Immagine non disponibile
Nicht verfügbares Bild
Brak zdjęcia
Картина недоступна

Picture not available
Image non disponible
Imagen no disponible
Immagine non disponibile
Nicht verfügbares Bild
Brak zdjęcia
Картина недоступна

ARMATURE 02a 594683
BUSHING KIT 10 594752
DRIVE END HOUSING 14 *595600
INDUCTION COIL 27 *595599
PINION DRIVE 03 *595597
PIGNON DRIVE SHAFT ASSEMBLY 02b *595601
REPAIR KIT 24 *595603
SOLENOID SWITCH 04 *595598
Valeo 438231/458395

TS24E3	2 Kw	2(1)	↻
12 V	65_°	8	N

Picture not available
Image non disponible
Imagen no disponible
Immagine non disponibile
Nicht verfügbares Bild
Brak zdjęcia
Картина недоступна

Picture not available
Image non disponible
Imagen no disponible
Immagine non disponibile
Nicht verfügbares Bild
Brak zdjęcia
Картина недоступна

SOLENOID SWITCH 04 *594784
INDUCTION COIL 27 *594788
FIELD SERIES COIL SET 06 *595665
PINION FORK SET 11 *594785
Valeo 438220/458373

TS24E30	2 Kw	2(1)	↻
12 V	65_°	8	N

Picture not available
Image non disponible
Imagen no disponible
Immagine non disponibile
Nicht verfügbares Bild
Brak zdjęcia
Картина недоступна

Picture not available
Image non disponible
Imagen no disponible
Immagine non disponibile
Nicht verfügbares Bild
Brak zdjęcia
Картина недоступна

BUSHING KIT 10 594752
SOLENOID SWITCH 04 *594784
FIELD SERIES COIL SET 06 *595665
PINION FORK SET 11 *594785
Valeo 438271/458373

TS24E6	2,2 Kw	3(0)	↻
12 V	71_°	10	N

Picture not available
Image non disponible
Imagen no disponible
Immagine non disponibile
Nicht verfügbares Bild
Brak zdjęcia
Картина недоступна

Picture not available
Image non disponible
Imagen no disponible
Immagine non disponibile
Nicht verfügbares Bild
Brak zdjęcia
Картина недоступна

ARMATURE 02a 594683
PINION DRIVE 03 594747
FIELD SERIES COIL SET 06 *595665
PINION FORK SET 11 *595620
SOLENOID SWITCH 04 *595653
Valeo 438256/458416

TS24E7	2,2 Kw	3(0)	↻
12 V	45_°	10	N

Picture not available
Image non disponible
Imagen no disponible
Immagine non disponibile
Nicht verfügbares Bild
Brak zdjęcia
Картина недоступна

Picture not available
Image non disponible
Imagen no disponible
Immagine non disponibile
Nicht verfügbares Bild
Brak zdjęcia
Картина недоступна

ARMATURE 02a 594683
PINION DRIVE 03 594747
FIELD SERIES COIL SET 06 *595665
PINION FORK SET 11 *595620
SOLENOID SWITCH 04 *595618
Valeo 438255/458415

TS8E2	0,8 Kw	3(1)	↻
12 V	55_°	9	N



ARMATURE 02a 594721
BRUSH HOLDER PLATE ASSEMBLY 08 594290
BUSHING KIT 10 594456
DRIVE END HOUSING 14 594507
INDUCTION COIL 27 594522
PINION DRIVE 03 594726
PINION FORK SET 11 594289
SOLENOID SWITCH 04 594348
Valeo 438093/455962

TS8E3	0,7 Kw	2(1)	↻
12 V	35°	8	N

Picture not available
Image non disponible
Imagen no disponible
Immagine non disponibile
Nicht verfügbares Bild
Brak zdjęcia
Картина недоступна

Picture not available
Image non disponible
Imagen no disponible
Immagine non disponibile
Nicht verfügbares Bild
Brak zdjęcia
Картина недоступна

- ARMATURE** 02a 594721
 - BRUSH HOLDER PLATE ASSEMBLY** 08 594290
 - BUSHING KIT** 10 594456
 - DRIVE END HOUSING** 14 594697
 - INDUCTION COIL** 27 594522
 - PINION DRIVE** 03 *595733
 - PINION FORK SET** 11 594289
 - SOLENOID SWITCH** 04 594452
- Valeo** 438136/455985

TS8E4	0,7 Kw	2(1)	↻
12 V	54°	8	N



- ARMATURE** 02a 594721
 - BRUSH HOLDER PLATE ASSEMBLY** 08 594290
 - BUSHING KIT** 10 594456
 - INDUCTION COIL** 27 594522
 - PINION DRIVE** 03 *595733
 - PINION FORK SET** 11 594289
 - SOLENOID SWITCH** 04 594452
- Valeo** 438137/458159

TS8E5	0,7 Kw	2(1)	↻
12 V	35°	8	N



- ARMATURE** 02a 594721
 - BRUSH HOLDER PLATE ASSEMBLY** 08 594290
 - BUSHING KIT** 10 594456
 - INDUCTION COIL** 27 594522
 - PINION DRIVE** 03 *595733
 - PINION FORK SET** 11 594289
 - SOLENOID SWITCH** 04 594481
- Valeo** 438156/458170

TS8E6	0,85 Kw	2(1)	↻
12 V	37°	9	N



- ARMATURE** 02a 594721
 - BRUSH HOLDER PLATE ASSEMBLY** 08 594290
 - BUSHING KIT** 10 594456
 - DRIVE END HOUSING** 14 594506
 - INDUCTION COIL** 27 594522
 - PINION DRIVE** 03 594726
 - PINION FORK SET** 11 594289
 - SOLENOID SWITCH** 04 594698
- Valeo** 432685/455722

TS8E6(b)	0,85 Kw	2(1)	↻
12 V	37°	9	N



- ARMATURE** 02a 594721
 - INDUCTION COIL** 27 594522
 - PINION DRIVE** 03 594287
 - PINION FORK SET** 11 594417
 - SOLENOID SWITCH** 04 594698
- Valeo** 432685/455722

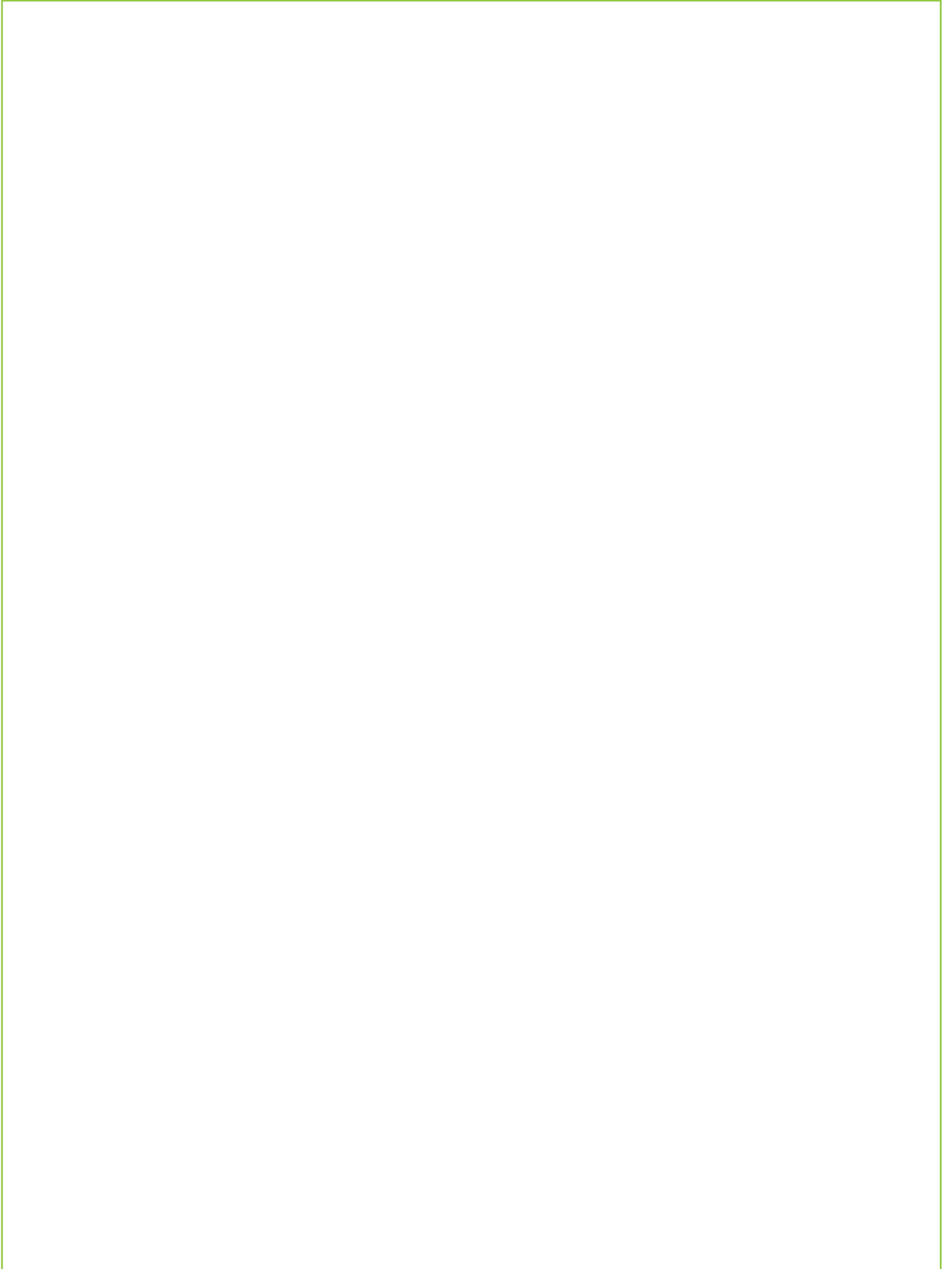





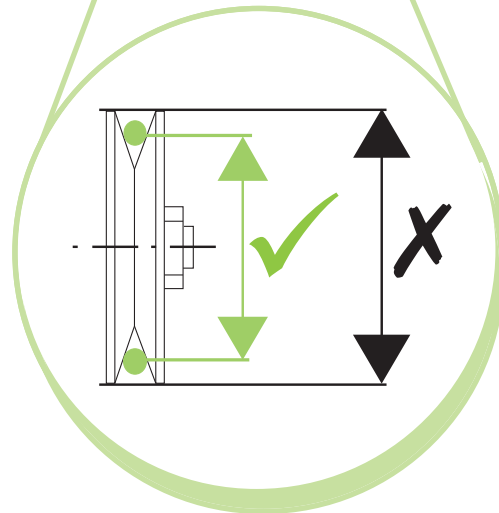



















437516	100	2	6	3
14 V		13-90°	57	INC















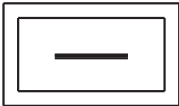

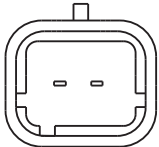

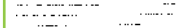
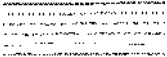

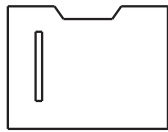
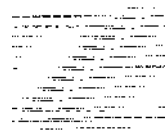

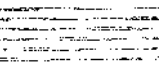
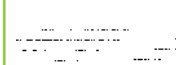
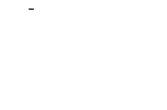



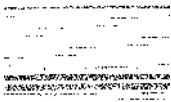



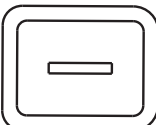

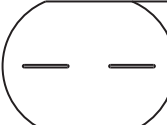

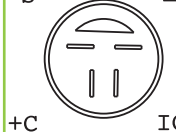

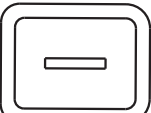

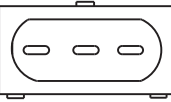
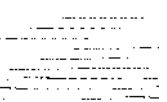
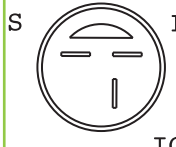
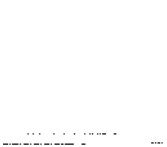

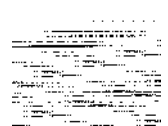



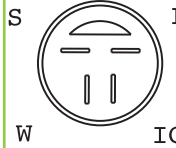





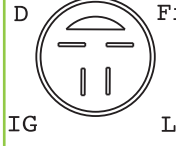

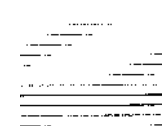
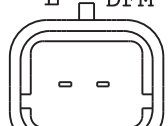
	SEP : Separate regulator - INC : Built-in regulator SEP : Régulateur séparé - INC : Régulateur incorporé SEP : Regulador separado - INC : Regulador incorporado SEP : Regulador separado - INC : Regulador incorporado SEP : Regolatore separato - INC : Regolatore incorporato
	Rotor Rotor Rotor Rotor Rotore
	Stator Stator Estator Estator Statore
	Rectifier Pont de diodes Placa de diodos Placa de diodos Ponte diodi
	Auxiliary diodes Support de diodes auxiliaires Soporte de Diodo auxiliar Suporte de Diodo auxiliar Diodi ausiliari
	Brush holder Porte-balais complet Porta-escobillas Porta-escovas Porta spazzole
	Brushes Jeu de balais Juego de escobillas Jogo de Escovas Spazzole
	Fuse Fusible Fusible Fusível Fusibile
	Pulley Poulie Polea Polia Puleggia
	Fan Ventilateur Ventilador Ventilador Ventilatore
	Hardware of pulley Jeu de pièces fixation poulie Piezas sujección polea Peças de fixação da polia Corredo fissaggio puleggia
	Condenser Condensateur Condensador Condensador Condensatore
	Hardware for front bearing Rondelle de fermeture Arandela de cierre Anilha de fecho Rondella di bloccaggio
	A + terminal Borne A+ Borne A+ Borne A+ Terminale A+

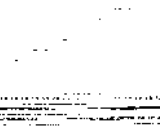
	Complète terminal "R" diameter 5 Borne relais diamètre 5 Borne de relé de diamètre 5 Borne do relé de diâmetro 5 Morsetto relé diametro 5
	"+" terminal Borne plus Borne + Borne + Polo +
	Front bearing Roulement avant Rodamiento delantero Rolamento dianteiro Cuscinetto anteriore
	Rear bearing Roulement arrière Rodamiento posterior Rolamento posterior Cuscinetto posteriore
	Protective cover Capot de protection Tapa de protección Tampa de protecção Copertura protettiva
	Rear holder Patte arrière Pata posterior Fixação posterior Staffa posteriore
	Plastic capsule Capsule plastique cápsula de plástico Cápsula de plástico Capsula in plastica
	Silent block Ensemble amortisseur de tendeur Conjunto amortiguador del tensor Conjunto amortecedor do tensor Blocco silenziatore
	Repair kit Kit de réparation VI Kit de reparación VI Kit de reparação VI Kit riparazione VI
	Rear Bracket Palier arrière Tapa trasera Tampa traseira Supporto posteriore
	Front housing Palier avant équipé Tapa delantera Tapa dianteira Supporto anteriore equipaggiato

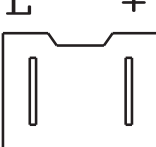
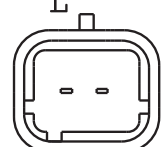

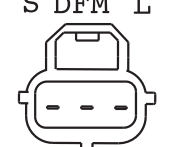

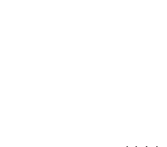
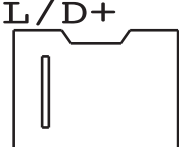
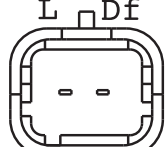
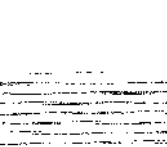
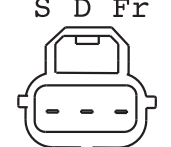
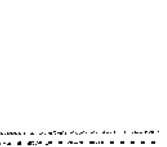





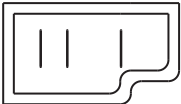
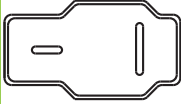

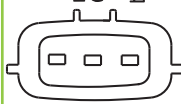
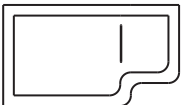



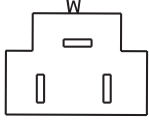

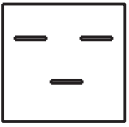
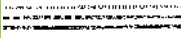
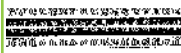
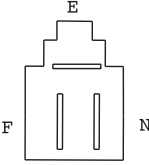
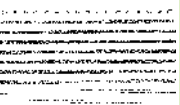
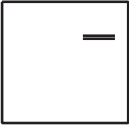
2		SEP :Externe regelaar - INC : Ingebouwde regelaar SEP: Mit externem Regler - INC: Mit integriertem Regler SEP : Oddzielny regulator - INC : wbudowany regulator SEP :Dıştan konjektör - INC : İçten konjektör SEP :Отдельный регулятор - INC :встроенный регулятор
4		Rotor Rotor Wirnik Rotor Якорь
5		Stator Stator Stojan Stator Статор
7		Diodebrug Diodenbrücke Mostek diodowy Diod köprüsü Выпрямитель/диод
8		Hulpdiodebrug Externer Diodenträger Diody Yardımcı diod desteği Дополнительные диоды
9		Borstelhouder Kohlenhalter Szczotkotrzymacz Kömür tutuculu indüktör Щеткодержатель
9a		Koolborstelset Kohlebürstensatz Szczotki Kömür takımı Набор щеток
10		Zekering Sicherung Bezpiecznik Sigorta Предохранитель
11		Poulie Riemenscheibe Koło pasowe Kasnak Ременной шкив
12		Ventilator Lüfterscheibe Wiatrak Pervane Вентилятор
13		Bevestigingsset voor poelie Befestigungssatz für Riemenscheibe Zestaw mocowań koła pasowego Kasnak sabitleme takımı parçaları Крепление ременного шкива
14		Condensator Kondensator Kondensator Kondansatör Конденсатор
16		Houder voorste kogellager Verschluss Scheibe Zestaw do przedniego łożyska Kilit pulu Набор к переднему подшипнику
17		Aansluitklem A+ Anschlussklemme "A+" Zacisk A + A+ ucu A+ клемма

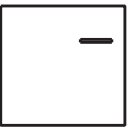
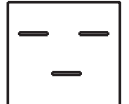

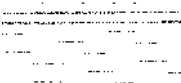
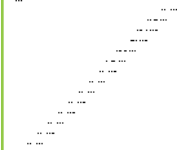
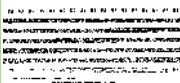
18		Aansluitklem relais diameter 5 Relaisanschluss 5 mm Kompletny zacisk „R” średnica 5 5 mm çapında sigorta tablo ucu Целая клемма «R» диаметр 5
20		Aansluitklem B+ Plusanschluss Zacisk „+” + uç Контакт «+»
21		Lager voor Kugellager Vorne Przednie łożysko Ön rulman Передний подшипник
22		Lager achter Kugellager Hinten Tylnie łożysko Arka rulman Задний подшипник
24		Beschermkap Schutzkappe Ochronna obudowa Koruma kapağı Защитная крышка
25		Achterste houder Hintere Befestigung Tylny wspornik Arka braket Задний держатель
26		Kunststof kapje Kunststoffabdeckung Plastikowa kapsuła Plastik kapsül Пластиковая капсула
28		Rubberen dempingsschijf Dämpfer Amortyzator drgań Titreşim amortisör takımı Сайлент блок
29		Reparatieset (inwendige ventilator) Reparatursatz Zestaw naprawczy İçten soğutmalı alternatör tamir takımı Ремонтный набор
30		Achterste behuizing Hinteres Lagerschild Tylna obudowa Arka kapak Задняя скоба/кронштейн
31		Voorste behuizing Ausgestattetes vorderes Lagerschild Przednia obudowa Ön kapak-Parçaları Передняя крышка

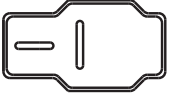
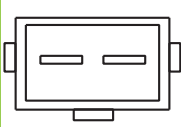
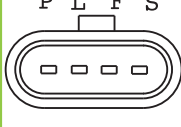
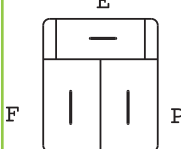
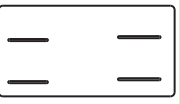
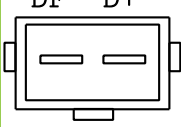
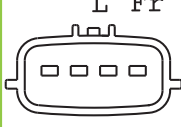
1 B+ 	13 B+ B+ 	23 COM 	37 	53 S RC LI 	68 	78 
2 W 	14 EXC 	24 	38 	54 	69 	79 
3 L 	15 	25 	39 	55 	70 S D IG L 	80 
4 DF 	16 	30 L DFM 	40 	56 	71 S L +C IG 	81 
5 D+ 	17 	31 L 	41 61E 15 	57 	72 S L IG 	82 
6 EXC 	18 	32 COM 	42 	60 	73 S L W IG 	85 S IG L 
7 	19 	33 	43 	61 	74 D Fr IG L 	86 
8 	20 L DFM 	34 	50 B+ RC LI 	62 	75 	87 
11 L + 	21 L 	35 	51 S DFM L 	66 	76 	88 
12 L/D+ 	22 L Df 	36 	52 S D Fr 	67 	77 	89 

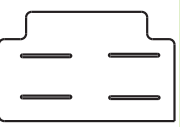

91 B+ B+ D+ 	112 S L 	122 	132 S IG L 	143	159	169
92 D+ 	113	123	133 L R S 	144	160	171 
101 Exc 	114	124	134	145	161 W  L R	172 
102 DF 	115 	125	135 	146	162 E  F N	180 
103 DF 	116	126 	136	147	163	181 
104 Exc 	117	127	137	148	164	182
105 D+ DF 	118	128 	138	149	165	183
106 	119	129	140 	151 	166	184 
110 L IG(R) 	120 D+ W 	130 P L F S 	141 E  F P	152	167	190 
111	121 DF D+ 	131 L Fr 	142 	153	168	191 

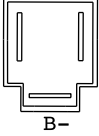
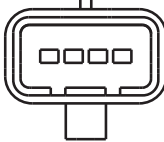

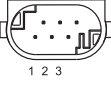
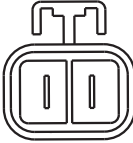
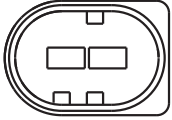
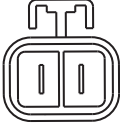
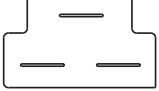
<p>199</p> <p>.....</p>	<p>223</p> <p>.....</p>	<p>271</p> <p>.....</p>				
<p>200</p> <p>.....</p>	<p>224</p> <p>.....</p>	<p>280</p> <p>D+ Exc</p> 				
<p>201</p> <p>.....</p>	<p>230</p> <p>Exc+ Exc- T T</p> 	<p>290</p> <p>.....</p>				
<p>210</p> <p>.....</p>	<p>231</p> <p>.....</p>	<p>.....</p>				
<p>217</p> <p>.....</p>	<p>240</p> <p>COM</p> 	<p>.....</p>				
<p>218</p> <p>.....</p>	<p>250</p> <p>MASSÉ / ground / ALIMENTATION +5V / CAPTEUR V / output V / CAPTEUR U / output U / CAPTEUR W / output W / NON UTILISÉ / unused</p> 	<p>.....</p>				
<p>219</p> <p>.....</p>	<p>253</p> <p>.....</p>	<p>.....</p>				
<p>220</p> <p>L</p> 	<p>260</p> <p>EXC+ EXC-</p> 	<p>.....</p>				
<p>221</p> <p>D+ W</p> 	<p>261</p> <p>.....</p>	<p>.....</p>				
<p>222</p> <p>.....</p>	<p>270</p> <p>B-</p>  <p>EXC D+</p>	<p>.....</p>				



2518032

35

1

14



Picture not available
Image non disponible
Imagen no disponible
Immagine non disponibile
Nicht verfügbares Bild
Brak zdjęcia
Картина недоступна

Picture not available
Image non disponible
Imagen no disponible
Immagine non disponibile
Nicht verfügbares Bild
Brak zdjęcia
Картина недоступна

BRUSH HOLDER 09

494487

RECTIFIER OR DIODE BRIDGE ASSEMBLY 07

592554

FAN 12

507001

REAR BEARING 22

592857

ROTOR 04

512009

STATOR 05

592625

Valeo**592681****2518033**

35

1

14



Picture not available
Image non disponible
Imagen no disponible
Immagine non disponibile
Nicht verfügbares Bild
Brak zdjęcia
Картина недоступна

Picture not available
Image non disponible
Imagen no disponible
Immagine non disponibile
Nicht verfügbares Bild
Brak zdjęcia
Картина недоступна

BRUSH HOLDER 09

494487

RECTIFIER OR DIODE BRIDGE ASSEMBLY 07

592554

FAN 12

507001

REAR BEARING 22

592857

ROTOR 04

512009

STATOR 05

592625

Valeo**592682****2518050**

35

1

1V

14



Ø 79,4

Picture not available
Image non disponible
Imagen no disponible
Immagine non disponibile
Nicht verfügbares Bild
Brak zdjęcia
Картина недоступна

Picture not available
Image non disponible
Imagen no disponible
Immagine non disponibile
Nicht verfügbares Bild
Brak zdjęcia
Картина недоступна

BRUSH HOLDER 09

503017

RECTIFIER OR DIODE BRIDGE ASSEMBLY 07

501024

FAN 12

*507067

PULLEY 11

101932

ROTOR 04

512031

Valeo**433476****2518051**

55

1

SP

14



Picture not available
Image non disponible
Imagen no disponible
Immagine non disponibile
Nicht verfügbares Bild
Brak zdjęcia
Картина недоступна

Picture not available
Image non disponible
Imagen no disponible
Immagine non disponibile
Nicht verfügbares Bild
Brak zdjęcia
Картина недоступна

BRUSH HOLDER 09

503019

SEP:SEPARATED REGULATOR -INC:BUILT-IN REGULATOR 02

494495

FAN 12

507001

FRONT HOUSING 31

592606

ROTOR 04

512039

2518057

55

2

1V

14



Ø 59,7

Picture not available
Image non disponible
Imagen no disponible
Immagine non disponibile
Nicht verfügbares Bild
Brak zdjęcia
Картина недоступна

Picture not available
Image non disponible
Imagen no disponible
Immagine non disponibile
Nicht verfügbares Bild
Brak zdjęcia
Картина недоступна

SEP:SEPARATED REGULATOR -INC:BUILT-IN REGULATOR 02

523345

RECTIFIER OR DIODE BRIDGE ASSEMBLY 07

501118

FAN 12

507001

REAR BEARING 22

592857

Valeo**433119****2518071**

45

2

14



Picture not available
Image non disponible
Imagen no disponible
Immagine non disponibile
Nicht verfügbares Bild
Brak zdjęcia
Картина недоступна

Picture not available
Image non disponible
Imagen no disponible
Immagine non disponibile
Nicht verfügbares Bild
Brak zdjęcia
Картина недоступна

BRUSH HOLDER 09

494489

Valeo**433090****2940426**

70

2

1V

14



Ø 59,7

INC

**FAN** 12

592088

REAR BEARING 22

592857

STATOR 05

592625

Valeo**432829/436316****2940526**

55

1

1V

14



Ø 71

Picture not available
Image non disponible
Imagen no disponible
Immagine non disponibile
Nicht verfügbares Bild
Brak zdjęcia
Картина недоступна

Picture not available
Image non disponible
Imagen no disponible
Immagine non disponibile
Nicht verfügbares Bild
Brak zdjęcia
Картина недоступна

BRUSH HOLDER 09

503019

SEP:SEPARATED REGULATOR -INC:BUILT-IN REGULATOR 02

494495

RECTIFIER OR DIODE BRIDGE ASSEMBLY 07

592554

REAR BEARING 22

592857

ROTOR 04

512039

Valeo**433002/436269**

2940753	45	2	1V
28	↻	0°	Ø 71

Picture not available
Image non disponible
Imagen no disponible
Imagine non disponibile
Nicht verfügbares Bild
Brak zdjęcia
Картина недоступна

Picture not available
Image non disponible
Imagen no disponible
Imagine non disponibile
Nicht verfügbares Bild
Brak zdjęcia
Картина недоступна

BRUSH HOLDER 09 503025
SEP:SEPARATED REGULATOR -INC:BUILT-IN REGULATOR 02 505039
CONDENSOR 14 517009
RECTIFIER OR DIODE BRIDGE ASSEMBLY 07 501096
FAN 12 590553
REAR BEARING 22 592857
Valeo 523070

2940754	70	2	1V
14	↻	0°	Ø 71

Picture not available
Image non disponible
Imagen no disponible
Imagine non disponibile
Nicht verfügbares Bild
Brak zdjęcia
Картина недоступна

Picture not available
Image non disponible
Imagen no disponible
Imagine non disponibile
Nicht verfügbares Bild
Brak zdjęcia
Картина недоступна

FRONT BEARING 21 593224
REAR BEARING 22 590619
BRUSH HOLDER 09 503025
SEP:SEPARATED REGULATOR -INC:BUILT-IN REGULATOR 02 505037
RECTIFIER OR DIODE BRIDGE ASSEMBLY 07 501096
FAN 12 592673
REAR BEARING 22 592857
ROTOR 04 512005
STATOR 05 592625
Valeo 523071

2940772	55	1	2V
14	↻		Ø 81

Picture not available
Image non disponible
Imagen no disponible
Imagine non disponibile
Nicht verfügbares Bild
Brak zdjęcia
Картина недоступна

Picture not available
Image non disponible
Imagen no disponible
Imagine non disponibile
Nicht verfügbares Bild
Brak zdjęcia
Картина недоступна

BRUSH HOLDER 09 503019
SEP:SEPARATED REGULATOR -INC:BUILT-IN REGULATOR 02 494495
PULLEY 11 593380
REAR BEARING 22 592857
ROTOR 04 512039
Valeo 2940772

2940776	55	1	
28	↻		

Picture not available
Image non disponible
Imagen no disponible
Imagine non disponibile
Nicht verfügbares Bild
Brak zdjęcia
Картина недоступна

Picture not available
Image non disponible
Imagen no disponible
Imagine non disponibile
Nicht verfügbares Bild
Brak zdjęcia
Картина недоступна

BRUSH HOLDER 09 503019
SEP:SEPARATED REGULATOR -INC:BUILT-IN REGULATOR 02 494498
FAN 12 592088
REAR BEARING 22 592857
Valeo 2523162/436415

2940778	55	1	2V
28	↻		Ø 88

Picture not available
Image non disponible
Imagen no disponible
Imagine non disponibile
Nicht verfügbares Bild
Brak zdjęcia
Картина недоступна

Picture not available
Image non disponible
Imagen no disponible
Imagine non disponibile
Nicht verfügbares Bild
Brak zdjęcia
Картина недоступна

BRUSH HOLDER 09 503019
RECTIFIER OR DIODE BRIDGE ASSEMBLY 07 501118
FAN 12 592088
REAR BEARING 22 592857

2940778	55	1	2V
28	↻		Ø 88

Picture not available
Image non disponible
Imagen no disponible
Imagine non disponibile
Nicht verfügbares Bild
Brak zdjęcia
Картина недоступна

Picture not available
Image non disponible
Imagen no disponible
Imagine non disponibile
Nicht verfügbares Bild
Brak zdjęcia
Картина недоступна

BRUSH HOLDER 09 503019
RECTIFIER OR DIODE BRIDGE ASSEMBLY 07 501118
FAN 12 592088
REAR BEARING 22 592857
Valeo 523161/436588

2940780	55	1	SP
28	↻		

Picture not available
Image non disponible
Imagen no disponible
Imagine non disponibile
Nicht verfügbares Bild
Brak zdjęcia
Картина недоступна

Picture not available
Image non disponible
Imagen no disponible
Imagine non disponibile
Nicht verfügbares Bild
Brak zdjęcia
Картина недоступна

BRUSH HOLDER 09 503019
RECTIFIER OR DIODE BRIDGE ASSEMBLY 07 501118
FAN 12 590553
REAR BEARING 22 592857
Valeo 523159

2940782	65	1	SP
14	↻		INC



BRUSH HOLDER 09 503019
SEP:SEPARATED REGULATOR -INC:BUILT-IN REGULATOR 02 494495
REAR BEARING 22 592857
ROTOR 04 512005
STATOR 05 592625
Valeo 433052/436127

2940793

70

1

SP

14



Picture not available
Image non disponible
Imagen no disponible
Immagine non disponibile
Nicht verfügbares Bild
Brak zdjęcia
Картина недоступна

Picture not available
Image non disponible
Imagen no disponible
Immagine non disponibile
Nicht verfügbares Bild
Brak zdjęcia
Картина недоступна

BRUSH HOLDER 09

503019

RECTIFIER OR DIODE BRIDGE ASSEMBLY 07

501118

FAN 12

590553

REAR BEARING 22

592857

ROTOR 04

512005

STATOR 05

592625

Valeo**523158/436425****2940813**

35

1

1V

14



Ø 52

Picture not available
Image non disponible
Imagen no disponible
Immagine non disponibile
Nicht verfügbares Bild
Brak zdjęcia
Картина недоступна

Picture not available
Image non disponible
Imagen no disponible
Immagine non disponibile
Nicht verfügbares Bild
Brak zdjęcia
Картина недоступна

REAR BEARING 22

590619

BRUSH HOLDER 09

503017

RECTIFIER OR DIODE BRIDGE ASSEMBLY 07

501026

FAN 12

*507067

ROTOR 04

512031

Valeo**2523163****2940861**

33

1

1V

14



Ø 71

Picture not available
Image non disponible
Imagen no disponible
Immagine non disponibile
Nicht verfügbares Bild
Brak zdjęcia
Картина недоступна

Picture not available
Image non disponible
Imagen no disponible
Immagine non disponibile
Nicht verfügbares Bild
Brak zdjęcia
Картина недоступна

BRUSH HOLDER 09

494487

SEP:SEPARATED REGULATOR -INC:BUILT-IN REGULATOR 02505032**REAR BEARING** 22

592857

Valeo**2523166****2940926**

40

1

1V

28



Ø 71

Picture not available
Image non disponible
Imagen no disponible
Immagine non disponibile
Nicht verfügbares Bild
Brak zdjęcia
Картина недоступна

Picture not available
Image non disponible
Imagen no disponible
Immagine non disponibile
Nicht verfügbares Bild
Brak zdjęcia
Картина недоступна

BRUSH HOLDER 09

503025

SEP:SEPARATED REGULATOR -INC:BUILT-IN REGULATOR 02505094**FAN** 12

592088

REAR BEARING 22

592857

Valeo**2523158****2941097**

40

1

1V

14



Ø 59,7

INC

**REAR BEARING** 22

590619

BRUSH SET 09a

300821

SEP:SEPARATED REGULATOR -INC:BUILT-IN REGULATOR 02523345**RECTIFIER OR DIODE BRIDGE ASSEMBLY** 07

501026

FAN 12

*507067

ROTOR 04

512031

2941097

40

1

1V

14



Ø 59,7

INC

**REAR BEARING** 22

590619

BRUSH SET 09a

300821

SEP:SEPARATED REGULATOR -INC:BUILT-IN REGULATOR 02523345**RECTIFIER OR DIODE BRIDGE ASSEMBLY** 07

501026

FAN 12

*507067

ROTOR 04

512031

Valeo**433036/433354****2941231**

45

2

1V

14



Ø 61

Picture not available
Image non disponible
Imagen no disponible
Immagine non disponibile
Nicht verfügbares Bild
Brak zdjęcia
Картина недоступна

Picture not available
Image non disponible
Imagen no disponible
Immagine non disponibile
Nicht verfügbares Bild
Brak zdjęcia
Картина недоступна

BRUSH HOLDER 09

494487

SEP:SEPARATED REGULATOR -INC:BUILT-IN REGULATOR 02505032**RECTIFIER OR DIODE BRIDGE ASSEMBLY** 07

494476

REAR BEARING 22

592857

ROTOR 04

512031

Valeo**433068****2941232**

70

2

1V

14



Ø 66

Picture not available
Image non disponible
Imagen no disponible
Immagine non disponibile
Nicht verfügbares Bild
Brak zdjęcia
Картина недоступна

Picture not available
Image non disponible
Imagen no disponible
Immagine non disponibile
Nicht verfügbares Bild
Brak zdjęcia
Картина недоступна

REAR BEARING 22

590619

SEP:SEPARATED REGULATOR -INC:BUILT-IN REGULATOR 02523345**PULLEY** 11

096879

REAR BRACKET 25

592680

ROTOR 04

*2523191

STATOR 05

592625

Valeo**433037/436327**

2941253

65

1

1V

14



Ø 61

Picture not available
Image non disponible
Imagen no disponible
Immagine non disponibile
Nicht verfügbares Bild
Brak zdjęcia
Картина недоступна

Picture not available
Image non disponible
Imagen no disponible
Immagine non disponibile
Nicht verfügbares Bild
Brak zdjęcia
Картина недоступна

REAR BEARING 22

590619

BRUSH HOLDER 09

503001

FAN 12

592088

PULLEY 11

523335

ROTOR 04

512005

STATOR 05

592625

Valeo**433137/436315****2941388**

65

1

14



Picture not available
Image non disponible
Imagen no disponible
Immagine non disponibile
Nicht verfügbares Bild
Brak zdjęcia
Картина недоступна

Picture not available
Image non disponible
Imagen no disponible
Immagine non disponibile
Nicht verfügbares Bild
Brak zdjęcia
Картина недоступна

REAR BEARING 22

590619

BRUSH HOLDER 09

503020

SEP:SEPARATED REGULATOR -INC:BUILT-IN REGULATOR 02 494495

592088

FAN 12

523335

PULLEY 11

523100

PROTECTION COVER 24

512039

ROTOR 04

592625

STATOR 05**433065****Valeo****2941447**

35

1

2V

14



30°

Ø 70

Picture not available
Image non disponible
Imagen no disponible
Immagine non disponibile
Nicht verfügbares Bild
Brak zdjęcia
Картина недоступна

Picture not available
Image non disponible
Imagen no disponible
Immagine non disponibile
Nicht verfügbares Bild
Brak zdjęcia
Картина недоступна

BRUSH HOLDER 09

494487

RECTIFIER OR DIODE BRIDGE ASSEMBLY 07

494476

FAN 12

592088

REAR BEARING 22

592857

Valeo**433477****514011ABC**

37

2

1V

14



Ø 70

INC

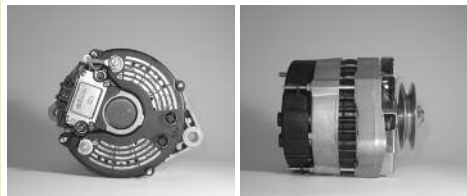
**BRUSH HOLDER** 09

581216

Valeo**432749/433407****516044A**

60

2

4V

14



Ø 71,16

INC

**BRUSH HOLDER** 09

581216

516044A

60

2

4V

14



Ø 71,16

INC

**BRUSH HOLDER** 09

581216

Valeo**432763/433445****516058A**

50

1

1V

14



Ø 59,7

INC

**BRUSH HOLDER** 09

581216

Valeo**432726/433442****71651802**

50

1

1V

14



Ø 66,8

INC

**RECTIFIER OR DIODE BRIDGE ASSEMBLY** 07

105135

Valeo**432736/433411****9AL2502K**

55

2

1V

14



Ø 59,7

Picture not available
Image non disponible
Imagen no disponible
Immagine non disponibile
Nicht verfügbares Bild
Brak zdjęcia
Картина недоступна

Picture not available
Image non disponible
Imagen no disponible
Immagine non disponibile
Nicht verfügbares Bild
Brak zdjęcia
Картина недоступна

BRUSH HOLDER 09

494487

REAR BEARING 22

592857

PROTECTION COVER 24

494507

ROTOR 04

512039

Valeo**432808**

9AL2505P

70

2

1V

14



Ø 59,7

Picture not available
Image non disponible
Imagen no disponible
Immagine non disponibile
Nicht verfügbares Bild
Brak zdjęćia
Картина недоступна

Picture not available
Image non disponible
Imagen no disponible
Immagine non disponibile
Nicht verfügbares Bild
Brak zdjęćia
Картина недоступна

BRUSH HOLDER 09

503006

REAR BEARING 22

592857

PROTECTION COVER 24

494507

ROTOR 04

512005

STATOR 05

592625

Valeo**432808****9AL2507G**

40

1

1V

14



Ø 93

Picture not available
Image non disponible
Imagen no disponible
Immagine non disponibile
Nicht verfügbares Bild
Brak zdjęćia
Картина недоступна

Picture not available
Image non disponible
Imagen no disponible
Immagine non disponibile
Nicht verfügbares Bild
Brak zdjęćia
Картина недоступна

BRUSH HOLDER 09

503006

RECTIFIER OR DIODE BRIDGE ASSEMBLY 07

592554

REAR BEARING 22

592857

PROTECTION COVER 24

494507

ROTOR 04

512009

STATOR 05

592625

Valeo**433397****9AL2538K**

50

2

1V

14



Ø 69,6

Picture not available
Image non disponible
Imagen no disponible
Immagine non disponibile
Nicht verfügbares Bild
Brak zdjęćia
Картина недоступна

Picture not available
Image non disponible
Imagen no disponible
Immagine non disponibile
Nicht verfügbares Bild
Brak zdjęćia
Картина недоступна

BRUSH HOLDER 09

503006

REAR BEARING 22

592857

PROTECTION COVER 24

494507

Valeo**432728****9AL2540G**

40

1

1V

14



42°

Ø 70

INC

Picture not available
Image non disponible
Imagen no disponible
Immagine non disponibile
Nicht verfügbares Bild
Brak zdjęćia
Картина недоступна

Picture not available
Image non disponible
Imagen no disponible
Immagine non disponibile
Nicht verfügbares Bild
Brak zdjęćia
Картина недоступна

BRUSH HOLDER 09

503006

RECTIFIER OR DIODE BRIDGE ASSEMBLY 07

592554

REAR BEARING 22

592857

PROTECTION COVER 24

494507

ROTOR 04

512013

STATOR 05

592625

Valeo**432747/433404****9AL2546G**

40

1

1V

14



42°

Ø 70

INC

Picture not available
Image non disponible
Imagen no disponible
Immagine non disponibile
Nicht verfügbares Bild
Brak zdjęćia
Картина недоступна

Picture not available
Image non disponible
Imagen no disponible
Immagine non disponibile
Nicht verfügbares Bild
Brak zdjęćia
Картина недоступна

BRUSH HOLDER 09

503006

REAR BEARING 22

592857

PROTECTION COVER 24

494507

ROTOR 04

512013

STATOR 05

592625

Valeo**432747/433404****9AL2559G**

45

2

1V

14



Ø 70

Picture not available
Image non disponible
Imagen no disponible
Immagine non disponibile
Nicht verfügbares Bild
Brak zdjęćia
Картина недоступна

Picture not available
Image non disponible
Imagen no disponible
Immagine non disponibile
Nicht verfügbares Bild
Brak zdjęćia
Картина недоступна

BRUSH HOLDER 09

503006

REAR BEARING 22

592857

PROTECTION COVER 24

494507

STATOR 05

592625

Valeo**510051****9AL2560G**

45

2

14



Picture not available
Image non disponible
Imagen no disponible
Immagine non disponibile
Nicht verfügbares Bild
Brak zdjęćia
Картина недоступна

Picture not available
Image non disponible
Imagen no disponible
Immagine non disponibile
Nicht verfügbares Bild
Brak zdjęćia
Картина недоступна

BRUSH HOLDER 09

503006

RECTIFIER OR DIODE BRIDGE ASSEMBLY 07

592554

REAR BEARING 22

592857

PROTECTION COVER 24

494507

STATOR 05

592625

Valeo**510052****9AL2572K**

50

2

1V

14



70°

Ø 60

INC

**BRUSH HOLDER** 09

503006

REAR BEARING 22

592857

PROTECTION COVER 24

494507

Valeo**432735/433414**

9AL2576G	40	1	1V
14		42°	Ø 70 INC

Picture not available
Image non disponible
Imagen no disponible
Immagine non disponibile
Nicht verfügbares Bild
Brak zdjęcia
Картина недоступна

Picture not available
Image non disponible
Imagen no disponible
Immagine non disponibile
Nicht verfügbares Bild
Brak zdjęcia
Картина недоступна

BRUSH HOLDER 09 503006
REAR BEARING 22 592857
PROTECTION COVER 24 494507
ROTOR 04 512013
STATOR 05 592625
Valeo 432747/433404

9AL2577G	45	2	1V
14		20°	Ø 69,7

Picture not available
Image non disponible
Imagen no disponible
Immagine non disponibile
Nicht verfügbares Bild
Brak zdjęcia
Картина недоступна

Picture not available
Image non disponible
Imagen no disponible
Immagine non disponibile
Nicht verfügbares Bild
Brak zdjęcia
Картина недоступна

BRUSH HOLDER 09 503006
REAR BEARING 22 592857
PROTECTION COVER 24 494507
STATOR 05 592625
Valeo 510068/436356

9AL2578G	45	2	2V
14		20°	Ø 70

Picture not available
Image non disponible
Imagen no disponible
Immagine non disponibile
Nicht verfügbares Bild
Brak zdjęcia
Картина недоступна

Picture not available
Image non disponible
Imagen no disponible
Immagine non disponibile
Nicht verfügbares Bild
Brak zdjęcia
Картина недоступна

BRUSH HOLDER 09 503006
RECTIFIER OR DIODE BRIDGE ASSEMBLY 07 501118
REAR BEARING 22 592857
STATOR 05 592625
Valeo 105111/436354

9AL2579G	45	2	2V
14		2°	Ø 76

Picture not available
Image non disponible
Imagen no disponible
Immagine non disponibile
Nicht verfügbares Bild
Brak zdjęcia
Картина недоступна

Picture not available
Image non disponible
Imagen no disponible
Immagine non disponibile
Nicht verfügbares Bild
Brak zdjęcia
Картина недоступна

BRUSH HOLDER 09 503006
RECTIFIER OR DIODE BRIDGE ASSEMBLY 07 501118
REAR BEARING 22 592857
STATOR 05 592625
Valeo 105111/436354

9AL2582K	50	2	1V
14			Ø 66

Picture not available
Image non disponible
Imagen no disponible
Immagine non disponibile
Nicht verfügbares Bild
Brak zdjęcia
Картина недоступна

Picture not available
Image non disponible
Imagen no disponible
Immagine non disponibile
Nicht verfügbares Bild
Brak zdjęcia
Картина недоступна

BRUSH HOLDER 09 503006
RECTIFIER OR DIODE BRIDGE ASSEMBLY 07 592554
REAR BEARING 22 592857
PROTECTION COVER 24 494507
Valeo 432715

9AL2583K	50	2	1V
14		20°	Ø 60 SEP



BRUSH HOLDER 09 503006
REAR BEARING 22 592857
PROTECTION COVER 24 494507
Valeo 433436

9AL2585G	45	2	
14			

Picture not available
Image non disponible
Imagen no disponible
Immagine non disponibile
Nicht verfügbares Bild
Brak zdjęcia
Картина недоступна

Picture not available
Image non disponible
Imagen no disponible
Immagine non disponibile
Nicht verfügbares Bild
Brak zdjęcia
Картина недоступна

BRUSH HOLDER 09 503006
RECTIFIER OR DIODE BRIDGE ASSEMBLY 07 501118
REAR BEARING 22 592857
STATOR 05 592625
Valeo 510076

9AL2589K	50	1	1V
14			Ø 60

Picture not available
Image non disponible
Imagen no disponible
Immagine non disponibile
Nicht verfügbares Bild
Brak zdjęcia
Картина недоступна

Picture not available
Image non disponible
Imagen no disponible
Immagine non disponibile
Nicht verfügbares Bild
Brak zdjęcia
Картина недоступна

BRUSH HOLDER 09 503006
REAR BEARING 22 592857
PROTECTION COVER 24 494507
Valeo 432735

9AL2590K

50

1

1V

14



Ø 69,7

Picture not available
Image non disponible
Imagen no disponible
Immagine non disponibile
Nicht verfügbares Bild
Brak zdjęcia
Картина недоступна

Picture not available
Image non disponible
Imagen no disponible
Immagine non disponibile
Nicht verfügbares Bild
Brak zdjęcia
Картина недоступна

BRUSH HOLDER 09

503006

REAR BEARING 22

592857

PROTECTION COVER 24

494507

Valeo**432803/433423****9AL2591K**

50

1

1V

14



60°

Ø 60

INC

**BRUSH HOLDER** 09

503006

REAR BEARING 22

592857

PROTECTION COVER 24

494507

Valeo**432724/433429****9AL2592K**

50

1

1V

14



20°

Ø 66

SEP

**BRUSH HOLDER** 09

503006

REAR BEARING 22

592857

PROTECTION COVER 24

494507

Valeo**432715/433392****9AL2593K**

50

1

1V

14



20°

Ø 69,7

INC

**BRUSH HOLDER** 09

503006

REAR BEARING 22

592857

PROTECTION COVER 24

494507

Valeo**432749/433407****9AL2600G**

40

1

14



Picture not available
Image non disponible
Imagen no disponible
Immagine non disponibile
Nicht verfügbares Bild
Brak zdjęcia
Картина недоступна

Picture not available
Image non disponible
Imagen no disponible
Immagine non disponibile
Nicht verfügbares Bild
Brak zdjęcia
Картина недоступна

BRUSH HOLDER 09

503006

REAR BEARING 22

592857

PROTECTION COVER 24

494507

ROTOR 04

512013

STATOR 05

592625

Valeo**432982/436262****9AL2607P**

70

2

1V

14



Ø 59,7

Picture not available
Image non disponible
Imagen no disponible
Immagine non disponibile
Nicht verfügbares Bild
Brak zdjęcia
Картина недоступна

Picture not available
Image non disponible
Imagen no disponible
Immagine non disponibile
Nicht verfügbares Bild
Brak zdjęcia
Картина недоступна

BRUSH HOLDER 09

503006

RECTIFIER OR DIODE BRIDGE ASSEMBLY 07

592554

FAN 12

592088

REAR BEARING 22

592857

PROTECTION COVER 24

494507

ROTOR 04

512005

STATOR 05

592625

Valeo**432821****9AL2615G**

45

1

1V

14



60°

Ø 66

SEP

**BRUSH HOLDER** 09

494488

PULLEY 11

096879

REAR BEARING 22

592857

ROTOR 04

512013

STATOR 05

592625

Valeo**432700/436100****9AL2616K**

50

2

1V

14



Ø 59,7

Picture not available
Image non disponible
Imagen no disponible
Immagine non disponibile
Nicht verfügbares Bild
Brak zdjęcia
Картина недоступна

Picture not available
Image non disponible
Imagen no disponible
Immagine non disponibile
Nicht verfügbares Bild
Brak zdjęcia
Картина недоступна

BRUSH HOLDER 09

503006

RECTIFIER OR DIODE BRIDGE ASSEMBLY 07

501118

REAR BEARING 22

592857

Valeo**432771/433427**

9AL2617K 50 1 1V

14 ↻ 40° ∇ Ø 59,7 SEP

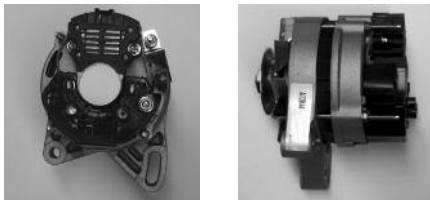

BRUSH HOLDER 📏09 503006
RECTIFIER OR DIODE BRIDGE ASSEMBLY 📏07 592554
REAR BEARING 📏22 592857
PROTECTION COVER 📏24 494507
Valeo 433384

9AL2618G 45 1 1V

14 ↻ Ø 59,7

Picture not available
 Image non disponible
 Imagen no disponible
 Immagine non disponibile
 Nicht verfügbares Bild
 Brak zdjęcia
 Картина недоступна

Picture not available
 Image non disponible
 Imagen no disponible
 Immagine non disponibile
 Nicht verfügbares Bild
 Brak zdjęcia
 Картина недоступна

BRUSH HOLDER 📏09 494488
RECTIFIER OR DIODE BRIDGE ASSEMBLY 📏07 501118
REAR BEARING 📏22 592857
ROTOR 📏04 512039
Valeo 432823/436164

9AL2628P 70 2 1V

14 ↻ 55° ∇ Ø 66 INC



BRUSH HOLDER 📏09 503006
PULLEY 📏11 096879
REAR BEARING 📏22 592857
PROTECTION COVER 📏24 494507
ROTOR 📏04 512005
STATOR 📏05 592625
Valeo 432808/433368

9AL2633G 40 1 1V

14 ↻ 42° ∇ Ø 70 INC

Picture not available
 Image non disponible
 Imagen no disponible
 Immagine non disponibile
 Nicht verfügbares Bild
 Brak zdjęcia
 Картина недоступна

Picture not available
 Image non disponible
 Imagen no disponible
 Immagine non disponibile
 Nicht verfügbares Bild
 Brak zdjęcia
 Картина недоступна

BRUSH HOLDER 📏09 503007
REAR BEARING 📏22 592857
Valeo 432747/433404

9AL2658K 55 1 1V

14 ↻ 20° ∇ Ø 69,7 SEP

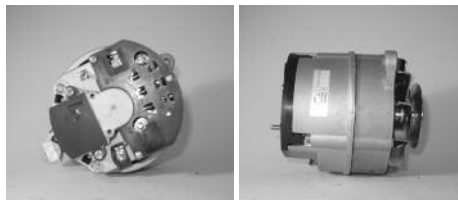

BRUSH HOLDER 📏09 503006
RECTIFIER OR DIODE BRIDGE ASSEMBLY 📏07 592554
REAR BEARING 📏22 592857
Valeo 432827/436305

9AL2666F 35 1 1V

14 ↻ 45° ∇ Ø 66 INC

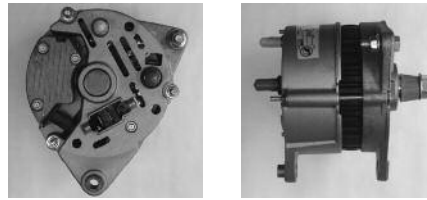

BRUSH HOLDER 📏09 503007
REAR BEARING 📏22 592857
ROTOR 📏04 512031
Valeo 433416

9AL2679K 50 1 1V

14 ↻ 20° ∇ Ø 66 SEP



BRUSH HOLDER 📏09 503006
RECTIFIER OR DIODE BRIDGE ASSEMBLY 📏07 592554
REAR BEARING 📏22 592857
PROTECTION COVER 📏24 494507
Valeo 432715/433392

9AL2685K 50 1 1V

14 ↻ 20° ∇ Ø 66 SEP

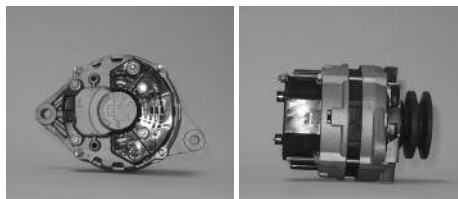

BRUSH HOLDER 📏09 503006
RECTIFIER OR DIODE BRIDGE ASSEMBLY 📏07 592554
REAR BEARING 📏22 592857
PROTECTION COVER 📏24 494507
Valeo 432714/433395

9AL2688K

55

1

1V

14



Ø 56

Picture not available
Image non disponible
Imagen no disponible
Immagine non disponibile
Nicht verfügbares Bild
Brak zdjęć
Картина недоступна

Picture not available
Image non disponible
Imagen no disponible
Immagine non disponibile
Nicht verfügbares Bild
Brak zdjęć
Картина недоступна

BRUSH HOLDER 09

494488

REAR BEARING 22

592857

ROTOR 04

512039

Valeo**432832/436186****9AL2689K**

55

1

1V

14



60°

Ø 56

Picture not available
Image non disponible
Imagen no disponible
Immagine non disponibile
Nicht verfügbares Bild
Brak zdjęć
Картина недоступна

Picture not available
Image non disponible
Imagen no disponible
Immagine non disponibile
Nicht verfügbares Bild
Brak zdjęć
Картина недоступна

BRUSH HOLDER 09

494488

REAR BEARING 22

592857

ROTOR 04

512039

Valeo**436170****9AL2696G**

40

1

1V

14



60°

Ø 55,4

SEP

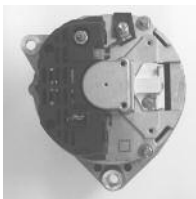
**REAR BEARING** 22

590619

BRUSH HOLDER 09

503007

RECTIFIER OR DIODE BRIDGE ASSEMBLY 07

501026

Valeo**432834/433351****9AL2762G**

40

1

1V

14



30°

Ø 55,4

SEP

**REAR BEARING** 22

590619

BRUSH HOLDER 09

503007

RECTIFIER OR DIODE BRIDGE ASSEMBLY 07

501026

Valeo**433359****9AL2765G**

40

1

1V

14



50°

Ø 56

SEP

**BRUSH HOLDER** 09

503007

REAR BEARING 22

592857

Valeo**432848/433408****9AL2767P**

70

1

1V

14



Ø 60

Picture not available
Image non disponible
Imagen no disponible
Immagine non disponibile
Nicht verfügbares Bild
Brak zdjęć
Картина недоступна

Picture not available
Image non disponible
Imagen no disponible
Immagine non disponibile
Nicht verfügbares Bild
Brak zdjęć
Картина недоступна

BRUSH HOLDER 09

503006

RECTIFIER OR DIODE BRIDGE ASSEMBLY 07

501118

REAR BEARING 22

592857

ROTOR 04

512005

STATOR 05

592625

Valeo**432839****9AL2768G**

45

1

1V

14



Ø 69,7

Picture not available
Image non disponible
Imagen no disponible
Immagine non disponibile
Nicht verfügbares Bild
Brak zdjęć
Картина недоступна

Picture not available
Image non disponible
Imagen no disponible
Immagine non disponibile
Nicht verfügbares Bild
Brak zdjęć
Картина недоступна

BRUSH HOLDER 09

503006

RECTIFIER OR DIODE BRIDGE ASSEMBLY 07

501118

REAR BEARING 22

592857

ROTOR 04

512013

Valeo**432773/433373****9AL2774G**

40

1

1V

14



Ø 59,7

INC

**BRUSH HOLDER** 09

503007

REAR BEARING 22

592857

Valeo**432855/433387**

9AL2788K

50

2

1V

14



Ø 55,4

Picture not available
Image non disponible
Imagen no disponible
Immagine non disponibile
Nicht verfügbares Bild
Brak zdjęcia
Картина недоступна

Picture not available
Image non disponible
Imagen no disponible
Immagine non disponibile
Nicht verfügbares Bild
Brak zdjęcia
Картина недоступна

BRUSH HOLDER 09

503006

RECTIFIER OR DIODE BRIDGE ASSEMBLY 07

501118

REAR BEARING 22

592857

Valeo**432736****9AL2793P**

70

1

1V

14



Ø 66

Picture not available
Image non disponible
Imagen no disponible
Immagine non disponibile
Nicht verfügbares Bild
Brak zdjęcia
Картина недоступна

Picture not available
Image non disponible
Imagen no disponible
Immagine non disponibile
Nicht verfügbares Bild
Brak zdjęcia
Картина недоступна

BRUSH HOLDER 09

503006

RECTIFIER OR DIODE BRIDGE ASSEMBLY 07

592554

FAN 12

592088

REAR BEARING 22

592857

PROTECTION COVER 24

494507

ROTOR 04

512005

STATOR 05

592625

Valeo**510244****9AL2800G**

45

1

1V

14



Ø 83,7

Picture not available
Image non disponible
Imagen no disponible
Immagine non disponibile
Nicht verfügbares Bild
Brak zdjęcia
Картина недоступна

Picture not available
Image non disponible
Imagen no disponible
Immagine non disponibile
Nicht verfügbares Bild
Brak zdjęcia
Картина недоступна

BRUSH HOLDER 09

503006

RECTIFIER OR DIODE BRIDGE ASSEMBLY 07

592554

REAR BEARING 22

592857

PROTECTION COVER 24

494507

ROTOR 04

512039

Valeo**432996****9AL2817G**

40

1

1V

14



Ø 55,4

Picture not available
Image non disponible
Imagen no disponible
Immagine non disponibile
Nicht verfügbares Bild
Brak zdjęcia
Картина недоступна

Picture not available
Image non disponible
Imagen no disponible
Immagine non disponibile
Nicht verfügbares Bild
Brak zdjęcia
Картина недоступна

BRUSH HOLDER 09

503007

REAR BEARING 22

592857

Valeo**432844****9AL2826K**

50

1

1V

14



0°

Ø 69,7

Picture not available
Image non disponible
Imagen no disponible
Immagine non disponibile
Nicht verfügbares Bild
Brak zdjęcia
Картина недоступна

Picture not available
Image non disponible
Imagen no disponible
Immagine non disponibile
Nicht verfügbares Bild
Brak zdjęcia
Картина недоступна

BRUSH HOLDER 09

503006

RECTIFIER OR DIODE BRIDGE ASSEMBLY 07

592554

REAR BEARING 22

592857

PROTECTION COVER 24

494507

Valeo**432973/433471****9AL2834K**

55

1

14



Picture not available
Image non disponible
Imagen no disponible
Immagine non disponibile
Nicht verfügbares Bild
Brak zdjęcia
Картина недоступна

Picture not available
Image non disponible
Imagen no disponible
Immagine non disponibile
Nicht verfügbares Bild
Brak zdjęcia
Картина недоступна

BRUSH HOLDER 09

494488

REAR BEARING 22

592857

ROTOR 04

512005

Valeo**432847****9AL2924K**

55

1

14



Picture not available
Image non disponible
Imagen no disponible
Immagine non disponibile
Nicht verfügbares Bild
Brak zdjęcia
Картина недоступна

Picture not available
Image non disponible
Imagen no disponible
Immagine non disponibile
Nicht verfügbares Bild
Brak zdjęcia
Картина недоступна

BRUSH HOLDER 09

494488

RECTIFIER OR DIODE BRIDGE ASSEMBLY 07

501118

REAR BEARING 22

592857

ROTOR 04

512005

Valeo**510369/436430****9AL2969F**

35

1

14



Picture not available
Image non disponible
Imagen no disponible
Immagine non disponibile
Nicht verfügbares Bild
Brak zdjęcia
Картина недоступна

Picture not available
Image non disponible
Imagen no disponible
Immagine non disponibile
Nicht verfügbares Bild
Brak zdjęcia
Картина недоступна

BRUSH HOLDER 09

494487

REAR BEARING 22

592857

Valeo**432994/436268**

9AL3544G

40

1

1V

28



Ø 69,7

Picture not available
Image non disponible
Imagen no disponible
Immagine non disponibile
Nicht verfügbares Bild
Brak zdjęć
Картина недоступна

Picture not available
Image non disponible
Imagen no disponible
Immagine non disponibile
Nicht verfügbares Bild
Brak zdjęć
Картина недоступна

BRUSH HOLDER 09

494493

RECTIFIER OR DIODE BRIDGE ASSEMBLY 07

592554

FAN 12

592088

REAR BEARING 22

592857

PROTECTION COVER 24

494507

ROTOR 04

512013

Valeo**510037****9AL3580G**

40

2

2V

28



20°

Ø 76

Picture not available
Image non disponible
Imagen no disponible
Immagine non disponibile
Nicht verfügbares Bild
Brak zdjęć
Картина недоступна

Picture not available
Image non disponible
Imagen no disponible
Immagine non disponibile
Nicht verfügbares Bild
Brak zdjęć
Картина недоступна

BRUSH HOLDER 09

503006

RECTIFIER OR DIODE BRIDGE ASSEMBLY 07

501118

FAN 12

592088

REAR BEARING 22

592857

Valeo**105112/436353****9AL3581G**

40

2

2V

28



Ø 70

Picture not available
Image non disponible
Imagen no disponible
Immagine non disponibile
Nicht verfügbares Bild
Brak zdjęć
Картина недоступна

Picture not available
Image non disponible
Imagen no disponible
Immagine non disponibile
Nicht verfügbares Bild
Brak zdjęć
Картина недоступна

BRUSH HOLDER 09

503006

RECTIFIER OR DIODE BRIDGE ASSEMBLY 07

501118

FAN 12

592088

REAR BEARING 22

592857

Valeo**105112/436353****9AL3586G**

40

2

28



Picture not available
Image non disponible
Imagen no disponible
Immagine non disponibile
Nicht verfügbares Bild
Brak zdjęć
Картина недоступна

Picture not available
Image non disponible
Imagen no disponible
Immagine non disponibile
Nicht verfügbares Bild
Brak zdjęć
Картина недоступна

BRUSH HOLDER 09

503006

RECTIFIER OR DIODE BRIDGE ASSEMBLY 07

501118

FAN 12

592088

REAR BEARING 22

592857

Valeo**510077/436353****9AL3776G**

45

2

2V

28



0°

Ø 81

Picture not available
Image non disponible
Imagen no disponible
Immagine non disponibile
Nicht verfügbares Bild
Brak zdjęć
Картина недоступна

Picture not available
Image non disponible
Imagen no disponible
Immagine non disponibile
Nicht verfügbares Bild
Brak zdjęć
Картина недоступна

BRUSH HOLDER 09

503006

RECTIFIER OR DIODE BRIDGE ASSEMBLY 07

501118

FAN 12

592088

PULLEY 11

593380

REAR BEARING 22

592857

Valeo**510227/436436****9AL3911G**

45

1

1V

28



Ø 66

Picture not available
Image non disponible
Imagen no disponible
Immagine non disponibile
Nicht verfügbares Bild
Brak zdjęć
Картина недоступна

Picture not available
Image non disponible
Imagen no disponible
Immagine non disponibile
Nicht verfügbares Bild
Brak zdjęć
Картина недоступна

BRUSH HOLDER 09

494493

PULLEY 11

096879

REAR BEARING 22

592857

PROTECTION COVER 24

494507

Valeo**510347****9AL3925G**

40

1

SP

28



60°

Picture not available
Image non disponible
Imagen no disponible
Immagine non disponibile
Nicht verfügbares Bild
Brak zdjęć
Картина недоступна

Picture not available
Image non disponible
Imagen no disponible
Immagine non disponibile
Nicht verfügbares Bild
Brak zdjęć
Картина недоступна

BRUSH HOLDER 09

494488

RECTIFIER OR DIODE BRIDGE ASSEMBLY 07

501118

REAR BEARING 22

592857

Valeo**510370/436431****9AL3955G**

40

2

28



Picture not available
Image non disponible
Imagen no disponible
Immagine non disponibile
Nicht verfügbares Bild
Brak zdjęć
Картина недоступна

Picture not available
Image non disponible
Imagen no disponible
Immagine non disponibile
Nicht verfügbares Bild
Brak zdjęć
Картина недоступна

BRUSH HOLDER 09

503019

REAR BEARING 22

592857

PROTECTION COVER 24

494507

Valeo**432990**





9AL3956G

40 2 2V

28  Ø 81

Picture not available
Image non disponible
Imagen no disponible
Immagine non disponibile
Nicht verfügbares Bild
Brak zdjęcia
Картина недоступна

Picture not available
Image non disponible
Imagen no disponible
Immagine non disponibile
Nicht verfügbares Bild
Brak zdjęcia
Картина недоступна

BRUSH HOLDER  09 503019
PULLEY  11 593380
REAR BEARING  22 592857
PROTECTION COVER  24 494507
Valeo **510393**





9AL3986G

40 1 2V

28  Ø 81

Picture not available
Image non disponible
Imagen no disponible
Immagine non disponibile
Nicht verfügbares Bild
Brak zdjęcia
Картина недоступна

Picture not available
Image non disponible
Imagen no disponible
Immagine non disponibile
Nicht verfügbares Bild
Brak zdjęcia
Картина недоступна

BRUSH HOLDER  09 494488
RECTIFIER OR DIODE BRIDGE ASSEMBLY  07 501118
FAN  12 592088
REAR BEARING  22 592857
PROTECTION COVER  24 494507
Valeo **510396**





9AL5002K

55 1

14 

Picture not available
Image non disponible
Imagen no disponible
Immagine non disponibile
Nicht verfügbares Bild
Brak zdjęcia
Картина недоступна

Picture not available
Image non disponible
Imagen no disponible
Immagine non disponibile
Nicht verfügbares Bild
Brak zdjęcia
Картина недоступна

BRUSH HOLDER  09 503019
REAR BEARING  22 592857
PROTECTION COVER  24 494507
ROTOR  04 512039
Valeo **432869/436414**





9AL5004G

45 2

14 

Picture not available
Image non disponible
Imagen no disponible
Immagine non disponibile
Nicht verfügbares Bild
Brak zdjęcia
Картина недоступна

Picture not available
Image non disponible
Imagen no disponible
Immagine non disponibile
Nicht verfügbares Bild
Brak zdjęcia
Картина недоступна

BRUSH HOLDER  09 503019
FAN  12 590553
REAR BEARING  22 592857
PROTECTION COVER  24 494507
ROTOR  04 512009
Valeo **432992/436597**







9AL5009F

35 1 1V

14  Ø 95,2

Picture not available
Image non disponible
Imagen no disponible
Immagine non disponibile
Nicht verfügbares Bild
Brak zdjęcia
Картина недоступна

Picture not available
Image non disponible
Imagen no disponible
Immagine non disponibile
Nicht verfügbares Bild
Brak zdjęcia
Картина недоступна

BRUSH HOLDER  09 503006
RECTIFIER OR DIODE BRIDGE ASSEMBLY  07 592554
REAR BEARING  22 592857
PROTECTION COVER  24 494507
ROTOR  04 512009
STATOR  05 592625
Valeo **432997**

9AL5050K

55 2 1V

14  Ø 66

Picture not available
Image non disponible
Imagen no disponible
Immagine non disponibile
Nicht verfügbares Bild
Brak zdjęcia
Картина недоступна

Picture not available
Image non disponible
Imagen no disponible
Immagine non disponibile
Nicht verfügbares Bild
Brak zdjęcia
Картина недоступна

BRUSH HOLDER  09 503019
FAN  12 590553
REAR BEARING  22 592857
ROTOR  04 512039

9AL5050K

55 2 1V

14  Ø 66

Picture not available
Image non disponible
Imagen no disponible
Immagine non disponibile
Nicht verfügbares Bild
Brak zdjęcia
Картина недоступна

Picture not available
Image non disponible
Imagen no disponible
Immagine non disponibile
Nicht verfügbares Bild
Brak zdjęcia
Картина недоступна

BRUSH HOLDER  09 503019
FAN  12 590553
REAR BEARING  22 592857
ROTOR  04 512039
Valeo **432877/433484**

9AL5051P

70 2 1V

14  Ø 66

Picture not available
Image non disponible
Imagen no disponible
Immagine non disponibile
Nicht verfügbares Bild
Brak zdjęcia
Картина недоступна

Picture not available
Image non disponible
Imagen no disponible
Immagine non disponibile
Nicht verfügbares Bild
Brak zdjęcia
Картина недоступна

BRUSH HOLDER  09 503019
FAN  12 590553
REAR BEARING  22 592857
ROTOR  04 512005
STATOR  05 592625

9AL6011G

40

1

28



Picture not available
Image non disponible
Imagen no disponible
Immagine non disponibile
Nicht verfügbares Bild
Brak zdjęć
Картина недоступна

Picture not available
Image non disponible
Imagen no disponible
Immagine non disponibile
Nicht verfügbares Bild
Brak zdjęć
Картина недоступна

BRUSH HOLDER 09

494488

FAN 12

592088

REAR BEARING 22

592857

PROTECTION COVER 24

494507

Valeo**510426/436419****9AL6027K**

55

2

2V

28



Ø 65

Picture not available
Image non disponible
Imagen no disponible
Immagine non disponibile
Nicht verfügbares Bild
Brak zdjęć
Картина недоступна

Picture not available
Image non disponible
Imagen no disponible
Immagine non disponibile
Nicht verfügbares Bild
Brak zdjęć
Картина недоступна

BRUSH HOLDER 09

494488

REAR BEARING 22

592857

Valeo**510449****9AR2500K**

55

1

1V

14



60°

Ø 66

INC

**BRUSH HOLDER** 09

503019

SEP:SEPARATED REGULATOR -INC:BUILT-IN REGULATOR 02494495**FAN** 12

592088

REAR BEARING 22

592857

ROTOR 04

512039

STATOR 05

592625

Valeo**432853/436189****9AR2501K**

55

1

14



Picture not available
Image non disponible
Imagen no disponible
Immagine non disponibile
Nicht verfügbares Bild
Brak zdjęć
Картина недоступна

Picture not available
Image non disponible
Imagen no disponible
Immagine non disponibile
Nicht verfügbares Bild
Brak zdjęć
Картина недоступна

BRUSH HOLDER 09

494487

SEP:SEPARATED REGULATOR -INC:BUILT-IN REGULATOR 02494495**REAR BEARING** 22

592857

PROTECTION COVER 24

494507

ROTOR 04

512039

Valeo**432983/436263****9AR2506K**

55

1

1V

14



60°

Ø 66

INC

**BRUSH HOLDER** 09

503019

SEP:SEPARATED REGULATOR -INC:BUILT-IN REGULATOR 02494495**REAR BEARING** 22

592857

ROTOR 04

512039

STATOR 05

592625

Valeo**432853/436189****9AR2510K**

55

1

14



Picture not available
Image non disponible
Imagen no disponible
Immagine non disponibile
Nicht verfügbares Bild
Brak zdjęć
Картина недоступна

Picture not available
Image non disponible
Imagen no disponible
Immagine non disponibile
Nicht verfügbares Bild
Brak zdjęć
Картина недоступна

BRUSH HOLDER 09

494487

SEP:SEPARATED REGULATOR -INC:BUILT-IN REGULATOR 02494495**RECTIFIER OR DIODE BRIDGE ASSEMBLY** 07

592554

FAN 12

592088

REAR BEARING 22

592857

PROTECTION COVER 24

494507

ROTOR 04

512039

Valeo**432983/436263****9AR2511F**

35

1

1V

14



60°

Ø 66

INC

**BRUSH HOLDER** 09

494487

SEP:SEPARATED REGULATOR -INC:BUILT-IN REGULATOR 02494495**REAR BEARING** 22

592857

ROTOR 04

512009

STATOR 05

592625

Valeo**432849/436208****9AR2512P**

70

2

1V

14



60°

Ø 77

Picture not available
Image non disponible
Imagen no disponible
Immagine non disponibile
Nicht verfügbares Bild
Brak zdjęć
Картина недоступна

Picture not available
Image non disponible
Imagen no disponible
Immagine non disponibile
Nicht verfügbares Bild
Brak zdjęć
Картина недоступна

BRUSH HOLDER 09

494487

SEP:SEPARATED REGULATOR -INC:BUILT-IN REGULATOR 02494495**FAN** 12

592088

REAR BEARING 22

592857

PROTECTION COVER 24

494507

ROTOR 04

512005

STATOR 05

592625

Valeo**432817**

9AR2513F

35 1

14



Picture not available
Image non disponible
Imagen no disponible
Immagine non disponibile
Nicht verfügbares Bild
Brak zdjęcia
Картина недоступна

Picture not available
Image non disponible
Imagen no disponible
Immagine non disponibile
Nicht verfügbares Bild
Brak zdjęcia
Картина недоступна

BRUSH HOLDER 09 503019
SEP:SEPARATED REGULATOR -INC:BUILT-IN REGULATOR 02494495
RECTIFIER OR DIODE BRIDGE ASSEMBLY 07 592554
REAR BEARING 22 592857
PROTECTION COVER 24 494507
ROTOR 04 512009
STATOR 05 592625
Valeo 432983/436263

9AR2515K

55 1 1V

14



Ø 66

Picture not available
Image non disponible
Imagen no disponible
Immagine non disponibile
Nicht verfügbares Bild
Brak zdjęcia
Картина недоступна

Picture not available
Image non disponible
Imagen no disponible
Immagine non disponibile
Nicht verfügbares Bild
Brak zdjęcia
Картина недоступна

BRUSH HOLDER 09 494487
SEP:SEPARATED REGULATOR -INC:BUILT-IN REGULATOR 02494495
REAR BEARING 22 592857
ROTOR 04 512039
Valeo 432845/*436216

9AR2516F

35 1 1V

14



Ø 66

Picture not available
Image non disponible
Imagen no disponible
Immagine non disponibile
Nicht verfügbares Bild
Brak zdjęcia
Картина недоступна

Picture not available
Image non disponible
Imagen no disponible
Immagine non disponibile
Nicht verfügbares Bild
Brak zdjęcia
Картина недоступна

BRUSH HOLDER 09 494487
SEP:SEPARATED REGULATOR -INC:BUILT-IN REGULATOR 02494495
REAR BEARING 22 592857
ROTOR 04 512009
STATOR 05 592625
Valeo 432845/*436216

9AR2517K

55 1 1V

14



15°

Ø 70

INC



BRUSH HOLDER 09 494487
SEP:SEPARATED REGULATOR -INC:BUILT-IN REGULATOR 02494495
REAR BEARING 22 592857
ROTOR 04 512039
Valeo 432861/436196

9AR2518F

35 1 1V

14



15°

Ø 70

INC

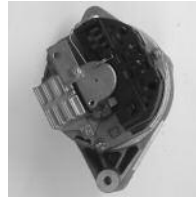

BRUSH HOLDER 09 494487
SEP:SEPARATED REGULATOR -INC:BUILT-IN REGULATOR 02494495
REAR BEARING 22 592857
ROTOR 04 512009
STATOR 05 592625
Valeo 432859/436194

9AR2519F

35 1 1V

14



60°

Ø 61

INC

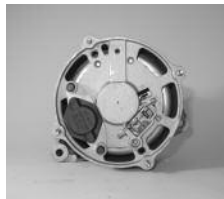

BRUSH HOLDER 09 494487
SEP:SEPARATED REGULATOR -INC:BUILT-IN REGULATOR 02494495
REAR BEARING 22 592857
ROTOR 04 512009
STATOR 05 592625
Valeo 432849/436208

9AR2520K

55 1 1V

14



60°

Ø 61

INC

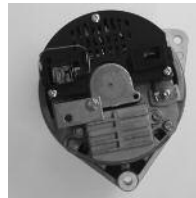

BRUSH HOLDER 09 503019
SEP:SEPARATED REGULATOR -INC:BUILT-IN REGULATOR 02494495
REAR BEARING 22 592857
ROTOR 04 512039
STATOR 05 592625
Valeo 432853/436189

9AR2524F

35 1 1V

14



60°

Ø 66

INC

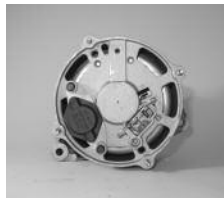

BRUSH HOLDER 09 494487
SEP:SEPARATED REGULATOR -INC:BUILT-IN REGULATOR 02494495
REAR BEARING 22 592857
ROTOR 04 512009
STATOR 05 592625
Valeo 432849/436208

9AR2526F

35

1

1V

14



Ø 66

Picture not available
Image non disponible
Imagen no disponible
Immagine non disponibile
Nicht verfügbares Bild
Brak zdjęć
Картина недоступна

Picture not available
Image non disponible
Imagen no disponible
Immagine non disponibile
Nicht verfügbares Bild
Brak zdjęć
Картина недоступна

BRUSH HOLDER 09

494487

SEP:SEPARATED REGULATOR -INC:BUILT-IN REGULATOR 02494495**REAR BEARING** 22

592857

ROTOR 04

512009

STATOR 05

592625

Valeo

432845/*436216

9AR2527K

55

1

1V

14



15°

Ø 70

INC

**BRUSH HOLDER** 09

494487

SEP:SEPARATED REGULATOR -INC:BUILT-IN REGULATOR 02494495**REAR BEARING** 22

592857

ROTOR 04

512039

Valeo

432861/436196

9AR2528F

35

1

1V

14



15°

Ø 70

INC

**BRUSH HOLDER** 09

494487

SEP:SEPARATED REGULATOR -INC:BUILT-IN REGULATOR 02494495**REAR BEARING** 22

592857

ROTOR 04

512009

STATOR 05

592625

Valeo

432859/436194

9AR2533P

70

2

1V

14



60°

Ø 66

Picture not available
Image non disponible
Imagen no disponible
Immagine non disponibile
Nicht verfügbares Bild
Brak zdjęć
Картина недоступна

Picture not available
Image non disponible
Imagen no disponible
Immagine non disponibile
Nicht verfügbares Bild
Brak zdjęć
Картина недоступна

BRUSH HOLDER 09

494487

SEP:SEPARATED REGULATOR -INC:BUILT-IN REGULATOR 02494495**FAN** 12

592088

REAR BEARING 22

592857

PROTECTION COVER 24

494507

ROTOR 04

512005

STATOR 05

592625

Valeo

432818

9AR2539K

55

2

1V

14



60°

Ø 77

INC

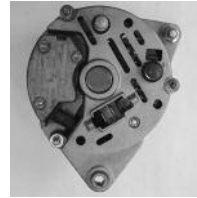
**BRUSH HOLDER** 09

494487

SEP:SEPARATED REGULATOR -INC:BUILT-IN REGULATOR 02494495**REAR BEARING** 22

592857

ROTOR 04

512039

Valeo

432825/436181

9AR2547F

35

1

1V

14



0°

Ø 83,7

Picture not available
Image non disponible
Imagen no disponible
Immagine non disponibile
Nicht verfügbares Bild
Brak zdjęć
Картина недоступна

Picture not available
Image non disponible
Imagen no disponible
Immagine non disponibile
Nicht verfügbares Bild
Brak zdjęć
Картина недоступна

BRUSH HOLDER 09

503019

SEP:SEPARATED REGULATOR -INC:BUILT-IN REGULATOR 02494495**RECTIFIER OR DIODE BRIDGE ASSEMBLY** 07

592554

REAR BEARING 22

592857

PROTECTION COVER 24

494507

ROTOR 04

512009

STATOR 05

592625

Valeo

432983/436263

9AR2548F

35

1

1V

14



0°

Ø 98,7

Picture not available
Image non disponible
Imagen no disponible
Immagine non disponibile
Nicht verfügbares Bild
Brak zdjęć
Картина недоступна

Picture not available
Image non disponible
Imagen no disponible
Immagine non disponibile
Nicht verfügbares Bild
Brak zdjęć
Картина недоступна

BRUSH HOLDER 09

503019

SEP:SEPARATED REGULATOR -INC:BUILT-IN REGULATOR 02494495**REAR BEARING** 22

592857

PROTECTION COVER 24

494507

ROTOR 04

512009

STATOR 05

592625

Valeo

432983/436263

9AR2549F

35

1

1V

14



0°

Ø 111,5

Picture not available
Image non disponible
Imagen no disponible
Immagine non disponibile
Nicht verfügbares Bild
Brak zdjęć
Картина недоступна

Picture not available
Image non disponible
Imagen no disponible
Immagine non disponibile
Nicht verfügbares Bild
Brak zdjęć
Картина недоступна

BRUSH HOLDER 09

503019

SEP:SEPARATED REGULATOR -INC:BUILT-IN REGULATOR 02494495**RECTIFIER OR DIODE BRIDGE ASSEMBLY** 07

592554

REAR BEARING 22

592857

PROTECTION COVER 24

494507

ROTOR 04

512009

STATOR 05

592625

Valeo

432983/436263



9AR2553K

55

1

1V

14



0°

Ø 83,7

Picture not available
Image non disponible
Imagen no disponible
Immagine non disponibile
Nicht verfügbares Bild
Brak zdjęcia
Картина недоступна

Picture not available
Image non disponible
Imagen no disponible
Immagine non disponibile
Nicht verfügbares Bild
Brak zdjęcia
Картина недоступна

BRUSH HOLDER 09

503019

SEP:SEPARATED REGULATOR -INC:BUILT-IN REGULATOR 02494495**RECTIFIER OR DIODE BRIDGE ASSEMBLY** 07 592554**REAR BEARING** 22 592857**PROTECTION COVER** 24 494507**ROTOR** 04 512039**Valeo** 432983/436263**9AR2561K**

55

2

1V

14



60°

Ø 52

INC

**BRUSH HOLDER** 09

494487

SEP:SEPARATED REGULATOR -INC:BUILT-IN REGULATOR 02494495**REAR BEARING** 22 592857**ROTOR** 04 512005**Valeo** 432825/436181**9AR2562K**

55

2

1V

14



60°

Ø 56

INC

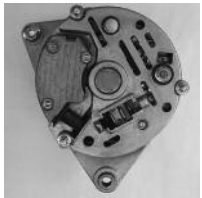
**BRUSH HOLDER** 09

494487

SEP:SEPARATED REGULATOR -INC:BUILT-IN REGULATOR 02494495**REAR BEARING** 22 592857**ROTOR** 04 512005**9AR2562K**

55

2

1V

14



60°

Ø 56

INC

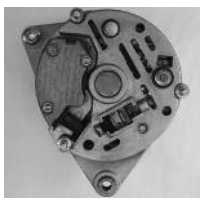
**BRUSH HOLDER** 09

494487

SEP:SEPARATED REGULATOR -INC:BUILT-IN REGULATOR 02494495**REAR BEARING** 22 592857**ROTOR** 04 512005**9AR2562K**

55

2

1V

14



60°

Ø 56

INC

**BRUSH HOLDER** 09

494487

SEP:SEPARATED REGULATOR -INC:BUILT-IN REGULATOR 02494495**REAR BEARING** 22 592857**ROTOR** 04 512005**Valeo** 432819/436223**9AR2565F**

35

1

1V

14



0°

Ø 69,7

Picture not available
Image non disponible
Imagen no disponible
Immagine non disponibile
Nicht verfügbares Bild
Brak zdjęcia
Картина недоступна

Picture not available
Image non disponible
Imagen no disponible
Immagine non disponibile
Nicht verfügbares Bild
Brak zdjęcia
Картина недоступна

BRUSH HOLDER 09

494487

SEP:SEPARATED REGULATOR -INC:BUILT-IN REGULATOR 02494495**REAR BEARING** 22 592857**PROTECTION COVER** 24 494507**ROTOR** 04 512009**STATOR** 05 592625**Valeo** 432983/436223**9AR2566K**

55

1

14



Picture not available
Image non disponible
Imagen no disponible
Immagine non disponibile
Nicht verfügbares Bild
Brak zdjęcia
Картина недоступна

Picture not available
Image non disponible
Imagen no disponible
Immagine non disponibile
Nicht verfügbares Bild
Brak zdjęcia
Картина недоступна

BRUSH HOLDER 09

503019

SEP:SEPARATED REGULATOR -INC:BUILT-IN REGULATOR 02494495**RECTIFIER OR DIODE BRIDGE ASSEMBLY** 07 592554**REAR BEARING** 22 592857**PROTECTION COVER** 24 494507**ROTOR** 04 512039**Valeo** 432983/436223**9AR2567F**

35

1

14

Picture not available
Image non disponible
Imagen no disponible
Immagine non disponibile
Nicht verfügbares Bild
Brak zdjęcia
Картина недоступна

Picture not available
Image non disponible
Imagen no disponible
Immagine non disponibile
Nicht verfügbares Bild
Brak zdjęcia
Картина недоступна

BRUSH HOLDER 09

503019

SEP:SEPARATED REGULATOR -INC:BUILT-IN REGULATOR 02494495**REAR BEARING** 22 592857**PROTECTION COVER** 24 494507**ROTOR** 04 512009**Valeo** 432983/436223

9AR2569G

45

2

1V

14



60°

Ø 52

INC

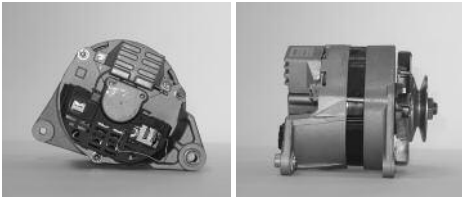
**BRUSH HOLDER** 09

494487

SEP:SEPARATED REGULATOR -INC:BUILT-IN REGULATOR 02494495**REAR BEARING** 22

592857

ROTOR 04

512039

Valeo**432835/436169****9AR2570G**

45

2

1V

14



60°

Ø 52

INC

**BRUSH HOLDER** 09

494487

SEP:SEPARATED REGULATOR -INC:BUILT-IN REGULATOR 02494495**REAR BEARING** 22

592857

ROTOR 04

512039

Valeo**432836/436167****9AR2587F**

35

2

1V

14



Ø 69,7

Picture not available
Image non disponible
Imagen no disponible
Immagine non disponibile
Nicht verfügbares Bild
Brak zdjęcia
Картина недоступна

Picture not available
Image non disponible
Imagen no disponible
Immagine non disponibile
Nicht verfügbares Bild
Brak zdjęcia
Картина недоступна

BRUSH HOLDER 09

494487

SEP:SEPARATED REGULATOR -INC:BUILT-IN REGULATOR 02494495**REAR BEARING** 22

592857

PROTECTION COVER 24

494507

ROTOR 04

512009

STATOR 05

592625

Valeo**490664****9AR2602F**

35

2

1V

14



60°

Ø 52

INC

**BRUSH HOLDER** 09

494487

SEP:SEPARATED REGULATOR -INC:BUILT-IN REGULATOR 02494495**REAR BEARING** 22

592857

ROTOR 04

512009

STATOR 05

592625

Valeo**432836/436167****9AR2603F**

35

2

1V

14



60°

Ø 52

INC

**BRUSH HOLDER** 09

494487

SEP:SEPARATED REGULATOR -INC:BUILT-IN REGULATOR 02494495**REAR BEARING** 22

592857

ROTOR 04

512009

STATOR 05

592625

Valeo**432835/436169****9AR2612G**

45

2

1V

14



60°

Ø 52

INC

**BRUSH HOLDER** 09

494487

SEP:SEPARATED REGULATOR -INC:BUILT-IN REGULATOR 02494495**REAR BEARING** 22

592857

ROTOR 04

512039

Valeo**432863/436140****9AR2613F**

35

2

1V

14



60°

Ø 56

INC

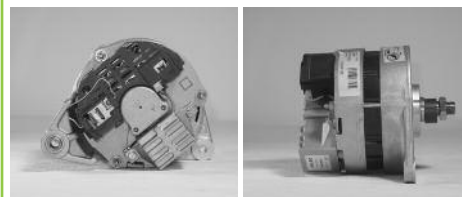
**BRUSH HOLDER** 09

494487

SEP:SEPARATED REGULATOR -INC:BUILT-IN REGULATOR 02494495**REAR BEARING** 22

592857

ROTOR 04

512009

STATOR 05

592625

Valeo**432863/436140****9AR2619G**

45

1

1V

14



60°

Ø 59,7

INC

**RECTIFIER OR DIODE BRIDGE ASSEMBLY** 07

501118

REAR BEARING 22

592857

ROTOR 04

512039

Valeo**436153**

9AR2621L

65

1

1V

14



60°

Ø 61

INC

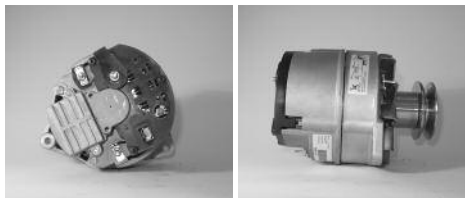

BRUSH HOLDER 09 494487
SEP:SEPARATED REGULATOR -INC:BUILT-IN REGULATOR 02 494495
RECTIFIER OR DIODE BRIDGE ASSEMBLY 07 501118
FAN 12 592088
REAR BEARING 22 592857
ROTOR 04 512039
STATOR 05 592625

Valeo**432856/436199****9AR2627G**

45

2

1V

14



60°

Ø 52

INC



BRUSH HOLDER 09 494487
SEP:SEPARATED REGULATOR -INC:BUILT-IN REGULATOR 02 505032
RECTIFIER OR DIODE BRIDGE ASSEMBLY 07 494476
REAR BEARING 22 592857
ROTOR 04 512031

Valeo**432836/436167****9AR2629G**

45

2

1V

14



60°

Ø 52

INC



BRUSH HOLDER 09 494487
SEP:SEPARATED REGULATOR -INC:BUILT-IN REGULATOR 02 494495
REAR BEARING 22 592857
ROTOR 04 512039

Valeo**432836/436167****9AR2630K**

55

2

1V

14



60°

Ø 56

INC



BRUSH HOLDER 09 494487
SEP:SEPARATED REGULATOR -INC:BUILT-IN REGULATOR 02 494495
REAR BEARING 22 592857
ROTOR 04 512005

9AR2630K

55

2

1V

14



60°

Ø 56

INC



BRUSH HOLDER 09 494487
SEP:SEPARATED REGULATOR -INC:BUILT-IN REGULATOR 02 494495
REAR BEARING 22 592857
ROTOR 04 512005

9AR2630K

55

2

1V

14



60°

Ø 56

INC



BRUSH HOLDER 09 494487
SEP:SEPARATED REGULATOR -INC:BUILT-IN REGULATOR 02 494495
REAR BEARING 22 592857
ROTOR 04 512005

Valeo**432825/436181****9AR2636G**

45

1

1V

14



15°

Ø 61

INC



BRUSH HOLDER 09 494487
SEP:SEPARATED REGULATOR -INC:BUILT-IN REGULATOR 02 505031
RECTIFIER OR DIODE BRIDGE ASSEMBLY 07 494476
REAR BEARING 22 592857
ROTOR 04 512031

Valeo**432859/436194****9AR2638P**

70

1

1V

14



Ø 59,7

Picture not available
 Image non disponible
 Imagen no disponible
 Immagine non disponibile
 Nicht verfügbares Bild
 Brak zdjęcia
 Картина недоступна

Picture not available
 Image non disponible
 Imagen no disponible
 Immagine non disponibile
 Nicht verfügbares Bild
 Brak zdjęcia
 Картина недоступна

REAR BEARING 22 590619
BRUSH HOLDER 09 494487
SEP:SEPARATED REGULATOR -INC:BUILT-IN REGULATOR 02 494495
FAN 12 592088
PROTECTION COVER 24 494507
ROTOR 04 512005
STATOR 05 592625

Valeo**432826**

9AR2641G

40

1

1V

14



42°

Ø 60,5

INC

Picture not available
Image non disponible
Imagem no disponibile
Immagine non disponibile
Nicht verfügbares Bild
Brak zdjęcia
Картина недоступна

Picture not available
Image non disponible
Imagem no disponibile
Immagine non disponibile
Nicht verfügbares Bild
Brak zdjęcia
Картина недоступна

REAR BEARING 22

592857

ROTOR 04

512031

Valeo**432747/433404****9AR2650D**

28

2

1V

14



60°

Ø 52

INC

**BRUSH HOLDER** 09

494487

SEP:SEPARATED REGULATOR -INC:BUILT-IN REGULATOR 02505032**RECTIFIER OR DIODE BRIDGE ASSEMBLY** 07

494476

REAR BEARING 22

592857

ROTOR 04

512031

Valeo**432836/436167****9AR2652F**

35

2

1V

14



60°

Ø 52

INC

**BRUSH HOLDER** 09

494487

SEP:SEPARATED REGULATOR -INC:BUILT-IN REGULATOR 02505032**RECTIFIER OR DIODE BRIDGE ASSEMBLY** 07

494476

REAR BEARING 22

592857

ROTOR 04

512031

9AR2652F

35

2

1V

14



60°

Ø 52

INC

**BRUSH HOLDER** 09

494487

SEP:SEPARATED REGULATOR -INC:BUILT-IN REGULATOR 02505032**RECTIFIER OR DIODE BRIDGE ASSEMBLY** 07

494476

REAR BEARING 22

592857

ROTOR 04

512031

Valeo**432836/436175****9AR2653F**

35

2

1V

14



60°

Ø 52

INC

**BRUSH HOLDER** 09

494487

SEP:SEPARATED REGULATOR -INC:BUILT-IN REGULATOR 02505032**RECTIFIER OR DIODE BRIDGE ASSEMBLY** 07

494476

REAR BEARING 22

592857

ROTOR 04

512031

Valeo**432835/436169****9AR2654G**

45

2

1V

14



60°

Ø 52

INC

**BRUSH HOLDER** 09

494487

SEP:SEPARATED REGULATOR -INC:BUILT-IN REGULATOR 02505032**RECTIFIER OR DIODE BRIDGE ASSEMBLY** 07

494476

REAR BEARING 22

592857

ROTOR 04

512031

Valeo**432836/436167****9AR2655G**

45

2

1V

14



60°

Ø 52

INC

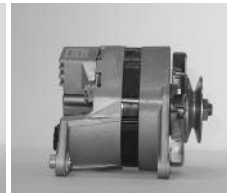
**BRUSH HOLDER** 09

494487

SEP:SEPARATED REGULATOR -INC:BUILT-IN REGULATOR 02505032**RECTIFIER OR DIODE BRIDGE ASSEMBLY** 07

494476

REAR BEARING 22

592857

ROTOR 04

512031

Valeo**432835/436169****9AR2659K**

50

1

1V

14



60°

Ø 60

INC

**BRUSH HOLDER** 09

494488

REAR BEARING 22

592857

ROTOR 04

512039

Valeo**432724/433429**

9AR2660K

50

2

1V

14



70°

Ø 55,4

INC



REAR BEARING 22
 BRUSH HOLDER 09
 ROTOR 04

590619
 494488
 512039

Valeo**432735/433414****9AR2662F**

33

1

1V

14



60°

Ø 55,4

INC

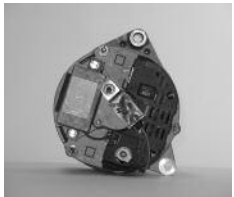

BRUSH HOLDER 09
 REAR BEARING 22
 ROTOR 04

494487
 592857
 512031

Valeo**432857/433352****9AR2663K**

55

1

1V

14



20°

Ø 66

INC



BRUSH HOLDER 09
 SEP:SEPARATED REGULATOR -INC:BUILT-IN REGULATOR 02505029
 RECTIFIER OR DIODE BRIDGE ASSEMBLY 07
 REAR BEARING 22
 PROTECTION COVER 24
 ROTOR 04

494487
 592554
 592857
 494507
 512039

Valeo**432744/433375****9AR2664F**

33

1

1V

14



45°

Ø 66

INC



BRUSH HOLDER 09
 REAR BEARING 22
 ROTOR 04

494487
 592857
 512031

Valeo**433036/433353****9AR2672P**

70

2

1V

14



20°

Ø 59,7

INC



BRUSH HOLDER 09
 SEP:SEPARATED REGULATOR -INC:BUILT-IN REGULATOR 02505029
 RECTIFIER OR DIODE BRIDGE ASSEMBLY 07
 FAN 12
 REAR BEARING 22
 PROTECTION COVER 24
 ROTOR 04
 STATOR 05

494487
 592554
 592088
 592857
 494507
 512005
 592625

Valeo**432829/436316****9AR2673K**

55

2

1V

14



20°

Ø 65,8

INC



BRUSH HOLDER 09
 SEP:SEPARATED REGULATOR -INC:BUILT-IN REGULATOR 02505029
 RECTIFIER OR DIODE BRIDGE ASSEMBLY 07
 REAR BEARING 22
 PROTECTION COVER 24
 ROTOR 04

494487
 592554
 592857
 494507
 512039

Valeo**432746/433374****9AR2676K**

50

2

1V

14



0°

Ø 59,7

INC



BRUSH HOLDER 09
 REAR BEARING 22
 ROTOR 04

494488
 592857
 512039

Valeo**432764/433447****9AR2683G**

45

2

1V

14



60°

Ø 61

INC



BRUSH HOLDER 09
 SEP:SEPARATED REGULATOR -INC:BUILT-IN REGULATOR 02505032
 RECTIFIER OR DIODE BRIDGE ASSEMBLY 07
 REAR BEARING 22
 ROTOR 04

494487
 494476
 592857
 512031

9AR2683G

45

2

1V

14



60°

Ø 61

INC

**BRUSH HOLDER** 09

494487

SEP:SEPARATED REGULATOR -INC:BUILT-IN REGULATOR 02505032**RECTIFIER OR DIODE BRIDGE ASSEMBLY** 07

494476

REAR BEARING 22

592857

ROTOR 04

512031

Valeo**432831/436145****9AR2684P**

70

2

1V

14



Ø 59,7

Picture not available
Image non disponible
Imagen no disponible
Immagine non disponibile
Nicht verfügbares Bild
Brak zdjęćia
Картина недоступна

Picture not available
Image non disponible
Imagen no disponible
Immagine non disponibile
Nicht verfügbares Bild
Brak zdjęćia
Картина недоступна

BRUSH HOLDER 09

494487

SEP:SEPARATED REGULATOR -INC:BUILT-IN REGULATOR 02494495**FAN** 12

592088

REAR BEARING 22

592857

PROTECTION COVER 24

494507

ROTOR 04

512005

STATOR 05

592625

Valeo**432837****9AR2687G**

45

1

1V

14



Ø 66

Picture not available
Image non disponible
Imagen no disponible
Immagine non disponibile
Nicht verfügbares Bild
Brak zdjęćia
Картина недоступна

Picture not available
Image non disponible
Imagen no disponible
Immagine non disponibile
Nicht verfügbares Bild
Brak zdjęćia
Картина недоступна

BRUSH HOLDER 09

494487

SEP:SEPARATED REGULATOR -INC:BUILT-IN REGULATOR 02505032**REAR BEARING** 22

592857

ROTOR 04

512031

Valeo**510847****9AR2690P**

70

2

1V

14



20°

Ø 59,7

INC

**BRUSH HOLDER** 09

494488

RECTIFIER OR DIODE BRIDGE ASSEMBLY 07

592554

FAN 12

592088

REAR BEARING 22

592857

ROTOR 04

512005

STATOR 05

592625

Valeo**432829/436316****9AR2695K**

50

1

1V

14



70°

Ø 55,4

INC

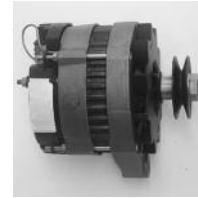
**BRUSH HOLDER** 09

494488

REAR BEARING 22

592857

ROTOR 04

512039

Valeo**432735/433414****9AR2697D**

28

2

1V

14



60°

Ø 60

Picture not available
Image non disponible
Imagen no disponible
Immagine non disponibile
Nicht verfügbares Bild
Brak zdjęćia
Картина недоступна

Picture not available
Image non disponible
Imagen no disponible
Immagine non disponibile
Nicht verfügbares Bild
Brak zdjęćia
Картина недоступна

BRUSH HOLDER 09

494487

SEP:SEPARATED REGULATOR -INC:BUILT-IN REGULATOR 02505032**RECTIFIER OR DIODE BRIDGE ASSEMBLY** 07

494476

REAR BEARING 22

592857

ROTOR 04

512031

Valeo**432863/436175****9AR2701D**

28

2

1V

14



60°

Ø 52

INC

**BRUSH HOLDER** 09

494487

SEP:SEPARATED REGULATOR -INC:BUILT-IN REGULATOR 02505032**RECTIFIER OR DIODE BRIDGE ASSEMBLY** 07

494476

REAR BEARING 22

592857

ROTOR 04

512031

Valeo**432836/436167****9AR2702D**

45

2

1V

14



60°

Ø 56

INC

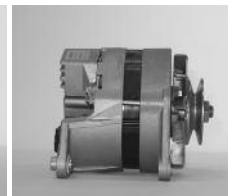
**BRUSH HOLDER** 09

494487

SEP:SEPARATED REGULATOR -INC:BUILT-IN REGULATOR 02505032**RECTIFIER OR DIODE BRIDGE ASSEMBLY** 07

494476

REAR BEARING 22

592857

ROTOR 04

512031

Valeo**432835/436169**

9AR2703F

35

2

1V

14



60°

Ø 56

INC



BRUSH HOLDER 09 494487
SEP:SEPARATED REGULATOR -INC:BUILT-IN REGULATOR 02505032
RECTIFIER OR DIODE BRIDGE ASSEMBLY 07 494476
REAR BEARING 22 592857
ROTOR 04 512031

9AR2703F

35

2

1V

14



60°

Ø 56

INC



BRUSH HOLDER 09 494487
SEP:SEPARATED REGULATOR -INC:BUILT-IN REGULATOR 02505032
RECTIFIER OR DIODE BRIDGE ASSEMBLY 07 494476
REAR BEARING 22 592857
ROTOR 04 512031

Valeo**432836/436175****9AR2704F**

45

2

1V

14



60°

Ø 56

INC



BRUSH HOLDER 09 494487
SEP:SEPARATED REGULATOR -INC:BUILT-IN REGULATOR 02505032
RECTIFIER OR DIODE BRIDGE ASSEMBLY 07 494476
REAR BEARING 22 592857
ROTOR 04 512031

Valeo**432835/436169****9AR2705G**

45

2

1V

14



60°

Ø 56

INC



BRUSH HOLDER 09 494487
SEP:SEPARATED REGULATOR -INC:BUILT-IN REGULATOR 02505032
RECTIFIER OR DIODE BRIDGE ASSEMBLY 07 494476
REAR BEARING 22 592857
ROTOR 04 512031

Valeo**432836/436167****9AR2706G**

45

2

1V

14



Ø 61

Picture not available
 Image non disponible
 Imagen no disponible
 Immagine non disponibile
 Nicht verfügbares Bild
 Brak zdjęcia
 Картина недоступна

Picture not available
 Image non disponible
 Imagen no disponible
 Immagine non disponibile
 Nicht verfügbares Bild
 Brak zdjęcia
 Картина недоступна

REAR BEARING 22 590619
BRUSH HOLDER 09 494489
SEP:SEPARATED REGULATOR -INC:BUILT-IN REGULATOR 02505032
RECTIFIER OR DIODE BRIDGE ASSEMBLY 07 494476
FAN 12 *507067
PULLEY 11 523335
ROTOR 04 512031
Valeo **432835**

9AR2707G

45

2

1V

14



60°

Ø 56

INC

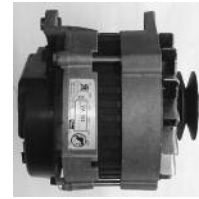

BRUSH HOLDER 09 494487
SEP:SEPARATED REGULATOR -INC:BUILT-IN REGULATOR 02505032
RECTIFIER OR DIODE BRIDGE ASSEMBLY 07 494476
REAR BEARING 22 592857
ROTOR 04 512031
Valeo **432836/436167**

9AR2708G

45

1

1V

14



60°

Ø 61

INC



BRUSH HOLDER 09 494487
SEP:SEPARATED REGULATOR -INC:BUILT-IN REGULATOR 02505031
RECTIFIER OR DIODE BRIDGE ASSEMBLY 07 494476
REAR BEARING 22 592857
ROTOR 04 512031
Valeo **432849/436208**

9AR2709L

54

1

1V

14



15°

Ø 61

INC

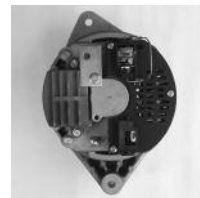

BRUSH HOLDER 09 494487
SEP:SEPARATED REGULATOR -INC:BUILT-IN REGULATOR 02494495
FAN 12 592088
REAR BEARING 22 592857
ROTOR 04 512039
STATOR 05 592625
Valeo **432861/436197**

9AR2712P

70

1

14



Picture not available
Image non disponible
Imagen no disponible
Immagine non disponibile
Nicht verfügbares Bild
Brak zdjęcia
Картина недоступна

Picture not available
Image non disponible
Imagen no disponible
Immagine non disponibile
Nicht verfügbares Bild
Brak zdjęcia
Картина недоступна

BRUSH HOLDER 09

503025

SEP:SEPARATED REGULATOR -INC:BUILT-IN REGULATOR 02505034**FAN** 12

592088

REAR BEARING 22

592857

ROTOR 04

512005

STATOR 05

592625

Valeo**510803****9AR2714F**

35

1

1V

14



Ø 80

Picture not available
Image non disponible
Imagen no disponible
Immagine non disponibile
Nicht verfügbares Bild
Brak zdjęcia
Картина недоступна

Picture not available
Image non disponible
Imagen no disponible
Immagine non disponibile
Nicht verfügbares Bild
Brak zdjęcia
Картина недоступна

BRUSH HOLDER 09

503019

SEP:SEPARATED REGULATOR -INC:BUILT-IN REGULATOR 02494495**RECTIFIER OR DIODE BRIDGE ASSEMBLY** 07

592554

REAR BEARING 22

592857

PROTECTION COVER 24

494507

ROTOR 04

512009

STATOR 05

592625

Valeo**432998****9AR2715F**

35

1

1V

14



Ø 95,2

Picture not available
Image non disponible
Imagen no disponible
Immagine non disponibile
Nicht verfügbares Bild
Brak zdjęcia
Картина недоступна

Picture not available
Image non disponible
Imagen no disponible
Immagine non disponibile
Nicht verfügbares Bild
Brak zdjęcia
Картина недоступна

BRUSH HOLDER 09

503019

SEP:SEPARATED REGULATOR -INC:BUILT-IN REGULATOR 02494495**RECTIFIER OR DIODE BRIDGE ASSEMBLY** 07

592554

REAR BEARING 22

592857

PROTECTION COVER 24

494507

ROTOR 04

512009

STATOR 05

592625

Valeo**432999****9AR2719G**

45

2

1V

14



Ø 61

Picture not available
Image non disponible
Imagen no disponible
Immagine non disponibile
Nicht verfügbares Bild
Brak zdjęcia
Картина недоступна

Picture not available
Image non disponible
Imagen no disponible
Immagine non disponibile
Nicht verfügbares Bild
Brak zdjęcia
Картина недоступна

BRUSH HOLDER 09

494487

REAR BEARING 22

592857

ROTOR 04

512031

Valeo**510808****9AR2720K**

50

1

1V

14



42°

Ø 60,5

INC

Picture not available
Image non disponible
Imagen no disponible
Immagine non disponibile
Nicht verfügbares Bild
Brak zdjęcia
Картина недоступна

Picture not available
Image non disponible
Imagen no disponible
Immagine non disponibile
Nicht verfügbares Bild
Brak zdjęcia
Картина недоступна

BRUSH HOLDER 09

494487

REAR BEARING 22

592857

ROTOR 04

512031

Valeo**432747/433404****9AR2725F**

35

1

1V

14



0°

Ø 83,7

Picture not available
Image non disponible
Imagen no disponible
Immagine non disponibile
Nicht verfügbares Bild
Brak zdjęcia
Картина недоступна

Picture not available
Image non disponible
Imagen no disponible
Immagine non disponibile
Nicht verfügbares Bild
Brak zdjęcia
Картина недоступна

BRUSH HOLDER 09

503019

SEP:SEPARATED REGULATOR -INC:BUILT-IN REGULATOR 02494495**REAR BEARING** 22

592857

ROTOR 04

512009

STATOR 05

592625

Valeo**432984/436264****9AR2726G**

45

1

1V

14



15°

Ø 61

INC

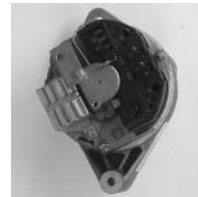
**BRUSH HOLDER** 09

494489

SEP:SEPARATED REGULATOR -INC:BUILT-IN REGULATOR 02505031**RECTIFIER OR DIODE BRIDGE ASSEMBLY** 07

494476

REAR BEARING 22

592857

ROTOR 04

512031

Valeo**432859/436194****9AR2727G**

45

1

1V

14



60°

Ø 61

INC

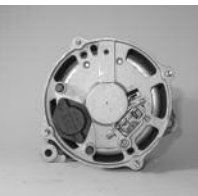
**BRUSH HOLDER** 09

494489

SEP:SEPARATED REGULATOR -INC:BUILT-IN REGULATOR 02505031**RECTIFIER OR DIODE BRIDGE ASSEMBLY** 07

494476

REAR BEARING 22

592857

ROTOR 04

512031

Valeo**432849/436208**

9AR2728G

40 1 1V

14 ↻ 45° ∇ Ø 59,7 INC

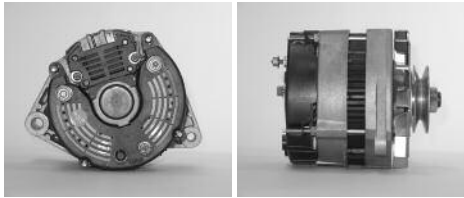

BRUSH HOLDER 09 494489
REAR BEARING 22 592857
ROTOR 04 512031
Valeo 433036/433354

9AR2737P

70 2 1V

14 ↻ Ø 66

Picture not available
Image non disponible
Imagen no disponible
Immagine non disponibile
Nicht verfügbares Bild
Brak zdjęcia
Картина недоступна

Picture not available
Image non disponible
Imagen no disponible
Immagine non disponibile
Nicht verfügbares Bild
Brak zdjęcia
Картина недоступна

BRUSH HOLDER 09 503025
SEP:SEPARATED REGULATOR -INC:BUILT-IN REGULATOR 02505038
CONDENSOR 14 517009
RECTIFIER OR DIODE BRIDGE ASSEMBLY 07 501096
FAN 12 592088
REAR BEARING 22 592857
ROTOR 04 512005
STATOR 05 592625
Valeo 510815

9AR2738P

70 1 SP

14 ↻

Picture not available
Image non disponible
Imagen no disponible
Immagine non disponibile
Nicht verfügbares Bild
Brak zdjęcia
Картина недоступна

Picture not available
Image non disponible
Imagen no disponible
Immagine non disponibile
Nicht verfügbares Bild
Brak zdjęcia
Картина недоступна

BRUSH HOLDER 09 503025
SEP:SEPARATED REGULATOR -INC:BUILT-IN REGULATOR 02505038
CONDENSOR 14 517009
FAN 12 592088
REAR BEARING 22 592857
ROTOR 04 512005
STATOR 05 592625
Valeo 510816

9AR2742P

70 1 1V

14 ↻ Ø 80

Picture not available
Image non disponible
Imagen no disponible
Immagine non disponibile
Nicht verfügbares Bild
Brak zdjęcia
Картина недоступна

Picture not available
Image non disponible
Imagen no disponible
Immagine non disponibile
Nicht verfügbares Bild
Brak zdjęcia
Картина недоступна

BRUSH HOLDER 09 503025
SEP:SEPARATED REGULATOR -INC:BUILT-IN REGULATOR 02505038
CONDENSOR 14 517009
FAN 12 592088
REAR BEARING 22 592857
ROTOR 04 512005
STATOR 05 592625
Valeo 510820

9AR2744P

70 2 1V

14 ↻ Ø 61

Picture not available
Image non disponible
Imagen no disponible
Immagine non disponibile
Nicht verfügbares Bild
Brak zdjęcia
Картина недоступна

Picture not available
Image non disponible
Imagen no disponible
Immagine non disponibile
Nicht verfügbares Bild
Brak zdjęcia
Картина недоступна

BRUSH HOLDER 09 503025
SEP:SEPARATED REGULATOR -INC:BUILT-IN REGULATOR 02505038
CONDENSOR 14 517009
RECTIFIER OR DIODE BRIDGE ASSEMBLY 07 501096
FAN 12 592088
REAR BEARING 22 592857
ROTOR 04 512005
STATOR 05 592625
Valeo 510823

9AR2748G

45 1 1V

14 ↻ 30° ∇ Ø 55,4 INC

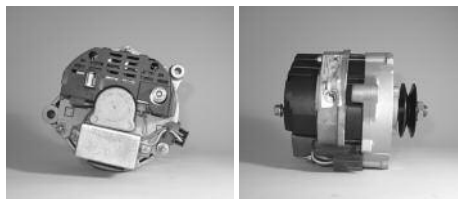

BRUSH HOLDER 09 494487
REAR BEARING 22 592857
ROTOR 04 512031
Valeo 432846/433363

9AR2752P

70 2 1V

14 ↻ 0° ∇ Ø 59,7 INC



BRUSH HOLDER 09 494488
REAR BEARING 22 592857
ROTOR 04 512005
STATOR 05 592625
Valeo 432811/433371

9AR2755P

70 1 1V

14 ↻ 60° ∇ Ø 59,7 INC

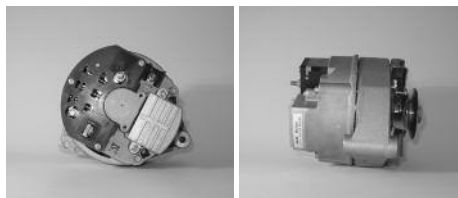

BRUSH HOLDER 09 503025
SEP:SEPARATED REGULATOR -INC:BUILT-IN REGULATOR 02494495
RECTIFIER OR DIODE BRIDGE ASSEMBLY 07 592554
FAN 12 592088
REAR BEARING 22 592857
PROTECTION COVER 24 494507
ROTOR 04 512005
STATOR 05 592625

9AR2755P

70

1

1V

14



60°

Ø 59,7

INC

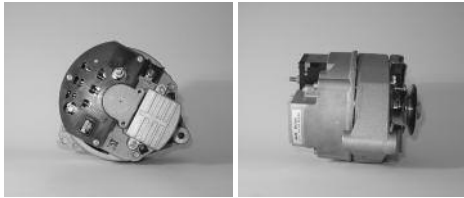

BRUSH HOLDER 09 503025
SEP:SEPARATED REGULATOR -INC:BUILT-IN REGULATOR 02494495
RECTIFIER OR DIODE BRIDGE ASSEMBLY 07 592554
FAN 12 592088
REAR BEARING 22 592857
PROTECTION COVER 24 494507
ROTOR 04 512005
STATOR 05 592625

Valeo**432727/436287****9AR2756F**

35

1

1V

14



15°

Ø 61

INC



BRUSH HOLDER 09 494487
SEP:SEPARATED REGULATOR -INC:BUILT-IN REGULATOR 02494495
REAR BEARING 22 592857
ROTOR 04 512039
STATOR 05 592625

Valeo**432859/436194****9AR2757K**

50

1

1V

14



42°

Ø 60,5

INC

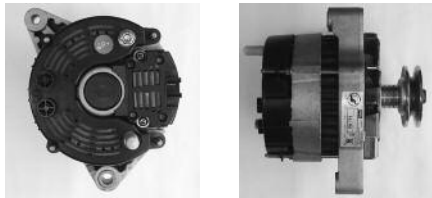

REAR BEARING 22 592857
ROTOR 04 512031

Valeo**432748/433405****9AR2759K**

55

1

14



INC



BRUSH HOLDER 09 494487
REAR BEARING 22 592857
ROTOR 04 512005

Valeo**436121****9AR2760K**

50

2

1V

14



70°

Ø 55,4

INC



BRUSH HOLDER 09 494488
REAR BEARING 22 592857
ROTOR 04 512039

Valeo**432735/433414****9AR2763F**

35

1

1V

14



15°

Ø 61

INC



BRUSH HOLDER 09 494487
SEP:SEPARATED REGULATOR -INC:BUILT-IN REGULATOR 02494495
REAR BEARING 22 592857
ROTOR 04 512009
STATOR 05 592625

Valeo**432859/436194****9AR2764L**

65

1

1V

14



15°

Ø 61

INC

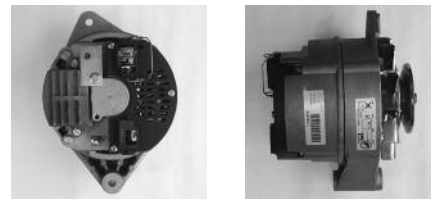

BRUSH HOLDER 09 494487
SEP:SEPARATED REGULATOR -INC:BUILT-IN REGULATOR 02494495
FAN 12 592088
REAR BEARING 22 592857
ROTOR 04 512039
STATOR 05 592625

Valeo**432861/436197****9AR2775F**

35

1

14



Picture not available
 Image non disponible
 Imagen no disponible
 Immagine non disponibile
 Nicht verfügbares Bild
 Brak zdjęcia
 Картина недоступна

Picture not available
 Image non disponible
 Imagen no disponible
 Immagine non disponibile
 Nicht verfügbares Bild
 Brak zdjęcia
 Картина недоступна

BRUSH HOLDER 09 503025
SEP:SEPARATED REGULATOR -INC:BUILT-IN REGULATOR 02505034
REAR BEARING 22 592857
ROTOR 04 512009
STATOR 05 592625

Valeo**510834**

9AR2778K	50	2	1V
14	↻	20°	Ø 69,7 INC

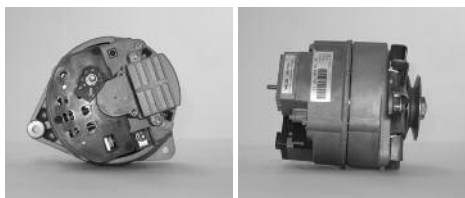

BRUSH HOLDER 09 494488
REAR BEARING 22 592857
ROTOR 04 512039

9AR2778K	50	2	1V
14	↻	20°	Ø 69,7 INC

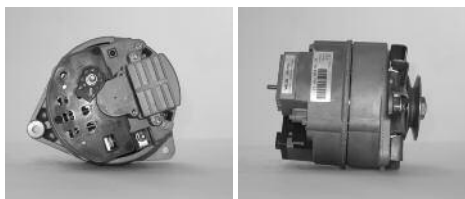

BRUSH HOLDER 09 494488
REAR BEARING 22 592857
ROTOR 04 512039

Valeo 432729/436137

9AR2779L	65	1	1V
14	↻	60°	Ø 61 INC

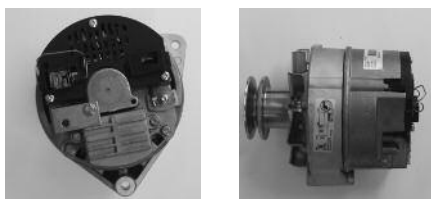

REAR BEARING 22 590619
BRUSH HOLDER 09 494487
FAN 12 592088
PULLEY 11 507033
PROTECTION COVER 24 523100
ROTOR 04 512039
STATOR 05 592625

Valeo 432853/436189

9AR2784K	55	1	1V
14	↻	60°	Ø 61 INC

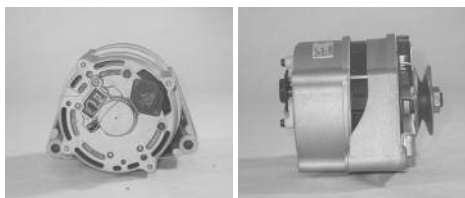

BRUSH HOLDER 09 494487
REAR BEARING 22 592857
ROTOR 04 512005

Valeo 436121

9AR2785K	55	1	1V
14	↻	60°	Ø 71 INC



BRUSH HOLDER 09 494487
REAR BEARING 22 592857
ROTOR 04 512005

Valeo 436121

9AR2786K	55	1	1V
14	↻	0°	Ø 83,7



BRUSH HOLDER 09 503019
SEP:SEPARATED REGULATOR -INC:BUILT-IN REGULATOR 02 494495

REAR BEARING 22 592857
ROTOR 04 512039

Valeo 432984/436244

9AR2792G	45	1	1V
14	↻	60°	Ø 61 INC



REAR BEARING 22 590619
BRUSH HOLDER 09 494489
RECTIFIER OR DIODE BRIDGE ASSEMBLY 07 494476

FAN 12 *507067
PULLEY 11 507033
ROTOR 04 512031

Valeo 432849/436208

9AR2794K	55	1	1V
14	↻	30°	Ø 59,7 INC



RECTIFIER OR DIODE BRIDGE ASSEMBLY 07 592554
REAR BEARING 22 592857
PROTECTION COVER 24 494507
ROTOR 04 512039

Valeo 432842/436157

9AR2795T

90

1

1V

14



Ø 61

Picture not available
Image non disponible
Imagen no disponible
Immagine non disponibile
Nicht verfügbares Bild
Brak zdjęćia
Картина недоступна

Picture not available
Image non disponible
Imagen no disponible
Immagine non disponibile
Nicht verfügbares Bild
Brak zdjęćia
Картина недоступна

BRUSH HOLDER 09

494487

RECTIFIER OR DIODE BRIDGE ASSEMBLY 07

592651

FAN 12

592088

REAR BEARING 22

592857

Valeo**432840****9AR2796T**

90

1

1V

14



Ø 61

Picture not available
Image non disponible
Imagen no disponible
Immagine non disponibile
Nicht verfügbares Bild
Brak zdjęćia
Картина недоступна

Picture not available
Image non disponible
Imagen no disponible
Immagine non disponibile
Nicht verfügbares Bild
Brak zdjęćia
Картина недоступна

BRUSH HOLDER 09

503019

RECTIFIER OR DIODE BRIDGE ASSEMBLY 07

592651

FAN 12

592088

REAR BEARING 22

592857

Valeo**432841****9AR2799G**

45

1

SP

14



60°

Picture not available
Image non disponible
Imagen no disponible
Immagine non disponibile
Nicht verfügbares Bild
Brak zdjęćia
Картина недоступна

Picture not available
Image non disponible
Imagen no disponible
Immagine non disponibile
Nicht verfügbares Bild
Brak zdjęćia
Картина недоступна

BRUSH HOLDER 09

494487

REAR BEARING 22

592857

ROTOR 04

512031

Valeo**432988/436265****9AR2805G**

45

2

2V

14



20°

Ø 76

Picture not available
Image non disponible
Imagen no disponible
Immagine non disponibile
Nicht verfügbares Bild
Brak zdjęćia
Картина недоступна

Picture not available
Image non disponible
Imagen no disponible
Immagine non disponibile
Nicht verfügbares Bild
Brak zdjęćia
Картина недоступна

BRUSH HOLDER 09

503019

RECTIFIER OR DIODE BRIDGE ASSEMBLY 07

501118

REAR BEARING 22

592857

ROTOR 04

512039

Valeo**510273/436359****9AR2809D**

25

1

1V

14



Ø 55,4

Picture not available
Image non disponible
Imagen no disponible
Immagine non disponibile
Nicht verfügbares Bild
Brak zdjęćia
Картина недоступна

Picture not available
Image non disponible
Imagen no disponible
Immagine non disponibile
Nicht verfügbares Bild
Brak zdjęćia
Картина недоступна

BRUSH HOLDER 09

503025

SEP:SEPARATED REGULATOR -INC:BUILT-IN REGULATOR 02

505038

CONDENSOR 14

517009

FAN 12

592088

REAR BEARING 22

592857

ROTOR 04

512039

Valeo**510837****9AR2810L**

65

1

1V

14



60°

Ø 66

INC

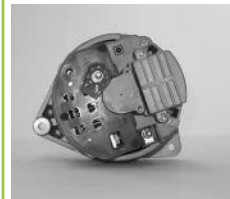
**BRUSH HOLDER** 09

494487

SEP:SEPARATED REGULATOR -INC:BUILT-IN REGULATOR 02

494495

FAN 12

592088

REAR BEARING 22

592857

ROTOR 04

512005

STATOR 05

592625

Valeo**436137****9AR2811K**

55

1

1V

14



60°

Ø 66

INC

**BRUSH HOLDER** 09

494487

SEP:SEPARATED REGULATOR -INC:BUILT-IN REGULATOR 02

494495

REAR BEARING 22

592857

ROTOR 04

512005

Valeo**436137****9AR2815K**

55

1

1V

14



20°

Ø 66

INC

**BRUSH HOLDER** 09

494488

RECTIFIER OR DIODE BRIDGE ASSEMBLY 07

592554

REAR BEARING 22

592857

ROTOR 04

512039

Valeo**432745/433380**

9AR2828G

45

1

1V

14



30°

Ø 55,4

INC

**BRUSH HOLDER** 09

494487

REAR BEARING 22

592857

ROTOR 04

512031

Valeo**432846/433363****9AR2830L**

65

1

1V

14



15°

Ø 61

INC

**REAR BEARING** 22

590619

BRUSH HOLDER 09

494487

SEP:SEPARATED REGULATOR -INC:BUILT-IN REGULATOR 02494495**FAN** 12

592088

PULLEY 11

507033

PROTECTION COVER 24

523100

ROTOR 04

512039

STATOR 05

592625

9AR2830L

65

1

1V

14



15°

Ø 61

INC

**REAR BEARING** 22

590619

BRUSH HOLDER 09

494487

SEP:SEPARATED REGULATOR -INC:BUILT-IN REGULATOR 02494495**FAN** 12

592088

PULLEY 11

507033

PROTECTION COVER 24

523100

ROTOR 04

512039

STATOR 05

592625

Valeo**432845/436293****9AR2838L**

65

1

1V

14



60°

Ø 61

INC

**BRUSH HOLDER** 09

503019

SEP:SEPARATED REGULATOR -INC:BUILT-IN REGULATOR 02494495**REAR BEARING** 22

592857

ROTOR 04

512039

STATOR 05

592625

Valeo**432853/436189****9AR2839G**

45

1

1V

14



70°

Ø 61

INC

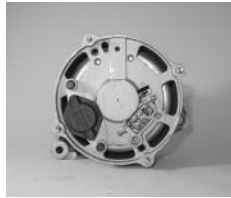
**BRUSH HOLDER** 09

494487

SEP:SEPARATED REGULATOR -INC:BUILT-IN REGULATOR 02505031**RECTIFIER OR DIODE BRIDGE ASSEMBLY** 07

494476

REAR BEARING 22

592857

ROTOR 04

512031

Valeo**432849/436208****9AR2843G**

45

2

1V

14



60°

Ø 59,7

INC

**BRUSH HOLDER** 09

494487

SEP:SEPARATED REGULATOR -INC:BUILT-IN REGULATOR 02505032**RECTIFIER OR DIODE BRIDGE ASSEMBLY** 07

494476

REAR BEARING 22

592857

ROTOR 04

512031

Valeo**432836/436167****9AR2846K**

55

1

1V

14



INC

**BRUSH HOLDER** 09

494487

REAR BEARING 22

592857

ROTOR 04

512005

9AR2846K

55

1

1V

14

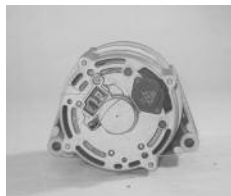

INC

**BRUSH HOLDER** 09

494487

REAR BEARING 22

592857

ROTOR 04

512005

Valeo**432854/436125**

9AR2851K

55

1

14



Picture not available
Image non disponible
Imagen no disponible
Immagine non disponibile
Nicht verfügbares Bild
Brak zdjęcia
Картина недоступна

Picture not available
Image non disponible
Imagen no disponible
Immagine non disponibile
Nicht verfügbares Bild
Brak zdjęcia
Картина недоступна

BRUSH HOLDER 09

503019

SEP:SEPARATED REGULATOR -INC:BUILT-IN REGULATOR 02494495**REAR BEARING** 22

592857

ROTOR 04

512039

Valeo**432984/436264****9AR2852K**

55

1

14



Picture not available
Image non disponible
Imagen no disponible
Immagine non disponibile
Nicht verfügbares Bild
Brak zdjęcia
Картина недоступна

Picture not available
Image non disponible
Imagen no disponible
Immagine non disponibile
Nicht verfügbares Bild
Brak zdjęcia
Картина недоступна

BRUSH HOLDER 09

503019

SEP:SEPARATED REGULATOR -INC:BUILT-IN REGULATOR 02494495**REAR BEARING** 22

592857

ROTOR 04

512039

Valeo**432984/436264****9AR2853K**

55

1

1V

14



0°

Ø 98,7

Picture not available
Image non disponible
Imagen no disponible
Immagine non disponibile
Nicht verfügbares Bild
Brak zdjęcia
Картина недоступна

Picture not available
Image non disponible
Imagen no disponible
Immagine non disponibile
Nicht verfügbares Bild
Brak zdjęcia
Картина недоступна

BRUSH HOLDER 09

503019

SEP:SEPARATED REGULATOR -INC:BUILT-IN REGULATOR 02494495**REAR BEARING** 22

592857

ROTOR 04

512039

Valeo**432984/436264****9AR2859G**

45

1

1V

14



120°

Ø 59,7

INC

**BRUSH HOLDER** 09

494487

REAR BEARING 22

592857

ROTOR 04

512031

Valeo**432855/433387****9AR2861K**

55

1

1V

14



Ø 74,5

Picture not available
Image non disponible
Imagen no disponible
Immagine non disponibile
Nicht verfügbares Bild
Brak zdjęcia
Картина недоступна

Picture not available
Image non disponible
Imagen no disponible
Immagine non disponibile
Nicht verfügbares Bild
Brak zdjęcia
Картина недоступна

BRUSH HOLDER 09

503019

SEP:SEPARATED REGULATOR -INC:BUILT-IN REGULATOR 02494495**REAR BEARING** 22

592857

ROTOR 04

512039

Valeo**510315****9AR2867L**

65

1

1V

14



60°

Ø 61

INC

**BRUSH HOLDER** 09

494487

SEP:SEPARATED REGULATOR -INC:BUILT-IN REGULATOR 02494495**RECTIFIER OR DIODE BRIDGE ASSEMBLY** 07

501118

FAN 12

592088

REAR BEARING 22

592857

ROTOR 04

512039

STATOR 05

592625

Valeo**432856/436199****9AR2881P**

75

1

1V

14



Ø 71

Picture not available
Image non disponible
Imagen no disponible
Immagine non disponibile
Nicht verfügbares Bild
Brak zdjęcia
Картина недоступна

Picture not available
Image non disponible
Imagen no disponible
Immagine non disponibile
Nicht verfügbares Bild
Brak zdjęcia
Картина недоступна

BRUSH HOLDER 09

503025

SEP:SEPARATED REGULATOR -INC:BUILT-IN REGULATOR 02505037**REAR BEARING** 22

592857

ROTOR 04

512005

STATOR 05

592625

Valeo**510843****9AR2882F03**

35

1

1V

14



Ø 80

Picture not available
Image non disponible
Imagen no disponible
Immagine non disponibile
Nicht verfügbares Bild
Brak zdjęcia
Картина недоступна

Picture not available
Image non disponible
Imagen no disponible
Immagine non disponibile
Nicht verfügbares Bild
Brak zdjęcia
Картина недоступна

BRUSH HOLDER 09

494487

SEP:SEPARATED REGULATOR -INC:BUILT-IN REGULATOR 02505031**REAR BEARING** 22

592857

ROTOR 04

512031

Valeo**510336**

9AR2882F04 35 1 1V
14 ↻ ∅ 80

Picture not available
Image non disponible
Imagen no disponible
Immagine non disponibile
Nicht verfügbares Bild
Brak zdjęcia
Картина недоступна

Picture not available
Image non disponible
Imagen no disponible
Immagine non disponibile
Nicht verfügbares Bild
Brak zdjęcia
Картина недоступна

BRUSH HOLDER 09 494487
SEP:SEPARATED REGULATOR -INC:BUILT-IN REGULATOR 02505031
REAR BEARING 22 592857
ROTOR 04 512031
Valeo 590037

9AR2884L 65 1 1V
14 ↻ 15° ∅ 71 INC



REAR BEARING 22 590619
BRUSH HOLDER 09 494487
FAN 12 592088
PROTECTION COVER 24 523100
ROTOR 04 512039
STATOR 05 592625
Valeo 432861/436197

9AR2890G 45 2 1V
14 ↻ ∅ 66

Picture not available
Image non disponible
Imagen no disponible
Immagine non disponibile
Nicht verfügbares Bild
Brak zdjęcia
Картина недоступна

Picture not available
Image non disponible
Imagen no disponible
Immagine non disponibile
Nicht verfügbares Bild
Brak zdjęcia
Картина недоступна

BRUSH HOLDER 09 494487
SEP:SEPARATED REGULATOR -INC:BUILT-IN REGULATOR 02505032
RECTIFIER OR DIODE BRIDGE ASSEMBLY 07 494476
REAR BEARING 22 592857
ROTOR 04 512031
Valeo 432986

9AR2895F 35 2 1V
14 ↻ ∅ 77,3

Picture not available
Image non disponible
Imagen no disponible
Immagine non disponibile
Nicht verfügbares Bild
Brak zdjęcia
Картина недоступна

Picture not available
Image non disponible
Imagen no disponible
Immagine non disponibile
Nicht verfügbares Bild
Brak zdjęcia
Картина недоступна

BRUSH HOLDER 09 494489
SEP:SEPARATED REGULATOR -INC:BUILT-IN REGULATOR 02505032
RECTIFIER OR DIODE BRIDGE ASSEMBLY 07 494476
REAR BEARING 22 592857
ROTOR 04 512031
Valeo 510325

9AR2895F02 35 2 1V
14 ↻ ∅ 77,3

Picture not available
Image non disponible
Imagen no disponible
Immagine non disponibile
Nicht verfügbares Bild
Brak zdjęcia
Картина недоступна

Picture not available
Image non disponible
Imagen no disponible
Immagine non disponibile
Nicht verfügbares Bild
Brak zdjęcia
Картина недоступна

BRUSH HOLDER 09 494489
SEP:SEPARATED REGULATOR -INC:BUILT-IN REGULATOR 02505032
RECTIFIER OR DIODE BRIDGE ASSEMBLY 07 494476
REAR BEARING 22 592857
ROTOR 04 512031
Valeo 510450

9AR2895F03 35 2 1V
14 ↻ ∅ 66

Picture not available
Image non disponible
Imagen no disponible
Immagine non disponibile
Nicht verfügbares Bild
Brak zdjęcia
Картина недоступна

Picture not available
Image non disponible
Imagen no disponible
Immagine non disponibile
Nicht verfügbares Bild
Brak zdjęcia
Картина недоступна

BRUSH HOLDER 09 494489
SEP:SEPARATED REGULATOR -INC:BUILT-IN REGULATOR 02505032
RECTIFIER OR DIODE BRIDGE ASSEMBLY 07 494476
REAR BEARING 22 592857
ROTOR 04 512031
Valeo 510451

9AR2896G 45 1 1V
14 ↻ ∅ 71

Picture not available
Image non disponible
Imagen no disponible
Immagine non disponibile
Nicht verfügbares Bild
Brak zdjęcia
Картина недоступна

Picture not available
Image non disponible
Imagen no disponible
Immagine non disponibile
Nicht verfügbares Bild
Brak zdjęcia
Картина недоступна

BRUSH HOLDER 09 494489
SEP:SEPARATED REGULATOR -INC:BUILT-IN REGULATOR 02505031
RECTIFIER OR DIODE BRIDGE ASSEMBLY 07 494476
REAR BEARING 22 592857
ROTOR 04 512031
Valeo 432859

9AR2897L 65 1 1V
14 ↻ 15° ∅ 71

Picture not available
Image non disponible
Imagen no disponible
Immagine non disponibile
Nicht verfügbares Bild
Brak zdjęcia
Картина недоступна

Picture not available
Image non disponible
Imagen no disponible
Immagine non disponibile
Nicht verfügbares Bild
Brak zdjęcia
Картина недоступна

BRUSH HOLDER 09 494487
SEP:SEPARATED REGULATOR -INC:BUILT-IN REGULATOR 02494495
FAN 12 592088
REAR BEARING 22 592857
ROTOR 04 512039
STATOR 05 592625
Valeo 432861

9AR2909P

70

1

1V

14



Ø 83,7

Picture not available
Image non disponible
Imagem no disponibile
Immagine non disponibile
Nicht verfügbares Bild
Brak zdjęćia
Картина недоступна

Picture not available
Image non disponible
Imagem no disponibile
Immagine non disponibile
Nicht verfügbares Bild
Brak zdjęćia
Картина недоступна

BRUSH HOLDER 09

494487

SEP:SEPARATED REGULATOR -INC:BUILT-IN REGULATOR 02494495**RECTIFIER OR DIODE BRIDGE ASSEMBLY** 07

592554

REAR BEARING 22

592857

PROTECTION COVER 24

494507

ROTOR 04

512039

STATOR 05

592625

Valeo **510333****9AR2917G**

45

2

SP

14



60°

INC

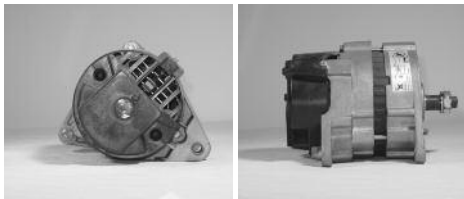
**BRUSH HOLDER** 09

494489

SEP:SEPARATED REGULATOR -INC:BUILT-IN REGULATOR 02505032**RECTIFIER OR DIODE BRIDGE ASSEMBLY** 07

494476

REAR BEARING 22

592857

Valeo **432862/433485****9AR2918G**

45

2

14

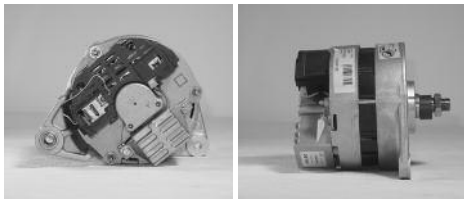

INC

**BRUSH HOLDER** 09

494487

SEP:SEPARATED REGULATOR -INC:BUILT-IN REGULATOR 02505032**RECTIFIER OR DIODE BRIDGE ASSEMBLY** 07

494476

REAR BEARING 22

592857

Valeo **432863/436140****9AR2919P**

70

2

1V

14



Ø 66

Picture not available
Image non disponible
Imagem no disponibile
Immagine non disponibile
Nicht verfügbares Bild
Brak zdjęćia
Картина недоступна

Picture not available
Image non disponible
Imagem no disponibile
Immagine non disponibile
Nicht verfügbares Bild
Brak zdjęćia
Картина недоступна

BRUSH HOLDER 09

503019

SEP:SEPARATED REGULATOR -INC:BUILT-IN REGULATOR 02494495**FAN** 12

592088

REAR BEARING 22

592857

ROTOR 04

512005

STATOR 05

592625

Valeo **432864****9AR2920P**

70

2

1V

14



60°

Ø 66

INC

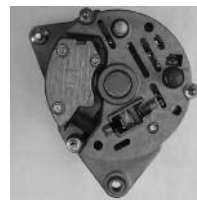
**BRUSH HOLDER** 09

503019

SEP:SEPARATED REGULATOR -INC:BUILT-IN REGULATOR 02494495**FAN** 12

592088

REAR BEARING 22

592857

ROTOR 04

512005

STATOR 05

592625

Valeo **432865/433486****9AR2929G**

45

2

14



Picture not available
Image non disponible
Imagem no disponibile
Immagine non disponibile
Nicht verfügbares Bild
Brak zdjęćia
Картина недоступна

Picture not available
Image non disponible
Imagem no disponibile
Immagine non disponibile
Nicht verfügbares Bild
Brak zdjęćia
Картина недоступна

BRUSH HOLDER 09

494487

SEP:SEPARATED REGULATOR -INC:BUILT-IN REGULATOR 02505032**RECTIFIER OR DIODE BRIDGE ASSEMBLY** 07

494476

REAR BEARING 22

592857

Valeo **510358****9AR2930G**

45

1

14



Picture not available
Image non disponible
Imagem no disponibile
Immagine non disponibile
Nicht verfügbares Bild
Brak zdjęćia
Картина недоступна

Picture not available
Image non disponible
Imagem no disponibile
Immagine non disponibile
Nicht verfügbares Bild
Brak zdjęćia
Картина недоступна

BRUSH HOLDER 09

494487

SEP:SEPARATED REGULATOR -INC:BUILT-IN REGULATOR 02494495**RECTIFIER OR DIODE BRIDGE ASSEMBLY** 07

592554

REAR BEARING 22

592857

PROTECTION COVER 24

494507

ROTOR 04

512039

Valeo **510359****9AR2933P**

70

2

1V

14



Ø 59,7

Picture not available
Image non disponible
Imagem no disponibile
Immagine non disponibile
Nicht verfügbares Bild
Brak zdjęćia
Картина недоступна

Picture not available
Image non disponible
Imagem no disponibile
Immagine non disponibile
Nicht verfügbares Bild
Brak zdjęćia
Картина недоступна

BRUSH HOLDER 09

494488

FAN 12

592088

REAR BEARING 22

592857

ROTOR 04

512005

STATOR 05

592625

Valeo **432786**

9AR2935P

70 2 1V

14 ↻ ∅ 59,7

Picture not available
Image non disponible
Imagen no disponible
Immagine non disponibile
Nicht verfügbares Bild
Brak zdjęcia
Картина недоступна

Picture not available
Image non disponible
Imagen no disponible
Immagine non disponibile
Nicht verfügbares Bild
Brak zdjęcia
Картина недоступна

BRUSH HOLDER 09 494488
REAR BEARING 22 592857
ROTOR 04 512005
STATOR 05 592625
Valeo **432787**

9AR2938T

90 2 1V

14 ↻ ∅ 56

Picture not available
Image non disponible
Imagen no disponible
Immagine non disponibile
Nicht verfügbares Bild
Brak zdjęcia
Картина недоступна

Picture not available
Image non disponible
Imagen no disponible
Immagine non disponibile
Nicht verfügbares Bild
Brak zdjęcia
Картина недоступна

BRUSH HOLDER 09 494487
RECTIFIER OR DIODE BRIDGE ASSEMBLY 07 592651
FAN 12 592088
REAR BEARING 22 592857
STATOR 05 592625
Valeo **432866**

9AR2951L

65 2 1V

14 ↻ 0° ∅ 77 INC

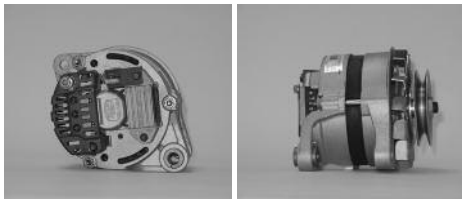
**B+(M6)D+(M8)**

BRUSH HOLDER 09 494488
BRUSH HOLDER 09 494488
RECTIFIER OR DIODE BRIDGE ASSEMBLY 07 501096
RECTIFIER OR DIODE BRIDGE ASSEMBLY 07 501096
REAR BEARING 22 592857
REAR BEARING 22 592857
ROTOR 04 512039
ROTOR 04 512039
STATOR 05 592625
STATOR 05 592625

9AR2951L

65 2 1V

14 ↻ 0° ∅ 77 INC

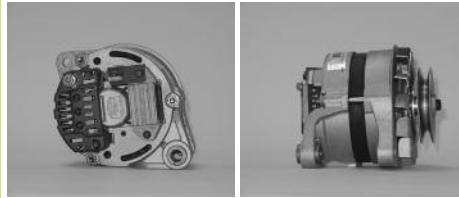
**B+(M6)D+(M8)**

BRUSH HOLDER 09 494488
BRUSH HOLDER 09 494488
RECTIFIER OR DIODE BRIDGE ASSEMBLY 07 501096
RECTIFIER OR DIODE BRIDGE ASSEMBLY 07 501096
REAR BEARING 22 592857
REAR BEARING 22 592857
ROTOR 04 512039
ROTOR 04 512039
STATOR 05 592625
STATOR 05 592625
Valeo **432868/436237**

9AR2958P

70 2 1V

14 ↻ ∅ 77,3

Picture not available
Image non disponible
Imagen no disponible
Immagine non disponibile
Nicht verfügbares Bild
Brak zdjęcia
Картина недоступна

Picture not available
Image non disponible
Imagen no disponible
Immagine non disponibile
Nicht verfügbares Bild
Brak zdjęcia
Картина недоступна

REAR BEARING 22 590619
BRUSH HOLDER 09 503012
SEP:SEPARATED REGULATOR -INC:BUILT-IN REGULATOR 02 505037
RECTIFIER OR DIODE BRIDGE ASSEMBLY 07 501096
FAN 12 592088
PULLEY 11 *507101
ROTOR 04 512005
STATOR 05 592625
Valeo **510859**

9AR2963L

65 2 1V

14 ↻ ∅ 71

Picture not available
Image non disponible
Imagen no disponible
Immagine non disponibile
Nicht verfügbares Bild
Brak zdjęcia
Картина недоступна

Picture not available
Image non disponible
Imagen no disponible
Immagine non disponibile
Nicht verfügbares Bild
Brak zdjęcia
Картина недоступна

BRUSH HOLDER 09 503019
SEP:SEPARATED REGULATOR -INC:BUILT-IN REGULATOR 02 494495
FAN 12 592088
REAR BEARING 22 592857
ROTOR 04 512039
STATOR 05 592625
Valeo **510379**

9AR2968K

50

1

14



Picture not available
Image non disponible
Imagem no disponibile
Immagine non disponibile
Nicht verfügbares Bild
Brak zdjęcia
Картина недоступна

Picture not available
Image non disponible
Imagem no disponibile
Immagine non disponibile
Nicht verfügbares Bild
Brak zdjęcia
Картина недоступна

BRUSH HOLDER 09

494487

REAR BEARING 22

592857

ROTOR 04

512031

Valeo**432993/436267****9AR2971G**

45

1

1V

14



15°

Ø 61

INC

**REAR BEARING** 22

592857

Valeo**432882/436294****9AR2972G**

45

1

1V

14



15°

Ø 61

INC

**REAR BEARING** 22

592857

Valeo**433047/436193****9AR2973L**

65

1

1V

14



Ø 56

Picture not available
Image non disponible
Imagem no disponibile
Immagine non disponibile
Nicht verfügbares Bild
Brak zdjęcia
Картина недоступна

Picture not available
Image non disponible
Imagem no disponibile
Immagine non disponibile
Nicht verfügbares Bild
Brak zdjęcia
Картина недоступна

REAR BEARING 22

590619

FAN 12

592088

PULLEY 11

592669

STATOR 05

592625

Valeo**432881****9AR2974L**

65

1

1V

14



15°

Ø 61

INC

**FAN** 12

592088

REAR BEARING 22

592857

STATOR 05

592625

Valeo**432882/436294****9AR2975L**

65

1

1V

14



15°

Ø 61

INC

**FAN** 12

592088

REAR BEARING 22

592857

STATOR 05

592625

Valeo**433048/436400****9AR2976K**

55

1

1V

14



Ø 61

INC

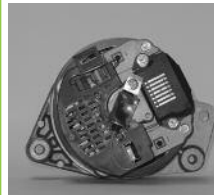
**REAR BEARING** 22

592857

Valeo**432883/436220****9AR2977L**

65

1

1V

14



60°

Ø 61

INC

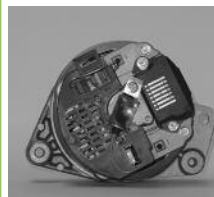
**FAN** 12

592088

REAR BEARING 22

592857

STATOR 05

592625

Valeo**432883/436220****9AR2978F**

35

2

14



Picture not available
Image non disponible
Imagem no disponibile
Immagine non disponibile
Nicht verfügbares Bild
Brak zdjęcia
Картина недоступна

Picture not available
Image non disponible
Imagem no disponibile
Immagine non disponibile
Nicht verfügbares Bild
Brak zdjęcia
Картина недоступна

REAR BEARING 22

590619

BRUSH HOLDER 09

494489

SEP:SEPARATED REGULATOR -INC:BUILT-IN REGULATOR 02 505032**RECTIFIER OR DIODE BRIDGE ASSEMBLY** 07

494476

FAN 12

*507067

ROTOR 04

512031

Valeo**510325**

9AR2990P

70

2

1V

14



Ø 66

Picture not available
Image non disponible
Imagen no disponible
Immagine non disponibile
Nicht verfügbares Bild
Brak zdjęcia
Картина недоступна

Picture not available
Image non disponible
Imagen no disponible
Immagine non disponibile
Nicht verfügbares Bild
Brak zdjęcia
Картина недоступна

BRUSH HOLDER 09 503019
SEP:SEPARATED REGULATOR -INC:BUILT-IN REGULATOR 02 505029
RECTIFIER OR DIODE BRIDGE ASSEMBLY 07 592554
FAN 12 592088
REAR BEARING 22 592857
PROTECTION COVER 24 494507
ROTOR 04 512005
STATOR 05 592625
Valeo 432870

9AR2992P

70

2

2V

14



Ø 76

Picture not available
Image non disponible
Imagen no disponible
Immagine non disponibile
Nicht verfügbares Bild
Brak zdjęcia
Картина недоступна

Picture not available
Image non disponible
Imagen no disponible
Immagine non disponibile
Nicht verfügbares Bild
Brak zdjęcia
Картина недоступна

FRONT BEARING 21 593224
REAR BEARING 22 590619
RECTIFIER OR DIODE BRIDGE ASSEMBLY 07 592650
FAN 12 592672
PULLEY 11 490512
REAR BRACKET 25 518005
ROTOR 04 512005
STATOR 05 592625
Valeo 510401

9AR2999P

70

2

1V

14



Ø 77,3

Picture not available
Image non disponible
Imagen no disponible
Immagine non disponibile
Nicht verfügbares Bild
Brak zdjęcia
Картина недоступна

Picture not available
Image non disponible
Imagen no disponible
Immagine non disponibile
Nicht verfügbares Bild
Brak zdjęcia
Картина недоступна

BRUSH HOLDER 09 503025
SEP:SEPARATED REGULATOR -INC:BUILT-IN REGULATOR 02 505038
CONDENSOR 14 517009
RECTIFIER OR DIODE BRIDGE ASSEMBLY 07 501096
FAN 12 592088
REAR BEARING 22 592857
ROTOR 04 512005
STATOR 05 592625
Valeo 510863

9AR3713G

45

1

SP

28



Picture not available
Image non disponible
Imagen no disponible
Immagine non disponibile
Nicht verfügbares Bild
Brak zdjęcia
Картина недоступна

Picture not available
Image non disponible
Imagen no disponible
Immagine non disponibile
Nicht verfügbares Bild
Brak zdjęcia
Картина недоступна

BRUSH HOLDER 09 503025
SEP:SEPARATED REGULATOR -INC:BUILT-IN REGULATOR 02 505035
FAN 12 592088
REAR BEARING 22 592857
Valeo 510804

9AR3721G

45

2

28



Picture not available
Image non disponible
Imagen no disponible
Immagine non disponibile
Nicht verfügbares Bild
Brak zdjęcia
Картина недоступна

Picture not available
Image non disponible
Imagen no disponible
Immagine non disponibile
Nicht verfügbares Bild
Brak zdjęcia
Картина недоступна

BRUSH HOLDER 09 503019
SEP:SEPARATED REGULATOR -INC:BUILT-IN REGULATOR 02 494498
RECTIFIER OR DIODE BRIDGE ASSEMBLY 07 501118
FAN 12 592088
REAR BEARING 22 592857
Valeo 100896/436347

9AR3743G

45

1

1V

28



Ø 80

Picture not available
Image non disponible
Imagen no disponible
Immagine non disponibile
Nicht verfügbares Bild
Brak zdjęcia
Картина недоступна

Picture not available
Image non disponible
Imagen no disponible
Immagine non disponibile
Nicht verfügbares Bild
Brak zdjęcia
Картина недоступна

BRUSH HOLDER 09 503025
SEP:SEPARATED REGULATOR -INC:BUILT-IN REGULATOR 02 505039
CONDENSOR 14 517009
FAN 12 592088
REAR BEARING 22 592857
Valeo 510821

9AR3806G

40

2

2V

28



20°

Ø 76

Picture not available
Image non disponible
Imagen no disponible
Immagine non disponibile
Nicht verfügbares Bild
Brak zdjęcia
Картина недоступна

Picture not available
Image non disponible
Imagen no disponible
Immagine non disponibile
Nicht verfügbares Bild
Brak zdjęcia
Картина недоступна

BRUSH HOLDER 09 503019
FAN 12 592088
REAR BEARING 22 592857
Valeo 101375/436347

9AR3868G

45

1

2V

28



Ø 81

Picture not available
Image non disponible
Imagen no disponible
Immagine non disponibile
Nicht verfügbares Bild
Brak zdjęćia
Картина недоступна

Picture not available
Image non disponible
Imagen no disponible
Immagine non disponibile
Nicht verfügbares Bild
Brak zdjęćia
Картина недоступна

BRUSH HOLDER 09

503019

SEP:SEPARATED REGULATOR -INC:BUILT-IN REGULATOR 02494498**RECTIFIER OR DIODE BRIDGE ASSEMBLY** 07

501118

FAN 12

592088

PULLEY 11

593380

REAR BEARING 22

592857

Valeo**510289****9AR3894D**

25

1

1V

28

Ø 55,4

Picture not available
Image non disponible
Imagen no disponible
Immagine non disponibile
Nicht verfügbares Bild
Brak zdjęćia
Картина недоступна

Picture not available
Image non disponible
Imagen no disponible
Immagine non disponibile
Nicht verfügbares Bild
Brak zdjęćia
Картина недоступна

BRUSH HOLDER 09

503025

SEP:SEPARATED REGULATOR -INC:BUILT-IN REGULATOR 02505039**CONDENSOR** 14

517009

FAN 12

592088

REAR BEARING 22

592857

Valeo**510844****9AR3921G**

45

1

1V

28



30°

Ø 66

Picture not available
Image non disponible
Imagen no disponible
Immagine non disponibile
Nicht verfügbares Bild
Brak zdjęćia
Картина недоступна

Picture not available
Image non disponible
Imagen no disponible
Immagine non disponibile
Nicht verfügbares Bild
Brak zdjęćia
Картина недоступна

BRUSH HOLDER 09

503019

FAN 12

592088

PULLEY 11

096879

REAR BEARING 22

592857

PROTECTION COVER 24

494507

Valeo**510348/436437****9AR3927G**

40

1

28



Picture not available
Image non disponible
Imagen no disponible
Immagine non disponibile
Nicht verfügbares Bild
Brak zdjęćia
Картина недоступна

Picture not available
Image non disponible
Imagen no disponible
Immagine non disponibile
Nicht verfügbares Bild
Brak zdjęćia
Картина недоступна

BRUSH HOLDER 09

503019

RECTIFIER OR DIODE BRIDGE ASSEMBLY 07

501118

REAR BEARING 22

592857

9AR3927G

40

1

28



Picture not available
Image non disponible
Imagen no disponible
Immagine non disponibile
Nicht verfügbares Bild
Brak zdjęćia
Картина недоступна

Picture not available
Image non disponible
Imagen no disponible
Immagine non disponibile
Nicht verfügbares Bild
Brak zdjęćia
Картина недоступна

BRUSH HOLDER 09

503019

RECTIFIER OR DIODE BRIDGE ASSEMBLY 07

501118

REAR BEARING 22

592857

9AR3927G

40

1

28



Picture not available
Image non disponible
Imagen no disponible
Immagine non disponibile
Nicht verfügbares Bild
Brak zdjęćia
Картина недоступна

Picture not available
Image non disponible
Imagen no disponible
Immagine non disponibile
Nicht verfügbares Bild
Brak zdjęćia
Картина недоступна

BRUSH HOLDER 09

503019

RECTIFIER OR DIODE BRIDGE ASSEMBLY 07

501118

REAR BEARING 22

592857

9AR3927G

40

1

28



Picture not available
Image non disponible
Imagen no disponible
Immagine non disponibile
Nicht verfügbares Bild
Brak zdjęćia
Картина недоступна

Picture not available
Image non disponible
Imagen no disponible
Immagine non disponibile
Nicht verfügbares Bild
Brak zdjęćia
Картина недоступна

BRUSH HOLDER 09

503019

RECTIFIER OR DIODE BRIDGE ASSEMBLY 07

501118

REAR BEARING 22

592857

9AR3927G

40

1

28



Picture not available
Image non disponible
Imagen no disponible
Immagine non disponibile
Nicht verfügbares Bild
Brak zdjęćia
Картина недоступна

Picture not available
Image non disponible
Imagen no disponible
Immagine non disponibile
Nicht verfügbares Bild
Brak zdjęćia
Картина недоступна

BRUSH HOLDER 09

503019

RECTIFIER OR DIODE BRIDGE ASSEMBLY 07

501118

REAR BEARING 22

592857

Valeo**510372/436558**

9AR3949K 55 2

28 ↻

Picture not available
Image non disponible
Imagen no disponible
Immagine non disponibile
Nicht verfügbares Bild
Brak zdjęcia
Картина недоступна

Picture not available
Image non disponible
Imagen no disponible
Immagine non disponibile
Nicht verfügbares Bild
Brak zdjęcia
Картина недоступна

BRUSH HOLDER 09 494488
SEP:SEPARATED REGULATOR -INC:BUILT-IN REGULATOR 02494500
RECTIFIER OR DIODE BRIDGE ASSEMBLY 07 592554
FAN 12 592088
PROTECTION COVER 24 494507
Valeo 510377

9AR3987G 40 1 2V

28 ↻ 22° ∇ Ø 88

Picture not available
Image non disponible
Imagen no disponible
Immagine non disponibile
Nicht verfügbares Bild
Brak zdjęcia
Картина недоступна

Picture not available
Image non disponible
Imagen no disponible
Immagine non disponibile
Nicht verfügbares Bild
Brak zdjęcia
Картина недоступна

BRUSH HOLDER 09 503019
RECTIFIER OR DIODE BRIDGE ASSEMBLY 07 50118
FAN 12 592088
PULLEY 11 507128
Valeo 510397/436421

9AR3952G 40 2

28 ↻

Picture not available
Image non disponible
Imagen no disponible
Immagine non disponibile
Nicht verfügbares Bild
Brak zdjęcia
Картина недоступна

Picture not available
Image non disponible
Imagen no disponible
Immagine non disponibile
Nicht verfügbares Bild
Brak zdjęcia
Картина недоступна

BRUSH HOLDER 09 494488
SEP:SEPARATED REGULATOR -INC:BUILT-IN REGULATOR 02505107
RECTIFIER OR DIODE BRIDGE ASSEMBLY 07 501096
REAR BEARING 22 592857
Valeo 510391/436416

9AR5001K 55 1 1V

14 ↻ ∇ Ø 66

Picture not available
Image non disponible
Imagen no disponible
Immagine non disponibile
Nicht verfügbares Bild
Brak zdjęcia
Картина недоступна

Picture not available
Image non disponible
Imagen no disponible
Immagine non disponibile
Nicht verfügbares Bild
Brak zdjęcia
Картина недоступна

BRUSH HOLDER 09 503019
SEP:SEPARATED REGULATOR -INC:BUILT-IN REGULATOR 02494495
RECTIFIER OR DIODE BRIDGE ASSEMBLY 07 592554
REAR BEARING 22 592857
PROTECTION COVER 24 494507
ROTOR 04 512039
Valeo 432989/436266

9AR3959G 40 2 1V

28 ↻ Ø 77,3

Picture not available
Image non disponible
Imagen no disponible
Immagine non disponibile
Nicht verfügbares Bild
Brak zdjęcia
Картина недоступна

Picture not available
Image non disponible
Imagen no disponible
Immagine non disponibile
Nicht verfügbares Bild
Brak zdjęcia
Картина недоступна

REAR BEARING 22 590619
BRUSH HOLDER 09 503012
SEP:SEPARATED REGULATOR -INC:BUILT-IN REGULATOR 02505094
RECTIFIER OR DIODE BRIDGE ASSEMBLY 07 501096
FAN 12 592088
PULLEY 11 *507101
Valeo 510860

9AR5006G 45 2 1V

14 ↻ Ø 77 INC



BRUSH HOLDER 09 494488
FAN 12 590553
REAR BEARING 22 592857
ROTOR 04 512039
Valeo 432991/436109

9AR3961G 40 2 2V

28 ↻ Ø 65

Picture not available
Image non disponible
Imagen no disponible
Immagine non disponibile
Nicht verfügbares Bild
Brak zdjęcia
Картина недоступна

Picture not available
Image non disponible
Imagen no disponible
Immagine non disponibile
Nicht verfügbares Bild
Brak zdjęcia
Картина недоступна

BRUSH HOLDER 09 503019
FAN 12 592088
REAR BEARING 22 592857
Valeo 510388

9AR5028K02 55 1 1V

14 ↻ Ø 71 INC



REAR BEARING 22 590619
ROTOR 04 512005
Valeo 436121

9AR5034P

70

2

14



Picture not available
Image non disponible
Imagem no disponibile
Immagine non disponibile
Nicht verfügbares Bild
Brak zdjęćia
Картина недоступна

Picture not available
Image non disponible
Imagem no disponibile
Immagine non disponibile
Nicht verfügbares Bild
Brak zdjęćia
Картина недоступна

BRUSH HOLDER 09

503025

SEP:SEPARATED REGULATOR -INC:BUILT-IN REGULATOR 02505038**CONDENSOR** 14 517009**RECTIFIER OR DIODE BRIDGE ASSEMBLY** 07 501096**REAR BEARING** 22 592857**ROTOR** 04 512005**STATOR** 05 592625**Valeo** 432874/436135**9AR5037L**

65

1

1V

14



Ø 61

INC

**B+(M6)D+(M5)****BRUSH HOLDER** 09 494487**SEP:SEPARATED REGULATOR -INC:BUILT-IN REGULATOR** 02494495**FAN** 12 592088**REAR BEARING** 22 592857**ROTOR** 04 512005**STATOR** 05 592625**9AR5037L**

65

1

1V

14



Ø 61

INC

**B+(M6)D+(M5)****BRUSH HOLDER** 09 494487**SEP:SEPARATED REGULATOR -INC:BUILT-IN REGULATOR** 02494495**FAN** 12 592088**REAR BEARING** 22 592857**ROTOR** 04 512005**STATOR** 05 592625**Valeo** 432872/436131**9AR5038L**

65

1

1V

14



Ø 61

INC

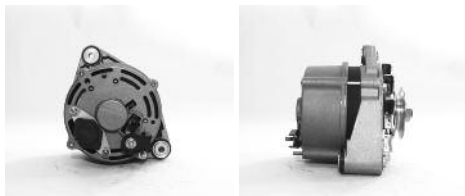
**REAR BEARING** 22 590619**BRUSH HOLDER** 09 494487**SEP:SEPARATED REGULATOR -INC:BUILT-IN REGULATOR** 02494495**RECTIFIER OR DIODE BRIDGE ASSEMBLY** 07 501098**FAN** 12 592088**ROTOR** 04 512005**STATOR** 05 592625**Valeo** 432873/436598**9AR5039L**

65

1

1V

14



Ø 61

INC

**BRUSH HOLDER** 09 494487**SEP:SEPARATED REGULATOR -INC:BUILT-IN REGULATOR** 02494495**FAN** 12 592088**REAR BEARING** 22 592857**ROTOR** 04 512005**STATOR** 05 592625**Valeo** 432874/436135**9AR5043P**

70

1

1V

14



Ø 77,3

INC

**B+(M6)D+(M5)**
W(M5)**BRUSH HOLDER** 09 503019**SEP:SEPARATED REGULATOR -INC:BUILT-IN REGULATOR** 02494495**FAN** 12 592088**REAR BEARING** 22 592857**ROTOR** 04 512005**STATOR** 05 592625**Valeo** 432875/436139**9AR5044K**

55

1

1V

14



Ø 56

INC

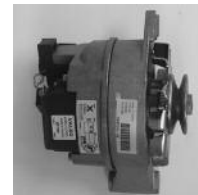
**REAR BEARING** 22 592857**Valeo** 432861/436196**9AR5048P**

70

1

1V

14



Ø 59,7

INC

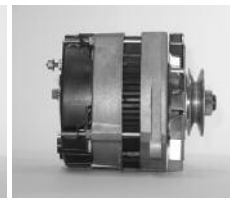
**BRUSH HOLDER** 09 494488**FAN** 12 592088**REAR BEARING** 22 592857**ROTOR** 04 512005**STATOR** 05 592625**Valeo** 432739/433358

9AR5049K	55	2	1V
14	↻	0°	Ø 66 INC



BRUSH HOLDER 09 494488
FAN 12 590553
REAR BEARING 22 592857
ROTOR 04 512039
Valeo 432876/433483

9AR5052U	80	1	1V
14	↻		Ø 69,7

Picture not available
Image non disponible
Imagen no disponible
Immagine non disponibile
Nicht verfügbares Bild
Brak zdjęć
Картина недоступна

Picture not available
Image non disponible
Imagen no disponible
Immagine non disponibile
Nicht verfügbares Bild
Brak zdjęć
Картина недоступна

BRUSH HOLDER 09 494487
RECTIFIER OR DIODE BRIDGE ASSEMBLY 07 592651
FAN 12 592088
REAR BEARING 22 592857
Valeo 510474

9AR5062K	55	1	1V
14	↻		Ø 59,7 INC



BRUSH HOLDER 09 494488
RECTIFIER OR DIODE BRIDGE ASSEMBLY 07 592554
REAR BEARING 22 592857
ROTOR 04 512039
Valeo 432739/433358

9AR5071F	35	1	1V
14	↻	42°	Ø 70

Picture not available
Image non disponible
Imagen no disponible
Immagine non disponibile
Nicht verfügbares Bild
Brak zdjęć
Картина недоступна

Picture not available
Image non disponible
Imagen no disponible
Immagine non disponibile
Nicht verfügbares Bild
Brak zdjęć
Картина недоступна

BRUSH HOLDER 09 494487
SEP:SEPARATED REGULATOR -INC:BUILT-IN REGULATOR 02505031
RECTIFIER OR DIODE BRIDGE ASSEMBLY 07 494476
REAR BEARING 22 592857
ROTOR 04 512031
Valeo 433479

9AR5080K	55	1	1V
14	↻		Ø 56

Picture not available
Image non disponible
Imagen no disponible
Immagine non disponibile
Nicht verfügbares Bild
Brak zdjęć
Картина недоступна

Picture not available
Image non disponible
Imagen no disponible
Immagine non disponibile
Nicht verfügbares Bild
Brak zdjęć
Картина недоступна

BRUSH HOLDER 09 503205
SEP:SEPARATED REGULATOR -INC:BUILT-IN REGULATOR 02505037
RECTIFIER OR DIODE BRIDGE ASSEMBLY 07 501096
REAR BEARING 22 592857
ROTOR 04 512039
Valeo 510871

9AR5084L	65	1	1V
14	↻		Ø 56 INC

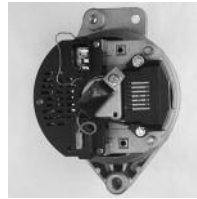

FAN 12 592088
REAR BEARING 22 592857
STATOR 05 592625

9AR5084L	65	1	1V
14	↻		Ø 56 INC

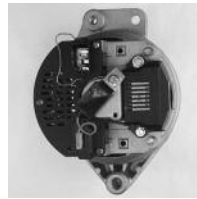

FAN 12 592088
REAR BEARING 22 592857
STATOR 05 592625
Valeo 432881/436601

9AR5086L	65	1	1V
14	↻		Ø 61 INC

Picture not available
Image non disponible
Imagen no disponible
Immagine non disponibile
Nicht verfügbares Bild
Brak zdjęć
Картина недоступна

Picture not available
Image non disponible
Imagen no disponible
Immagine non disponibile
Nicht verfügbares Bild
Brak zdjęć
Картина недоступна

FAN 12 592088
REAR BEARING 22 592857
STATOR 05 592625

9AR5086L

65

1

1V

14



Ø 61

INC

Picture not available
Image non disponible
Imagen no disponible
Immagine non disponibile
Nicht verfügbares Bild
Brak zdjęcia
Картина недоступна

Picture not available
Image non disponible
Imagen no disponible
Immagine non disponibile
Nicht verfügbares Bild
Brak zdjęcia
Картина недоступна

FAN 12

592088

REAR BEARING 22

592857

STATOR 05

592625

Valeo**432882/436294****9AR5088L**

65

1

1V

14



Ø 66

Picture not available
Image non disponible
Imagen no disponible
Immagine non disponibile
Nicht verfügbares Bild
Brak zdjęcia
Картина недоступна

Picture not available
Image non disponible
Imagen no disponible
Immagine non disponibile
Nicht verfügbares Bild
Brak zdjęcia
Картина недоступна

FAN 12

592088

REAR BEARING 22

592857

STATOR 05

592625

Valeo**432883****9AR5092K**

55

2

2V

14



Ø 56

Picture not available
Image non disponible
Imagen no disponible
Immagine non disponibile
Nicht verfügbares Bild
Brak zdjęcia
Картина недоступна

Picture not available
Image non disponible
Imagen no disponible
Immagine non disponibile
Nicht verfügbares Bild
Brak zdjęcia
Картина недоступна

BRUSH HOLDER 09

503019

SEP:SEPARATED REGULATOR -INC:BUILT-IN REGULATOR 02494495**REAR BEARING** 22

592857

ROTOR 04

512039

Valeo**432987****9AR5096G**

40

1

1V

14



Ø 55,8

INC

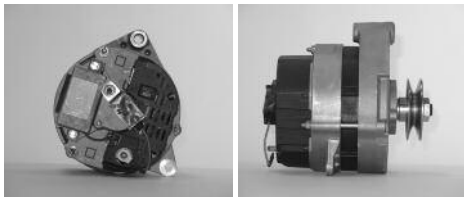
**BRUSH HOLDER** 09

494489

REAR BEARING 22

592857

ROTOR 04

512031

Valeo**432857/433352****9AR5097P**

70

2

1V

14



Ø 66

INC

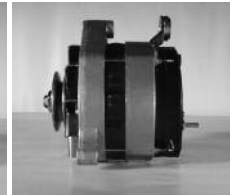
**REAR BEARING** 22

590619

BRUSH HOLDER 09

494488

PULLEY 11

096879

REAR BRACKET 25

592680

PROTECTION COVER 24

494507

ROTOR 04

512005

STATOR 05

592625

9AR5097P

70

2

1V

14



Ø 66

INC

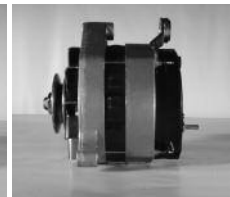
**REAR BEARING** 22

590619

BRUSH HOLDER 09

494488

PULLEY 11

096879

REAR BRACKET 25

592680

PROTECTION COVER 24

494507

ROTOR 04

512005

STATOR 05

592625

Valeo**433037/433368****9AR6000G**

40

2

1V

28



Ø 77,3

Picture not available
Image non disponible
Imagen no disponible
Immagine non disponibile
Nicht verfügbares Bild
Brak zdjęcia
Картина недоступна

Picture not available
Image non disponible
Imagen no disponible
Immagine non disponibile
Nicht verfügbares Bild
Brak zdjęcia
Картина недоступна

BRUSH HOLDER 09

503025

SEP:SEPARATED REGULATOR -INC:BUILT-IN REGULATOR 02505039**CONDENSOR** 14

517009

RECTIFIER OR DIODE BRIDGE ASSEMBLY 07

501096

FAN 12

592088

REAR BEARING 22

592857

Valeo**510864****9AR6012G**

40

1

28



60°

Picture not available
Image non disponible
Imagen no disponible
Immagine non disponibile
Nicht verfügbares Bild
Brak zdjęcia
Картина недоступна

Picture not available
Image non disponible
Imagen no disponible
Immagine non disponibile
Nicht verfügbares Bild
Brak zdjęcia
Картина недоступна

BRUSH HOLDER 09

503019

FAN 12

592088

REAR BEARING 22

592857

PROTECTION COVER 24

494507

Valeo**510427/436420**

9AR6016G

40 1 1V

28 ↻ ∅ 61

Picture not available
Image non disponible
Imagen no disponible
Immagine non disponibile
Nicht verfügbares Bild
Brak zdjęcia
Картина недоступна

Picture not available
Image non disponible
Imagen no disponible
Immagine non disponibile
Nicht verfügbares Bild
Brak zdjęcia
Картина недоступна

REAR BEARING 📏 22 590619
BRUSH HOLDER 📏 09 503025
SEP:SEPARATED REGULATOR -INC:BUILT-IN REGULATOR 📏 02 505039
CONDENSOR 📏 14 517009
FAN 📏 12 592088
Valeo 510865

9AR6025K

55 1 2V

28 ↻ ∅ 81

Picture not available
Image non disponible
Imagen no disponible
Immagine non disponibile
Nicht verfügbares Bild
Brak zdjęcia
Картина недоступна

Picture not available
Image non disponible
Imagen no disponible
Immagine non disponibile
Nicht verfügbares Bild
Brak zdjęcia
Картина недоступна

BRUSH HOLDER 📏 09 503019
SEP:SEPARATED REGULATOR -INC:BUILT-IN REGULATOR 📏 02 494498
RECTIFIER OR DIODE BRIDGE ASSEMBLY 📏 07 501118
FAN 📏 12 592088
PULLEY 📏 11 593380
REAR BEARING 📏 22 592857
Valeo 510445/436355

9AR6053L

55 1 1V

28 ↻ ∅ 69,7

Picture not available
Image non disponible
Imagen no disponible
Immagine non disponibile
Nicht verfügbares Bild
Brak zdjęcia
Картина недоступна

Picture not available
Image non disponible
Imagen no disponible
Immagine non disponibile
Nicht verfügbares Bild
Brak zdjęcia
Картина недоступна

BRUSH HOLDER 📏 09 494487
SEP:SEPARATED REGULATOR -INC:BUILT-IN REGULATOR 📏 02 494498
FAN 📏 12 592088
REAR BEARING 📏 22 592857
PROTECTION COVER 📏 24 494507
Valeo 510475

9AR6093K

55 2 1V

28 ↻ ∅ 68

Picture not available
Image non disponible
Imagen no disponible
Immagine non disponibile
Nicht verfügbares Bild
Brak zdjęcia
Картина недоступна

Picture not available
Image non disponible
Imagen no disponible
Immagine non disponibile
Nicht verfügbares Bild
Brak zdjęcia
Картина недоступна

BRUSH HOLDER 📏 09 494488
SEP:SEPARATED REGULATOR -INC:BUILT-IN REGULATOR 📏 02 494500
RECTIFIER OR DIODE BRIDGE ASSEMBLY 📏 07 592554
FAN 📏 12 592088
PROTECTION COVER 📏 24 494507
Valeo 510514

A11M10

28 1 1V

14 ↻ 45° ∅ 55,4 INC

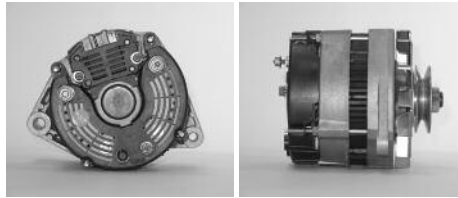

BRUSH HOLDER 📏 09 096026
Valeo 433036/433354

A11M12

30 1 1V

14 ↻ 60° ∅ 55,4 SEP

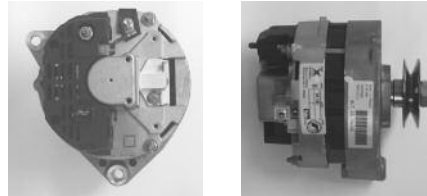

BRUSH HOLDER 📏 09 096026
Valeo 432834/433351

A11M14

28 1

14 ↻

Picture not available
Image non disponible
Imagen no disponible
Immagine non disponibile
Nicht verfügbares Bild
Brak zdjęcia
Картина недоступна

Picture not available
Image non disponible
Imagen no disponible
Immagine non disponibile
Nicht verfügbares Bild
Brak zdjęcia
Картина недоступна

BRUSH HOLDER 📏 09 096026
Valeo 102794

A11R2

38 1 1V

14 ↻ ∅ 55,4

Picture not available
Image non disponible
Imagen no disponible
Immagine non disponibile
Nicht verfügbares Bild
Brak zdjęcia
Картина недоступна

Picture not available
Image non disponible
Imagen no disponible
Immagine non disponibile
Nicht verfügbares Bild
Brak zdjęcia
Картина недоступна

BRUSH HOLDER 📏 09 096026
RECTIFIER OR DIODE BRIDGE ASSEMBLY 📏 07 092086
Valeo 432844

A11R4

30 1 1V

14 ↻ 30° ∅ 81

Picture not available
Image non disponible
Imagen no disponible
Immagine non disponibile
Nicht verfügbares Bild
Brak zdjęcia
Картина недоступна

Picture not available
Image non disponible
Imagen no disponible
Immagine non disponibile
Nicht verfügbares Bild
Brak zdjęcia
Картина недоступна

AUXILIARY DIODE 📏 08 092425
BRUSH HOLDER 📏 09 092743
RECTIFIER OR DIODE BRIDGE ASSEMBLY 📏 07 092086
Valeo 433476

A11VI10

50

1

1V

14



60°

Ø 59,7

INC

**B+(M8)D+(M5)**

FRONT BEARING 21 593563
 PROTECTION COVER 24 *592942
 SEP:SEPARATED REGULATOR -INC:BUILT-IN REGULATOR 02593350
 CONDENSOR 14 592851
 RECTIFIER OR DIODE BRIDGE ASSEMBLY 07 593163
 FRONT BEARING 21 592866
 PULLEY 11 096880
 PULLEY 11 593253
 REPAIRE KIT 29 592854

Valeo**433153/436257****A11VI101**

70

1

1V

14



60°

Ø 59,7

INC



FRONT BEARING 21 593563
 REAR BEARING 22 593564
 PROTECTION COVER 24 593376
 SEP:SEPARATED REGULATOR -INC:BUILT-IN REGULATOR 02593375
 CONDENSOR 14 593377
 RECTIFIER OR DIODE BRIDGE ASSEMBLY 07 592848
 FRONT BEARING 21 592866
 PULLEY 11 593749
 REPAIRE KIT 29 592854
 ROTOR 04 593150
 STATOR 05 593279

Valeo**439274/437191****A11VI102**

70

1

5V

14



60°

Ø 59,4

INC



FRONT BEARING 21 593563
 REAR BEARING 22 593564
 PROTECTION COVER 24 593376
 SEP:SEPARATED REGULATOR -INC:BUILT-IN REGULATOR 02593375
 CONDENSOR 14 593377
 RECTIFIER OR DIODE BRIDGE ASSEMBLY 07 592848
 FRONT BEARING 21 592866
 PULLEY 11 592929
 REPAIRE KIT 29 592854
 ROTOR 04 593150
 STATOR 05 593279

Valeo**439273/437190****A11VI104**

75

2

6V

14



0°

Ø 58,18

INC



FRONT BEARING 21 593563
 REAR BEARING 22 593564
 PROTECTION COVER 24 593315
 SEP:SEPARATED REGULATOR -INC:BUILT-IN REGULATOR 02593290
 RECTIFIER OR DIODE BRIDGE ASSEMBLY 07 593175
 REPAIRE KIT 29 592854
 ROTOR 04 593150
 STATOR 05 593279

Valeo**439287/437203****A11VI105**

75

2

3V

14



19°

Ø 67,2

INC



FRONT BEARING 21 593563
 REAR BEARING 22 593564
 PROTECTION COVER 24 593315
 SEP:SEPARATED REGULATOR -INC:BUILT-IN REGULATOR 02593290
 RECTIFIER OR DIODE BRIDGE ASSEMBLY 07 593304
 PULLEY 11 593746
 REPAIRE KIT 29 592854
 ROTOR 04 593150
 STATOR 05 593279

Valeo**439291/437206****A11VI106**

70

4

6V

14



40°

Ø 57,5

INC

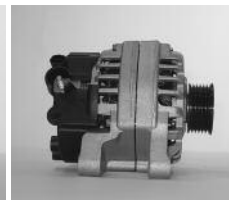

FRONT BEARING 21 593563
 REAR BEARING 22 593564
 PROTECTION COVER 24 593376
 SEP:SEPARATED REGULATOR -INC:BUILT-IN REGULATOR 02593419
 CONDENSOR 14 593421
 RECTIFIER OR DIODE BRIDGE ASSEMBLY 07 593420
 PULLEY 11 593754
 REPAIRE KIT 29 592854
 ROTOR 04 593150
 STATOR 05 593279

Valeo**439275/437355**

A11VI108

70 1 5V

14 ↻ 60° ∇ ∅ 59,4 INC

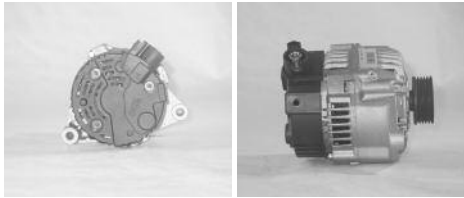

FRONT BEARING	↻ 21	593563
REAR BEARING	↻ 22	593564
PROTECTION COVER	↻ 24	593376
SEP:SEPARATED REGULATOR -INC:BUILT-IN REGULATOR	↻ 02	593419
CONDENSOR	↻ 14	593421
RECTIFIER OR DIODE BRIDGE ASSEMBLY	↻ 07	593420
PULLEY	↻ 11	592929
REPAIRE KIT	↻ 29	592854
ROTOR	↻ 04	593150
STATOR	↻ 05	593279

Valeo

439332/437345

A11VI11

70 1 1V

14 ↻ 60° ∇ ∅ 59,7 INC

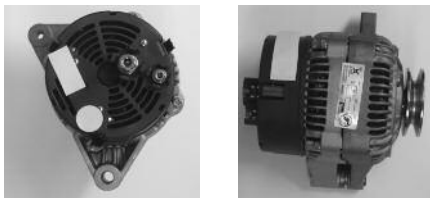

B+(M8)D+(M5)

FRONT BEARING	↻ 21	593563
REAR BEARING	↻ 22	593564
PROTECTION COVER	↻ 24	*592942
SEP:SEPARATED REGULATOR -INC:BUILT-IN REGULATOR	↻ 02	593350
CONDENSOR	↻ 14	592851
RECTIFIER OR DIODE BRIDGE ASSEMBLY	↻ 07	593163
PULLEY	↻ 11	096880
PULLEY	↻ 11	593253
REPAIRE KIT	↻ 29	592854
STATOR	↻ 05	593279

Valeo

433154/436258

A11VI110

75 2 3V

14 ↻ 66-82° ∇ ∅ 62,7 INC



FRONT BEARING	↻ 21	593563
REAR BEARING	↻ 22	593564
PROTECTION COVER	↻ 24	593374
SEP:SEPARATED REGULATOR -INC:BUILT-IN REGULATOR	↻ 02	593411
RECTIFIER OR DIODE BRIDGE ASSEMBLY	↻ 07	593204
PULLEY	↻ 11	593768
REPAIRE KIT	↻ 29	592854
ROTOR	↻ 04	593150
STATOR	↻ 05	593279

Valeo

439320/437323

A11VI111

75 2 4V

14 ↻ 66-82° ∇ ∅ 62,9 INC

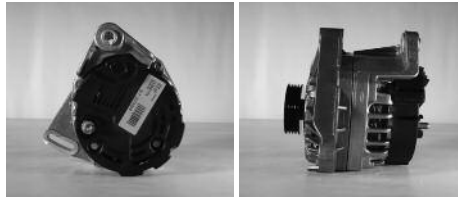

FRONT BEARING	↻ 21	593563
REAR BEARING	↻ 22	593564
PROTECTION COVER	↻ 24	593374
SEP:SEPARATED REGULATOR -INC:BUILT-IN REGULATOR	↻ 02	593411
RECTIFIER OR DIODE BRIDGE ASSEMBLY	↻ 07	593204
PULLEY	↻ 11	593753
REPAIRE KIT	↻ 29	592854
ROTOR	↻ 04	593150
STATOR	↻ 05	593279

Valeo

439308/437313

A11VI15

50 2 5V

14 ↻ 20° ∇ ∅ 59,4 INC



B+(M8)D+(M5)

FRONT BEARING	↻ 21	593563
REAR BEARING	↻ 22	593690
PROTECTION COVER	↻ 24	592946
SEP:SEPARATED REGULATOR -INC:BUILT-IN REGULATOR	↻ 02	593350
CONDENSOR	↻ 14	592853
RECTIFIER OR DIODE BRIDGE ASSEMBLY	↻ 07	592848
REPAIRE KIT	↻ 29	592854

Valeo

433187/436344

A11VI16

50 2 6V

14 ↻ 20° ∇ ∅ 66 INC

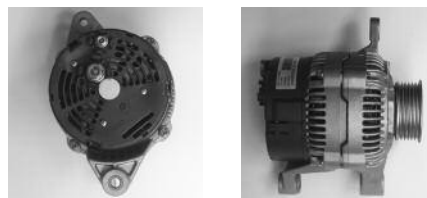

B+(M8)D+(M5)

FRONT BEARING	↻ 21	593563
REAR BEARING	↻ 22	593564
PROTECTION COVER	↻ 24	592946
SEP:SEPARATED REGULATOR -INC:BUILT-IN REGULATOR	↻ 02	593350
CONDENSOR	↻ 14	592853
RECTIFIER OR DIODE BRIDGE ASSEMBLY	↻ 07	592848
FRONT BEARING	↻ 21	592866
REPAIRE KIT	↻ 29	592854

Valeo

433185/436336

A11VI17

70

2

6V

14



20°

Ø 66

INC

**B+(M8)D+(M5)**

FRONT BEARING	593563
REAR BEARING	593564
PROTECTION COVER	592946
SEP:SEPARATED REGULATOR -INC:BUILT-IN REGULATOR	02593350
CONDENSOR	14 592853
RECTIFIER OR DIODE BRIDGE ASSEMBLY	07 592848
FRONT BEARING	21 592866
REPAIRE KIT	29 592854
STATOR	05 593279

Valeo**436338****A11VI18**

70

2

4V

14



20°

Ø 59,4

INC

**B+(M8)D+(M5)**

FRONT BEARING	21 593563
REAR BEARING	22 593564
PROTECTION COVER	24 592946
SEP:SEPARATED REGULATOR -INC:BUILT-IN REGULATOR	02593350
CONDENSOR	14 592853
RECTIFIER OR DIODE BRIDGE ASSEMBLY	07 592848
PULLEY	11 593741
REPAIRE KIT	29 592854
STATOR	05 593279

Valeo**433155/436259****A11VI21**

70

2

6V

14



76-88°

Ø 55

INC

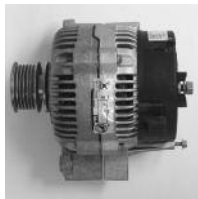

FRONT BEARING	21 593563
REAR BEARING	22 593564
PROTECTION COVER	24 593241
SEP:SEPARATED REGULATOR -INC:BUILT-IN REGULATOR	02593131
CONDENSOR	14 592933
RECTIFIER OR DIODE BRIDGE ASSEMBLY	07 592915
REPAIRE KIT	29 592854
ROTOR	04 593150
STATOR	05 593279

Valeo**439000/436363****A11VI22**

60

2

6V

14



76-88°

Ø 49,3

INC

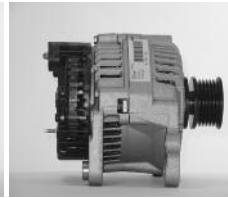
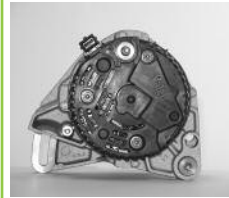

FRONT BEARING	21 593563
REAR BEARING	22 593564
PROTECTION COVER	24 593241
SEP:SEPARATED REGULATOR -INC:BUILT-IN REGULATOR	02593131
CONDENSOR	14 592933
RECTIFIER OR DIODE BRIDGE ASSEMBLY	07 592915
PULLEY	11 592920
REPAIRE KIT	29 592854
STATOR	05 593279

Valeo**436364****A11VI23**

70

2

6V

14



20°

Ø 59,4

INC

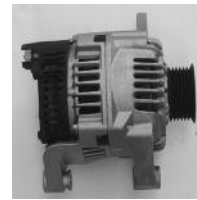
**B+(M8)D+(M5)**

FRONT BEARING	21 593563
REAR BEARING	22 593564
PROTECTION COVER	24 *592942
SEP:SEPARATED REGULATOR -INC:BUILT-IN REGULATOR	02593350
CONDENSOR	14 592851
RECTIFIER OR DIODE BRIDGE ASSEMBLY	07 593163
FRONT BEARING	21 592866
PULLEY	11 593743
REPAIRE KIT	29 592854
STATOR	05 593279

A11VI23

70

2

6V

14



20°

Ø 59,4

INC

**B+(M8)D+(M5)**

FRONT BEARING	21 593563
REAR BEARING	22 593564
PROTECTION COVER	24 *592942
SEP:SEPARATED REGULATOR -INC:BUILT-IN REGULATOR	02593350
CONDENSOR	14 592851
RECTIFIER OR DIODE BRIDGE ASSEMBLY	07 593163
FRONT BEARING	21 592866
PULLEY	11 593743
REPAIRE KIT	29 592854
STATOR	05 593279

Valeo**433188/436345**

A11VI24

50 2 6V

14 ↻ 20° ∅ 66 INC

**B+(M8)D+(M5)**

- FRONT BEARING 21 593563
- REAR BEARING 22 593690
- PROTECTION COVER 24 *592942
- SEP:SEPARATED REGULATOR -INC:BUILT-IN REGULATOR 02593350
- CONDENSOR 14 592851
- RECTIFIER OR DIODE BRIDGE ASSEMBLY 07 593163
- REPAIRE KIT 29 592854

Valeo**433161/436336****A11VI25**

70 2 6V

14 ↻ 20° ∅ 66 INC

**B+(M8)D+(M5)**

- FRONT BEARING 21 593563
- REAR BEARING 22 593690
- PROTECTION COVER 24 *592942
- SEP:SEPARATED REGULATOR -INC:BUILT-IN REGULATOR 02593350
- CONDENSOR 14 592851
- RECTIFIER OR DIODE BRIDGE ASSEMBLY 07 593163
- REPAIRE KIT 29 592854
- STATOR 05 593279

Valeo**433162/436338****A11VI26**

75 2 6V

14 ↻ 35° ∅ 58,18 INC



- FRONT BEARING 21 593563
- REAR BEARING 22 593564
- PROTECTION COVER 24 592944
- CONDENSOR 14 592852
- RECTIFIER OR DIODE BRIDGE ASSEMBLY 07 592847
- REPAIRE KIT 29 592854
- ROTOR 04 593150
- STATOR 05 593279

Valeo**439015/436465****A11VI28**

75 2 3V

14 ↻ 19° ∅ 61,1 INC



- FRONT BEARING 21 593563
- REAR BEARING 22 593564
- PROTECTION COVER 24 592944
- CONDENSOR 14 592852
- RECTIFIER OR DIODE BRIDGE ASSEMBLY 07 592847
- REPAIRE KIT 29 592854
- ROTOR 04 593150
- STATOR 05 593279

Valeo**433167/436277****A11VI29**

75 2 4V

14 ↻ 25° ∅ 58,18 INC



- FRONT BEARING 21 593563
- REAR BEARING 22 593564
- PROTECTION COVER 24 592945
- CONDENSOR 14 592852
- RECTIFIER OR DIODE BRIDGE ASSEMBLY 07 592847
- PULLEY 11 593741
- REPAIRE KIT 29 592854
- ROTOR 04 593150
- STATOR 05 593279

Valeo**439014/436447****A11VI30**

75 2 4V

14 ↻ 25° ∅ 64,8 INC



- FRONT BEARING 21 593563
- REAR BEARING 22 593564
- PROTECTION COVER 24 592944
- CONDENSOR 14 592852
- RECTIFIER OR DIODE BRIDGE ASSEMBLY 07 592847
- PULLEY 11 593740
- REPAIRE KIT 29 592854
- ROTOR 04 593150
- STATOR 05 593279

Valeo**439017/436468**

A11VI31

75

2

4V

14



19°

Ø 64,8

INC

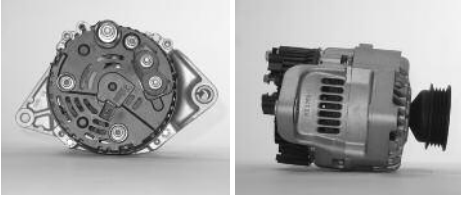

FRONT BEARING	21	593563
REAR BEARING	22	593564
PROTECTION COVER	24	592944
CONDENSOR	14	592852
RECTIFIER OR DIODE BRIDGE ASSEMBLY	07	592847
PULLEY	11	592924
REPAIRE KIT	29	592854
ROTOR	04	593150
STATOR	05	593279

A11VI31

75

2

4V

14



19°

Ø 64,8

INC



FRONT BEARING	21	593563
REAR BEARING	22	593564
PROTECTION COVER	24	592944
CONDENSOR	14	592852
RECTIFIER OR DIODE BRIDGE ASSEMBLY	07	592847
PULLEY	11	592924
REPAIRE KIT	29	592854
ROTOR	04	593150
STATOR	05	593279

Valeo**433166/436367****A11VI32**

70

2

5V

14



60°

Ø 59,4

Picture not available
Image non disponible
Imagen no disponible
Immagine non disponibile
Nicht verfügbares Bild
Brak zdjęcia
Картина недоступна

Picture not available
Image non disponible
Imagen no disponible
Immagine non disponibile
Nicht verfügbares Bild
Brak zdjęcia
Картина недоступна

FRONT BEARING	21	593563
REAR BEARING	22	593564
PROTECTION COVER	24	*592942
SEP:SEPARATED REGULATOR -INC:BUILT-IN REGULATOR	02	593350
CONDENSOR	14	592851
RECTIFIER OR DIODE BRIDGE ASSEMBLY	07	593163
FRONT BEARING	21	592866
PULLEY	11	593742
REPAIRE KIT	29	592854
ROTOR	04	593150
STATOR	05	593279

A11VI33

50

2

6V

14



20°

Ø 59,4

Picture not available
Image non disponible
Imagen no disponible
Immagine non disponibile
Nicht verfügbares Bild
Brak zdjęcia
Картина недоступна

Picture not available
Image non disponible
Imagen no disponible
Immagine non disponibile
Nicht verfügbares Bild
Brak zdjęcia
Картина недоступна

FRONT BEARING	21	593563
REAR BEARING	22	593564
PROTECTION COVER	24	*592942
SEP:SEPARATED REGULATOR -INC:BUILT-IN REGULATOR	02	593350
CONDENSOR	14	592851
RECTIFIER OR DIODE BRIDGE ASSEMBLY	07	593163
FRONT BEARING	21	592866
PULLEY	11	593743
REPAIRE KIT	29	592854

A11VI35

70

2

7V

14



90°

Ø 56,5

Picture not available
Image non disponible
Imagen no disponible
Immagine non disponibile
Nicht verfügbares Bild
Brak zdjęcia
Картина недоступна

Picture not available
Image non disponible
Imagen no disponible
Immagine non disponibile
Nicht verfügbares Bild
Brak zdjęcia
Картина недоступна

FRONT BEARING	21	593563
REAR BEARING	22	593564
PROTECTION COVER	24	593241
SEP:SEPARATED REGULATOR -INC:BUILT-IN REGULATOR	02	593131
CONDENSOR	14	592933
RECTIFIER OR DIODE BRIDGE ASSEMBLY	07	592915
PULLEY	11	593693
REPAIRE KIT	29	592854
ROTOR	04	593150
STATOR	05	593279

Valeo**439063/436634****A11VI36**

70

2

6V

14



90°

Ø 53,2

INC

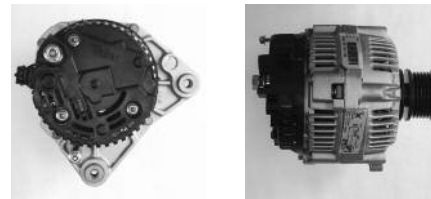

FRONT BEARING	21	593563
REAR BEARING	22	593564
PROTECTION COVER	24	593241
SEP:SEPARATED REGULATOR -INC:BUILT-IN REGULATOR	02	593131
CONDENSOR	14	592933
RECTIFIER OR DIODE BRIDGE ASSEMBLY	07	592915
PULLEY	11	592920
REPAIRE KIT	29	592854
ROTOR	04	593150
STATOR	05	593279

Valeo**439001/436442**

A11VI37

50 1 1V

14 ↻ 60° ∇ Ø 59,7 INC

**B+(M8)D+(M5)**

FRONT BEARING	↻ 21	593563
REAR BEARING	↻ 22	593564
PROTECTION COVER	↻ 24	*592942
SEP:SEPARATED REGULATOR -INC:BUILT-IN REGULATOR	↻ 02	5933131
CONDENSOR	↻ 14	592851
RECTIFIER OR DIODE BRIDGE ASSEMBLY	↻ 07	593163
FRONT BEARING	↻ 21	592866
PULLEY	↻ 11	096880
REPAIRE KIT	↻ 29	592854

Valeo**433153/436257****A11VI40**

70 2 6V

14 ↻ 20° ∇ Ø 66 INC

**B+(M8)D+(M5)**

FRONT BEARING	↻ 21	593563
REAR BEARING	↻ 22	593564
PROTECTION COVER	↻ 24	*592942
SEP:SEPARATED REGULATOR -INC:BUILT-IN REGULATOR	↻ 02	5933350
CONDENSOR	↻ 14	592851
RECTIFIER OR DIODE BRIDGE ASSEMBLY	↻ 07	593163
FRONT BEARING	↻ 21	592866
REPAIRE KIT	↻ 29	592854
ROTOR	↻ 04	593150
STATOR	↻ 05	593279

Valeo**433162/436338****A11VI42**

50 1 1V

14 ↻ 60° ∇ Ø 59,7 INC

**B+(M8)D+(M5)**

FRONT BEARING	↻ 21	593563
REAR BEARING	↻ 22	593564
PROTECTION COVER	↻ 24	*592942
SEP:SEPARATED REGULATOR -INC:BUILT-IN REGULATOR	↻ 02	5933350
CONDENSOR	↻ 14	592851
RECTIFIER OR DIODE BRIDGE ASSEMBLY	↻ 07	593163
FRONT BEARING	↻ 21	592866
REPAIRE KIT	↻ 29	592854

Valeo**433153/436257****A11VI43**

70 1 1V

14 ↻ 60° ∇ Ø 59,7 INC

**B+(M8)D+(M5)**

FRONT BEARING	↻ 21	593563
REAR BEARING	↻ 22	593564
PROTECTION COVER	↻ 24	*592942
SEP:SEPARATED REGULATOR -INC:BUILT-IN REGULATOR	↻ 02	5933350
CONDENSOR	↻ 14	592851
RECTIFIER OR DIODE BRIDGE ASSEMBLY	↻ 07	593163
FRONT BEARING	↻ 21	592866
PULLEY	↻ 11	096880
REPAIRE KIT	↻ 29	592854
ROTOR	↻ 04	593150
STATOR	↻ 05	593279

Valeo**433154/436258****A11VI44**

70 1 5V

14 ↻ 60° ∇ Ø 59,4

Picture not available
Image non disponible
Imagen no disponible
Immagine non disponibile
Nicht verfügbares Bild
Brak zdjęcia
Картина недоступна

Picture not available
Image non disponible
Imagen no disponible
Immagine non disponibile
Nicht verfügbares Bild
Brak zdjęcia
Картина недоступна

FRONT BEARING	↻ 21	593563
REAR BEARING	↻ 22	593564
PROTECTION COVER	↻ 24	*592942
SEP:SEPARATED REGULATOR -INC:BUILT-IN REGULATOR	↻ 02	5933350
CONDENSOR	↻ 14	592851
RECTIFIER OR DIODE BRIDGE ASSEMBLY	↻ 07	593163
FRONT BEARING	↻ 21	592866
PULLEY	↻ 11	593742
REPAIRE KIT	↻ 29	592854
ROTOR	↻ 04	593150
STATOR	↻ 05	593279

A11VI45

70 2 5V

14 ↻ 55° ∇ Ø 59,4 INC

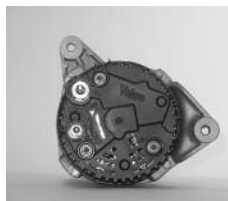
**B+(M8)D+(M5)**

FRONT BEARING	↻ 21	593563
REAR BEARING	↻ 22	593564
PROTECTION COVER	↻ 24	*592942
SEP:SEPARATED REGULATOR -INC:BUILT-IN REGULATOR	↻ 02	5933350
CONDENSOR	↻ 14	592851
RECTIFIER OR DIODE BRIDGE ASSEMBLY	↻ 07	593163
FRONT BEARING	↻ 21	592866
PULLEY	↻ 11	593742
REPAIRE KIT	↻ 29	592854
ROTOR	↻ 04	593150
STATOR	↻ 05	593279

Valeo**439039/436489**

A11VI46

65

1

4V

14



27°

Ø 60

INC

**B+(M8)D+(M5)**

FRONT BEARING	593563
REAR BEARING	593564
PROTECTION COVER	593239
SEP:SEPARATED REGULATOR -INC:BUILT-IN REGULATOR	593350
RECTIFIER OR DIODE BRIDGE ASSEMBLY	593166
PULLEY	593704
REPAIRE KIT	592854
ROTOR	593150
STATOR	593279

Valeo**439030/436481****A11VI47**

50

2

6V

14



20°

Ø 66

INC

**B+(M8)D+(M5)**

FRONT BEARING	593563
REAR BEARING	593564
PROTECTION COVER	592946
CONDENSOR	592853
RECTIFIER OR DIODE BRIDGE ASSEMBLY	592848
FRONT BEARING	592866
REPAIRE KIT	592854

Valeo**433185/436336****A11VI48**

70

2

4V

14



20°

Ø 59,4

INC

**B+(M8)D+(M5)**

FRONT BEARING	593563
REAR BEARING	593564
PROTECTION COVER	592946
SEP:SEPARATED REGULATOR -INC:BUILT-IN REGULATOR	593350
CONDENSOR	592853
RECTIFIER OR DIODE BRIDGE ASSEMBLY	592848
FRONT BEARING	592866
PULLEY	593741
REPAIRE KIT	592854
ROTOR	593150
STATOR	593279

Valeo**436259****A11VI49**

70

2

6V

14



20°

Ø 59,4

INC

**B+(M8)D+(M5)**

FRONT BEARING	593563
REAR BEARING	593564
PROTECTION COVER	*592942
CONDENSOR	592851
RECTIFIER OR DIODE BRIDGE ASSEMBLY	593163
FRONT BEARING	592866
PULLEY	593743
REPAIRE KIT	592854
ROTOR	593150
STATOR	593279

Valeo**433188/436345****A11VI51**

70

2

6V

14



20°

Ø 66

INC

**B+(M8)D+(M5)**

FRONT BEARING	593563
REAR BEARING	593564
PROTECTION COVER	*592942
CONDENSOR	592851
RECTIFIER OR DIODE BRIDGE ASSEMBLY	593163
FRONT BEARING	592866
REPAIRE KIT	592854
ROTOR	593150
STATOR	593279

Valeo**433162/436338****A11VI52**

70

2

5V

14



20°

Ø 59,4

Picture not available
Image non disponible
Imagen no disponible
Immagine non disponibile
Nicht verfügbares Bild
Brak zdjęcia
Картина недоступна

Picture not available
Image non disponible
Imagen no disponible
Immagine non disponibile
Nicht verfügbares Bild
Brak zdjęcia
Картина недоступна

FRONT BEARING	593563
REAR BEARING	593564
PROTECTION COVER	*592942
SEP:SEPARATED REGULATOR -INC:BUILT-IN REGULATOR	593350
CONDENSOR	592851
RECTIFIER OR DIODE BRIDGE ASSEMBLY	593163
FRONT BEARING	592866
PULLEY	593742
REPAIRE KIT	592854
ROTOR	593150
STATOR	593279

A11VI53

50

2

6V

14



20°

Ø 59,4

Picture not available
Image non disponible
Imagen no disponible
Immagine non disponibile
Nicht verfügbares Bild
Brak zdjęcia
Картина недоступна

Picture not available
Image non disponible
Imagen no disponible
Immagine non disponibile
Nicht verfügbares Bild
Brak zdjęcia
Картина недоступна

FRONT BEARING 21

593563

REAR BEARING 22

593564

PROTECTION COVER 24

*592942

CONDENSOR 14

592851

RECTIFIER OR DIODE BRIDGE ASSEMBLY 07

593163

FRONT BEARING 21

592866

PULLEY 11

593743

REPAIRE KIT 29

592854

A11VI54

75

2

4V

14



25°

Ø 58,18

INC

**FRONT BEARING** 21

593563

REAR BEARING 22

593564

PROTECTION COVER 24

593242

SEP:SEPARATED REGULATOR -INC:BUILT-IN REGULATOR 02 593141**RECTIFIER OR DIODE BRIDGE ASSEMBLY** 07

593175

PULLEY 11

593741

REPAIRE KIT 29

592854

ROTOR 04

593150

STATOR 05

593279

Valeo**439014/436447****A11VI55**

70

1

1V

14



60°

Ø 59,7

INC

**B+(M8)D+(M5)****FRONT BEARING** 21

593563

REAR BEARING 22

593564

PROTECTION COVER 24

*592942

SEP:SEPARATED REGULATOR -INC:BUILT-IN REGULATOR 02 593350**CONDENSOR** 14

592851

RECTIFIER OR DIODE BRIDGE ASSEMBLY 07

593163

FRONT BEARING 21

592866

PULLEY 11

593749

REPAIRE KIT 29

592854

ROTOR 04

593150

STATOR 05

593279

Valeo**433154/436258****A11VI56**

70

1

5V

14



60°

Ø 59,4

INC

**B+(M8)D+(M5)****FRONT BEARING** 21

593563

REAR BEARING 22

593564

PROTECTION COVER 24

*592942

CONDENSOR 14

592851

RECTIFIER OR DIODE BRIDGE ASSEMBLY 07

593163

FRONT BEARING 21

592866

PULLEY 11

593742

REPAIRE KIT 29

592854

ROTOR 04

593150

STATOR 05

593279

Valeo**439040/436490****A11VI57**

70

2

6V

14



20°

Ø 59,4

INC

**B+(M8)D+(M5)****FRONT BEARING** 21

593563

REAR BEARING 22

593564

PROTECTION COVER 24

*592942

SEP:SEPARATED REGULATOR -INC:BUILT-IN REGULATOR 02 593350**CONDENSOR** 14

592851

RECTIFIER OR DIODE BRIDGE ASSEMBLY 07

593163

FRONT BEARING 21

592866

PULLEY 11

593743

REPAIRE KIT 29

592854

ROTOR 04

593150

STATOR 05

593279

A11VI57

70

2

6V

14



20°

Ø 59,4

INC

**B+(M8)D+(M5)****FRONT BEARING** 21

593563

REAR BEARING 22

593564

PROTECTION COVER 24

*592942

SEP:SEPARATED REGULATOR -INC:BUILT-IN REGULATOR 02 593350**CONDENSOR** 14

592851

RECTIFIER OR DIODE BRIDGE ASSEMBLY 07

593163

FRONT BEARING 21

592866

PULLEY 11

593743

REPAIRE KIT 29

592854

ROTOR 04

593150

STATOR 05

593279

A11VI57

70

2

6V

14



20°

Ø 59,4

INC

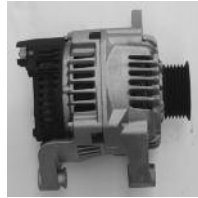
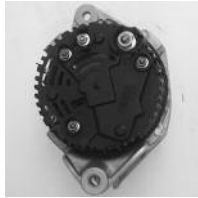
**B+(M8)D+(M5)**

FRONT BEARING	21	593563
REAR BEARING	22	593564
PROTECTION COVER	24	*592942
SEP:SEPARATED REGULATOR -INC:BUILT-IN REGULATOR	02	593350
CONDENSOR	14	592851
RECTIFIER OR DIODE BRIDGE ASSEMBLY	07	593163
FRONT BEARING	21	592866
PULLEY	11	593743
REPAIRE KIT	29	592854
ROTOR	04	593150
STATOR	05	593279

Valeo**433188/436345****A11VI58**

50

2

6V

14



20°

Ø 59,4

Picture not available
Image non disponible
Imagen no disponible
Immagine non disponibile
Nicht verfügbares Bild
Brak zdjęcia
Картина недоступна

Picture not available
Image non disponible
Imagen no disponible
Immagine non disponibile
Nicht verfügbares Bild
Brak zdjęcia
Картина недоступна

FRONT BEARING	21	593563
REAR BEARING	22	593564
PROTECTION COVER	24	*592942
SEP:SEPARATED REGULATOR -INC:BUILT-IN REGULATOR	02	593350
CONDENSOR	14	592851
RECTIFIER OR DIODE BRIDGE ASSEMBLY	07	593163
FRONT BEARING	21	592866
PULLEY	11	593743
REPAIRE KIT	29	592854

A11VI59

75

2

6V

14



0°

Ø 58,18

INC



FRONT BEARING	21	593563
REAR BEARING	22	593564
PROTECTION COVER	24	592944
CONDENSOR	14	592852
RECTIFIER OR DIODE BRIDGE ASSEMBLY	07	592847
REPAIRE KIT	29	592854
ROTOR	04	593150
STATOR	05	593279

Valeo**439077/436648****A11VI61**

75

2

3V

14



19°

Ø 67,2

INC

**B+(M8)
L(M5)**

FRONT BEARING	21	593563
REAR BEARING	22	593564
PROTECTION COVER	24	592944
CONDENSOR	14	592852
RECTIFIER OR DIODE BRIDGE ASSEMBLY	07	592847
PULLEY	11	593746
REPAIRE KIT	29	592854
ROTOR	04	593150
STATOR	05	593279

Valeo**439057/436614****A11VI62**

70

2

6V

14



90°

Ø 53,2

INC



FRONT BEARING	21	593563
REAR BEARING	22	593564
PROTECTION COVER	24	593241
SEP:SEPARATED REGULATOR -INC:BUILT-IN REGULATOR	02	593131
CONDENSOR	14	592933
RECTIFIER OR DIODE BRIDGE ASSEMBLY	07	592915
PULLEY	11	593615
REPAIRE KIT	29	592854
ROTOR	04	593150
STATOR	05	593279

Valeo**439031/436482****A11VI64**

70

2

6V

14



90°

Ø 50,5

INC

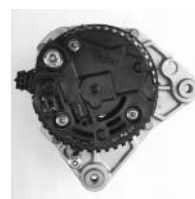

FRONT BEARING	21	593563
REAR BEARING	22	593564
PROTECTION COVER	24	593241
SEP:SEPARATED REGULATOR -INC:BUILT-IN REGULATOR	02	593131
CONDENSOR	14	592933
PULLEY	11	592920
REPAIRE KIT	29	592854
ROTOR	04	593150
STATOR	05	593279

Valeo**439001/436442**

A11VI66

70

2

6V

14



76-88°

Ø 53,2

INC



FRONT BEARING	↗ 21	593563
REAR BEARING	↗ 22	593564
PROTECTION COVER	↗ 24	593241
SEP:SEPARATED REGULATOR -INC:BUILT-IN REGULATOR	↗ 02	593131
CONDENSOR	↗ 14	592933
RECTIFIER OR DIODE BRIDGE ASSEMBLY	↗ 07	592915
PULLEY	↗ 11	592920
REPAIRE KIT	↗ 29	592854
ROTOR	↗ 04	593150
STATOR	↗ 05	593279

A11VI66

70

2

6V

14



76-88°

Ø 53,2

INC



FRONT BEARING	↗ 21	593563
REAR BEARING	↗ 22	593564
PROTECTION COVER	↗ 24	593241
SEP:SEPARATED REGULATOR -INC:BUILT-IN REGULATOR	↗ 02	593131
CONDENSOR	↗ 14	592933
RECTIFIER OR DIODE BRIDGE ASSEMBLY	↗ 07	592915
PULLEY	↗ 11	592920
REPAIRE KIT	↗ 29	592854
ROTOR	↗ 04	593150
STATOR	↗ 05	593279

Valeo**439000/436364****A11VI67**

75

2

4V

14



65°

Ø 62,9

INC



FRONT BEARING	↗ 21	593563
REAR BEARING	↗ 22	593564
PROTECTION COVER	↗ 24	593291
SEP:SEPARATED REGULATOR -INC:BUILT-IN REGULATOR	↗ 02	593303
RECTIFIER OR DIODE BRIDGE ASSEMBLY	↗ 07	593304
PULLEY	↗ 11	593753
REPAIRE KIT	↗ 29	592854
ROTOR	↗ 04	593150
STATOR	↗ 05	593279

Valeo**439171/436701****A11VI72**

70

2

5V

14



20°

Ø 63,09

Picture not available
Image non disponible
Imagen no disponible
Immagine non disponibile
Nicht verfügbares Bild
Brak zdjęcia
Картина недоступна

Picture not available
Image non disponible
Imagen no disponible
Immagine non disponibile
Nicht verfügbares Bild
Brak zdjęcia
Картина недоступна

FRONT BEARING	↗ 21	593563
REAR BEARING	↗ 22	593564
PROTECTION COVER	↗ 24	*592942
SEP:SEPARATED REGULATOR -INC:BUILT-IN REGULATOR	↗ 02	593350
CONDENSOR	↗ 14	592851
RECTIFIER OR DIODE BRIDGE ASSEMBLY	↗ 07	593557
PULLEY	↗ 11	593725
REPAIRE KIT	↗ 29	592854
ROTOR	↗ 04	593150
STATOR	↗ 05	593279

Valeo**541854****A11VI76**

75

2

6V

14



0°

Ø 58,18

INC



FRONT BEARING	↗ 21	593563
REAR BEARING	↗ 22	593564
PROTECTION COVER	↗ 24	593242
SEP:SEPARATED REGULATOR -INC:BUILT-IN REGULATOR	↗ 02	593141
RECTIFIER OR DIODE BRIDGE ASSEMBLY	↗ 07	593175
REPAIRE KIT	↗ 29	592854
ROTOR	↗ 04	593150
STATOR	↗ 05	593279

Valeo**439168/436697****A11VI77**

75

2

6V

14



0°

Ø 62,9

INC



FRONT BEARING	↗ 21	593563
REAR BEARING	↗ 22	593564
PROTECTION COVER	↗ 24	593242
SEP:SEPARATED REGULATOR -INC:BUILT-IN REGULATOR	↗ 02	593141
RECTIFIER OR DIODE BRIDGE ASSEMBLY	↗ 07	593175
PULLEY	↗ 11	593707
REPAIRE KIT	↗ 29	592854
ROTOR	↗ 04	593150
STATOR	↗ 05	593279

Valeo**439169/436698**

A11VI79

75

2

6V

14



0°

Ø 58,18

INC



FRONT BEARING 21 593563
 REAR BEARING 22 593564
 PROTECTION COVER 24 593291
 SEP:SEPARATED REGULATOR -INC:BUILT-IN REGULATOR 02 593290
 RECTIFIER OR DIODE BRIDGE ASSEMBLY 07 593175
 REPAIRE KIT 29 592854
 ROTOR 04 593150
 STATOR 05 593279

Valeo

439077/436713

A11VI81

75

2

6V

14



0°

Ø 58,2

INC



FRONT BEARING 21 593563
 REAR BEARING 22 593564
 PROTECTION COVER 24 593291
 SEP:SEPARATED REGULATOR -INC:BUILT-IN REGULATOR 02 593290
 RECTIFIER OR DIODE BRIDGE ASSEMBLY 07 593306
 PULLEY 11 593701
 REPAIRE KIT 29 592854
 ROTOR 04 593150
 STATOR 05 593279

Valeo

439182/436706

A11VI82

70

2

6V

14



90°

Ø 57,2

Picture not available
 Image non disponible
 Imagen no disponible
 Immagine non disponibile
 Nicht verfügbares Bild
 Brak zdjęcia
 Картина недоступна

Picture not available
 Image non disponible
 Imagen no disponible
 Immagine non disponibile
 Nicht verfügbares Bild
 Brak zdjęcia
 Картина недоступна

PROTECTION COVER 24 593367
 SEP:SEPARATED REGULATOR -INC:BUILT-IN REGULATOR 02 593362
 RECTIFIER OR DIODE BRIDGE ASSEMBLY 07 593364
 REPAIRE KIT 29 592854
 ROTOR 04 593150
 STATOR 05 593279

A11VI85

75

2

3V

14



19°

Ø 67,2

INC

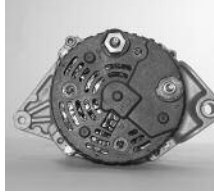

FRONT BEARING 21 593563
 REAR BEARING 22 593564
 PROTECTION COVER 24 593291
 SEP:SEPARATED REGULATOR -INC:BUILT-IN REGULATOR 02 593310
 RECTIFIER OR DIODE BRIDGE ASSEMBLY 07 593304
 PULLEY 11 593746
 REPAIRE KIT 29 592854
 ROTOR 04 593150
 STATOR 05 593279

Valeo

439057/436740

A11VI87

75

2

3V

14



30°

Ø 67,2

INC



FRONT BEARING 21 593563
 REAR BEARING 22 593564
 PROTECTION COVER 24 593317
 SEP:SEPARATED REGULATOR -INC:BUILT-IN REGULATOR 02 593411
 RECTIFIER OR DIODE BRIDGE ASSEMBLY 07 593204
 PULLEY 11 593751
 REPAIRE KIT 29 592854
 ROTOR 04 593150
 STATOR 05 593279

Valeo

439202/436712

A11VI88

75

2

6V

14



0°

Ø 58,18

INC



FRONT BEARING 21 593563
 REAR BEARING 22 593564
 PROTECTION COVER 24 593374
 SEP:SEPARATED REGULATOR -INC:BUILT-IN REGULATOR 02 593411
 RECTIFIER OR DIODE BRIDGE ASSEMBLY 07 593204
 REPAIRE KIT 29 592854
 ROTOR 04 593356
 STATOR 05 593279

Valeo

439230/437112

A11VI89

70 1 5V

14 ↻ 60° ∇ Ø 59,4 INC

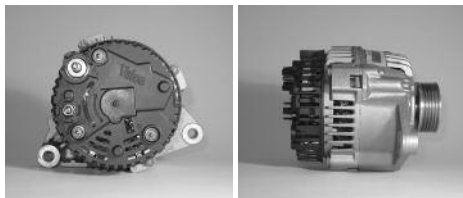
**B+(M8)D+(M5)**

FRONT BEARING	↻ 21	593563
REAR BEARING	↻ 22	593564
PROTECTION COVER	↻ 24	*592942
SEP:SEPARATED REGULATOR -INC:BUILT-IN REGULATOR	↻ 02	593350
CONDENSOR	↻ 14	592851
RECTIFIER OR DIODE BRIDGE ASSEMBLY	↻ 07	593163
FRONT BEARING	↻ 21	592866
PULLEY	↻ 11	592929
REPAIRE KIT	↻ 29	592854
ROTOR	↻ 04	593150
STATOR	↻ 05	593279

Valeo**439214/436741****A11VI91**

70 2 6V

14 ↻ 40° ∇ Ø 57,5 INC

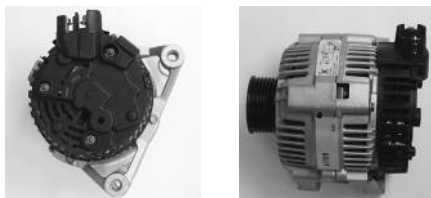
**B+(M8)
L(M5)**

FRONT BEARING	↻ 21	593563
REAR BEARING	↻ 22	593564
PROTECTION COVER	↻ 24	592946
SEP:SEPARATED REGULATOR -INC:BUILT-IN REGULATOR	↻ 02	593350
CONDENSOR	↻ 14	592853
RECTIFIER OR DIODE BRIDGE ASSEMBLY	↻ 07	592848
FRONT BEARING	↻ 21	592866
PULLEY	↻ 11	593754
REPAIRE KIT	↻ 29	592854
ROTOR	↻ 04	593150
STATOR	↻ 05	593279

Valeo**439246/437137****A11VI92**

75 2 6V

14 ↻ 0° ∇ Ø 58,18 INC

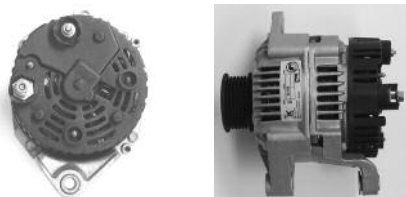

FRONT BEARING	↻ 21	593563
REAR BEARING	↻ 22	593564
PROTECTION COVER	↻ 24	593315
SEP:SEPARATED REGULATOR -INC:BUILT-IN REGULATOR	↻ 02	593310
RECTIFIER OR DIODE BRIDGE ASSEMBLY	↻ 07	593175
REPAIRE KIT	↻ 29	592854
ROTOR	↻ 04	593150
STATOR	↻ 05	593279

Valeo**439204/436713****A11VI93**

75 2 3V

14 ↻ 19° ∇ Ø 67,2 INC



FRONT BEARING	↻ 21	593563
REAR BEARING	↻ 22	593564
PROTECTION COVER	↻ 24	593315
SEP:SEPARATED REGULATOR -INC:BUILT-IN REGULATOR	↻ 02	593310
RECTIFIER OR DIODE BRIDGE ASSEMBLY	↻ 07	593304
PULLEY	↻ 11	593746
REPAIRE KIT	↻ 29	592854
ROTOR	↻ 04	593150
STATOR	↻ 05	593279

Valeo**439213/436740****A11VI94**

75 6V

14 ↻ 0° ∇ Ø 58,18



FRONT BEARING	↻ 21	593563
REAR BEARING	↻ 22	593564
SEP:SEPARATED REGULATOR -INC:BUILT-IN REGULATOR	↻ 02	593411
RECTIFIER OR DIODE BRIDGE ASSEMBLY	↻ 07	593204
PULLEY	↻ 11	593518
REPAIRE KIT	↻ 29	592854
ROTOR	↻ 04	593150
STATOR	↻ 05	593279

Valeo**439226/436750****A11VI95**

70 2 6V

14 ↻ 90° ∇ Ø 50,5 INC

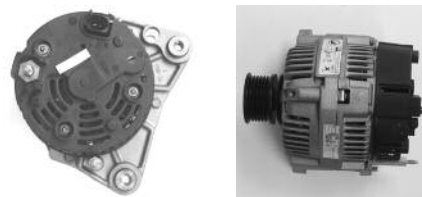

FRONT BEARING	↻ 21	593563
REAR BEARING	↻ 22	593564
PROTECTION COVER	↻ 24	593367
SEP:SEPARATED REGULATOR -INC:BUILT-IN REGULATOR	↻ 02	593362
RECTIFIER OR DIODE BRIDGE ASSEMBLY	↻ 07	593364
PULLEY	↻ 11	592920
REPAIRE KIT	↻ 29	592854
ROTOR	↻ 04	593150
STATOR	↻ 05	593279

Valeo**439256/437170**

A11VI96	75	2	4V
14	↻	66-82°	Ø 62,9 INC

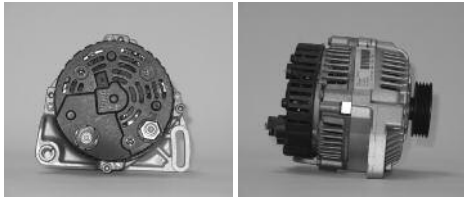

- FRONT BEARING 21 593563
 - REAR BEARING 22 593564
 - PROTECTION COVER 24 593315
 - SEP:SEPARATED REGULATOR -INC:BUILT-IN REGULATOR 02 593290
 - RECTIFIER OR DIODE BRIDGE ASSEMBLY 07 593304
 - PULLEY 11 593753
 - REPAIRE KIT 29 592854
 - ROTOR 04 593150
 - STATOR 05 593279
- Valeo** **439205/436714**

A11VI97	75	2	6V
14	↻	0°	Ø 58,18 INC



- FRONT BEARING 21 593563
 - REAR BEARING 22 593564
 - PROTECTION COVER 24 593315
 - SEP:SEPARATED REGULATOR -INC:BUILT-IN REGULATOR 02 593290
 - RECTIFIER OR DIODE BRIDGE ASSEMBLY 07 593175
 - REPAIRE KIT 29 592854
 - ROTOR 04 593356
 - STATOR 05 593279
- Valeo** **439249/437140**

A11VI98	75	2	4V
14	↻	65-82°	Ø 62,9 INC

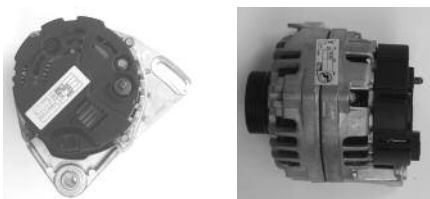

- FRONT BEARING 21 593563
- REAR BEARING 22 593564
- SEP:SEPARATED REGULATOR -INC:BUILT-IN REGULATOR 02 593411
- RECTIFIER OR DIODE BRIDGE ASSEMBLY 07 593204
- PULLEY 11 593753
- REPAIRE KIT 29 592854
- ROTOR 04 593150
- STATOR 05 593279

A11VI98	75	2	4V
14	↻	65-82°	Ø 62,9 INC

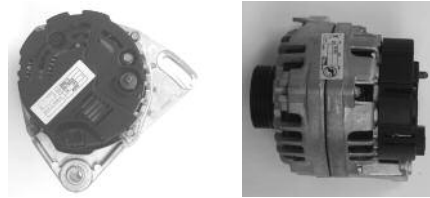

- FRONT BEARING 21 593563
 - REAR BEARING 22 593564
 - SEP:SEPARATED REGULATOR -INC:BUILT-IN REGULATOR 02 593411
 - RECTIFIER OR DIODE BRIDGE ASSEMBLY 07 593204
 - PULLEY 11 593753
 - REPAIRE KIT 29 592854
 - ROTOR 04 593150
 - STATOR 05 593279
- Valeo** **439238/437119**

A12M10	35	1	1V
14	↻	20°	Ø 70 INC

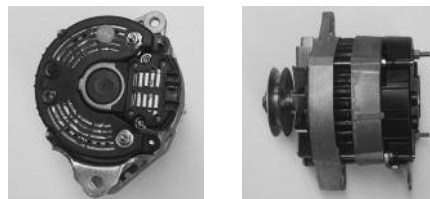

- BRUSH HOLDER 09 095984
- Valeo** **432745/433380**

A12M11	35	1	1V
14	↻	60°	Ø 55,4 INC

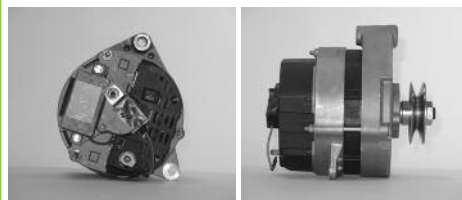

- SEP:SEPARATED REGULATOR -INC:BUILT-IN REGULATOR 02 300667
- Valeo** **432857/433352**

A12M16	35	1	1V
14	↻	45°	INC

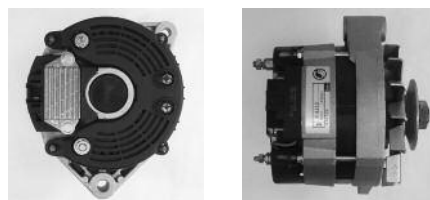

- SEP:SEPARATED REGULATOR -INC:BUILT-IN REGULATOR 02 300667
- Valeo** **433036/433353**

A12M17	35	1	1V
14	↻	∇	Ø 62,2 INC

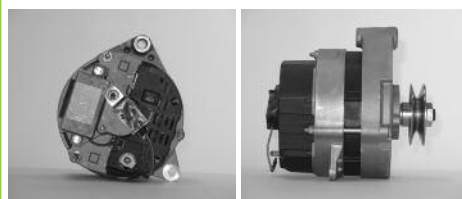

- SEP:SEPARATED REGULATOR -INC:BUILT-IN REGULATOR 02 300667
- Valeo** **432857/433352**



A12M18

35 1 1V

14 ↻ 20° ∇ ∅ 66 INC

**BRUSH HOLDER** 09

095984

Valeo

432745/433380

A12M2

35 1 1V

14 ↻ ∅ 93

Picture not available
Image non disponible
Imagen no disponible
Immagine non disponibile
Nicht verfügbares Bild
Brak zdjęcia
Картина недоступна

Picture not available
Image non disponible
Imagen no disponible
Immagine non disponibile
Nicht verfügbares Bild
Brak zdjęcia
Картина недоступна

BRUSH HOLDER 09

095984

Valeo

433396

A12M7

35 1 1V

14 ↻ 20° ∇ ∅ 66

Picture not available
Image non disponible
Imagen no disponible
Immagine non disponibile
Nicht verfügbares Bild
Brak zdjęcia
Картина недоступна

Picture not available
Image non disponible
Imagen no disponible
Immagine non disponibile
Nicht verfügbares Bild
Brak zdjęcia
Картина недоступна

BRUSH HOLDER 09

095984

Valeo

432744/433376

A12M9

35 1 1V

14 ↻ 45° ∇ ∅ 72,9 INC

**BRUSH HOLDER** 09

095984

SEP:SEPARATED REGULATOR -INC:BUILT-IN REGULATOR 02300667**Valeo**

433036/433353

A12R1

35 2 1V

14 ↻ 20° ∇ ∅ 69,7

Picture not available
Image non disponible
Imagen no disponible
Immagine non disponibile
Nicht verfügbares Bild
Brak zdjęcia
Картина недоступна

Picture not available
Image non disponible
Imagen no disponible
Immagine non disponibile
Nicht verfügbares Bild
Brak zdjęcia
Картина недоступна

BRUSH HOLDER 09

095984

RECTIFIER OR DIODE BRIDGE ASSEMBLY 07

092086

Valeo

432728

A12R10

35 2 1V

14 ↻ 60° ∇ ∅ 60

Picture not available
Image non disponible
Imagen no disponible
Immagine non disponibile
Nicht verfügbares Bild
Brak zdjęcia
Картина недоступна

Picture not available
Image non disponible
Imagen no disponible
Immagine non disponibile
Nicht verfügbares Bild
Brak zdjęcia
Картина недоступна

BRUSH HOLDER 09

095984

RECTIFIER OR DIODE BRIDGE ASSEMBLY 07

092086

Valeo

432736

A12R11

35 2 1V

14 ↻ 20° ∇ ∅ 76,5 INC

**BRUSH HOLDER** 09

095984

RECTIFIER OR DIODE BRIDGE ASSEMBLY 07

092086

Valeo

432749/433407

A12R12

35 1 1V

14 ↻ 120° ∇ ∅ 59,7 INC

**AUXILIARY DIODE** 08

092425

BRUSH HOLDER 09

095984

RECTIFIER OR DIODE BRIDGE ASSEMBLY 07

092086

Valeo

432855/433387

A12R13

35 1 1V

14 ↻ 120° ∇ ∅ 59,7 INC

**BRUSH HOLDER** 09

095984

RECTIFIER OR DIODE BRIDGE ASSEMBLY 07

092086

Valeo

432855/433387

A12R14

35 1 1V

14 ↻ 45° ∇ ∅ 59,7 INC

**BRUSH HOLDER** 09

095984

RECTIFIER OR DIODE BRIDGE ASSEMBLY 07

092086

Valeo

433416

A12R16

35 1 1V

14  16°  Ø 70

Picture not available
Image non disponible
Imagen no disponible
Immagine non disponibile
Nicht verfügbares Bild
Brak zdjęcia
Картина недоступна

Picture not available
Image non disponible
Imagen no disponible
Immagine non disponibile
Nicht verfügbares Bild
Brak zdjęcia
Картина недоступна

AUXILIARY DIODE  08

092425

BRUSH HOLDER  09

092743

RECTIFIER OR DIODE BRIDGE ASSEMBLY  07

092086

Valeo

432973/433471

A12R17

35 1 1V

14  Ø 80,2

Picture not available
Image non disponible
Imagen no disponible
Immagine non disponibile
Nicht verfügbares Bild
Brak zdjęcia
Картина недоступна

Picture not available
Image non disponible
Imagen no disponible
Immagine non disponibile
Nicht verfügbares Bild
Brak zdjęcia
Картина недоступна

AUXILIARY DIODE  08

092425

BRUSH HOLDER  09

092743

RECTIFIER OR DIODE BRIDGE ASSEMBLY  07

092086

Valeo

432973/433471

A12R19

35 2 1V

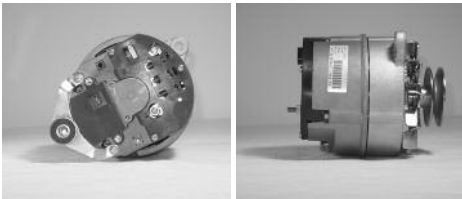
14  20°  Ø 63 SEP**BRUSH HOLDER**  09

095984

RECTIFIER OR DIODE BRIDGE ASSEMBLY  07

092086

Valeo

433436

A12R2

35 2 1V

14  50°  Ø 59,7 SEP**BRUSH HOLDER**  09

095984

RECTIFIER OR DIODE BRIDGE ASSEMBLY  07

092086

Valeo

433408

A12R21

35 1 1V

14  20°  Ø 66 SEP**BRUSH HOLDER**  09

095984

RECTIFIER OR DIODE BRIDGE ASSEMBLY  07

092086

Valeo

432715/433392

A12R22

40 1 1V

14  42°  Ø 70 INC

Picture not available
Image non disponible
Imagen no disponible
Immagine non disponibile
Nicht verfügbares Bild
Brak zdjęcia
Картина недоступна

Picture not available
Image non disponible
Imagen no disponible
Immagine non disponibile
Nicht verfügbares Bild
Brak zdjęcia
Картина недоступна

SEP:SEPARATED REGULATOR -INC:BUILT-IN REGULATOR  02300820**RECTIFIER OR DIODE BRIDGE ASSEMBLY**  07

092086

Valeo

432747/433404

A12R23

35 1 1V

14  20°  Ø 66 SEP**AUXILIARY DIODE**  08

092425

BRUSH HOLDER  09

095984

RECTIFIER OR DIODE BRIDGE ASSEMBLY  07

092086

Valeo

432715/433392

A12R25

40 1 1V

14  20°  Ø 55,4

Picture not available
Image non disponible
Imagen no disponible
Immagine non disponibile
Nicht verfügbares Bild
Brak zdjęcia
Картина недоступна

Picture not available
Image non disponible
Imagen no disponible
Immagine non disponibile
Nicht verfügbares Bild
Brak zdjęcia
Картина недоступна

SEP:SEPARATED REGULATOR -INC:BUILT-IN REGULATOR  02300820**RECTIFIER OR DIODE BRIDGE ASSEMBLY**  07

092086

Valeo

432770/433388

A12R26

35 1 1V

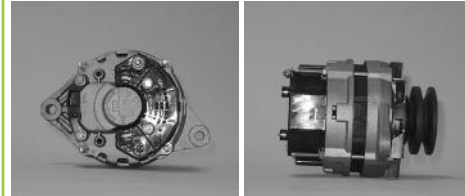
14  20°  Ø 70 SEP**RECTIFIER OR DIODE BRIDGE ASSEMBLY**  07

092086

Valeo

432714/433395

A12R27

35 1 1V

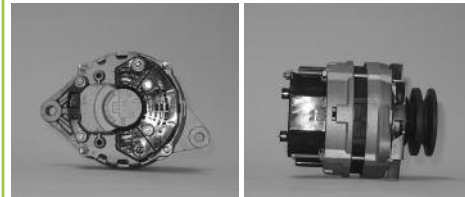
14  20°  Ø 70 SEP**AUXILIARY DIODE**  08

092425

BRUSH HOLDER  09

095984

RECTIFIER OR DIODE BRIDGE ASSEMBLY  07

092086

Valeo

432714/433395

A12R3

35 2 1V

14 ↻ 60° ∇ Ø 63 SEP

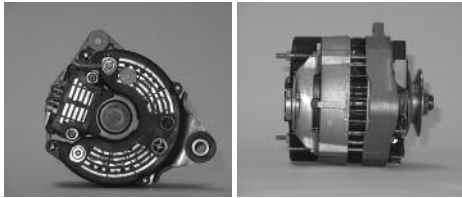
**BRUSH HOLDER** 📏09

095984

RECTIFIER OR DIODE BRIDGE ASSEMBLY 📏07

092086

Valeo

432771/433426

A12R30

40 1 1V

14 ↻ 20° ∇ Ø 70 INC

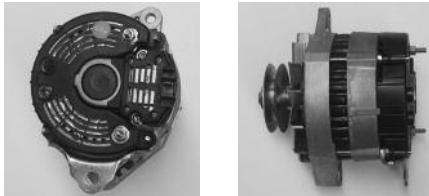
**RECTIFIER OR DIODE BRIDGE ASSEMBLY** 📏07

092086

Valeo

432745/433380

A12R31

40 2 1V

14 ↻ 20° ∇ Ø 70 INC

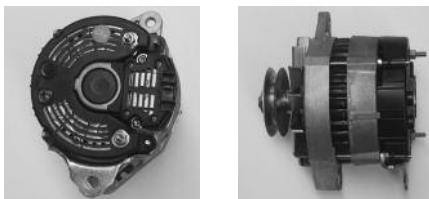
**RECTIFIER OR DIODE BRIDGE ASSEMBLY** 📏07

092086

Valeo

432745/433380

A12R32

40 1 1V

14 ↻ INC

**RECTIFIER OR DIODE BRIDGE ASSEMBLY** 📏07

092086

Valeo

432744/433375

A12R33

40 1 1V

14 ↻ 20° ∇ Ø 66 INC

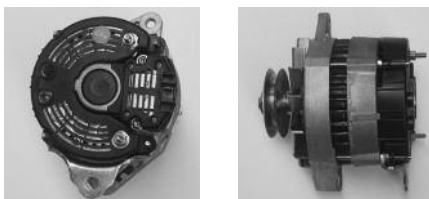
**SEP:SEPARATED REGULATOR -INC:BUILT-IN REGULATOR** 📏02300820**RECTIFIER OR DIODE BRIDGE ASSEMBLY** 📏07

092086

Valeo

432745/433380

A12R34

40 1 1V

14 ↻ 20° ∇ Ø 72,7 INC

**SEP:SEPARATED REGULATOR -INC:BUILT-IN REGULATOR** 📏02300820**RECTIFIER OR DIODE BRIDGE ASSEMBLY** 📏07

092086

Valeo

432744/433375

A12R351T

25 2 1V

28 ↻ Ø 55,4

Picture not available
Image non disponible
Imagen no disponible
Immagine non disponibile
Nicht verfügbares Bild
Brak zdjęcia
Картина недоступна

Picture not available
Image non disponible
Imagen no disponible
Immagine non disponibile
Nicht verfügbares Bild
Brak zdjęcia
Картина недоступна

REAR BEARING 📏22

590619

A12R37

40 1 1V

14 ↻ 45° ∇ Ø 59,7 INC

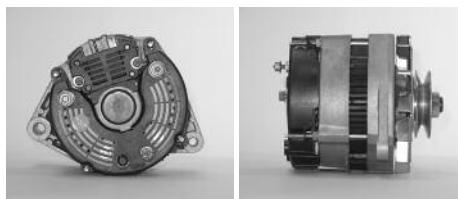
**RECTIFIER OR DIODE BRIDGE ASSEMBLY** 📏07

092086

A12R37

40 1 1V

14 ↻ 45° ∇ Ø 59,7 INC

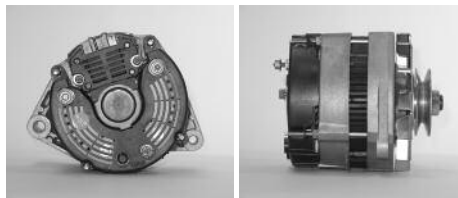
**RECTIFIER OR DIODE BRIDGE ASSEMBLY** 📏07

092086

Valeo

432739/433358

A12R38

40 1 1V

14 ↻ 30° ∇ Ø 55,4 INC

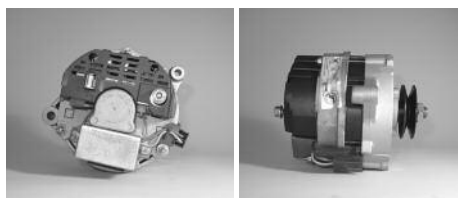
**SEP:SEPARATED REGULATOR -INC:BUILT-IN REGULATOR** 📏02300667**Valeo**

432846/433363

A12R4	35	1	1V
14		20°	Ø 63,25

Picture not available
Image non disponible
Imagen no disponible
Immagine non disponibile
Nicht verfügbares Bild
Brak zdjęcia
Картина недоступна

Picture not available
Image non disponible
Imagen no disponible
Immagine non disponibile
Nicht verfügbares Bild
Brak zdjęcia
Картина недоступна

BRUSH HOLDER 09 095984
RECTIFIER OR DIODE BRIDGE ASSEMBLY 07 092086
Valeo 432728

A12R42	35	1	SP
14			

Picture not available
Image non disponible
Imagen no disponible
Immagine non disponibile
Nicht verfügbares Bild
Brak zdjęcia
Картина недоступна

Picture not available
Image non disponible
Imagen no disponible
Immagine non disponibile
Nicht verfügbares Bild
Brak zdjęcia
Картина недоступна

BRUSH HOLDER 09 092743
RECTIFIER OR DIODE BRIDGE ASSEMBLY 07 092086
Valeo 432973/433471

A12R43	40	1	1V
14		60°	Ø 55,4 INC

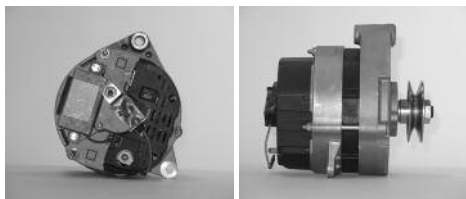

RECTIFIER OR DIODE BRIDGE ASSEMBLY 07 092086
Valeo 432857/433352

A12R44	40	1	1V
14		120°	Ø 59,7 INC



SEP:SEPARATED REGULATOR -INC:BUILT-IN REGULATOR 02300820
RECTIFIER OR DIODE BRIDGE ASSEMBLY 07 092086
Valeo 432855/433387

A12R45	40	1	1V
14		45°	Ø 66 INC

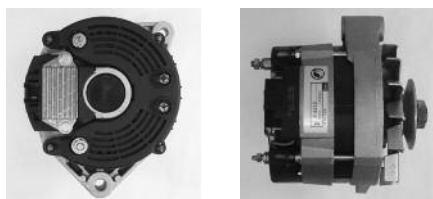

RECTIFIER OR DIODE BRIDGE ASSEMBLY 07 092086
Valeo 433036/433353

A12R47	35	1	1V
14		20°	Ø 66 SEP



BRUSH HOLDER 09 095984
RECTIFIER OR DIODE BRIDGE ASSEMBLY 07 092086
Valeo 432714/433395

A12R48	35	1	1V
14		20°	Ø 66 SEP

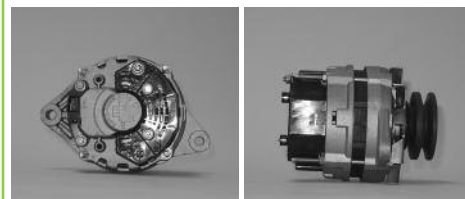

AUXILIARY DIODE 08 092425
BRUSH HOLDER 09 095984
RECTIFIER OR DIODE BRIDGE ASSEMBLY 07 092086
Valeo 432714/433395

A12R52	40	2	1V
14		20°	Ø 66 INC

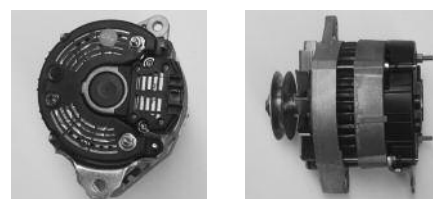

SEP:SEPARATED REGULATOR -INC:BUILT-IN REGULATOR 02300820
RECTIFIER OR DIODE BRIDGE ASSEMBLY 07 092086
Valeo 432745/433380

A12R53	40	1	1V
14			INC



SEP:SEPARATED REGULATOR -INC:BUILT-IN REGULATOR 02300820
RECTIFIER OR DIODE BRIDGE ASSEMBLY 07 092086
Valeo 433036/433354

A12R54	35	1	1V
14			Ø 55,4

Picture not available
Image non disponible
Imagen no disponible
Immagine non disponibile
Nicht verfügbares Bild
Brak zdjęcia
Картина недоступна

Picture not available
Image non disponible
Imagen no disponible
Immagine non disponibile
Nicht verfügbares Bild
Brak zdjęcia
Картина недоступна

RECTIFIER OR DIODE BRIDGE ASSEMBLY 07 092086
Valeo 432844

A12R56

35 1 1V

14 ↻ 60° ▷ Ø 55,4 SEP

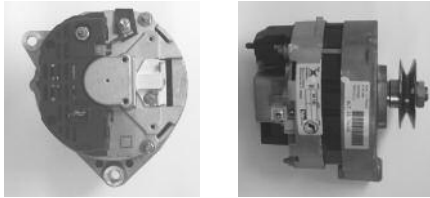

RECTIFIER OR DIODE BRIDGE ASSEMBLY 07 092086
Valeo 432834/433351

A12R9

35 1 1V

14 ↻ ▷ Ø 66 INC

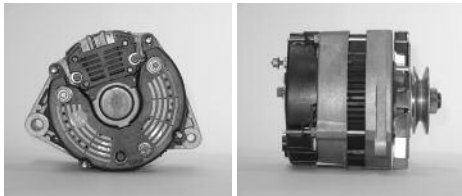

AUXILIARY DIODE 08 092425
 BRUSH HOLDER 09 095984
 RECTIFIER OR DIODE BRIDGE ASSEMBLY 07 092086
Valeo 433036/433354

A13E02

55 1 1V

14 ↻ 15° ▷ Ø 56 INC



PLASTIC CAPSULE 26 590650
 REAR BEARING 22 590619
 PROTECTION COVER 24 590651
 RECTIFIER OR DIODE BRIDGE ASSEMBLY 07 523321
 FAN 12 592673
 PULLEY 11 592669
Valeo 433046/436399

A13E03

65 1 1V

14 ↻ 15° ▷ Ø 56 INC



PLASTIC CAPSULE 26 590650
 REAR BEARING 22 590619
 PROTECTION COVER 24 590651
 RECTIFIER OR DIODE BRIDGE ASSEMBLY 07 523321
 FAN 12 592673
 PULLEY 11 592669
Valeo 433046/436399

A13E05

65 1 1V

14 ↻ 15° ▷ Ø 56 INC

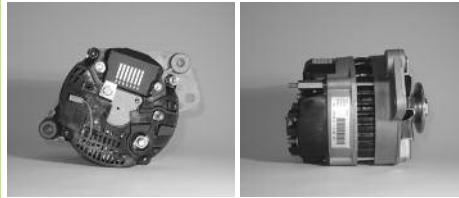

PLASTIC CAPSULE 26 590650
 REAR BEARING 22 590619
 PROTECTION COVER 24 590651
 CONDENSOR 14 592674
 RECTIFIER OR DIODE BRIDGE ASSEMBLY 07 523321
 FAN 12 592673
 PULLEY 11 592669
Valeo 433050/436296

A13E06

55 1 1V

14 ↻ 60° ▷ Ø 61 INC



PLASTIC CAPSULE 26 590650
 REAR BEARING 22 590619
 PROTECTION COVER 24 590651
 CONDENSOR 14 592674
 RECTIFIER OR DIODE BRIDGE ASSEMBLY 07 523321
 FAN 12 592673
 PULLEY 11 592666
Valeo 433044/436191

A13E07

65 1 1V

14 ↻ 60° ▷ Ø 61 INC



PLASTIC CAPSULE 26 590650
 REAR BEARING 22 590619
 PROTECTION COVER 24 590651
 CONDENSOR 14 592674
 RECTIFIER OR DIODE BRIDGE ASSEMBLY 07 523321
 FAN 12 592673
 PULLEY 11 592666

A13E07

65

1

1V

14



60°

Ø 61

INC

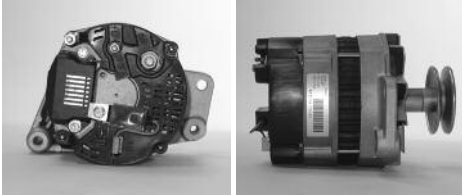
**PLASTIC CAPSULE** 26

590650

REAR BEARING 22

590619

PROTECTION COVER 24

590651

CONDENSOR 14

592674

RECTIFIER OR DIODE BRIDGE ASSEMBLY 07

523321

FAN 12

592673

PULLEY 11

592666

Valeo**433044/436228****A13E08**

45

1

1V

14



15°

Ø 61

INC

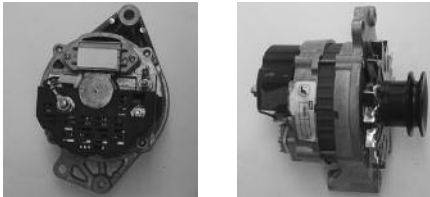
**PLASTIC CAPSULE** 26

590650

REAR BEARING 22

590619

PROTECTION COVER 24

590651

CONDENSOR 14

592674

RECTIFIER OR DIODE BRIDGE ASSEMBLY 07

523321

FAN 12

592673

PULLEY 11

523335

Valeo**433047/436193****A13E09**

65

1

1V

14



15°

Ø 61

INC

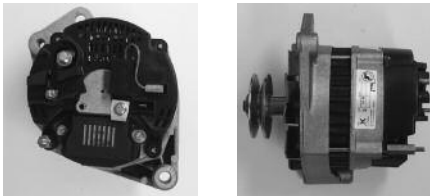
**PLASTIC CAPSULE** 26

590650

REAR BEARING 22

590619

PROTECTION COVER 24

590651

CONDENSOR 14

592674

RECTIFIER OR DIODE BRIDGE ASSEMBLY 07

523321

FAN 12

592673

PULLEY 11

523335

Valeo**436400****A13E10**

45

1

1V

14



Ø 61

INC

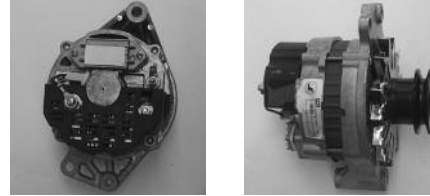
**PLASTIC CAPSULE** 26

590650

REAR BEARING 22

590619

PROTECTION COVER 24

590651

CONDENSOR 14

592674

RECTIFIER OR DIODE BRIDGE ASSEMBLY 07

523321

FAN 12

592673

PULLEY 11

523335

Valeo**433047/436193****A13E11**

65

1

1V

14



15°

Ø 61

INC

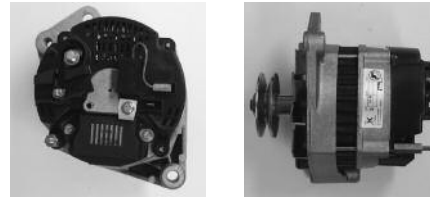
**PLASTIC CAPSULE** 26

590650

REAR BEARING 22

590619

PROTECTION COVER 24

590651

CONDENSOR 14

592674

RECTIFIER OR DIODE BRIDGE ASSEMBLY 07

523321

FAN 12

592673

PULLEY 11

523335

Valeo**433048/436400****A13E12**

45

1

1V

14



60°

Ø 61

INC

**PLASTIC CAPSULE** 26

590650

REAR BEARING 22

590619

PROTECTION COVER 24

590651

CONDENSOR 14

592674

RECTIFIER OR DIODE BRIDGE ASSEMBLY 07

523321

FAN 12

592673

PULLEY 11

592666

Valeo**436192**

A13E13

65 1 1V

14 ↻ ∅ 61 INC



PLASTIC CAPSULE 26 590650
REAR BEARING 22 590619
PROTECTION COVER 24 590651
RECTIFIER OR DIODE BRIDGE ASSEMBLY 07 523321
FAN 12 592673
PULLEY 11 592666
Valeo **433044/436191**

A13E19

55 2 1V

14 ↻ 108-117° ∅ 66,25 INC

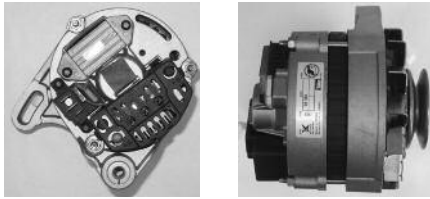

PLASTIC CAPSULE 26 590650
REAR BEARING 22 590619
FAN 12 592673
PULLEY 11 096882
Valeo **433083/436147**

A13E21

55 1 1V

14 ↻ 15° ∅ 56 INC



PLASTIC CAPSULE 26 590650
PROTECTION COVER 24 590651
RECTIFIER OR DIODE BRIDGE ASSEMBLY 07 523321
FAN 12 592673
PULLEY 11 592669
Valeo **433046/436399**

A13E22

65 1 1V

14 ↻ 15° ∅ 56 INC

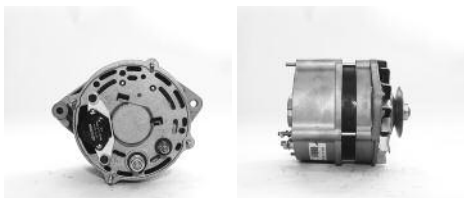

PLASTIC CAPSULE 26 590650
PROTECTION COVER 24 590651
RECTIFIER OR DIODE BRIDGE ASSEMBLY 07 523321
FAN 12 592673
PULLEY 11 592669
Valeo **433046/436399**

A13E23

55 2 1V

14 ↻ 0° ∅ 59,7 INC

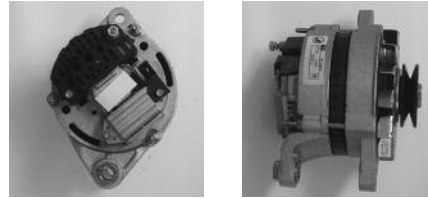

PLASTIC CAPSULE 26 590650
REAR BEARING 22 590619
RECTIFIER OR DIODE BRIDGE ASSEMBLY 07 592650
FAN 12 592673

A13E23

55 2 1V

14 ↻ 0° ∅ 59,7 INC

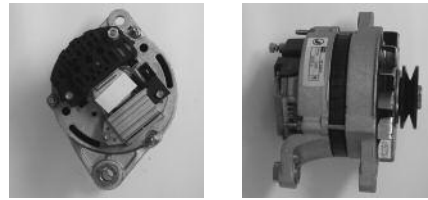

PLASTIC CAPSULE 26 590650
REAR BEARING 22 590619
RECTIFIER OR DIODE BRIDGE ASSEMBLY 07 592650
FAN 12 592673

A13E23

55 2 1V

14 ↻ 0° ∅ 59,7 INC

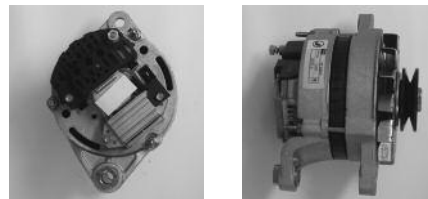

PLASTIC CAPSULE 26 590650
REAR BEARING 22 590619
RECTIFIER OR DIODE BRIDGE ASSEMBLY 07 592650
FAN 12 592673
Valeo **433117/436112**

A13E24

55 2 1V

14 ↻ 33° ∅ 77



PLASTIC CAPSULE 26 590650
REAR BEARING 22 590619
RECTIFIER OR DIODE BRIDGE ASSEMBLY 07 592650
Valeo **433116/436245**

Picture not available
 Image non disponible
 Imagen no disponible
 Immagine non disponibile
 Nicht verfügbares Bild
 Brak zdjęcia
 Картина недоступна

Picture not available
 Image non disponible
 Imagen no disponible
 Immagine non disponibile
 Nicht verfügbares Bild
 Brak zdjęcia
 Картина недоступна

A13E25

55

2

1V

14



33°

Ø 59,7

INC

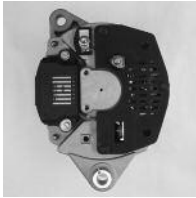
**PLASTIC CAPSULE** 26

590650

REAR BEARING 22

590619

RECTIFIER OR DIODE BRIDGE ASSEMBLY 07

592650

FAN 12

592673

Valeo**433115/436114****A13E26**

55

2

1V

14



30°

Ø 61

INC

**B+(M6)D+(M5)****PLASTIC CAPSULE** 26

590650

REAR BEARING 22

590619

RECTIFIER OR DIODE BRIDGE ASSEMBLY 07

592650

FAN 12

592673

Valeo**433118/436117****A13E27**

55

2

1V

14



Ø 56

Picture not available
Image non disponible
Imagen no disponible
Immagine non disponibile
Nicht verfügbares Bild
Brak zdjęć
Картина недоступна

Picture not available
Image non disponible
Imagen no disponible
Immagine non disponibile
Nicht verfügbares Bild
Brak zdjęć
Картина недоступна

PLASTIC CAPSULE 26

590650

FAN 12

592673

PULLEY 11

592669

A13E31

55

2

1V

14



60°

Ø 77

Picture not available
Image non disponible
Imagen no disponible
Immagine non disponibile
Nicht verfügbares Bild
Brak zdjęć
Картина недоступна

Picture not available
Image non disponible
Imagen no disponible
Immagine non disponibile
Nicht verfügbares Bild
Brak zdjęć
Картина недоступна

PLASTIC CAPSULE 26

590650

FAN 12

592673

A13E32

55

2

2V

14



60°

Ø 69

Picture not available
Image non disponible
Imagen no disponible
Immagine non disponibile
Nicht verfügbares Bild
Brak zdjęć
Картина недоступна

Picture not available
Image non disponible
Imagen no disponible
Immagine non disponibile
Nicht verfügbares Bild
Brak zdjęć
Картина недоступна

PLASTIC CAPSULE 26

590650

REAR BEARING 22

590619

FAN 12

592673

A13E33

55

2

14



60°

Picture not available
Image non disponible
Imagen no disponible
Immagine non disponibile
Nicht verfügbares Bild
Brak zdjęć
Картина недоступна

Picture not available
Image non disponible
Imagen no disponible
Immagine non disponibile
Nicht verfügbares Bild
Brak zdjęć
Картина недоступна

PLASTIC CAPSULE 26

590650

REAR BEARING 22

590619

FAN 12

592673

A13E34

55

2

2V

14



60°

Ø 70

Picture not available
Image non disponible
Imagen no disponible
Immagine non disponibile
Nicht verfügbares Bild
Brak zdjęć
Картина недоступна

Picture not available
Image non disponible
Imagen no disponible
Immagine non disponibile
Nicht verfügbares Bild
Brak zdjęć
Картина недоступна

PLASTIC CAPSULE 26

590650

REAR BEARING 22

590619

FAN 12

592673

A13E35

55

2

1V

14



60°

Ø 70

Picture not available
Image non disponible
Imagen no disponible
Immagine non disponibile
Nicht verfügbares Bild
Brak zdjęć
Картина недоступна

Picture not available
Image non disponible
Imagen no disponible
Immagine non disponibile
Nicht verfügbares Bild
Brak zdjęć
Картина недоступна

PLASTIC CAPSULE 26

590650

REAR BEARING 22

590619

FAN 12

592673

A13E36

70

2

1V

14



60°

Ø 77

Picture not available
Image non disponible
Imagen no disponible
Immagine non disponibile
Nicht verfügbares Bild
Brak zdjęć
Картина недоступна

Picture not available
Image non disponible
Imagen no disponible
Immagine non disponibile
Nicht verfügbares Bild
Brak zdjęć
Картина недоступна

PLASTIC CAPSULE 26

590650

REAR BEARING 22

590619

FAN 12

592673



A13E37

70 2 1V

14 ↻ 60° ∇ Ø 56

Picture not available
Image non disponible
Imagen no disponible
Immagine non disponibile
Nicht verfügbares Bild
Brak zdjęcia
Картина недоступна

Picture not available
Image non disponible
Imagen no disponible
Immagine non disponibile
Nicht verfügbares Bild
Brak zdjęcia
Картина недоступна

PLASTIC CAPSULE 📏 26

590650

REAR BEARING 📏 22

590619

FAN 📏 12

592673

PULLEY 📏 11

592669

A13E38

70 2 1V

14 ↻ 60° ∇ Ø 70

Picture not available
Image non disponible
Imagen no disponible
Immagine non disponibile
Nicht verfügbares Bild
Brak zdjęcia
Картина недоступна

Picture not available
Image non disponible
Imagen no disponible
Immagine non disponibile
Nicht verfügbares Bild
Brak zdjęcia
Картина недоступна

PLASTIC CAPSULE 📏 26

590650

REAR BEARING 📏 22

590619

FAN 📏 12

592673

A13E39

65 1 1V

14 ↻ 15° ∇ Ø 64,4 INC

Picture not available
Image non disponible
Imagen no disponible
Immagine non disponibile
Nicht verfügbares Bild
Brak zdjęcia
Картина недоступна

Picture not available
Image non disponible
Imagen no disponible
Immagine non disponibile
Nicht verfügbares Bild
Brak zdjęcia
Картина недоступна

PLASTIC CAPSULE 📏 26

590650

REAR BEARING 📏 22

590619

PROTECTION COVER 📏 24

590651

RECTIFIER OR DIODE BRIDGE ASSEMBLY 📏 07

523321

FAN 📏 12

592673

PULLEY 📏 11

592669

Valeo**433046/437600****A13E42**

45 1 1V

14 ↻ Ø 61 INC

**PLASTIC CAPSULE** 📏 26

590650

REAR BEARING 📏 22

590619

PROTECTION COVER 📏 24

590651

CONDENSOR 📏 14

592674

RECTIFIER OR DIODE BRIDGE ASSEMBLY 📏 07

523321

FAN 📏 12

592673

PULLEY 📏 11

523335

Valeo**433047/436193****A13E43**

65 1 1V

14 ↻ Ø 61 INC

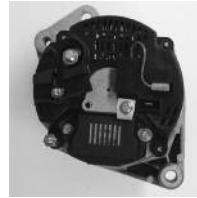
**PLASTIC CAPSULE** 📏 26

590650

REAR BEARING 📏 22

590619

PROTECTION COVER 📏 24

590651

CONDENSOR 📏 14

592674

RECTIFIER OR DIODE BRIDGE ASSEMBLY 📏 07

523321

FAN 📏 12

592673

PULLEY 📏 11

523335

A13E43

65 1 1V

14 ↻ Ø 61 INC

**PLASTIC CAPSULE** 📏 26

590650

REAR BEARING 📏 22

590619

PROTECTION COVER 📏 24

590651

CONDENSOR 📏 14

592674

RECTIFIER OR DIODE BRIDGE ASSEMBLY 📏 07

523321

FAN 📏 12

592673

PULLEY 📏 11

523335

Valeo**433048/436400****A13E44**

45 1 1V

14 ↻ Ø 61 INC

**PLASTIC CAPSULE** 📏 26

590650

REAR BEARING 📏 22

590619

PROTECTION COVER 📏 24

590651

CONDENSOR 📏 14

592674

RECTIFIER OR DIODE BRIDGE ASSEMBLY 📏 07

523321

FAN 📏 12

592673

PULLEY 📏 11

592666

Valeo**433043/436192****A13E45**

65 1 1V

14 ↻ Ø 61 INC

**PLASTIC CAPSULE** 📏 26

590650

REAR BEARING 📏 22

590619

PROTECTION COVER 📏 24

590651

RECTIFIER OR DIODE BRIDGE ASSEMBLY 📏 07

523321

FAN 📏 12

592673

PULLEY 📏 11

592666

A13E45	65	1	1V
14	↻	Ø 61	INC



PLASTIC CAPSULE 26 590650
REAR BEARING 22 590619
PROTECTION COVER 24 590651
RECTIFIER OR DIODE BRIDGE ASSEMBLY 07 523321
FAN 12 592673
PULLEY 11 592666

A13E45	65	1	1V
14	↻	Ø 61	INC



PLASTIC CAPSULE 26 590650
REAR BEARING 22 590619
PROTECTION COVER 24 590651
RECTIFIER OR DIODE BRIDGE ASSEMBLY 07 523321
FAN 12 592673
PULLEY 11 592666

A13E45	65	1	1V
14	↻	Ø 61	INC



PLASTIC CAPSULE 26 590650
REAR BEARING 22 590619
PROTECTION COVER 24 590651
RECTIFIER OR DIODE BRIDGE ASSEMBLY 07 523321
FAN 12 592673
PULLEY 11 592666

Valeo 433044/436240

A13E46	55	1	1V
14	↻	Ø 65	



PLASTIC CAPSULE 26 590650
PROTECTION COVER 24 590651
RECTIFIER OR DIODE BRIDGE ASSEMBLY 07 523321
FAN 12 592673

A13E47	65	1	1V
14	↻	Ø 65	



PLASTIC CAPSULE 26 590650
PROTECTION COVER 24 590651
RECTIFIER OR DIODE BRIDGE ASSEMBLY 07 523321
FAN 12 592673
Valeo 436368

A13E48	55	1	1V
14	↻	Ø 65	



PLASTIC CAPSULE 26 590650
PROTECTION COVER 24 590651
CONDENSOR 14 592674
RECTIFIER OR DIODE BRIDGE ASSEMBLY 07 523321
FAN 12 592673
Valeo 436369

A13E49	65	1	1V
14	↻	Ø 65	



PLASTIC CAPSULE 26 590650
PROTECTION COVER 24 590651
CONDENSOR 14 592674
RECTIFIER OR DIODE BRIDGE ASSEMBLY 07 523321
FAN 12 592673
Valeo 436370

A13E50	50	1	1V
14	↻	94-108°	Ø 61,12 INC

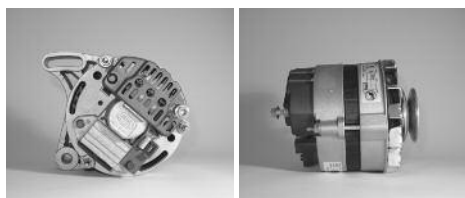

PLASTIC CAPSULE 26 590650
REAR BEARING 22 590619
SEP:SEPARATED REGULATOR -INC:BUILT-IN REGULATOR 02 592602
FAN 12 592673

A13E50

50 1 1V

14 ↻ 94-108° ∅ 61,12 INC

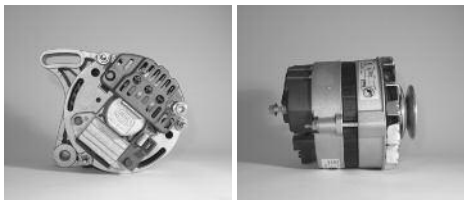

PLASTIC CAPSULE 🛠️ 26 590650
REAR BEARING 🛠️ 22 590619
SEP:SEPARATED REGULATOR -INC:BUILT-IN REGULATOR 🛠️ 02 592602
FAN 🛠️ 12 592673
Valeo 433085/436230

A13E54

65 1 1V

14 ↻ 60° ∅ 61 INC



PLASTIC CAPSULE 🛠️ 26 590650
REAR BEARING 🛠️ 22 590619
PROTECTION COVER 🛠️ 24 590651
CONDENSOR 🛠️ 14 592674
SEP:SEPARATED REGULATOR -INC:BUILT-IN REGULATOR 🛠️ 02 592888
RECTIFIER OR DIODE BRIDGE ASSEMBLY 🛠️ 07 523321
FAN 🛠️ 12 592673
PULLEY 🛠️ 11 592666

A13E54

65 1 1V

14 ↻ 60° ∅ 61 INC



PLASTIC CAPSULE 🛠️ 26 590650
REAR BEARING 🛠️ 22 590619
PROTECTION COVER 🛠️ 24 590651
CONDENSOR 🛠️ 14 592674
SEP:SEPARATED REGULATOR -INC:BUILT-IN REGULATOR 🛠️ 02 592888
RECTIFIER OR DIODE BRIDGE ASSEMBLY 🛠️ 07 523321
FAN 🛠️ 12 592673
PULLEY 🛠️ 11 592666
Valeo 436228

A13E58

65 1 1V

14 ↻ 15° ∅ 65 INC

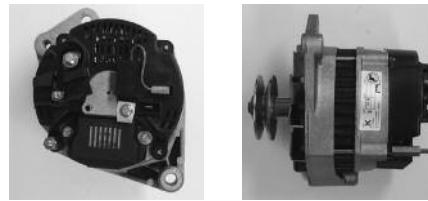

PLASTIC CAPSULE 🛠️ 26 590650
PROTECTION COVER 🛠️ 24 590651
CONDENSOR 🛠️ 14 592674
SEP:SEPARATED REGULATOR -INC:BUILT-IN REGULATOR 🛠️ 02 592888
RECTIFIER OR DIODE BRIDGE ASSEMBLY 🛠️ 07 523321
FAN 🛠️ 12 592673
PULLEY 🛠️ 11 523335
Valeo 433048/436400

A13E63

65 1 4V

14 ↻ 46° ∅ 63,2

Picture not available
 Image non disponible
 Imagen no disponible
 Immagine non disponibile
 Nicht verfügbares Bild
 Brak zdjęcia
 Картина недоступна

Picture not available
 Image non disponible
 Imagen no disponible
 Immagine non disponibile
 Nicht verfügbares Bild
 Brak zdjęcia
 Картина недоступна

PLASTIC CAPSULE 🛠️ 26 590650
SEP:SEPARATED REGULATOR -INC:BUILT-IN REGULATOR 🛠️ 02 592602
FAN 🛠️ 12 590553
Valeo 439034/436485

A13M12

25 1 1V

14 ↻ 40° ∅ 59,7 INC



BRUSH HOLDER 🛠️ 09 095788
Valeo 433382

A13M4

25 1 1V

14 ↻ 20° ∅ 76,2

Picture not available
 Image non disponible
 Imagen no disponible
 Immagine non disponibile
 Nicht verfügbares Bild
 Brak zdjęcia
 Картина недоступна

Picture not available
 Image non disponible
 Imagen no disponible
 Immagine non disponibile
 Nicht verfügbares Bild
 Brak zdjęcia
 Картина недоступна

BRUSH HOLDER 🛠️ 09 095788
Valeo 436262

A13M9

25

1

1V

14



Ø 76,2

Picture not available
Image non disponible
Imagen no disponible
Immagine non disponibile
Nicht verfügbares Bild
Brak zdjęćia
Картина недоступна

Picture not available
Image non disponible
Imagen no disponible
Immagine non disponibile
Nicht verfügbares Bild
Brak zdjęćia
Картина недоступна

BRUSH HOLDER 09**Valeo**

095788

432982/436262

A13N10

55

1

14



16°∇

Picture not available
Image non disponible
Imagen no disponible
Immagine non disponibile
Nicht verfügbares Bild
Brak zdjęćia
Картина недоступна

Picture not available
Image non disponible
Imagen no disponible
Immagine non disponibile
Nicht verfügbares Bild
Brak zdjęćia
Картина недоступна

PLASTIC CAPSULE 26

590627

PROTECTION COVER 24

590564

BRUSH HOLDER 09

092859

SEP:SEPARATED REGULATOR -INC:BUILT-IN REGULATOR 02

*2590558

FAN 12

590553

PULLEY 11

593253

ROTOR 04

092988

STATOR 05

100930

Valeo

432708

A13N103

50

1

14



Picture not available
Image non disponible
Imagen no disponible
Immagine non disponibile
Nicht verfügbares Bild
Brak zdjęćia
Картина недоступна

Picture not available
Image non disponible
Imagen no disponible
Immagine non disponibile
Nicht verfügbares Bild
Brak zdjęćia
Картина недоступна

PLASTIC CAPSULE 26

590627

PROTECTION COVER 24

590564

BRUSH HOLDER 09

092859

SEP:SEPARATED REGULATOR -INC:BUILT-IN REGULATOR 02

*2590558

FAN 12

590553

PULLEY 11

593253

ROTOR 04

092988

STATOR 05

100930

Valeo

432724

A13N104

50

1

1V

14



20°∇

Ø 59,7

INC

**PLASTIC CAPSULE** 26

590627

REAR BEARING 22

590568

PROTECTION COVER 24

590564

BRUSH HOLDER 09

092859

SEP:SEPARATED REGULATOR -INC:BUILT-IN REGULATOR 02

*2590558

RECTIFIER OR DIODE BRIDGE ASSEMBLY 07

180593

FAN 12

592673

FAN 12

590553

PULLEY 11

593253

ROTOR 04

092988

STATOR 05

100930

Valeo

432726/433442

A13N106

60

2

6V

14



0°∇

Ø 62,9

Picture not available
Image non disponible
Imagen no disponible
Immagine non disponibile
Nicht verfügbares Bild
Brak zdjęćia
Картина недоступна

Picture not available
Image non disponible
Imagen no disponible
Immagine non disponibile
Nicht verfügbares Bild
Brak zdjęćia
Картина недоступна

SEP:SEPARATED REGULATOR -INC:BUILT-IN REGULATOR 02

*2590558

Valeo

432716

A13N107

60

2

1V

14



42°∇

Ø 63,25

Picture not available
Image non disponible
Imagen no disponible
Immagine non disponibile
Nicht verfügbares Bild
Brak zdjęćia
Картина недоступна

Picture not available
Image non disponible
Imagen no disponible
Immagine non disponibile
Nicht verfügbares Bild
Brak zdjęćia
Картина недоступна

SEP:SEPARATED REGULATOR -INC:BUILT-IN REGULATOR 02

*2590558

Valeo

432717

A13N108+

70

2

1V

14



42°∇

Ø 63,25

Picture not available
Image non disponible
Imagen no disponible
Immagine non disponibile
Nicht verfügbares Bild
Brak zdjęćia
Картина недоступна

Picture not available
Image non disponible
Imagen no disponible
Immagine non disponibile
Nicht verfügbares Bild
Brak zdjęćia
Картина недоступна

PLASTIC CAPSULE 26

590627

REAR BEARING 22

590568

PROTECTION COVER 24

590564

SEP:SEPARATED REGULATOR -INC:BUILT-IN REGULATOR 02590704**RECTIFIER OR DIODE BRIDGE ASSEMBLY** 07

592880

PULLEY 11

096882

STATOR 05

592830

Valeo

432718

A13N109

50 2 1V

14 ↻ 60° ∇ Ø 60 INC

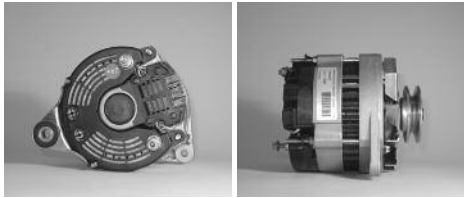

PLASTIC CAPSULE	26	590627
REAR BEARING	22	590568
PROTECTION COVER	24	590564
REAR BRACKET	25	593227
BRUSH SET	09a	300821
SEP:SEPARATED REGULATOR -INC:BUILT-IN REGULATOR	02	182120
FAN	12	092477
PULLEY	11	097140
ROTOR	04	092968
HARDWARE OF PULLEY	13	300767
STATOR	05	100930

Valeo**432719/436312****A13N11**

35 1

28 ↻↻ 0° ∇

Picture not available Image non disponible Imagen no disponible Immagine non disponibile Nicht verfügbares Bild Brak zdjęcia Картина недоступна	Picture not available Image non disponible Imagen no disponible Immagine non disponibile Nicht verfügbares Bild Brak zdjęcia Картина недоступна
---	---

PLASTIC CAPSULE	26	590629
FRONT BEARING	21	593224
REAR BEARING	22	590613
PROTECTION COVER	24	590564
BRUSH HOLDER	09	300665
SEP:SEPARATED REGULATOR -INC:BUILT-IN REGULATOR	02	590640
RECTIFIER OR DIODE BRIDGE ASSEMBLY	07	593196

Valeo**100442/436355****A13N110**

60 1 1V

14 ↻ 20° ∇ Ø 59,7 INC

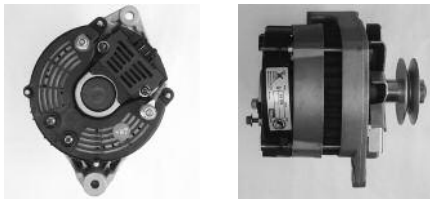

PLASTIC CAPSULE	26	590627
REAR BEARING	22	590568
PROTECTION COVER	24	590564
SEP:SEPARATED REGULATOR -INC:BUILT-IN REGULATOR	02	*2590558
RECTIFIER OR DIODE BRIDGE ASSEMBLY	07	180593
FAN	12	592673
PULLEY	11	593253
ROTOR	04	092985
STATOR	05	592729

A13N110

60 1 1V

14 ↻ 20° ∇ Ø 59,7 INC

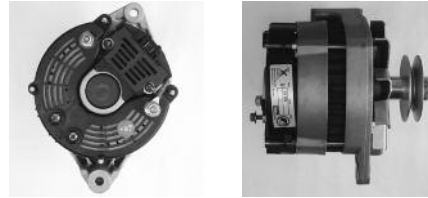

PLASTIC CAPSULE	26	590627
REAR BEARING	22	590568
PROTECTION COVER	24	590564
SEP:SEPARATED REGULATOR -INC:BUILT-IN REGULATOR	02	*2590558
RECTIFIER OR DIODE BRIDGE ASSEMBLY	07	180593
FAN	12	592673
PULLEY	11	593253
ROTOR	04	092985
STATOR	05	592729

Valeo**432726/433442****A13N112**

60 2 6V

14 ↻ 0° ∇ Ø 62,9

Picture not available Image non disponible Imagen no disponible Immagine non disponibile Nicht verfügbares Bild Brak zdjęcia Картина недоступна	Picture not available Image non disponible Imagen no disponible Immagine non disponibile Nicht verfügbares Bild Brak zdjęcia Картина недоступна
---	---

SEP:SEPARATED REGULATOR -INC:BUILT-IN REGULATOR	02	*2590558
---	----	----------

Valeo**180580****A13N113**

60 1 1V

14 ↻ 60° ∇ Ø 59,7 INC

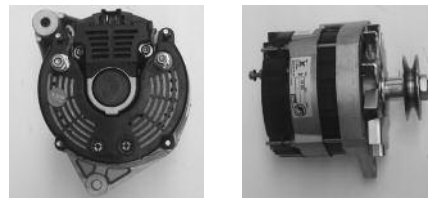

SEP:SEPARATED REGULATOR -INC:BUILT-IN REGULATOR	02	*2590558
---	----	----------

Valeo**432724/433429****A13N114**

60 1 1V

14 ↻ 60° ∇ Ø 59,7 INC

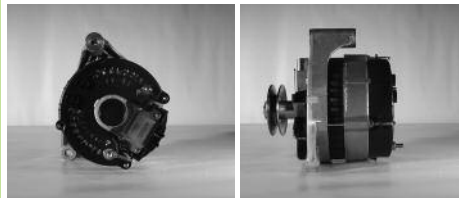

PLASTIC CAPSULE	26	590627
PROTECTION COVER	24	590564
SEP:SEPARATED REGULATOR -INC:BUILT-IN REGULATOR	02	*2590558
FAN	12	592673
PULLEY	11	593253
ROTOR	04	092985

Valeo**432726/433440**

A13N116

60

2

6V

14



Ø 62,9

Picture not available
Image non disponible
Imagem no disponibile
Immagine non disponibile
Nicht verfügbares Bild
Brak zdjęćia
Картина недоступна

Picture not available
Image non disponible
Imagem no disponibile
Immagine non disponibile
Nicht verfügbares Bild
Brak zdjęćia
Картина недоступна

SEP:SEPARATED REGULATOR -INC:BUILT-IN REGULATOR 02

*2590558

Valeo**432716****A13N117**

60

2

1V

14



Ø 63,25

Picture not available
Image non disponible
Imagem no disponibile
Immagine non disponibile
Nicht verfügbares Bild
Brak zdjęćia
Картина недоступна

Picture not available
Image non disponible
Imagem no disponibile
Immagine non disponibile
Nicht verfügbares Bild
Brak zdjęćia
Картина недоступна

SEP:SEPARATED REGULATOR -INC:BUILT-IN REGULATOR 02

*2590558

Valeo**432717****A13N118**

50

1

1V

14



20°

Ø 59,7

Picture not available
Image non disponible
Imagem no disponibile
Immagine non disponibile
Nicht verfügbares Bild
Brak zdjęćia
Картина недоступна

Picture not available
Image non disponible
Imagem no disponibile
Immagine non disponibile
Nicht verfügbares Bild
Brak zdjęćia
Картина недоступна

PLASTIC CAPSULE 26

590627

REAR BEARING 22

590568

PROTECTION COVER 24

590564

SEP:SEPARATED REGULATOR -INC:BUILT-IN REGULATOR 02

182120

RECTIFIER OR DIODE BRIDGE ASSEMBLY 07

105754

PULLEY 11

593253

STATOR 05

100930

Valeo**432725****A13N119**

50

2

1V

14



20°

Ø 79,4

Picture not available
Image non disponible
Imagem no disponibile
Immagine non disponibile
Nicht verfügbares Bild
Brak zdjęćia
Картина недоступна

Picture not available
Image non disponible
Imagem no disponibile
Immagine non disponibile
Nicht verfügbares Bild
Brak zdjęćia
Картина недоступна

PLASTIC CAPSULE 26

590627

REAR BEARING 22

590568

PROTECTION COVER 24

590564

SEP:SEPARATED REGULATOR -INC:BUILT-IN REGULATOR 02

*2590558

RECTIFIER OR DIODE BRIDGE ASSEMBLY 07

593193

FAN 12

592673

PULLEY 11

101932

STATOR 05

100930

Valeo**183011/436350****A13N12**

50

1

1V

14



0°

Ø 59,7

Picture not available
Image non disponible
Imagem no disponibile
Immagine non disponibile
Nicht verfügbares Bild
Brak zdjęćia
Картина недоступна

Picture not available
Image non disponible
Imagem no disponibile
Immagine non disponibile
Nicht verfügbares Bild
Brak zdjęćia
Картина недоступна

PLASTIC CAPSULE 26

590627

REAR BEARING 22

590568

PROTECTION COVER 24

590564

BRUSH HOLDER 09

092859

SEP:SEPARATED REGULATOR -INC:BUILT-IN REGULATOR 02

*2590558

RECTIFIER OR DIODE BRIDGE ASSEMBLY 07

180593

FAN 12

590553

PULLEY 11

593253

ROTOR 04

092985

STATOR 05

100930

Valeo**432759/433417****A13N120**

60

2

5V

14



0°

Ø 58,18

INC

**PLASTIC CAPSULE** 26

590627

REAR BEARING 22

590619

PROTECTION COVER 24

590564

SEP:SEPARATED REGULATOR -INC:BUILT-IN REGULATOR 02

*2590558

FAN 12

592673

PULLEY 11

592757

ROTOR 04

092968

A13N120

60

2

5V

14



0°

Ø 58,18

INC

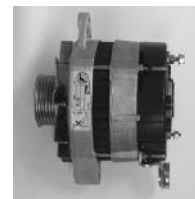
**PLASTIC CAPSULE** 26

590627

REAR BEARING 22

590619

PROTECTION COVER 24

590564

SEP:SEPARATED REGULATOR -INC:BUILT-IN REGULATOR 02

*2590558

FAN 12

592673

PULLEY 11

592757

ROTOR 04

092968

Valeo**433042/433449**

A13N121

60 1 1V

14 ↻ 20° ∇ ∅ 59,7

Picture not available
Image non disponible
Imagen no disponible
Immagine non disponibile
Nicht verfügbares Bild
Brak zdjęcia
Картина недоступна

Picture not available
Image non disponible
Imagen no disponible
Immagine non disponibile
Nicht verfügbares Bild
Brak zdjęcia
Картина недоступна

SEP:SEPARATED REGULATOR -INC:BUILT-IN REGULATOR 📏02

*2590558

Valeo**432726****A13N123**

50 2 1V

14 ↻ 42° ∇ ∅ 60 INC

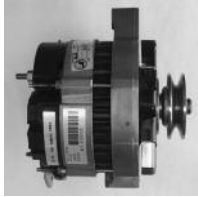
**PLASTIC CAPSULE** 📏26

590627

REAR BEARING 📏22

590568

PROTECTION COVER 📏24

590564

BRUSH SET 📏09a

300821

SEP:SEPARATED REGULATOR -INC:BUILT-IN REGULATOR 📏02182120**FAN** 📏12

592673

PULLEY 📏11

097140

ROTOR 📏04

300846

STATOR 📏05

100930

Valeo**433040/433454****A13N124**

60 2 6V

14 ↻ 0° ∇ ∅ 58,18 INC

**SEP:SEPARATED REGULATOR -INC:BUILT-IN REGULATOR** 📏02

*2590558

Valeo**433066/436455****A13N125+**

70 2 6V

14 ↻ 60° ∇ ∅ 58,18

Picture not available
Image non disponible
Imagen no disponible
Immagine non disponibile
Nicht verfügbares Bild
Brak zdjęcia
Картина недоступна

Picture not available
Image non disponible
Imagen no disponible
Immagine non disponibile
Nicht verfügbares Bild
Brak zdjęcia
Картина недоступна

PLASTIC CAPSULE 📏26

590627

REAR BEARING 📏22

590568

PROTECTION COVER 📏24

590564

SEP:SEPARATED REGULATOR -INC:BUILT-IN REGULATOR 📏02590704**RECTIFIER OR DIODE BRIDGE ASSEMBLY** 📏07

105135

FAN 📏12

592673

STATOR 📏05

592830

Valeo**433109****A13N126**

50 2 5V

14 ↻ 0° ∇ ∅ 58,18 INC

**PLASTIC CAPSULE** 📏26

590627

REAR BEARING 📏22

590568

PROTECTION COVER 📏24

590564

SEP:SEPARATED REGULATOR -INC:BUILT-IN REGULATOR 📏02

*2590558

RECTIFIER OR DIODE BRIDGE ASSEMBLY 📏07

105135

FAN 📏12

592673

PULLEY 📏11

592757

ROTOR 📏04

092968

STATOR 📏05

100930

Valeo**433042/433449****A13N127**

50 2 5V

14 ↻ 60° ∇ ∅ 58,18 INC

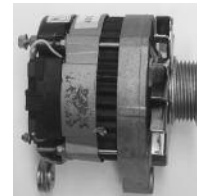
**PLASTIC CAPSULE** 📏26

590627

REAR BEARING 📏22

590613

PROTECTION COVER 📏24

590564

SEP:SEPARATED REGULATOR -INC:BUILT-IN REGULATOR 📏02

*2590558

FAN 📏12

592673

PULLEY 📏11

592757

ROTOR 📏04

092968

STATOR 📏05

100930

Valeo**433087/433488****A13N128+**

50 2 6V

14 ↻ 60° ∇ ∅ 58,18 INC

**PLASTIC CAPSULE** 📏26

590627

PROTECTION COVER 📏24

590564

SEP:SEPARATED REGULATOR -INC:BUILT-IN REGULATOR 📏02

*2590558

FAN 📏12

592673

ROTOR 📏04

092968

STATOR 📏05

100930

Valeo**433088/433489**

A13N129

50

1

1V

14



60°

Ø 66

INC

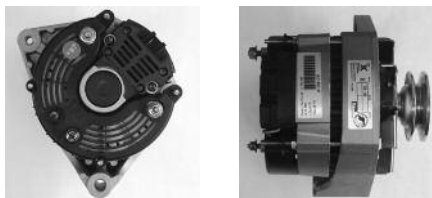

PLASTIC CAPSULE 26 590627
 REAR BEARING 22 590568
 SEP:SEPARATED REGULATOR -INC:BUILT-IN REGULATOR 02 182120
 RECTIFIER OR DIODE BRIDGE ASSEMBLY 07 105754
 FAN 12 592673
 PULLEY 11 097140
 ROTOR 04 300846
 STATOR 05 100930

Valeo**433069/433455****A13N13**

50

2

1V

14



20°

INC



PLASTIC CAPSULE 26 590627
 REAR BEARING 22 590568
 PROTECTION COVER 24 590564
 BRUSH HOLDER 09 092859
 SEP:SEPARATED REGULATOR -INC:BUILT-IN REGULATOR 02 *2590558
 RECTIFIER OR DIODE BRIDGE ASSEMBLY 07 180593
 FAN 12 592673
 FAN 12 590553
 PULLEY 11 593253
 ROTOR 04 092968
 STATOR 05 100930

Valeo**432728/436313****A13N130+**

70

1

1V

14



60°

Ø 60

INC

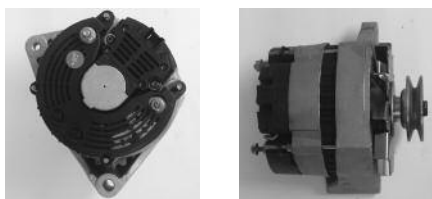

PLASTIC CAPSULE 26 590627
 SEP:SEPARATED REGULATOR -INC:BUILT-IN REGULATOR 02 590538
 FAN 12 592673
 PULLEY 11 097140
 STATOR 05 592830

Valeo**433070/436314****A13N133+**

70

2

6V

14



0°

Ø 58,2

INC



PLASTIC CAPSULE 26 590627
 FRONT BEARING 21 593224
 REAR BEARING 22 590619
 PROTECTION COVER 24 590564
 SEP:SEPARATED REGULATOR -INC:BUILT-IN REGULATOR 02 590538
 RECTIFIER OR DIODE BRIDGE ASSEMBLY 07 593180
 FAN 12 592673
 STATOR 05 592830

A13N133+

70

2

6V

14



0°

Ø 58,2

INC



PLASTIC CAPSULE 26 590627
 FRONT BEARING 21 593224
 REAR BEARING 22 590619
 PROTECTION COVER 24 590564
 SEP:SEPARATED REGULATOR -INC:BUILT-IN REGULATOR 02 590538
 RECTIFIER OR DIODE BRIDGE ASSEMBLY 07 593180
 FAN 12 592673
 STATOR 05 592830

Valeo**433079/436310****A13N136**

60

2

5V

14



0°

Ø 71,16

INC



SEP:SEPARATED REGULATOR -INC:BUILT-IN REGULATOR 02 *2590558

Valeo**433086/433465****A13N137**

50

2

5V

14



60°

Ø 71,16

INC

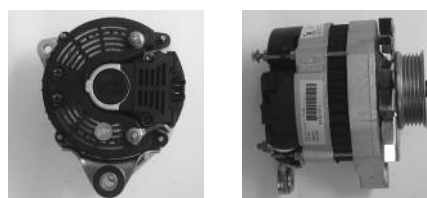

PLASTIC CAPSULE 26 590627
 REAR BEARING 22 590568
 PROTECTION COVER 24 590564
 BRUSH HOLDER 09 092859
 SEP:SEPARATED REGULATOR -INC:BUILT-IN REGULATOR 02

*2590558
RECTIFIER OR DIODE BRIDGE ASSEMBLY 07 180593
FAN 12 590553
ROTOR 04 092968
STATOR 05 100930
Valeo **433065/433441**

A13N138+ 70 2
 14 0°

Picture not available
 Image non disponible
 Imagen no disponible
 Immagine non disponibile
 Nicht verfügbares Bild
 Brak zdjęcia
 Картина недоступна

Picture not available
 Image non disponible
 Imagen no disponible
 Immagine non disponibile
 Nicht verfügbares Bild
 Brak zdjęcia
 Картина недоступна

PLASTIC CAPSULE 26 590627
REAR BEARING 22 590619
PROTECTION COVER 24 590564
SEP:SEPARATED REGULATOR -INC:BUILT-IN REGULATOR 02 590538
RECTIFIER OR DIODE BRIDGE ASSEMBLY 07 593180
FAN 12 592673
STATOR 05 592830
Valeo **433080**

A13N139 50 2 5V
 14 0° \emptyset 59,7

Picture not available
 Image non disponible
 Imagen no disponible
 Immagine non disponibile
 Nicht verfügbares Bild
 Brak zdjęcia
 Картина недоступна

Picture not available
 Image non disponible
 Imagen no disponible
 Immagine non disponibile
 Nicht verfügbares Bild
 Brak zdjęcia
 Картина недоступна

PLASTIC CAPSULE 26 590627
PROTECTION COVER 24 590564
SEP:SEPARATED REGULATOR -INC:BUILT-IN REGULATOR 02
 *2590558
RECTIFIER OR DIODE BRIDGE ASSEMBLY 07 180593
FAN 12 592673
ROTOR 04 092968
STATOR 05 100930
Valeo **433086**

A13N14 50 2 1V
 14 20° \emptyset 69,6

Picture not available
 Image non disponible
 Imagen no disponible
 Immagine non disponibile
 Nicht verfügbares Bild
 Brak zdjęcia
 Картина недоступна

Picture not available
 Image non disponible
 Imagen no disponible
 Immagine non disponibile
 Nicht verfügbares Bild
 Brak zdjęcia
 Картина недоступна

SEP:SEPARATED REGULATOR -INC:BUILT-IN REGULATOR 02
 *2590558
RECTIFIER OR DIODE BRIDGE ASSEMBLY 07 180593
Valeo **432729/433438**

A13N140T 40 2 1V
 28 20° \emptyset 74

Picture not available
 Image non disponible
 Imagen no disponible
 Immagine non disponibile
 Nicht verfügbares Bild
 Brak zdjęcia
 Картина недоступна

Picture not available
 Image non disponible
 Imagen no disponible
 Immagine non disponibile
 Nicht verfügbares Bild
 Brak zdjęcia
 Картина недоступна

PROTECTION COVER 24 590564
BRUSH HOLDER 09 300665
SEP:SEPARATED REGULATOR -INC:BUILT-IN REGULATOR 02 590640
RECTIFIER OR DIODE BRIDGE ASSEMBLY 07 102556
FAN 12 592673
STATOR 05 101339
Valeo **2181757/436352**

A13N143M 30 1 SP
 28 20°

Picture not available
 Image non disponible
 Imagen no disponible
 Immagine non disponibile
 Nicht verfügbares Bild
 Brak zdjęcia
 Картина недоступна

Picture not available
 Image non disponible
 Imagen no disponible
 Immagine non disponibile
 Nicht verfügbares Bild
 Brak zdjęcia
 Картина недоступна

PLASTIC CAPSULE 26 590629
FRONT BEARING 21 593224
REAR BEARING 22 590613
PROTECTION COVER 24 590564
BRUSH HOLDER 09 092967
SEP:SEPARATED REGULATOR -INC:BUILT-IN REGULATOR 02 182169
RECTIFIER OR DIODE BRIDGE ASSEMBLY 07 593199
Valeo **592777**

A13N144 50 2 1V
 14 20° \emptyset 59,7

Picture not available
 Image non disponible
 Imagen no disponible
 Immagine non disponibile
 Nicht verfügbares Bild
 Brak zdjęcia
 Картина недоступна

Picture not available
 Image non disponible
 Imagen no disponible
 Immagine non disponibile
 Nicht verfügbares Bild
 Brak zdjęcia
 Картина недоступна

PLASTIC CAPSULE 26 590627
REAR BEARING 22 590619
PROTECTION COVER 24 590564
SEP:SEPARATED REGULATOR -INC:BUILT-IN REGULATOR 02 182120
RECTIFIER OR DIODE BRIDGE ASSEMBLY 07 105754
PULLEY 11 593253
STATOR 05 100930
Valeo **432725**

A13N146T

50

2

14



20°

Picture not available
Image non disponible
Imagen no disponible
Immagine non disponibile
Nicht verfügbares Bild
Brak zdjęćia
Картина недоступна

Picture not available
Image non disponible
Imagen no disponible
Immagine non disponibile
Nicht verfügbares Bild
Brak zdjęćia
Картина недоступна

PLASTIC CAPSULE 26 590627
PROTECTION COVER 24 590564
REAR BRACKET 25 593227
RECTIFIER OR DIODE BRIDGE ASSEMBLY 07 105135
FAN 12 592673
ROTOR 04 590639
STATOR 05 100930
Valeo 2518049

A13N147M

50

1

14



20°

Picture not available
Image non disponible
Imagen no disponible
Immagine non disponibile
Nicht verfügbares Bild
Brak zdjęćia
Картина недоступна

Picture not available
Image non disponible
Imagen no disponible
Immagine non disponibile
Nicht verfügbares Bild
Brak zdjęćia
Картина недоступна

PLASTIC CAPSULE 26 590629
FRONT BEARING 21 593224
REAR BEARING 22 590613
PROTECTION COVER 24 590564
BRUSH HOLDER 09 092967
SEP:SEPARATED REGULATOR -INC:BUILT-IN REGULATOR 02 590512
RECTIFIER OR DIODE BRIDGE ASSEMBLY 07 593199
FAN 12 592673
FAN 12 590553
Valeo 518039

A13N148M

50

1

14



20°

Picture not available
Image non disponible
Imagen no disponible
Immagine non disponibile
Nicht verfügbares Bild
Brak zdjęćia
Картина недоступна

Picture not available
Image non disponible
Imagen no disponible
Immagine non disponibile
Nicht verfügbares Bild
Brak zdjęćia
Картина недоступна

PLASTIC CAPSULE 26 590629
FRONT BEARING 21 593224
REAR BEARING 22 590613
PROTECTION COVER 24 590564
BRUSH HOLDER 09 092967
SEP:SEPARATED REGULATOR -INC:BUILT-IN REGULATOR 02 590512
RECTIFIER OR DIODE BRIDGE ASSEMBLY 07 593199
FAN 12 592673
FAN 12 590553
Valeo 518040

A13N149M

50

1

14



20°

Picture not available
Image non disponible
Imagen no disponible
Immagine non disponibile
Nicht verfügbares Bild
Brak zdjęćia
Картина недоступна

Picture not available
Image non disponible
Imagen no disponible
Immagine non disponibile
Nicht verfügbares Bild
Brak zdjęćia
Картина недоступна

PLASTIC CAPSULE 26 590629
FRONT BEARING 21 593224
REAR BEARING 22 590613
PROTECTION COVER 24 590564
BRUSH HOLDER 09 092967
SEP:SEPARATED REGULATOR -INC:BUILT-IN REGULATOR 02 590512
RECTIFIER OR DIODE BRIDGE ASSEMBLY 07 593199
FAN 12 592673
Valeo 590049

A13N15

50

2

1V

14



60°

Ø 59,7

INC



SEP:SEPARATED REGULATOR -INC:BUILT-IN REGULATOR 02 *2590558
Valeo 432733/433430

A13N150

60

1

1V

14



60°

Ø 59,7

INC

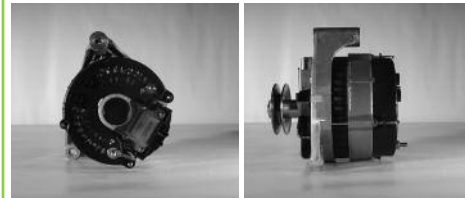

PLASTIC CAPSULE 26 590627
REAR BEARING 22 590568
PROTECTION COVER 24 590564
SEP:SEPARATED REGULATOR -INC:BUILT-IN REGULATOR 02 *2590558
RECTIFIER OR DIODE BRIDGE ASSEMBLY 07 180593
FAN 12 592673
PULLEY 11 593253
Valeo 433081/433440

2518071

45

2

14



Picture not available
Image non disponible
Imagen no disponible
Immagine non disponibile
Nicht verfügbares Bild
Brak zdjęćia
Картина недоступна

Picture not available
Image non disponible
Imagen no disponible
Immagine non disponibile
Nicht verfügbares Bild
Brak zdjęćia
Картина недоступна

SEP:SEPARATED REGULATOR -INC:BUILT-IN REGULATOR 02 505031
RECTIFIER OR DIODE BRIDGE ASSEMBLY 07 494476
FAN 12 *507067
PULLEY 11 523335
REAR BEARING 22 592857
ROTOR 04 512031
Valeo 433090

2518073 80 1

14 ↻

Picture not available
Image non disponible
Imagen no disponible
Immagine non disponibile
Nicht verfügbares Bild
Brak zdjęcia
Картина недоступна

Picture not available
Image non disponible
Imagen no disponible
Immagine non disponibile
Nicht verfügbares Bild
Brak zdjęcia
Картина недоступна

BRUSH HOLDER 09 494487
RECTIFIER OR DIODE BRIDGE ASSEMBLY 07 592554
FAN 12 592088
REAR BEARING 22 592857
Valeo **592685**

2541128 35 1

14 ↻

Picture not available
Image non disponible
Imagen no disponible
Immagine non disponibile
Nicht verfügbares Bild
Brak zdjęcia
Картина недоступна

Picture not available
Image non disponible
Imagen no disponible
Immagine non disponibile
Nicht verfügbares Bild
Brak zdjęcia
Картина недоступна

BRUSH HOLDER 09 494487
RECTIFIER OR DIODE BRIDGE ASSEMBLY 07 592554
FAN 12 507001
REAR BEARING 22 592857
ROTOR 04 512009
STATOR 05 592625
Valeo **592683**

2518074 80 1

14 ↻

Picture not available
Image non disponible
Imagen no disponible
Immagine non disponibile
Nicht verfügbares Bild
Brak zdjęcia
Картина недоступна

Picture not available
Image non disponible
Imagen no disponible
Immagine non disponibile
Nicht verfügbares Bild
Brak zdjęcia
Картина недоступна

BRUSH HOLDER 09 494487
RECTIFIER OR DIODE BRIDGE ASSEMBLY 07 592554
FAN 12 592088
REAR BEARING 22 592857
Valeo **592686**

2541129 80 1

14 ↻

Picture not available
Image non disponible
Imagen no disponible
Immagine non disponibile
Nicht verfügbares Bild
Brak zdjęcia
Картина недоступна

Picture not available
Image non disponible
Imagen no disponible
Immagine non disponibile
Nicht verfügbares Bild
Brak zdjęcia
Картина недоступна

BRUSH HOLDER 09 494487
RECTIFIER OR DIODE BRIDGE ASSEMBLY 07 592554
FAN 12 592088
REAR BEARING 22 592857
Valeo **592687**

2518098 45 2 1V

14 ↻ Ø 61

Picture not available
Image non disponible
Imagen no disponible
Immagine non disponibile
Nicht verfügbares Bild
Brak zdjęcia
Картина недоступна

Picture not available
Image non disponible
Imagen no disponible
Immagine non disponibile
Nicht verfügbares Bild
Brak zdjęcia
Картина недоступна

BRUSH HOLDER 09 494489
SEP:SEPARATED REGULATOR -INC:BUILT-IN REGULATOR 02 505031
RECTIFIER OR DIODE BRIDGE ASSEMBLY 07 494476
REAR BEARING 22 592857
ROTOR 04 512031
Valeo **592688**

2541130 70 1 2V

14 ↻ Ø 81

Picture not available
Image non disponible
Imagen no disponible
Immagine non disponibile
Nicht verfügbares Bild
Brak zdjęcia
Картина недоступна

Picture not available
Image non disponible
Imagen no disponible
Immagine non disponibile
Nicht verfügbares Bild
Brak zdjęcia
Картина недоступна

BRUSH HOLDER 09 503019
SEP:SEPARATED REGULATOR -INC:BUILT-IN REGULATOR 02 494495
FAN 12 592088
FRONT HOUSING 31 592606
PULLEY 11 593380
REAR BEARING 22 592857
ROTOR 04 512005
STATOR 05 592625
Valeo **541130**

2518099 70 2

14 ↻

Picture not available
Image non disponible
Imagen no disponible
Immagine non disponibile
Nicht verfügbares Bild
Brak zdjęcia
Картина недоступна

Picture not available
Image non disponible
Imagen no disponible
Immagine non disponibile
Nicht verfügbares Bild
Brak zdjęcia
Картина недоступна

BRUSH HOLDER 09 503012
BRUSH HOLDER 09 503025
SEP:SEPARATED REGULATOR -INC:BUILT-IN REGULATOR 02 505037
RECTIFIER OR DIODE BRIDGE ASSEMBLY 07 501096
FAN 12 592088
PULLEY 11 507060
REAR BEARING 22 592857
ROTOR 04 512005
STATOR 05 592625
Valeo **592689**

2541131 70 1 2V

14 ↻ Ø 81,75

Picture not available
Image non disponible
Imagen no disponible
Immagine non disponibile
Nicht verfügbares Bild
Brak zdjęcia
Картина недоступна

Picture not available
Image non disponible
Imagen no disponible
Immagine non disponibile
Nicht verfügbares Bild
Brak zdjęcia
Картина недоступна

BRUSH HOLDER 09 503019
SEP:SEPARATED REGULATOR -INC:BUILT-IN REGULATOR 02 494495
FAN 12 592088
FRONT HOUSING 31 592606
REAR BEARING 22 592857
ROTOR 04 512005
STATOR 05 592625
Valeo **541131**

2541139

80

1

1V

14



30°

Ø 65

INC

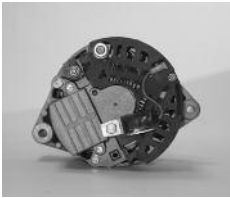
**B+(M8)D+(M6)****PROTECTION COVER** 24

590623

BRUSH HOLDER 09

494487

RECTIFIER OR DIODE BRIDGE ASSEMBLY 07

592651

FAN 12

592088

PULLEY 11

592659

REAR BEARING 22

592857

Valeo**433135/436479****2541148**

70

1

2V

14



Ø 98,8

Picture not available
Image non disponible
Imagen no disponible
Immagine non disponibile
Nicht verfügbares Bild
Brak zdjęćia
Картина недоступна

Picture not available
Image non disponible
Imagen no disponible
Immagine non disponibile
Nicht verfügbares Bild
Brak zdjęćia
Картина недоступна

BRUSH HOLDER 09

503019

SEP:SEPARATED REGULATOR -INC:BUILT-IN REGULATOR 02

494495

FAN 12

592088

REAR BEARING 22

592857

ROTOR 04

512005

STATOR 05

592625

Valeo**592692****2541154**

80

1

1V

14



30°

Ø 65

INC

**B+(M6)D+(M5)****BRUSH HOLDER** 09

494487

RECTIFIER OR DIODE BRIDGE ASSEMBLY 07

592651

FAN 12

592088

PULLEY 11

592659

REAR BEARING 22

592857

Valeo**433135/436480****2541163**

45

2

1V

14



Ø 70

Picture not available
Image non disponible
Imagen no disponible
Immagine non disponibile
Nicht verfügbares Bild
Brak zdjęćia
Картина недоступна

Picture not available
Image non disponible
Imagen no disponible
Immagine non disponibile
Nicht verfügbares Bild
Brak zdjęćia
Картина недоступна

BRUSH HOLDER 09

494489

SEP:SEPARATED REGULATOR -INC:BUILT-IN REGULATOR 02

505032

RECTIFIER OR DIODE BRIDGE ASSEMBLY 07

494476

FAN 12

*507067

PULLEY 11

102229

REAR BEARING 22

592857

ROTOR 04

512031

Valeo**592693****2541164**

45

2

2V

14



Ø 72

Picture not available
Image non disponible
Imagen no disponible
Immagine non disponibile
Nicht verfügbares Bild
Brak zdjęćia
Картина недоступна

Picture not available
Image non disponible
Imagen no disponible
Immagine non disponibile
Nicht verfügbares Bild
Brak zdjęćia
Картина недоступна

BRUSH HOLDER 09

494489

SEP:SEPARATED REGULATOR -INC:BUILT-IN REGULATOR 02

505032

RECTIFIER OR DIODE BRIDGE ASSEMBLY 07

494476

FAN 12

*507067

PULLEY 11

592661

REAR BEARING 22

592857

ROTOR 04

512031

Valeo**592694****2541194**

35

2

1V

14



30°

Ø 82,5

Picture not available
Image non disponible
Imagen no disponible
Immagine non disponibile
Nicht verfügbares Bild
Brak zdjęćia
Картина недоступна

Picture not available
Image non disponible
Imagen no disponible
Immagine non disponibile
Nicht verfügbares Bild
Brak zdjęćia
Картина недоступна

BRUSH HOLDER 09

494489

SEP:SEPARATED REGULATOR -INC:BUILT-IN REGULATOR 02

505031

RECTIFIER OR DIODE BRIDGE ASSEMBLY 07

494476

REAR BEARING 22

592857

Valeo**592695****2541195**

35

1

1V

14



42°

Ø 66,5

Picture not available
Image non disponible
Imagen no disponible
Immagine non disponibile
Nicht verfügbares Bild
Brak zdjęćia
Картина недоступна

Picture not available
Image non disponible
Imagen no disponible
Immagine non disponibile
Nicht verfügbares Bild
Brak zdjęćia
Картина недоступна

BRUSH HOLDER 09

494489

SEP:SEPARATED REGULATOR -INC:BUILT-IN REGULATOR 02

505031

RECTIFIER OR DIODE BRIDGE ASSEMBLY 07

494476

REAR BEARING 22

592857

Valeo**592696/433479****2541198**

65

1

14



Picture not available
Image non disponible
Imagen no disponible
Immagine non disponibile
Nicht verfügbares Bild
Brak zdjęćia
Картина недоступна

Picture not available
Image non disponible
Imagen no disponible
Immagine non disponibile
Nicht verfügbares Bild
Brak zdjęćia
Картина недоступна

BRUSH HOLDER 09

503019

SEP:SEPARATED REGULATOR -INC:BUILT-IN REGULATOR 02

494495

FAN 12

592088

REAR BEARING 22

592857

ROTOR 04

512005

STATOR 05

592625

Valeo**592697**

2541227

55 1

28



Picture not available
Image non disponible
Imagen no disponible
Immagine non disponibile
Nicht verfügbares Bild
Brak zdjęcia
Картина недоступна

Picture not available
Image non disponible
Imagen no disponible
Immagine non disponibile
Nicht verfügbares Bild
Brak zdjęcia
Картина недоступна

BRUSH HOLDER 09 494488
SEP:SEPARATED REGULATOR -INC:BUILT-IN REGULATOR 02505021
RECTIFIER OR DIODE BRIDGE ASSEMBLY 07 592554
FAN 12 592088
PROTECTION COVER 24 514005

Valeo**592797****2541263**

45 1

14



6°

SEP



BRUSH HOLDER 09 494489
SEP:SEPARATED REGULATOR -INC:BUILT-IN REGULATOR 02505031
RECTIFIER OR DIODE BRIDGE ASSEMBLY 07 494476
FAN 12 *507067
REAR BEARING 22 592857
ROTOR 04 512031

Valeo**432700/436100****2541264**

55 1

14



6°

INC



PULLEY 11 523335
REAR BEARING 22 592857
ROTOR 04 512005

Valeo**432705/436146****2541290**

70 2 2V

14



60°

Ø 81

Picture not available
Image non disponible
Imagen no disponible
Immagine non disponibile
Nicht verfügbares Bild
Brak zdjęcia
Картина недоступна

Picture not available
Image non disponible
Imagen no disponible
Immagine non disponibile
Nicht verfügbares Bild
Brak zdjęcia
Картина недоступна

BRUSH HOLDER 09 503019
SEP:SEPARATED REGULATOR -INC:BUILT-IN REGULATOR 02494495
FAN 12 592088
ROTOR 04 512005
STATOR 05 592625

Valeo**439197/436273****2541300**

80 1 1V

14



30°

Ø 65

INC

**B+(M8)D+(M6)**

REAR BEARING 22 590619
REAR BEARING 22 590619
PROTECTION COVER 24 590623
PROTECTION COVER 24 590623
BRUSH HOLDER 09 503001
BRUSH HOLDER 09 503001
RECTIFIER OR DIODE BRIDGE ASSEMBLY 07 592651
RECTIFIER OR DIODE BRIDGE ASSEMBLY 07 592651
FAN 12 592088
FAN 12 592088
PULLEY 11 592659
PULLEY 11 592659

2541300

80 1 1V

14



30°

Ø 65

INC

**B+(M8)D+(M6)**

REAR BEARING 22 590619
REAR BEARING 22 590619
PROTECTION COVER 24 590623
PROTECTION COVER 24 590623
BRUSH HOLDER 09 503001
BRUSH HOLDER 09 503001
RECTIFIER OR DIODE BRIDGE ASSEMBLY 07 592651
RECTIFIER OR DIODE BRIDGE ASSEMBLY 07 592651
FAN 12 592088
FAN 12 592088
PULLEY 11 592659
PULLEY 11 592659

Valeo**433135/436480****2541400**

70 2 2V

14



Ø 90,58

Picture not available
Image non disponible
Imagen no disponible
Immagine non disponibile
Nicht verfügbares Bild
Brak zdjęcia
Картина недоступна

Picture not available
Image non disponible
Imagen no disponible
Immagine non disponibile
Nicht verfügbares Bild
Brak zdjęcia
Картина недоступна

BRUSH HOLDER 09 503019
SEP:SEPARATED REGULATOR -INC:BUILT-IN REGULATOR 02494495
FAN 12 592088
ROTOR 04 512005
STATOR 05 592625

2541423

55

2

28



0°

Picture not available
Image non disponible
Imagen no disponible
Immagine non disponibile
Nicht verfügbares Bild
Brak zdjęcia
Картина недоступна

Picture not available
Image non disponible
Imagen no disponible
Immagine non disponibile
Nicht verfügbares Bild
Brak zdjęcia
Картина недоступна

FRONT BEARING 21 593224
REAR BEARING 22 590619
BRUSH HOLDER 09 503024
SEP:SEPARATED REGULATOR -INC:BUILT-IN REGULATOR 02 505107
RECTIFIER OR DIODE BRIDGE ASSEMBLY 07 501096
FAN 12 592673
Valeo 2541423/436416

2541452

35

2

1V

14



Ø 77,3

Picture not available
Image non disponible
Imagen no disponible
Immagine non disponibile
Nicht verfügbares Bild
Brak zdjęcia
Картина недоступна

Picture not available
Image non disponible
Imagen no disponible
Immagine non disponibile
Nicht verfügbares Bild
Brak zdjęcia
Картина недоступна

BRUSH HOLDER 09 494489
SEP:SEPARATED REGULATOR -INC:BUILT-IN REGULATOR 02 505032
RECTIFIER OR DIODE BRIDGE ASSEMBLY 07 494476
REAR BEARING 22 592857
ROTOR 04 512031
Valeo 592798

2940060

55

1

1V

28



Ø 66

Picture not available
Image non disponible
Imagen no disponible
Immagine non disponibile
Nicht verfügbares Bild
Brak zdjęcia
Картина недоступна

Picture not available
Image non disponible
Imagen no disponible
Immagine non disponibile
Nicht verfügbares Bild
Brak zdjęcia
Картина недоступна

BRUSH HOLDER 09 503019
FAN 12 592088
PULLEY 11 096879
REAR BEARING 22 592857
Valeo 522104

2940119

65

1

2V

14



Ø 70

Picture not available
Image non disponible
Imagen no disponible
Immagine non disponibile
Nicht verfügbares Bild
Brak zdjęcia
Картина недоступна

Picture not available
Image non disponible
Imagen no disponible
Immagine non disponibile
Nicht verfügbares Bild
Brak zdjęcia
Картина недоступна

BRUSH HOLDER 09 503019
SEP:SEPARATED REGULATOR -INC:BUILT-IN REGULATOR 02 494495
FAN 12 592088
REAR BEARING 22 592857
ROTOR 04 512005
STATOR 05 592625
Valeo 432980/433473

2940130

80

1

1V

14



Ø 61

INC

Picture not available
Image non disponible
Imagen no disponible
Immagine non disponibile
Nicht verfügbares Bild
Brak zdjęcia
Картина недоступна

Picture not available
Image non disponible
Imagen no disponible
Immagine non disponibile
Nicht verfügbares Bild
Brak zdjęcia
Картина недоступна

B+(M8)D+(M8)

REAR BEARING 22 590619
PROTECTION COVER 24 590623
BRUSH HOLDER 09 503001
RECTIFIER OR DIODE BRIDGE ASSEMBLY 07 592651
FAN 12 592088
Valeo 432816/436321

2940146

50

1

1V

14



Ø 70

Picture not available
Image non disponible
Imagen no disponible
Immagine non disponibile
Nicht verfügbares Bild
Brak zdjęcia
Картина недоступна

Picture not available
Image non disponible
Imagen no disponible
Immagine non disponibile
Nicht verfügbares Bild
Brak zdjęcia
Картина недоступна

BRUSH HOLDER 09 503019
SEP:SEPARATED REGULATOR -INC:BUILT-IN REGULATOR 02 494495
REAR BEARING 22 592857
ROTOR 04 512039
STATOR 05 592625
Valeo 2522161/433481

2940148

65

1

2V

14



Ø 77,3

Picture not available
Image non disponible
Imagen no disponible
Immagine non disponibile
Nicht verfügbares Bild
Brak zdjęcia
Картина недоступна

Picture not available
Image non disponible
Imagen no disponible
Immagine non disponibile
Nicht verfügbares Bild
Brak zdjęcia
Картина недоступна

BRUSH HOLDER 09 503019
SEP:SEPARATED REGULATOR -INC:BUILT-IN REGULATOR 02 494495
FAN 12 592088
REAR BEARING 22 592857
ROTOR 04 512005
STATOR 05 592625
Valeo 432981/433475

2940173

45

2

1V

14



Ø 52

Picture not available
Image non disponible
Imagen no disponible
Immagine non disponibile
Nicht verfügbares Bild
Brak zdjęcia
Картина недоступна

Picture not available
Image non disponible
Imagen no disponible
Immagine non disponibile
Nicht verfügbares Bild
Brak zdjęcia
Картина недоступна

REAR BEARING 22 590619
BRUSH HOLDER 09 494489
SEP:SEPARATED REGULATOR -INC:BUILT-IN REGULATOR 02 505032
RECTIFIER OR DIODE BRIDGE ASSEMBLY 07 494476
FAN 12 *507067
ROTOR 04 512031
Valeo 2522159

2940208

75 1 1V

14 ↻ ∅ 71

Picture not available
Image non disponible
Imagen no disponible
Immagine non disponibile
Nicht verfügbares Bild
Brak zdjęcia
Картина недоступна

Picture not available
Image non disponible
Imagen no disponible
Immagine non disponibile
Nicht verfügbares Bild
Brak zdjęcia
Картина недоступна

REAR BEARING 📏22 590619
BRUSH HOLDER 📏09 503012
SEP:SEPARATED REGULATOR -INC:BUILT-IN REGULATOR 📏02505037
RECTIFIER OR DIODE BRIDGE ASSEMBLY 📏07 501101
FAN 📏12 592088
ROTOR 📏04 512005
STATOR 📏05 592625
Valeo 422758

2940275

70 2 1V

14 ↻ 55° ∅ 66 INC



REAR BEARING 📏22 590619
SEP:SEPARATED REGULATOR -INC:BUILT-IN REGULATOR 📏02
*2523345
CONDENSOR 📏14 517022
PULLEY 📏11 096879
REAR BRACKET 📏25 592680
ROTOR 📏04 *2523191
STATOR 📏05 592625
Valeo 433037/433368

2940349

65 1 1V

14 ↻ ∅ 65,5 INC

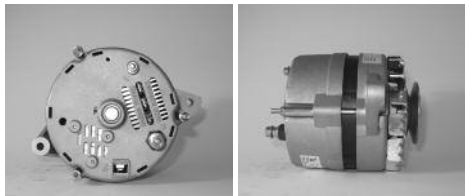

REAR BEARING 📏22 590619
BRUSH HOLDER 📏09 503001
SEP:SEPARATED REGULATOR -INC:BUILT-IN REGULATOR 📏02494495
RECTIFIER OR DIODE BRIDGE ASSEMBLY 📏07 592650
FAN 📏12 592088
ROTOR 📏04 512005
STATOR 📏05 592625
Valeo 433056/436148

2940351

65 1 1V

14 ↻ ∅ 59,7 INC

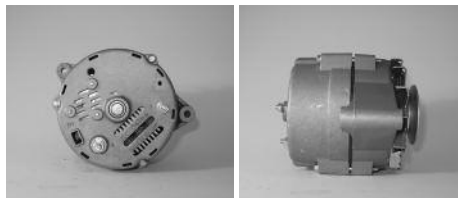
**B+(M6)D+(M5)**

RECTIFIER OR DIODE BRIDGE ASSEMBLY 📏07 592554
PULLEY 📏11 096880
REAR BEARING 📏22 592857
ROTOR 📏04 512005
STATOR 📏05 592625
Valeo 436159

2940353

45 1 1V

14 ↻ 15° ∅ 59,7 INC



BRUSH HOLDER 📏09 494489
SEP:SEPARATED REGULATOR -INC:BUILT-IN REGULATOR 📏02505031
RECTIFIER OR DIODE BRIDGE ASSEMBLY 📏07 501096
REAR BEARING 📏22 592857
ROTOR 📏04 512031
Valeo 433054/436149

2940356

70 1 1V

14 ↻ ∅ 59,7



Picture not available
Image non disponible
Imagen no disponible
Immagine non disponibile
Nicht verfügbares Bild
Brak zdjęcia
Картина недоступна

Picture not available
Image non disponible
Imagen no disponible
Immagine non disponibile
Nicht verfügbares Bild
Brak zdjęcia
Картина недоступна

REAR BEARING 📏22 590619
SEP:SEPARATED REGULATOR -INC:BUILT-IN REGULATOR 📏02523345
FAN 📏12 592088
Valeo 432804

2940357

90 1 1V

14 ↻ ∅ 64,5 INC

**B+(M6)D+(M6)**

BRUSH HOLDER 📏09 494487
BRUSH HOLDER 📏09 494487
RECTIFIER OR DIODE BRIDGE ASSEMBLY 📏07 592651
RECTIFIER OR DIODE BRIDGE ASSEMBLY 📏07 592651
FAN 📏12 592088
FAN 📏12 592088
REAR BEARING 📏22 592857
REAR BEARING 📏22 592857

2940357

90

1

1V

14



Ø 64,5

INC

**B+(M6)D+(M6)****BRUSH HOLDER** 09

494487

BRUSH HOLDER 09

494487

RECTIFIER OR DIODE BRIDGE ASSEMBLY 07

592651

RECTIFIER OR DIODE BRIDGE ASSEMBLY 07

592651

FAN 12

592088

FAN 12

592088

REAR BEARING 22

592857

REAR BEARING 22

592857

Valeo**433045/436212****2940359**

65

1

1V

14



Ø 60

Picture not available
Image non disponible
Imagen no disponible
Immagine non disponibile
Nicht verfügbares Bild
Brak zdjęcia
Картина недоступна

Picture not available
Image non disponible
Imagen no disponible
Immagine non disponibile
Nicht verfügbares Bild
Brak zdjęcia
Картина недоступна

BRUSH SET 09a

300821

FAN 12

592088

REAR BEARING 22

592857

STATOR 05

592625

Valeo**433051****2940361**

90

1

SP

14



60°

INC

**B+(M8)D+(M6)
W(M5)****REAR BEARING** 22

590619

PROTECTION COVER 24

590623

BRUSH HOLDER 09

503001

RECTIFIER OR DIODE BRIDGE ASSEMBLY 07

592651

FAN 12

592088

2940361

90

1

SP

14



60°

INC

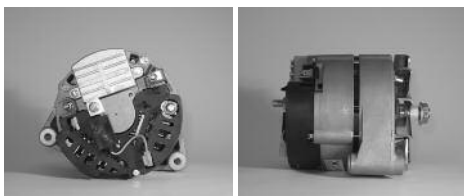
**B+(M8)D+(M6)
W(M5)****REAR BEARING** 22

590619

PROTECTION COVER 24

590623

BRUSH HOLDER 09

503001

RECTIFIER OR DIODE BRIDGE ASSEMBLY 07

592651

FAN 12

592088

2940361

90

1

SP

14



60°

INC

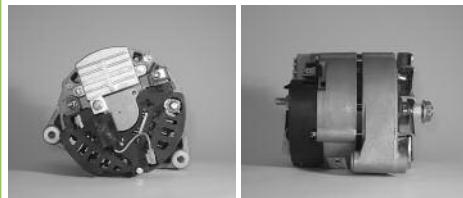
**B+(M8)D+(M6)
W(M5)****REAR BEARING** 22

590619

PROTECTION COVER 24

590623

BRUSH HOLDER 09

503001

RECTIFIER OR DIODE BRIDGE ASSEMBLY 07

592651

FAN 12

592088

Valeo**433057/436290****2940377**

80

1

1V

14



Ø 65

INC

Picture not available
Image non disponible
Imagen no disponible
Immagine non disponibile
Nicht verfügbares Bild
Brak zdjęcia
Картина недоступна

Picture not available
Image non disponible
Imagen no disponible
Immagine non disponibile
Nicht verfügbares Bild
Brak zdjęcia
Картина недоступна

B+(M8)D+(M6)**BRUSH HOLDER** 09

494487

RECTIFIER OR DIODE BRIDGE ASSEMBLY 07

592651

FAN 12

592088

REAR BEARING 22

592857

Valeo**432816/436321****2940413**

40

2

SP

28



Picture not available
Image non disponible
Imagen no disponible
Immagine non disponibile
Nicht verfügbares Bild
Brak zdjęcia
Картина недоступна

Picture not available
Image non disponible
Imagen no disponible
Immagine non disponibile
Nicht verfügbares Bild
Brak zdjęcia
Картина недоступна

REAR BEARING 22

590619

BRUSH HOLDER 09

503019

SEP:SEPARATED REGULATOR -INC:BUILT-IN REGULATOR 02

494498

FAN 12

592088

REAR BEARING 22

592857

Valeo**2523340****2940426**

70

2

1V

14



Ø 59,7

INC

**BRUSH SET** 09a

300821

SEP:SEPARATED REGULATOR -INC:BUILT-IN REGULATOR 02

523190

RECTIFIER OR DIODE BRIDGE ASSEMBLY 07

501118

Valeo**432829/436316**

A13N150

60 1 1V

14 ↻ 60° ∇ ∅ 59,7 INC

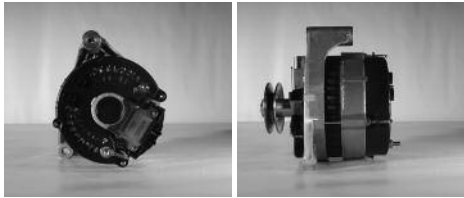
**ROTOR** 📏04

092985

Valeo**433081/433440****A13N151+**

70 2 4V

14 ↻ 20° ∇ ∅ 59,4 INC

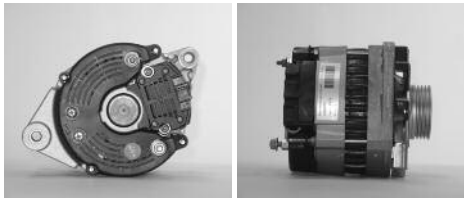
**PLASTIC CAPSULE** 📏26

590627

PROTECTION COVER 📏24

590564

SEP:SEPARATED REGULATOR -INC:BUILT-IN REGULATOR 📏02

590538

RECTIFIER OR DIODE BRIDGE ASSEMBLY 📏07

592749

FAN 📏12

592673

STATOR 📏05

592830

Valeo**433082/433457****A13N152M**

30 1

28 ↻ 20° ∇

Picture not available
Image non disponible
Imagen no disponible
Immagine non disponibile
Nicht verfügbares Bild
Brak zdjęcia
Картина недоступна

Picture not available
Image non disponible
Imagen no disponible
Immagine non disponibile
Nicht verfügbares Bild
Brak zdjęcia
Картина недоступна

PLASTIC CAPSULE 📏26

590629

FRONT BEARING 📏21

593224

REAR BEARING 📏22

590613

PROTECTION COVER 📏24

590564

BRUSH HOLDER 📏09

092967

SEP:SEPARATED REGULATOR -INC:BUILT-IN REGULATOR 📏02

182169

RECTIFIER OR DIODE BRIDGE ASSEMBLY 📏07

593199

FAN 📏12

592673

Valeo**2518064****A13N156+**

70 1 1V

14 ↻ 20° ∇ ∅ 60 INC

**PLASTIC CAPSULE** 📏26

590627

PROTECTION COVER 📏24

590564

SEP:SEPARATED REGULATOR -INC:BUILT-IN REGULATOR 📏02

*2590558

RECTIFIER OR DIODE BRIDGE ASSEMBLY 📏07

180593

FAN 📏12

592673

PULLEY 📏11

097140

STATOR 📏05

592830

Valeo**433139/436681****A13N157**

60 2 1V

14 ↻ 20° ∇ ∅ 60 INC

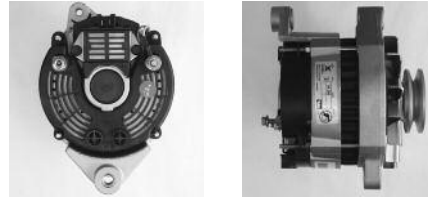
**PLASTIC CAPSULE** 📏26

590627

REAR BEARING 📏22

590568

PROTECTION COVER 📏24

590564

SEP:SEPARATED REGULATOR -INC:BUILT-IN REGULATOR 📏02

*2590558

RECTIFIER OR DIODE BRIDGE ASSEMBLY 📏07

180593

FAN 📏12

592673

PULLEY 📏11

097140

ROTOR 📏04

590639

A13N157

60 2 1V

14 ↻ 20° ∇ ∅ 60 INC

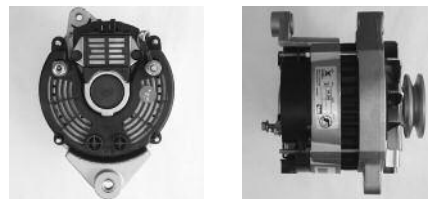
**PLASTIC CAPSULE** 📏26

590627

REAR BEARING 📏22

590568

PROTECTION COVER 📏24

590564

SEP:SEPARATED REGULATOR -INC:BUILT-IN REGULATOR 📏02

*2590558

RECTIFIER OR DIODE BRIDGE ASSEMBLY 📏07

180593

FAN 📏12

592673

PULLEY 📏11

097140

ROTOR 📏04

590639

Valeo**433096/433459****A13N158+**

70 2 1V

14 ↻ 20° ∇ ∅ 60 INC

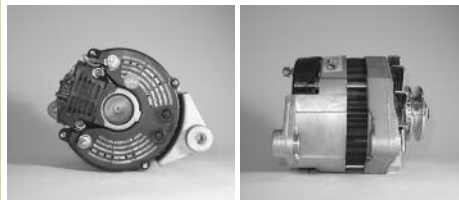
**PLASTIC CAPSULE** 📏26

590627

PROTECTION COVER 📏24

590564

SEP:SEPARATED REGULATOR -INC:BUILT-IN REGULATOR 📏02

*2590558

RECTIFIER OR DIODE BRIDGE ASSEMBLY 📏07

180593

FAN 📏12

592673

PULLEY 📏11

097140

ROTOR 📏04

590625

STATOR 📏05

592830

Valeo**433097/436250**

A13N159+

70

2

5V

14



0°

Ø 58,18

INC

**PLASTIC CAPSULE** 26

590627

REAR BEARING 22

590619

PROTECTION COVER 24

590564

REAR BRACKET 25

593230

SEP:SEPARATED REGULATOR -INC:BUILT-IN REGULATOR 02

*2590558

FAN 12

592673

PULLEY 11

592757

ROTOR 04

590625

STATOR 05

592830

A13N159+

70

2

5V

14



0°

Ø 58,18

INC

**PLASTIC CAPSULE** 26

590627

REAR BEARING 22

590619

PROTECTION COVER 24

590564

REAR BRACKET 25

593230

SEP:SEPARATED REGULATOR -INC:BUILT-IN REGULATOR 02

*2590558

FAN 12

592673

PULLEY 11

592757

ROTOR 04

590625

STATOR 05

592830

Valeo

433098/433463

A13N160

60

2

5V

14



60°

Ø 71,16

INC

**PLASTIC CAPSULE** 26

590627

REAR BEARING 22

590568

PROTECTION COVER 24

590564

SEP:SEPARATED REGULATOR -INC:BUILT-IN REGULATOR 02

*2590558

RECTIFIER OR DIODE BRIDGE ASSEMBLY 07

180593

FAN 12

592673

ROTOR 04

092968

Valeo

433061/433441

A13N161+

70

2

6V

14



0°

Ø 58,18

INC

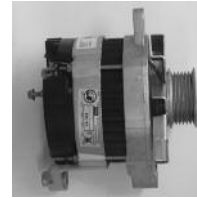
**PLASTIC CAPSULE** 26

590627

PROTECTION COVER 24

590564

SEP:SEPARATED REGULATOR -INC:BUILT-IN REGULATOR 02

*2590558

RECTIFIER OR DIODE BRIDGE ASSEMBLY 07

180593

FAN 12

592673

ROTOR 04

590625

STATOR 05

592830

Valeo

433099/436254

A13N162+

70

2

6V

14



0°

Ø 62,9

INC

**REAR BEARING** 22

590619

PROTECTION COVER 24

590564

REAR BRACKET 25

593230

SEP:SEPARATED REGULATOR -INC:BUILT-IN REGULATOR 02

*2590558

RECTIFIER OR DIODE BRIDGE ASSEMBLY 07

180593

FAN 12

592673

PULLEY 11

105760

ROTOR 04

590625

STATOR 05

592830

Valeo

433110/433461

A13N163

60

2

5V

14



0°

Ø 62,9

INC

**SEP:SEPARATED REGULATOR -INC:BUILT-IN REGULATOR** 02

*2590558

Valeo

433460

A13N164+

70

2

6V

14



0°

Ø 62,9

INC

**PLASTIC CAPSULE** 26

590627

REAR BEARING 22

590568

PROTECTION COVER 24

590564

REAR BRACKET 25

593230

SEP:SEPARATED REGULATOR -INC:BUILT-IN REGULATOR 02

*2590558

RECTIFIER OR DIODE BRIDGE ASSEMBLY  07

FAN  12

PULLEY  11

ROTOR  04

STATOR  05

Valeo

592880

592673

105760

590625

592830

433111/433460

A13N165

60

14



Picture not available
Image non disponible
Imagen no disponible
Immagine non disponibile
Nicht verfügbares Bild
Brak zdjęcía
Картина недоступна

Picture not available
Image non disponible
Imagen no disponible
Immagine non disponibile
Nicht verfügbares Bild
Brak zdjęcía
Картина недоступна

PLASTIC CAPSULE  26

590627

FRONT BEARING  21

593224

REAR BEARING  22

590619

BRUSH HOLDER  09

300665

SEP:SEPARATED REGULATOR -INC:BUILT-IN REGULATOR  02 182007

RECTIFIER OR DIODE BRIDGE ASSEMBLY  07

593199

THROUGH BOLTS  23

518611

Valeo

592769

A13N166M

30

1

28



60°

Picture not available
Image non disponible
Imagen no disponible
Immagine non disponibile
Nicht verfügbares Bild
Brak zdjęcía
Картина недоступна

Picture not available
Image non disponible
Imagen no disponible
Immagine non disponibile
Nicht verfügbares Bild
Brak zdjęcía
Картина недоступна

PLASTIC CAPSULE  26

590629

FRONT BEARING  21

592780

REAR BEARING  22

590613

PROTECTION COVER  24

590607

BRUSH HOLDER  09

092967

SEP:SEPARATED REGULATOR -INC:BUILT-IN REGULATOR  02 590605

RECTIFIER OR DIODE BRIDGE ASSEMBLY  07

592882

Valeo

592770/436427

A13N167

50

2

5V

14



20°

Ø 59,4

INC



PLASTIC CAPSULE  26

590627

PROTECTION COVER  24

590564

SEP:SEPARATED REGULATOR -INC:BUILT-IN REGULATOR  02 182120

RECTIFIER OR DIODE BRIDGE ASSEMBLY  07

592840

FAN  12

592673

PULLEY  11

592760

ROTOR  04

590639

STATOR  05

100930

Valeo

433094/433487

A13N169

60

2

6V

14



0°

Ø 58,18

INC



PLASTIC CAPSULE  26

590627

FRONT BEARING  21

593224

REAR BEARING  22

590619

PROTECTION COVER  24

590564

SEP:SEPARATED REGULATOR -INC:BUILT-IN REGULATOR  02 182120

FAN  12

592673

ROTOR  04

092968

Valeo

433113/436473

A13N17

50

2

1V

14



60°

Ø 63,25

Picture not available
Image non disponible
Imagen no disponible
Immagine non disponibile
Nicht verfügbares Bild
Brak zdjęcía
Картина недоступна

Picture not available
Image non disponible
Imagen no disponible
Immagine non disponibile
Nicht verfügbares Bild
Brak zdjęcía
Картина недоступна

SEP:SEPARATED REGULATOR -INC:BUILT-IN REGULATOR  02

*2590558

Valeo

432734/433435

A13N171+

70

2

1V

14



0°

Ø 63,25

INC



PLASTIC CAPSULE  26

590627

REAR BEARING  22

590568

PROTECTION COVER  24

590564

REAR BRACKET  25

593230

SEP:SEPARATED REGULATOR -INC:BUILT-IN REGULATOR  02

*2590558

RECTIFIER OR DIODE BRIDGE ASSEMBLY  07

592881

FAN  12

592673

PULLEY  11

096882

ROTOR  04

590625

STATOR  05

592830

Valeo

433095/433462

A13N172+

70

2

6V

14



0°

Ø 58,18

INC



PLASTIC CAPSULE  26

590627

REAR BEARING  22

590568

PROTECTION COVER  24

590564

REAR BRACKET  25

593230

SEP:SEPARATED REGULATOR -INC:BUILT-IN REGULATOR  02

*2590558

FAN 12

592673

STATOR 05

592830

Valeo

433120/436455

A13N173+

70

1

1V

14

0°

Ø 59,7

INC



PLASTIC CAPSULE 26

590627

REAR BEARING 22

590568

PROTECTION COVER 24

590564

REAR BRACKET 25

593230

SEP:SEPARATED REGULATOR -INC:BUILT-IN REGULATOR 02

*2590558

FAN 12

592673

PULLEY 11

593253

STATOR 05

592830

Valeo

433121/433467

A13N174

35

2

28

0°

0°

Picture not available
Image non disponible
Imagen no disponible
Immagine non disponibile
Nicht verfügbares Bild
Brak zdjęcia
Картина недоступна

Picture not available
Image non disponible
Imagen no disponible
Immagine non disponibile
Nicht verfügbares Bild
Brak zdjęcia
Картина недоступна

FRONT BEARING 21

593224

REAR BEARING 22

590613

PROTECTION COVER 24

590564

BRUSH HOLDER 09

300665

SEP:SEPARATED REGULATOR -INC:BUILT-IN REGULATOR 02

590640

RECTIFIER OR DIODE BRIDGE ASSEMBLY 07

593196

Valeo

592771

A13N175

50

1

1V

14

60°

Ø 60

INC

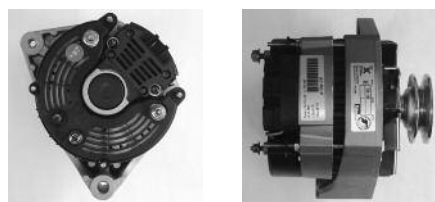

PLASTIC CAPSULE 26

590627

REAR BEARING 22

590568

SEP:SEPARATED REGULATOR -INC:BUILT-IN REGULATOR 02

182120

RECTIFIER OR DIODE BRIDGE ASSEMBLY 07

592877

FAN 12

592673

PULLEY 11

097140

ROTOR 04

300846

STATOR 05

100930

Valeo

433069/433455

A13N176+

70

1

1V

14

60°

Ø 60

INC



PLASTIC CAPSULE 26

590627

REAR BEARING 22

590568

SEP:SEPARATED REGULATOR -INC:BUILT-IN REGULATOR 02

182120

FAN 12

592673

PULLEY 11

097140

Valeo

433070/436314

A13N177+

70

2

4V

14

20°

Ø 59,4

INC

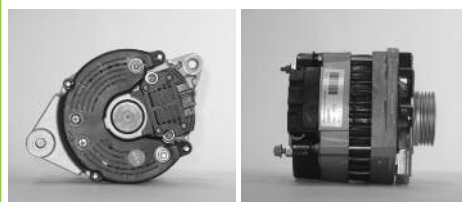

PLASTIC CAPSULE 26

590627

REAR BEARING 22

590568

PROTECTION COVER 24

590564

SEP:SEPARATED REGULATOR -INC:BUILT-IN REGULATOR 02

182120

RECTIFIER OR DIODE BRIDGE ASSEMBLY 07

592749

FAN 12

592673

ROTOR 04

590625

STATOR 05

592830

Valeo

433082/433457

A13N178+

70

2

6V

14

0°

Ø 58,18

Picture not available
Image non disponible
Imagen no disponible
Immagine non disponibile
Nicht verfügbares Bild
Brak zdjęcia
Картина недоступна

Picture not available
Image non disponible
Imagen no disponible
Immagine non disponibile
Nicht verfügbares Bild
Brak zdjęcia
Картина недоступна

PLASTIC CAPSULE 26

590627

FRONT BEARING 21

593224

REAR BEARING 22

590568

PROTECTION COVER 24

590564

SEP:SEPARATED REGULATOR -INC:BUILT-IN REGULATOR 02

182120

RECTIFIER OR DIODE BRIDGE ASSEMBLY 07

593180

FAN 12

592673

STATOR 05

592830

Valeo

433079

A13N179+ 70 2 3V

14 ↻ 0° ∇ Ø 58,18 INC

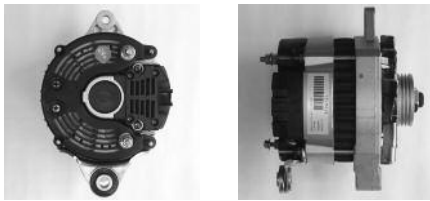

PLASTIC CAPSULE 📏 26 590627
REAR BEARING 📏 22 590619
PROTECTION COVER 📏 24 590564
SEP:SEPARATED REGULATOR -INC:BUILT-IN REGULATOR 📏 02 182120
RECTIFIER OR DIODE BRIDGE ASSEMBLY 📏 07 593180
FAN 📏 12 592673
STATOR 📏 05 592830
Valeo 433080/436472

A13N18 50 1 1V

14 ↻ 70° ∇ Ø 55,4 INC



PLASTIC CAPSULE 📏 26 590627
REAR BEARING 📏 22 590568
PROTECTION COVER 📏 24 590564
BRUSH HOLDER 📏 09 092859
SEP:SEPARATED REGULATOR -INC:BUILT-IN REGULATOR 📏 02 *2590558
RECTIFIER OR DIODE BRIDGE ASSEMBLY 📏 07 105135
ROTOR 📏 04 092985
STATOR 📏 05 100930
Valeo 432735/433414

A13N180+ 70 2 6V

14 ↻ 60° ∇ Ø 61,4

Picture not available
 Image non disponible
 Imagen no disponible
 Immagine non disponibile
 Nicht verfügbares Bild
 Brak zdjęcia
 Картина недоступна

Picture not available
 Image non disponible
 Imagen no disponible
 Immagine non disponibile
 Nicht verfügbares Bild
 Brak zdjęcia
 Картина недоступна

PLASTIC CAPSULE 📏 26 590627
PROTECTION COVER 📏 24 590564
REAR BRACKET 📏 25 593230
SEP:SEPARATED REGULATOR -INC:BUILT-IN REGULATOR 📏 02 *2590558
FAN 📏 12 592673
STATOR 📏 05 592830
Valeo 433109

A13N181 50 2 4V

14 ↻ 20° ∇ Ø 59,4 INC

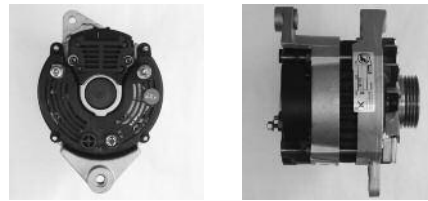

PLASTIC CAPSULE 📏 26 590627
SEP:SEPARATED REGULATOR -INC:BUILT-IN REGULATOR 📏 02 182120
RECTIFIER OR DIODE BRIDGE ASSEMBLY 📏 07 592749
FAN 📏 12 592673
ROTOR 📏 04 590639
STATOR 📏 05 100930
Valeo 432769/433364

A13N182 50 2 5V

14 ↻ 20° ∇ Ø 59,4 INC

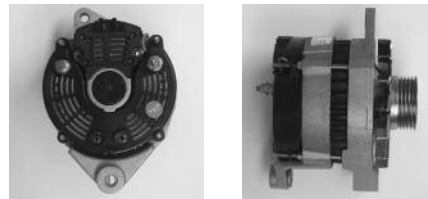

PLASTIC CAPSULE 📏 26 590627
SEP:SEPARATED REGULATOR -INC:BUILT-IN REGULATOR 📏 02 182120
RECTIFIER OR DIODE BRIDGE ASSEMBLY 📏 07 592749
FAN 📏 12 592673
PULLEY 📏 11 592760
ROTOR 📏 04 590639
STATOR 📏 05 100930
Valeo 433094/433487

A13N183+ 70 2 4V

14 ↻ 20° ∇ Ø 59,4 INC



PLASTIC CAPSULE 📏 26 590627
REAR BEARING 📏 22 590568
SEP:SEPARATED REGULATOR -INC:BUILT-IN REGULATOR 📏 02 182120
RECTIFIER OR DIODE BRIDGE ASSEMBLY 📏 07 592749
FAN 📏 12 592673
ROTOR 📏 04 590625
Valeo 433082/433457

A13N184+

70

2

5V

14



20°

Ø 59,4

INC

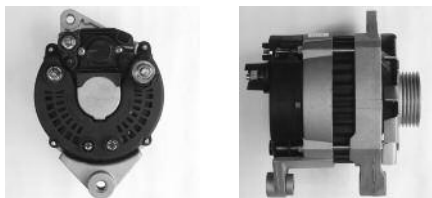
**PLASTIC CAPSULE** 26

590627

SEP:SEPARATED REGULATOR -INC:BUILT-IN REGULATOR 02 590688**RECTIFIER OR DIODE BRIDGE ASSEMBLY** 07 592878**FAN** 12 592673**PULLEY** 11 181485**ROTOR** 04 590625**STATOR** 05 592830**Valeo**

433122/433468

A13N185+

70

2

1V

14



42°

Ø 63,25

INC

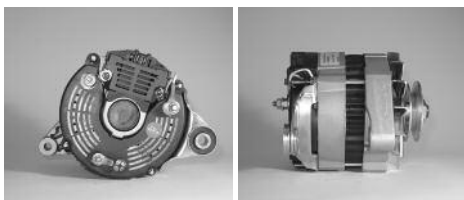
**PLASTIC CAPSULE** 26

590627

REAR BEARING 22 590568**PROTECTION COVER** 24 590564**SEP:SEPARATED REGULATOR -INC:BUILT-IN REGULATOR** 02

*2590558

RECTIFIER OR DIODE BRIDGE ASSEMBLY 07 592880**FAN** 12 592673**PULLEY** 11 096882**STATOR** 05 592830**Valeo**

432718/436602

A13N186M

50

2

14



20°

Picture not available
Image non disponible
Imagen no disponible
Immagine non disponibile
Nicht verfügbares Bild
Brak zdjęćia
Картина недоступна

Picture not available
Image non disponible
Imagen no disponible
Immagine non disponibile
Nicht verfügbares Bild
Brak zdjęćia
Картина недоступна

FRONT BEARING 21 593224**REAR BEARING** 22 590613**PROTECTION COVER** 24 590564**BRUSH HOLDER** 09 092967**SEP:SEPARATED REGULATOR -INC:BUILT-IN REGULATOR** 02 590512**RECTIFIER OR DIODE BRIDGE ASSEMBLY** 07 593199**FAN** 12 592673**Valeo**

592772

A13N187

60

2

14



20°

Picture not available
Image non disponible
Imagen no disponible
Immagine non disponibile
Nicht verfügbares Bild
Brak zdjęćia
Картина недоступна

Picture not available
Image non disponible
Imagen no disponible
Immagine non disponibile
Nicht verfügbares Bild
Brak zdjęćia
Картина недоступна

PLASTIC CAPSULE 26

590627

PROTECTION COVER 24 590564**SEP:SEPARATED REGULATOR -INC:BUILT-IN REGULATOR** 02

*2590558

RECTIFIER OR DIODE BRIDGE ASSEMBLY 07

180593

FAN 12 592673**PULLEY** 11 593253**ROTOR** 04 092968**Valeo**

433123

A13N188+

70

2

14



20°

Picture not available
Image non disponible
Imagen no disponible
Immagine non disponibile
Nicht verfügbares Bild
Brak zdjęćia
Картина недоступна

Picture not available
Image non disponible
Imagen no disponible
Immagine non disponibile
Nicht verfügbares Bild
Brak zdjęćia
Картина недоступна

PLASTIC CAPSULE 26

590627

PROTECTION COVER 24 590564**SEP:SEPARATED REGULATOR -INC:BUILT-IN REGULATOR** 02

*2590558

RECTIFIER OR DIODE BRIDGE ASSEMBLY 07 180593**FAN** 12 592673**PULLEY** 11 593253**STATOR** 05 592830**Valeo**

433124

A13N189

40

28



Picture not available
Image non disponible
Imagen no disponible
Immagine non disponibile
Nicht verfügbares Bild
Brak zdjęćia
Картина недоступна

Picture not available
Image non disponible
Imagen no disponible
Immagine non disponibile
Nicht verfügbares Bild
Brak zdjęćia
Картина недоступна

PLASTIC CAPSULE 26

590627

FRONT BEARING 21 593224**REAR BEARING** 22 590619**BRUSH HOLDER** 09 300665**SEP:SEPARATED REGULATOR -INC:BUILT-IN REGULATOR** 02 590640**RECTIFIER OR DIODE BRIDGE ASSEMBLY** 07 593199**THROUGH BOLTS** 23 518611**A13N19**

50

1

1V

14



60°

Ø 59,7

INC

**SEP:SEPARATED REGULATOR -INC:BUILT-IN REGULATOR** 02

*2590558

Valeo

432736/433411

A13N190

40

28



Picture not available
Image non disponible
Imagen no disponible
Immagine non disponibile
Nicht verfügbares Bild
Brak zdjęcia
Картина недоступна

Picture not available
Image non disponible
Imagen no disponible
Immagine non disponibile
Nicht verfügbares Bild
Brak zdjęcia
Картина недоступна

PLASTIC CAPSULE	26	590627
FRONT BEARING	21	593224
REAR BEARING	22	590619
BRUSH HOLDER	09	300665
SEP:SEPARATED REGULATOR -INC:BUILT-IN REGULATOR	02	590640
RECTIFIER OR DIODE BRIDGE ASSEMBLY	07	593199
THROUGH BOLTS	23	518611
Valeo		592773

A13N198+

80

14



Picture not available
Image non disponible
Imagen no disponible
Immagine non disponibile
Nicht verfügbares Bild
Brak zdjęcia
Картина недоступна

Picture not available
Image non disponible
Imagen no disponible
Immagine non disponibile
Nicht verfügbares Bild
Brak zdjęcia
Картина недоступна

PLASTIC CAPSULE	26	590627
FRONT BEARING	21	593224
REAR BEARING	22	590619
BRUSH HOLDER	09	300665
SEP:SEPARATED REGULATOR -INC:BUILT-IN REGULATOR	02	182007
RECTIFIER OR DIODE BRIDGE ASSEMBLY	07	593199
THROUGH BOLTS	23	518611

A13N199+

70

2

6V

14



0°

Ø 58,18

INC



PLASTIC CAPSULE	26	590627
REAR BEARING	22	590568
PROTECTION COVER	24	590564
SEP:SEPARATED REGULATOR -INC:BUILT-IN REGULATOR	02	*2590558
RECTIFIER OR DIODE BRIDGE ASSEMBLY	07	180593
FAN	12	592673
ROTOR	04	590625
STATOR	05	592830
Valeo		433144/436254

A13N20

50

1

1V

14



60°

Ø 59,7

INC



PLASTIC CAPSULE	26	590627
REAR BEARING	22	590619
PROTECTION COVER	24	590564
BRUSH HOLDER	09	092859
SEP:SEPARATED REGULATOR -INC:BUILT-IN REGULATOR	02	*2590558
RECTIFIER OR DIODE BRIDGE ASSEMBLY	07	105135
FAN	12	592673
FAN	12	590553
PULLEY	11	593253
ROTOR	04	092985
STATOR	05	100930
Valeo		432724/433429

A13N200+

70

2

5V

14



60°

Ø 58,2

INC



PLASTIC CAPSULE	26	590627
REAR BEARING	22	590568
PROTECTION COVER	24	590564
REAR BRACKET	25	593230
SEP:SEPARATED REGULATOR -INC:BUILT-IN REGULATOR	02	*2590558
FAN	12	592673
PULLEY	11	592757
STATOR	05	592830
Valeo		433145/436252

A13N201+

70

2

6V

14



60°

Ø 58,2

INC



PLASTIC CAPSULE	26	590627
REAR BEARING	22	590568
PROTECTION COVER	24	590564
REAR BRACKET	25	593230
SEP:SEPARATED REGULATOR -INC:BUILT-IN REGULATOR	02	*2590558
FAN	12	592673
STATOR	05	592830
Valeo		433146/436253

A13N203

60 2 3V

14 ↻ 20° ∅ 67,2

Picture not available
Image non disponible
Imagem no disponibile
Immagine non disponibile
Nicht verfügbares Bild
Brak zdjęcia
Картина недоступна

Picture not available
Image non disponible
Imagem no disponibile
Immagine non disponibile
Nicht verfügbares Bild
Brak zdjęcia
Картина недоступна

PLASTIC CAPSULE 📏26	590627
REAR BEARING 📏22	590568
PROTECTION COVER 📏24	590564
BRUSH HOLDER 📏09	593243
SEP:SEPARATED REGULATOR -INC:BUILT-IN REGULATOR 📏02	
*2590558	
RECTIFIER OR DIODE BRIDGE ASSEMBLY 📏07	180593
FAN 📏12	592673
ROTOR 📏04	590639
Valeo	433147

A13N204+

70 2 3V

14 ↻ 20° ∅ 67,2 INC

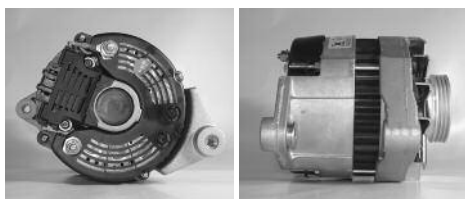

PLASTIC CAPSULE 📏26	590627
REAR BEARING 📏22	590568
PROTECTION COVER 📏24	590564
SEP:SEPARATED REGULATOR -INC:BUILT-IN REGULATOR 📏02	
*2590558	
RECTIFIER OR DIODE BRIDGE ASSEMBLY 📏07	180593
FAN 📏12	592673
ROTOR 📏04	590625
STATOR 📏05	592830
Valeo	433148/436461

A13N206+

70 2 6V

14 ↻ 0° ∅ 62,9 INC

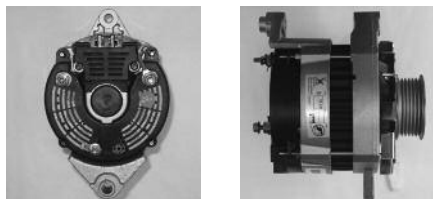

PLASTIC CAPSULE 📏26	590627
REAR BEARING 📏22	590568
PROTECTION COVER 📏24	590564
SEP:SEPARATED REGULATOR -INC:BUILT-IN REGULATOR 📏02	
*2590558	
RECTIFIER OR DIODE BRIDGE ASSEMBLY 📏07	180593
FAN 📏12	592673
PULLEY 📏11	105760
ROTOR 📏04	590625
STATOR 📏05	592830
Valeo	433149/436255

A13N207+

70 2

14 ↻ 20° INC

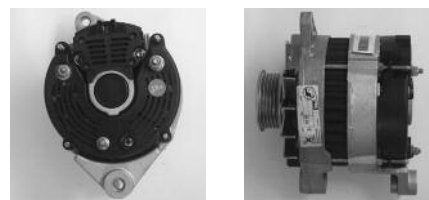

PLASTIC CAPSULE 📏26	590627
PLASTIC CAPSULE 📏26	590627
REAR BEARING 📏22	590568
REAR BEARING 📏22	590568
SEP:SEPARATED REGULATOR -INC:BUILT-IN REGULATOR 📏02	182120
SEP:SEPARATED REGULATOR -INC:BUILT-IN REGULATOR 📏02	182120
RECTIFIER OR DIODE BRIDGE ASSEMBLY 📏07	592951
RECTIFIER OR DIODE BRIDGE ASSEMBLY 📏07	592951
FAN 📏12	592673
FAN 📏12	592673
PULLEY 📏11	592760
PULLEY 📏11	592760
ROTOR 📏04	590625
ROTOR 📏04	590625
STATOR 📏05	592830
STATOR 📏05	592830
Valeo	541314/436371

A13N209

60 2 6V

14 ↻ 0° ∅ 62,9 INC

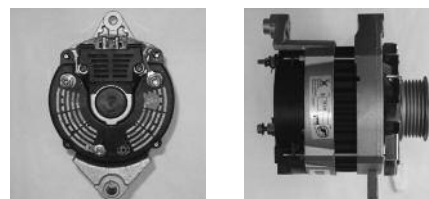

PLASTIC CAPSULE 📏26	590627
REAR BEARING 📏22	590568
PROTECTION COVER 📏24	590564
SEP:SEPARATED REGULATOR -INC:BUILT-IN REGULATOR 📏02	
*2590558	
FAN 📏12	592673
PULLEY 📏11	105760
ROTOR 📏04	092968
Valeo	433149/436255

A13N210

50 2 5V

14 ↻ 60° ∅ 71,16 INC

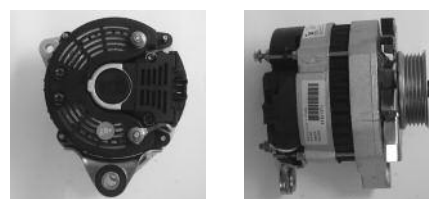

PLASTIC CAPSULE 📏26	590627
REAR BEARING 📏22	590568
PROTECTION COVER 📏24	590564
SEP:SEPARATED REGULATOR -INC:BUILT-IN REGULATOR 📏02	
*2590558	
RECTIFIER OR DIODE BRIDGE ASSEMBLY 📏07	180593
FAN 📏12	592673
ROTOR 📏04	092968
STATOR 📏05	100930
Valeo	433061/433441

A13N214

60 1 1V

14 ↻ 20° ∇ Ø 63,25 INC

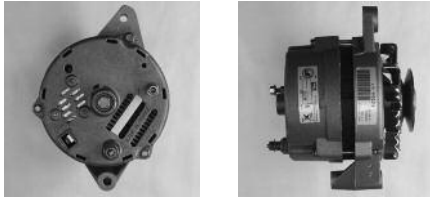

PLASTIC CAPSULE	↻ 26	590627
REAR BEARING	↻ 22	590568
PROTECTION COVER	↻ 24	590564
SEP:SEPARATED REGULATOR -INC:BUILT-IN REGULATOR	↻ 02	182120
RECTIFIER OR DIODE BRIDGE ASSEMBLY	↻ 07	592840
FAN	↻ 12	592673
PULLEY	↻ 11	096882
ROTOR	↻ 04	092968

A13N214

60 1 1V

14 ↻ 20° ∇ Ø 63,25 INC

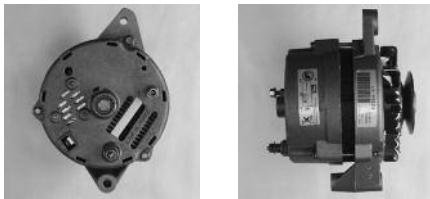

PLASTIC CAPSULE	↻ 26	590627
REAR BEARING	↻ 22	590568
PROTECTION COVER	↻ 24	590564
SEP:SEPARATED REGULATOR -INC:BUILT-IN REGULATOR	↻ 02	182120
RECTIFIER OR DIODE BRIDGE ASSEMBLY	↻ 07	592840
FAN	↻ 12	592673
PULLEY	↻ 11	096882
ROTOR	↻ 04	092968

Valeo**433055/436161****A13N215**

50 1 1V

14 ↻ 60° ∇ Ø 60 INC

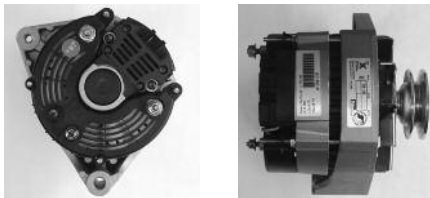

PLASTIC CAPSULE	↻ 26	590627
REAR BEARING	↻ 22	590568
SEP:SEPARATED REGULATOR -INC:BUILT-IN REGULATOR	↻ 02	182120
RECTIFIER OR DIODE BRIDGE ASSEMBLY	↻ 07	592877
FAN	↻ 12	592673
PULLEY	↻ 11	097140
ROTOR	↻ 04	300846
STATOR	↻ 05	100930

Valeo**433069/433455****A13N216+**

70 1 1V

14 ↻ 60° ∇ Ø 60 INC

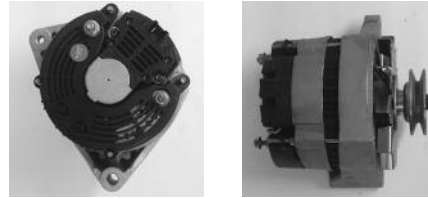

PLASTIC CAPSULE	↻ 26	590627
REAR BEARING	↻ 22	590568
SEP:SEPARATED REGULATOR -INC:BUILT-IN REGULATOR	↻ 02	182120
RECTIFIER OR DIODE BRIDGE ASSEMBLY	↻ 07	592877
FAN	↻ 12	592673
PULLEY	↻ 11	097140
STATOR	↻ 05	592830

A13N216+

70 1 1V

14 ↻ 60° ∇ Ø 60 INC

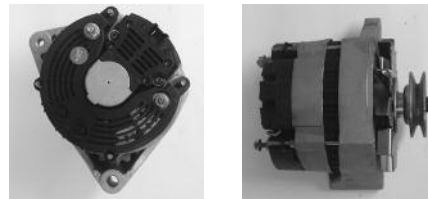

PLASTIC CAPSULE	↻ 26	590627
REAR BEARING	↻ 22	590568
SEP:SEPARATED REGULATOR -INC:BUILT-IN REGULATOR	↻ 02	182120
RECTIFIER OR DIODE BRIDGE ASSEMBLY	↻ 07	592877
FAN	↻ 12	592673
PULLEY	↻ 11	097140
STATOR	↻ 05	592830

Valeo**433070/436323****A13N217+**

70 2 5V

14 ↻ 20° ∇ Ø 59,4 INC

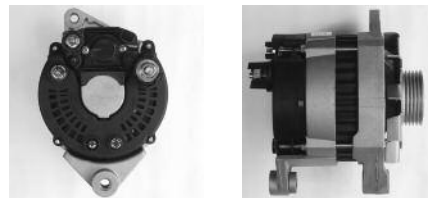

PLASTIC CAPSULE	↻ 26	590627
REAR BEARING	↻ 22	590568
SEP:SEPARATED REGULATOR -INC:BUILT-IN REGULATOR	↻ 02	590688
RECTIFIER OR DIODE BRIDGE ASSEMBLY	↻ 07	592878
FAN	↻ 12	592673
PULLEY	↻ 11	181485
ROTOR	↻ 04	590625
STATOR	↻ 05	592830

Valeo**433122/433468**

A13N218

50

2

4V

14



20°

Ø 59,4

INC



PLASTIC CAPSULE 26

590627

REAR BEARING 22

590568

SEP:SEPARATED REGULATOR -INC:BUILT-IN REGULATOR 02182120

RECTIFIER OR DIODE BRIDGE ASSEMBLY 07

592749

FAN 12

592673

ROTOR 04

590639

STATOR 05

100930

Valeo**432769/433364****A13N219**

50

2

5V

14



20°

Ø 59,4

INC



PLASTIC CAPSULE 26

590627

REAR BEARING 22

590568

SEP:SEPARATED REGULATOR -INC:BUILT-IN REGULATOR 02182120

RECTIFIER OR DIODE BRIDGE ASSEMBLY 07

592749

FAN 12

592673

PULLEY 11

592760

ROTOR 04

590639

STATOR 05

100930

Valeo**433094/433487****A13N220+**

70

2

4V

14



20°

Ø 59,4

INC



PLASTIC CAPSULE 26

590627

REAR BEARING 22

590568

SEP:SEPARATED REGULATOR -INC:BUILT-IN REGULATOR 02182120

RECTIFIER OR DIODE BRIDGE ASSEMBLY 07

592749

FAN 12

592673

ROTOR 04

590625

STATOR 05

592830

Valeo**433082/433457****A13N221**

50

2

1V

14



20°

Ø 59,7

INC



PLASTIC CAPSULE 26

590627

REAR BEARING 22

590568

PROTECTION COVER 24

590564

SEP:SEPARATED REGULATOR -INC:BUILT-IN REGULATOR 02182120

FAN 12

592673

PULLEY 11

593253

ROTOR 04

092968

STATOR 05

100930

Valeo**432746/433374****A13N226**

60

2

1V

14



0°

Ø 63,25

INC



PLASTIC CAPSULE 26

590627

REAR BEARING 22

590568

PROTECTION COVER 24

590564

SEP:SEPARATED REGULATOR -INC:BUILT-IN REGULATOR 02

*2590558

RECTIFIER OR DIODE BRIDGE ASSEMBLY 07

180593

FAN 12

592673

PULLEY 11

096882

ROTOR 04

092968

Valeo**439180/433437****A13N229T**

40

2

2V

28



20°

Ø 70

Picture not available
Image non disponible
Imagen no disponible
Immagine non disponibile
Nicht verfügbares Bild
Brak zdjęcia
Картина недоступна

Picture not available
Image non disponible
Imagen no disponible
Immagine non disponibile
Nicht verfügbares Bild
Brak zdjęcia
Картина недоступна

PLASTIC CAPSULE 26

590629

FRONT BEARING 21

592860

REAR BEARING 22

590613

PROTECTION COVER 24

590564

SEP:SEPARATED REGULATOR -INC:BUILT-IN REGULATOR 02590640

RECTIFIER OR DIODE BRIDGE ASSEMBLY 07

101342

FAN 12

592673

STATOR 05

101339

Valeo**436347**

A13N230+

70 2 6V

14 ↻ 0° ∇ Ø 58,18 INC



PLASTIC CAPSULE 📏26 590627
REAR BEARING 📏22 590568
PROTECTION COVER 📏24 590564
SEP:SEPARATED REGULATOR -INC:BUILT-IN REGULATOR 📏02
 *2590558
FAN 📏12 592673
ROTOR 📏04 590625
STATOR 📏05 592830
Valeo 433144/436254

A13N231

60 2 6V

14 ↻ 0° ∇ Ø 58,18 INC



PLASTIC CAPSULE 📏26 590627
FRONT BEARING 📏21 593224
REAR BEARING 📏22 590568
PROTECTION COVER 📏24 590564
SEP:SEPARATED REGULATOR -INC:BUILT-IN REGULATOR 📏02182120
FAN 📏12 590553
ROTOR 📏04 092968
Valeo 433113/436473

A13N233+

70 2 3V

14 ↻ 0° ∇ Ø 58,18 INC



PLASTIC CAPSULE 📏26 590627
REAR BEARING 📏22 590568
PROTECTION COVER 📏24 590564
SEP:SEPARATED REGULATOR -INC:BUILT-IN REGULATOR 📏02182120
RECTIFIER OR DIODE BRIDGE ASSEMBLY 📏07 593180
FAN 📏12 590553
PULLEY 📏11 593215
STATOR 📏05 592830
Valeo 433080/436472

A13N234

60 1

14 ↻ 20° ∇

Picture not available
 Image non disponible
 Imagen no disponible
 Immagine non disponibile
 Nicht verfügbares Bild
 Brak zdjęcia
 Картина недоступна

Picture not available
 Image non disponible
 Imagen no disponible
 Immagine non disponibile
 Nicht verfügbares Bild
 Brak zdjęcia
 Картина недоступна

PLASTIC CAPSULE 📏26 590627
FRONT BEARING 📏21 593224
REAR BEARING 📏22 590568
PROTECTION COVER 📏24 590564
SEP:SEPARATED REGULATOR -INC:BUILT-IN REGULATOR 📏02593135
RECTIFIER OR DIODE BRIDGE ASSEMBLY 📏07 593309
FAN 📏12 592673
Valeo 439185/436676

A13N235+

70 2 6V

14 ↻ 0° ∇ Ø 62,9 INC



PLASTIC CAPSULE 📏26 590627
REAR BEARING 📏22 590568
PROTECTION COVER 📏24 590564
SEP:SEPARATED REGULATOR -INC:BUILT-IN REGULATOR 📏02
 *2590558
RECTIFIER OR DIODE BRIDGE ASSEMBLY 📏07 592880
FAN 📏12 592673
PULLEY 📏11 105760
ROTOR 📏04 590625
STATOR 📏05 592830
Valeo 436372

A13N236M

35 1 2V

28 ↻ 60° ∇ Ø 89,4

Picture not available
 Image non disponible
 Imagen no disponible
 Immagine non disponibile
 Nicht verfügbares Bild
 Brak zdjęcia
 Картина недоступна

Picture not available
 Image non disponible
 Imagen no disponible
 Immagine non disponibile
 Nicht verfügbares Bild
 Brak zdjęcia
 Картина недоступна

PLASTIC CAPSULE 📏26 590629
FRONT BEARING 📏21 592780
REAR BEARING 📏22 590613
BRUSH HOLDER 📏09 092967
SEP:SEPARATED REGULATOR -INC:BUILT-IN REGULATOR 📏02590605
RECTIFIER OR DIODE BRIDGE ASSEMBLY 📏07 592882
Valeo 439241/436427

A13N237

50

1

1V

14



45°

Ø 80

Picture not available
Image non disponible
Imagen no disponible
Immagine non disponibile
Nicht verfügbares Bild
Brak zdjęcia
Картина недоступна

Picture not available
Image non disponible
Imagen no disponible
Immagine non disponibile
Nicht verfügbares Bild
Brak zdjęcia
Картина недоступна

PLASTIC CAPSULE 26

590627

REAR BEARING 22

590568

PROTECTION COVER 24

590564

SEP:SEPARATED REGULATOR -INC:BUILT-IN REGULATOR 02593191**RECTIFIER OR DIODE BRIDGE ASSEMBLY** 07

592877

FAN 12

092477

STATOR 05

100930

Valeo**439186/436373****A13N238+**

70

1

1V

14



0°

Ø 83,7

Picture not available
Image non disponible
Imagen no disponible
Immagine non disponibile
Nicht verfügbares Bild
Brak zdjęcia
Картина недоступна

Picture not available
Image non disponible
Imagen no disponible
Immagine non disponibile
Nicht verfügbares Bild
Brak zdjęcia
Картина недоступна

PLASTIC CAPSULE 26

590627

REAR BEARING 22

590568

SEP:SEPARATED REGULATOR -INC:BUILT-IN REGULATOR 02593191**FAN** 12

100809

PULLEY 11

507050

STATOR 05

592830

Valeo**439187/436374****A13N239+**

70

2

1V

14



20°

Ø 59,7

INC

**PLASTIC CAPSULE** 26

590627

REAR BEARING 22

590568

PROTECTION COVER 24

590564

SEP:SEPARATED REGULATOR -INC:BUILT-IN REGULATOR 02182120**RECTIFIER OR DIODE BRIDGE ASSEMBLY** 07

592877

FAN 12

592673

PULLEY 11

593253

STATOR 05

592830

Valeo**432829/436316****A13N240**

50

2

4V

14



20°

Ø 59,4

INC

**PLASTIC CAPSULE** 26

590627

REAR BEARING 22

590568

PROTECTION COVER 24

590564

SEP:SEPARATED REGULATOR -INC:BUILT-IN REGULATOR 02182120**RECTIFIER OR DIODE BRIDGE ASSEMBLY** 07

592749

FAN 12

592673

ROTOR 04

590639

STATOR 05

100930

Valeo**432769/433364****A13N241+**

70

2

6V

14



0°

Ø 58,18

INC

**PLASTIC CAPSULE** 26

590627

FRONT BEARING 21

593224

REAR BEARING 22

590568

PROTECTION COVER 24

590564

SEP:SEPARATED REGULATOR -INC:BUILT-IN REGULATOR 02182120**RECTIFIER OR DIODE BRIDGE ASSEMBLY** 07

593180

FAN 12

592673

STATOR 05

592830

A13N241+

70

2

6V

14



0°

Ø 58,18

INC

**PLASTIC CAPSULE** 26

590627

FRONT BEARING 21

593224

REAR BEARING 22

590568

PROTECTION COVER 24

590564

SEP:SEPARATED REGULATOR -INC:BUILT-IN REGULATOR 02182120**RECTIFIER OR DIODE BRIDGE ASSEMBLY** 07

593180

FAN 12

592673

STATOR 05

592830

Valeo**433079/436310**

A13N242+

70 2 3V

14 ↻ 0° Ø 58,18 INC

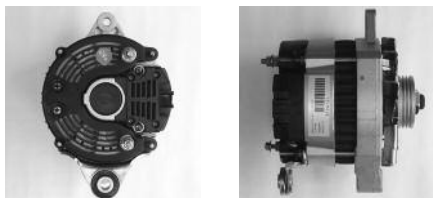

PLASTIC CAPSULE	26	590627
REAR BEARING	22	590568
PROTECTION COVER	24	590564
SEP:SEPARATED REGULATOR -INC:BUILT-IN REGULATOR	02	182120
RECTIFIER OR DIODE BRIDGE ASSEMBLY	07	593180
FAN	12	592673
PULLEY	11	593215
STATOR	05	592830
Valeo		433080/436472

A13N243CKD

50 2 1V

14 ↻ 20° Ø 59,7

Picture not available
Image non disponible
Imagen no disponible
Immagine non disponibile
Nicht verfügbares Bild
Brak zdjęcia
Картина недоступна

Picture not available
Image non disponible
Imagen no disponible
Immagine non disponibile
Nicht verfügbares Bild
Brak zdjęcia
Картина недоступна

PLASTIC CAPSULE	26	590627
REAR BEARING	22	590568
PROTECTION COVER	24	590564
SEP:SEPARATED REGULATOR -INC:BUILT-IN REGULATOR	02	182120
RECTIFIER OR DIODE BRIDGE ASSEMBLY	07	592840
FAN	12	592673
PULLEY	11	593253
ROTOR	04	092968
STATOR	05	100930
Valeo		436375

A13N244

60 1 1V

14 ↻ 60° Ø 71,5

Picture not available
Image non disponible
Imagen no disponible
Immagine non disponibile
Nicht verfügbares Bild
Brak zdjęcia
Картина недоступна

Picture not available
Image non disponible
Imagen no disponible
Immagine non disponibile
Nicht verfügbares Bild
Brak zdjęcia
Картина недоступна

PLASTIC CAPSULE	26	590627
REAR BEARING	22	590568
SEP:SEPARATED REGULATOR -INC:BUILT-IN REGULATOR	02	182120
RECTIFIER OR DIODE BRIDGE ASSEMBLY	07	105754
FAN	12	592673
PULLEY	11	593209
ROTOR	04	092968
Valeo		592855

A13N245+

70 2

14 ↻ 20°

Picture not available
Image non disponible
Imagen no disponible
Immagine non disponibile
Nicht verfügbares Bild
Brak zdjęcia
Картина недоступна

Picture not available
Image non disponible
Imagen no disponible
Immagine non disponibile
Nicht verfügbares Bild
Brak zdjęcia
Картина недоступна

PLASTIC CAPSULE	26	590627
REAR BEARING	22	590568
PROTECTION COVER	24	590564
SEP:SEPARATED REGULATOR -INC:BUILT-IN REGULATOR	02	593191
RECTIFIER OR DIODE BRIDGE ASSEMBLY	07	593182
FAN	12	592673
STATOR	05	592830
Valeo		439220/437182

A13N247+

70 2 1V

14 ↻ 55° Ø 66 INC



PLASTIC CAPSULE	26	590627
REAR BEARING	22	590568
PROTECTION COVER	24	590564
SEP:SEPARATED REGULATOR -INC:BUILT-IN REGULATOR	02	182120
RECTIFIER OR DIODE BRIDGE ASSEMBLY	07	592749
FAN	12	100809
PULLEY	11	096879
REAR BRACKET	25	593218
STATOR	05	592830
Valeo		433368

A13N25+

70 2 1V

14 ↻ 42° Ø 48

Picture not available
Image non disponible
Imagen no disponible
Immagine non disponibile
Nicht verfügbares Bild
Brak zdjęcia
Картина недоступна

Picture not available
Image non disponible
Imagen no disponible
Immagine non disponibile
Nicht verfügbares Bild
Brak zdjęcia
Картина недоступна

PLASTIC CAPSULE	26	590627
REAR BEARING	22	590568
PROTECTION COVER	24	590564
REAR BRACKET	25	593227
BRUSH HOLDER	09	092859
SEP:SEPARATED REGULATOR -INC:BUILT-IN REGULATOR	02	182120
FAN	12	092477
REAR BRACKET	25	102319
ROTOR	04	092968
STATOR	05	592830
Valeo		432737

A13N255

60

14



Picture not available
Image non disponible
Imagen no disponible
Immagine non disponibile
Nicht verfügbares Bild
Brak zdjęcia
Картина недоступна

Picture not available
Image non disponible
Imagen no disponible
Immagine non disponibile
Nicht verfügbares Bild
Brak zdjęcia
Картина недоступна

PLASTIC CAPSULE 26	590627
FRONT BEARING 21	593224
REAR BEARING 22	590619
BRUSH HOLDER 09	300665
SEP:SEPARATED REGULATOR -INC:BUILT-IN REGULATOR 02	182007
RECTIFIER OR DIODE BRIDGE ASSEMBLY 07	593199
ROTOR 04	593265
STATOR 05	593278
THROUGH BOLTS 23	518611
Valeo	592769/436376

A13N257

40

28



Picture not available
Image non disponible
Imagen no disponible
Immagine non disponibile
Nicht verfügbares Bild
Brak zdjęcia
Картина недоступна

Picture not available
Image non disponible
Imagen no disponible
Immagine non disponibile
Nicht verfügbares Bild
Brak zdjęcia
Картина недоступна

PLASTIC CAPSULE 26	590627
FRONT BEARING 21	593224
REAR BEARING 22	590619
BRUSH HOLDER 09	300665
SEP:SEPARATED REGULATOR -INC:BUILT-IN REGULATOR 02	590640
RECTIFIER OR DIODE BRIDGE ASSEMBLY 07	593199
ROTOR 04	593265
STATOR 05	101339
THROUGH BOLTS 23	518611
Valeo	439101/436377

A13N259

50

1

14



20°

Picture not available
Image non disponible
Imagen no disponible
Immagine non disponibile
Nicht verfügbares Bild
Brak zdjęcia
Картина недоступна

Picture not available
Image non disponible
Imagen no disponible
Immagine non disponibile
Nicht verfügbares Bild
Brak zdjęcia
Картина недоступна

PLASTIC CAPSULE 26	590627
FRONT BEARING 21	593224
REAR BEARING 22	590568
SEP:SEPARATED REGULATOR -INC:BUILT-IN REGULATOR 02	593135
RECTIFIER OR DIODE BRIDGE ASSEMBLY 07	593199
FAN 12	592673
ROTOR 04	300846
Valeo	439181/436378

A13N260

70

1

1V

14



45°

Ø 80

Picture not available
Image non disponible
Imagen no disponible
Immagine non disponibile
Nicht verfügbares Bild
Brak zdjęcia
Картина недоступна

Picture not available
Image non disponible
Imagen no disponible
Immagine non disponibile
Nicht verfügbares Bild
Brak zdjęcia
Картина недоступна

PLASTIC CAPSULE 26	590627
REAR BEARING 22	590568
SEP:SEPARATED REGULATOR -INC:BUILT-IN REGULATOR 02	593191
FAN 12	092477
STATOR 05	592830
Valeo	439184

A13N261

50

2

1V

14



20°

Ø 74

Picture not available
Image non disponible
Imagen no disponible
Immagine non disponibile
Nicht verfügbares Bild
Brak zdjęcia
Картина недоступна

Picture not available
Image non disponible
Imagen no disponible
Immagine non disponibile
Nicht verfügbares Bild
Brak zdjęcia
Картина недоступна

PLASTIC CAPSULE 26	590627
REAR BEARING 22	590568
PROTECTION COVER 24	590564
SEP:SEPARATED REGULATOR -INC:BUILT-IN REGULATOR 02	182120
RECTIFIER OR DIODE BRIDGE ASSEMBLY 07	592749
FAN 12	590553
ROTOR 04	590639
STATOR 05	100930
Valeo	439188

A13N262

50

1

1V

14



0°

Ø 95

Picture not available
Image non disponible
Imagen no disponible
Immagine non disponibile
Nicht verfügbares Bild
Brak zdjęcia
Картина недоступна

Picture not available
Image non disponible
Imagen no disponible
Immagine non disponibile
Nicht verfügbares Bild
Brak zdjęcia
Картина недоступна

PLASTIC CAPSULE 26	590627
REAR BEARING 22	590568
PROTECTION COVER 24	590564
SEP:SEPARATED REGULATOR -INC:BUILT-IN REGULATOR 02	182120
RECTIFIER OR DIODE BRIDGE ASSEMBLY 07	593182
FAN 12	592673
ROTOR 04	092968
STATOR 05	100930
Valeo	592868

A13N263

50 2 2V

14 ↻ 0° ∅ 71

Picture not available
Image non disponible
Imagen no disponible
Immagine non disponibile
Nicht verfügbares Bild
Brak zdjęcia
Картина недоступна

Picture not available
Image non disponible
Imagen no disponible
Immagine non disponibile
Nicht verfügbares Bild
Brak zdjęcia
Картина недоступна

PLASTIC CAPSULE 📏26 590627
REAR BEARING 📏22 590568
PROTECTION COVER 📏24 590564
SEP:SEPARATED REGULATOR -INC:BUILT-IN REGULATOR 📏02 182120
RECTIFIER OR DIODE BRIDGE ASSEMBLY 📏07 593178
FAN 📏12 590553
ROTOR 📏04 092968
STATOR 📏05 100930

A13N269

60 1 1V

14 ↻ 11° ∅ 68 INC

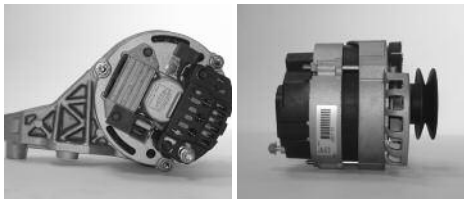

PLASTIC CAPSULE 📏26 590627
REAR BEARING 📏22 590568
SEP:SEPARATED REGULATOR -INC:BUILT-IN REGULATOR 📏02 182120
RECTIFIER OR DIODE BRIDGE ASSEMBLY 📏07 592749
FAN 📏12 592673
PULLEY 📏11 593912
ROTOR 📏04 300846

A13N269

60 1 1V

14 ↻ 11° ∅ 68 INC



PLASTIC CAPSULE 📏26 590627
REAR BEARING 📏22 590568
SEP:SEPARATED REGULATOR -INC:BUILT-IN REGULATOR 📏02 182120
RECTIFIER OR DIODE BRIDGE ASSEMBLY 📏07 592749
FAN 📏12 592673
PULLEY 📏11 593912
ROTOR 📏04 300846

Valeo**439013/436446****A13N27**

50 1 4V

14 ↻ 60° ∅ 71,16 INC

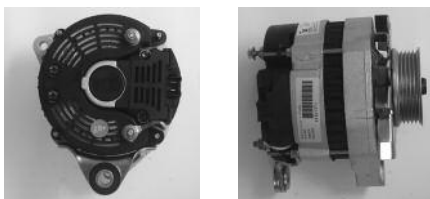

PLASTIC CAPSULE 📏26 590627
REAR BEARING 📏22 590568
PROTECTION COVER 📏24 590564
SEP:SEPARATED REGULATOR -INC:BUILT-IN REGULATOR 📏02

*2590558

RECTIFIER OR DIODE BRIDGE ASSEMBLY 📏07

180593

FAN 📏12

592673

FAN 📏12

590553

STATOR 📏05

100930

Valeo**433061/433441****A13N270**

40 1 SP

28 ↻ 20°

Picture not available
Image non disponible
Imagen no disponible
Immagine non disponibile
Nicht verfügbares Bild
Brak zdjęcia
Картина недоступна

Picture not available
Image non disponible
Imagen no disponible
Immagine non disponibile
Nicht verfügbares Bild
Brak zdjęcia
Картина недоступна

PLASTIC CAPSULE 📏26 590627
FRONT BEARING 📏21 593224
REAR BEARING 📏22 590568
SEP:SEPARATED REGULATOR -INC:BUILT-IN REGULATOR 📏02 593136
FAN 📏12 592673
STATOR 📏05 101339

Valeo**439189****A13N271**

60

14 ↻

Picture not available
Image non disponible
Imagen no disponible
Immagine non disponibile
Nicht verfügbares Bild
Brak zdjęcia
Картина недоступна

Picture not available
Image non disponible
Imagen no disponible
Immagine non disponibile
Nicht verfügbares Bild
Brak zdjęcia
Картина недоступна

PLASTIC CAPSULE 📏26 590627
FRONT BEARING 📏21 593224
REAR BEARING 📏22 590619
SEP:SEPARATED REGULATOR -INC:BUILT-IN REGULATOR 📏02 182120
RECTIFIER OR DIODE BRIDGE ASSEMBLY 📏07 593199
ROTOR 📏04 593270
STATOR 📏05 593278
THROUGH BOLTS 📏23 518611

Valeo**439190/436491****A13N272**

40 SP

28 ↻

Picture not available
Image non disponible
Imagen no disponible
Immagine non disponibile
Nicht verfügbares Bild
Brak zdjęcia
Картина недоступна

Picture not available
Image non disponible
Imagen no disponible
Immagine non disponibile
Nicht verfügbares Bild
Brak zdjęcia
Картина недоступна

PLASTIC CAPSULE 📏26 590627
FRONT BEARING 📏21 593224
REAR BEARING 📏22 590619
SEP:SEPARATED REGULATOR -INC:BUILT-IN REGULATOR 📏02 593835
RECTIFIER OR DIODE BRIDGE ASSEMBLY 📏07 593199
ROTOR 📏04 593270
STATOR 📏05 101339
THROUGH BOLTS 📏23 518611

Valeo**439191/436492**

A13N273+

80

SP

14



Picture not available
Image non disponible
Imagen no disponible
Immagine non disponibile
Nicht verfügbares Bild
Brak zdjęćia
Картина недоступна

Picture not available
Image non disponible
Imagen no disponible
Immagine non disponibile
Nicht verfügbares Bild
Brak zdjęćia
Картина недоступна

PLASTIC CAPSULE 26 590627
FRONT BEARING 21 593224
REAR BEARING 22 590619
SEP:SEPARATED REGULATOR -INC:BUILT-IN REGULATOR 02 182120
RECTIFIER OR DIODE BRIDGE ASSEMBLY 07 593199
THROUGH BOLTS 23 518611

Valeo**439192/436493****A13N274+**

70

2

2V

14



60°

Ø 81

Picture not available
Image non disponible
Imagen no disponible
Immagine non disponibile
Nicht verfügbares Bild
Brak zdjęćia
Картина недоступна

Picture not available
Image non disponible
Imagen no disponible
Immagine non disponibile
Nicht verfügbares Bild
Brak zdjęćia
Картина недоступна

PLASTIC CAPSULE 26 590627
PROTECTION COVER 24 590564
SEP:SEPARATED REGULATOR -INC:BUILT-IN REGULATOR 02 593191
RECTIFIER OR DIODE BRIDGE ASSEMBLY 07 593183
FAN 12 592673
PULLEY 11 593221
ROTOR 04 593268
STATOR 05 592830

Valeo**439097/436715****A13N275+**

70

2

2V

14



0°

Ø 81,75

Picture not available
Image non disponible
Imagen no disponible
Immagine non disponibile
Nicht verfügbares Bild
Brak zdjęćia
Картина недоступна

Picture not available
Image non disponible
Imagen no disponible
Immagine non disponibile
Nicht verfügbares Bild
Brak zdjęćia
Картина недоступна

PLASTIC CAPSULE 26 590627
PROTECTION COVER 24 590564
SEP:SEPARATED REGULATOR -INC:BUILT-IN REGULATOR 02 593191
RECTIFIER OR DIODE BRIDGE ASSEMBLY 07 593183
FAN 12 592673
PULLEY 11 593222
ROTOR 04 593268
STATOR 05 592830

Valeo**439098/436716****A13N276+**

70

2

2V

14



60°

Ø 90,58

Picture not available
Image non disponible
Imagen no disponible
Immagine non disponibile
Nicht verfügbares Bild
Brak zdjęćia
Картина недоступна

Picture not available
Image non disponible
Imagen no disponible
Immagine non disponibile
Nicht verfügbares Bild
Brak zdjęćia
Картина недоступна

PLASTIC CAPSULE 26 590627
PROTECTION COVER 24 590564
SEP:SEPARATED REGULATOR -INC:BUILT-IN REGULATOR 02 593191
RECTIFIER OR DIODE BRIDGE ASSEMBLY 07 593183
FAN 12 592673
PULLEY 11 593220
ROTOR 04 593268
STATOR 05 592830

Valeo**439099/436717****A13N277**

50

1

1V

14



20°

Ø 70

Picture not available
Image non disponible
Imagen no disponible
Immagine non disponibile
Nicht verfügbares Bild
Brak zdjęćia
Картина недоступна

Picture not available
Image non disponible
Imagen no disponible
Immagine non disponibile
Nicht verfügbares Bild
Brak zdjęćia
Картина недоступна

PLASTIC CAPSULE 26 590627
REAR BEARING 22 590568
PROTECTION COVER 24 590564
SEP:SEPARATED REGULATOR -INC:BUILT-IN REGULATOR 02 593191
RECTIFIER OR DIODE BRIDGE ASSEMBLY 07 593187
FAN 12 592673
PULLEY 11 593223
ROTOR 04 092968
STATOR 05 100930

Valeo**439193/436708****A13N278+**

70

1

2V

14



20°

Ø 70

Picture not available
Image non disponible
Imagen no disponible
Immagine non disponibile
Nicht verfügbares Bild
Brak zdjęćia
Картина недоступна

Picture not available
Image non disponible
Imagen no disponible
Immagine non disponibile
Nicht verfügbares Bild
Brak zdjęćia
Картина недоступна

PLASTIC CAPSULE 26 590627
REAR BEARING 22 590568
PROTECTION COVER 24 590564
SEP:SEPARATED REGULATOR -INC:BUILT-IN REGULATOR 02 593191
RECTIFIER OR DIODE BRIDGE ASSEMBLY 07 593182
FAN 12 592673
STATOR 05 592830

Valeo**439194/436709**

A13N279+

70 1 2V

14 ↻ 20° ▽ ∅ 77,3

Picture not available
Image non disponible
Imagen no disponible
Immagine non disponibile
Nicht verfügbares Bild
Brak zdjęcia
Картина недоступна

Picture not available
Image non disponible
Imagen no disponible
Immagine non disponibile
Nicht verfügbares Bild
Brak zdjęcia
Картина недоступна

PLASTIC CAPSULE 26 590627
REAR BEARING 22 590568
PROTECTION COVER 24 590564
SEP:SEPARATED REGULATOR -INC:BUILT-IN REGULATOR 02 593191
RECTIFIER OR DIODE BRIDGE ASSEMBLY 07 593182
FAN 12 592673
PULLEY 11 593254
STATOR 05 592830
Valeo 439195/436710

A13N280+

70 1 1V

14 ↻ 20° ▽ ∅ 82,5

Picture not available
Image non disponible
Imagen no disponible
Immagine non disponibile
Nicht verfügbares Bild
Brak zdjęcia
Картина недоступна

Picture not available
Image non disponible
Imagen no disponible
Immagine non disponibile
Nicht verfügbares Bild
Brak zdjęcia
Картина недоступна

PLASTIC CAPSULE 26 590627
REAR BEARING 22 590568
PROTECTION COVER 24 590564
SEP:SEPARATED REGULATOR -INC:BUILT-IN REGULATOR 02 593191
RECTIFIER OR DIODE BRIDGE ASSEMBLY 07 593182
FAN 12 592673
STATOR 05 592830
Valeo 439196/436711

A13N283M

40 2

28 ↻ 20° ▽

Picture not available
Image non disponible
Imagen no disponible
Immagine non disponibile
Nicht verfügbares Bild
Brak zdjęcia
Картина недоступна

Picture not available
Image non disponible
Imagen no disponible
Immagine non disponibile
Nicht verfügbares Bild
Brak zdjęcia
Картина недоступна

PLASTIC CAPSULE 26 590629
FRONT BEARING 21 592860
REAR BEARING 22 590613
PROTECTION COVER 24 590564
BRUSH HOLDER 09 092967
SEP:SEPARATED REGULATOR -INC:BUILT-IN REGULATOR 02 182169
RECTIFIER OR DIODE BRIDGE ASSEMBLY 07 593188
FAN 12 592673
STATOR 05 101339
Valeo 439043/436664

A13N284+

70 2 6V

14 ↻ 0° ▽ ∅ 62,9

Picture not available
Image non disponible
Imagen no disponible
Immagine non disponibile
Nicht verfügbares Bild
Brak zdjęcia
Картина недоступна

Picture not available
Image non disponible
Imagen no disponible
Immagine non disponibile
Nicht verfügbares Bild
Brak zdjęcia
Картина недоступна

PLASTIC CAPSULE 26 590627
REAR BEARING 22 590568
PROTECTION COVER 24 590564
SEP:SEPARATED REGULATOR -INC:BUILT-IN REGULATOR 02 182120
RECTIFIER OR DIODE BRIDGE ASSEMBLY 07 593187
FAN 12 592673
PULLEY 11 105760
ROTOR 04 590625
STATOR 05 592830
Valeo 439041/436494

A13N285

60 1

14 ↻ 20° ▽

Picture not available
Image non disponible
Imagen no disponible
Immagine non disponibile
Nicht verfügbares Bild
Brak zdjęcia
Картина недоступна

Picture not available
Image non disponible
Imagen no disponible
Immagine non disponibile
Nicht verfügbares Bild
Brak zdjęcia
Картина недоступна

PLASTIC CAPSULE 26 590627
FRONT BEARING 21 593224
REAR BEARING 22 590568
PROTECTION COVER 24 590564
SEP:SEPARATED REGULATOR -INC:BUILT-IN REGULATOR 02 593135
RECTIFIER OR DIODE BRIDGE ASSEMBLY 07 592754
FAN 12 590553
Valeo 439067/436638

A13N289

70 2 4V

14 ↻ 0° ▽ ∅ 57,18 INC

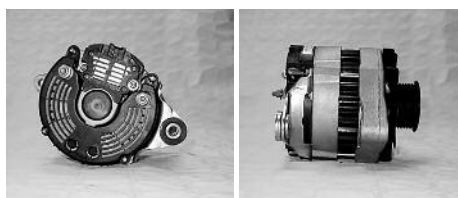

PLASTIC CAPSULE 26 590627
REAR BEARING 22 590568
PROTECTION COVER 24 590564
SEP:SEPARATED REGULATOR -INC:BUILT-IN REGULATOR 02 182120
RECTIFIER OR DIODE BRIDGE ASSEMBLY 07 593180
FAN 12 590553
PULLEY 11 593248
STATOR 05 592830
Valeo 439074/436645

A13N29	50	2	4V
14		0°	Ø 71,16 INC



PLASTIC CAPSULE	26	590627
REAR BEARING	22	590568
PROTECTION COVER	24	590564
BRUSH HOLDER	09	092859
SEP:SEPARATED REGULATOR -INC:BUILT-IN REGULATOR	02	*2590558
RECTIFIER OR DIODE BRIDGE ASSEMBLY	07	180593
FAN	12	592673
FAN	12	590553
ROTOR	04	092968
STATOR	05	100930
Valeo		432763/433420

A13N290	55	1	SP
14		60°	



PLASTIC CAPSULE	26	590627
FRONT BEARING	21	592780
PROTECTION COVER	24	590564
SEP:SEPARATED REGULATOR -INC:BUILT-IN REGULATOR	02	593191
STATOR	05	593278

A13N291+	70	1	1V
14		45°	Ø 80



PLASTIC CAPSULE	26	590627
REAR BEARING	22	590568
PROTECTION COVER	24	590564
SEP:SEPARATED REGULATOR -INC:BUILT-IN REGULATOR	02	593191
RECTIFIER OR DIODE BRIDGE ASSEMBLY	07	104269
FAN	12	092477
ROTOR	04	592813
STATOR	05	592830
Valeo		439233

A13N293	50	1	1V
14		45°	Ø 80



PLASTIC CAPSULE	26	590627
REAR BEARING	22	590568
PROTECTION COVER	24	590564
SEP:SEPARATED REGULATOR -INC:BUILT-IN REGULATOR	02	593191
RECTIFIER OR DIODE BRIDGE ASSEMBLY	07	104269
FAN	12	092477
STATOR	05	100930
Valeo		439243

A13N296	50	1	1V
14		0°	Ø 83,7



PLASTIC CAPSULE	26	590627
REAR BEARING	22	590568
PROTECTION COVER	24	590564
SEP:SEPARATED REGULATOR -INC:BUILT-IN REGULATOR	02	593191
RECTIFIER OR DIODE BRIDGE ASSEMBLY	07	104269
FAN	12	590553
ROTOR	04	092968
STATOR	05	100930
Valeo		439288

A13N297	70	1	1V
14		0°	Ø 83,7



PLASTIC CAPSULE	26	590627
REAR BEARING	22	590568
SEP:SEPARATED REGULATOR -INC:BUILT-IN REGULATOR	02	593191
RECTIFIER OR DIODE BRIDGE ASSEMBLY	07	104269
FAN	12	100809
PULLEY	11	507050
ROTOR	04	592813
STATOR	05	592830
Valeo		439386

A13N30	50	2	5V
14		0°	Ø 62,9



SEP:SEPARATED REGULATOR -INC:BUILT-IN REGULATOR	02	*2590558
Valeo		432765/433443



A13N303

70 2 1V

14 ↻ 42° ▷ ∅ 60 INC



PLASTIC CAPSULE 🛠️ 26	590627
REAR BEARING 🛠️ 22	590568
PROTECTION COVER 🛠️ 24	590564
SEP:SEPARATED REGULATOR -INC:BUILT-IN REGULATOR 🛠️ 02	182120
RECTIFIER OR DIODE BRIDGE ASSEMBLY 🛠️ 07	593180
FAN 🛠️ 12	590553
PULLEY 🛠️ 11	097140
ROTOR 🛠️ 04	092968
STATOR 🛠️ 05	592830
Valeo	437505

A13N306

60 1 1V

14 ↻ 60° ▷ ∅ 71,5

Picture not available
Image non disponible
Imagen no disponible
Immagine non disponibile
Nicht verfügbares Bild
Brak zdjęcia
Картина недоступна

Picture not available
Image non disponible
Imagen no disponible
Immagine non disponibile
Nicht verfügbares Bild
Brak zdjęcia
Картина недоступна

REAR BEARING 🛠️ 22	590619
SEP:SEPARATED REGULATOR -INC:BUILT-IN REGULATOR 🛠️ 02	182120
RECTIFIER OR DIODE BRIDGE ASSEMBLY 🛠️ 07	593182
PULLEY 🛠️ 11	593209
ROTOR 🛠️ 04	092968
STATOR 🛠️ 05	593278
Valeo	439614

A13N31

50 2 1V

14 ↻ 70° ▷ ∅ 60

Picture not available
Image non disponible
Imagen no disponible
Immagine non disponibile
Nicht verfügbares Bild
Brak zdjęcia
Картина недоступна

Picture not available
Image non disponible
Imagen no disponible
Immagine non disponibile
Nicht verfügbares Bild
Brak zdjęcia
Картина недоступна

SEP:SEPARATED REGULATOR -INC:BUILT-IN REGULATOR 🛠️ 02	
*2590558	
Valeo	432738

A13N33M

35 1

28 ↻ 22° ▷

Picture not available
Image non disponible
Imagen no disponible
Immagine non disponibile
Nicht verfügbares Bild
Brak zdjęcia
Картина недоступна

Picture not available
Image non disponible
Imagen no disponible
Immagine non disponibile
Nicht verfügbares Bild
Brak zdjęcia
Картина недоступна

PLASTIC CAPSULE 🛠️ 26	590629
FRONT BEARING 🛠️ 21	592780
REAR BEARING 🛠️ 22	590613
PROTECTION COVER 🛠️ 24	590564
BRUSH HOLDER 🛠️ 09	092967
SEP:SEPARATED REGULATOR -INC:BUILT-IN REGULATOR 🛠️ 02	590536
RECTIFIER OR DIODE BRIDGE ASSEMBLY 🛠️ 07	593199
Valeo	510397

A13N34

55 1

14 ↻ 22° ▷

Picture not available
Image non disponible
Imagen no disponible
Immagine non disponibile
Nicht verfügbares Bild
Brak zdjęcia
Картина недоступна

Picture not available
Image non disponible
Imagen no disponible
Immagine non disponibile
Nicht verfügbares Bild
Brak zdjęcia
Картина недоступна

PLASTIC CAPSULE 🛠️ 26	590629
FRONT BEARING 🛠️ 21	592780
REAR BEARING 🛠️ 22	590613
PROTECTION COVER 🛠️ 24	590564
SEP:SEPARATED REGULATOR -INC:BUILT-IN REGULATOR 🛠️ 02	593129
RECTIFIER OR DIODE BRIDGE ASSEMBLY 🛠️ 07	593199
STATOR 🛠️ 05	100930
Valeo	104551

A13N35M

35 1

14 ↻ 20° ▷

Picture not available
Image non disponible
Imagen no disponible
Immagine non disponibile
Nicht verfügbares Bild
Brak zdjęcia
Картина недоступна

Picture not available
Image non disponible
Imagen no disponible
Immagine non disponibile
Nicht verfügbares Bild
Brak zdjęcia
Картина недоступна

PLASTIC CAPSULE 🛠️ 26	590629
FRONT BEARING 🛠️ 21	593224
REAR BEARING 🛠️ 22	590613
PROTECTION COVER 🛠️ 24	590564
BRUSH HOLDER 🛠️ 09	092967
SEP:SEPARATED REGULATOR -INC:BUILT-IN REGULATOR 🛠️ 02	590512
RECTIFIER OR DIODE BRIDGE ASSEMBLY 🛠️ 07	593199
FAN 🛠️ 12	592673
FAN 🛠️ 12	590553
STATOR 🛠️ 05	101339
Valeo	103141

A13N36M

30 1

28 ↻ 20° ▷

Picture not available
Image non disponible
Imagen no disponible
Immagine non disponibile
Nicht verfügbares Bild
Brak zdjęcia
Картина недоступна

Picture not available
Image non disponible
Imagen no disponible
Immagine non disponibile
Nicht verfügbares Bild
Brak zdjęcia
Картина недоступна

PLASTIC CAPSULE 🛠️ 26	590629
FRONT BEARING 🛠️ 21	593224
REAR BEARING 🛠️ 22	590613
PROTECTION COVER 🛠️ 24	590564
BRUSH HOLDER 🛠️ 09	092967
SEP:SEPARATED REGULATOR -INC:BUILT-IN REGULATOR 🛠️ 02	590536
RECTIFIER OR DIODE BRIDGE ASSEMBLY 🛠️ 07	593199
Valeo	592777

A13N38

50

1

1V

14



45°

Ø 59,7

INC



PLASTIC CAPSULE 26 590627
REAR BEARING 22 590568
PROTECTION COVER 24 590564
SEP:SEPARATED REGULATOR -INC:BUILT-IN REGULATOR 02 182120
RECTIFIER OR DIODE BRIDGE ASSEMBLY 07 105754
FAN 12 592673
FAN 12 590553
PULLEY 11 593253
ROTOR 04 092968
STATOR 05 100930

A13N38

50

1

1V

14



45°

Ø 59,7

INC



PLASTIC CAPSULE 26 590627
REAR BEARING 22 590568
PROTECTION COVER 24 590564
SEP:SEPARATED REGULATOR -INC:BUILT-IN REGULATOR 02 182120
RECTIFIER OR DIODE BRIDGE ASSEMBLY 07 105754
FAN 12 592673
FAN 12 590553
PULLEY 11 593253
ROTOR 04 092968
STATOR 05 100930

A13N38

50

1

1V

14



45°

Ø 59,7

INC



PLASTIC CAPSULE 26 590627
REAR BEARING 22 590568
PROTECTION COVER 24 590564
SEP:SEPARATED REGULATOR -INC:BUILT-IN REGULATOR 02 182120
RECTIFIER OR DIODE BRIDGE ASSEMBLY 07 105754
FAN 12 592673
FAN 12 590553
PULLEY 11 593253
ROTOR 04 092968
STATOR 05 100930

Valeo**432739/433358****A13N42**

50

2

1V

14



20°

Ø 59,7

INC



PLASTIC CAPSULE 26 590627
REAR BEARING 22 590568
PROTECTION COVER 24 590564
SEP:SEPARATED REGULATOR -INC:BUILT-IN REGULATOR 02 182120
FAN 12 592673
FAN 12 590553
PULLEY 11 593253
ROTOR 04 092968
STATOR 05 100930

Valeo**432746/433374****A13N43**

50

1

1V

14



45°

Ø 59,7

INC



SEP:SEPARATED REGULATOR -INC:BUILT-IN REGULATOR 02
 *2590558

Valeo**432739/433358****A13N44T**

50

2

SP

14



0°

Picture not available
 Image non disponible
 Imagen no disponible
 Immagine non disponibile
 Nicht verfügbares Bild
 Brak zdjęć
 Картина недоступна

Picture not available
 Image non disponible
 Imagen no disponible
 Immagine non disponibile
 Nicht verfügbares Bild
 Brak zdjęć
 Картина недоступна

BRUSH HOLDER 09

300850

Valeo**105111/436354****A13N45T**

35

2

28



20°

Picture not available
 Image non disponible
 Imagen no disponible
 Immagine non disponibile
 Nicht verfügbares Bild
 Brak zdjęć
 Картина недоступна

Picture not available
 Image non disponible
 Imagen no disponible
 Immagine non disponibile
 Nicht verfügbares Bild
 Brak zdjęć
 Картина недоступна

BRUSH HOLDER 09

300850

Valeo**105112/436353**

A13N46

50 1 1V

14 ↻ 42° ∅ 60 INC

Picture not available
Image non disponible
Imagen no disponible
Immagine non disponibile
Nicht verfügbares Bild
Brak zdjęcia
Картина недоступна

Picture not available
Image non disponible
Imagen no disponible
Immagine non disponibile
Nicht verfügbares Bild
Brak zdjęcia
Картина недоступна

PLASTIC CAPSULE 🛠️ 26 590627
PROTECTION COVER 🛠️ 24 590564
SEP:SEPARATED REGULATOR -INC:BUILT-IN REGULATOR 🛠️ 02 182120
FAN 🛠️ 12 592673
FAN 🛠️ 12 590553
PULLEY 🛠️ 11 097140
ROTOR 🛠️ 04 300846
STATOR 🛠️ 05 100930
Valeo 432747/433404

A13N49

50 1 1V

14 ↻ 20° ∅ 69,6 INC

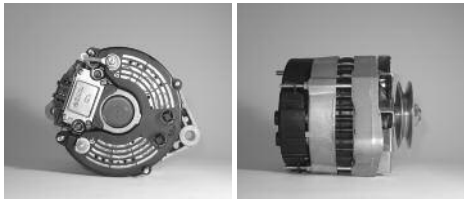

SEP:SEPARATED REGULATOR -INC:BUILT-IN REGULATOR 🛠️ 02
 *2590558
Valeo 432749/433407

A13N4T

40 2 2V

28 ↻ 20° ∅ 65

Picture not available
Image non disponible
Imagen no disponible
Immagine non disponibile
Nicht verfügbares Bild
Brak zdjęcia
Картина недоступна

Picture not available
Image non disponible
Imagen no disponible
Immagine non disponibile
Nicht verfügbares Bild
Brak zdjęcia
Картина недоступна

PROTECTION COVER 🛠️ 24 590564
SEP:SEPARATED REGULATOR -INC:BUILT-IN REGULATOR 🛠️ 02 590640
RECTIFIER OR DIODE BRIDGE ASSEMBLY 🛠️ 07 101342
PULLEY 🛠️ 11 101054
HARDWARE OF PULLEY 🛠️ 13 300767
STATOR 🛠️ 05 101339
Valeo 100363/436347

A13N50

50 2 1V

14 ↻ 70° ∅ 55,4 INC



PLASTIC CAPSULE 🛠️ 26 590627
REAR BEARING 🛠️ 22 590568
PROTECTION COVER 🛠️ 24 590564
BRUSH HOLDER 🛠️ 09 092859
SEP:SEPARATED REGULATOR -INC:BUILT-IN REGULATOR 🛠️ 02
 *2590558
RECTIFIER OR DIODE BRIDGE ASSEMBLY 🛠️ 07 180593
ROTOR 🛠️ 04 300846
STATOR 🛠️ 05 100930
Valeo 432753/433446

A13N51

40

28 ↻

Picture not available
Image non disponible
Imagen no disponible
Immagine non disponibile
Nicht verfügbares Bild
Brak zdjęcia
Картина недоступна

Picture not available
Image non disponible
Imagen no disponible
Immagine non disponibile
Nicht verfügbares Bild
Brak zdjęcia
Картина недоступна

PLASTIC CAPSULE 🛠️ 26 590627
FRONT BEARING 🛠️ 21 593224
REAR BEARING 🛠️ 22 590619
SEP:SEPARATED REGULATOR -INC:BUILT-IN REGULATOR 🛠️ 02 590640
CONDENSOR 🛠️ 14 517022
STATOR 🛠️ 05 101339
Valeo 101823

A13N52

50

14 ↻

Picture not available
Image non disponible
Imagen no disponible
Immagine non disponibile
Nicht verfügbares Bild
Brak zdjęcia
Картина недоступна

Picture not available
Image non disponible
Imagen no disponible
Immagine non disponibile
Nicht verfügbares Bild
Brak zdjęcia
Картина недоступна

PLASTIC CAPSULE 🛠️ 26 590627
FRONT BEARING 🛠️ 21 593224
REAR BEARING 🛠️ 22 590619
SEP:SEPARATED REGULATOR -INC:BUILT-IN REGULATOR 🛠️ 02 182007
CONDENSOR 🛠️ 14 517022
ROTOR 🛠️ 04 593273
STATOR 🛠️ 05 593278
Valeo 101822

A13N53

50

2

1V

14 ↻ 60° ∅ 63,25 SEP

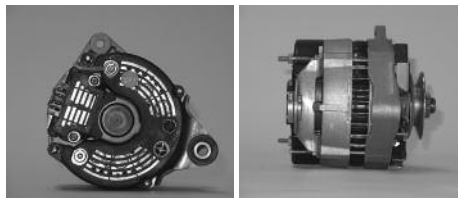

SEP:SEPARATED REGULATOR -INC:BUILT-IN REGULATOR 🛠️ 02
 *2590558
Valeo 432771/433426

A13N55M

35

1

14 ↻ 20°

Picture not available
Image non disponible
Imagen no disponible
Immagine non disponibile
Nicht verfügbares Bild
Brak zdjęcia
Картина недоступна

Picture not available
Image non disponible
Imagen no disponible
Immagine non disponibile
Nicht verfügbares Bild
Brak zdjęcia
Картина недоступна

PLASTIC CAPSULE 🛠️ 26 590629
FRONT BEARING 🛠️ 21 593224
REAR BEARING 🛠️ 22 590613
PROTECTION COVER 🛠️ 24 590564
BRUSH HOLDER 🛠️ 09 092967
SEP:SEPARATED REGULATOR -INC:BUILT-IN REGULATOR 🛠️ 02 590512
RECTIFIER OR DIODE BRIDGE ASSEMBLY 🛠️ 07 593199
STATOR 🛠️ 05 101339
Valeo 105582

A13N56M

40

2

28



20°

Picture not available
Image non disponible
Imagen no disponible
Immagine non disponibile
Nicht verfügbares Bild
Brak zdjęcia
Картина недоступна

Picture not available
Image non disponible
Imagen no disponible
Immagine non disponibile
Nicht verfügbares Bild
Brak zdjęcia
Картина недоступна

PLASTIC CAPSULE 26	590629
FRONT BEARING 21	592860
REAR BEARING 22	590613
PROTECTION COVER 24	590564
BRUSH HOLDER 09	092967
SEP:SEPARATED REGULATOR -INC:BUILT-IN REGULATOR 02	182169
RECTIFIER OR DIODE BRIDGE ASSEMBLY 07	102556
FAN 12	592673
STATOR 05	101339

Valeo**100363/436352****A13N57M**

35

1

14



25°

Picture not available
Image non disponible
Imagen no disponible
Immagine non disponibile
Nicht verfügbares Bild
Brak zdjęcia
Картина недоступна

Picture not available
Image non disponible
Imagen no disponible
Immagine non disponibile
Nicht verfügbares Bild
Brak zdjęcia
Картина недоступна

PLASTIC CAPSULE 26	590629
FRONT BEARING 21	593224
REAR BEARING 22	590613
PROTECTION COVER 24	590564
BRUSH HOLDER 09	092967
SEP:SEPARATED REGULATOR -INC:BUILT-IN REGULATOR 02	590512
RECTIFIER OR DIODE BRIDGE ASSEMBLY 07	593199
FAN 12	592673
FAN 12	590553
STATOR 05	101339

Valeo**103142****A13N58M**

50

2

14



20°

Picture not available
Image non disponible
Imagen no disponible
Immagine non disponibile
Nicht verfügbares Bild
Brak zdjęcia
Картина недоступна

Picture not available
Image non disponible
Imagen no disponible
Immagine non disponibile
Nicht verfügbares Bild
Brak zdjęcia
Картина недоступна

FRONT BEARING 21	592860
PROTECTION COVER 24	590564
BRUSH HOLDER 09	092967
FAN 12	592673

Valeo**102053****A13N59M**

40

2

28



20°

Picture not available
Image non disponible
Imagen no disponible
Immagine non disponibile
Nicht verfügbares Bild
Brak zdjęcia
Картина недоступна

Picture not available
Image non disponible
Imagen no disponible
Immagine non disponibile
Nicht verfügbares Bild
Brak zdjęcia
Картина недоступна

FRONT BEARING 21	592860
REAR BEARING 22	590613
PROTECTION COVER 24	590564
BRUSH HOLDER 09	092967
SEP:SEPARATED REGULATOR -INC:BUILT-IN REGULATOR 02	182169
FAN 12	592673
STATOR 05	101339

Valeo**102054****A13N6**

50

1

1V

14



45°

Ø 59,7

INC



PLASTIC CAPSULE 26	590627
REAR BEARING 22	590619
PROTECTION COVER 24	590564
BRUSH HOLDER 09	092859
SEP:SEPARATED REGULATOR -INC:BUILT-IN REGULATOR 02	*2590558
RECTIFIER OR DIODE BRIDGE ASSEMBLY 07	180593
FAN 12	592673
PULLEY 11	593253
ROTOR 04	092968
STATOR 05	100930

Valeo**432754/433416****A13N60T**

50

2

14



20°

Picture not available
Image non disponible
Imagen no disponible
Immagine non disponibile
Nicht verfügbares Bild
Brak zdjęcia
Картина недоступна

Picture not available
Image non disponible
Imagen no disponible
Immagine non disponibile
Nicht verfügbares Bild
Brak zdjęcia
Картина недоступна

FRONT BEARING 21	592860
REAR BEARING 22	590613
PROTECTION COVER 24	590564
BRUSH HOLDER 09	092859
FAN 12	592673

Valeo**102055**

A13N61T

40 2

28 ↻ 20°

Picture not available
Image non disponible
Imagen no disponible
Immagine non disponibile
Nicht verfügbares Bild
Brak zdjęcia
Картина недоступна

Picture not available
Image non disponible
Imagen no disponible
Immagine non disponibile
Nicht verfügbares Bild
Brak zdjęcia
Картина недоступна

FRONT BEARING 📏21 592860
PROTECTION COVER 📏24 590564
BRUSH HOLDER 📏09 300665
SEP:SEPARATED REGULATOR -INC:BUILT-IN REGULATOR 📏02092953
FAN 📏12 592673
STATOR 📏05 101339
Valeo 102056

A13N62

50 2 1V

14 ↻ 20° Ø 69,6

Picture not available
Image non disponible
Imagen no disponible
Immagine non disponibile
Nicht verfügbares Bild
Brak zdjęcia
Картина недоступна

Picture not available
Image non disponible
Imagen no disponible
Immagine non disponibile
Nicht verfügbares Bild
Brak zdjęcia
Картина недоступна

BRUSH HOLDER 📏09 300850
RECTIFIER OR DIODE BRIDGE ASSEMBLY 📏07 102817
Valeo 101728/436356

A13N64

50 2 1V

14 ↻ 20° Ø 66,7 INC



PLASTIC CAPSULE 📏26 590627
REAR BEARING 📏22 590619
PROTECTION COVER 📏24 590564
BRUSH HOLDER 📏09 092859
SEP:SEPARATED REGULATOR -INC:BUILT-IN REGULATOR 📏02
*2590558
RECTIFIER OR DIODE BRIDGE ASSEMBLY 📏07 180593
ROTOR 📏04 092985
STATOR 📏05 100930
Valeo 432755/436308

A13N65

50 2 1V

14 ↻ 0° Ø 63,25 INC



PLASTIC CAPSULE 📏26 590627
REAR BEARING 📏22 590568
PROTECTION COVER 📏24 590564
BRUSH HOLDER 📏09 092859
SEP:SEPARATED REGULATOR -INC:BUILT-IN REGULATOR 📏02

*2590558

RECTIFIER OR DIODE BRIDGE ASSEMBLY 📏07

180593

FAN 📏12 590553**PULLEY** 📏11 096882**ROTOR** 📏04 092968**STATOR** 📏05 100930**Valeo**

432756/433437

A13N66M

50 1

14 ↻

Picture not available
Image non disponible
Imagen no disponible
Immagine non disponibile
Nicht verfügbares Bild
Brak zdjęcia
Картина недоступна

Picture not available
Image non disponible
Imagen no disponible
Immagine non disponibile
Nicht verfügbares Bild
Brak zdjęcia
Картина недоступна

PLASTIC CAPSULE 📏26 590629
FRONT BEARING 📏21 593224
REAR BEARING 📏22 590613
PROTECTION COVER 📏24 590564
BRUSH HOLDER 📏09 092967
RECTIFIER OR DIODE BRIDGE ASSEMBLY 📏07 593199
FAN 📏12 592673
FAN 📏12 590553
Valeo 102341

A13N69

50 1 1V

14 ↻ 20° Ø 70

Picture not available
Image non disponible
Imagen no disponible
Immagine non disponibile
Nicht verfügbares Bild
Brak zdjęcia
Картина недоступна

Picture not available
Image non disponible
Imagen no disponible
Immagine non disponibile
Nicht verfügbares Bild
Brak zdjęcia
Картина недоступна

PLASTIC CAPSULE 📏26 590627
REAR BEARING 📏22 590619
PROTECTION COVER 📏24 590564
SEP:SEPARATED REGULATOR -INC:BUILT-IN REGULATOR 📏02
*2590558
RECTIFIER OR DIODE BRIDGE ASSEMBLY 📏07 102817
RECTIFIER OR DIODE BRIDGE ASSEMBLY 📏07 105135
FAN 📏12 592673
FAN 📏12 590553
ROTOR 📏04 092968
STATOR 📏05 100930
Valeo 433472

A13N76

50 1 2V

14 ↻ 20° Ø 77,3

Picture not available
Image non disponible
Imagen no disponible
Immagine non disponibile
Nicht verfügbares Bild
Brak zdjęcia
Картина недоступна

Picture not available
Image non disponible
Imagen no disponible
Immagine non disponibile
Nicht verfügbares Bild
Brak zdjęcia
Картина недоступна

PLASTIC CAPSULE 📏26 590627
REAR BEARING 📏22 590619
PROTECTION COVER 📏24 590564
SEP:SEPARATED REGULATOR -INC:BUILT-IN REGULATOR 📏02
*2590558
RECTIFIER OR DIODE BRIDGE ASSEMBLY 📏07 102817
RECTIFIER OR DIODE BRIDGE ASSEMBLY 📏07 105135
FAN 📏12 592673
FAN 📏12 590553
ROTOR 📏04 092968
STATOR 📏05 100930
Valeo 433474

A13N80	50	1	1V
14	↻	60°	Ø 59,7 INC

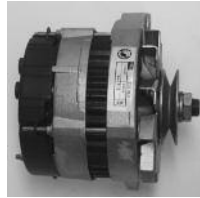

B+(M6)D+(M6)
D-(M5)

RECTIFIER OR DIODE BRIDGE ASSEMBLY 07 592840

A13N80	50	1	1V
14	↻	60°	Ø 59,7 INC



B+(M6)D+(M6)
D-(M5)

RECTIFIER OR DIODE BRIDGE ASSEMBLY 07 592840

Valeo 432772/436102

A13N81	50	2	1V
14	↻	0°	Ø 59,7 INC

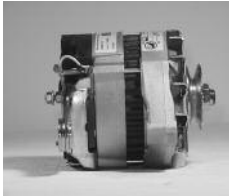

SEP:SEPARATED REGULATOR -INC:BUILT-IN REGULATOR 02

*2590558

Valeo 432764/433447

A13N83	50	1	1V
14	↻	40°	Ø 59,7 SEP



PLASTIC CAPSULE 26 590627

REAR BEARING 22 590619

PROTECTION COVER 24 590564

SEP:SEPARATED REGULATOR -INC:BUILT-IN REGULATOR 02 182120

RECTIFIER OR DIODE BRIDGE ASSEMBLY 07 105754

FAN 12 592673

FAN 12 590553

PULLEY 11 593253

ROTOR 04 092968

STATOR 05 100930

Valeo 433384

A13N84	50	1	1V
14	↻	20°	Ø 66

Picture not available
Image non disponible
Imagen no disponible
Immagine non disponibile
Nicht verfügbares Bild
Brak zdjęcia
Картина недоступна

Picture not available
Image non disponible
Imagen no disponible
Immagine non disponibile
Nicht verfügbares Bild
Brak zdjęcia
Картина недоступна

PLASTIC CAPSULE 26 590627

REAR BEARING 22 590619

PROTECTION COVER 24 590564

FAN 12 592673

FRONT HOUSING 31 095190

PULLEY 11 096879

ROTOR 04 092968

STATOR 05 100930

Valeo 433075

A13N85	60	1	1V
14	↻	0°	Ø 59,7 INC



SEP:SEPARATED REGULATOR -INC:BUILT-IN REGULATOR 02

*2590558

A13N85	60	1	1V
14	↻	0°	Ø 59,7 INC



SEP:SEPARATED REGULATOR -INC:BUILT-IN REGULATOR 02

*2590558

Valeo 432759/433418

A13N86	60	2	4V
14	↻	0°	Ø 71,16 INC



PLASTIC CAPSULE 26 590627

PROTECTION COVER 24 590564

BRUSH HOLDER 09 092859

SEP:SEPARATED REGULATOR -INC:BUILT-IN REGULATOR 02

*2590558

RECTIFIER OR DIODE BRIDGE ASSEMBLY 07 180593

FAN 12 592673

ROTOR 04 092968

A13N86	60	2	4V
14	↻	0°	Ø 71,16 INC

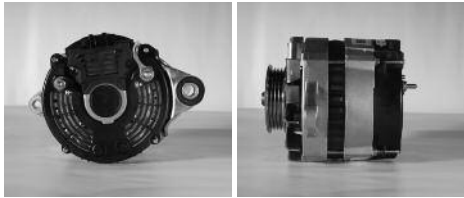

PLASTIC CAPSULE 26 590627
PROTECTION COVER 24 590564
BRUSH HOLDER 09 092859
SEP:SEPARATED REGULATOR -INC:BUILT-IN REGULATOR 02
 *2590558
RECTIFIER OR DIODE BRIDGE ASSEMBLY 07 180593
FAN 12 592673
ROTOR 04 092968
Valeo **432763/433445**

A13N87	60	2	1V
14	↻	0°	Ø 59,7 INC



PLASTIC CAPSULE 26 590627
REAR BEARING 22 590568
PROTECTION COVER 24 590564
SEP:SEPARATED REGULATOR -INC:BUILT-IN REGULATOR 02
 *2590558
FAN 12 592673
PULLEY 11 096880
ROTOR 04 092968
Valeo **432764/433448**

A13N88	60	2	1V
14	↻	0°	Ø 59,7 INC



SEP:SEPARATED REGULATOR -INC:BUILT-IN REGULATOR 02
 *2590558

A13N88	60	2	1V
14	↻	0°	Ø 59,7 INC

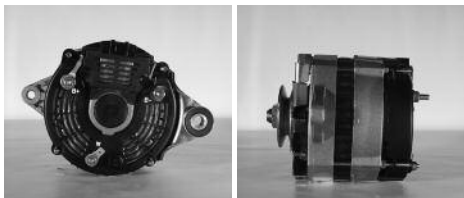

SEP:SEPARATED REGULATOR -INC:BUILT-IN REGULATOR 02
 *2590558
Valeo **432764/433448**

A13N89	60	2	5V
14	↻	0°	Ø 62,9 INC

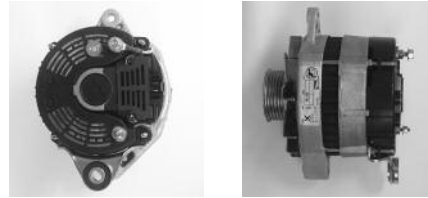

PLASTIC CAPSULE 26 590627
REAR BEARING 22 590619
PROTECTION COVER 24 590564
BRUSH HOLDER 09 092859
SEP:SEPARATED REGULATOR -INC:BUILT-IN REGULATOR 02
 *2590558
RECTIFIER OR DIODE BRIDGE ASSEMBLY 07 180593
FAN 12 592673
ROTOR 04 092968
Valeo **432765/433444**

A13N90	50	2	1V
14	↻	60°	Ø 59,7 INC



SEP:SEPARATED REGULATOR -INC:BUILT-IN REGULATOR 02
 *2590558

A13N90	50	2	1V
14	↻	60°	Ø 59,7 INC



SEP:SEPARATED REGULATOR -INC:BUILT-IN REGULATOR 02
 *2590558
Valeo **432766/433430**

A13N91	50	1	1V
14	↻	60°	Ø 59,7 INC



SEP:SEPARATED REGULATOR -INC:BUILT-IN REGULATOR 02
 *2590558
Valeo **432736/433411**

A13N92

50

2

1V

14



60°

Ø 60

INC

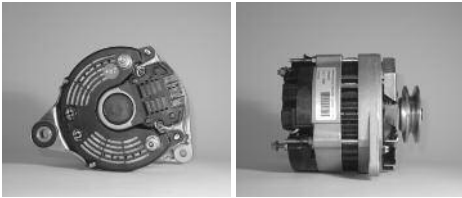
**SEP:SEPARATED REGULATOR -INC:BUILT-IN REGULATOR** 02

*2590558

Valeo**432719/436312****A13N93**

50

2

14



60°

Picture not available
Image non disponible
Imagen no disponible
Immagine non disponibile
Nicht verfügbares Bild
Brak zdjęcia
Картина недоступна

Picture not available
Image non disponible
Imagen no disponible
Immagine non disponibile
Nicht verfügbares Bild
Brak zdjęcia
Картина недоступна

PLASTIC CAPSULE 26

590627

REAR BEARING 22

590568

PROTECTION COVER 24

590564

SEP:SEPARATED REGULATOR -INC:BUILT-IN REGULATOR 02

593129

FAN 12

592673

FAN 12

590553

ROTOR 04

092968

STATOR 05

100930

Valeo**432767/436747****A13N94+**

70

1

1V

14



45°

Ø 69,6

INC

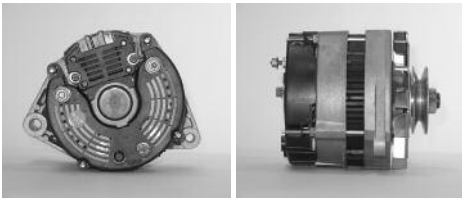
**PLASTIC CAPSULE** 26

590627

REAR BEARING 22

590568

PROTECTION COVER 24

590564

SEP:SEPARATED REGULATOR -INC:BUILT-IN REGULATOR 02

182120

FAN 12

592673

ROTOR 04

092968

HARDWARE OF PULLEY 13

300767

STATOR 05

592830

Valeo**432768/433358****A13N95**

50

2

4V

14



20°

Ø 59,4

INC

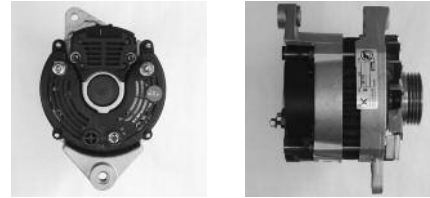
**PLASTIC CAPSULE** 26

590627

REAR BEARING 22

590568

PROTECTION COVER 24

590564

SEP:SEPARATED REGULATOR -INC:BUILT-IN REGULATOR 02

182120

RECTIFIER OR DIODE BRIDGE ASSEMBLY 07

592840

FAN 12

592673

FAN 12

590553

ROTOR 04

590639

STATOR 05

100930

Valeo**432769/433364****A13N97**

60

2

14



0°

Picture not available
Image non disponible
Imagen no disponible
Immagine non disponibile
Nicht verfügbares Bild
Brak zdjęcia
Картина недоступна

Picture not available
Image non disponible
Imagen no disponible
Immagine non disponibile
Nicht verfügbares Bild
Brak zdjęcia
Картина недоступна

PLASTIC CAPSULE 26

590627

REAR BEARING 22

590568

PROTECTION COVER 24

590564

BRUSH HOLDER 09

092859

SEP:SEPARATED REGULATOR -INC:BUILT-IN REGULATOR 02

*2590558

RECTIFIER OR DIODE BRIDGE ASSEMBLY 07

180593

FAN 12

592673

ROTOR 04

092968

Valeo**105789****A13R10L**

40

2

1V

14



Ø 70

Picture not available
Image non disponible
Imagen no disponible
Immagine non disponibile
Nicht verfügbares Bild
Brak zdjęcia
Картина недоступна

Picture not available
Image non disponible
Imagen no disponible
Immagine non disponibile
Nicht verfügbares Bild
Brak zdjęcia
Картина недоступна

BRUSH HOLDER 09

056473

BRUSH SET 09a

073742

Valeo**105111/436354****A13R111LT**

40

2

2V

14



Ø 76

Picture not available
Image non disponible
Imagen no disponible
Immagine non disponibile
Nicht verfügbares Bild
Brak zdjęcia
Картина недоступна

Picture not available
Image non disponible
Imagen no disponible
Immagine non disponibile
Nicht verfügbares Bild
Brak zdjęcia
Картина недоступна

BRUSH HOLDER 09

056473

Valeo**105111/436354**

A13R121

55 1 1V

14 ↻ 60°

Picture not available
Image non disponible
Imagen no disponible
Immagine non disponibile
Nicht verfügbares Bild
Brak zdjęcia
Картина недоступна

Picture not available
Image non disponible
Imagen no disponible
Immagine non disponibile
Nicht verfügbares Bild
Brak zdjęcia
Картина недоступна

RECTIFIER OR DIODE BRIDGE ASSEMBLY 09 07

079649

Valeo**432772/436101****A13R122**

55 2 1V

14 ↻ Ø 70

Picture not available
Image non disponible
Imagen no disponible
Immagine non disponibile
Nicht verfügbares Bild
Brak zdjęcia
Картина недоступна

Picture not available
Image non disponible
Imagen no disponible
Immagine non disponibile
Nicht verfügbares Bild
Brak zdjęcia
Картина недоступна

BRUSH HOLDER 09

056473

Valeo**101728/436356****A13R129**

36 1 1V

14 ↻ SEP

**BRUSH HOLDER** 09

095788

RECTIFIER OR DIODE BRIDGE ASSEMBLY 07

079649

Valeo**433384****A13R141**

50 2 1V

14 ↻ 60° Ø 63

Picture not available
Image non disponible
Imagen no disponible
Immagine non disponibile
Nicht verfügbares Bild
Brak zdjęcia
Картина недоступна

Picture not available
Image non disponible
Imagen no disponible
Immagine non disponibile
Nicht verfügbares Bild
Brak zdjęcia
Картина недоступна

BRUSH HOLDER 09

095984

RECTIFIER OR DIODE BRIDGE ASSEMBLY 07

079649

Valeo**432771/433427****A13R145**

35 1 1V

14 ↻ 20° Ø 61,5

Picture not available
Image non disponible
Imagen no disponible
Immagine non disponibile
Nicht verfügbares Bild
Brak zdjęcia
Картина недоступна

Picture not available
Image non disponible
Imagen no disponible
Immagine non disponibile
Nicht verfügbares Bild
Brak zdjęcia
Картина недоступна

BRUSH HOLDER 09

095984

RECTIFIER OR DIODE BRIDGE ASSEMBLY 07

079649

Valeo**432770/433388****A13R150**

55 2 1V

14 ↻ 60° Ø 61,8 INC

**BRUSH HOLDER** 09

095984

RECTIFIER OR DIODE BRIDGE ASSEMBLY 07

079649

Valeo**432719/436312****A13R152**

50 1 1V

14 ↻ 20° Ø 66 SEP

**BRUSH HOLDER** 09

095984

RECTIFIER OR DIODE BRIDGE ASSEMBLY 07

079649

Valeo**432715/433392****A13R159**

50 2

14 ↻ 20°

Picture not available
Image non disponible
Imagen no disponible
Immagine non disponibile
Nicht verfügbares Bild
Brak zdjęcia
Картина недоступна

Picture not available
Image non disponible
Imagen no disponible
Immagine non disponibile
Nicht verfügbares Bild
Brak zdjęcia
Картина недоступна

BRUSH HOLDER 09

095984

RECTIFIER OR DIODE BRIDGE ASSEMBLY 07

079649

Valeo**105111/436354****A13R160**

35 2

28 ↻ 20°

Picture not available
Image non disponible
Imagen no disponible
Immagine non disponibile
Nicht verfügbares Bild
Brak zdjęcia
Картина недоступна

Picture not available
Image non disponible
Imagen no disponible
Immagine non disponibile
Nicht verfügbares Bild
Brak zdjęcia
Картина недоступна

BRUSH HOLDER 09

095984

RECTIFIER OR DIODE BRIDGE ASSEMBLY 07

079649

Valeo**105112/436353****A13R168**

25 2 1V

28 ↻ 20° Ø 70

Picture not available
Image non disponible
Imagen no disponible
Immagine non disponibile
Nicht verfügbares Bild
Brak zdjęcia
Картина недоступна

Picture not available
Image non disponible
Imagen no disponible
Immagine non disponibile
Nicht verfügbares Bild
Brak zdjęcia
Картина недоступна

BRUSH HOLDER 09

056473

Valeo**105112/436353**

A13R170	35	1	1V
14		20°	Ø 66 SEP



BRUSH HOLDER 09 096026
RECTIFIER OR DIODE BRIDGE ASSEMBLY 07 079649
Valeo 432715/433392

A13R173	50	1	1V
14		20°	Ø 70



BRUSH HOLDER 09 092743
RECTIFIER OR DIODE BRIDGE ASSEMBLY 07 079649
Valeo 433472

A13R174	35	1	1V
14		40°	Ø 59,7 INC



BRUSH HOLDER 09 095984
RECTIFIER OR DIODE BRIDGE ASSEMBLY 07 079649
Valeo 433382

A13R175	35	1	1V
14		40°	Ø 59,7 SEP

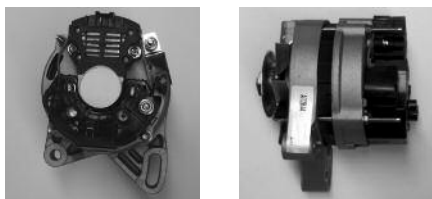

BRUSH HOLDER 09 096026
RECTIFIER OR DIODE BRIDGE ASSEMBLY 07 079649
Valeo 433384

A13R177	50	2	1V
14		70°	Ø 62,7



BRUSH HOLDER 09 095984
RECTIFIER OR DIODE BRIDGE ASSEMBLY 07 079649
Valeo 433425

A13R180	50	2	1V
14		70°	Ø 62,7



BRUSH HOLDER 09 095984
RECTIFIER OR DIODE BRIDGE ASSEMBLY 07 079649
Valeo 433425

A13R184	50	2	1V
14			Ø 66



BRUSH HOLDER 09 096026
RECTIFIER OR DIODE BRIDGE ASSEMBLY 07 079649
Valeo 432715

A13R187	35	1	1V
14		20°	Ø 70 SEP

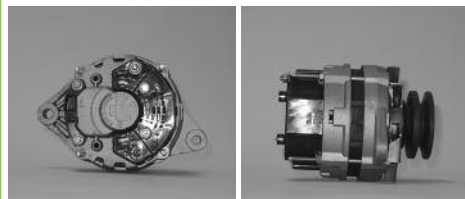

BRUSH HOLDER 09 096026
RECTIFIER OR DIODE BRIDGE ASSEMBLY 07 079649
Valeo 432714/433395

A13R189	50	2	1V
14		0°	Ø 59,7 INC

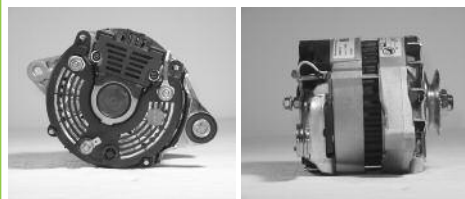

BRUSH HOLDER 09 095984
RECTIFIER OR DIODE BRIDGE ASSEMBLY 07 079649
Valeo 432764/433447

A13R190	70	2	1V
14		60°	Ø 61,8



BRUSH HOLDER 09 096334
RECTIFIER OR DIODE BRIDGE ASSEMBLY 07 079649
Valeo 432839

A13R191T	35	2	2V
28		20°	Ø 70

Picture not available
Image non disponible
Imagen no disponible
Immagine non disponibile
Nicht verfügbares Bild
Brak zdjęcia
Картина недоступна

Picture not available
Image non disponible
Imagen no disponible
Immagine non disponibile
Nicht verfügbares Bild
Brak zdjęcia
Картина недоступна

BRUSH HOLDER 09 095984
RECTIFIER OR DIODE BRIDGE ASSEMBLY 07 079649
Valeo 105112/436353

A13R194	40	1	1V
14		42°	Ø 70 INC

Picture not available
Image non disponible
Imagen no disponible
Immagine non disponibile
Nicht verfügbares Bild
Brak zdjęcia
Картина недоступна

Picture not available
Image non disponible
Imagen no disponible
Immagine non disponibile
Nicht verfügbares Bild
Brak zdjęcia
Картина недоступна

BRUSH HOLDER 09 096334
RECTIFIER OR DIODE BRIDGE ASSEMBLY 07 079649
Valeo 432747/433404

A13R195	45	1	1V
14		42°	Ø 70 INC

Picture not available
Image non disponible
Imagen no disponible
Immagine non disponibile
Nicht verfügbares Bild
Brak zdjęcia
Картина недоступна

Picture not available
Image non disponible
Imagen no disponible
Immagine non disponibile
Nicht verfügbares Bild
Brak zdjęcia
Картина недоступна

BRUSH HOLDER 09 095984
RECTIFIER OR DIODE BRIDGE ASSEMBLY 07 079649
Valeo 432747/433404

A13R201T	20	2	
28			

Picture not available
Image non disponible
Imagen no disponible
Immagine non disponibile
Nicht verfügbares Bild
Brak zdjęcia
Картина недоступна

Picture not available
Image non disponible
Imagen no disponible
Immagine non disponibile
Nicht verfügbares Bild
Brak zdjęcia
Картина недоступна

FRONT BEARING 21 079349
Valeo 097217

A13R202	45	1	1V
14		42°	Ø 93

Picture not available
Image non disponible
Imagen no disponible
Immagine non disponibile
Nicht verfügbares Bild
Brak zdjęcia
Картина недоступна

Picture not available
Image non disponible
Imagen no disponible
Immagine non disponibile
Nicht verfügbares Bild
Brak zdjęcia
Картина недоступна

BRUSH HOLDER 09 095984
RECTIFIER OR DIODE BRIDGE ASSEMBLY 07 079649
Valeo 433397

A13R205	35	1	1V
28		20°	Ø 59,7

Picture not available
Image non disponible
Imagen no disponible
Immagine non disponibile
Nicht verfügbares Bild
Brak zdjęcia
Картина недоступна

Picture not available
Image non disponible
Imagen no disponible
Immagine non disponibile
Nicht verfügbares Bild
Brak zdjęcia
Картина недоступна

BRUSH HOLDER 09 095984
RECTIFIER OR DIODE BRIDGE ASSEMBLY 07 079649
Valeo 105112/436353

A13R212	50	1	1V
14		60°	Ø 60 INC



BRUSH HOLDER 09 095984
RECTIFIER OR DIODE BRIDGE ASSEMBLY 07 079649
Valeo 432724/433429

A13R214	35	1	
28		0°	

Picture not available
Image non disponible
Imagen no disponible
Immagine non disponibile
Nicht verfügbares Bild
Brak zdjęcia
Картина недоступна

Picture not available
Image non disponible
Imagen no disponible
Immagine non disponibile
Nicht verfügbares Bild
Brak zdjęcia
Картина недоступна

PROTECTION COVER 24 098979
Valeo 102334/436355

A13R215	50	1	1V
14		42°	Ø 70 INC

Picture not available
Image non disponible
Imagen no disponible
Immagine non disponibile
Nicht verfügbares Bild
Brak zdjęcia
Картина недоступна

Picture not available
Image non disponible
Imagen no disponible
Immagine non disponibile
Nicht verfügbares Bild
Brak zdjęcia
Картина недоступна

BRUSH HOLDER 09 095984
RECTIFIER OR DIODE BRIDGE ASSEMBLY 07 079649
Valeo 432747/433404

A13R218	50	1	1V
14		45°	Ø 59,7 INC



PROTECTION COVER 24 098979
Valeo 432754/433416

A13R220	50	1	1V
14	↻	42°	Ø 70 INC

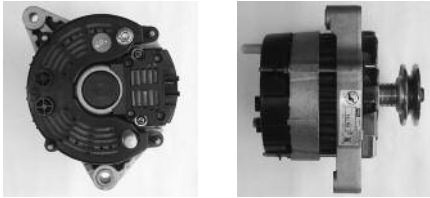

SEP:SEPARATED REGULATOR -INC:BUILT-IN REGULATOR 02300820
PROTECTION COVER 24 098979
Valeo 432748/433405

A13R221	50	2	1V
14	↻	20°	Ø 59,7 INC

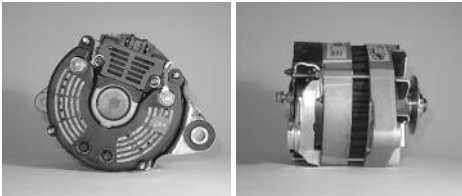

PROTECTION COVER 24 098979
Valeo 432728/4336313

A13R222	50	2	1V
14	↻	20°	Ø 69,6



PROTECTION COVER 24 098979
Valeo 432729/433438

A13R228	50	2	1V
14	↻	0°	Ø 59,7 INC

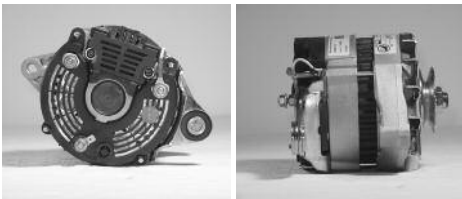

PROTECTION COVER 24 098979
Valeo 432764/433447

A13R230	50	2	1V
14	↻	60°	Ø 59,7 INC



PROTECTION COVER 24 098979
Valeo 432733/433430

A13R231	50	1	1V
14	↻	70°	Ø 59,7 INC

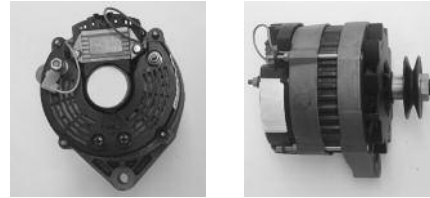

PROTECTION COVER 24 098979
Valeo 432735/433414

A13R242	50	2	1V
14	↻	60°	Ø 63,25



PROTECTION COVER 24 098979
Valeo 433435

A13R243	50	2	1V
14	↻	70°	Ø 55,4 INC

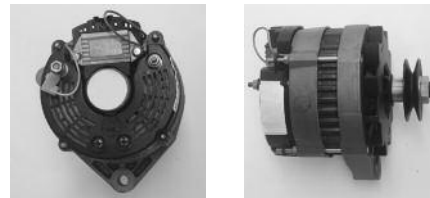

PROTECTION COVER 24 098979
Valeo 432735/433414

A13R244	45	1	1V
14	↻	20°	Ø 70



PROTECTION COVER 24 098979
Valeo 433373

A13R245	55	2	1V
14	↻	60°	Ø 66,5 INC

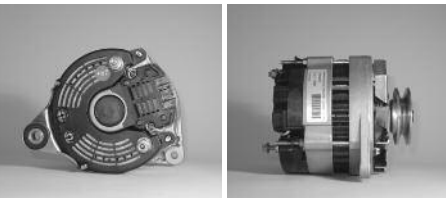

PROTECTION COVER 24 098979
Valeo 432719/436312



A13R255

70 2 1V

14 ↻ 60° ▷ ∅ 63,25

Picture not available
Image non disponible
Imagen no disponible
Immagine non disponibile
Nicht verfügbares Bild
Brak zdjęcia
Картина недоступна

Picture not available
Image non disponible
Imagen no disponible
Immagine non disponibile
Nicht verfügbares Bild
Brak zdjęcia
Картина недоступна

PROTECTION COVER 📄 24098979
433435**Valeo****A13R260**

50 2 1V

14 ↻ 0° ▷ ∅ 63,25 INC

**PROTECTION COVER** 📄 24098979
432756/433437**Valeo****A13R262**

50 1 1V

14 ↻ 42° ▷ ∅ 60 INC

Picture not available
Image non disponible
Imagen no disponible
Immagine non disponibile
Nicht verfügbares Bild
Brak zdjęcia
Картина недоступна

Picture not available
Image non disponible
Imagen no disponible
Immagine non disponibile
Nicht verfügbares Bild
Brak zdjęcia
Картина недоступна

SEP:SEPARATED REGULATOR -INC:BUILT-IN REGULATOR 📄 02300820**PROTECTION COVER** 📄 24098979
432747/433404**Valeo****A13R263**

50 1 1V

14 ↻ 42° ▷ ∅ 60 INC

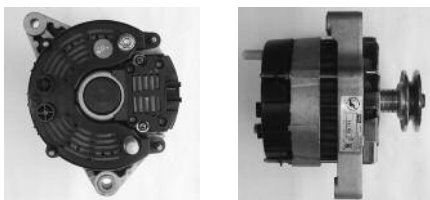
**SEP:SEPARATED REGULATOR -INC:BUILT-IN REGULATOR** 📄 02300820**PROTECTION COVER** 📄 24098979
432748/433405**Valeo****A13R265**

50 2 1V

14 ↻ 20° ▷ ∅ 66 SEP

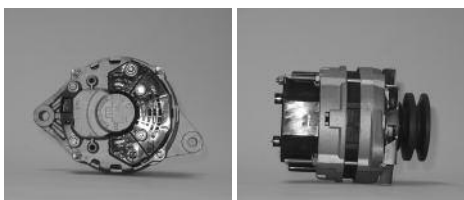
**BRUSH HOLDER** 📄 09**RECTIFIER OR DIODE BRIDGE ASSEMBLY** 📄 07096026
079649
432714/433395**Valeo****A13R269**

50 2 1V

14 ↻ 0° ▷ ∅ 59,7 INC

**SEP:SEPARATED REGULATOR -INC:BUILT-IN REGULATOR** 📄 02

*2590558

PROTECTION COVER 📄 24098979
432764/433447**Valeo****A13R270**

50 2 1V

14 ↻ 60° ▷ ∅ 59,7 INC

**SEP:SEPARATED REGULATOR -INC:BUILT-IN REGULATOR** 📄 02

*2590558

PROTECTION COVER 📄 24098979
432733/433430**Valeo****A13R43L**

40 2 1V

14 ↻ 20° ▷ ∅ 70

Picture not available
Image non disponible
Imagen no disponible
Immagine non disponibile
Nicht verfügbares Bild
Brak zdjęcia
Картина недоступна

Picture not available
Image non disponible
Imagen no disponible
Immagine non disponibile
Nicht verfügbares Bild
Brak zdjęcia
Картина недоступна

BRUSH HOLDER 📄 09056473
101728/436356**Valeo****A13R47LT**

40 2 1V

14 ↻ ∅ 86

Picture not available
Image non disponible
Imagen no disponible
Immagine non disponibile
Nicht verfügbares Bild
Brak zdjęcia
Картина недоступна

Picture not available
Image non disponible
Imagen no disponible
Immagine non disponibile
Nicht verfügbares Bild
Brak zdjęcia
Картина недоступна

BRUSH HOLDER 📄 09056473
105111/436354**Valeo****A13R49LT**

40 2 1V

14 ↻ ∅ 71,6

Picture not available
Image non disponible
Imagen no disponible
Immagine non disponibile
Nicht verfügbares Bild
Brak zdjęcia
Картина недоступна

Picture not available
Image non disponible
Imagen no disponible
Immagine non disponibile
Nicht verfügbares Bild
Brak zdjęcia
Картина недоступна

BRUSH HOLDER 📄 09056473
105111/436354**Valeo**

A13R55L 65 2 1V
14 ↻ ∅ 86

Picture not available
Image non disponible
Imagen no disponible
Immagine non disponibile
Nicht verfügbares Bild
Brak zdjęć
Картина недоступна

Picture not available
Image non disponible
Imagen no disponible
Immagine non disponibile
Nicht verfügbares Bild
Brak zdjęć
Картина недоступна

BRUSH HOLDER 09 056473
Valeo 105111/436354

A13R61LT 30 2 1V
28 ↻ ∅ 71,6

Picture not available
Image non disponible
Imagen no disponible
Immagine non disponibile
Nicht verfügbares Bild
Brak zdjęć
Картина недоступна

Picture not available
Image non disponible
Imagen no disponible
Immagine non disponibile
Nicht verfügbares Bild
Brak zdjęć
Картина недоступна

BRUSH HOLDER 09 056473
Valeo 105112/436353

A13R80T 55 2 1V
14 ↻ ∅ 86

Picture not available
Image non disponible
Imagen no disponible
Immagine non disponibile
Nicht verfügbares Bild
Brak zdjęć
Картина недоступна

Picture not available
Image non disponible
Imagen no disponible
Immagine non disponibile
Nicht verfügbares Bild
Brak zdjęć
Картина недоступна

BRUSH HOLDER 09 096334
RECTIFIER OR DIODE BRIDGE ASSEMBLY 07 079649
Valeo 105111/436354

A13R83T 40 2 2V
14 ↻

Picture not available
Image non disponible
Imagen no disponible
Immagine non disponibile
Nicht verfügbares Bild
Brak zdjęć
Картина недоступна

Picture not available
Image non disponible
Imagen no disponible
Immagine non disponibile
Nicht verfügbares Bild
Brak zdjęć
Картина недоступна

BRUSH HOLDER 09 095984
RECTIFIER OR DIODE BRIDGE ASSEMBLY 07 079649
Valeo 105111/436354

A13R85T 35 2 1V
28 ↻ ∅ 86

Picture not available
Image non disponible
Imagen no disponible
Immagine non disponibile
Nicht verfügbares Bild
Brak zdjęć
Картина недоступна

Picture not available
Image non disponible
Imagen no disponible
Immagine non disponibile
Nicht verfügbares Bild
Brak zdjęć
Картина недоступна

BRUSH HOLDER 09 095984
RECTIFIER OR DIODE BRIDGE ASSEMBLY 07 079649
Valeo 105112/436353

A13R86T 40 2 1V
14 ↻

Picture not available
Image non disponible
Imagen no disponible
Immagine non disponibile
Nicht verfügbares Bild
Brak zdjęć
Картина недоступна

Picture not available
Image non disponible
Imagen no disponible
Immagine non disponibile
Nicht verfügbares Bild
Brak zdjęć
Картина недоступна

BRUSH HOLDER 09 095984
RECTIFIER OR DIODE BRIDGE ASSEMBLY 07 079649
Valeo 105111/436354

A13R87 35 2 1V
28 ↻ 20° ∅ 55,4

Picture not available
Image non disponible
Imagen no disponible
Immagine non disponibile
Nicht verfügbares Bild
Brak zdjęć
Картина недоступна

Picture not available
Image non disponible
Imagen no disponible
Immagine non disponibile
Nicht verfügbares Bild
Brak zdjęć
Картина недоступна

BRUSH HOLDER 09 096026
RECTIFIER OR DIODE BRIDGE ASSEMBLY 07 079649
Valeo 105112/436353

A13R88T 35 2 1V
28 ↻

Picture not available
Image non disponible
Imagen no disponible
Immagine non disponibile
Nicht verfügbares Bild
Brak zdjęć
Картина недоступна

Picture not available
Image non disponible
Imagen no disponible
Immagine non disponibile
Nicht verfügbares Bild
Brak zdjęć
Картина недоступна

BRUSH HOLDER 09 095984
RECTIFIER OR DIODE BRIDGE ASSEMBLY 07 079649
Valeo 105112/436353

A13R89T 35 2 2V
28 ↻ ∅ 76

Picture not available
Image non disponible
Imagen no disponible
Immagine non disponibile
Nicht verfügbares Bild
Brak zdjęć
Картина недоступна

Picture not available
Image non disponible
Imagen no disponible
Immagine non disponibile
Nicht verfügbares Bild
Brak zdjęć
Картина недоступна

BRUSH HOLDER 09 095984
RECTIFIER OR DIODE BRIDGE ASSEMBLY 07 079649
Valeo 105112/436353

A13R91LT 30 2 2V
28 ↻ ∅ 76

Picture not available
Image non disponible
Imagen no disponible
Immagine non disponibile
Nicht verfügbares Bild
Brak zdjęć
Картина недоступна

Picture not available
Image non disponible
Imagen no disponible
Immagine non disponibile
Nicht verfügbares Bild
Brak zdjęć
Картина недоступна

BRUSH HOLDER 09 056473
Valeo 105112/436353



A13V02

70 1 6V

14 ↻ 60° ∇ Ø 56 INC

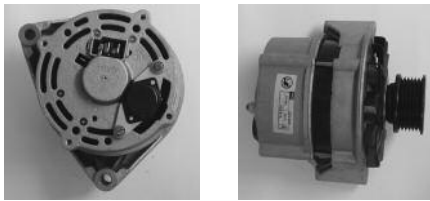

SEP:SEPARATED REGULATOR -INC:BUILT-IN REGULATOR 02592792
 RECTIFIER OR DIODE BRIDGE ASSEMBLY 07 592838
 PULLEY 11 592898
 ROTOR 04 592808
 STATOR 05 592826

Valeo

433138/436120

A13V05

55 1 6V

14 ↻ 60° ∇ Ø 56 INC

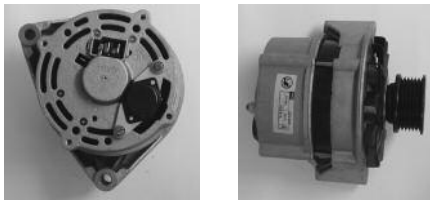

SEP:SEPARATED REGULATOR -INC:BUILT-IN REGULATOR 02592792
 RECTIFIER OR DIODE BRIDGE ASSEMBLY 07 592838
 PULLEY 11 592898

Valeo

433138/436120

A13V07

70 1 6V

14 ↻ 60° ∇ Ø 56 INC

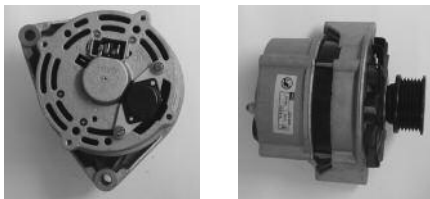

REAR BEARING 22 590613
 SEP:SEPARATED REGULATOR -INC:BUILT-IN REGULATOR 02592792
 RECTIFIER OR DIODE BRIDGE ASSEMBLY 07 592838
 PULLEY 11 592898
 ROTOR 04 592808
 STATOR 05 592826

Valeo

433138/436120

A13V08

55 1 6V

14 ↻ Ø 64

Picture not available
 Image non disponible
 Imagen no disponible
 Immagine non disponibile
 Nicht verfügbares Bild
 Brak zdjęcia
 Картина недоступна

Picture not available
 Image non disponible
 Imagen no disponible
 Immagine non disponibile
 Nicht verfügbares Bild
 Brak zdjęcia
 Картина недоступна

REAR BEARING 22 590613
 SEP:SEPARATED REGULATOR -INC:BUILT-IN REGULATOR 02592792
 RECTIFIER OR DIODE BRIDGE ASSEMBLY 07 592838

A13V110

80 1 1V

14 ↻ 60° ∇ Ø 61

Picture not available
 Image non disponible
 Imagen no disponible
 Immagine non disponibile
 Nicht verfügbares Bild
 Brak zdjęcia
 Картина недоступна

Picture not available
 Image non disponible
 Imagen no disponible
 Immagine non disponibile
 Nicht verfügbares Bild
 Brak zdjęcia
 Картина недоступна

FRONT BEARING 21 593563
 PROTECTION COVER 24 593295
 SEP:SEPARATED REGULATOR -INC:BUILT-IN REGULATOR 02593139
 CONDENSOR 14 592849
 RECTIFIER OR DIODE BRIDGE ASSEMBLY 07 592917
 FRONT BEARING 21 592866
 REPAIRE KIT 29 592854
 ROTOR 04 592818
 STATOR 05 592831

Valeo

436379

A13V100

90 1 6V

14 ↻ 60° ∇ Ø 48 INC



FRONT BEARING 21 593674
 REAR BEARING 22 593691
 PROTECTION COVER 24 593235
 SEP:SEPARATED REGULATOR -INC:BUILT-IN REGULATOR 02593131
 CONDENSOR 14 593233
 RECTIFIER OR DIODE BRIDGE ASSEMBLY 07 592917
 PULLEY 11 593718
 REPAIRE KIT 29 592854
 ROTOR 04 593145
 STATOR 05 592832

A13V100

90 1 6V

14 ↻ 60° ∇ Ø 48 INC

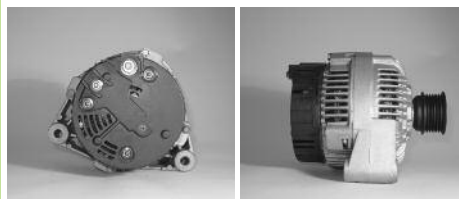

FRONT BEARING 21 593674
 REAR BEARING 22 593691
 PROTECTION COVER 24 593235
 SEP:SEPARATED REGULATOR -INC:BUILT-IN REGULATOR 02593131
 CONDENSOR 14 593233
 RECTIFIER OR DIODE BRIDGE ASSEMBLY 07 592917
 PULLEY 11 593718
 REPAIRE KIT 29 592854
 ROTOR 04 593145
 STATOR 05 592832

Valeo

439244/437125

A13VI101

90

1

6V

14



45°

Ø 59,4

INC

**B+(M8)D+(M5)**

FRONT BEARING	↗ 21	593674
REAR BEARING	↗ 22	593564
PROTECTION COVER	↗ 24	592946
SEP:SEPARATED REGULATOR -INC:BUILT-IN REGULATOR	↗ 02	593350
CONDENSOR	↗ 14	592853
RECTIFIER OR DIODE BRIDGE ASSEMBLY	↗ 07	592848
PULLEY	↗ 11	593702
REPAIRE KIT	↗ 29	592854
ROTOR	↗ 04	593147
STATOR	↗ 05	593158

Valeo**439083/436654****A13VI102**

80

1

6V

14



45°

Ø 59,4

INC

**B+(M8)D+(M5)**

FRONT BEARING	↗ 21	593674
REAR BEARING	↗ 22	593564
PROTECTION COVER	↗ 24	592946
SEP:SEPARATED REGULATOR -INC:BUILT-IN REGULATOR	↗ 02	593350
CONDENSOR	↗ 14	592853
RECTIFIER OR DIODE BRIDGE ASSEMBLY	↗ 07	592848
PULLEY	↗ 11	593702
REPAIRE KIT	↗ 29	592854
ROTOR	↗ 04	593298
STATOR	↗ 05	592831

Valeo**439071/436642****A13VI104**

80

2

3V

14



19°

Ø 67,2

INC

**B+(M8)
L(M5)**

FRONT BEARING	↗ 21	593563
REAR BEARING	↗ 22	593564
PROTECTION COVER	↗ 24	592944
CONDENSOR	↗ 14	592852
RECTIFIER OR DIODE BRIDGE ASSEMBLY	↗ 07	592847
PULLEY	↗ 11	593746
REPAIRE KIT	↗ 29	592854
ROTOR	↗ 04	593298
STATOR	↗ 05	592831

Valeo**439058/436615****A13VI105**

110

2

3V

14



19°

Ø 67,2

Picture not available
Image non disponible
Imagen no disponible
Immagine non disponibile
Nicht verfügbares Bild
Brak zdjęcia
Картина недоступна

Picture not available
Image non disponible
Imagen no disponible
Immagine non disponibile
Nicht verfügbares Bild
Brak zdjęcia
Картина недоступна

FRONT BEARING	↗ 21	593563
REAR BEARING	↗ 22	593564
PROTECTION COVER	↗ 24	592944
CONDENSOR	↗ 14	592852
RECTIFIER OR DIODE BRIDGE ASSEMBLY	↗ 07	592846
PULLEY	↗ 11	593746
REPAIRE KIT	↗ 29	592854
ROTOR	↗ 04	593298
STATOR	↗ 05	592832

Valeo**439078/436649****A13VI106**

110

2

6V

14



27°

Ø 55

INC

**B+(M6)
W(M5),L(M5)**

FRONT BEARING	↗ 21	593563
REAR BEARING	↗ 22	593564
PROTECTION COVER	↗ 24	592944
CONDENSOR	↗ 14	592852
RECTIFIER OR DIODE BRIDGE ASSEMBLY	↗ 07	592846
PULLEY	↗ 11	593543
REPAIRE KIT	↗ 29	592854
ROTOR	↗ 04	593298
STATOR	↗ 05	592832

Valeo**439059/436616****A13VI107**

110

2

6V

14



0°

Ø 55

INC

**B+(M6)
W(M5),L(M5)**

FRONT BEARING	↗ 21	593563
REAR BEARING	↗ 22	593564
PROTECTION COVER	↗ 24	592944
CONDENSOR	↗ 14	592852
RECTIFIER OR DIODE BRIDGE ASSEMBLY	↗ 07	592846
PULLEY	↗ 11	593747
REPAIRE KIT	↗ 29	592854
ROTOR	↗ 04	593298
STATOR	↗ 05	592832

Valeo**439060/436617**

A13VI108

80

2

5V

14



20°

Ø 59,4

INC

**B+(M8)D+(M5)**

FRONT BEARING	593563
REAR BEARING	593564
PROTECTION COVER	*592942
CONDENSOR	592851
RECTIFIER OR DIODE BRIDGE ASSEMBLY	593163
FRONT BEARING	592866
PULLEY	593742
REPAIRE KIT	592854
ROTOR	593298
STATOR	592831

A13VI108

80

2

5V

14



20°

Ø 59,4

INC

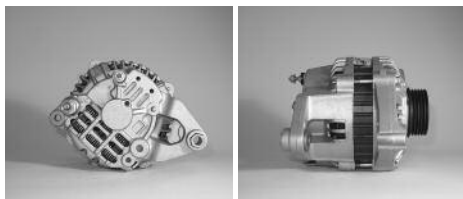
**B+(M8)D+(M5)**

FRONT BEARING	593563
REAR BEARING	593564
PROTECTION COVER	*592942
CONDENSOR	592851
RECTIFIER OR DIODE BRIDGE ASSEMBLY	593163
FRONT BEARING	592866
PULLEY	593742
REPAIRE KIT	592854
ROTOR	593298
STATOR	592831

Valeo**439021/436474****A13VI109**

80

2

5V

14



20°

Ø 65

INC

**B+(M8)D+(M5)**

FRONT BEARING	593563
REAR BEARING	593564
PROTECTION COVER	*592942
CONDENSOR	592851
RECTIFIER OR DIODE BRIDGE ASSEMBLY	593163
FRONT BEARING	592866
PULLEY	593744
REPAIRE KIT	592854
ROTOR	593298
STATOR	592831

Valeo**439022/436475****A13VI11**

110

2

6V

14



0°

Ø 61,1

INC



FRONT BEARING	593563
REAR BEARING	593564
PROTECTION COVER	592944
CONDENSOR	592852
RECTIFIER OR DIODE BRIDGE ASSEMBLY	592846
PULLEY	592921
REPAIRE KIT	592854
ROTOR	592818
ROTOR	593298
STATOR	592832

Valeo**433165/436275****A13VI113**

110

2

3V

14



0°

Ø 58,18

Picture not available
Image non disponible
Imagen no disponible
Immagine non disponibile
Nicht verfügbares Bild
Brak zdjęćia
Картина недоступна

Picture not available
Image non disponible
Imagen no disponible
Immagine non disponibile
Nicht verfügbares Bild
Brak zdjęćia
Картина недоступна

FRONT BEARING	593563
REAR BEARING	593564
PROTECTION COVER	*592942
SEP:SEPARATED REGULATOR -INC:BUILT-IN REGULATOR	593131
PULLEY	593215
REPAIRE KIT	592854
ROTOR	593298
STATOR	592832

A13VI114

90

2

6V

14



90°

Ø 59,2

INC



FRONT BEARING	593563
REAR BEARING	593564
PROTECTION COVER	593241
SEP:SEPARATED REGULATOR -INC:BUILT-IN REGULATOR	593131
CONDENSOR	592933
RECTIFIER OR DIODE BRIDGE ASSEMBLY	592915
PULLEY	593615
REPAIRE KIT	592854
ROTOR	593298
STATOR	592832

Valeo**439032/436483**

A13VI116

80

1

5V

14



60°

Ø 57

INC

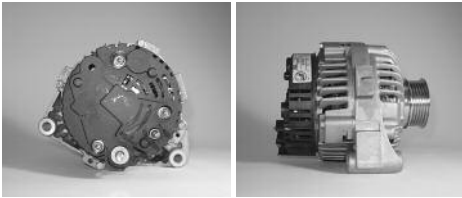
**B+(M8)D+(M5)****PROTECTION COVER** 24

593295

SEP:SEPARATED REGULATOR -INC:BUILT-IN REGULATOR 02593131

593131

CONDENSOR 14

592850

RECTIFIER OR DIODE BRIDGE ASSEMBLY 07

592915

PULLEY 11

593722

REPAIRE KIT 29

592854

ROTOR 04

593298

STATOR 05

592831

Valeo**439165/436678****A13VI117**

110

2

6V

14



0°

Ø 62,9

Picture not available
Image non disponible
Imagen no disponible
Immagine non disponibile
Nicht verfügbares Bild
Brak zdjęcia
Картина недоступна

Picture not available
Image non disponible
Imagen no disponible
Immagine non disponibile
Nicht verfügbares Bild
Brak zdjęcia
Картина недоступна

FRONT BEARING 21

593563

REAR BEARING 22

593564

PROTECTION COVER 24

593242

SEP:SEPARATED REGULATOR -INC:BUILT-IN REGULATOR 02593141

593141

RECTIFIER OR DIODE BRIDGE ASSEMBLY 07

593172

PULLEY 11

593707

REPAIRE KIT 29

592854

ROTOR 04

593298

STATOR 05

592832

Valeo**439532****A13VI118**

120

2

6V

14



13°

Ø 60,7

INC

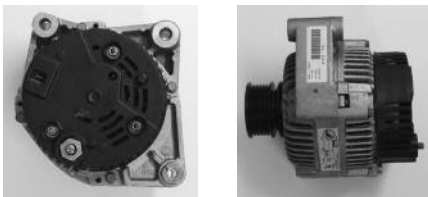
**FRONT BEARING** 21

593563

REAR BEARING 22

593564

PROTECTION COVER 24

593249

SEP:SEPARATED REGULATOR -INC:BUILT-IN REGULATOR 02593141

593141

RECTIFIER OR DIODE BRIDGE ASSEMBLY 07

593174

PULLEY 11

593712

REPAIRE KIT 29

592854

ROTOR 04

593147

STATOR 05

593161

Valeo**439082/436653****A13VI119**

80

1

6V

14



30°

Ø 53,2

INC

**FRONT BEARING** 21

593563

REAR BEARING 22

593564

CONDENSOR 14

592852

PULLEY 11

593602

REGULATOR + COVER 02+24

*599146

REPAIRE KIT 29

592854

ROTOR 04

593298

STATOR 05

592831

Valeo**439084/436655****A13VI121**

90

2

7V

14



90°

Ø 64,2

INC

**FRONT BEARING** 21

593563

REAR BEARING 22

593564

PROTECTION COVER 24

593241

SEP:SEPARATED REGULATOR -INC:BUILT-IN REGULATOR 02593131

593131

CONDENSOR 14

592933

RECTIFIER OR DIODE BRIDGE ASSEMBLY 07

592915

PULLEY 11

593706

REPAIRE KIT 29

592854

ROTOR 04

593298

STATOR 05

592832

Valeo**439033/436484****A13VI122**

110

2

3V

14



0°

Ø 58,18

INC

**FRONT BEARING** 21

593563

REAR BEARING 22

593564

PROTECTION COVER 24

593242

SEP:SEPARATED REGULATOR -INC:BUILT-IN REGULATOR 02593141

593141

RECTIFIER OR DIODE BRIDGE ASSEMBLY 07

593172

PULLEY 11

593215

REPAIRE KIT 29

592854

ROTOR 04

593298

STATOR 05

592832

Valeo**439325/437329**

A13VI123

90

2

6V

14



72-88°

Ø 53,2

INC

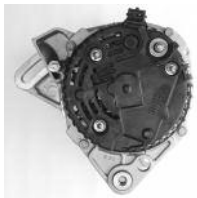

FRONT BEARING	21	593563
REAR BEARING	22	593564
PROTECTION COVER	24	593241
SEP:SEPARATED REGULATOR -INC:BUILT-IN REGULATOR	02	593131
CONDENSOR	14	592933
RECTIFIER OR DIODE BRIDGE ASSEMBLY	07	592915
REPAIRE KIT	29	592854
ROTOR	04	593298
STATOR	05	592832

Valeo**439002/436443****A13VI124**

90

2

6V

14



90°

Ø 53,2

INC



FRONT BEARING	21	593563
REAR BEARING	22	593564
PROTECTION COVER	24	593241
SEP:SEPARATED REGULATOR -INC:BUILT-IN REGULATOR	02	593131
CONDENSOR	14	592933
RECTIFIER OR DIODE BRIDGE ASSEMBLY	07	592915
REPAIRE KIT	29	592854
ROTOR	04	593298
STATOR	05	592832

Valeo**439003/436444****A13VI125**

90

2

7V

14



90°

Ø 58,3

INC



FRONT BEARING	21	593563
REAR BEARING	22	593564
PROTECTION COVER	24	593241
SEP:SEPARATED REGULATOR -INC:BUILT-IN REGULATOR	02	593131
CONDENSOR	14	592933
RECTIFIER OR DIODE BRIDGE ASSEMBLY	07	592915
PULLEY	11	593693
REPAIRE KIT	29	592854
ROTOR	04	593298
STATOR	05	592832

Valeo**439004/436445****A13VI126**

90

2

6V

14



90°

Ø 53,2

INC



FRONT BEARING	21	593563
REAR BEARING	22	593564
PROTECTION COVER	24	593295
SEP:SEPARATED REGULATOR -INC:BUILT-IN REGULATOR	02	593131
CONDENSOR	14	592850
RECTIFIER OR DIODE BRIDGE ASSEMBLY	07	593557
REPAIRE KIT	29	592854
ROTOR	04	593298
STATOR	05	592832

Valeo**439012/436449****A13VI13**

110

2

1V

14



0°

Ø 66

Picture not available
Image non disponible
Imagen no disponible
Immagine non disponibile
Nicht verfügbares Bild
Brak zdjęcia
Картина недоступна

Picture not available
Image non disponible
Imagen no disponible
Immagine non disponibile
Nicht verfügbares Bild
Brak zdjęcia
Картина недоступна

FRONT BEARING	21	593563
REAR BEARING	22	593690
PROTECTION COVER	24	592945
CONDENSOR	14	592852
RECTIFIER OR DIODE BRIDGE ASSEMBLY	07	592846
PULLEY	11	096879
REPAIRE KIT	29	592854
ROTOR	04	592818
STATOR	05	592832

Valeo**433176****A13VI130**

95

1

14



Picture not available
Image non disponible
Imagen no disponible
Immagine non disponibile
Nicht verfügbares Bild
Brak zdjęcia
Картина недоступна

Picture not available
Image non disponible
Imagen no disponible
Immagine non disponibile
Nicht verfügbares Bild
Brak zdjęcia
Картина недоступна

CONDENSOR	14	592852
RECTIFIER OR DIODE BRIDGE ASSEMBLY	07	593204
PULLEY	11	592919
REGULATOR + COVER	02+24	*599147
REPAIRE KIT	29	592854
ROTOR	04	593298
STATOR	05	592832

A13VI131

110

2

6V

14



35°

Ø 62,9

INC

Picture not available
Image non disponible
Imagem no disponibile
Immagine non disponibile
Nicht verfügbares Bild
Brak zdjęcia
Картина недоступна

Picture not available
Image non disponible
Imagem no disponibile
Immagine non disponibile
Nicht verfügbares Bild
Brak zdjęcia
Картина недоступна

FRONT BEARING 21

593563

REAR BEARING 22

593564

PROTECTION COVER 24

592944

CONDENSOR 14

592852

RECTIFIER OR DIODE BRIDGE ASSEMBLY 07

592846

PULLEY 11

593707

REPAIRE KIT 29

592854

ROTOR 04

593298

STATOR 05

592832

Valeo**439066/436637****A13VI132**

80

2

6V

14



30°

Ø 53,2

INC

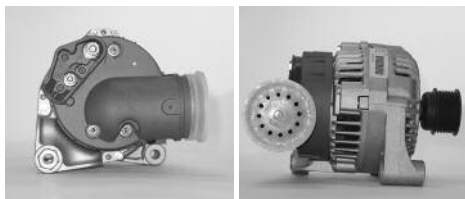
**B+(M8)D+(M6)****FRONT BEARING** 21

593563

SEP:SEPARATED REGULATOR -INC:BUILT-IN REGULATOR 02 593139**CONDENSOR** 14

592934

RECTIFIER OR DIODE BRIDGE ASSEMBLY 07

592915

PULLEY 11

593602

PROTECTION COVER 24

592947

REPAIRE KIT 29

592854

ROTOR 04

593298

STATOR 05

592831

Valeo**439070/436641****A13VI134**

90

1

6V

14



60°

Ø 56

INC

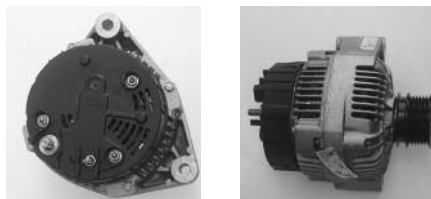
**B+(M8)D+(M5)****FRONT BEARING** 21

593674

REAR BEARING 22

593564

SEP:SEPARATED REGULATOR -INC:BUILT-IN REGULATOR 02 593131**CONDENSOR** 14

593233

RECTIFIER OR DIODE BRIDGE ASSEMBLY 07

592917

PULLEY 11

592898

REPAIRE KIT 29

592854

ROTOR 04

593298

STATOR 05

592832

A13VI134

90

1

6V

14



60°

Ø 56

INC

**B+(M8)D+(M5)****FRONT BEARING** 21

593674

REAR BEARING 22

593564

SEP:SEPARATED REGULATOR -INC:BUILT-IN REGULATOR 02 593131**CONDENSOR** 14

593233

RECTIFIER OR DIODE BRIDGE ASSEMBLY 07

592917

PULLEY 11

592898

REPAIRE KIT 29

592854

ROTOR 04

593298

STATOR 05

592832

Valeo**439245/437126****A13VI135**

90

1

6V

14



60°

Ø 48

INC

**FRONT BEARING** 21

593674

REAR BEARING 22

593564

PROTECTION COVER 24

593235

SEP:SEPARATED REGULATOR -INC:BUILT-IN REGULATOR 02 593131**CONDENSOR** 14

593233

RECTIFIER OR DIODE BRIDGE ASSEMBLY 07

592917

PULLEY 11

593718

REPAIRE KIT 29

592854

ROTOR 04

593298

STATOR 05

592832

A13VI135

90

1

6V

14



60°

Ø 48

INC

**FRONT BEARING** 21

593674

REAR BEARING 22

593564

PROTECTION COVER 24

593235

SEP:SEPARATED REGULATOR -INC:BUILT-IN REGULATOR 02 593131**CONDENSOR** 14

593233

RECTIFIER OR DIODE BRIDGE ASSEMBLY 07

592917

PULLEY 11

593718

REPAIRE KIT 29

592854

ROTOR 04

593298

STATOR 05

592832

Valeo**439244/437125**

A13VI137

90 2 5V

14 ↻ 90° ∇ Ø 59,2 INC

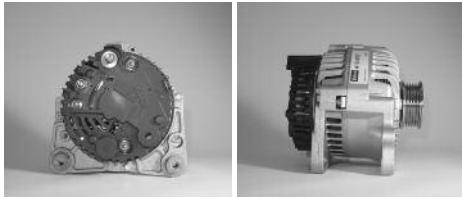
**B+(M8)D+(M5)**

FRONT BEARING	↻ 21	593563
REAR BEARING	↻ 22	593564
PROTECTION COVER	↻ 24	593295
SEP:SEPARATED REGULATOR -INC:BUILT-IN REGULATOR	↻ 02	593131
CONDENSOR	↻ 14	592850
RECTIFIER OR DIODE BRIDGE ASSEMBLY	↻ 07	592917
PULLEY	↻ 11	593710
REPAIRE KIT	↻ 29	592854
ROTOR	↻ 04	593298
STATOR	↻ 05	592832

Valeo**439073/436644****A13VI138**

90 2 5V

14 ↻ 60° ∇ Ø 59,1 INC

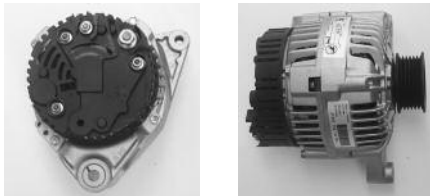
**B+(M8)D+(M5)**

FRONT BEARING	↻ 21	593674
REAR BEARING	↻ 22	593564
PROTECTION COVER	↻ 24	593295
SEP:SEPARATED REGULATOR -INC:BUILT-IN REGULATOR	↻ 02	593131
CONDENSOR	↻ 14	592850
RECTIFIER OR DIODE BRIDGE ASSEMBLY	↻ 07	592917
PULLEY	↻ 11	593711
REPAIRE KIT	↻ 29	592854
ROTOR	↻ 04	593298

Valeo**439069/436640****A13VI139**

110 2 6V

14 ↻ 0° ∇ Ø 58,18 INC



FRONT BEARING	↻ 21	593563
REAR BEARING	↻ 22	593564
PROTECTION COVER	↻ 24	593242
SEP:SEPARATED REGULATOR -INC:BUILT-IN REGULATOR	↻ 02	593141
RECTIFIER OR DIODE BRIDGE ASSEMBLY	↻ 07	593172
PULLEY	↻ 11	593709
REPAIRE KIT	↻ 29	592854
ROTOR	↻ 04	593298
STATOR	↻ 05	592832

Valeo**439075/436646****A13VI14**

80 2 4V

14 ↻ 19° ∇ Ø 61,6 INC



FRONT BEARING	↻ 21	593563
REAR BEARING	↻ 22	593564
PROTECTION COVER	↻ 24	592944
CONDENSOR	↻ 14	592852
RECTIFIER OR DIODE BRIDGE ASSEMBLY	↻ 07	592847
PULLEY	↻ 11	592924
REPAIRE KIT	↻ 29	592854
ROTOR	↻ 04	592818
STATOR	↻ 05	592831

Valeo**433166/436276****A13VI140**

115 2 6V

14 ↻ 32° ∇ Ø 53,2 INC

**B+(M8)D+(M6)**

FRONT BEARING	↻ 21	593563
REAR BEARING	↻ 22	593564
SEP:SEPARATED REGULATOR -INC:BUILT-IN REGULATOR	↻ 02	593139
CONDENSOR	↻ 14	592934
RECTIFIER OR DIODE BRIDGE ASSEMBLY	↻ 07	592915
PULLEY	↻ 11	593602
PROTECTION COVER	↻ 24	595260
REPAIRE KIT	↻ 29	592854
ROTOR	↻ 04	593147
STATOR	↻ 05	593161

Valeo**439036/436488****A13VI141**

90 1 5V

14 ↻ 60° ∇ Ø 59,4 INC

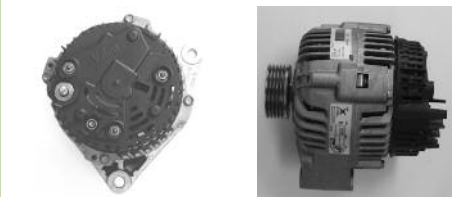
**B+(M8)D+(M6)**

FRONT BEARING	↻ 21	593563
REAR BEARING	↻ 22	593564
PROTECTION COVER	↻ 24	*592942
SEP:SEPARATED REGULATOR -INC:BUILT-IN REGULATOR	↻ 02	593350
CONDENSOR	↻ 14	592851
RECTIFIER OR DIODE BRIDGE ASSEMBLY	↻ 07	593163
FRONT BEARING	↻ 21	592866
PULLEY	↻ 11	592929
REPAIRE KIT	↻ 29	592854
ROTOR	↻ 04	593147
STATOR	↻ 05	593158

Valeo**439094/436666**

A13VI142

95

2

5V

14



55°



INC

**B+(M8)D+(M5)**

FRONT BEARING	21	593563
REAR BEARING	22	593564
PROTECTION COVER	24	*592942
SEP:SEPARATED REGULATOR -INC:BUILT-IN REGULATOR	02	593350
CONDENSOR	14	592851
RECTIFIER OR DIODE BRIDGE ASSEMBLY	07	593163
FRONT BEARING	21	592866
PULLEY	11	593742
REPAIRE KIT	29	592854
ROTOR	04	593147
STATOR	05	593158

Valeo**439103/436669****A13VI148**

110

2

4V

14



0°



Ø 56,7

Picture not available
Image non disponible
Imagen no disponible
Immagine non disponibile
Nicht verfügbares Bild
Brak zdjęcia
Картина недоступна

Picture not available
Image non disponible
Imagen no disponible
Immagine non disponibile
Nicht verfügbares Bild
Brak zdjęcia
Картина недоступна

FRONT BEARING	21	593563
REAR BEARING	22	593564
PROTECTION COVER	24	593242
SEP:SEPARATED REGULATOR -INC:BUILT-IN REGULATOR	02	593141
RECTIFIER OR DIODE BRIDGE ASSEMBLY	07	593172
PULLEY	11	593248
REPAIRE KIT	29	592854
ROTOR	04	593298
STATOR	05	592832

Valeo**439076/436647****A13VI149**

80

2

4V

14



0°



Ø 56,7

INC



FRONT BEARING	21	593563
REAR BEARING	22	593564
PROTECTION COVER	24	593242
SEP:SEPARATED REGULATOR -INC:BUILT-IN REGULATOR	02	593141
RECTIFIER OR DIODE BRIDGE ASSEMBLY	07	593175
PULLEY	11	593248
REPAIRE KIT	29	592854
ROTOR	04	593298
STATOR	05	592831

Valeo**439085/436656****A13VI150**

95

1

5V

14



60°



Ø 49,4

INC



FRONT BEARING	21	593563
REAR BEARING	22	593564
SEP:SEPARATED REGULATOR -INC:BUILT-IN REGULATOR	02	593333
RECTIFIER OR DIODE BRIDGE ASSEMBLY	07	593204
PULLEY	11	592919
REPAIRE KIT	29	592854
ROTOR	04	593298
STATOR	05	592832

Valeo**439093/436665****A13VI151+**

120

2

6V

14



13°



Ø 60,7

INC



FRONT BEARING	21	593563
REAR BEARING	22	593564
PROTECTION COVER	24	593307
SEP:SEPARATED REGULATOR -INC:BUILT-IN REGULATOR	02	593318
RECTIFIER OR DIODE BRIDGE ASSEMBLY	07	593174
PULLEY	11	593712
REPAIRE KIT	29	592854
ROTOR	04	593147
STATOR	05	593161

Valeo**439203/436731****A13VI152**

80

2

6V

14



13°



Ø 60,7

INC

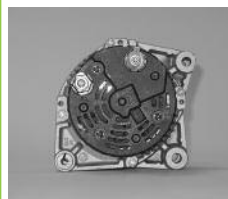

FRONT BEARING	21	593563
REAR BEARING	22	593564
PROTECTION COVER	24	593307
SEP:SEPARATED REGULATOR -INC:BUILT-IN REGULATOR	02	593305
RECTIFIER OR DIODE BRIDGE ASSEMBLY	07	593306
PULLEY	11	593712
REPAIRE KIT	29	592854
ROTOR	04	593298
STATOR	05	592831

Valeo**439172/436702**









A13VI153

110 2 6V

14 ↻ 35° ∇ ∅ 58,18

Picture not available
Image non disponible
Imagem no disponibile
Immagine non disponibile
Nicht verfügbares Bild
Brak zdjęcia
Картина недоступна

Picture not available
Image non disponible
Imagem no disponibile
Immagine non disponibile
Nicht verfügbares Bild
Brak zdjęcia
Картина недоступна









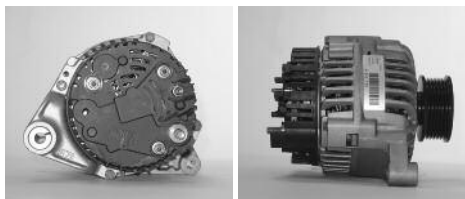

FRONT BEARING 	593563
REAR BEARING 	593564
PROTECTION COVER 	592944
CONDENSOR 	592852
RECTIFIER OR DIODE BRIDGE ASSEMBLY 	592846
REPAIRE KIT 	592854
ROTOR 	593298
STATOR 	592832
Valeo	439091/436662

A13VI155

90 2 6V

14 ↻ 60° ∇ ∅ 66 INC



FRONT BEARING 	593563
REAR BEARING 	593564
PROTECTION COVER 	593295
SEP:SEPARATED REGULATOR -INC:BUILT-IN REGULATOR 	02593131
CONDENSOR 	592850
RECTIFIER OR DIODE BRIDGE ASSEMBLY 	592917
PULLEY 	593719
REPAIRE KIT 	592854
ROTOR 	593298
STATOR 	592832
Valeo	439005/436387







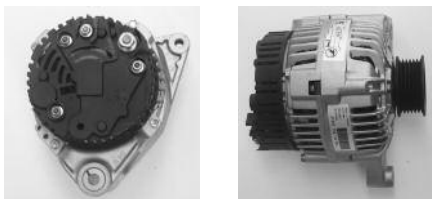



A13VI156

90 2 6V

14 ↻ 60° ∇ ∅ 57,2 INC



B+(M8)D+(M5)









FRONT BEARING 	593563
REAR BEARING 	593564
PROTECTION COVER 	593295
SEP:SEPARATED REGULATOR -INC:BUILT-IN REGULATOR 	02593131
CONDENSOR 	592850
RECTIFIER OR DIODE BRIDGE ASSEMBLY 	592917
PULLEY 	593720
REPAIRE KIT 	592854
ROTOR 	593298
STATOR 	592832
Valeo	439069/436640

A13VI157

110 2 6V

14 ↻ 0° ∇ ∅ 61,1 INC









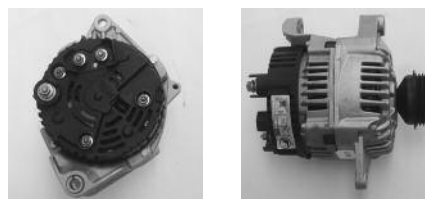

FRONT BEARING 	593563
REAR BEARING 	593564
PROTECTION COVER 	593291
SEP:SEPARATED REGULATOR -INC:BUILT-IN REGULATOR 	02593290
RECTIFIER OR DIODE BRIDGE ASSEMBLY 	593299
PULLEY 	592921
REPAIRE KIT 	592854
ROTOR 	593298
STATOR 	592832
Valeo	433165/436275

A13VI16

80 2 3V

14 ↻ 19° ∇ ∅ 61,1 INC



FRONT BEARING 	593563
REAR BEARING 	593564
PROTECTION COVER 	592944
CONDENSOR 	592852
RECTIFIER OR DIODE BRIDGE ASSEMBLY 	592847
REPAIRE KIT 	592854
ROTOR 	592818
STATOR 	592831
Valeo	433167/436277

A13VI160

90 2 6V

14 ↻ 30° ∇ ∅ 53,2 INC

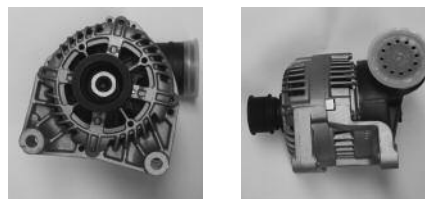

FRONT BEARING 	593563
REAR BEARING 	593564
SEP:SEPARATED REGULATOR -INC:BUILT-IN REGULATOR 	02593333
RECTIFIER OR DIODE BRIDGE ASSEMBLY 	593204
PULLEY 	593602
REPAIRE KIT 	592854
ROTOR 	593298
STATOR 	592832
Valeo	439223/436746

A13VI163

110

2

4V

14



25°

Ø 64,8

INC



FRONT BEARING 21 593563
 REAR BEARING 22 593564
 PROTECTION COVER 24 593291
 SEP:SEPARATED REGULATOR -INC:BUILT-IN REGULATOR 02 593290
 RECTIFIER OR DIODE BRIDGE ASSEMBLY 07 593299
 PULLEY 11 593740
 REPAIRE KIT 29 592854
 ROTOR 04 593298
 STATOR 05 592832

Valeo**439018/436469****A13VI164**

110

2

6V

14



35°

Ø 58,18

INC



FRONT BEARING 21 593563
 REAR BEARING 22 593564
 PROTECTION COVER 24 593291
 SEP:SEPARATED REGULATOR -INC:BUILT-IN REGULATOR 02 593290
 RECTIFIER OR DIODE BRIDGE ASSEMBLY 07 593172
 REPAIRE KIT 29 592854
 ROTOR 04 593298
 STATOR 05 592832

Valeo**439016/436728****A13VI165**

80

2

6V

14



0°

Ø 58,18

INC



FRONT BEARING 21 593563
 REAR BEARING 22 593564
 PROTECTION COVER 24 593291
 SEP:SEPARATED REGULATOR -INC:BUILT-IN REGULATOR 02 593310
 RECTIFIER OR DIODE BRIDGE ASSEMBLY 07 593175
 REPAIRE KIT 29 592854
 ROTOR 04 593298
 STATOR 05 592831

Valeo**439061/436739****A13VI166**

80

2

6V

14



35°

Ø 58,18

INC



FRONT BEARING 21 593563
 REAR BEARING 22 593564
 PROTECTION COVER 24 593291
 SEP:SEPARATED REGULATOR -INC:BUILT-IN REGULATOR 02 593290
 RECTIFIER OR DIODE BRIDGE ASSEMBLY 07 593175
 REPAIRE KIT 29 592854
 ROTOR 04 593298
 STATOR 05 592831

Valeo**439090/436730****A13VI167**

110

2

6V

14



35°

Ø 58,18

INC



FRONT BEARING 21 593563
 REAR BEARING 22 593564
 PROTECTION COVER 24 593291
 SEP:SEPARATED REGULATOR -INC:BUILT-IN REGULATOR 02 593290
 RECTIFIER OR DIODE BRIDGE ASSEMBLY 07 593172
 REPAIRE KIT 29 592854
 ROTOR 04 593298
 STATOR 05 592832

Valeo**439091/436729****A13VI17**

110

2

4V

14



26°

Ø 62,9

INC



FRONT BEARING 21 593563
 REAR BEARING 22 593564
 PROTECTION COVER 24 592944
 CONDENSOR 14 592852
 RECTIFIER OR DIODE BRIDGE ASSEMBLY 07 592846
 PULLEY 11 592927
 REPAIRE KIT 29 592854
 ROTOR 04 592818
 ROTOR 04 593298
 STATOR 05 592832

Valeo**433168/436278**

A13VI170











90 1 6V

14 ↻ 60° ∇ Ø 48 INC

Picture not available
Image non disponible
Imagen no disponible
Immagine non disponibile
Nicht verfügbares Bild
Brak zdjęcia
Картина недоступна

Picture not available
Image non disponible
Imagen no disponible
Immagine non disponibile
Nicht verfügbares Bild
Brak zdjęcia
Картина недоступна

B+(M8)D+(M5)









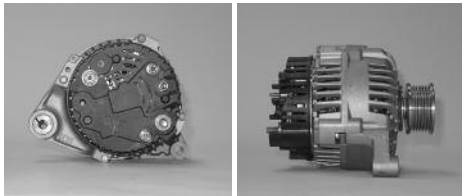

FRONT BEARING 	593674
REAR BEARING 	593691
PROTECTION COVER 	593235
SEP:SEPARATED REGULATOR -INC:BUILT-IN REGULATOR 	02593350
CONDENSOR 	593233
RECTIFIER OR DIODE BRIDGE ASSEMBLY 	592917
PULLEY 	593718
REPAIRE KIT 	592854
ROTOR 	593145
STATOR 	592832

Valeo**439095/436667****A13VI173**

90 2 6V

14 ↻ 60° ∇ Ø 57,2 INC

**B+(M8)D+(M5)**









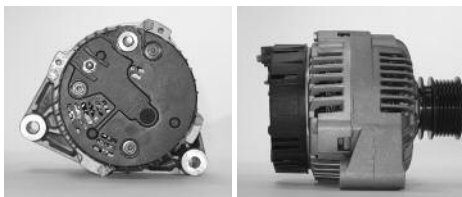

FRONT BEARING 	593563
REAR BEARING 	593564
PROTECTION COVER 	593295
SEP:SEPARATED REGULATOR -INC:BUILT-IN REGULATOR 	02593131
CONDENSOR 	592850
RECTIFIER OR DIODE BRIDGE ASSEMBLY 	592917
PULLEY 	593723
REPAIRE KIT 	592854
ROTOR 	593298
STATOR 	592832

Valeo**439221/436744****A13VI175**

90 1 6V

14 ↻ 60° ∇ Ø 56 INC

**B+(M8)D+(M5)**

FRONT BEARING 	593563
REAR BEARING 	593564
PROTECTION COVER 	593235
SEP:SEPARATED REGULATOR -INC:BUILT-IN REGULATOR 	02593350
CONDENSOR 	593233
RECTIFIER OR DIODE BRIDGE ASSEMBLY 	592917
FRONT BEARING 	592866
PULLEY 	592898
REPAIRE KIT 	592854
ROTOR 	593145
STATOR 	592832

Valeo**439198/436718****A13VI176**











90 1 6V

14 ↻ 60° ∇ Ø 48 INC

Picture not available
Image non disponible
Imagen no disponible
Immagine non disponibile
Nicht verfügbares Bild
Brak zdjęcia
Картина недоступна

Picture not available
Image non disponible
Imagen no disponible
Immagine non disponibile
Nicht verfügbares Bild
Brak zdjęcia
Картина недоступна

B+(M8)D+(M5)



FRONT BEARING 	593563
REAR BEARING 	593691
PROTECTION COVER 	593235
SEP:SEPARATED REGULATOR -INC:BUILT-IN REGULATOR 	02593350
CONDENSOR 	593233
RECTIFIER OR DIODE BRIDGE ASSEMBLY 	592917
FRONT BEARING 	592866
PULLEY 	593718
REPAIRE KIT 	592854
ROTOR 	593145
STATOR 	592832

Valeo**439095/436667****A13VI178**

90 5V

14 ↻ Ø 51 INC

**B+(M8)
L(M6)**

FRONT BEARING 	593563
REAR BEARING 	593564
PROTECTION COVER 	593322
SEP:SEPARATED REGULATOR -INC:BUILT-IN REGULATOR 	02593319
RECTIFIER OR DIODE BRIDGE ASSEMBLY 	593320
FRONT BEARING 	592866
PULLEY 	593724
REPAIRE KIT 	592854
ROTOR 	593298
STATOR 	592832

Valeo**439206/436732****A13VI179**

110 2 6V

14 ↻ 0° Ø 58,2 INC



FRONT BEARING 	593563
REAR BEARING 	593564
PROTECTION COVER 	593291
SEP:SEPARATED REGULATOR -INC:BUILT-IN REGULATOR 	02593290
RECTIFIER OR DIODE BRIDGE ASSEMBLY 	593329
PULLEY 	593701
REPAIRE KIT 	592854
ROTOR 	593298
STATOR 	592832

Valeo**439216/436743**

A13VI18

95

1

5V

14



60°

Ø 49,4

INC

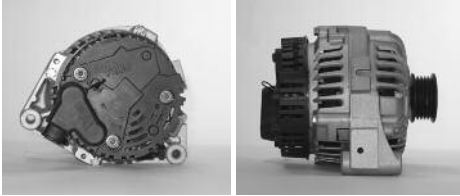
**B+(M8)D+(M6)**

FRONT BEARING	21	593563
PROTECTION COVER	24	592941
SEP:SEPARATED REGULATOR -INC:BUILT-IN REGULATOR	02	593139
CONDENSOR	14	592849
RECTIFIER OR DIODE BRIDGE ASSEMBLY	07	592915
FRONT BEARING	21	592866
PULLEY	11	592919
REPAIRE KIT	29	592854
ROTOR	04	592818
ROTOR	04	593298
STATOR	05	592832

Valeo**439038/436380****A13VI180**

115

2

6V

14



32°

Ø 53,2

INC

**B+(M8)D+(M6)**

FRONT BEARING	21	593563
REAR BEARING	22	593564
SEP:SEPARATED REGULATOR -INC:BUILT-IN REGULATOR	02	593139
RECTIFIER OR DIODE BRIDGE ASSEMBLY	07	592917
PULLEY	11	593602
REPAIRE KIT	29	592854
ROTOR	04	593147
STATOR	05	593161

Valeo**439170/436700****A13VI181**

90

2

6V

14



90°

Ø 57,2

Picture not available
Image non disponible
Imagen no disponible
Immagine non disponibile
Nicht verfügbares Bild
Brak zdjęcia
Картина недоступна

Picture not available
Image non disponible
Imagen no disponible
Immagine non disponibile
Nicht verfügbares Bild
Brak zdjęcia
Картина недоступна

PROTECTION COVER	24	593367
SEP:SEPARATED REGULATOR -INC:BUILT-IN REGULATOR	02	593362
RECTIFIER OR DIODE BRIDGE ASSEMBLY	07	593364
REPAIRE KIT	29	592854
ROTOR	04	593298
STATOR	05	592832

A13VI184

80

2

3V

14



19°

Ø 67,2

INC



FRONT BEARING	21	593563
REAR BEARING	22	593564
PROTECTION COVER	24	593291
SEP:SEPARATED REGULATOR -INC:BUILT-IN REGULATOR	02	593310
RECTIFIER OR DIODE BRIDGE ASSEMBLY	07	593304
PULLEY	11	593746
REPAIRE KIT	29	592854
ROTOR	04	593298
STATOR	05	592831

Valeo**439058/436737****A13VI185**

110

2

3V

14



19°

Ø 67,2

INC



FRONT BEARING	21	593563
REAR BEARING	22	593564
PROTECTION COVER	24	593291
SEP:SEPARATED REGULATOR -INC:BUILT-IN REGULATOR	02	593290
RECTIFIER OR DIODE BRIDGE ASSEMBLY	07	593299
PULLEY	11	593746
REPAIRE KIT	29	592854
ROTOR	04	593298
STATOR	05	592832

Valeo**439078/436745****A13VI188**

110

2

3V

14



30°

Ø 67,2

INC

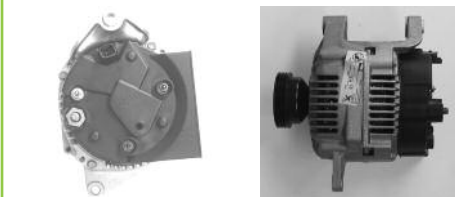

FRONT BEARING	21	593563
REAR BEARING	22	593564
PROTECTION COVER	24	593317
SEP:SEPARATED REGULATOR -INC:BUILT-IN REGULATOR	02	593411
RECTIFIER OR DIODE BRIDGE ASSEMBLY	07	593327
PULLEY	11	593751
REPAIRE KIT	29	592854
ROTOR	04	593298
STATOR	05	592832

Valeo**439215/436742**

A13VI189

80 2 6V

14 ↻ 20° ∅ 59,4 INC

**B+(M8)D+(M5)**

- FRONT BEARING 21 593563
- REAR BEARING 22 593564
- PROTECTION COVER 24 *592942
- SEP:SEPARATED REGULATOR -INC:BUILT-IN REGULATOR 02 593350
- CONDENSOR 14 592851
- RECTIFIER OR DIODE BRIDGE ASSEMBLY 07 593163
- FRONT BEARING 21 592866
- PULLEY 11 593743
- REPAIRE KIT 29 592854
- ROTOR 04 593298
- STATOR 05 592831

Valeo**439023/436476****A13VI190**

90 4 6V

14 ↻ 60° ∅ 53,46 INC



- FRONT BEARING 21 593563
- REAR BEARING 22 593564
- PROTECTION COVER 24 593354
- SEP:SEPARATED REGULATOR -INC:BUILT-IN REGULATOR 02 593333
- RECTIFIER OR DIODE BRIDGE ASSEMBLY 07 593204
- PULLEY 11 593727
- REPAIRE KIT 29 592854
- ROTOR 04 593298
- STATOR 05 592832

Valeo**439236/437117****A13VI191**

97 2 6V

14 ↻ 20° ∅ 59,4 INC

**B+(M8)D+(M5)**

- FRONT BEARING 21 593563
- REAR BEARING 22 593564
- PROTECTION COVER 24 *592942
- SEP:SEPARATED REGULATOR -INC:BUILT-IN REGULATOR 02 593350
- CONDENSOR 14 592851
- RECTIFIER OR DIODE BRIDGE ASSEMBLY 07 593163
- FRONT BEARING 21 592866
- PULLEY 11 593743
- REPAIRE KIT 29 592854
- ROTOR 04 593147
- STATOR 05 593158

Valeo**433190/436366****A13VI192+**

105 2 6V

14 ↻ 60° ∅ 57,1 INC



- FRONT BEARING 21 593563
- REAR BEARING 22 593564
- SEP:SEPARATED REGULATOR -INC:BUILT-IN REGULATOR 02 593342
- RECTIFIER OR DIODE BRIDGE ASSEMBLY 07 593327
- PULLEY 11 593615
- REPAIRE KIT 29 592854
- ROTOR 04 593147
- STATOR 05 593158

Valeo**439227/436751****A13VI193+**

105 2 6V

14 ↻ 0° ∅ 51,1 INC



- FRONT BEARING 21 593563
- REAR BEARING 22 593564
- PROTECTION COVER 24 593341
- SEP:SEPARATED REGULATOR -INC:BUILT-IN REGULATOR 02 593342
- RECTIFIER OR DIODE BRIDGE ASSEMBLY 07 593327
- PULLEY 11 593714
- REPAIRE KIT 29 592854
- ROTOR 04 593147
- STATOR 05 593158

Valeo**439228/436752****A13VI194+**

105 2 6V

14 ↻ 55° ∅ 53,34

Picture not available
Image non disponible
Imagen no disponible
Immagine non disponibile
Nicht verfügbares Bild
Brak zdjęcia
Картина недоступна

Picture not available
Image non disponible
Imagen no disponible
Immagine non disponibile
Nicht verfügbares Bild
Brak zdjęcia
Картина недоступна

- PROTECTION COVER 24 593341
- SEP:SEPARATED REGULATOR -INC:BUILT-IN REGULATOR 02 593342
- RECTIFIER OR DIODE BRIDGE ASSEMBLY 07 593327
- PULLEY 11 593715
- REPAIRE KIT 29 592854
- ROTOR 04 593147
- STATOR 05 593158

Valeo**439218**

A13VI195

110

2

6V

14



26°

Ø 58,18

INC

**FRONT BEARING** 21

593563

REAR BEARING 22

593564

SEP:SEPARATED REGULATOR -INC:BUILT-IN REGULATOR 02 593411**RECTIFIER OR DIODE BRIDGE ASSEMBLY** 07

593327

REPAIRE KIT 29

592854

ROTOR 04

593298

STATOR 05

592832

Valeo**439224/436748****A13VI197**

90

1

6V

14



60°

Ø 56

INC

**B+(M8)D+(M5)****FRONT BEARING** 21

593563

REAR BEARING 22

593564

PROTECTION COVER 24

593235

SEP:SEPARATED REGULATOR -INC:BUILT-IN REGULATOR 02 593131**CONDENSOR** 14

593233

RECTIFIER OR DIODE BRIDGE ASSEMBLY 07

592917

FRONT BEARING 21

592866

PULLEY 11

592898

REPAIRE KIT 29

592854

ROTOR 04

593298

STATOR 05

592832

A13VI197

90

1

6V

14



60°

Ø 56

INC

**B+(M8)D+(M5)****FRONT BEARING** 21

593563

REAR BEARING 22

593564

PROTECTION COVER 24

593235

SEP:SEPARATED REGULATOR -INC:BUILT-IN REGULATOR 02 593131**CONDENSOR** 14

593233

RECTIFIER OR DIODE BRIDGE ASSEMBLY 07

592917

FRONT BEARING 21

592866

PULLEY 11

592898

REPAIRE KIT 29

592854

ROTOR 04

593298

STATOR 05

592832

Valeo**439245/437126****A13VI198**

90

1

6V

14



60°

Ø 48

INC

**FRONT BEARING** 21

593563

REAR BEARING 22

593564

PROTECTION COVER 24

593235

SEP:SEPARATED REGULATOR -INC:BUILT-IN REGULATOR 02 593131**CONDENSOR** 14

593233

RECTIFIER OR DIODE BRIDGE ASSEMBLY 07

592917

FRONT BEARING 21

592866

PULLEY 11

593718

REPAIRE KIT 29

592854

ROTOR 04

593298

STATOR 05

592832

A13VI198

90

1

6V

14



60°

Ø 48

INC

**FRONT BEARING** 21

593563

REAR BEARING 22

593564

PROTECTION COVER 24

593235

SEP:SEPARATED REGULATOR -INC:BUILT-IN REGULATOR 02 593131**CONDENSOR** 14

593233

RECTIFIER OR DIODE BRIDGE ASSEMBLY 07

592917

FRONT BEARING 21

592866

PULLEY 11

593718

REPAIRE KIT 29

592854

ROTOR 04

593298

STATOR 05

592832

Valeo**439244/437125****A13VI20**

80

2

4V

14



0°

Ø 64,8

INC

**B+(M6)
W(M5),L(M5)****FRONT BEARING** 21

593563

REAR BEARING 22

593564

PROTECTION COVER 24

592944

CONDENSOR 14

592852

RECTIFIER OR DIODE BRIDGE ASSEMBLY 07

592847

PULLEY 11

592923

REPAIRE KIT 29

592854

ROTOR 04

592818

ROTOR 04

593298

STATOR 05

592831

Valeo**433169/436279**

A13VI200

100 4 6V

14 ↻ 60° ∇ Ø 53,46 INC



FRONT BEARING	↻ 21	593563
REAR BEARING	↻ 22	593564
PROTECTION COVER	↻ 24	593354
SEP:SEPARATED REGULATOR -INC:BUILT-IN REGULATOR	↻ 02	593333
RECTIFIER OR DIODE BRIDGE ASSEMBLY	↻ 07	593204
PULLEY	↻ 11	593727
REPAIRE KIT	↻ 29	592854
ROTOR	↻ 04	593147
STATOR	↻ 05	593161

Valeo

439237/437118

A13VI201

120 2 6V

14 ↻ 40° ∇ Ø 54,4 INC

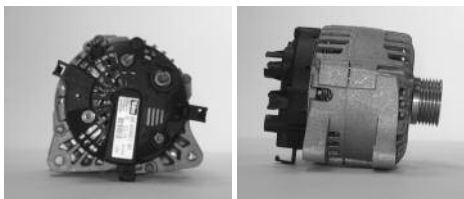
B+(M8)
L(M5)

FRONT BEARING	↻ 21	593674
REAR BEARING	↻ 22	593564
SEP:SEPARATED REGULATOR -INC:BUILT-IN REGULATOR	↻ 02	593290
PULLEY	↻ 11	593760
REPAIRE KIT	↻ 29	592854
ROTOR	↻ 04	593147
STATOR	↻ 05	593161

Valeo

439470/436749

A13VI202

90 3 5V

14 ↻ Ø 51 INC

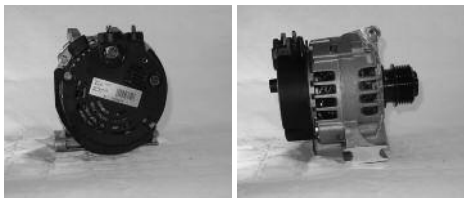
B+(M8)
L(M6)

FRONT BEARING	↻ 21	593563
REAR BEARING	↻ 22	593564
PROTECTION COVER	↻ 24	593322
SEP:SEPARATED REGULATOR -INC:BUILT-IN REGULATOR	↻ 02	593319
RECTIFIER OR DIODE BRIDGE ASSEMBLY	↻ 07	593320
FRONT BEARING	↻ 21	592866
PULLEY FREE WHEEL + CAP PROTECTION	↻ 11c	*595391
REPAIRE KIT	↻ 29	592854
ROTOR	↻ 04	593298
STATOR	↻ 05	592832

Valeo

439333/437346

A13VI203

80 2 6V

14 ↻ 40° ∇ Ø 57,5 INC

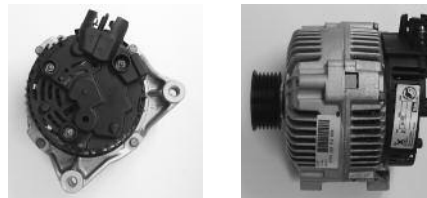
B+(M8)
L(M5)

FRONT BEARING	↻ 21	593563
REAR BEARING	↻ 22	593564
PROTECTION COVER	↻ 24	592946
SEP:SEPARATED REGULATOR -INC:BUILT-IN REGULATOR	↻ 02	593350
CONDENSOR	↻ 14	592853
RECTIFIER OR DIODE BRIDGE ASSEMBLY	↻ 07	592848
FRONT BEARING	↻ 21	592866
PULLEY	↻ 11	593519
REPAIRE KIT	↻ 29	592854
STATOR	↻ 05	593579

Valeo

439247/437138

A13VI207

120 2 6V

14 ↻ 35° ∇ Ø 58,18 INC

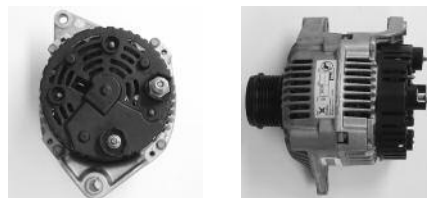

FRONT BEARING	↻ 21	593563
REAR BEARING	↻ 22	593564
PROTECTION COVER	↻ 24	593315
SEP:SEPARATED REGULATOR -INC:BUILT-IN REGULATOR	↻ 02	593290
RECTIFIER OR DIODE BRIDGE ASSEMBLY	↻ 07	593324
REPAIRE KIT	↻ 29	592854
ROTOR	↻ 04	593325
STATOR	↻ 05	593161

Valeo

439208/436735

A13VI208

120 2 6V

14 ↻ Ø 58,18 INC

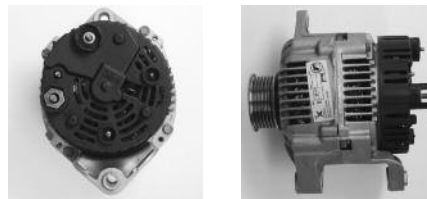

FRONT BEARING	↻ 21	593563
REAR BEARING	↻ 22	593564
PROTECTION COVER	↻ 24	593315
SEP:SEPARATED REGULATOR -INC:BUILT-IN REGULATOR	↻ 02	593290
RECTIFIER OR DIODE BRIDGE ASSEMBLY	↻ 07	593324
REPAIRE KIT	↻ 29	592854
ROTOR	↻ 04	593325
STATOR	↻ 05	593161

Valeo

439209/436736

A13VI209

110

2

6V

14



35°

Ø 58,18

INC

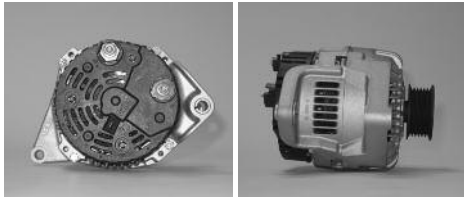

FRONT BEARING 21 593563
 REAR BEARING 22 593564
 PROTECTION COVER 24 593315
 SEP:SEPARATED REGULATOR -INC:BUILT-IN REGULATOR 02 593310
 RECTIFIER OR DIODE BRIDGE ASSEMBLY 07 593172
 REPAIRE KIT 29 592854
 ROTOR 04 593298
 STATOR 05 592832

Valeo

439199/436728

A13VI21

110

2

4V

14



0°

Ø 64,8

INC



FRONT BEARING 21 593563
 REAR BEARING 22 593564
 PROTECTION COVER 24 592944
 CONDENSOR 14 592852
 RECTIFIER OR DIODE BRIDGE ASSEMBLY 07 592846
 PULLEY 11 592923
 REPAIRE KIT 29 592854
 ROTOR 04 592818
 ROTOR 04 593298
 STATOR 05 592832

Valeo

433170/436280

A13VI210

110

2

6V

14



35°

Ø 58,18

INC

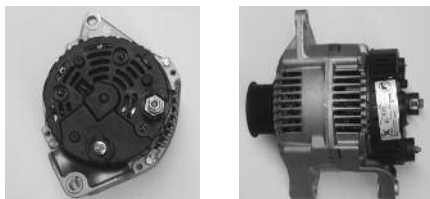

FRONT BEARING 21 593563
 REAR BEARING 22 593564
 PROTECTION COVER 24 593315
 SEP:SEPARATED REGULATOR -INC:BUILT-IN REGULATOR 02 593290
 RECTIFIER OR DIODE BRIDGE ASSEMBLY 07 593172
 REPAIRE KIT 29 592854
 ROTOR 04 593298
 STATOR 05 592832

Valeo

439200/436729

A13VI211

80

2

6V

14



35°

Ø 58,18

INC



FRONT BEARING 21 593563
 REAR BEARING 22 593564
 PROTECTION COVER 24 593315
 SEP:SEPARATED REGULATOR -INC:BUILT-IN REGULATOR 02 593290
 RECTIFIER OR DIODE BRIDGE ASSEMBLY 07 593175
 REPAIRE KIT 29 592854
 ROTOR 04 593298
 STATOR 05 592831

Valeo

439201/436730

A13VI212

80

2

3V

14



19°

Ø 67,2

INC



FRONT BEARING 21 593563
 REAR BEARING 22 593564
 PROTECTION COVER 24 593315
 SEP:SEPARATED REGULATOR -INC:BUILT-IN REGULATOR 02 593310
 RECTIFIER OR DIODE BRIDGE ASSEMBLY 07 593304
 PULLEY 11 593746
 REPAIRE KIT 29 592854
 ROTOR 04 593298
 STATOR 05 592831

Valeo

439210/436737

A13VI213

110

2

3V

14



19°

Ø 67,2

INC



FRONT BEARING 21 593563
 REAR BEARING 22 593564
 PROTECTION COVER 24 593315
 SEP:SEPARATED REGULATOR -INC:BUILT-IN REGULATOR 02 593310
 RECTIFIER OR DIODE BRIDGE ASSEMBLY 07 593299
 PULLEY 11 593746
 REPAIRE KIT 29 592854
 ROTOR 04 593298
 STATOR 05 592832

Valeo

439222/436745



A13VI216

110 2 6V

14 ↻ 0° ∇ Ø 58,18 INC



FRONT BEARING	593563
REAR BEARING	593564
PROTECTION COVER	593315
SEP:SEPARATED REGULATOR -INC:BUILT-IN REGULATOR	02593310
RECTIFIER OR DIODE BRIDGE ASSEMBLY	593172
REPAIRE KIT	592854
ROTOR	593298
STATOR	592832
Valeo	439207/436733

A13VI217

80 2 6V

14 ↻ 0° ∇ Ø 58,18 INC

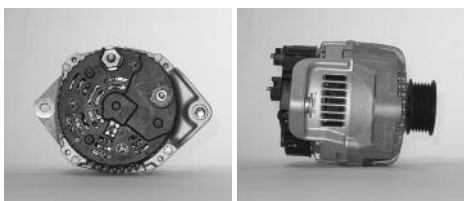

FRONT BEARING	593563
REAR BEARING	593564
PROTECTION COVER	593315
SEP:SEPARATED REGULATOR -INC:BUILT-IN REGULATOR	02593310
RECTIFIER OR DIODE BRIDGE ASSEMBLY	593175
REPAIRE KIT	592854
ROTOR	593298
STATOR	592831
Valeo	439212/436739

A13VI218

110 2 6V

14 ↻ 26° ∇ Ø 55 INC



FRONT BEARING	593563
REAR BEARING	593564
PROTECTION COVER	593315
SEP:SEPARATED REGULATOR -INC:BUILT-IN REGULATOR	02593310
RECTIFIER OR DIODE BRIDGE ASSEMBLY	593299
PULLEY	593543
REPAIRE KIT	592854
ROTOR	593298
STATOR	592832
Valeo	439251/437142

A13VI22

110 2 5V

14 ↻ 0° ∇ Ø 62,9

Picture not available
Image non disponible
Imagen no disponible
Immagine non disponibile
Nicht verfügbares Bild
Brak zdjęcia
Картина недоступна

Picture not available
Image non disponible
Imagen no disponible
Immagine non disponibile
Nicht verfügbares Bild
Brak zdjęcia
Картина недоступна

FRONT BEARING	593563
REAR BEARING	593564
CONDENSOR	592852
RECTIFIER OR DIODE BRIDGE ASSEMBLY	592846
PULLEY	593738
REPAIRE KIT	592854
ROTOR	592818
ROTOR	593298
STATOR	592832
Valeo	433164

A13VI220

90 1 6V

14 ↻ 60° ∇ Ø 49 INC

Picture not available
Image non disponible
Imagen no disponible
Immagine non disponibile
Nicht verfügbares Bild
Brak zdjęcia
Картина недоступна

Picture not available
Image non disponible
Imagen no disponible
Immagine non disponibile
Nicht verfügbares Bild
Brak zdjęcia
Картина недоступна

B+(M8)D+(M5)

FRONT BEARING	593563
REAR BEARING	593564
PROTECTION COVER	593235
SEP:SEPARATED REGULATOR -INC:BUILT-IN REGULATOR	02593350
CONDENSOR	593233
RECTIFIER OR DIODE BRIDGE ASSEMBLY	592917
FRONT BEARING	592866
PULLEY	593718
REPAIRE KIT	592854
ROTOR	593298
STATOR	592832
Valeo	439095/436667

A13VI222

90 1 6V

14 ↻ 60° ∇ Ø 57 INC

**B+(M8)D+(M5)**

FRONT BEARING	593563
REAR BEARING	593564
PROTECTION COVER	593235
SEP:SEPARATED REGULATOR -INC:BUILT-IN REGULATOR	02593350
CONDENSOR	593233
RECTIFIER OR DIODE BRIDGE ASSEMBLY	592917
FRONT BEARING	592866
PULLEY FREE WHEEL + CAP PROTECTION	11c 593495
REPAIRE KIT	592854
ROTOR	593298
STATOR	592832
Valeo	439198/436718

A13VI223

90 2 6V

14  90°  Ø 50,5

Picture not available
Image non disponible
Imagem no disponibile
Immagine non disponibile
Nicht verfügbares Bild
Brak zdjęcia
Картина недоступна

Picture not available
Image non disponible
Imagem no disponibile
Immagine non disponibile
Nicht verfügbares Bild
Brak zdjęcia
Картина недоступна

FRONT BEARING 	593563
REAR BEARING 	593564
PROTECTION COVER 	593367
SEP:SEPARATED REGULATOR -INC:BUILT-IN REGULATOR 	593362
RECTIFIER OR DIODE BRIDGE ASSEMBLY 	593364
REPAIRE KIT 	592854
ROTOR 	593298
STATOR 	592832
Valeo	439255/437169

A13VI224

80 2 6V

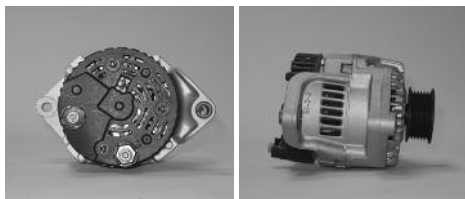







14  0°  Ø 58,18 INC

FRONT BEARING 	593563
REAR BEARING 	593564
PROTECTION COVER 	593315
SEP:SEPARATED REGULATOR -INC:BUILT-IN REGULATOR 	593310
RECTIFIER OR DIODE BRIDGE ASSEMBLY 	593175
REPAIRE KIT 	592854
ROTOR 	593298
STATOR 	592831
Valeo	439211/436738

A13VI227

110 2 6V







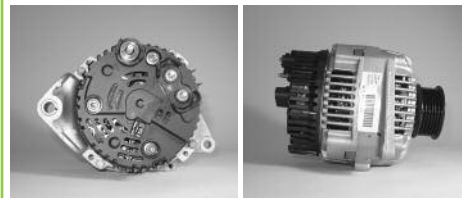

14  0°  Ø 55 INC

FRONT BEARING 	593563
REAR BEARING 	593564
PROTECTION COVER 	593315
SEP:SEPARATED REGULATOR -INC:BUILT-IN REGULATOR 	593310
RECTIFIER OR DIODE BRIDGE ASSEMBLY 	593299
PULLEY 	593747
REPAIRE KIT 	592854
ROTOR 	593298
STATOR 	592832
Valeo	439250/437141

A13VI23

80 2 6V









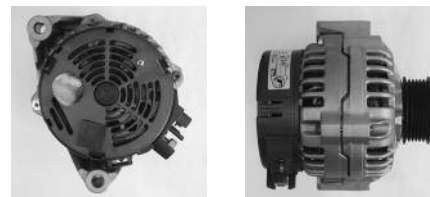

14  27°  Ø 61,1 INC

FRONT BEARING 	593563
REAR BEARING 	593564
PROTECTION COVER 	592944
CONDENSOR 	592852
RECTIFIER OR DIODE BRIDGE ASSEMBLY 	592847
PULLEY 	592921
REPAIRE KIT 	592854
ROTOR 	592818
STATOR 	592831
Valeo	433171/436281

A13VI230

80 1 6V









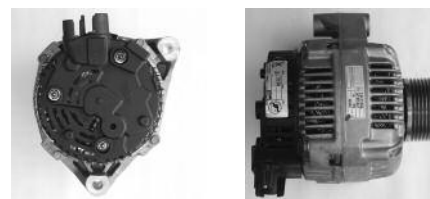

14  45°  Ø 66 INC**B+(M8)D+(M5)**

FRONT BEARING 	593563
REAR BEARING 	593564
PROTECTION COVER 	592946
SEP:SEPARATED REGULATOR -INC:BUILT-IN REGULATOR 	593350
CONDENSOR 	592853
RECTIFIER OR DIODE BRIDGE ASSEMBLY 	592848
FRONT BEARING 	592866
REPAIRE KIT 	592854
ROTOR 	593298
STATOR 	592831
Valeo	439102/436668

A13VI231

97 1 6V

14  45°  Ø 66 INC**B+(M8)D+(M5)**

FRONT BEARING 	593563
REAR BEARING 	593564
PROTECTION COVER 	592946
SEP:SEPARATED REGULATOR -INC:BUILT-IN REGULATOR 	593350
CONDENSOR 	592853
RECTIFIER OR DIODE BRIDGE ASSEMBLY 	592848
FRONT BEARING 	592866
REPAIRE KIT 	592854
ROTOR 	593147
STATOR 	593158
Valeo	439056/436613

A13VI232

80

1

6V

14



45°

Ø 59,4

INC

**B+(M8)D+(M5)**

FRONT BEARING	21	593563
REAR BEARING	22	593564
PROTECTION COVER	24	592946
SEP:SEPARATED REGULATOR -INC:BUILT-IN REGULATOR	02	593350
CONDENSOR	14	592853
RECTIFIER OR DIODE BRIDGE ASSEMBLY	07	592848
FRONT BEARING	21	592866
PULLEY	11	593743
REPAIRE KIT	29	592854
ROTOR	04	593298
STATOR	05	592831

Valeo**439071/436642****A13VI233**

97

1

6V

14



45°

Ø 59,4

INC

**B+(M8)D+(M5)**

FRONT BEARING	21	593563
REAR BEARING	22	593564
PROTECTION COVER	24	592946
SEP:SEPARATED REGULATOR -INC:BUILT-IN REGULATOR	02	593350
CONDENSOR	14	592853
RECTIFIER OR DIODE BRIDGE ASSEMBLY	07	592848
FRONT BEARING	21	592866
PULLEY	11	593743
REPAIRE KIT	29	592854
ROTOR	04	593147
STATOR	05	593158

Valeo**439083/436654****A13VI234**

100

2

5V

14



35°

Ø 54,8

INC



FRONT BEARING	21	593563
REAR BEARING	22	593564
PROTECTION COVER	24	593352
SEP:SEPARATED REGULATOR -INC:BUILT-IN REGULATOR	02	593333
RECTIFIER OR DIODE BRIDGE ASSEMBLY	07	593204
PULLEY	11	593755
REPAIRE KIT	29	592854
ROTOR	04	593147

Valeo**439301/437227****A13VI235**

80

2

3V

14



25°

Ø 67,2

INC



FRONT BEARING	21	593563
REAR BEARING	22	593564
PROTECTION COVER	24	593317
SEP:SEPARATED REGULATOR -INC:BUILT-IN REGULATOR	02	593411
RECTIFIER OR DIODE BRIDGE ASSEMBLY	07	593204
PULLEY	11	593751
REPAIRE KIT	29	592854
ROTOR	04	593298
STATOR	05	592831

Valeo**439254/437168****A13VI237**

90

5V

14



Ø 53

INC

**B+(M8)
L(M6)**

FRONT BEARING	21	593563
REAR BEARING	22	593564
PROTECTION COVER	24	593322
SEP:SEPARATED REGULATOR -INC:BUILT-IN REGULATOR	02	593319
RECTIFIER OR DIODE BRIDGE ASSEMBLY	07	593320
FRONT BEARING	21	592866
PULLEY	11	593730
REPAIRE KIT	29	592854
ROTOR	04	593298
STATOR	05	592832

Valeo**439206/436732****A13VI238**

120

2

6V

14



0°

Ø 58,18

INC



FRONT BEARING	21	593563
REAR BEARING	22	593564
PROTECTION COVER	24	593374
SEP:SEPARATED REGULATOR -INC:BUILT-IN REGULATOR	02	593411
RECTIFIER OR DIODE BRIDGE ASSEMBLY	07	593174
REPAIRE KIT	29	592854
ROTOR	04	593325
STATOR	05	593161

Valeo**439266/437183**

A13VI24

90

2

6V

14



60°

Ø 68,2

Picture not available
Image non disponible
Imagen no disponible
Immagine non disponibile
Nicht verfügbares Bild
Brak zdjęcia
Картина недоступна

Picture not available
Image non disponible
Imagen no disponible
Immagine non disponibile
Nicht verfügbares Bild
Brak zdjęcia
Картина недоступна

FRONT BEARING 21

593563

SEP:SEPARATED REGULATOR -INC:BUILT-IN REGULATOR 02593131**CONDENSOR** 14

592850

RECTIFIER OR DIODE BRIDGE ASSEMBLY 07

592917

FRONT BEARING 21

592866

PULLEY 11

593696

REPAIRE KIT 29

592854

ROTOR 04

592818

STATOR 05

592831

A13VI24

90

2

6V

14



60°

Ø 68,2

Picture not available
Image non disponible
Imagen no disponible
Immagine non disponibile
Nicht verfügbares Bild
Brak zdjęcia
Картина недоступна

Picture not available
Image non disponible
Imagen no disponible
Immagine non disponibile
Nicht verfügbares Bild
Brak zdjęcia
Картина недоступна

FRONT BEARING 21

593563

SEP:SEPARATED REGULATOR -INC:BUILT-IN REGULATOR 02593131**CONDENSOR** 14

592850

RECTIFIER OR DIODE BRIDGE ASSEMBLY 07

592917

FRONT BEARING 21

592866

PULLEY 11

593696

REPAIRE KIT 29

592854

ROTOR 04

592818

STATOR 05

592831

Valeo**439219/436381****A13VI241**

90

2

6V

14



74-87°

Ø 53,2

INC

**FRONT BEARING** 21

593563

REAR BEARING 22

593564

PROTECTION COVER 24

593367

SEP:SEPARATED REGULATOR -INC:BUILT-IN REGULATOR 02593362**RECTIFIER OR DIODE BRIDGE ASSEMBLY** 07

593366

REPAIRE KIT 29

592854

ROTOR 04

593298

STATOR 05

592832

Valeo**439258/437172****A13VI242**

97

4

6V

14



40°

Ø 57,5

INC

**FRONT BEARING** 21

593563

REAR BEARING 22

593564

PROTECTION COVER 24

593376

SEP:SEPARATED REGULATOR -INC:BUILT-IN REGULATOR 02593375**CONDENSOR** 14

593377

RECTIFIER OR DIODE BRIDGE ASSEMBLY 07

592848

FRONT BEARING 21

592866

PULLEY 11

593754

REPAIRE KIT 29

592854

ROTOR 04

593147

STATOR 05

593158

Valeo**437193****A13VI243**

120

2

2V

14



60°

Ø 70,5

Picture not available
Image non disponible
Imagen no disponible
Immagine non disponibile
Nicht verfügbares Bild
Brak zdjęcia
Картина недоступна

Picture not available
Image non disponible
Imagen no disponible
Immagine non disponibile
Nicht verfügbares Bild
Brak zdjęcia
Картина недоступна

FRONT BEARING 21

593563

REAR BEARING 22

593564

PROTECTION COVER 24

593295

SEP:SEPARATED REGULATOR -INC:BUILT-IN REGULATOR 02593350**CONDENSOR** 14

593383

RECTIFIER OR DIODE BRIDGE ASSEMBLY 07

593382

PULLEY 11

593721

REPAIRE KIT 29

592854

ROTOR 04

593147

STATOR 05

593161

Valeo**439279/437195****A13VI244**

120

2

12V

14



60°

Ø 52,92

Picture not available
Image non disponible
Imagen no disponible
Immagine non disponibile
Nicht verfügbares Bild
Brak zdjęcia
Картина недоступна

Picture not available
Image non disponible
Imagen no disponible
Immagine non disponibile
Nicht verfügbares Bild
Brak zdjęcia
Картина недоступна

FRONT BEARING 21

593563

REAR BEARING 22

593564

PROTECTION COVER 24

593295

SEP:SEPARATED REGULATOR -INC:BUILT-IN REGULATOR 02593350**CONDENSOR** 14

593383

RECTIFIER OR DIODE BRIDGE ASSEMBLY 07

593382

PULLEY 11

593734

REPAIRE KIT 29

592854

ROTOR 04

593147

STATOR 05

593161

Valeo**439293/437209**

A13VI246

97

1

5V

14



60°

Ø 59,4

INC



FRONT BEARING	21	593563
REAR BEARING	22	593564
PROTECTION COVER	24	593376
SEP:SEPARATED REGULATOR -INC:BUILT-IN REGULATOR	02	593375
CONDENSOR	14	593377
RECTIFIER OR DIODE BRIDGE ASSEMBLY	07	592848
FRONT BEARING	21	592866
PULLEY	11	592929
REPAIRE KIT	29	592854
ROTOR	04	593147
STATOR	05	593158

Valeo**439269/437186****A13VI249**

120

2

6V

14



35°

Ø 58,18

Picture not available
Image non disponible
Imagem no disponible
Immagine non disponibile
Nicht verfügbares Bild
Brak zdjęcia
Картина недоступна

Picture not available
Image non disponible
Imagem no disponible
Immagine non disponibile
Nicht verfügbares Bild
Brak zdjęcia
Картина недоступна

FRONT BEARING	21	593563
REAR BEARING	22	593564
PROTECTION COVER	24	593374
SEP:SEPARATED REGULATOR -INC:BUILT-IN REGULATOR	02	593411
RECTIFIER OR DIODE BRIDGE ASSEMBLY	07	593174
REPAIRE KIT	29	592854
ROTOR	04	593325
STATOR	05	593161

Valeo**439267/437184****A13VI25**

110

2

6V

14



19°

Ø 61,1

INC



FRONT BEARING	21	593563
REAR BEARING	22	593564
PROTECTION COVER	24	592944
CONDENSOR	14	592852
RECTIFIER OR DIODE BRIDGE ASSEMBLY	07	592846
PULLEY	11	592925
REPAIRE KIT	29	592854
ROTOR	04	592818
ROTOR	04	593298
STATOR	05	592832

Valeo**433172/436282****A13VI251**

110

2

6V

14



35°

Ø 58,18

INC



FRONT BEARING	21	593563
REAR BEARING	22	593564
PROTECTION COVER	24	593374
SEP:SEPARATED REGULATOR -INC:BUILT-IN REGULATOR	02	593411
RECTIFIER OR DIODE BRIDGE ASSEMBLY	07	593329
REPAIRE KIT	29	592854
ROTOR	04	593298
STATOR	05	592832

Valeo**439280/437196****A13VI252**

80

2

6V

14



35°

Ø 58,18

INC



FRONT BEARING	21	593563
REAR BEARING	22	593564
PROTECTION COVER	24	593374
SEP:SEPARATED REGULATOR -INC:BUILT-IN REGULATOR	02	593411
RECTIFIER OR DIODE BRIDGE ASSEMBLY	07	593306
REPAIRE KIT	29	592854
ROTOR	04	593298
STATOR	05	592831

Valeo**439281/437197****A13VI253**

110

2

6V

14



0°

Ø 58,18

INC



FRONT BEARING	21	593563
REAR BEARING	22	593564
PROTECTION COVER	24	593374
SEP:SEPARATED REGULATOR -INC:BUILT-IN REGULATOR	02	593411
RECTIFIER OR DIODE BRIDGE ASSEMBLY	07	593329
REPAIRE KIT	29	592854
ROTOR	04	593298
STATOR	05	592832

Valeo**439284/437200**

A13VI254

120

2

6V

14



35°

Ø 58,18

INC

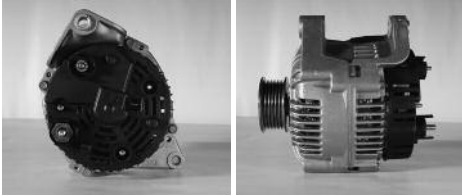

FRONT BEARING 21 593563
 REAR BEARING 22 593564
 PROTECTION COVER 24 593315
 SEP:SEPARATED REGULATOR -INC:BUILT-IN REGULATOR 02 593310
 RECTIFIER OR DIODE BRIDGE ASSEMBLY 07 593324
 REPAIRE KIT 29 592854
 ROTOR 04 593325
 STATOR 05 593161

Valeo**439282/437198****A13VI255**

120

2

6V

14



0°

Ø 58,18

INC



FRONT BEARING 21 593563
 REAR BEARING 22 593564
 PROTECTION COVER 24 593315
 SEP:SEPARATED REGULATOR -INC:BUILT-IN REGULATOR 02 593310
 RECTIFIER OR DIODE BRIDGE ASSEMBLY 07 593324
 PULLEY 11 593752
 REPAIRE KIT 29 592854
 ROTOR 04 593325
 STATOR 05 593161

Valeo**439283/437199****A13VI256**

80

1

5V

14



60°

Ø 59,4

INC



FRONT BEARING 21 593563
 REAR BEARING 22 593564
 PROTECTION COVER 24 593376
 SEP:SEPARATED REGULATOR -INC:BUILT-IN REGULATOR 02 593375
 CONDENSOR 14 593377
 RECTIFIER OR DIODE BRIDGE ASSEMBLY 07 592848
 FRONT BEARING 21 592866
 PULLEY 11 592929
 REPAIRE KIT 29 592854
 ROTOR 04 593298
 STATOR 05 592831

Valeo**439268/437185****A13VI257**

90

5V

14



Ø 53

INC

**B+(M8)
L(M6)**

FRONT BEARING 21 593563
 REAR BEARING 22 593564
 PROTECTION COVER 24 593322
 SEP:SEPARATED REGULATOR -INC:BUILT-IN REGULATOR 02 593319
 RECTIFIER OR DIODE BRIDGE ASSEMBLY 07 593320
 FRONT BEARING 21 592866
 PULLEY FREE WHEEL + CAP PROTECTION 11c *595391
 REPAIRE KIT 29 592854
 ROTOR 04 593298
 STATOR 05 592832

Valeo**439232/437114****A13VI258**

97

1

6V

14



45°

Ø 66

INC

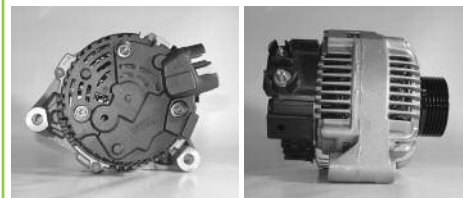
**B+(M8)D+(M5)**

FRONT BEARING 21 593563
 REAR BEARING 22 593564
 PROTECTION COVER 24 592946
 SEP:SEPARATED REGULATOR -INC:BUILT-IN REGULATOR 02 593350
 CONDENSOR 14 592853
 RECTIFIER OR DIODE BRIDGE ASSEMBLY 07 592848
 REPAIRE KIT 29 592854
 ROTOR 04 593147
 STATOR 05 593158

Valeo**439270/437187****A13VI259**

110

2

6V

14



25°

Ø 55

INC

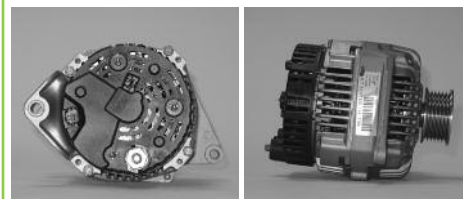

FRONT BEARING 21 593563
 REAR BEARING 22 593564
 PROTECTION COVER 24 593374
 SEP:SEPARATED REGULATOR -INC:BUILT-IN REGULATOR 02 593411
 RECTIFIER OR DIODE BRIDGE ASSEMBLY 07 593327
 PULLEY 11 593543
 REPAIRE KIT 29 592854
 ROTOR 04 593298
 STATOR 05 592832

Valeo**439302/437306**

A13VI260

80 1 6V

14 ↻ 45° ∇ Ø 66 INC

**B+(M8)D+(M5)**

FRONT BEARING	↗ 21	593563
REAR BEARING	↗ 22	593564
PROTECTION COVER	↗ 24	592946
SEP:SEPARATED REGULATOR -INC:BUILT-IN REGULATOR	↗ 02	593350
CONDENSOR	↗ 14	592853
RECTIFIER OR DIODE BRIDGE ASSEMBLY	↗ 07	592848
PULLEY	↗ 11	593735
REPAIRE KIT	↗ 29	592854
ROTOR	↗ 04	593298
STATOR	↗ 05	592831

Valeo**439102/436668****A13VI261**

97 1 6V

14 ↻ 53° ∇ Ø 66 INC

**B+(M8)D+(M5)**

FRONT BEARING	↗ 21	593563
REAR BEARING	↗ 22	593564
PROTECTION COVER	↗ 24	592946
SEP:SEPARATED REGULATOR -INC:BUILT-IN REGULATOR	↗ 02	593350
CONDENSOR	↗ 14	592853
RECTIFIER OR DIODE BRIDGE ASSEMBLY	↗ 07	592848
FRONT BEARING	↗ 21	592866
PULLEY	↗ 11	593735
REPAIRE KIT	↗ 29	592854
ROTOR	↗ 04	593147
STATOR	↗ 05	593158

Valeo**439056/436613****A13VI262**

80 1 6V

14 ↻ 45° ∇ Ø 59,4 INC

**B+(M8)D+(M5)**

FRONT BEARING	↗ 21	593563
REAR BEARING	↗ 22	593564
PROTECTION COVER	↗ 24	592946
SEP:SEPARATED REGULATOR -INC:BUILT-IN REGULATOR	↗ 02	593350
CONDENSOR	↗ 14	592853
RECTIFIER OR DIODE BRIDGE ASSEMBLY	↗ 07	592848
FRONT BEARING	↗ 21	592866
PULLEY	↗ 11	593763
REPAIRE KIT	↗ 29	592854
ROTOR	↗ 04	593298
STATOR	↗ 05	592831

Valeo**439071/436642****A13VI263**

97 1 6V

14 ↻ 45° ∇ Ø 59,4 INC

**B+(M8)D+(M5)**

FRONT BEARING	↗ 21	593563
REAR BEARING	↗ 22	593564
PROTECTION COVER	↗ 24	592946
SEP:SEPARATED REGULATOR -INC:BUILT-IN REGULATOR	↗ 02	593350
CONDENSOR	↗ 14	592853
RECTIFIER OR DIODE BRIDGE ASSEMBLY	↗ 07	592848
FRONT BEARING	↗ 21	592866
PULLEY	↗ 11	593763
REPAIRE KIT	↗ 29	592854
ROTOR	↗ 04	593147
STATOR	↗ 05	593158

Valeo**439083/436654****A13VI264**

110 2 6V

14 ↻ 0° ∇ Ø 58,18 INC



FRONT BEARING	↗ 21	593563
REAR BEARING	↗ 22	593564
PROTECTION COVER	↗ 24	593315
SEP:SEPARATED REGULATOR -INC:BUILT-IN REGULATOR	↗ 02	593290
RECTIFIER OR DIODE BRIDGE ASSEMBLY	↗ 07	593172
REPAIRE KIT	↗ 29	592854
ROTOR	↗ 04	593298
STATOR	↗ 05	592832

Valeo**439285/437201****A13VI265**

110 2 6V

14 ↻ 35° ∇ Ø 58,18 INC



FRONT BEARING	↗ 21	593563
REAR BEARING	↗ 22	593564
PROTECTION COVER	↗ 24	593315
SEP:SEPARATED REGULATOR -INC:BUILT-IN REGULATOR	↗ 02	593290
RECTIFIER OR DIODE BRIDGE ASSEMBLY	↗ 07	593172
REPAIRE KIT	↗ 29	592854
ROTOR	↗ 04	593298
STATOR	↗ 05	592832

Valeo**439286/437202**

A13VI266

80

2

3V

14



19°

Ø 67,2

INC



FRONT BEARING 21 593563
 REAR BEARING 22 593564
 PROTECTION COVER 24 593315
 SEP:SEPARATED REGULATOR -INC:BUILT-IN REGULATOR 02 593290
 RECTIFIER OR DIODE BRIDGE ASSEMBLY 07 593304
 PULLEY 11 593746
 REPAIRE KIT 29 592854
 ROTOR 04 593298
 STATOR 05 592831

Valeo**439289/437204****A13VI267**

110

2

3V

14



19°

Ø 67,2

INC

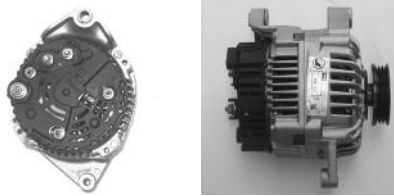

FRONT BEARING 21 593563
 REAR BEARING 22 593564
 PROTECTION COVER 24 593315
 SEP:SEPARATED REGULATOR -INC:BUILT-IN REGULATOR 02 593290
 RECTIFIER OR DIODE BRIDGE ASSEMBLY 07 593299
 PULLEY 11 593746
 REPAIRE KIT 29 592854
 ROTOR 04 593298
 STATOR 05 592832

Valeo**439290/437205****A13VI268**

110

2

4V

14



25°

Ø 55

INC



FRONT BEARING 21 593563
 REAR BEARING 22 593564
 PROTECTION COVER 24 593315
 SEP:SEPARATED REGULATOR -INC:BUILT-IN REGULATOR 02 593290
 RECTIFIER OR DIODE BRIDGE ASSEMBLY 07 593299
 PULLEY 11 593543
 REPAIRE KIT 29 592854
 ROTOR 04 593298
 STATOR 05 592832

Valeo**439251/437142****A13VI269**

110

2

4V

14



0°

Ø 55

INC

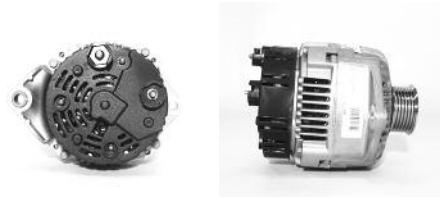

FRONT BEARING 21 593563
 REAR BEARING 22 593564
 PROTECTION COVER 24 593315
 SEP:SEPARATED REGULATOR -INC:BUILT-IN REGULATOR 02 593290
 RECTIFIER OR DIODE BRIDGE ASSEMBLY 07 593299
 PULLEY 11 593747
 REPAIRE KIT 29 592854
 ROTOR 04 593298
 STATOR 05 592832

Valeo**439250/437141****A13VI273**

97

2

5V

14



Ø 66

INC

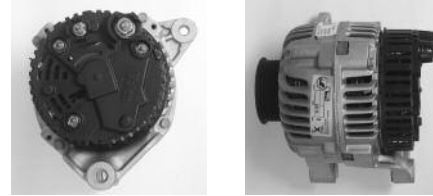
**B+(M8)D+(M5)**

FRONT BEARING 21 593563
 REAR BEARING 22 593564
 PROTECTION COVER 24 *592942
 SEP:SEPARATED REGULATOR -INC:BUILT-IN REGULATOR 02 593350
 CONDENSOR 14 592851
 RECTIFIER OR DIODE BRIDGE ASSEMBLY 07 593163
 FRONT BEARING 21 592866
 PULLEY 11 593764
 REPAIRE KIT 29 592854
 ROTOR 04 593147
 STATOR 05 593158

Valeo**439103/436669****A13VI274**

97

1

6V

14



53°

Ø 66

INC

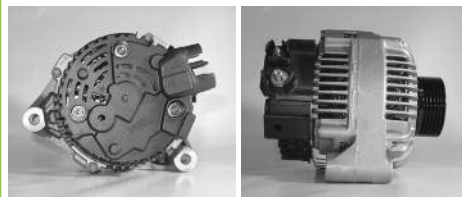
**B+(M8)D+(M5)**

FRONT BEARING 21 593563
 REAR BEARING 22 593564
 PROTECTION COVER 24 592946
 SEP:SEPARATED REGULATOR -INC:BUILT-IN REGULATOR 02 593350
 CONDENSOR 14 592853
 RECTIFIER OR DIODE BRIDGE ASSEMBLY 07 592848
 PULLEY 11 593735
 REPAIRE KIT 29 592854
 ROTOR 04 593147
 STATOR 05 593158

Valeo**439270/437187**

A13VI276

80 4 6V

14 ↻ 40° ∇ Ø 57,5 INC

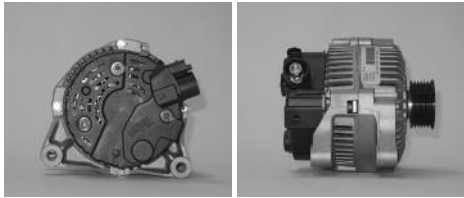

FRONT BEARING 21 593563
 REAR BEARING 22 593564
 PROTECTION COVER 24 593376
 SEP:SEPARATED REGULATOR -INC:BUILT-IN REGULATOR 02 593419
 CONDENSOR 14 593421
 RECTIFIER OR DIODE BRIDGE ASSEMBLY 07 593420
 PULLEY 11 593519
 REPAIRE KIT 29 592854
 STATOR 05 593579

Valeo**439277/437356****A13VI277**

90 4 6V

14 ↻ 40° ∇ Ø 57,5 INC

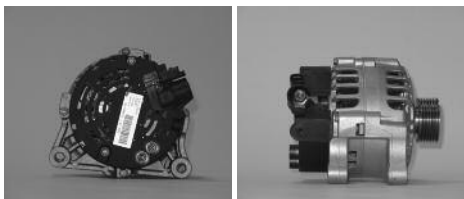

FRONT BEARING 21 593563
 REAR BEARING 22 593564
 PROTECTION COVER 24 593376
 SEP:SEPARATED REGULATOR -INC:BUILT-IN REGULATOR 02 593419
 CONDENSOR 14 593421
 RECTIFIER OR DIODE BRIDGE ASSEMBLY 07 593420
 PULLEY 11 593754
 REPAIRE KIT 29 592854
 ROTOR 04 593147
 STATOR 05 593158

Valeo**439276/437357****A13VI278**

80 1 5V

14 ↻ 60° ∇ Ø 59,4

Picture not available
 Image non disponible
 Imagen no disponible
 Immagine non disponibile
 Nicht verfügbares Bild
 Brak zdjęcia
 Картина недоступна

Picture not available
 Image non disponible
 Imagen no disponible
 Immagine non disponibile
 Nicht verfügbares Bild
 Brak zdjęcia
 Картина недоступна

FRONT BEARING 21 593563
 REAR BEARING 22 593564
 PROTECTION COVER 24 593376
 SEP:SEPARATED REGULATOR -INC:BUILT-IN REGULATOR 02 593419
 CONDENSOR 14 593421
 RECTIFIER OR DIODE BRIDGE ASSEMBLY 07 593420
 PULLEY 11 592929
 REPAIRE KIT 29 592854
 STATOR 05 593579

Valeo**439329/437342****A13VI279**

97 1 5V

14 ↻ 60° ∇ Ø 59,4 INC

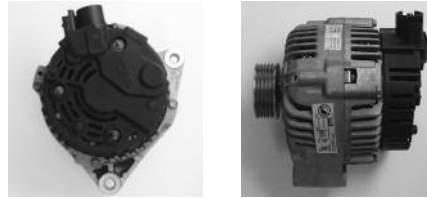

FRONT BEARING 21 593563
 REAR BEARING 22 593564
 PROTECTION COVER 24 593376
 SEP:SEPARATED REGULATOR -INC:BUILT-IN REGULATOR 02 593419
 CONDENSOR 14 593421
 RECTIFIER OR DIODE BRIDGE ASSEMBLY 07 593420
 PULLEY 11 592929
 REPAIRE KIT 29 592854
 ROTOR 04 593147
 STATOR 05 593158

A13VI279

97 1 5V

14 ↻ 60° ∇ Ø 59,4 INC

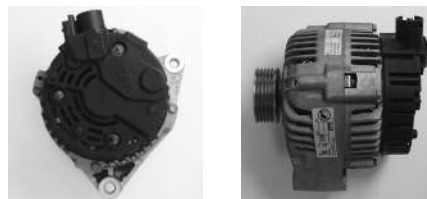

FRONT BEARING 21 593563
 REAR BEARING 22 593564
 PROTECTION COVER 24 593376
 SEP:SEPARATED REGULATOR -INC:BUILT-IN REGULATOR 02 593419
 CONDENSOR 14 593421
 RECTIFIER OR DIODE BRIDGE ASSEMBLY 07 593420
 PULLEY 11 592929
 REPAIRE KIT 29 592854
 ROTOR 04 593147
 STATOR 05 593158

A13VI279

97 1 5V

14 ↻ 60° ∇ Ø 59,4 INC

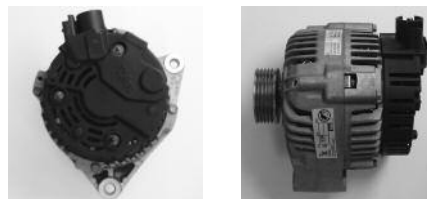

FRONT BEARING 21 593563
 REAR BEARING 22 593564
 PROTECTION COVER 24 593376
 SEP:SEPARATED REGULATOR -INC:BUILT-IN REGULATOR 02 593419
 CONDENSOR 14 593421
 RECTIFIER OR DIODE BRIDGE ASSEMBLY 07 593420
 PULLEY 11 592929
 REPAIRE KIT 29 592854
 ROTOR 04 593147
 STATOR 05 593158

Valeo**439330/437343**

A13VI28

110

2

6V

14



0°

Ø 62,9

INC

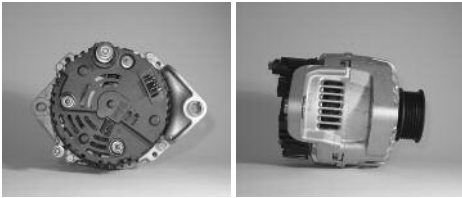

FRONT BEARING	593563
REAR BEARING	593564
PROTECTION COVER	592945
CONDENSOR	592852
RECTIFIER OR DIODE BRIDGE ASSEMBLY	592846
PULLEY	593737
REPAIRE KIT	592854
ROTOR	592818
STATOR	592832
Valeo	436382

A13VI280

80

2

6V

14



20°

Ø 59,4

INC

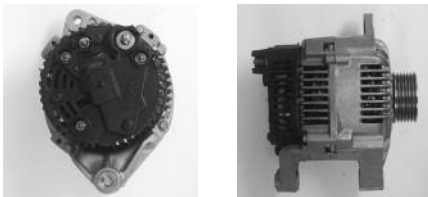
**B+(M8)D+(M5)**

FRONT BEARING	593563
REAR BEARING	593564
PROTECTION COVER	*592942
SEP:SEPARATED REGULATOR -INC:BUILT-IN REGULATOR	02593350
CONDENSOR	592851
RECTIFIER OR DIODE BRIDGE ASSEMBLY	593163
PULLEY	593743
REPAIRE KIT	592854
ROTOR	593298
STATOR	592831
Valeo	439023/436476

A13VI281

97

2

6V

14



20°

Ø 59,4

INC

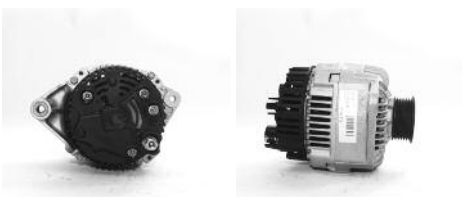
**B+(M8)D+(M5)**

FRONT BEARING	593563
REAR BEARING	593564
PROTECTION COVER	*592942
SEP:SEPARATED REGULATOR -INC:BUILT-IN REGULATOR	02593350
CONDENSOR	592851
RECTIFIER OR DIODE BRIDGE ASSEMBLY	593163
PULLEY	593743
REPAIRE KIT	592854
ROTOR	593147
STATOR	593158
Valeo	433190/436366

A13VI283

90

4

6V

14



40°

Ø 52

INC

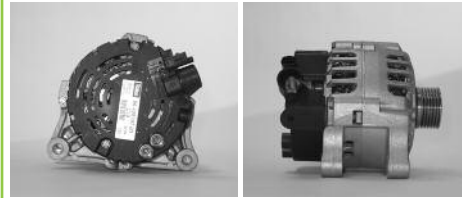

FRONT BEARING	593563
REAR BEARING	593564
PROTECTION COVER	593376
SEP:SEPARATED REGULATOR -INC:BUILT-IN REGULATOR	02593419
CONDENSOR	593421
RECTIFIER OR DIODE BRIDGE ASSEMBLY	593420
PULLEY	593769
REPAIRE KIT	592854
ROTOR	593147
STATOR	593158
Valeo	439449/437409

A13VI284

120

2

8V

14



50°

Ø 52,92

Picture not available
Image non disponible
Imagen no disponible
Immagine non disponibile
Nicht verfügbares Bild
Brak zdjęcia
Картина недоступна

Picture not available
Image non disponible
Imagen no disponible
Immagine non disponibile
Nicht verfügbares Bild
Brak zdjęcia
Картина недоступна

FRONT BEARING	593563
REAR BEARING	593564
PROTECTION COVER	593295
SEP:SEPARATED REGULATOR -INC:BUILT-IN REGULATOR	02593350
CONDENSOR	593383
RECTIFIER OR DIODE BRIDGE ASSEMBLY	593382
PULLEY	593766
REPAIRE KIT	592854
ROTOR	593147
STATOR	593161
Valeo	439322/437326

A13VI285

80

2

6V

14



35°

Ø 59,4

INC



FRONT BEARING	593563
REAR BEARING	593564
PROTECTION COVER	593374
SEP:SEPARATED REGULATOR -INC:BUILT-IN REGULATOR	02593411
RECTIFIER OR DIODE BRIDGE ASSEMBLY	593306
PULLEY FREE WEEL + CAP PROTECTION	593515
REPAIRE KIT	592854
ROTOR	593298
STATOR	592831
Valeo	439334/437347

A13VI286

90 4 6V

14  40°  Ø 53,46 INC



FRONT BEARING  21 593563
 REAR BEARING  22 593564
 PROTECTION COVER  24 593354
 SEP:SEPARATED REGULATOR -INC:BUILT-IN REGULATOR  02 593333
 RECTIFIER OR DIODE BRIDGE ASSEMBLY  07 593204
 PULLEY  11 593727
 REPAIRE KIT  29 592854
 ROTOR  04 593298
 STATOR  05 592832



Valeo

439236/437362

A13VI287

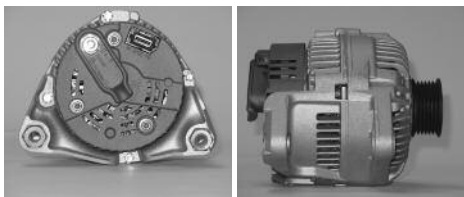
100 4 6V

14  40°  Ø 53,46 INC



FRONT BEARING  21 593563
 REAR BEARING  22 593564
 PROTECTION COVER  24 593354
 SEP:SEPARATED REGULATOR -INC:BUILT-IN REGULATOR  02 593333
 RECTIFIER OR DIODE BRIDGE ASSEMBLY  07 593204
 PULLEY  11 593727
 REPAIRE KIT  29 592854
 ROTOR  04 593147
 STATOR  05 593158











Valeo

439237/437363

A13VI288

80 1 5V

14  60°  Ø 59,4 INC

FRONT BEARING  21 593563
 REAR BEARING  22 593564
 PROTECTION COVER  24 593376
 SEP:SEPARATED REGULATOR -INC:BUILT-IN REGULATOR  02 593419
 CONDENSOR  14 593421
 RECTIFIER OR DIODE BRIDGE ASSEMBLY  07 593420
 PULLEY  11 592929
 REPAIRE KIT  29 592854
 ROTOR  04 593298
 STATOR  05 592831

Valeo

439331/437344

A13VI289

120 2 6V

14  35°  Ø 59,4

Picture not available
 Image non disponible
 Imagen no disponible
 Immagine non disponibile
 Nicht verfügbares Bild
 Brak zdjęcia
 Картина недоступна

Picture not available
 Image non disponible
 Imagen no disponible
 Immagine non disponibile
 Nicht verfügbares Bild
 Brak zdjęcia
 Картина недоступна

FRONT BEARING  21 593563
 REAR BEARING  22 593564
 PROTECTION COVER  24 593374
 SEP:SEPARATED REGULATOR -INC:BUILT-IN REGULATOR  02 593411
 RECTIFIER OR DIODE BRIDGE ASSEMBLY  07 593174
 PULLEY FREE WHEEL + CAP PROTECTION  11c 593515
 REPAIRE KIT  29 592854
 ROTOR  04 593147
 STATOR  05 593161

Valeo

439389/437354









A13VI290

120 2 6V

14  35°  Ø 58,18

Picture not available
 Image non disponible
 Imagen no disponible
 Immagine non disponibile
 Nicht verfügbares Bild
 Brak zdjęcia
 Картина недоступна

Picture not available
 Image non disponible
 Imagen no disponible
 Immagine non disponibile
 Nicht verfügbares Bild
 Brak zdjęcia
 Картина недоступна

FRONT BEARING  21 593563
 REAR BEARING  22 593564
 PROTECTION COVER  24 593374
 SEP:SEPARATED REGULATOR -INC:BUILT-IN REGULATOR  02 593411
 RECTIFIER OR DIODE BRIDGE ASSEMBLY  07 593174
 REPAIRE KIT  29 592854
 ROTOR  04 593325
 STATOR  05 593161









Valeo

439399/437368

A13VI291

120 2 6V

14  0°  Ø 58,18 INC

FRONT BEARING  21 593563
 REAR BEARING  22 593564
 PROTECTION COVER  24 593374
 SEP:SEPARATED REGULATOR -INC:BUILT-IN REGULATOR  02 593411
 RECTIFIER OR DIODE BRIDGE ASSEMBLY  07 593174
 REPAIRE KIT  29 592854
 ROTOR  04 593325
 STATOR  05 593161

Valeo

439388/437353

A13VI292

120

2

6V

14



35°

Ø 59,4

INC



FRONT BEARING 21 593563
 REAR BEARING 22 593564
 PROTECTION COVER 24 593315
 SEP:SEPARATED REGULATOR -INC:BUILT-IN REGULATOR 02 593290
 RECTIFIER OR DIODE BRIDGE ASSEMBLY 07 593324
 PULLEY FREE WEEL + CAP PROTECTION 11c 593515
 REPAIRE KIT 29 592854
 ROTOR 04 593325
 STATOR 05 593161

Valeo**439208/436735****A13VI293**

120

2

6V

14



90°

Ø 50,5

INC

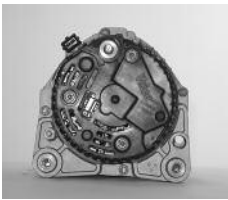

FRONT BEARING 21 593563
 REAR BEARING 22 593564
 PROTECTION COVER 24 593241
 SEP:SEPARATED REGULATOR -INC:BUILT-IN REGULATOR 02 593350
 RECTIFIER OR DIODE BRIDGE ASSEMBLY 07 593468
 PULLEY 11 592920
 REPAIRE KIT 29 592854
 ROTOR 04 593147
 STATOR 05 593161

Valeo**439400/437369****A13VI297**

120

2

6V RL

14



0°

Ø 58,18

INC

Picture not available
 Image non disponible
 Imagen no disponible
 Immagine non disponibile
 Nicht verfügbares Bild
 Brak zdjęcia
 Картина недоступна

Picture not available
 Image non disponible
 Imagen no disponible
 Immagine non disponibile
 Nicht verfügbares Bild
 Brak zdjęcia
 Картина недоступна

FRONT BEARING 21 593563
 REAR BEARING 22 593564
 PROTECTION COVER 24 593374
 SEP:SEPARATED REGULATOR -INC:BUILT-IN REGULATOR 02 593411
 RECTIFIER OR DIODE BRIDGE ASSEMBLY 07 593174
 PULLEY FREE WEEL + CAP PROTECTION 11c 593515
 REPAIRE KIT 29 592854
 ROTOR 04 593325
 STATOR 05 593161

Valeo**439448/437408****A13VI30**

110

2

6V

14



0°

Ø 58,18

INC



FRONT BEARING 21 593563
 REAR BEARING 22 593564
 PROTECTION COVER 24 592945
 CONDENSOR 14 592852
 RECTIFIER OR DIODE BRIDGE ASSEMBLY 07 592846
 REPAIRE KIT 29 592854
 ROTOR 04 592818
 ROTOR 04 593298
 STATOR 05 592832

Valeo**433158/436463****A13VI300**

110

2

6V

14



25°

Ø 55

INC



FRONT BEARING 21 593563
 REAR BEARING 22 593564
 PROTECTION COVER 24 593374
 SEP:SEPARATED REGULATOR -INC:BUILT-IN REGULATOR 02 593411
 RECTIFIER OR DIODE BRIDGE ASSEMBLY 07 593327
 PULLEY 11 593752
 REPAIRE KIT 29 592854
 ROTOR 04 593298
 STATOR 05 592832

Valeo**439302/437306****A13VI302**

90

1

6V

14



60°

Ø 56

INC



FRONT BEARING 21 593563
 REAR BEARING 22 593564
 PROTECTION COVER 24 593295
 SEP:SEPARATED REGULATOR -INC:BUILT-IN REGULATOR 02 593131
 CONDENSOR 14 593233
 RECTIFIER OR DIODE BRIDGE ASSEMBLY 07 593557
 PULLEY FREE WEEL + CAP PROTECTION 11c 593495
 REPAIRE KIT 29 592854
 ROTOR 04 593298
 STATOR 05 592832

Valeo**437489**

A13VI303

90 1 6V

14 ↻ 60° ∇ Ø 56 INC



FRONT BEARING	↻ 21	593563
REAR BEARING	↻ 22	593564
PROTECTION COVER	↻ 24	593295
SEP:SEPARATED REGULATOR -INC:BUILT-IN REGULATOR	↻ 02	593131
CONDENSOR	↻ 14	593233
RECTIFIER OR DIODE BRIDGE ASSEMBLY	↻ 07	593557
PULLEY	↻ 11	592898
REPAIRE KIT	↻ 29	592854
ROTOR	↻ 04	593298
STATOR	↻ 05	592832

Valeo

439530/437499

A13VI304

90 2 6V

14 ↻ 60° ∇ Ø 56 INC



FRONT BEARING	↻ 21	593563
REAR BEARING	↻ 22	593564
PROTECTION COVER	↻ 24	593295
SEP:SEPARATED REGULATOR -INC:BUILT-IN REGULATOR	↻ 02	593131
CONDENSOR	↻ 14	593233
RECTIFIER OR DIODE BRIDGE ASSEMBLY	↻ 07	593557
PULLEY	↻ 11	592898
REPAIRE KIT	↻ 29	592854
ROTOR	↻ 04	593298
STATOR	↻ 05	592832

Valeo

439528/437511

A13VI305

90 1 6V

14 ↻ 60° ∇ Ø 56 INC

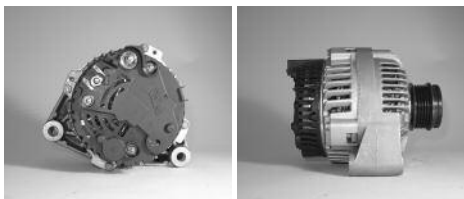

FRONT BEARING	↻ 21	593563
REAR BEARING	↻ 22	593564
PROTECTION COVER	↻ 24	593295
SEP:SEPARATED REGULATOR -INC:BUILT-IN REGULATOR	↻ 02	593131
CONDENSOR	↻ 14	593233
RECTIFIER OR DIODE BRIDGE ASSEMBLY	↻ 07	593557
PULLEY FREE WHEEL + CAP PROTECTION	↻ 11c	593495
REPAIRE KIT	↻ 29	592854
ROTOR	↻ 04	593298
STATOR	↻ 05	592832

Valeo

439531/437522

A13VI306

120 4 6V

14 ↻ 90° ∇ Ø 69,5 INC

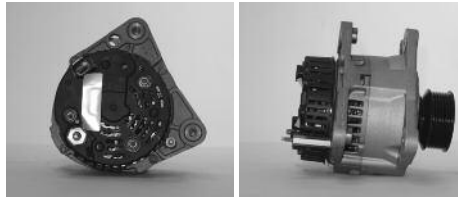

FRONT BEARING	↻ 21	593563
REAR BEARING	↻ 22	593564
PROTECTION COVER	↻ 24	593367
SEP:SEPARATED REGULATOR -INC:BUILT-IN REGULATOR	↻ 02	593362
RECTIFIER OR DIODE BRIDGE ASSEMBLY	↻ 07	593364
PULLEY	↻ 11	593906
REPAIRE KIT	↻ 29	592854
ROTOR	↻ 04	593147
STATOR	↻ 05	593161

Valeo

439529/437513

A13VI308

120 1 6V

14 ↻ 60° ∇ Ø 51,38



FRONT BEARING	↻ 21	593563
REAR BEARING	↻ 22	593564
PROTECTION COVER	↻ 24	593295
SEP:SEPARATED REGULATOR -INC:BUILT-IN REGULATOR	↻ 02	593131
CONDENSOR	↻ 14	593233
RECTIFIER OR DIODE BRIDGE ASSEMBLY	↻ 07	593989
PULLEY	↻ 11	593718
REPAIRE KIT	↻ 29	592854
ROTOR	↻ 04	593147
STATOR	↻ 05	593161

Valeo

439555/437552

A13VI31

80 2 6V

14 ↻ 20° ∇ Ø 66 INC

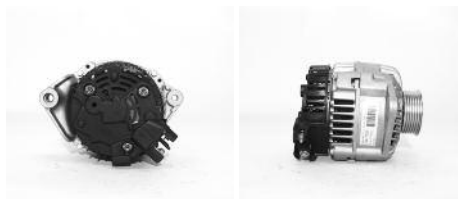

B+(M8)D+(M5)

FRONT BEARING	↻ 21	593563
REAR BEARING	↻ 22	593564
PROTECTION COVER	↻ 24	592946
SEP:SEPARATED REGULATOR -INC:BUILT-IN REGULATOR	↻ 02	593350
CONDENSOR	↻ 14	592853
RECTIFIER OR DIODE BRIDGE ASSEMBLY	↻ 07	592848
REPAIRE KIT	↻ 29	592854
ROTOR	↻ 04	592818
STATOR	↻ 05	592831

Valeo

433159/436340

A13VI310

120

1

6V

14



60°

Ø 57

INC

Picture not available
Image non disponible
Imagem no disponibile
Immagine non disponibile
Nicht verfügbares Bild
Brak zdjęćia
Картина недоступна

Picture not available
Image non disponible
Imagem no disponibile
Immagine non disponibile
Nicht verfügbares Bild
Brak zdjęćia
Картина недоступна

**B+(M8)D+(M5)
W(M5)**

FRONT BEARING	21	593563
REAR BEARING	22	593564
PROTECTION COVER	24	593295
SEP:SEPARATED REGULATOR -INC:BUILT-IN REGULATOR	02	593131
CONDENSOR	14	593233
RECTIFIER OR DIODE BRIDGE ASSEMBLY	07	593989
PULLEY FREE WHEEL + CAP PROTECTION	11c	593495
REPAIRE KIT	29	592854
ROTOR	04	593147
STATOR	05	593161

Valeo**439570/437763****A13VI32**

110

2

6V

14



25°

Ø 61,1

INC



FRONT BEARING	21	593563
REAR BEARING	22	593564
PROTECTION COVER	24	592944
CONDENSOR	14	592852
RECTIFIER OR DIODE BRIDGE ASSEMBLY	07	592846
PULLEY	11	592921
REPAIRE KIT	29	592854
ROTOR	04	592818
ROTOR	04	593298
STATOR	05	592832

Valeo**433173/436283****A13VI34**

110

2

3V

14



19°

Ø 61,1

INC

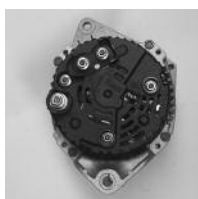

FRONT BEARING	21	593563
REAR BEARING	22	593564
PROTECTION COVER	24	592944
CONDENSOR	14	592852
RECTIFIER OR DIODE BRIDGE ASSEMBLY	07	592846
REPAIRE KIT	29	592854
ROTOR	04	592818
ROTOR	04	593298
STATOR	05	592832

Valeo**433174/436284****A13VI35**

110

2

4V

14



19°

Ø 61,1

INC



FRONT BEARING	21	593563
REAR BEARING	22	593564
PROTECTION COVER	24	592944
CONDENSOR	14	592852
RECTIFIER OR DIODE BRIDGE ASSEMBLY	07	592846
PULLEY	11	592926
REPAIRE KIT	29	592854
ROTOR	04	592818
ROTOR	04	593298
STATOR	05	592832

Valeo**433175/436285****A13VI40**

90

2

6V

14



72-88°

INC

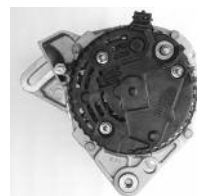

FRONT BEARING	21	593563
REAR BEARING	22	593564
PROTECTION COVER	24	593241
SEP:SEPARATED REGULATOR -INC:BUILT-IN REGULATOR	02	593131
CONDENSOR	14	592933
RECTIFIER OR DIODE BRIDGE ASSEMBLY	07	592915
FRONT BEARING	21	592866
REPAIRE KIT	29	592854
STATOR	05	592832

Valeo**439002/436443****A13VI41**

90

2

6V

14



90°

INC



FRONT BEARING	21	593563
REAR BEARING	22	593690
PROTECTION COVER	24	593241
SEP:SEPARATED REGULATOR -INC:BUILT-IN REGULATOR	02	593131
CONDENSOR	14	592933
RECTIFIER OR DIODE BRIDGE ASSEMBLY	07	592915
FRONT BEARING	21	592866
REPAIRE KIT	29	592854
STATOR	05	592832

Valeo**439003/436444**

A13VI44

90 2 7V

14 ↻ 90° ▽ INC



FRONT BEARING	↗ 21	593563
REAR BEARING	↗ 22	593690
PROTECTION COVER	↗ 24	593241
SEP:SEPARATED REGULATOR -INC:BUILT-IN REGULATOR	↗ 02	5933131
CONDENSOR	↗ 14	592933
RECTIFIER OR DIODE BRIDGE ASSEMBLY	↗ 07	592915
FRONT BEARING	↗ 21	592866
PULLEY	↗ 11	593693
REPAIRE KIT	↗ 29	592854
STATOR	↗ 05	592832

Valeo

439004/436445

A13VI45

110 2 6V

14 ↻ 0° ▽ Ø 58,18 INC

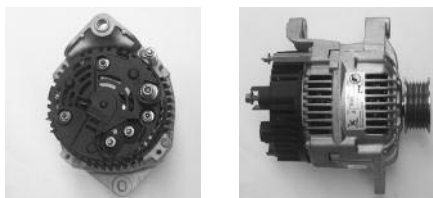

FRONT BEARING	↗ 21	593563
REAR BEARING	↗ 22	593564
PROTECTION COVER	↗ 24	592944
CONDENSOR	↗ 14	592852
RECTIFIER OR DIODE BRIDGE ASSEMBLY	↗ 07	592846
REPAIRE KIT	↗ 29	592854
ROTOR	↗ 04	592818
ROTOR	↗ 04	593298
STATOR	↗ 05	592832

Valeo

433177/436403

A13VI46

80 1 5V

14 ↻ 60° ▽ Ø 59,4 INC

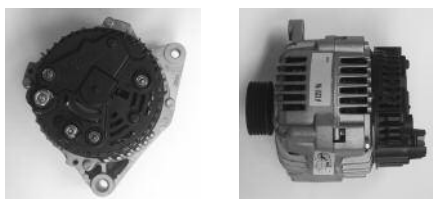

B+(M8)D+(M5)

FRONT BEARING	↗ 21	593563
REAR BEARING	↗ 22	593564
PROTECTION COVER	↗ 24	*592942
SEP:SEPARATED REGULATOR -INC:BUILT-IN REGULATOR	↗ 02	5933350
CONDENSOR	↗ 14	592851
RECTIFIER OR DIODE BRIDGE ASSEMBLY	↗ 07	593163
PULLEY	↗ 11	592929
REPAIRE KIT	↗ 29	592854
ROTOR	↗ 04	592818
STATOR	↗ 05	592831

Valeo

433156/436260

A13VI47

110 2 6V

14 ↻ 0° ▽ Ø 54,2 INC

B+(M6)D+(M5)
W(M5)

FRONT BEARING	↗ 21	593563
REAR BEARING	↗ 22	593564
PROTECTION COVER	↗ 24	592944
CONDENSOR	↗ 14	592852
RECTIFIER OR DIODE BRIDGE ASSEMBLY	↗ 07	592846
PULLEY	↗ 11	593739
REPAIRE KIT	↗ 29	592854
ROTOR	↗ 04	592818
ROTOR	↗ 04	593298
STATOR	↗ 05	592832

Valeo

439167/436383

A13VI48

80 2 4V

14 ↻ 20° ▽ Ø 59,4



FRONT BEARING	↗ 21	593563
REAR BEARING	↗ 22	593690
PROTECTION COVER	↗ 24	592946
SEP:SEPARATED REGULATOR -INC:BUILT-IN REGULATOR	↗ 02	5933350
CONDENSOR	↗ 14	592853
RECTIFIER OR DIODE BRIDGE ASSEMBLY	↗ 07	592848
PULLEY	↗ 11	593741
REPAIRE KIT	↗ 29	592854
ROTOR	↗ 04	592818
STATOR	↗ 05	592831

Valeo

433157/436261

A13VI49

80 2 6V

14 ↻ 20° ▽ Ø 66 INC

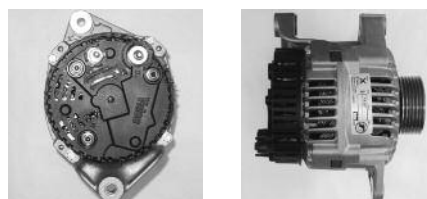

B+(M8)D+(M5)

FRONT BEARING	↗ 21	593563
REAR BEARING	↗ 22	593564
PROTECTION COVER	↗ 24	*592942
SEP:SEPARATED REGULATOR -INC:BUILT-IN REGULATOR	↗ 02	5933350
CONDENSOR	↗ 14	592851
RECTIFIER OR DIODE BRIDGE ASSEMBLY	↗ 07	593163
REPAIRE KIT	↗ 29	592854
ROTOR	↗ 04	592818
STATOR	↗ 05	592831

Valeo

433160/436339

A13VI51

80

2

6V

14



20°

Ø 59,4

INC

**B+(M8)D+(M5)**

FRONT BEARING	21	593563
REAR BEARING	22	593564
PROTECTION COVER	24	*592942
SEP:SEPARATED REGULATOR -INC:BUILT-IN REGULATOR	02	593350
CONDENSOR	14	592851
RECTIFIER OR DIODE BRIDGE ASSEMBLY	07	593163
FRONT BEARING	21	592866
PULLEY	11	593743
REPAIRE KIT	29	592854
ROTOR	04	592818
STATOR	05	592831

Valeo**433189/436346****A13VI52**

110

2

6V

14



35°

Ø 58,18

INC



FRONT BEARING	21	593563
REAR BEARING	22	593564
PROTECTION COVER	24	592945
CONDENSOR	14	592852
RECTIFIER OR DIODE BRIDGE ASSEMBLY	07	592846
REPAIRE KIT	29	592854
ROTOR	04	592818
ROTOR	04	593298
STATOR	05	592832

Valeo**439497/436384****A13VI54**

80

2

6V

14



32°

Ø 53,2

INC

**B+(M8)D+(M6)
W(M5)**

FRONT BEARING	21	593563
REAR BEARING	22	593564
SEP:SEPARATED REGULATOR -INC:BUILT-IN REGULATOR	02	593139
CONDENSOR	14	592934
RECTIFIER OR DIODE BRIDGE ASSEMBLY	07	592915
PULLEY	11	593602
PROTECTION COVER	24	592947
REPAIRE KIT	29	592854
ROTOR	04	592818
ROTOR	04	593298
STATOR	05	592831

Valeo**436385****A13VI55**

110

2

4V

14



25°

Ø 64,8

INC

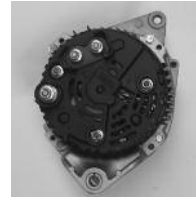

FRONT BEARING	21	593563
REAR BEARING	22	593564
PROTECTION COVER	24	592944
CONDENSOR	14	592852
RECTIFIER OR DIODE BRIDGE ASSEMBLY	07	592846
PULLEY	11	593740
REPAIRE KIT	29	592854
ROTOR	04	592818
ROTOR	04	593298
STATOR	05	592832

Valeo**439018/436469****A13VI57**

110

2

6V

14



35°

Ø 58,18

INC



FRONT BEARING	21	593563
REAR BEARING	22	593564
PROTECTION COVER	24	592944
CONDENSOR	14	592852
RECTIFIER OR DIODE BRIDGE ASSEMBLY	07	592846
REPAIRE KIT	29	592854
ROTOR	04	592818
ROTOR	04	593298
STATOR	05	592832

Valeo**439016/436467****A13VI59**

100

2

7V

14



32°

Ø 48,2

INC

**B+(M8)D+(M6)**

FRONT BEARING	21	593563
REAR BEARING	22	593564
SEP:SEPARATED REGULATOR -INC:BUILT-IN REGULATOR	02	593139
CONDENSOR	14	593232
PULLEY	11	593694
REPAIRE KIT	29	592854
ROTOR	04	592818
ROTOR	04	593298
STATOR	05	592832

Valeo**439035/436486**

A13VI60

105

2

6V

14



32°

Ø 53,2

INC

**B+(M8)D+(M6)**

FRONT BEARING	21	593563
REAR BEARING	22	593564
SEP:SEPARATED REGULATOR -INC:BUILT-IN REGULATOR	02	593139
CONDENSOR	14	592934
RECTIFIER OR DIODE BRIDGE ASSEMBLY	07	592915
PULLEY	11	593602
PROTECTION COVER	24	595260
REPAIRE KIT	29	592854
ROTOR	04	592818
STATOR	05	592832

Valeo**439036/436488****A13VI61**

80

2

1V

14



60°

Ø 68

INC

**B+(M8)D+(M6)**

FRONT BEARING	21	593563
REAR BEARING	22	593564
PROTECTION COVER	24	593252
SEP:SEPARATED REGULATOR -INC:BUILT-IN REGULATOR	02	593139
CONDENSOR	14	592849
RECTIFIER OR DIODE BRIDGE ASSEMBLY	07	592915
PULLEY	11	593695
REPAIRE KIT	29	592854
ROTOR	04	592818
STATOR	05	592831

Valeo**439092/436682****A13VI62**

110

2

6V

14



25°

Ø 58,18

INC



FRONT BEARING	21	593563
REAR BEARING	22	593564
CONDENSOR	14	592852
RECTIFIER OR DIODE BRIDGE ASSEMBLY	07	592846
PULLEY	11	593750
REPAIRE KIT	29	592854
ROTOR	04	592818
ROTOR	04	593298
STATOR	05	592832

Valeo**439020/436471****A13VI63**

90

2

6V

14



90°

INC



FRONT BEARING	21	593563
REAR BEARING	22	593690
PROTECTION COVER	24	593295
SEP:SEPARATED REGULATOR -INC:BUILT-IN REGULATOR	02	593131
RECTIFIER OR DIODE BRIDGE ASSEMBLY	07	592857
REPAIRE KIT	29	592854
STATOR	05	592832

Valeo**439012/436449****A13VI64**

80

2

6V

14



0°

Ø 58,18

INC



FRONT BEARING	21	593563
REAR BEARING	22	593564
PROTECTION COVER	24	592944
CONDENSOR	14	592852
RECTIFIER OR DIODE BRIDGE ASSEMBLY	07	592847
REPAIRE KIT	29	592854
ROTOR	04	593298
STATOR	05	592831

Valeo**439061/436618****A13VI65**

80

2

6V

14



35°

Ø 58,18

Picture not available
Image non disponible
Imagen no disponible
Immagine non disponibile
Nicht verfügbares Bild
Brak zdjęcia
Картина недоступна

Picture not available
Image non disponible
Imagen no disponible
Immagine non disponibile
Nicht verfügbares Bild
Brak zdjęcia
Картина недоступна

FRONT BEARING	21	593563
REAR BEARING	22	593564
PROTECTION COVER	24	592944
CONDENSOR	14	592852
RECTIFIER OR DIODE BRIDGE ASSEMBLY	07	592847
REPAIRE KIT	29	592854
ROTOR	04	593298
STATOR	05	592831

Valeo**439090/436661**

A13VI66

80

2

6V

14



25°

Ø 58,18

INC

**FRONT BEARING** 21

593563

REAR BEARING 22

593564

CONDENSOR 14

592852

RECTIFIER OR DIODE BRIDGE ASSEMBLY 07

592847

PULLEY 11

593750

REPAIRE KIT 29

592854

ROTOR 04

592818

ROTOR 04

593298

STATOR 05

592831

Valeo**439019/436470****A13VI67**

90

2

4V

14



60°

Ø 73,1

INC

**B+(M8)D+(M5)****FRONT BEARING** 21

593674

PROTECTION COVER 24

593295

SEP:SEPARATED REGULATOR -INC:BUILT-IN REGULATOR 02

593131

CONDENSOR 14

592850

RECTIFIER OR DIODE BRIDGE ASSEMBLY 07

592917

PULLEY 11

593697

REPAIRE KIT 29

592854

ROTOR 04

592818

STATOR 05

592832

Valeo**439011/436386****A13VI68**

80

2

5V

14



20°

Ø 59,4

INC

Picture not available
Image non disponible
Imagen no disponible
Immagine non disponibile
Nicht verfügbares Bild
Brak zdjęcia
Картина недоступна

Picture not available
Image non disponible
Imagen no disponible
Immagine non disponibile
Nicht verfügbares Bild
Brak zdjęcia
Картина недоступна

B+(M8)D+(M5)**FRONT BEARING** 21

593563

REAR BEARING 22

593564

PROTECTION COVER 24

*592942

CONDENSOR 14

592851

RECTIFIER OR DIODE BRIDGE ASSEMBLY 07

593163

FRONT BEARING 21

592866

PULLEY 11

593742

REPAIRE KIT 29

592854

ROTOR 04

593298

STATOR 05

592831

Valeo**439021/436474****A13VI69**

90

2

6V

14



60°

Ø 67,9

INC

**FRONT BEARING** 21

593674

REAR BEARING 22

593564

PROTECTION COVER 24

593295

SEP:SEPARATED REGULATOR -INC:BUILT-IN REGULATOR 02

593131

CONDENSOR 14

592850

RECTIFIER OR DIODE BRIDGE ASSEMBLY 07

592917

PULLEY 11

592932

REPAIRE KIT 29

592854

ROTOR 04

592818

ROTOR 04

593298

STATOR 05

592832

Valeo**439005/436387****A13VI70**

90

2

6V

14



60°

Ø 67,9

INC

**B+(M8)D+(M5)****FRONT BEARING** 21

593563

REAR BEARING 22

593564

SEP:SEPARATED REGULATOR -INC:BUILT-IN REGULATOR 02

593131

RECTIFIER OR DIODE BRIDGE ASSEMBLY 07

592917

PULLEY 11

593719

PROTECTION COVER 24

592949

REPAIRE KIT 29

592854

ROTOR 04

592818

ROTOR 04

593298

STATOR 05

592832

Valeo**439006/436388****A13VI71**

97

2

6V

14



20°

Ø 59,4

INC

**B+(M8)D+(M5)****FRONT BEARING** 21

593674

REAR BEARING 22

593564

PROTECTION COVER 24

*592942

CONDENSOR 14

592851

RECTIFIER OR DIODE BRIDGE ASSEMBLY 07

593163

PULLEY 11

593702

REPAIRE KIT 29

592854

ROTOR 04

593147

STATOR 05

593158

Valeo**433190/436366**

A13VI72

80 2 6V

14 ↻ 0° Ø 58,2 INC

**B+(M8)D+(M5)**

- FRONT BEARING 21 593563
- REAR BEARING 22 593564
- PROTECTION COVER 24 593238
- SEP:SEPARATED REGULATOR -INC:BUILT-IN REGULATOR 02 593138
- RECTIFIER OR DIODE BRIDGE ASSEMBLY 07 593166
- PULLEY 11 593701
- REPAIRE KIT 29 592854
- ROTOR 04 592818
- ROTOR 04 593298
- STATOR 05 592831

Valeo**439064/436635****A13VI73**

110 2 6V

14 ↻ 0° Ø 58,2 INC

**B+(M8)D+(M5)**

- FRONT BEARING 21 593563
- REAR BEARING 22 593564
- PROTECTION COVER 24 593238
- SEP:SEPARATED REGULATOR -INC:BUILT-IN REGULATOR 02 593138
- RECTIFIER OR DIODE BRIDGE ASSEMBLY 07 593167
- PULLEY 11 593701
- REPAIRE KIT 29 592854
- ROTOR 04 592818
- ROTOR 04 593298
- STATOR 05 592832

Valeo**439065/436636****A13VI74**

70 1 6V

14 ↻ 60° Ø 56 INC

**B+(M8)D+(M5)**

- FRONT BEARING 21 593674
- REAR BEARING 22 593691
- PROTECTION COVER 24 593235
- SEP:SEPARATED REGULATOR -INC:BUILT-IN REGULATOR 02 593131
- CONDENSOR 14 593233
- RECTIFIER OR DIODE BRIDGE ASSEMBLY 07 592917
- PULLEY 11 592898
- REPAIRE KIT 29 592854
- ROTOR 04 593145
- STATOR 05 592832

Valeo**439008/436450****A13VI75**

70 1 6V

14 ↻ 60° Ø 48 INC



- FRONT BEARING 21 593674
- REAR BEARING 22 593691
- PROTECTION COVER 24 593235
- SEP:SEPARATED REGULATOR -INC:BUILT-IN REGULATOR 02 593131
- CONDENSOR 14 593233
- RECTIFIER OR DIODE BRIDGE ASSEMBLY 07 592917
- PULLEY 11 593718
- REPAIRE KIT 29 592854
- ROTOR 04 593145
- STATOR 05 592832

Valeo**439009/436451****A13VI76**

105 1 5V

14 ↻ 60° Ø 49,4 INC



- FRONT BEARING 21 593563
- REAR BEARING 22 593564
- SEP:SEPARATED REGULATOR -INC:BUILT-IN REGULATOR 02 593139
- PULLEY 11 592919
- ROTOR 04 593298

Valeo**439062/436619****A13VI77**

90 2 6V

14 ↻ 60° Ø 63,4 INC

**B+(M8)D+(M5)**

- FRONT BEARING 21 593674
- REAR BEARING 22 593690
- PROTECTION COVER 24 593295
- SEP:SEPARATED REGULATOR -INC:BUILT-IN REGULATOR 02 593131
- CONDENSOR 14 592850
- RECTIFIER OR DIODE BRIDGE ASSEMBLY 07 592917
- PULLEY 11 593698
- REPAIRE KIT 29 592854
- ROTOR 04 592818
- STATOR 05 592832

Valeo**439010/436389**

A13VI78

80

2

6V

14



35°

Ø 55,4

INC

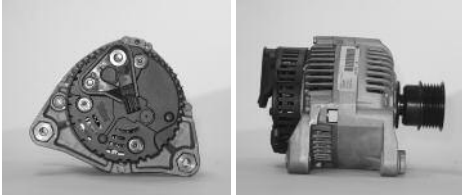
**B+(M8)D+(M6)**

FRONT BEARING	593563
REAR BEARING	593564
PROTECTION COVER	593234
SEP:SEPARATED REGULATOR -INC:BUILT-IN REGULATOR	593139
FRONT BEARING	592866
PULLEY	593699
REPAIRE KIT	592854
ROTOR	593298
STATOR	592831

Valeo**439007/436675****A13VI80**

80

2

5V

14



20°

Ø 66

INC

**B+(M8)D+(M5)**

FRONT BEARING	593563
REAR BEARING	593564
PROTECTION COVER	*592942
CONDENSOR	592851
RECTIFIER OR DIODE BRIDGE ASSEMBLY	593163
FRONT BEARING	592866
PULLEY	593744
REPAIRE KIT	592854
ROTOR	593298
STATOR	592831

Valeo**439022/436475****A13VI81**

80

2

6V

14



20°

Ø 59,4

INC

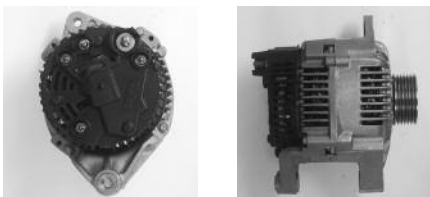
**B+(M8)D+(M5)**

FRONT BEARING	593674
REAR BEARING	593564
PROTECTION COVER	*592942
CONDENSOR	592851
RECTIFIER OR DIODE BRIDGE ASSEMBLY	593163
PULLEY	593702
REPAIRE KIT	592854
ROTOR	593298
STATOR	592831

Valeo**439023/436476****A13VI82**

105

1

7V

14



32°

Ø 48,2

INC



FRONT BEARING	593563
REAR BEARING	593564
CONDENSOR	592852
RECTIFIER OR DIODE BRIDGE ASSEMBLY	593165
PULLEY	593694
REGULATOR + COVER	*599145
REPAIRE KIT	592854
ROTOR	592818
ROTOR	593298
STATOR	592832

Valeo**439037/436487****A13VI83**

80

1

5V

14



60°

Ø 59,4

INC

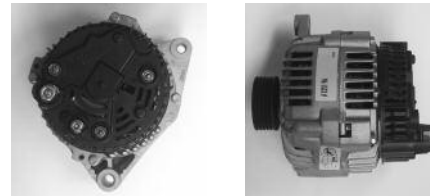
**B+(M8)D+(M5)**

FRONT BEARING	593563
REAR BEARING	593690
PROTECTION COVER	*592942
SEP:SEPARATED REGULATOR -INC:BUILT-IN REGULATOR	593350
CONDENSOR	592851
RECTIFIER OR DIODE BRIDGE ASSEMBLY	593163
FRONT BEARING	592866
PULLEY	592929
REPAIRE KIT	592854
ROTOR	592818
STATOR	592831

Valeo**433156/436260****A13VI84**

80

2

5V

14



55°

Ø 59,4

INC

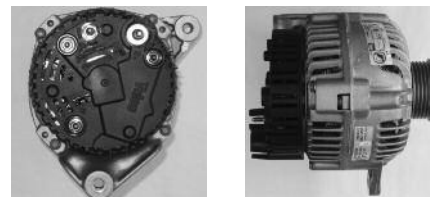
**B+(M8)D+(M5)**

FRONT BEARING	593563
REAR BEARING	593564
PROTECTION COVER	*592942
SEP:SEPARATED REGULATOR -INC:BUILT-IN REGULATOR	593350
CONDENSOR	592851
RECTIFIER OR DIODE BRIDGE ASSEMBLY	593163
FRONT BEARING	592866
PULLEY	593742
REPAIRE KIT	592854
ROTOR	593298
STATOR	592831

Valeo**439054/436611**

A13VI85

80

2

6V

14



20°

Ø 66

INC

**B+(M8)D+(M5)**

FRONT BEARING	21	593563
REAR BEARING	22	593564
PROTECTION COVER	24	592946
CONDENSOR	14	592853
RECTIFIER OR DIODE BRIDGE ASSEMBLY	07	592848
FRONT BEARING	21	592866
REPAIRE KIT	29	592854
ROTOR	04	593298
STATOR	05	592831

A13VI85

80

2

6V

14



20°

Ø 66

INC

**B+(M8)D+(M5)**

FRONT BEARING	21	593563
REAR BEARING	22	593564
PROTECTION COVER	24	592946
CONDENSOR	14	592853
RECTIFIER OR DIODE BRIDGE ASSEMBLY	07	592848
FRONT BEARING	21	592866
REPAIRE KIT	29	592854
ROTOR	04	593298
STATOR	05	592831

Valeo**433159/436340****A13VI86**

80

2

4V

14



20°

Ø 59,4

Picture not available
Image non disponible
Imagen no disponible
Immagine non disponibile
Nicht verfügbares Bild
Brak zdjęcia
Картина недоступна

Picture not available
Image non disponible
Imagen no disponible
Immagine non disponibile
Nicht verfügbares Bild
Brak zdjęcia
Картина недоступна

FRONT BEARING	21	593563
REAR BEARING	22	593564
PROTECTION COVER	24	592946
CONDENSOR	14	592853
RECTIFIER OR DIODE BRIDGE ASSEMBLY	07	592848
FRONT BEARING	21	592866
PULLEY	11	593741
REPAIRE KIT	29	592854
ROTOR	04	593298
STATOR	05	592831

Valeo**433157/436261****A13VI87**

80

2

6V

14



20°

Ø 66

INC

**B+(M8)D+(M5)**

FRONT BEARING	21	593563
REAR BEARING	22	593564
PROTECTION COVER	24	*592942
SEP:SEPARATED REGULATOR -INC:BUILT-IN REGULATOR	02	593350
CONDENSOR	14	592851
RECTIFIER OR DIODE BRIDGE ASSEMBLY	07	593163
FRONT BEARING	21	592866
REPAIRE KIT	29	592854
ROTOR	04	593298
STATOR	05	592831

Valeo**433160/436339****A13VI88**

80

2

6V

14



20°

Ø 59,4

INC

**B+(M8)D+(M5)**

FRONT BEARING	21	593563
REAR BEARING	22	593564
PROTECTION COVER	24	*592942
SEP:SEPARATED REGULATOR -INC:BUILT-IN REGULATOR	02	593350
CONDENSOR	14	592851
RECTIFIER OR DIODE BRIDGE ASSEMBLY	07	593163
FRONT BEARING	21	592866
PULLEY	11	593743
REPAIRE KIT	29	592854
ROTOR	04	593298
STATOR	05	592831

A13VI88

80

2

6V

14



20°

Ø 59,4

INC

**B+(M8)D+(M5)**

FRONT BEARING	21	593563
REAR BEARING	22	593564
PROTECTION COVER	24	*592942
SEP:SEPARATED REGULATOR -INC:BUILT-IN REGULATOR	02	593350
CONDENSOR	14	592851
RECTIFIER OR DIODE BRIDGE ASSEMBLY	07	593163
FRONT BEARING	21	592866
PULLEY	11	593743
REPAIRE KIT	29	592854
ROTOR	04	593298
STATOR	05	592831

Valeo**433189/436346**

A13VI94

90

1

6V

14



45°

Ø 66

INC

**B+(M8)D+(M5)**

FRONT BEARING	21	593674
REAR BEARING	22	593564
PROTECTION COVER	24	592946
SEP:SEPARATED REGULATOR -INC:BUILT-IN REGULATOR	02	593350
CONDENSOR	14	592853
RECTIFIER OR DIODE BRIDGE ASSEMBLY	07	592848
PULLEY	11	593745
REPAIRE KIT	29	592854
ROTOR	04	593147
STATOR	05	593158

Valeo**439056/436613****A13VI95**

80

1

6V

14



45°

Ø 66

INC

**B+(M8)D+(M5)**

FRONT BEARING	21	593674
REAR BEARING	22	593564
PROTECTION COVER	24	592946
SEP:SEPARATED REGULATOR -INC:BUILT-IN REGULATOR	02	593350
CONDENSOR	14	592853
RECTIFIER OR DIODE BRIDGE ASSEMBLY	07	592848
PULLEY	11	593745
REPAIRE KIT	29	592854
ROTOR	04	593298
STATOR	05	592831

Valeo**439102/436668****A13VI96**

80

1

5V

14



60°

Ø 59,4

INC

**B+(M8)D+(M5)**

FRONT BEARING	21	593563
REAR BEARING	22	593564
PROTECTION COVER	24	*592942
SEP:SEPARATED REGULATOR -INC:BUILT-IN REGULATOR	02	593350
CONDENSOR	14	592851
RECTIFIER OR DIODE BRIDGE ASSEMBLY	07	593163
FRONT BEARING	21	592866
PULLEY	11	592929
REPAIRE KIT	29	592854
ROTOR	04	593298
STATOR	05	592831

Valeo**433156/436260****A13VI97**

95

1

5V

14



60°

Ø 57

INC

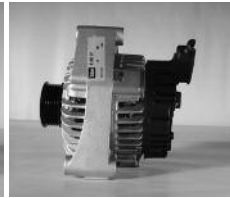

FRONT BEARING	21	593563
REAR BEARING	22	593564
PROTECTION COVER	24	593244
PROTECTION COVER	24	*599082
CONDENSOR	14	592852
RECTIFIER OR DIODE BRIDGE ASSEMBLY	07	593201
PULLEY	11	593708
REGULATOR + COVER	02+24	*599081
REPAIRE KIT	29	592854
ROTOR	04	593298
STATOR	05	592832

Valeo**439053/436607****A13VI99**

90

1

6V

14



60°

Ø 56

INC

**B+(M8)D+(M5)**

FRONT BEARING	21	593674
REAR BEARING	22	593691
PROTECTION COVER	24	593235
SEP:SEPARATED REGULATOR -INC:BUILT-IN REGULATOR	02	593131
CONDENSOR	14	593233
RECTIFIER OR DIODE BRIDGE ASSEMBLY	07	592917
PULLEY	11	592898
REPAIRE KIT	29	592854
ROTOR	04	593145
STATOR	05	592832

A13VI99

90

1

6V

14



60°

Ø 56

INC

**B+(M8)D+(M5)**

FRONT BEARING	21	593674
REAR BEARING	22	593691
PROTECTION COVER	24	593235
SEP:SEPARATED REGULATOR -INC:BUILT-IN REGULATOR	02	593131
CONDENSOR	14	593233
RECTIFIER OR DIODE BRIDGE ASSEMBLY	07	592917
PULLEY	11	592898
REPAIRE KIT	29	592854
ROTOR	04	593145
STATOR	05	592832

Valeo**439245/437126**

A14N1

85

2

1V

14



55°

Ø 66

INC



PLASTIC CAPSULE	26	590627
FRONT BEARING	21	593224
REAR BEARING	22	590568
BRUSH HOLDER	09	092859
SEP:SEPARATED REGULATOR -INC:BUILT-IN REGULATOR	02	300667
RECTIFIER OR DIODE BRIDGE ASSEMBLY	07	105135
FAN	12	100809
PULLEY	11	096879
STATOR	05	101868

Valeo**432808/433368****A14N10**

85

2

14



Picture not available Image non disponible Imagen no disponible Imagine non disponibile Nicht verfügbares Bild Brak zdjęć Картина недоступна	Picture not available Image non disponible Imagen no disponible Imagine non disponibile Nicht verfügbares Bild Brak zdjęć Картина недоступна
--	--

PLASTIC CAPSULE	26	590629
FRONT BEARING	21	593224
REAR BEARING	22	590613
PROTECTION COVER	24	590563
BRUSH HOLDER	09	092859
SEP:SEPARATED REGULATOR -INC:BUILT-IN REGULATOR	02	300667
*2590558		
RECTIFIER OR DIODE BRIDGE ASSEMBLY	07	105135
FAN	12	592703
PULLEY	11	593253
HARDWARE OF PULLEY	13	300761
STATOR	05	101868

Valeo**101473****A14N101**

75

2

6V

14



0°

Ø 58,18

Picture not available Image non disponible Imagen no disponible Imagine non disponibile Nicht verfügbares Bild Brak zdjęć Картина недоступна	Picture not available Image non disponible Imagen no disponible Imagine non disponibile Nicht verfügbares Bild Brak zdjęć Картина недоступна
--	--

PLASTIC CAPSULE	26	590629
REAR BEARING	22	590613
PROTECTION COVER	24	590563
SEP:SEPARATED REGULATOR -INC:BUILT-IN REGULATOR	02	300667
*2590558		
ROTOR	04	300696
STATOR	05	101025

Valeo**433093****A14N102**

90

2

6V

14



0°

Ø 58,18

INC



PLASTIC CAPSULE	26	590629
REAR BEARING	22	590613
PROTECTION COVER	24	590563
SEP:SEPARATED REGULATOR -INC:BUILT-IN REGULATOR	02	300667
*2590558		
ROTOR	04	300696
STATOR	05	101868

Valeo**433067/436594****A14N104+**

75

2

28



0°

Picture not available Image non disponible Imagen no disponible Imagine non disponibile Nicht verfügbares Bild Brak zdjęć Картина недоступна
--

Picture not available Image non disponible Imagen no disponible Imagine non disponibile Nicht verfügbares Bild Brak zdjęć Картина недоступна
--

PLASTIC CAPSULE	26	590629
FRONT BEARING	21	592860
REAR BEARING	22	590613
PROTECTION COVER	24	590566
REAR BRACKET	25	590658
BRUSH HOLDER	09	300665
SEP:SEPARATED REGULATOR -INC:BUILT-IN REGULATOR	02	590640
ROTOR	04	182055

Valeo**541178/436434****A14N105M**

55

2

28



20°

Picture not available Image non disponible Imagen no disponible Imagine non disponibile Nicht verfügbares Bild Brak zdjęć Картина недоступна
--

Picture not available Image non disponible Imagen no disponible Imagine non disponibile Nicht verfügbares Bild Brak zdjęć Картина недоступна
--

PLASTIC CAPSULE	26	590629
FRONT BEARING	21	592780
REAR BEARING	22	590613
PROTECTION COVER	24	590563
REAR BRACKET	25	590574
BRUSH HOLDER	09	092967
SEP:SEPARATED REGULATOR -INC:BUILT-IN REGULATOR	02	590582
RECTIFIER OR DIODE BRIDGE ASSEMBLY	07	593188
FAN	12	592703
STATOR	05	102589

Valeo**105836**

A14N106 75 2 1V
14 0° 63,25

Picture not available
Image non disponible
Imagen no disponible
Immagine non disponibile
Nicht verfügbares Bild
Brak zdjęcia
Картина недоступна

Picture not available
Image non disponible
Imagen no disponible
Immagine non disponibile
Nicht verfügbares Bild
Brak zdjęcia
Картина недоступна

- PLASTIC CAPSULE 26 590629
 - FRONT BEARING 21 593224
 - REAR BEARING 22 590613
 - PROTECTION COVER 24 590563
 - SEP:SEPARATED REGULATOR -INC:BUILT-IN REGULATOR 02 *2590558
 - RECTIFIER OR DIODE BRIDGE ASSEMBLY 07 180593
 - PULLEY 11 096882
 - ROTOR 04 *300807
 - STATOR 05 101025
- Valeo** 432786/436318

A14N110M 65 2
28 20° 74

Picture not available
Image non disponible
Imagen no disponible
Immagine non disponibile
Nicht verfügbares Bild
Brak zdjęcia
Картина недоступна

Picture not available
Image non disponible
Imagen no disponible
Immagine non disponibile
Nicht verfügbares Bild
Brak zdjęcia
Картина недоступна

- FRONT BEARING 21 592860
 - REAR BEARING 22 590613
 - PROTECTION COVER 24 590563
 - REAR BRACKET 25 590574
 - BRUSH HOLDER 09 092967
 - SEP:SEPARATED REGULATOR -INC:BUILT-IN REGULATOR 02 182169
 - RECTIFIER OR DIODE BRIDGE ASSEMBLY 07 102556
 - ROTOR 04 592727
 - STATOR 05 101518
- Valeo** 181695/436351

A14N112M 60 1
28 20°

Picture not available
Image non disponible
Imagen no disponible
Immagine non disponibile
Nicht verfügbares Bild
Brak zdjęcia
Картина недоступна

Picture not available
Image non disponible
Imagen no disponible
Immagine non disponibile
Nicht verfügbares Bild
Brak zdjęcia
Картина недоступна

- PLASTIC CAPSULE 26 590629
 - FRONT BEARING 21 592780
 - REAR BEARING 22 590613
 - PROTECTION COVER 24 590563
 - BRUSH HOLDER 09 092967
 - SEP:SEPARATED REGULATOR -INC:BUILT-IN REGULATOR 02 590536
 - RECTIFIER OR DIODE BRIDGE ASSEMBLY 07 593199
 - ROTOR 04 592727
 - STATOR 05 101518
- Valeo** 592601

A14N113 75 2 6V
14 60° 62,09

Picture not available
Image non disponible
Imagen no disponible
Immagine non disponibile
Nicht verfügbares Bild
Brak zdjęcia
Картина недоступна

Picture not available
Image non disponible
Imagen no disponible
Immagine non disponibile
Nicht verfügbares Bild
Brak zdjęcia
Картина недоступна

- PLASTIC CAPSULE 26 590629
 - REAR BEARING 22 590613
 - PROTECTION COVER 24 590563
 - BRUSH SET 09a 300821
 - SEP:SEPARATED REGULATOR -INC:BUILT-IN REGULATOR 02 *2590558
 - FAN 12 592673
 - PULLEY 11 105760
 - ROTOR 04 *300807
 - STATOR 05 101025
- Valeo** 433073

A14N114T 65 2 1V
28 20° 74

Picture not available
Image non disponible
Imagen no disponible
Immagine non disponibile
Nicht verfügbares Bild
Brak zdjęcia
Картина недоступна

Picture not available
Image non disponible
Imagen no disponible
Immagine non disponibile
Nicht verfügbares Bild
Brak zdjęcia
Картина недоступна

- FRONT BEARING 21 592860
 - PROTECTION COVER 24 590563
 - REAR BRACKET 25 590663
 - BRUSH HOLDER 09 300665
 - SEP:SEPARATED REGULATOR -INC:BUILT-IN REGULATOR 02 590640
 - RECTIFIER OR DIODE BRIDGE ASSEMBLY 07 102556
 - ROTOR 04 300681
 - STATOR 05 101518
- Valeo** 2181760/436351

A14N115M 60 2
28 2°

Picture not available
Image non disponible
Imagen no disponible
Immagine non disponibile
Nicht verfügbares Bild
Brak zdjęcia
Картина недоступна

Picture not available
Image non disponible
Imagen no disponible
Immagine non disponibile
Nicht verfügbares Bild
Brak zdjęcia
Картина недоступна

- PLASTIC CAPSULE 26 590629
 - FRONT BEARING 21 592860
 - REAR BEARING 22 590613
 - PROTECTION COVER 24 590563
 - REAR BRACKET 25 590574
 - BRUSH HOLDER 09 092967
 - SEP:SEPARATED REGULATOR -INC:BUILT-IN REGULATOR 02 182169
 - RECTIFIER OR DIODE BRIDGE ASSEMBLY 07 102556
 - FAN 12 592703
 - ROTOR 04 592727
 - STATOR 05 101518
- Valeo** 592786/436351



A14N116M

60 2 SP

28 ↻ 20°

Picture not available
Image non disponible
Imagen no disponible
Immagine non disponibile
Nicht verfügbares Bild
Brak zdjęcia
Картина недоступна

Picture not available
Image non disponible
Imagen no disponible
Immagine non disponibile
Nicht verfügbares Bild
Brak zdjęcia
Картина недоступна

PLASTIC CAPSULE 📏26 590629
FRONT BEARING 📏21 592780
REAR BEARING 📏22 590613
PROTECTION COVER 📏24 590563
REAR BRACKET 📏25 590574
BRUSH HOLDER 📏09 092967
SEP:SEPARATED REGULATOR -INC:BUILT-IN REGULATOR 📏02 182169
RECTIFIER OR DIODE BRIDGE ASSEMBLY 📏07 102556
ROTOR 📏04 592727
STATOR 📏05 101518

Valeo**2181762/436351****A14N117**

90 2 6V

14 ↻ 60° Ø 69,2

Picture not available
Image non disponible
Imagen no disponible
Immagine non disponibile
Nicht verfügbares Bild
Brak zdjęcia
Картина недоступна

Picture not available
Image non disponible
Imagen no disponible
Immagine non disponibile
Nicht verfügbares Bild
Brak zdjęcia
Картина недоступна

PLASTIC CAPSULE 📏26 590629
REAR BEARING 📏22 590613
SEP:SEPARATED REGULATOR -INC:BUILT-IN REGULATOR 📏02 *2590558
RECTIFIER OR DIODE BRIDGE ASSEMBLY 📏07 105135
RECTIFIER OR DIODE BRIDGE ASSEMBLY 📏07 180593
FAN 📏12 592703
PULLEY 📏11 105760
ROTOR 📏04 *300807

Valeo**433074****A14N118M**

60 1 SP

28 ↻ 20°

Picture not available
Image non disponible
Imagen no disponible
Immagine non disponibile
Nicht verfügbares Bild
Brak zdjęcia
Картина недоступна

Picture not available
Image non disponible
Imagen no disponible
Immagine non disponibile
Nicht verfügbares Bild
Brak zdjęcia
Картина недоступна

PLASTIC CAPSULE 📏26 590629
FRONT BEARING 📏21 592780
REAR BEARING 📏22 590613
PROTECTION COVER 📏24 590563
BRUSH HOLDER 📏09 092967
SEP:SEPARATED REGULATOR -INC:BUILT-IN REGULATOR 📏02 590536
RECTIFIER OR DIODE BRIDGE ASSEMBLY 📏07 593309
ROTOR 📏04 592727
STATOR 📏05 101518

Valeo**592601/436734****A14N119M**

60 1 SP

28 ↻ 20°

Picture not available
Image non disponible
Imagen no disponible
Immagine non disponibile
Nicht verfügbares Bild
Brak zdjęcia
Картина недоступна

Picture not available
Image non disponible
Imagen no disponible
Immagine non disponibile
Nicht verfügbares Bild
Brak zdjęcia
Картина недоступна

PLASTIC CAPSULE 📏26 590629
FRONT BEARING 📏21 592780
REAR BEARING 📏22 590613
PROTECTION COVER 📏24 590563
BRUSH HOLDER 📏09 092967
SEP:SEPARATED REGULATOR -INC:BUILT-IN REGULATOR 📏02 182169
RECTIFIER OR DIODE BRIDGE ASSEMBLY 📏07 593199
ROTOR 📏04 592727
STATOR 📏05 101518

Valeo**180620/436438****A14N12**

75 2 1V

14 ↻ 20° Ø 59,7 INC

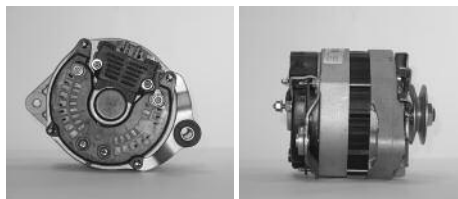

SEP:SEPARATED REGULATOR -INC:BUILT-IN REGULATOR 📏02 *2590558

Valeo**432777/436247****A14N120**

100 2 1V

14 ↻ 55° Ø 62,9

Picture not available
Image non disponible
Imagen no disponible
Immagine non disponibile
Nicht verfügbares Bild
Brak zdjęcia
Картина недоступна

Picture not available
Image non disponible
Imagen no disponible
Immagine non disponibile
Nicht verfügbares Bild
Brak zdjęcia
Картина недоступна

PLASTIC CAPSULE 📏26 590629
FRONT BEARING 📏21 593224
REAR BEARING 📏22 590613
ROTOR 📏04 300696
SEP:SEPARATED REGULATOR -INC:BUILT-IN REGULATOR 📏02 103487

Valeo**433125****A14N121**

75 1 1V

14 ↻ 60° Ø 59,7 INC

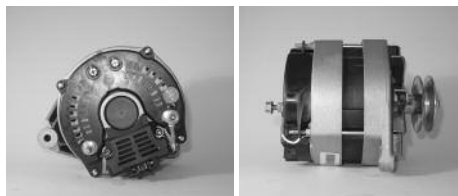









SEP:SEPARATED REGULATOR -INC:BUILT-IN REGULATOR 📏02 *2590558

Valeo**433126/436456**

A14N122M 60 1 SP28  20°

Picture not available
Image non disponible
Imagen no disponible
Immagine non disponibile
Nicht verfügbares Bild
Brak zdjęcia
Картина недоступна







Picture not available
Image non disponible
Imagen no disponible
Immagine non disponibile
Nicht verfügbares Bild
Brak zdjęcia
Картина недоступна

PLASTIC CAPSULE  26 590629
FRONT BEARING  21 592780
REAR BEARING  22 590613
PROTECTION COVER  24 590563
BRUSH HOLDER  09 092967
SEP:SEPARATED REGULATOR -INC:BUILT-IN REGULATOR  02 590536
RECTIFIER OR DIODE BRIDGE ASSEMBLY  07 593199
ROTOR  04 592727
STATOR  05 101518
Valeo 592601

A14N123 80 1 4V14  60° Ø 59,4

Picture not available
Image non disponible
Imagen no disponible
Immagine non disponibile
Nicht verfügbares Bild
Brak zdjęcia
Картина недоступна

Picture not available
Image non disponible
Imagen no disponible
Immagine non disponibile
Nicht verfügbares Bild
Brak zdjęcia
Картина недоступна

PLASTIC CAPSULE  26 590629
FRONT BEARING  21 593224
REAR BEARING  22 590613
PROTECTION COVER  24 590563
SEP:SEPARATED REGULATOR -INC:BUILT-IN REGULATOR  02 182120
ROTOR  04 *300807
Valeo 433071

A14N124+ 105 2 5V14  60° Ø 71,16 INC

PLASTIC CAPSULE  26 590629
REAR BEARING  22 590613
REAR BRACKET  25 593228
SEP:SEPARATED REGULATOR -INC:BUILT-IN REGULATOR  02 590660
RECTIFIER OR DIODE BRIDGE ASSEMBLY  07 300903
STATOR  05 518688
Valeo 433127/436457

A14N125 90 2 5V14  60° Ø 71,16 INC

PLASTIC CAPSULE  26 590629
FRONT BEARING  21 593224
REAR BEARING  22 590613
SEP:SEPARATED REGULATOR -INC:BUILT-IN REGULATOR  02



*2590558

RECTIFIER OR DIODE BRIDGE ASSEMBLY  07 180593
ROTOR  04 300696
STATOR  05 101868
Valeo 432814/433452

A14N13 80 2 1V14  Ø 59,7





Picture not available
Image non disponible
Imagen no disponible
Immagine non disponibile
Nicht verfügbares Bild
Brak zdjęcia
Картина недоступна

Picture not available
Image non disponible
Imagen no disponible
Immagine non disponibile
Nicht verfügbares Bild
Brak zdjęcia
Картина недоступна

PLASTIC CAPSULE  26 590627
FRONT BEARING  21 593224
REAR BEARING  22 590568
PROTECTION COVER  24 590563
BRUSH HOLDER  09 092859

SEP:SEPARATED REGULATOR -INC:BUILT-IN REGULATOR  02

*2590558

SEP:SEPARATED REGULATOR -INC:BUILT-IN REGULATOR  02 541137
RECTIFIER OR DIODE BRIDGE ASSEMBLY  07 180593
FAN  12 592703
PULLEY  11 593253
STATOR  05 101025
Valeo 432786/436318

A14N130 90 2 1V14  6° Ø 67,2

Picture not available
Image non disponible
Imagen no disponible
Immagine non disponibile
Nicht verfügbares Bild
Brak zdjęcia
Картина недоступна

Picture not available
Image non disponible
Imagen no disponible
Immagine non disponibile
Nicht verfügbares Bild
Brak zdjęcia
Картина недоступна

FRONT BEARING  21 593224
REAR BEARING  22 590613
PROTECTION COVER  24 590563
SEP:SEPARATED REGULATOR -INC:BUILT-IN REGULATOR  02

*2590558

PULLEY  11 593253
STATOR  05 101868
Valeo 433107

A14N131 90 2 1V14  20° Ø 66,5 INC

PLASTIC CAPSULE  26 590629
FRONT BEARING  21 593224
REAR BEARING  22 590613
PROTECTION COVER  24 590563
SEP:SEPARATED REGULATOR -INC:BUILT-IN REGULATOR  02

*2590558

PULLEY  11 593212
ROTOR  04 *300807
STATOR  05 101868
Valeo 433464

A14N132

90 2 6V

14 ↻ 0° Ø 62,9 INC

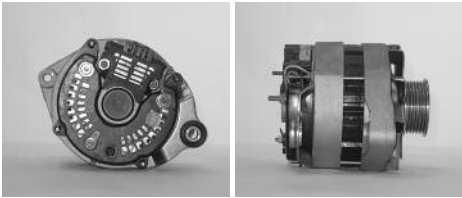

PLASTIC CAPSULE	26	590629
REAR BEARING	22	590613
PROTECTION COVER	24	590563
SEP:SEPARATED REGULATOR -INC:BUILT-IN REGULATOR	02	
*2590558		
RECTIFIER OR DIODE BRIDGE ASSEMBLY	07	592880
PULLEY	11	105760
ROTOR	04	300696
STATOR	05	101868

Valeo**433108/436454****A14N133**

55 1 2V

28 ↻ 0° Ø 75

Picture not available
Image non disponible
Imagen no disponible
Imagine non disponibile
Nicht verfügbares Bild
Brak zdjęcia
Картина недоступна

Picture not available
Image non disponible
Imagen no disponible
Imagine non disponibile
Nicht verfügbares Bild
Brak zdjęcia
Картина недоступна

PLASTIC CAPSULE	26	590629
FRONT BEARING	21	593224
REAR BEARING	22	590613
PROTECTION COVER	24	590563
BRUSH HOLDER	09	300665
SEP:SEPARATED REGULATOR -INC:BUILT-IN REGULATOR	02	590640
RECTIFIER OR DIODE BRIDGE ASSEMBLY	07	104269
STATOR	05	102589

Valeo**592774/436412****A14N134**

75 2 1V

14 ↻ 0° Ø 66 INC

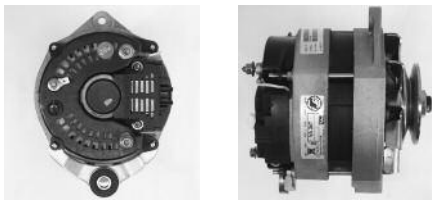

PLASTIC CAPSULE	26	590629
FRONT BEARING	21	593224
REAR BEARING	22	590613
PROTECTION COVER	24	590563
SEP:SEPARATED REGULATOR -INC:BUILT-IN REGULATOR	02	
*2590558		
FAN	12	592673
PULLEY	11	096879
ROTOR	04	300696
STATOR	05	101025

Valeo**433089/433450****A14N135**

55 2 SP

28 ↻ 0° Ø 0

Picture not available
Image non disponible
Imagen no disponible
Imagine non disponibile
Nicht verfügbares Bild
Brak zdjęcia
Картина недоступна

Picture not available
Image non disponible
Imagen no disponible
Imagine non disponibile
Nicht verfügbares Bild
Brak zdjęcia
Картина недоступна

PLASTIC CAPSULE	26	590629
FRONT BEARING	21	593224
REAR BEARING	22	590613
PROTECTION COVER	24	590563
REAR BRACKET	25	590638
BRUSH HOLDER	09	300665
SEP:SEPARATED REGULATOR -INC:BUILT-IN REGULATOR	02	590640
RECTIFIER OR DIODE BRIDGE ASSEMBLY	07	104269
STATOR	05	102589

Valeo**541147/436433****A14N137M**

60 2

28 ↻ 2°

Picture not available
Image non disponible
Imagen no disponible
Imagine non disponibile
Nicht verfügbares Bild
Brak zdjęcia
Картина недоступна

Picture not available
Image non disponible
Imagen no disponible
Imagine non disponibile
Nicht verfügbares Bild
Brak zdjęcia
Картина недоступна

PLASTIC CAPSULE	26	590629
FRONT BEARING	21	592780
REAR BEARING	22	590613
PROTECTION COVER	24	590563
REAR BRACKET	25	590663
BRUSH HOLDER	09	092967
SEP:SEPARATED REGULATOR -INC:BUILT-IN REGULATOR	02	590536
RECTIFIER OR DIODE BRIDGE ASSEMBLY	07	593199
ROTOR	04	592727
STATOR	05	101518

Valeo**592775****A14N138+**

75 2 SP

28 ↻ 0° Ø 0

Picture not available
Image non disponible
Imagen no disponible
Imagine non disponibile
Nicht verfügbares Bild
Brak zdjęcia
Картина недоступна

Picture not available
Image non disponible
Imagen no disponible
Imagine non disponibile
Nicht verfügbares Bild
Brak zdjęcia
Картина недоступна

PLASTIC CAPSULE	26	590629
FRONT BEARING	21	592860
REAR BEARING	22	590613
PROTECTION COVER	24	590566
REAR BRACKET	25	590658
BRUSH HOLDER	09	300665
SEP:SEPARATED REGULATOR -INC:BUILT-IN REGULATOR	02	590640
CONDENSOR	14	105604
RECTIFIER OR DIODE BRIDGE ASSEMBLY	07	592752
ROTOR	04	182055

Valeo**541178/436434**

A14N139

80

2

5V

14



20°

Ø 59,4

INC

**B+(M8)D+(M5)**

FRONT BEARING	21	593224
REAR BEARING	22	590613
SEP:SEPARATED REGULATOR -INC:BUILT-IN REGULATOR	02	590688
RECTIFIER OR DIODE BRIDGE ASSEMBLY	07	592878
FAN	12	592703
PULLEY	11	181485

Valeo**433129/433469****A14N14**

80

2

14



Picture not available
Image non disponible
Imagen no disponible
Immagine non disponibile
Nicht verfügbares Bild
Brak zdjęćia
Картина недоступна

Picture not available
Image non disponible
Imagen no disponible
Immagine non disponibile
Nicht verfügbares Bild
Brak zdjęćia
Картина недоступна

PLASTIC CAPSULE	26	590629
FRONT BEARING	21	593224
REAR BEARING	22	590613
PROTECTION COVER	24	590563
BRUSH HOLDER	09	092859
SEP:SEPARATED REGULATOR -INC:BUILT-IN REGULATOR	02	*2590558
SEP:SEPARATED REGULATOR -INC:BUILT-IN REGULATOR	02	541137
RECTIFIER OR DIODE BRIDGE ASSEMBLY	07	180593
FAN	12	592703
PULLEY	11	593253
REAR BRACKET	25	101113
HARDWARE OF PULLEY	13	300761
STATOR	05	101025

Valeo**101795****A14N140+**

105

2

1V

14



0°

Ø 66

INC

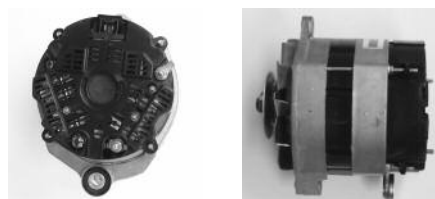

FRONT BEARING	21	592860
REAR BEARING	22	590613
PROTECTION COVER	24	590566
SEP:SEPARATED REGULATOR -INC:BUILT-IN REGULATOR	02	590660
RECTIFIER OR DIODE BRIDGE ASSEMBLY	07	300903
FAN	12	592703
PULLEY	11	096879
STATOR	05	518688

A14N140+

105

2

1V

14



0°

Ø 66

INC

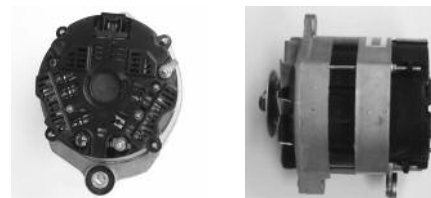

FRONT BEARING	21	592860
REAR BEARING	22	590613
PROTECTION COVER	24	590566
SEP:SEPARATED REGULATOR -INC:BUILT-IN REGULATOR	02	590660
RECTIFIER OR DIODE BRIDGE ASSEMBLY	07	300903
FAN	12	592703
PULLEY	11	096879
STATOR	05	518688

Valeo**433130/433466****A14N141M**

60

1

SP

28



20°

Ø 0

Picture not available
Image non disponible
Imagen no disponible
Immagine non disponibile
Nicht verfügbares Bild
Brak zdjęćia
Картина недоступна

Picture not available
Image non disponible
Imagen no disponible
Immagine non disponibile
Nicht verfügbares Bild
Brak zdjęćia
Картина недоступна

PLASTIC CAPSULE	26	590629
FRONT BEARING	21	592780
REAR BEARING	22	590613
PROTECTION COVER	24	590563
BRUSH HOLDER	09	092967
SEP:SEPARATED REGULATOR -INC:BUILT-IN REGULATOR	02	182169
RECTIFIER OR DIODE BRIDGE ASSEMBLY	07	592754
ROTOR	04	592727
STATOR	05	101518

A14N141M

60

1

SP

28



20°

Ø 0

Picture not available
Image non disponible
Imagen no disponible
Immagine non disponibile
Nicht verfügbares Bild
Brak zdjęćia
Картина недоступна

Picture not available
Image non disponible
Imagen no disponible
Immagine non disponibile
Nicht verfügbares Bild
Brak zdjęćia
Картина недоступна

PLASTIC CAPSULE	26	590629
FRONT BEARING	21	592780
REAR BEARING	22	590613
PROTECTION COVER	24	590563
BRUSH HOLDER	09	092967
SEP:SEPARATED REGULATOR -INC:BUILT-IN REGULATOR	02	182169
RECTIFIER OR DIODE BRIDGE ASSEMBLY	07	592754
ROTOR	04	592727
STATOR	05	101518

Valeo**592776/436440**

A14N142

90 2 1V

14 ↻ 0° ∇ Ø 66 INC

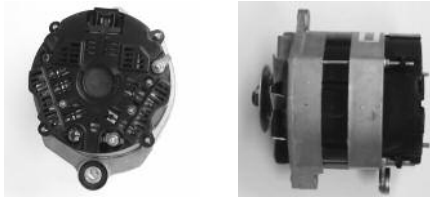

PLASTIC CAPSULE 🛠️ 26	590629
FRONT BEARING 🛠️ 21	593224
REAR BEARING 🛠️ 22	590613
PROTECTION COVER 🛠️ 24	590563
SEP:SEPARATED REGULATOR -INC:BUILT-IN REGULATOR 🛠️ 02	
*2590558	
FAN 🛠️ 12	592703
PULLEY 🛠️ 11	096879
ROTOR 🛠️ 04	300696
STATOR 🛠️ 05	101868

A14N142

90 2 1V

14 ↻ 0° ∇ Ø 66 INC

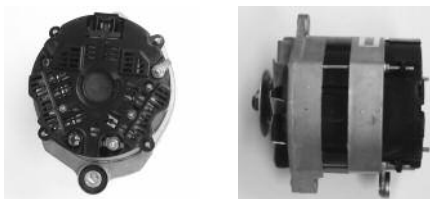

PLASTIC CAPSULE 🛠️ 26	590629
FRONT BEARING 🛠️ 21	593224
REAR BEARING 🛠️ 22	590613
PROTECTION COVER 🛠️ 24	590563
SEP:SEPARATED REGULATOR -INC:BUILT-IN REGULATOR 🛠️ 02	
*2590558	
FAN 🛠️ 12	592703
PULLEY 🛠️ 11	096879
ROTOR 🛠️ 04	300696
STATOR 🛠️ 05	101868

Valeo**433131/436459****A14N144**

75 2 1V

14 ↻ 20° ∇ Ø 79,4 INC

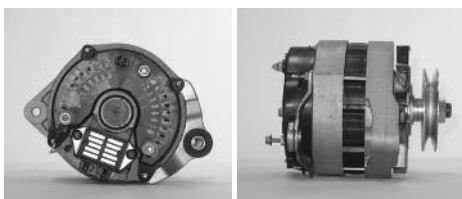

PLASTIC CAPSULE 🛠️ 26	590629
FRONT BEARING 🛠️ 21	593224
REAR BEARING 🛠️ 22	590613
PROTECTION COVER 🛠️ 24	590563
SEP:SEPARATED REGULATOR -INC:BUILT-IN REGULATOR 🛠️ 02	
*2590558	
RECTIFIER OR DIODE BRIDGE ASSEMBLY 🛠️ 07	593193
FAN 🛠️ 12	592673
PULLEY 🛠️ 11	101932
ROTOR 🛠️ 04	300694
STATOR 🛠️ 05	101025

Valeo**432783/433453****A14N145**

80 1 4V

14 ↻ 50° ∇ Ø 59,4

Picture not available
Image non disponible
Imagen no disponible
Immagine non disponibile
Nicht verfügbares Bild
Brak zdjęcia
Картина недоступна

Picture not available
Image non disponible
Imagen no disponible
Immagine non disponibile
Nicht verfügbares Bild
Brak zdjęcia
Картина недоступна

PLASTIC CAPSULE 🛠️ 26	590629
FRONT BEARING 🛠️ 21	593224
REAR BEARING 🛠️ 22	590613
PROTECTION COVER 🛠️ 24	590563
SEP:SEPARATED REGULATOR -INC:BUILT-IN REGULATOR 🛠️ 02	182120
Valeo	433071

A14N148

90 2 1V

14 ↻ 20° ∇ Ø 66,5

Picture not available
Image non disponible
Imagen no disponible
Immagine non disponibile
Nicht verfügbares Bild
Brak zdjęcia
Картина недоступна

Picture not available
Image non disponible
Imagen no disponible
Immagine non disponibile
Nicht verfügbares Bild
Brak zdjęcia
Картина недоступна

PLASTIC CAPSULE 🛠️ 26	590629
FRONT BEARING 🛠️ 21	592780
REAR BEARING 🛠️ 22	590613
PROTECTION COVER 🛠️ 24	590563
SEP:SEPARATED REGULATOR -INC:BUILT-IN REGULATOR 🛠️ 02	590512
RECTIFIER OR DIODE BRIDGE ASSEMBLY 🛠️ 07	593199
STATOR 🛠️ 05	101025

A14N150

75 2 1V

14 ↻ 0° ∇ Ø 66 INC

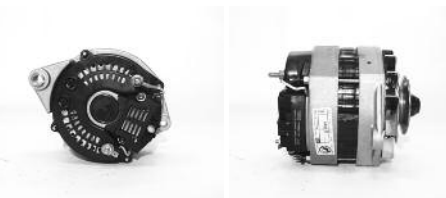

PLASTIC CAPSULE 🛠️ 26	590629
FRONT BEARING 🛠️ 21	593224
REAR BEARING 🛠️ 22	590613
PROTECTION COVER 🛠️ 24	590563
SEP:SEPARATED REGULATOR -INC:BUILT-IN REGULATOR 🛠️ 02	
*2590558	
FAN 🛠️ 12	592673
PULLEY 🛠️ 11	096879
ROTOR 🛠️ 04	300696
STATOR 🛠️ 05	101025

Valeo**433132/436453****A14N151**

90 2 1V

14 ↻ 20° ∇ Ø 66,5 INC

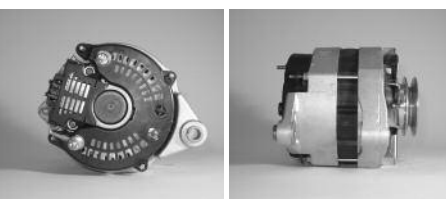

PLASTIC CAPSULE 🛠️ 26	590629
FRONT BEARING 🛠️ 21	593224
REAR BEARING 🛠️ 22	590613
PROTECTION COVER 🛠️ 24	590563
SEP:SEPARATED REGULATOR -INC:BUILT-IN REGULATOR 🛠️ 02	

*2590558
FAN 12 592703
PULLEY 11 593212
ROTOR 04 *300807
STATOR 05 101868
Valeo **433133/433464**

A14N152	90	2	6V
14		60°	Ø 62,9 INC



PLASTIC CAPSULE 26 590629
REAR BEARING 22 590613
PROTECTION COVER 24 590563
SEP:SEPARATED REGULATOR -INC:BUILT-IN REGULATOR 02

*2590558
RECTIFIER OR DIODE BRIDGE ASSEMBLY 07 592880
FAN 12 592703
PULLEY 11 105760
ROTOR 04 592815
STATOR 05 101868
Valeo **433184/436335**

A14N156	90	2	3V
14		20°	Ø 67,2 INC

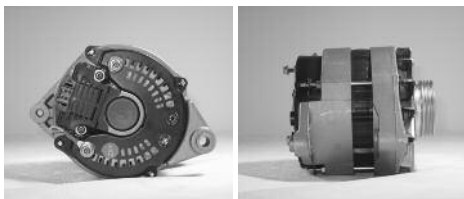

PLASTIC CAPSULE 26 590629
FRONT BEARING 21 593224
REAR BEARING 22 590613
PROTECTION COVER 24 590563
SEP:SEPARATED REGULATOR -INC:BUILT-IN REGULATOR 02

*2590558
FAN 12 592703
ROTOR 04 *300807
STATOR 05 101868

A14N156	90	2	3V
14		20°	Ø 67,2 INC

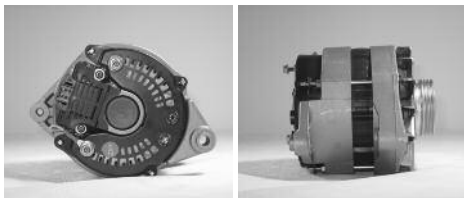

PLASTIC CAPSULE 26 590629
FRONT BEARING 21 593224
REAR BEARING 22 590613
PROTECTION COVER 24 590563
SEP:SEPARATED REGULATOR -INC:BUILT-IN REGULATOR 02

*2590558
FAN 12 592703
ROTOR 04 *300807
STATOR 05 101868
Valeo **433150/436251**

A14N158	90	2	1V
14		60°	Ø 59,7 INC



PLASTIC CAPSULE 26 590629
FRONT BEARING 21 593224
REAR BEARING 22 590613
PROTECTION COVER 24 590563
SEP:SEPARATED REGULATOR -INC:BUILT-IN REGULATOR 02

*2590558
RECTIFIER OR DIODE BRIDGE ASSEMBLY 07 592880
FAN 12 592703
PULLEY 11 593253
ROTOR 04 *300807
STATOR 05 101868
Valeo **433163/436464**

A14N160+	75	2	SP
28		0°	

Picture not available Image non disponible Imagen no disponible Immagine non disponibile Nicht verfügbares Bild Brak zdjęćia Картина недоступна	Picture not available Image non disponible Imagen no disponible Immagine non disponibile Nicht verfügbares Bild Brak zdjęćia Картина недоступна
---	---

PLASTIC CAPSULE 26 590629
FRONT BEARING 21 592860
REAR BEARING 22 590613
PROTECTION COVER 24 590566
REAR BRACKET 25 590658
SEP:SEPARATED REGULATOR -INC:BUILT-IN REGULATOR 02 590640
CONDENSOR 14 105604
RECTIFIER OR DIODE BRIDGE ASSEMBLY 07 592752
ROTOR 04 182055
Valeo **592778/436680**

A14N163	75	2	1V
14		20°	Ø 79,4 INC



PLASTIC CAPSULE 26 590629
FRONT BEARING 21 593224
REAR BEARING 22 590613
PROTECTION COVER 24 590563
SEP:SEPARATED REGULATOR -INC:BUILT-IN REGULATOR 02

*2590558
RECTIFIER OR DIODE BRIDGE ASSEMBLY 07 593193
FAN 12 592673
PULLEY 11 101932
ROTOR 04 300694
STATOR 05 101025
Valeo **439240/436349**



A14N164

90

2

6V

14



0°

Ø 62,9

INC

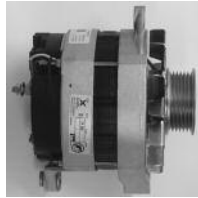

PLASTIC CAPSULE	26	590629
REAR BEARING	22	590613
PROTECTION COVER	24	590563
SEP:SEPARATED REGULATOR -INC:BUILT-IN REGULATOR	02	*2590558
RECTIFIER OR DIODE BRIDGE ASSEMBLY	07	592880
FAN	12	592703
PULLEY	11	105760
ROTOR	04	300696
STATOR	05	101868
Valeo		433151/436256

A14N165+

135

2

5V

14



60°

Ø 71,16

Picture not available
Image non disponible
Imagen no disponible
Immagine non disponibile
Nicht verfügbares Bild
Brak zdjęćia
Картина недоступна

Picture not available
Image non disponible
Imagen no disponible
Immagine non disponibile
Nicht verfügbares Bild
Brak zdjęćia
Картина недоступна

PLASTIC CAPSULE	26	590629
REAR BEARING	22	590613
REAR BRACKET	25	593228
SEP:SEPARATED REGULATOR -INC:BUILT-IN REGULATOR	02	590660
RECTIFIER OR DIODE BRIDGE ASSEMBLY	07	300903
FAN	12	592703

A14N171

90

2

6V

14



0°

Ø 58,18

INC



PLASTIC CAPSULE	26	590629
REAR BEARING	22	590613
PROTECTION COVER	24	590563
SEP:SEPARATED REGULATOR -INC:BUILT-IN REGULATOR	02	*2590558
FAN	12	592703
ROTOR	04	300696
STATOR	05	101868
Valeo		433152/436462

A14N172

80

2

5V

14



20°

Ø 59,4

INC

**B+(M8)D+(M5)**

FRONT BEARING	21	593224
REAR BEARING	22	590613
SEP:SEPARATED REGULATOR -INC:BUILT-IN REGULATOR	02	590688
RECTIFIER OR DIODE BRIDGE ASSEMBLY	07	592878
FAN	12	592703
PULLEY	11	181485
Valeo		433129/433469

A14N173

80

1

4V

14



60°

Ø 59,4

Picture not available
Image non disponible
Imagen no disponible
Immagine non disponibile
Nicht verfügbares Bild
Brak zdjęćia
Картина недоступна

Picture not available
Image non disponible
Imagen no disponible
Immagine non disponibile
Nicht verfügbares Bild
Brak zdjęćia
Картина недоступна

PLASTIC CAPSULE	26	590629
FRONT BEARING	21	593224
REAR BEARING	22	590613
PROTECTION COVER	24	590563
SEP:SEPARATED REGULATOR -INC:BUILT-IN REGULATOR	02	182120
RECTIFIER OR DIODE BRIDGE ASSEMBLY	07	592877
FAN	12	592673
ROTOR	04	*300807
Valeo		433071

A14N176

90

2

1V

14



20°

Ø 79,4

Picture not available
Image non disponible
Imagen no disponible
Immagine non disponibile
Nicht verfügbares Bild
Brak zdjęćia
Картина недоступна

Picture not available
Image non disponible
Imagen no disponible
Immagine non disponibile
Nicht verfügbares Bild
Brak zdjęćia
Картина недоступна

PLASTIC CAPSULE	26	590627
FRONT BEARING	21	593224
REAR BEARING	22	590613
PROTECTION COVER	24	590563
SEP:SEPARATED REGULATOR -INC:BUILT-IN REGULATOR	02	*2590558
RECTIFIER OR DIODE BRIDGE ASSEMBLY	07	592880
FAN	12	592703
PULLEY	11	101932
ROTOR	04	300694
STATOR	05	101868
Valeo		436391

A14N177M

60

2

SP

28



20°

Picture not available
Image non disponible
Imagen no disponible
Immagine non disponibile
Nicht verfügbares Bild
Brak zdjęćia
Картина недоступна

Picture not available
Image non disponible
Imagen no disponible
Immagine non disponibile
Nicht verfügbares Bild
Brak zdjęćia
Картина недоступна

PLASTIC CAPSULE	26	590629
FRONT BEARING	21	592860
REAR BEARING	22	590613
PROTECTION COVER	24	590563
REAR BRACKET	25	590574
SEP:SEPARATED REGULATOR -INC:BUILT-IN REGULATOR	02	182169
RECTIFIER OR DIODE BRIDGE ASSEMBLY	07	102556
FAN	12	100809
ROTOR	04	592727
STATOR	05	101518
Valeo		436707

A14N178

90

2

1V

14



0°

Ø 63,25

Picture not available
Image non disponible
Imagen no disponible
Immagine non disponibile
Nicht verfügbares Bild
Brak zdjęćia
Картина недоступна

Picture not available
Image non disponible
Imagen no disponible
Immagine non disponibile
Nicht verfügbares Bild
Brak zdjęćia
Картина недоступна

PLASTIC CAPSULE	26	590629
FRONT BEARING	21	593224
REAR BEARING	22	590613
PROTECTION COVER	24	590563
SEP:SEPARATED REGULATOR -INC:BUILT-IN REGULATOR	02	*2590558
RECTIFIER OR DIODE BRIDGE ASSEMBLY	07	592881
FAN	12	592703
PULLEY	11	096882
ROTOR	04	300696
STATOR	05	101868
Valeo		433178

A14N18

90

2

4V

14



20°

Ø 59,4

INC

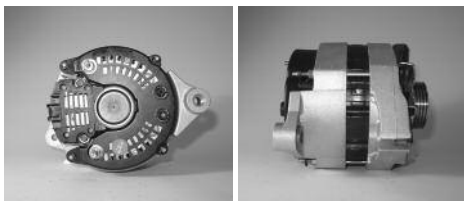

PLASTIC CAPSULE	26	590629
FRONT BEARING	21	593224
REAR BEARING	22	590613
PROTECTION COVER	24	590563
SEP:SEPARATED REGULATOR -INC:BUILT-IN REGULATOR	02	182120
RECTIFIER OR DIODE BRIDGE ASSEMBLY	07	593180
ROTOR	04	*300807
STATOR	05	101868
Valeo		432779/436322

A14N180+

105

2

1V

14



0°

Ø 82,5

Picture not available
Image non disponible
Imagen no disponible
Immagine non disponibile
Nicht verfügbares Bild
Brak zdjęćia
Картина недоступна

Picture not available
Image non disponible
Imagen no disponible
Immagine non disponibile
Nicht verfügbares Bild
Brak zdjęćia
Картина недоступна

PLASTIC CAPSULE	26	590629
REAR BEARING	22	590613
PROTECTION COVER	24	590566
REAR BRACKET	25	593228
SEP:SEPARATED REGULATOR -INC:BUILT-IN REGULATOR	02	590538
CONDENSOR	14	*105904
RECTIFIER OR DIODE BRIDGE ASSEMBLY	07	592752
FAN	12	592703
STATOR	05	518688
Valeo		436274

A14N181

80

1

5V

14



60°

Ø 59,4

INC

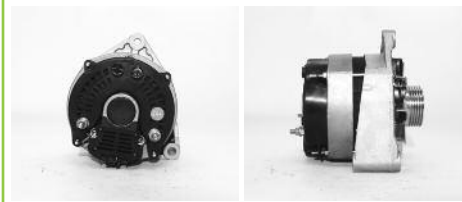

PLASTIC CAPSULE	26	590629
FRONT BEARING	21	593224
REAR BEARING	22	590613
PROTECTION COVER	24	590563
SEP:SEPARATED REGULATOR -INC:BUILT-IN REGULATOR	02	182120
RECTIFIER OR DIODE BRIDGE ASSEMBLY	07	592877
FAN	12	592673
PULLEY	11	592760
ROTOR	04	*300807
Valeo		433186/436343

A14N182

55

2

SP

28



20°

Picture not available
Image non disponible
Imagen no disponible
Immagine non disponibile
Nicht verfügbares Bild
Brak zdjęćia
Картина недоступна

Picture not available
Image non disponible
Imagen no disponible
Immagine non disponibile
Nicht verfügbares Bild
Brak zdjęćia
Картина недоступна

PLASTIC CAPSULE	26	590629
FRONT BEARING	21	593224
REAR BEARING	22	590613
PROTECTION COVER	24	590563
SEP:SEPARATED REGULATOR -INC:BUILT-IN REGULATOR	02	590640
RECTIFIER OR DIODE BRIDGE ASSEMBLY	07	593181
FAN	12	592703
STATOR	05	593277
Valeo		439079/436650











A14N183M

60 2 SP

28  0°

Picture not available
Image non disponible
Imagen no disponible
Immagine non disponibile
Nicht verfügbares Bild
Brak zdjęcia
Картина недоступна

Picture not available
Image non disponible
Imagen no disponible
Immagine non disponibile
Nicht verfügbares Bild
Brak zdjęcia
Картина недоступна

PLASTIC CAPSULE 	26	590629
FRONT BEARING 	21	592780
REAR BEARING 	22	590613
PROTECTION COVER 	24	590563
SEP:SEPARATED REGULATOR -INC:BUILT-IN REGULATOR 	02	182169
RECTIFIER OR DIODE BRIDGE ASSEMBLY 	07	592882
FAN 	12	592703
FRONT BEARING 	21	102130
ROTOR 	04	592727
STATOR 	05	101518
Valeo		439231/436393









A14N185

55 2 1V

28  20°

Picture not available
Image non disponible
Imagen no disponible
Immagine non disponibile
Nicht verfügbares Bild
Brak zdjęcia
Картина недоступна

Picture not available
Image non disponible
Imagen no disponible
Immagine non disponibile
Nicht verfügbares Bild
Brak zdjęcia
Картина недоступна

PLASTIC CAPSULE 	26	590629
FRONT BEARING 	21	593224
REAR BEARING 	22	590613
PROTECTION COVER 	24	590563
SEP:SEPARATED REGULATOR -INC:BUILT-IN REGULATOR 	02	590640
RECTIFIER OR DIODE BRIDGE ASSEMBLY 	07	593181
FAN 	12	592703
PULLEY 	11	593217
STATOR 	05	593277
Valeo		436394









A14N19

80 1

14 

Picture not available
Image non disponible
Imagen no disponible
Immagine non disponibile
Nicht verfügbares Bild
Brak zdjęcia
Картина недоступна

Picture not available
Image non disponible
Imagen no disponible
Immagine non disponibile
Nicht verfügbares Bild
Brak zdjęcia
Картина недоступна

PLASTIC CAPSULE 	26	590627
REAR BEARING 	22	590568
PROTECTION COVER 	24	590563
SEP:SEPARATED REGULATOR -INC:BUILT-IN REGULATOR 	02	182169
*2590558		
RECTIFIER OR DIODE BRIDGE ASSEMBLY 	07	102817
RECTIFIER OR DIODE BRIDGE ASSEMBLY 	07	105135
FAN 	12	592703
STATOR 	05	101025
Valeo		432808









A14N190

55 2 1V

28  20° \emptyset 82

Picture not available
Image non disponible
Imagen no disponible
Immagine non disponibile
Nicht verfügbares Bild
Brak zdjęcia
Картина недоступна

Picture not available
Image non disponible
Imagen no disponible
Immagine non disponibile
Nicht verfügbares Bild
Brak zdjęcia
Картина недоступна

PLASTIC CAPSULE 	26	590629
FRONT BEARING 	21	593224
REAR BEARING 	22	590613
PROTECTION COVER 	24	590563
SEP:SEPARATED REGULATOR -INC:BUILT-IN REGULATOR 	02	590640
RECTIFIER OR DIODE BRIDGE ASSEMBLY 	07	593181
FAN 	12	592703
PULLEY 	11	593216
STATOR 	05	593277
Valeo		439390/436395

A14N194

80 1 4V

14  60° \emptyset 59,4

Picture not available
Image non disponible
Imagen no disponible
Immagine non disponibile
Nicht verfügbares Bild
Brak zdjęcia
Картина недоступна







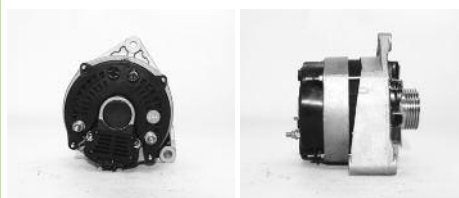

Picture not available
Image non disponible
Imagen no disponible
Immagine non disponibile
Nicht verfügbares Bild
Brak zdjęcia
Картина недоступна

PLASTIC CAPSULE 	26	590629
FRONT BEARING 	21	593224
REAR BEARING 	22	590613
PROTECTION COVER 	24	590563
SEP:SEPARATED REGULATOR -INC:BUILT-IN REGULATOR 	02	182120
RECTIFIER OR DIODE BRIDGE ASSEMBLY 	07	592877
FAN 	12	592673
ROTOR 	04	*300807

A14N195

80 1 5V











14  60° \emptyset 59,4 INC

PLASTIC CAPSULE 	26	590629
FRONT BEARING 	21	593224
REAR BEARING 	22	590613
PROTECTION COVER 	24	590563
SEP:SEPARATED REGULATOR -INC:BUILT-IN REGULATOR 	02	182120
RECTIFIER OR DIODE BRIDGE ASSEMBLY 	07	592877
FAN 	12	592673
PULLEY 	11	592760
ROTOR 	04	*300807
Valeo		433186/436343

A14N196M 60 2 SP28  20° 

Picture not available
Image non disponible
Imagen no disponible
Immagine non disponibile
Nicht verfügbares Bild
Brak zdjęć
Картина недоступна

Picture not available
Image non disponible
Imagen no disponible
Immagine non disponibile
Nicht verfügbares Bild
Brak zdjęć
Картина недоступна

PLASTIC CAPSULE 	26	590629
FRONT BEARING 	21	592860
REAR BEARING 	22	590613
PROTECTION COVER 	24	590563
BRUSH HOLDER 	09	092967
SEP:SEPARATED REGULATOR -INC:BUILT-IN REGULATOR 	02	182169
RECTIFIER OR DIODE BRIDGE ASSEMBLY 	07	593188
FAN 	12	592703
ROTOR 	04	592727
STATOR 	05	101518











Valeo

592786/436663

A14N198M 60 2 SP28  20° 

Picture not available
Image non disponible
Imagen no disponible
Immagine non disponibile
Nicht verfügbares Bild
Brak zdjęć
Картина недоступна

Picture not available
Image non disponible
Imagen no disponible
Immagine non disponibile
Nicht verfügbares Bild
Brak zdjęć
Картина недоступна

PLASTIC CAPSULE 	26	590629
FRONT BEARING 	21	592860
REAR BEARING 	22	590613
PROTECTION COVER 	24	590563
SEP:SEPARATED REGULATOR -INC:BUILT-IN REGULATOR 	02	182169
RECTIFIER OR DIODE BRIDGE ASSEMBLY 	07	593188
FAN 	12	100809
FRONT BEARING 	21	592866
ROTOR 	04	592727
STATOR 	05	101518

Valeo

439183/436707









A14N2 80 2 1V14  55°  Ø 66 INC**SEP:SEPARATED REGULATOR -INC:BUILT-IN REGULATOR**  02300667**A14N2** 80 2 1V14  55°  Ø 66 INC**SEP:SEPARATED REGULATOR -INC:BUILT-IN REGULATOR**  02300667**Valeo**

432808

A14N200M 60 1 SP28  20° 

Picture not available
Image non disponible
Imagen no disponible
Immagine non disponibile
Nicht verfügbares Bild
Brak zdjęć
Картина недоступна

Picture not available
Image non disponible
Imagen no disponible
Immagine non disponibile
Nicht verfügbares Bild
Brak zdjęć
Картина недоступна

PLASTIC CAPSULE 	26	590629
FRONT BEARING 	21	592780
REAR BEARING 	22	590613
PROTECTION COVER 	24	590563
BRUSH HOLDER 	09	092967
SEP:SEPARATED REGULATOR -INC:BUILT-IN REGULATOR 	02	590536
RECTIFIER OR DIODE BRIDGE ASSEMBLY 	07	592754
ROTOR 	04	592727
STATOR 	05	101518

Valeo

439068/436639

A14N205+ 75 2 SP28  0°

Picture not available
Image non disponible
Imagen no disponible
Immagine non disponibile
Nicht verfügbares Bild
Brak zdjęć
Картина недоступна

Picture not available
Image non disponible
Imagen no disponible
Immagine non disponibile
Nicht verfügbares Bild
Brak zdjęć
Картина недоступна

PLASTIC CAPSULE 	26	590629
FRONT BEARING 	21	592860
REAR BEARING 	22	590613
PROTECTION COVER 	24	590566
SEP:SEPARATED REGULATOR -INC:BUILT-IN REGULATOR 	02	590640
RECTIFIER OR DIODE BRIDGE ASSEMBLY 	07	592752
ROTOR 	04	182055









Valeo

439081/436652

A14N206M 60 1 SP28  20° 

Picture not available
Image non disponible
Imagen no disponible
Immagine non disponibile
Nicht verfügbares Bild
Brak zdjęć
Картина недоступна

Picture not available
Image non disponible
Imagen no disponible
Immagine non disponibile
Nicht verfügbares Bild
Brak zdjęć
Картина недоступна

PLASTIC CAPSULE 	26	590629
FRONT BEARING 	21	592780
REAR BEARING 	22	590613
PROTECTION COVER 	24	590563
BRUSH HOLDER 	09	092967
SEP:SEPARATED REGULATOR -INC:BUILT-IN REGULATOR 	02	593308
RECTIFIER OR DIODE BRIDGE ASSEMBLY 	07	593309
ROTOR 	04	592727
STATOR 	05	101518

Valeo

439173/436703



A14N207M

60 2 SP

28 ↻ 0°

Picture not available
Image non disponible
Imagen no disponible
Immagine non disponibile
Nicht verfügbares Bild
Brak zdjęcia
Картина недоступна

Picture not available
Image non disponible
Imagen no disponible
Immagine non disponibile
Nicht verfügbares Bild
Brak zdjęcia
Картина недоступна

PLASTIC CAPSULE 🛠️ 26	590629
FRONT BEARING 🛠️ 21	592780
REAR BEARING 🛠️ 22	590613
PROTECTION COVER 🛠️ 24	590563
SEP:SEPARATED REGULATOR -INC:BUILT-IN REGULATOR 🛠️ 02	590536
RECTIFIER OR DIODE BRIDGE ASSEMBLY 🛠️ 07	592882
FAN 🛠️ 12	592703
ROTOR 🛠️ 04	592727
STATOR 🛠️ 05	101518
Valeo	439314

A14N208M

60 2

28 ↻ 0°

Picture not available
Image non disponible
Imagen no disponible
Immagine non disponibile
Nicht verfügbares Bild
Brak zdjęcia
Картина недоступна

Picture not available
Image non disponible
Imagen no disponible
Immagine non disponibile
Nicht verfügbares Bild
Brak zdjęcia
Картина недоступна

PLASTIC CAPSULE 🛠️ 26	590629
FRONT BEARING 🛠️ 21	592780
REAR BEARING 🛠️ 22	590613
PROTECTION COVER 🛠️ 24	590563
SEP:SEPARATED REGULATOR -INC:BUILT-IN REGULATOR 🛠️ 02	182169
RECTIFIER OR DIODE BRIDGE ASSEMBLY 🛠️ 07	592882
FAN 🛠️ 12	592703
ROTOR 🛠️ 04	592727
STATOR 🛠️ 05	101518
Valeo	439231/437352

A14N22

80 2 1V

14 ↻ 0° Ø 59,7 INC

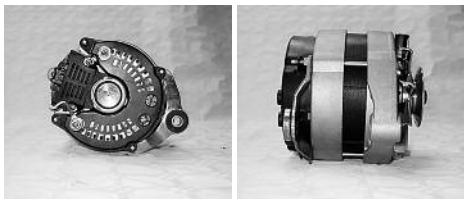

PLASTIC CAPSULE 🛠️ 26	590627
FRONT BEARING 🛠️ 21	593224
REAR BEARING 🛠️ 22	590568
PROTECTION COVER 🛠️ 24	590563
BRUSH HOLDER 🛠️ 09	092859
SEP:SEPARATED REGULATOR -INC:BUILT-IN REGULATOR 🛠️ 02	
*2590558	
RECTIFIER OR DIODE BRIDGE ASSEMBLY 🛠️ 07	105135
PULLEY 🛠️ 11	593253
REAR BRACKET 🛠️ 25	101113
STATOR 🛠️ 05	101025
Valeo	432811/433371

A14N23

75 1 1V

14 ↻ 20° Ø 73,1 INC



PLASTIC CAPSULE 🛠️ 26	590629
FRONT BEARING 🛠️ 21	593224
REAR BEARING 🛠️ 22	590613
PROTECTION COVER 🛠️ 24	590563
BRUSH SET 🛠️ 09a	300821
SEP:SEPARATED REGULATOR -INC:BUILT-IN REGULATOR 🛠️ 02	182120
RECTIFIER OR DIODE BRIDGE ASSEMBLY 🛠️ 07	105754
PULLEY 🛠️ 11	096879
REAR BRACKET 🛠️ 25	102517
ROTOR 🛠️ 04	300694
STATOR 🛠️ 05	101025
Valeo	432803/436246

A14N28T

65 2 2V

28 ↻ 20° Ø 76



REAR BRACKET 🛠️ 25	590663
ROTOR 🛠️ 04	300681
STATOR 🛠️ 05	101518
Valeo	101879/436348

A14N29M

75 2 SP

14 ↻ 20°



PLASTIC CAPSULE 🛠️ 26	590629
FRONT BEARING 🛠️ 21	592860
REAR BEARING 🛠️ 22	590613
PROTECTION COVER 🛠️ 24	590563
REAR BRACKET 🛠️ 25	590574
BRUSH HOLDER 🛠️ 09	092967
STATOR 🛠️ 05	101025
Valeo	102051

A14N35

75 2 1V

14 ↻ 20° Ø 60



SEP:SEPARATED REGULATOR -INC:BUILT-IN REGULATOR 🛠️ 02	
*2590558	
Valeo	432781

A14N36	75	1	1V
14	↻	20°	Ø 66

Picture not available
Image non disponible
Imagen no disponible
Immagine non disponibile
Nicht verfügbares Bild
Brak zdjęć
Картина недоступна

Picture not available
Image non disponible
Imagen no disponible
Immagine non disponibile
Nicht verfügbares Bild
Brak zdjęć
Картина недоступна

SEP:SEPARATED REGULATOR -INC:BUILT-IN REGULATOR 02
*2590558

Valeo **432782/433423**

A14N37	75	1	2V
14	↻	55°	Ø 84,5

Picture not available
Image non disponible
Imagen no disponible
Immagine non disponibile
Nicht verfügbares Bild
Brak zdjęć
Картина недоступна

Picture not available
Image non disponible
Imagen no disponible
Immagine non disponibile
Nicht verfügbares Bild
Brak zdjęć
Картина недоступна

PLASTIC CAPSULE 26 590627
REAR BEARING 22 590568
PROTECTION COVER 24 590563

SEP:SEPARATED REGULATOR -INC:BUILT-IN REGULATOR 02
*2590558

RECTIFIER OR DIODE BRIDGE ASSEMBLY 07 102817
RECTIFIER OR DIODE BRIDGE ASSEMBLY 07 105135
STATOR 05 101025

Valeo **432978**

A14N38	90	1	SP
14	↻	60°	

Picture not available
Image non disponible
Imagen no disponible
Immagine non disponibile
Nicht verfügbares Bild
Brak zdjęć
Картина недоступна

Picture not available
Image non disponible
Imagen no disponible
Immagine non disponibile
Nicht verfügbares Bild
Brak zdjęć
Картина недоступна

PLASTIC CAPSULE 26 590629
FRONT BEARING 21 593224
REAR BEARING 22 590613
BRUSH HOLDER 09 092859

SEP:SEPARATED REGULATOR -INC:BUILT-IN REGULATOR 02 300871
RECTIFIER OR DIODE BRIDGE ASSEMBLY 07 105754
ROTOR 04 300696
STATOR 05 101868

Valeo **432797**

A14N39	55	1	SP
28	↻	0°	

Picture not available
Image non disponible
Imagen no disponible
Immagine non disponibile
Nicht verfügbares Bild
Brak zdjęć
Картина недоступна

Picture not available
Image non disponible
Imagen no disponible
Immagine non disponibile
Nicht verfügbares Bild
Brak zdjęć
Картина недоступна

PLASTIC CAPSULE 26 590629
FRONT BEARING 21 593224
REAR BEARING 22 590613
PROTECTION COVER 24 590563
BRUSH HOLDER 09 300665
SEP:SEPARATED REGULATOR -INC:BUILT-IN REGULATOR 02 590640
RECTIFIER OR DIODE BRIDGE ASSEMBLY 07 104269
STATOR 05 102589

A14N39	55	1	SP
28	↻	0°	

Picture not available
Image non disponible
Imagen no disponible
Immagine non disponibile
Nicht verfügbares Bild
Brak zdjęć
Картина недоступна

Picture not available
Image non disponible
Imagen no disponible
Immagine non disponibile
Nicht verfügbares Bild
Brak zdjęć
Картина недоступна

PLASTIC CAPSULE 26 590629

FRONT BEARING 21 593224

REAR BEARING 22 590613

PROTECTION COVER 24 590563

BRUSH HOLDER 09 300665

SEP:SEPARATED REGULATOR -INC:BUILT-IN REGULATOR 02 590640

RECTIFIER OR DIODE BRIDGE ASSEMBLY 07 104269

STATOR 05 102589

Valeo **102334/436412**

A14N3T	65	2	2V
28	↻	20°	Ø 65

Picture not available
Image non disponible
Imagen no disponible
Immagine non disponibile
Nicht verfügbares Bild
Brak zdjęć
Картина недоступна

Picture not available
Image non disponible
Imagen no disponible
Immagine non disponibile
Nicht verfügbares Bild
Brak zdjęć
Картина недоступна

PROTECTION COVER 24 590563

REAR BRACKET 25 590663

BRUSH HOLDER 09 300682

RECTIFIER OR DIODE BRIDGE ASSEMBLY 07 101342

PULLEY 11 101054

ROTOR 04 300681

STATOR 05 101518

Valeo **100894/436348**

A14N4	75	2	1V
14	↻	20°	Ø 79,4 INC



SEP:SEPARATED REGULATOR -INC:BUILT-IN REGULATOR 02
*2590558

A14N4	75	2	1V
14	↻	20°	Ø 79,4 INC



SEP:SEPARATED REGULATOR -INC:BUILT-IN REGULATOR 02
*2590558

Valeo **432783/436360**

A14N43M

60 2 2V

28 ↻ 20° ∅ 96,5

Picture not available
Image non disponible
Imagen no disponible
Immagine non disponibile
Nicht verfügbares Bild
Brak zdjęcia
Картина недоступна

Picture not available
Image non disponible
Imagen no disponible
Immagine non disponibile
Nicht verfügbares Bild
Brak zdjęcia
Картина недоступна

PLASTIC CAPSULE 📏 26

590629

FRONT BEARING 📏 21

592780

REAR BEARING 📏 22

590613

PROTECTION COVER 📏 24

590563

REAR BRACKET 📏 25

590574

BRUSH HOLDER 📏 09

300760

RECTIFIER OR DIODE BRIDGE ASSEMBLY 📏 07

102556

ROTOR 📏 04

592727

STATOR 📏 05

101518

Valeo**102969/436348****A14N44M**

60 2 2V

28 ↻ 20° ∅ 72

Picture not available
Image non disponible
Imagen no disponible
Immagine non disponibile
Nicht verfügbares Bild
Brak zdjęcia
Картина недоступна

Picture not available
Image non disponible
Imagen no disponible
Immagine non disponibile
Nicht verfügbares Bild
Brak zdjęcia
Картина недоступна

PLASTIC CAPSULE 📏 26

590629

FRONT BEARING 📏 21

592780

REAR BEARING 📏 22

590613

PROTECTION COVER 📏 24

590563

REAR BRACKET 📏 25

590574

BRUSH HOLDER 📏 09

300760

RECTIFIER OR DIODE BRIDGE ASSEMBLY 📏 07

102556

PULLEY 📏 11

101054

ROTOR 📏 04

592727

STATOR 📏 05

101518

Valeo**104794/436348****A14N47M**

60 1

28 ↻

Picture not available
Image non disponible
Imagen no disponible
Immagine non disponibile
Nicht verfügbares Bild
Brak zdjęcia
Картина недоступна

Picture not available
Image non disponible
Imagen no disponible
Immagine non disponibile
Nicht verfügbares Bild
Brak zdjęcia
Картина недоступна

PLASTIC CAPSULE 📏 26

590629

FRONT BEARING 📏 21

592780

REAR BEARING 📏 22

590613

PROTECTION COVER 📏 24

590563

BRUSH HOLDER 📏 09

092967

RECTIFIER OR DIODE BRIDGE ASSEMBLY 📏 07

593199

ROTOR 📏 04

592727

STATOR 📏 05

101518

Valeo**592601****A14N50**

75 2 1V

14 ↻ 0° ∅ 69,75

Picture not available
Image non disponible
Imagen no disponible
Immagine non disponibile
Nicht verfügbares Bild
Brak zdjęcia
Картина недоступна

Picture not available
Image non disponible
Imagen no disponible
Immagine non disponibile
Nicht verfügbares Bild
Brak zdjęcia
Картина недоступна

SEP:SEPARATED REGULATOR -INC:BUILT-IN REGULATOR 📏 02

*2590558

ROTOR 📏 04

593298

Valeo**432786/436318****A14N51**

75 1 1V

14 ↻ 60° ∅ 67,2 INC

Picture not available
Image non disponible
Imagen no disponible
Immagine non disponibile
Nicht verfügbares Bild
Brak zdjęcia
Картина недоступна

Picture not available
Image non disponible
Imagen no disponible
Immagine non disponibile
Nicht verfügbares Bild
Brak zdjęcia
Картина недоступна

SEP:SEPARATED REGULATOR -INC:BUILT-IN REGULATOR 📏 02

*2590558

Valeo**432785/436326****A14N53**

75 2 1V

14 ↻ 0° ∅ 66

Picture not available
Image non disponible
Imagen no disponible
Immagine non disponibile
Nicht verfügbares Bild
Brak zdjęcia
Картина недоступна

Picture not available
Image non disponible
Imagen no disponible
Immagine non disponibile
Nicht verfügbares Bild
Brak zdjęcia
Картина недоступна

SEP:SEPARATED REGULATOR -INC:BUILT-IN REGULATOR 📏 02

*2590558

Valeo**432786/436318****A14N54**

75 2 1V

14 ↻ 60° ∅ 59,7 INC

**SEP:SEPARATED REGULATOR -INC:BUILT-IN REGULATOR** 📏 02

*2590558

Valeo**433039/436249****A14N55**

80 2 1V

14 ↻ 55° ∅ 66 INC

**SEP:SEPARATED REGULATOR -INC:BUILT-IN REGULATOR** 📏 02

*2590558

Valeo**432808/433368**

A14N56	75	1	1V
14	↻	60°	Ø 66

Picture not available
Image non disponible
Imagen no disponible
Immagine non disponibile
Nicht verfügbares Bild
Brak zdjęcia
Картина недоступна

Picture not available
Image non disponible
Imagen no disponible
Immagine non disponibile
Nicht verfügbares Bild
Brak zdjęcia
Картина недоступна

SEP:SEPARATED REGULATOR -INC:BUILT-IN REGULATOR 02
*2590558

Valeo **432802**

A14N59	80	1	1V
14	↻	20°	Ø 60 INC



SEP:SEPARATED REGULATOR -INC:BUILT-IN REGULATOR 02
*2590558

Valeo **432806/436320**

A14N60	90	2	5V
14	↻	60°	Ø 80,94 INC



SEP:SEPARATED REGULATOR -INC:BUILT-IN REGULATOR 02
*2590558

Valeo **432814/433452**

A14N62	75	2	1V
14	↻	0°	Ø 71,5 INC

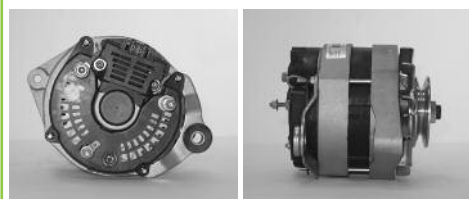

SEP:SEPARATED REGULATOR -INC:BUILT-IN REGULATOR 02
*2590558

Valeo **432788/433451**

A14N63	90	2	6V
14	↻	60°	Ø 62,5

Picture not available
Image non disponible
Imagen no disponible
Immagine non disponibile
Nicht verfügbares Bild
Brak zdjęcia
Картина недоступна

Picture not available
Image non disponible
Imagen no disponible
Immagine non disponibile
Nicht verfügbares Bild
Brak zdjęcia
Картина недоступна

SEP:SEPARATED REGULATOR -INC:BUILT-IN REGULATOR 02
*2590558

Valeo **432789**

A14N64	75	2	1V
14	↻	0°	Ø 66 INC

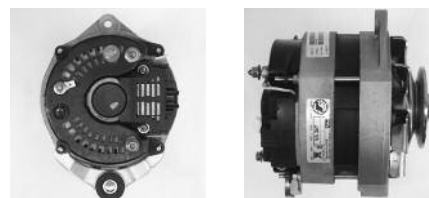

SEP:SEPARATED REGULATOR -INC:BUILT-IN REGULATOR 02
*2590558

Valeo **432793/433450**

A14N65	75	2	6V
14	↻	60°	Ø 62,5

Picture not available
Image non disponible
Imagen no disponible
Immagine non disponibile
Nicht verfügbares Bild
Brak zdjęcia
Картина недоступна

Picture not available
Image non disponible
Imagen no disponible
Immagine non disponibile
Nicht verfügbares Bild
Brak zdjęcia
Картина недоступна

SEP:SEPARATED REGULATOR -INC:BUILT-IN REGULATOR 02
*2590558

Valeo **432789**

A14N67+	90		
14	↻		INC

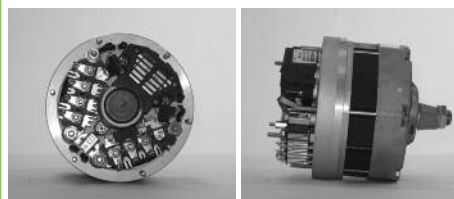

B+(M6)
D-(M5)

PLASTIC CAPSULE 26

590629

FRONT BEARING 21

592860

REAR BEARING 22

590613

SEP:SEPARATED REGULATOR -INC:BUILT-IN REGULATOR 02 **300871**

CONDENSOR 14

105604

RECTIFIER OR DIODE BRIDGE ASSEMBLY 07

300903

FRONT HOUSING 31

*599072

Valeo **432794/436599**

A14N69	90	2	1V
14	↻	0°	Ø 63,25

Picture not available
Image non disponible
Imagen no disponible
Immagine non disponibile
Nicht verfügbares Bild
Brak zdjęcia
Картина недоступна

Picture not available
Image non disponible
Imagen no disponible
Immagine non disponibile
Nicht verfügbares Bild
Brak zdjęcia
Картина недоступна

SEP:SEPARATED REGULATOR -INC:BUILT-IN REGULATOR 02
*2590558

Valeo **432786/436318**

A14N70

90 2 1V

14 ↻ 60° ∇ ∅ 63,25

Picture not available
Image non disponible
Imagen no disponible
Immagine non disponibile
Nicht verfügbares Bild
Brak zdjęcia
Картина недоступна

Picture not available
Image non disponible
Imagen no disponible
Immagine non disponibile
Nicht verfügbares Bild
Brak zdjęcia
Картина недоступна

SEP:SEPARATED REGULATOR -INC:BUILT-IN REGULATOR 📏02

*2590558

Valeo**432796****A14N71**

90 1 SP

14 ↻ 60° ∇ INC

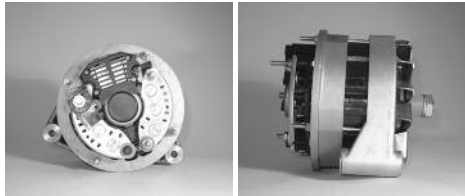
**B+(M8)D+(M5)****PLASTIC CAPSULE** 📏26

590629

FRONT BEARING 📏21

593224

REAR BEARING 📏22

590613

SEP:SEPARATED REGULATOR -INC:BUILT-IN REGULATOR 📏02300871**RECTIFIER OR DIODE BRIDGE ASSEMBLY** 📏07

105754

FAN 📏12

592703

STATOR 📏05

101868

Valeo**432797/436595****A14N73**

105 2 1V

14 ↻ 0° ∇ ∅ 71,5 INC

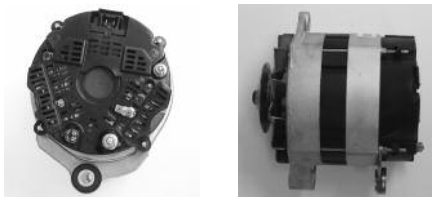
**PLASTIC CAPSULE** 📏26

590629

FRONT BEARING 📏21

592860

REAR BEARING 📏22

590613

PROTECTION COVER 📏24

590566

REAR BRACKET 📏25

593228

SEP:SEPARATED REGULATOR -INC:BUILT-IN REGULATOR 📏02590660**RECTIFIER OR DIODE BRIDGE ASSEMBLY** 📏07

300903

PULLEY 📏11

593209

STATOR 📏05

518688

Valeo**432798/436452****A14N74**

90 2 1V

14 ↻ 0° ∇ ∅ 66 INC

**PLASTIC CAPSULE** 📏26

590629

FRONT BEARING 📏21

593224

REAR BEARING 📏22

590613

PROTECTION COVER 📏24

590563

SEP:SEPARATED REGULATOR -INC:BUILT-IN REGULATOR 📏02

*2590558

FAN 📏12

592703

PULLEY 📏11

096879

ROTOR 📏04

300696

STATOR 📏05

101868

Valeo**436390****A14N75+**

105 2 1V

14 ↻ 0° ∇ ∅ 66 INC

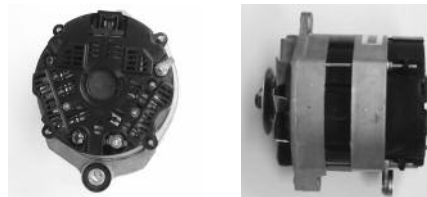
**FRONT BEARING** 📏21

592860

REAR BEARING 📏22

590613

PROTECTION COVER 📏24

590566

REAR BRACKET 📏25

593228

SEP:SEPARATED REGULATOR -INC:BUILT-IN REGULATOR 📏02590660**RECTIFIER OR DIODE BRIDGE ASSEMBLY** 📏07

300903

PULLEY 📏11

096879

STATOR 📏05

518688

Valeo**432799/433466****A14N76+**

105 2 5V

14 ↻ 60° ∇ ∅ 80,94 INC

**PLASTIC CAPSULE** 📏26

590629

REAR BEARING 📏22

590613

REAR BRACKET 📏25

593228

SEP:SEPARATED REGULATOR -INC:BUILT-IN REGULATOR 📏02590660**RECTIFIER OR DIODE BRIDGE ASSEMBLY** 📏07

300903

PULLEY 📏11

*105500

STATOR 📏05

518688

Valeo**432801/433458****A14N77**

90 1 1V

14 ↻ 60° ∇ ∅ 66

Picture not available
Image non disponible
Imagen no disponible
Immagine non disponibile
Nicht verfügbares Bild
Brak zdjęcia
Картина недоступна

Picture not available
Image non disponible
Imagen no disponible
Immagine non disponibile
Nicht verfügbares Bild
Brak zdjęcia
Картина недоступна

SEP:SEPARATED REGULATOR -INC:BUILT-IN REGULATOR 📏02

*2590558

Valeo**432802**

A14N81M

60

1

28



20°

Picture not available
Image non disponible
Imagen no disponible
Immagine non disponibile
Nicht verfügbares Bild
Brak zdjęć
Картина недоступна

Picture not available
Image non disponible
Imagen no disponible
Immagine non disponibile
Nicht verfügbares Bild
Brak zdjęć
Картина недоступна

PLASTIC CAPSULE 26

590629

FRONT BEARING 21

592780

REAR BEARING 22

590613

PROTECTION COVER 24

590563

BRUSH HOLDER 09

092967

SEP:SEPARATED REGULATOR -INC:BUILT-IN REGULATOR 02

590536

RECTIFIER OR DIODE BRIDGE ASSEMBLY 07

593199

ROTOR 04

592727

STATOR 05

101518

Valeo**592601****A14N82**

80

2

14



10°

Picture not available
Image non disponible
Imagen no disponible
Immagine non disponibile
Nicht verfügbares Bild
Brak zdjęć
Картина недоступна

Picture not available
Image non disponible
Imagen no disponible
Immagine non disponibile
Nicht verfügbares Bild
Brak zdjęć
Картина недоступна

PLASTIC CAPSULE 26

590629

FRONT BEARING 21

593224

REAR BEARING 22

590613

PROTECTION COVER 24

590563

SEP:SEPARATED REGULATOR -INC:BUILT-IN REGULATOR 02

182120

PULLEY 11

593253

Valeo**433114****A14N83**

80

2

1V

14



10°

Ø 59,7

Picture not available
Image non disponible
Imagen no disponible
Immagine non disponibile
Nicht verfügbares Bild
Brak zdjęć
Картина недоступна

Picture not available
Image non disponible
Imagen no disponible
Immagine non disponibile
Nicht verfügbares Bild
Brak zdjęć
Картина недоступна

SEP:SEPARATED REGULATOR -INC:BUILT-IN REGULATOR 02

*2590558

Valeo**432809****A14N84**

75

2

1V

14



0°

Ø 59,7

INC

**SEP:SEPARATED REGULATOR -INC:BUILT-IN REGULATOR** 02

*2590558

Valeo**432811/433371****A14N85**

75

2

6V

14



0°

Ø 71,16

Picture not available
Image non disponible
Imagen no disponible
Immagine non disponibile
Nicht verfügbares Bild
Brak zdjęć
Картина недоступна

Picture not available
Image non disponible
Imagen no disponible
Immagine non disponibile
Nicht verfügbares Bild
Brak zdjęć
Картина недоступна

SEP:SEPARATED REGULATOR -INC:BUILT-IN REGULATOR 02

*2590558

Valeo**432805****A14N86**

75

2

6V

14



60°

Ø 71,16

Picture not available
Image non disponible
Imagen no disponible
Immagine non disponibile
Nicht verfügbares Bild
Brak zdjęć
Картина недоступна

Picture not available
Image non disponible
Imagen no disponible
Immagine non disponibile
Nicht verfügbares Bild
Brak zdjęć
Картина недоступна

SEP:SEPARATED REGULATOR -INC:BUILT-IN REGULATOR 02

*2590558

Valeo**433072****A14N88**

80

1

1V

14



20°

Ø 60

INC

**FRONT BEARING** 21

593224

REAR BEARING 22

590613

PROTECTION COVER 24

590563

SEP:SEPARATED REGULATOR -INC:BUILT-IN REGULATOR 02

182120

PULLEY 11

593253

Valeo**432806/436320****A14N89**

75

2

6V

14



0°

Ø 62,9

Picture not available
Image non disponible
Imagen no disponible
Immagine non disponibile
Nicht verfügbares Bild
Brak zdjęć
Картина недоступна

Picture not available
Image non disponible
Imagen no disponible
Immagine non disponibile
Nicht verfügbares Bild
Brak zdjęć
Картина недоступна

SEP:SEPARATED REGULATOR -INC:BUILT-IN REGULATOR 02

*2590558

Valeo**432812**

A14N9

80 1 1V

14 ↻ INC



PLASTIC CAPSULE 📏 26 590629
REAR BEARING 📏 22 590613
PROTECTION COVER 📏 24 590563
BRUSH HOLDER 📏 09 092859
SEP:SEPARATED REGULATOR -INC:BUILT-IN REGULATOR 📏 02
 *2590558
RECTIFIER OR DIODE BRIDGE ASSEMBLY 📏 07 105135
PULLEY 📏 11 593253
HARDWARE OF PULLEY 📏 13 593225
STATOR 📏 05 101025
Valeo **432806/436320**

A14N91

80 2 1V

14 ↻ 55° ∇ Ø 66 INC

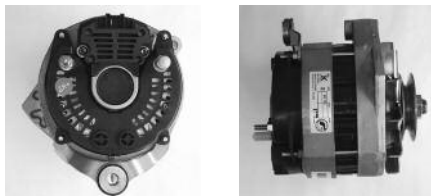

B+(M6),B-(M5),D+(M6)

SEP:SEPARATED REGULATOR -INC:BUILT-IN REGULATOR 📏 02 182120
RECTIFIER OR DIODE BRIDGE ASSEMBLY 📏 07 593180
FAN 📏 12 100809
PULLEY 📏 11 096879
ROTOR 📏 04 300696

A14N91

80 2 1V

14 ↻ 55° ∇ Ø 66 INC

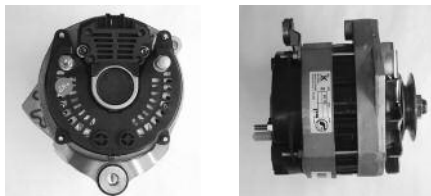

B+(M6),B-(M5),D+(M6)

SEP:SEPARATED REGULATOR -INC:BUILT-IN REGULATOR 📏 02 182120
RECTIFIER OR DIODE BRIDGE ASSEMBLY 📏 07 593180
FAN 📏 12 100809
PULLEY 📏 11 096879
ROTOR 📏 04 300696

A14N91

80 2 1V

14 ↻ 55° ∇ Ø 66 INC

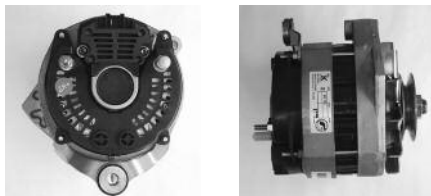

B+(M6),B-(M5),D+(M6)

SEP:SEPARATED REGULATOR -INC:BUILT-IN REGULATOR 📏 02 182120
RECTIFIER OR DIODE BRIDGE ASSEMBLY 📏 07 593180
FAN 📏 12 100809
PULLEY 📏 11 096879
ROTOR 📏 04 300696
Valeo **432808/436435**

A14N95+

105 2 6V

14 ↻ 60° ∇ Ø 62,09

Picture not available
 Image non disponible
 Imagen no disponible
 Immagine non disponibile
 Nicht verfügbares Bild
 Brak zdjęcia
 Картина недоступна

Picture not available
 Image non disponible
 Imagen no disponible
 Immagine non disponibile
 Nicht verfügbares Bild
 Brak zdjęcia
 Картина недоступна

PLASTIC CAPSULE 📏 26 590629
PROTECTION COVER 📏 24 590566
REAR BRACKET 📏 25 593228
SEP:SEPARATED REGULATOR -INC:BUILT-IN REGULATOR 📏 02 590660
RECTIFIER OR DIODE BRIDGE ASSEMBLY 📏 07 300903
PULLEY 📏 11 105760
STATOR 📏 05 518688
Valeo **432813**

A14N96

90 2 5V

14 ↻ 60° ∇ Ø 80,94 INC

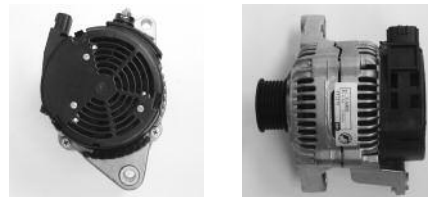

PLASTIC CAPSULE 📏 26 590629
FRONT BEARING 📏 21 593224
REAR BEARING 📏 22 590613
SEP:SEPARATED REGULATOR -INC:BUILT-IN REGULATOR 📏 02
 *2590558
RECTIFIER OR DIODE BRIDGE ASSEMBLY 📏 07 180593
PULLEY 📏 11 *105500
ROTOR 📏 04 300696
STATOR 📏 05 101868
Valeo **432814/433452**

A14N97

75 1 2V

14 ↻ 20° ∇ Ø 64,1 INC

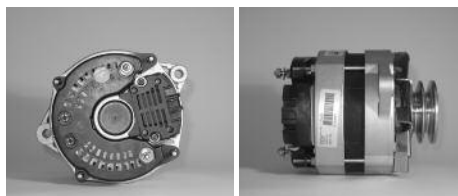

SEP:SEPARATED REGULATOR -INC:BUILT-IN REGULATOR 📏 02
 *2590558
Valeo **432815/436307**

A14N99

75 2 6V

14 ↻ 0° ∇ Ø 62,9

Picture not available
 Image non disponible
 Imagen no disponible
 Immagine non disponibile
 Nicht verfügbares Bild
 Brak zdjęcia
 Картина недоступна









Picture not available
 Image non disponible
 Imagen no disponible
 Immagine non disponibile
 Nicht verfügbares Bild
 Brak zdjęcia
 Картина недоступна

SEP:SEPARATED REGULATOR -INC:BUILT-IN REGULATOR 📏 02
 *2590558
Valeo **432812**

A14R39T 50 2 2V

28  ° Ø 65









Picture not available Image non disponible Imagen no disponible Immagine non disponibile Nicht verfügbares Bild Brak zdjęćia Картина недоступна	Picture not available Image non disponible Imagen no disponible Immagine non disponibile Nicht verfügbares Bild Brak zdjęćia Картина недоступна
---	---

FRONT BEARING  21 592860
REAR BEARING  22 590613
BRUSH HOLDER  09 300665
SEP:SEPARATED REGULATOR -INC:BUILT-IN REGULATOR  02 092953
PLASTIC CAPSULE  26 077973
BRUSH HOLDER  09 101164
ROTOR  04 092956
STATOR  05 097486
Valeo 439278

A14R541T 55 2

28 









Picture not available Image non disponible Imagen no disponible Immagine non disponibile Nicht verfügbares Bild Brak zdjęćia Картина недоступна	Picture not available Image non disponible Imagen no disponible Immagine non disponibile Nicht verfügbares Bild Brak zdjęćia Картина недоступна
---	---

RECTIFIER OR DIODE BRIDGE ASSEMBLY  07 103730
PLASTIC CAPSULE  26 077973
CONDENSOR  14 103744
RECTIFIER OR DIODE BRIDGE ASSEMBLY  07 103756
PULLEY  11 095392
ROTOR  04 092956
HARDWARE OF PULLEY  13 100518
STATOR  05 097486
Valeo 103164

A14R542T 55 2

28 







Picture not available Image non disponible Imagen no disponible Immagine non disponibile Nicht verfügbares Bild Brak zdjęćia Картина недоступна	Picture not available Image non disponible Imagen no disponible Immagine non disponibile Nicht verfügbares Bild Brak zdjęćia Картина недоступна
---	---

RECTIFIER OR DIODE BRIDGE ASSEMBLY  07 103730
SEP:SEPARATED REGULATOR -INC:BUILT-IN REGULATOR  02 092955
PLASTIC CAPSULE  26 077973
CONDENSOR  14 103744
RECTIFIER OR DIODE BRIDGE ASSEMBLY  07 103756
PULLEY  11 593253
ROTOR  04 092956
HARDWARE OF PULLEY  13 300761
STATOR  05 097486
Valeo 103484

A14R543T 55 2

28 





Picture not available Image non disponible Imagen no disponible Immagine non disponibile Nicht verfügbares Bild Brak zdjęćia Картина недоступна	Picture not available Image non disponible Imagen no disponible Immagine non disponibile Nicht verfügbares Bild Brak zdjęćia Картина недоступна
---	---

RECTIFIER OR DIODE BRIDGE ASSEMBLY  07 103730
PLASTIC CAPSULE  26 077973
CONDENSOR  14 103744
RECTIFIER OR DIODE BRIDGE ASSEMBLY  07 103756
ROTOR  04 092956
HARDWARE OF PULLEY  13 100518
STATOR  05 097486

A14R544T 55 2

28 







Picture not available Image non disponible Imagen no disponible Immagine non disponibile Nicht verfügbares Bild Brak zdjęćia Картина недоступна	Picture not available Image non disponible Imagen no disponible Immagine non disponibile Nicht verfügbares Bild Brak zdjęćia Картина недоступна
---	---

PLASTIC CAPSULE  26 077973
CONDENSOR  14 103744
RECTIFIER OR DIODE BRIDGE ASSEMBLY  07 103756
ROTOR  04 092956
STATOR  05 097486

A14R545T 55 2

28 







Picture not available Image non disponible Imagen no disponible Immagine non disponibile Nicht verfügbares Bild Brak zdjęćia Картина недоступна	Picture not available Image non disponible Imagen no disponible Immagine non disponibile Nicht verfügbares Bild Brak zdjęćia Картина недоступна
---	---

PLASTIC CAPSULE  26 077973
CONDENSOR  14 103744
RECTIFIER OR DIODE BRIDGE ASSEMBLY  07 103756
ROTOR  04 092956
HARDWARE OF PULLEY  13 101591
STATOR  05 097486

A14R54T 55 2

28 

Picture not available Image non disponible Imagen no disponible Immagine non disponibile Nicht verfügbares Bild Brak zdjęćia Картина недоступна	Picture not available Image non disponible Imagen no disponible Immagine non disponibile Nicht verfügbares Bild Brak zdjęćia Картина недоступна
---	---

RECTIFIER OR DIODE BRIDGE ASSEMBLY  07 103730
PLASTIC CAPSULE  26 077973
CONDENSOR  14 103744
RECTIFIER OR DIODE BRIDGE ASSEMBLY  07 103756
ROTOR  04 092956
HARDWARE OF PULLEY  13 101591
STATOR  05 097486
Valeo 103163



A14S054

150 2 5V

14 ↻ 48° ∇ Ø 54,8 INC

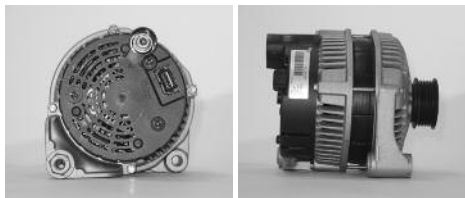

FRONT BEARING 21 593563
 REAR BEARING 22 593564
 PROTECTION COVER 24 593841
 SEP:SEPARATED REGULATOR -INC:BUILT-IN REGULATOR 02 593839
 RECTIFIER OR DIODE BRIDGE ASSEMBLY 07 593840
 FRONT HOUSING 31 593844
 PULLEY 11 593728
 ROTOR 04 593285
 STATOR 05 593588

Valeo

439252/437160

A14S055

150 2 5V

14 ↻ 34° ∇ Ø 54,8 INC

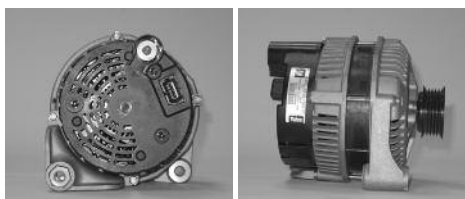

FRONT BEARING 21 593563
 REAR BEARING 22 593564
 PROTECTION COVER 24 593841
 SEP:SEPARATED REGULATOR -INC:BUILT-IN REGULATOR 02 593839
 RECTIFIER OR DIODE BRIDGE ASSEMBLY 07 593840
 FRONT HOUSING 31 593844
 PULLEY 11 593728
 ROTOR 04 593285
 STATOR 05 593588

Valeo

439446/437406

A14V01

95 1 1V

14 ↻ 60° ∇ Ø 66 INC

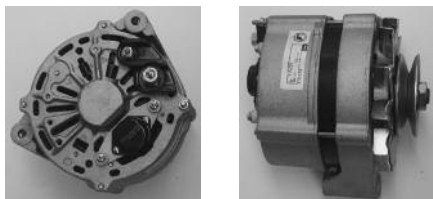

B+(M8)D+(M5)

FRONT BEARING 21 593224
 REAR BEARING 22 590613
 SEP:SEPARATED REGULATOR -INC:BUILT-IN REGULATOR 02 592781
 RECTIFIER OR DIODE BRIDGE ASSEMBLY 07 592700
 FAN 12 592703
 STATOR 05 592699

A14V01

95 1 1V

14 ↻ 60° ∇ Ø 66 INC

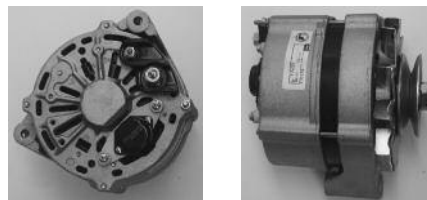

B+(M8)D+(M5)

FRONT BEARING 21 593224
 REAR BEARING 22 590613
 SEP:SEPARATED REGULATOR -INC:BUILT-IN REGULATOR 02 592781
 RECTIFIER OR DIODE BRIDGE ASSEMBLY 07 592700
 FAN 12 592703
 STATOR 05 592699

Valeo

433134/436134

A14V02

105 1 1V

14 ↻ 60° ∇ Ø 66 INC



B+(M8)D+(M5)

SEP:SEPARATED REGULATOR -INC:BUILT-IN REGULATOR 02 592781
 RECTIFIER OR DIODE BRIDGE ASSEMBLY 07 592700
 FAN 12 592703
 STATOR 05 592699

A14V02

105 1 1V

14 ↻ 60° ∇ Ø 66 INC

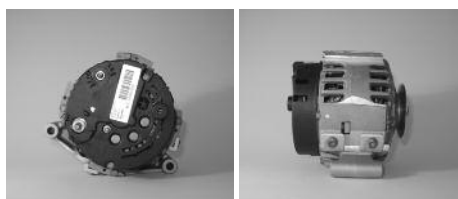

B+(M8)D+(M5)

SEP:SEPARATED REGULATOR -INC:BUILT-IN REGULATOR 02 592781
 RECTIFIER OR DIODE BRIDGE ASSEMBLY 07 592700
 FAN 12 592703
 STATOR 05 592699

Valeo

433134/436134

A14V03

95 1 1V

14 ↻ 60° ∇ Ø 70



Picture not available
 Image non disponible
 Imagen no disponible
 Immagine non disponibile
 Nicht verfügbares Bild
 Brak zdjęcia
 Картина недоступна

Picture not available
 Image non disponible
 Imagen no disponible
 Immagine non disponibile
 Nicht verfügbares Bild
 Brak zdjęcia
 Картина недоступна

FRONT BEARING 21 593224
 REAR BEARING 22 590613
 CONDENSOR 14 592674
 SEP:SEPARATED REGULATOR -INC:BUILT-IN REGULATOR 02 592781
 RECTIFIER OR DIODE BRIDGE ASSEMBLY 07 592700
 FAN 12 592703
 STATOR 05 592699

Valeo

433136/436132

A14V04

95

2

1V

14



60°

Ø 68

INC

**B+(M8)D+(M6)****FRONT BEARING** 21

593224

REAR BEARING 22

590613

SEP:SEPARATED REGULATOR -INC:BUILT-IN REGULATOR 02592781**RECTIFIER OR DIODE BRIDGE ASSEMBLY** 07

592835

STATOR 05

592699

Valeo**433191/436398****A14V05**

90

1

1V

14



60°

Ø 66

INC

**B+(M8)D+(M5)****FRONT BEARING** 21

593224

REAR BEARING 22

590613

SEP:SEPARATED REGULATOR -INC:BUILT-IN REGULATOR 02592781**RECTIFIER OR DIODE BRIDGE ASSEMBLY** 07

592700

FAN 12

592703

Valeo**433134/436134****A14V07**

105

2

6V

14



85°

Ø 56,8

Picture not available
Image non disponible
Imagen no disponible
Immagine non disponibile
Nicht verfügbares Bild
Brak zdjęcia
Картина недоступна

Picture not available
Image non disponible
Imagen no disponible
Immagine non disponibile
Nicht verfügbares Bild
Brak zdjęcia
Картина недоступна

SEP:SEPARATED REGULATOR -INC:BUILT-IN REGULATOR 02592952**RECTIFIER OR DIODE BRIDGE ASSEMBLY** 07

592956

FAN 12

592955

Valeo**433192/436404****A14V08**

90

2

6V

14



85°

Ø 56,8

Picture not available
Image non disponible
Imagen no disponible
Immagine non disponibile
Nicht verfügbares Bild
Brak zdjęcia
Картина недоступна

Picture not available
Image non disponible
Imagen no disponible
Immagine non disponibile
Nicht verfügbares Bild
Brak zdjęcia
Картина недоступна

SEP:SEPARATED REGULATOR -INC:BUILT-IN REGULATOR 02592952**RECTIFIER OR DIODE BRIDGE ASSEMBLY** 07

592956

FAN 12

592955

Valeo**433193/436405****A14V09**

140

2

6V

14



85°

Ø 56,8

Picture not available
Image non disponible
Imagen no disponible
Immagine non disponibile
Nicht verfügbares Bild
Brak zdjęcia
Картина недоступна

Picture not available
Image non disponible
Imagen no disponible
Immagine non disponibile
Nicht verfügbares Bild
Brak zdjęcia
Картина недоступна

SEP:SEPARATED REGULATOR -INC:BUILT-IN REGULATOR 02592952**RECTIFIER OR DIODE BRIDGE ASSEMBLY** 07

592959

FAN 12

592955

Valeo**433194****A14V10**

105

2

6V

14



85°

Ø 56,8

Picture not available
Image non disponible
Imagen no disponible
Immagine non disponibile
Nicht verfügbares Bild
Brak zdjęcia
Картина недоступна

Picture not available
Image non disponible
Imagen no disponible
Immagine non disponibile
Nicht verfügbares Bild
Brak zdjęcia
Картина недоступна

SEP:SEPARATED REGULATOR -INC:BUILT-IN REGULATOR 02592952**RECTIFIER OR DIODE BRIDGE ASSEMBLY** 07

592956

FAN 12

592955

Valeo**433195****A14V11**

90

2

6V

14



85°

Ø 56,8

Picture not available
Image non disponible
Imagen no disponible
Immagine non disponibile
Nicht verfügbares Bild
Brak zdjęcia
Картина недоступна

Picture not available
Image non disponible
Imagen no disponible
Immagine non disponibile
Nicht verfügbares Bild
Brak zdjęcia
Картина недоступна

SEP:SEPARATED REGULATOR -INC:BUILT-IN REGULATOR 02592952**RECTIFIER OR DIODE BRIDGE ASSEMBLY** 07

592956

FAN 12

592955

Valeo**433196****A14V12**

140

2

6V

14



85°

Ø 56,8

Picture not available
Image non disponible
Imagen no disponible
Immagine non disponibile
Nicht verfügbares Bild
Brak zdjęcia
Картина недоступна

Picture not available
Image non disponible
Imagen no disponible
Immagine non disponibile
Nicht verfügbares Bild
Brak zdjęcia
Картина недоступна

SEP:SEPARATED REGULATOR -INC:BUILT-IN REGULATOR 02592952**RECTIFIER OR DIODE BRIDGE ASSEMBLY** 07

592959

FAN 12

592955

Valeo**433197**

A14V13

105 2 1V

14 ↻ 60° ∇ Ø 68 INC

**B+(M8)D+(M6)**

SEP:SEPARATED REGULATOR -INC:BUILT-IN REGULATOR 📏 02592781
 RECTIFIER OR DIODE BRIDGE ASSEMBLY 📏 07 592835
 PROTECTION COVER 📏 24 *519762
 STATOR 📏 05 592699
Valeo 433179/436330

A14V14

90 2 6V

14 ↻ 85° ∇ Ø 56,8 INC

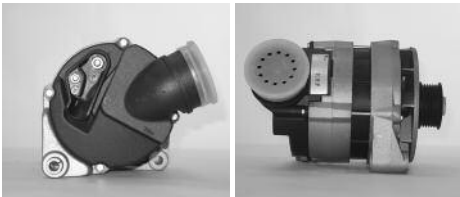
**B+(M8)D+(M5)**

SEP:SEPARATED REGULATOR -INC:BUILT-IN REGULATOR 📏 02592952
 RECTIFIER OR DIODE BRIDGE ASSEMBLY 📏 07 592956
 FAN 📏 12 592955
Valeo 433182/436410

A14V15

105 2 6V

14 ↻ 85° ∇ Ø 56,8 INC

**B+(M8)D+(M6)**

SEP:SEPARATED REGULATOR -INC:BUILT-IN REGULATOR 📏 02592952
 RECTIFIER OR DIODE BRIDGE ASSEMBLY 📏 07 592956
 FAN 📏 12 592955
Valeo 433183/436411

A14V16

140 2 6V

14 ↻ 85° ∇ Ø 56,8 INC

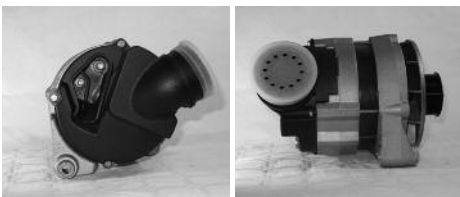
**B+(M8)D+(M6)**

SEP:SEPARATED REGULATOR -INC:BUILT-IN REGULATOR 📏 02592963
 RECTIFIER OR DIODE BRIDGE ASSEMBLY 📏 07 592959
 FAN 📏 12 592955
Valeo 433180/436331

A14V17

90 2 6V

14 ↻ Ø 56,8 INC

**B+(M8)D+(M6)**

SEP:SEPARATED REGULATOR -INC:BUILT-IN REGULATOR 📏 02592952
 RECTIFIER OR DIODE BRIDGE ASSEMBLY 📏 07 592956
 FAN 📏 12 592955
Valeo 433182/436333

A14V18

105 2 6V

14 ↻ 90° ∇ Ø 56,8 INC

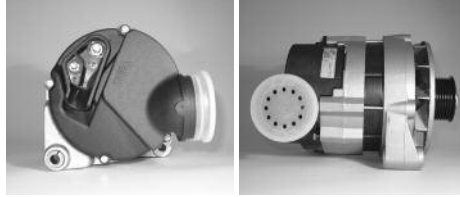
**B+(M8)D+(M6)**

SEP:SEPARATED REGULATOR -INC:BUILT-IN REGULATOR 📏 02592952
 RECTIFIER OR DIODE BRIDGE ASSEMBLY 📏 07 592956
 FAN 📏 12 592955
Valeo 433183/436334

A14V19

140 2 6V

14 ↻ 95° ∇ Ø 56,8 INC

**B+(M8)D+(M6)**

SEP:SEPARATED REGULATOR -INC:BUILT-IN REGULATOR 📏 02592963
 RECTIFIER OR DIODE BRIDGE ASSEMBLY 📏 07 592959
 FAN 📏 12 592955
Valeo 433181/436332

A14V20

80 2 SP

28 ↻ 85° ∇



FAN 📏 12 592703
Valeo 436396

A14VI10

120

2

6V

14



20°

Ø 59,4

INC

**B+(M8)D+(M5)**

FRONT BEARING	21	593674
REAR BEARING	22	593564
PROTECTION COVER	24	593247
SEP:SEPARATED REGULATOR -INC:BUILT-IN REGULATOR	02	593350
CONDENSOR	14	592853
RECTIFIER OR DIODE BRIDGE ASSEMBLY	07	593202
PULLEY	11	593758
REPAIRE KIT	29	593282
ROTOR	04	593285
STATOR	05	593159

Valeo**439024/436477****A14VI11**

120

2

6V

14



20°

Ø 59,4

INC

**B+(M8)D+(M5)**

FRONT BEARING	21	593674
REAR BEARING	22	593564
SEP:SEPARATED REGULATOR -INC:BUILT-IN REGULATOR	02	593350
CONDENSOR	14	592853
RECTIFIER OR DIODE BRIDGE ASSEMBLY	07	593202
PULLEY	11	593758
REPAIRE KIT	29	593282
ROTOR	04	593285
STATOR	05	593159

Valeo**439055/436612****A14VI13**

120

1

6V

14



60°

Ø 66

INC

**B+(M8)D+(M5)**

FRONT BEARING	21	593674
REAR BEARING	22	593564
PROTECTION COVER	24	593247
SEP:SEPARATED REGULATOR -INC:BUILT-IN REGULATOR	02	593350
CONDENSOR	14	592853
RECTIFIER OR DIODE BRIDGE ASSEMBLY	07	593202
PULLEY	11	593759
REPAIRE KIT	29	593282
ROTOR	04	593285
STATOR	05	593159

Valeo**439025/436478****A14VI14**

120

1

6V

14



60°

Ø 59,8

INC

**B+(M8)D+(M5)**

FRONT BEARING	21	593674
REAR BEARING	22	593564
PROTECTION COVER	24	593247
SEP:SEPARATED REGULATOR -INC:BUILT-IN REGULATOR	02	593350
CONDENSOR	14	592853
RECTIFIER OR DIODE BRIDGE ASSEMBLY	07	593202
REPAIRE KIT	29	593282
ROTOR	04	593285
STATOR	05	593159

Valeo**439072/436643****A14VI15+**

150

1

6V

14



60°

Ø 63

INC

**B+(M8)D+(M5)**

FRONT BEARING	21	593674
REAR BEARING	22	593564
PROTECTION COVER	24	593289
SEP:SEPARATED REGULATOR -INC:BUILT-IN REGULATOR	02	593284
CONDENSOR	14	593288
RECTIFIER OR DIODE BRIDGE ASSEMBLY	07	593287
PULLEY	11	593748
REPAIRE KIT	29	593282
ROTOR	04	593285
STATOR	05	593286

Valeo**439104/436670****A14VI16+**

150

1

6V

14



60°

Ø 66

INC

**B+(M8)D+(M5)**

FRONT BEARING	21	593674
REAR BEARING	22	593564
PROTECTION COVER	24	593289
SEP:SEPARATED REGULATOR -INC:BUILT-IN REGULATOR	02	593284
CONDENSOR	14	593288
RECTIFIER OR DIODE BRIDGE ASSEMBLY	07	593287
PULLEY	11	593759
REPAIRE KIT	29	593282
ROTOR	04	593285
STATOR	05	593286

Valeo**439105/436671**

A14VI21

110 1 6V

14 ↻ 60° ∇ Ø 67,99

Picture not available
Image non disponible
Imagem no disponible
Immagine non disponibile
Nicht verfügbares Bild
Brak zdjęcia
Картина недоступна

Picture not available
Image non disponible
Imagem no disponible
Immagine non disponibile
Nicht verfügbares Bild
Brak zdjęcia
Картина недоступна

FRONT BEARING 🛠️ 21	593563
REAR BEARING 🛠️ 22	593564
PROTECTION COVER 🛠️ 24	593452
SEP:SEPARATED REGULATOR -INC:BUILT-IN REGULATOR 🛠️ 02	593342
RECTIFIER OR DIODE BRIDGE ASSEMBLY 🛠️ 07	593449
PULLEY 🛠️ 11	593717
REPAIRE KIT 🛠️ 29	593453
ROTOR 🛠️ 04	593285
STATOR 🛠️ 05	593159

Valeo**439217****A14VI22**

120 2 6V

14 ↻ 35° ∇ Ø 51 INC

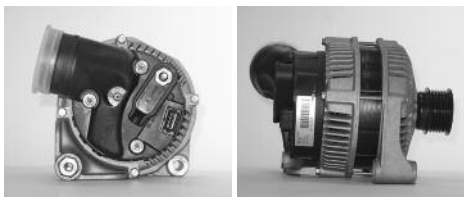

FRONT BEARING 🛠️ 21	593674
REAR BEARING 🛠️ 22	593564
SEP:SEPARATED REGULATOR -INC:BUILT-IN REGULATOR 🛠️ 02	593347
RECTIFIER OR DIODE BRIDGE ASSEMBLY 🛠️ 07	593348
PULLEY 🛠️ 11	593726
REPAIRE KIT 🛠️ 29	593282
ROTOR 🛠️ 04	593285
STATOR 🛠️ 05	593159

Valeo**439234/437115****A14VI23**

150 2 6V

14 ↻ 60° ∇ Ø 50 INC



FRONT BEARING 🛠️ 21	593674
REAR BEARING 🛠️ 22	593564
PROTECTION COVER 🛠️ 24	593346
SEP:SEPARATED REGULATOR -INC:BUILT-IN REGULATOR 🛠️ 02	593342
RECTIFIER OR DIODE BRIDGE ASSEMBLY 🛠️ 07	593345
PULLEY 🛠️ 11	593729
REPAIRE KIT 🛠️ 29	593282
ROTOR 🛠️ 04	593285
STATOR 🛠️ 05	593286

Valeo**439229/436753****A14VI26**

120 2 5V

14 ↻ Ø 54,8

Picture not available
Image non disponible
Imagem no disponible
Immagine non disponibile
Nicht verfügbares Bild
Brak zdjęcia
Картина недоступна

Picture not available
Image non disponible
Imagem no disponible
Immagine non disponibile
Nicht verfügbares Bild
Brak zdjęcia
Картина недоступна

FRONT BEARING 🛠️ 21	593674
REAR BEARING 🛠️ 22	593564
PROTECTION COVER 🛠️ 24	593352
SEP:SEPARATED REGULATOR -INC:BUILT-IN REGULATOR 🛠️ 02	593347
RECTIFIER OR DIODE BRIDGE ASSEMBLY 🛠️ 07	593348
PULLEY 🛠️ 11	593728
REPAIRE KIT 🛠️ 29	593282
ROTOR 🛠️ 04	593285
STATOR 🛠️ 05	593159

A14VI27+

150 4 6V

14 ↻ 40° ∇ Ø 57,5 INC

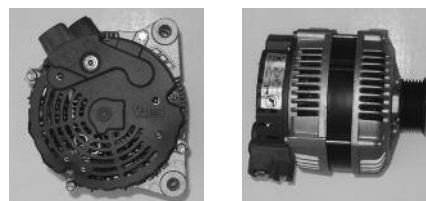
**B+(M8)
L(M5)**

FRONT BEARING 🛠️ 21	593674
REAR BEARING 🛠️ 22	593564
PROTECTION COVER 🛠️ 24	593289
SEP:SEPARATED REGULATOR -INC:BUILT-IN REGULATOR 🛠️ 02	593284
CONDENSOR 🛠️ 14	593288
RECTIFIER OR DIODE BRIDGE ASSEMBLY 🛠️ 07	593499
PULLEY 🛠️ 11	593762
REPAIRE KIT 🛠️ 29	593282
ROTOR 🛠️ 04	593285
STATOR 🛠️ 05	593286

Valeo**439257/437171****A14VI28**

120 2 5V

14 ↻ 35° ∇ Ø 54,8 INC

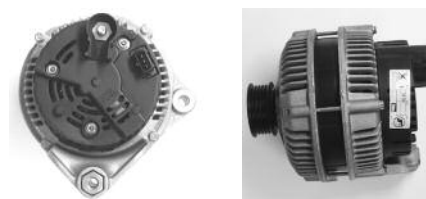

FRONT BEARING 🛠️ 21	593674
REAR BEARING 🛠️ 22	593564
PROTECTION COVER 🛠️ 24	593352
SEP:SEPARATED REGULATOR -INC:BUILT-IN REGULATOR 🛠️ 02	593347
PULLEY 🛠️ 11	593728
REPAIRE KIT 🛠️ 29	593282
ROTOR 🛠️ 04	593285
STATOR 🛠️ 05	593159

Valeo**439235/437116**

A14VI29+

150

2

5V

14



Ø 54,8

INC

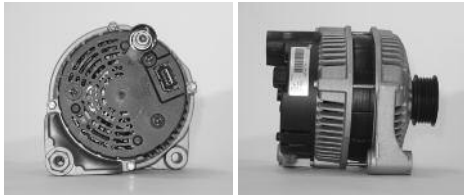

FRONT BEARING	👉21	593674
REAR BEARING	👉22	593564
PROTECTION COVER	👉24	593361
SEP:SEPARATED REGULATOR -INC:BUILT-IN REGULATOR	👉02	593347
RECTIFIER OR DIODE BRIDGE ASSEMBLY	👉07	593502
PULLEY	👉11	593728
REPAIRE KIT	👉29	593282
ROTOR	👉04	593285
STATOR	👉05	593286

Valeo**439252/437160****A14VI30**

120

2

6V

14



20°

Ø 59,4

INC

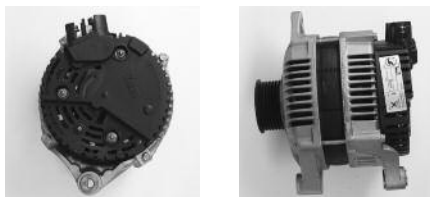
**B+(M8)D+(M5)**

FRONT BEARING	👉21	593674
REAR BEARING	👉22	593564
PROTECTION COVER	👉24	593247
SEP:SEPARATED REGULATOR -INC:BUILT-IN REGULATOR	👉02	593350
CONDENSOR	👉14	592853
RECTIFIER OR DIODE BRIDGE ASSEMBLY	👉07	593202
PULLEY	👉11	593731
REPAIRE KIT	👉29	593282
ROTOR	👉04	593285
STATOR	👉05	593159

Valeo**439024/436477****A14VI31**

120

2

6V

14



20°

Ø 66

INC

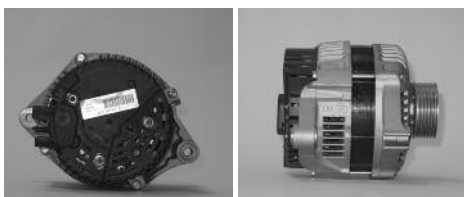
**B+(M8)D+(M5)**

FRONT BEARING	👉21	593674
REAR BEARING	👉22	593564
PROTECTION COVER	👉24	593247
SEP:SEPARATED REGULATOR -INC:BUILT-IN REGULATOR	👉02	593350
CONDENSOR	👉14	592853
RECTIFIER OR DIODE BRIDGE ASSEMBLY	👉07	593202
PULLEY	👉11	593759
REPAIRE KIT	👉29	593282
ROTOR	👉04	593285
STATOR	👉05	593159

Valeo**439253/437164****A14VI34**

150

2

5V

14



Ø 54,8

INC

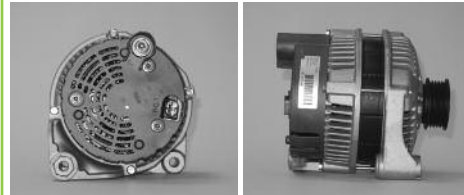

FRONT BEARING	👉21	593674
REAR BEARING	👉22	593564
PROTECTION COVER	👉24	593407
SEP:SEPARATED REGULATOR -INC:BUILT-IN REGULATOR	👉02	593406
RECTIFIER OR DIODE BRIDGE ASSEMBLY	👉07	593345
PULLEY	👉11	593728
REPAIRE KIT	👉29	593282
ROTOR	👉04	593285
STATOR	👉05	593286

Valeo**439305/437309****A14VI35**

150

4

6V

14



40°

Ø 57,5

INC

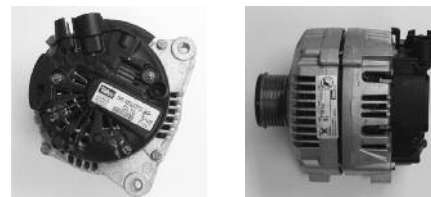
**B+(M8)D+(M5)**

FRONT BEARING	👉21	593674
REAR BEARING	👉22	593564
PROTECTION COVER	👉24	593289
SEP:SEPARATED REGULATOR -INC:BUILT-IN REGULATOR	👉02	593284
CONDENSOR	👉14	593288
RECTIFIER OR DIODE BRIDGE ASSEMBLY	👉07	593499
PULLEY FREE WHEEL + CAP PROTECTION	👉11c	593521
REPAIRE KIT	👉29	593282
ROTOR	👉04	593285
STATOR	👉05	593286

Valeo**439294/437210****A14VI36**

150

2

6V

14



60°

Ø 66

Picture not available
Image non disponible
Imagen no disponible
Immagine non disponibile
Nicht verfügbares Bild
Brak zdjęcia
Картина недоступна

Picture not available
Image non disponible
Imagen no disponible
Immagine non disponibile
Nicht verfügbares Bild
Brak zdjęcia
Картина недоступна

FRONT BEARING	👉21	593674
REAR BEARING	👉22	593564
PROTECTION COVER	👉24	593462
SEP:SEPARATED REGULATOR -INC:BUILT-IN REGULATOR	👉02	593362
RECTIFIER OR DIODE BRIDGE ASSEMBLY	👉07	593460
PULLEY	👉11	593767
REPAIRE KIT	👉29	593282
ROTOR	👉04	593798
STATOR	👉05	593286

Valeo**439396/437365**

A14VI37

120 2 6V

14 ↻ ∅ 61 INC

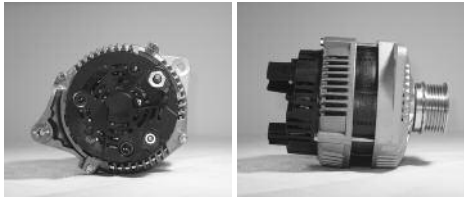
**B+(M8)D+(M5)**

FRONT BEARING	↗ 21	593674
REAR BEARING	↗ 22	593564
PROTECTION COVER	↗ 24	593405
SEP:SEPARATED REGULATOR -INC:BUILT-IN REGULATOR	↗ 02	593138
RECTIFIER OR DIODE BRIDGE ASSEMBLY	↗ 07	593404
PULLEY	↗ 11	593736
REPAIRE KIT	↗ 29	593282
ROTOR	↗ 04	593285
STATOR	↗ 05	593159

Valeo**439303/437307****A14VI39**

110 1 6V

14 ↻ 60° ∅ 68

Picture not available
Image non disponible
Imagen no disponible
Imagine non disponible
Nicht verfügbares Bild
Brak zdjęcia
Картина недоступна

Picture not available
Image non disponible
Imagen no disponible
Imagine non disponible
Nicht verfügbares Bild
Brak zdjęcia
Картина недоступна

FRONT BEARING	↗ 21	593563
REAR BEARING	↗ 22	593564
PROTECTION COVER	↗ 24	593452
SEP:SEPARATED REGULATOR -INC:BUILT-IN REGULATOR	↗ 02	593342
RECTIFIER OR DIODE BRIDGE ASSEMBLY	↗ 07	593449
REPAIRE KIT	↗ 29	593453
ROTOR	↗ 04	593285
STATOR	↗ 05	593159

Valeo**439387****A14VI41**

150 4 6V

14 ↻ 40° ∅ 57,5 INC

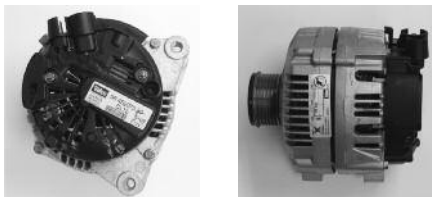
**B+(M8)D+(M5)**

FRONT BEARING	↗ 21	593674
REAR BEARING	↗ 22	593564
PROTECTION COVER	↗ 24	593289
SEP:SEPARATED REGULATOR -INC:BUILT-IN REGULATOR	↗ 02	593284
CONDENSOR	↗ 14	593288
RECTIFIER OR DIODE BRIDGE ASSEMBLY	↗ 07	593499
PULLEY FREE WHEEL + CAP PROTECTION	↗ 11c	593907
REPAIRE KIT	↗ 29	593282
ROTOR	↗ 04	593285
STATOR	↗ 05	593286

Valeo**439294/437210****A14VI42**

150 4 6V

14 ↻ 40° ∅ 57,5 INC

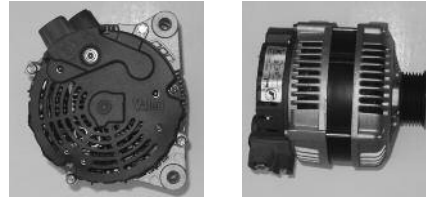
**B+(M8)
L(M5)**

FRONT BEARING	↗ 21	593674
REAR BEARING	↗ 22	593564
PROTECTION COVER	↗ 24	593289
SEP:SEPARATED REGULATOR -INC:BUILT-IN REGULATOR	↗ 02	593284
CONDENSOR	↗ 14	593288
RECTIFIER OR DIODE BRIDGE ASSEMBLY	↗ 07	593499
PULLEY	↗ 11	593620
REPAIRE KIT	↗ 29	593282
ROTOR	↗ 04	593285
STATOR	↗ 05	593286

Valeo**439257/437171****A14VI45**

150 2 6V

14 ↻ 34° ∅ 61 INC

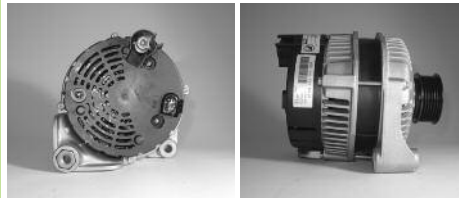

FRONT BEARING	↗ 21	593674
REAR BEARING	↗ 22	593564
PROTECTION COVER	↗ 24	593407
SEP:SEPARATED REGULATOR -INC:BUILT-IN REGULATOR	↗ 02	593406
RECTIFIER OR DIODE BRIDGE ASSEMBLY	↗ 07	593502
PULLEY	↗ 11	593770
REPAIRE KIT	↗ 29	593282
ROTOR	↗ 04	593285
STATOR	↗ 05	593286

Valeo**439450/437410****A14VI46**

150 2 5V

14 ↻ ∅ 54,8 INC

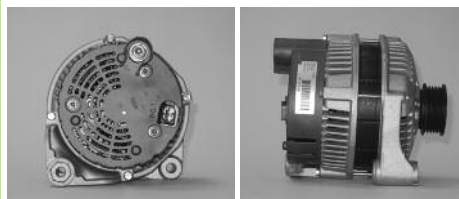

FRONT BEARING	↗ 21	593674
REAR BEARING	↗ 22	593564
PROTECTION COVER	↗ 24	593407
SEP:SEPARATED REGULATOR -INC:BUILT-IN REGULATOR	↗ 02	593406
RECTIFIER OR DIODE BRIDGE ASSEMBLY	↗ 07	593502
PULLEY	↗ 11	593728
REPAIRE KIT	↗ 29	593282
ROTOR	↗ 04	593285
STATOR	↗ 05	593286

Valeo**439305/437309**

A14VI47

150

2

5V

14



34°

Ø 54,8

INC

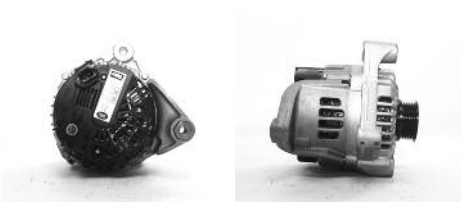

FRONT BEARING 21 593674
 REAR BEARING 22 593564
 PROTECTION COVER 24 593407
 SEP:SEPARATED REGULATOR -INC:BUILT-IN REGULATOR 02 593406
 RECTIFIER OR DIODE BRIDGE ASSEMBLY 07 593345
 PULLEY 11 593728
 REPAIRE KIT 29 593282
 ROTOR 04 593285
 STATOR 05 593286

Valeo**439459/437417****A14VI48**

150

4

6V

14



40°

Ø 57,5

INC

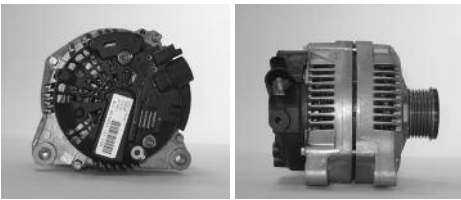

FRONT BEARING 21 593563
 REAR BEARING 22 593564
 CONDENSOR 14 593501
 RECTIFIER OR DIODE BRIDGE ASSEMBLY 07 593499
 PULLEY FREE WEEL + CAP PROTECTION 11c 593907
 REPAIRE KIT 29 593282
 ROTOR 04 593285
 STATOR 05 593286

Valeo**439493/437458****A14VI49**

150

4

6V

14



40°

Ø 57,5

INC

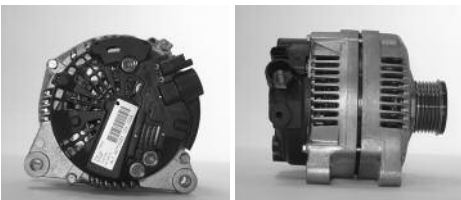

FRONT BEARING 21 593674
 REAR BEARING 22 593564
 SEP:SEPARATED REGULATOR -INC:BUILT-IN REGULATOR 02 593498
 CONDENSOR 14 593501
 RECTIFIER OR DIODE BRIDGE ASSEMBLY 07 593499
 PULLEY FREE WEEL + CAP PROTECTION 11c 593907
 REPAIRE KIT 29 593282
 ROTOR 04 593285
 STATOR 05 593286

Valeo**439447/437407****A14VI52**

150

2

5V

14



34°

Ø 54,8

INC

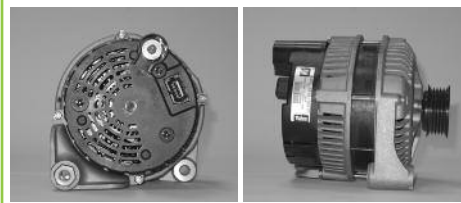

FRONT BEARING 21 593674
 REAR BEARING 22 593564
 PROTECTION COVER 24 593361
 SEP:SEPARATED REGULATOR -INC:BUILT-IN REGULATOR 02 593347
 RECTIFIER OR DIODE BRIDGE ASSEMBLY 07 593345
 PULLEY 11 593728
 REPAIRE KIT 29 593282
 ROTOR 04 593285
 STATOR 05 593286

Valeo**439446/437406****A14VI53**

150

2

5V

14



34°

Ø 54,8

INC

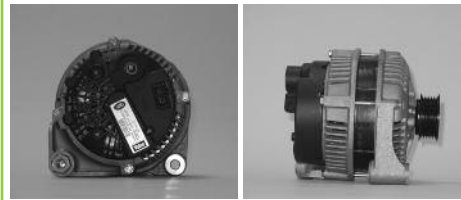

FRONT BEARING 21 593674
 REAR BEARING 22 593564
 PROTECTION COVER 24 593361
 SEP:SEPARATED REGULATOR -INC:BUILT-IN REGULATOR 02 593347
 RECTIFIER OR DIODE BRIDGE ASSEMBLY 07 593345
 PULLEY 11 593728
 REPAIRE KIT 29 593282
 ROTOR 04 593285
 STATOR 05 593286

Valeo**439463/437421****A16R106**

55

1V

28



Picture not available
 Image non disponible
 Imagen no disponible
 Immagine non disponibile
 Nicht verfügbares Bild
 Brak zdjęcia
 Картина недоступна

Picture not available
 Image non disponible
 Imagen no disponible
 Immagine non disponibile
 Nicht verfügbares Bild
 Brak zdjęcia
 Картина недоступна

HARDWARE FOR FRONT BEARING 16 079811
 BRUSH HOLDER 09 *096302
 A+ TERMINAL 17 590040
 RECTIFIER OR DIODE BRIDGE ASSEMBLY 07 076847
 SEP:SEPARATED REGULATOR -INC:BUILT-IN REGULATOR 02 *098047
 HARDWARE OF PULLEY 13 070921

Valeo**093528**

A16R120

55

28



Picture not available
Image non disponible
Imagen no disponible
Immagine non disponibile
Nicht verfügbares Bild
Brak zdjęcia
Картина недоступна

Picture not available
Image non disponible
Imagen no disponible
Immagine non disponibile
Nicht verfügbares Bild
Brak zdjęcia
Картина недоступна

AUXILIARY DIODE 08 097060
HARDWARE FOR FRONT BEARING 16 079811
BRUSH HOLDER 09 *096302
A+ TERMINAL 17 590040
RECTIFIER OR DIODE BRIDGE ASSEMBLY 07 076847
SEP:SEPARATED REGULATOR -INC:BUILT-IN REGULATOR 02*098047
HARDWARE OF PULLEY 13 070921

Valeo**093245/436358****A16R150**

55

28



Picture not available
Image non disponible
Imagen no disponible
Immagine non disponibile
Nicht verfügbares Bild
Brak zdjęcia
Картина недоступна

Picture not available
Image non disponible
Imagen no disponible
Immagine non disponibile
Nicht verfügbares Bild
Brak zdjęcia
Картина недоступна

AUXILIARY DIODE 08 097060
HARDWARE FOR FRONT BEARING 16 079811
BRUSH HOLDER 09 *096302
A+ TERMINAL 17 590040
RECTIFIER OR DIODE BRIDGE ASSEMBLY 07 076847
SEP:SEPARATED REGULATOR -INC:BUILT-IN REGULATOR 02*098047
HARDWARE OF PULLEY 13 070921

Valeo**096834****A16R160**

55

28



Picture not available
Image non disponible
Imagen no disponible
Immagine non disponibile
Nicht verfügbares Bild
Brak zdjęcia
Картина недоступна

Picture not available
Image non disponible
Imagen no disponible
Immagine non disponibile
Nicht verfügbares Bild
Brak zdjęcia
Картина недоступна

HARDWARE FOR FRONT BEARING 16 079811
BRUSH HOLDER 09 092746
A+ TERMINAL 17 590040
RECTIFIER OR DIODE BRIDGE ASSEMBLY 07 076847
SEP:SEPARATED REGULATOR -INC:BUILT-IN REGULATOR 02*098047
HARDWARE OF PULLEY 13 070921

Valeo**093182****A16R161**

50

2V

28



Ø 89

Picture not available
Image non disponible
Imagen no disponible
Immagine non disponibile
Nicht verfügbares Bild
Brak zdjęcia
Картина недоступна

Picture not available
Image non disponible
Imagen no disponible
Immagine non disponibile
Nicht verfügbares Bild
Brak zdjęcia
Картина недоступна

HARDWARE FOR FRONT BEARING 16 079811
BRUSH HOLDER 09 092746
A+ TERMINAL 17 590040
RECTIFIER OR DIODE BRIDGE ASSEMBLY 07 076847
FRONT BEARING 21 079349
REAR BRACKET 30 101314
SEP:SEPARATED REGULATOR -INC:BUILT-IN REGULATOR 02*098047
HARDWARE OF PULLEY 13 070921
STATOR 05 079497

Valeo**093182****A16R190**

55

28



Picture not available
Image non disponible
Imagen no disponible
Immagine non disponibile
Nicht verfügbares Bild
Brak zdjęcia
Картина недоступна

Picture not available
Image non disponible
Imagen no disponible
Immagine non disponibile
Nicht verfügbares Bild
Brak zdjęcia
Картина недоступна

AUXILIARY DIODE 08 097060
HARDWARE FOR FRONT BEARING 16 079811
BRUSH HOLDER 09 *096302
A+ TERMINAL 17 590040
RECTIFIER OR DIODE BRIDGE ASSEMBLY 07 076847
SEP:SEPARATED REGULATOR -INC:BUILT-IN REGULATOR 02*098047
HARDWARE OF PULLEY 13 070921

Valeo**094951****A16R20**

55

2V

28



Picture not available
Image non disponible
Imagen no disponible
Immagine non disponibile
Nicht verfügbares Bild
Brak zdjęcia
Картина недоступна

Picture not available
Image non disponible
Imagen no disponible
Immagine non disponibile
Nicht verfügbares Bild
Brak zdjęcia
Картина недоступна

BRUSH HOLDER 09 182231
SEP:SEPARATED REGULATOR -INC:BUILT-IN REGULATOR 02*098047
HARDWARE OF PULLEY 13 070921

Valeo**072681****A16R20T**

55

2V

28



Picture not available
Image non disponible
Imagen no disponible
Immagine non disponibile
Nicht verfügbares Bild
Brak zdjęcia
Картина недоступна

Picture not available
Image non disponible
Imagen no disponible
Immagine non disponibile
Nicht verfügbares Bild
Brak zdjęcia
Картина недоступна

BRUSH HOLDER 09 182231
SEP:SEPARATED REGULATOR -INC:BUILT-IN REGULATOR 02*098047
HARDWARE OF PULLEY 13 070921

Valeo**076635**

A16R210 120

28

Picture not available
Image non disponible
Imagen no disponible
Immagine non disponibile
Nicht verfügbares Bild
Brak zdjęćia
Картина недоступна

Picture not available
Image non disponible
Imagen no disponible
Immagine non disponibile
Nicht verfügbares Bild
Brak zdjęćia
Картина недоступна

AUXILIARY DIODE 08 097060
HARDWARE FOR FRONT BEARING 16 079811
BRUSH HOLDER 09 300686
COMPLÈTE TERMINAL "R" DIAMETER 5 18 097016
CONDENSOR 14 589045
RECTIFIER OR DIODE BRIDGE ASSEMBLY 07 097764
ROTOR 04 182276
SEP:SEPARATED REGULATOR -INC:BUILT-IN REGULATOR 02*098047
HARDWARE OF PULLEY 13 070921
STATOR 05 093469
Valeo 096956

A16R21T 55 2V

28

Picture not available
Image non disponible
Imagen no disponible
Immagine non disponibile
Nicht verfügbares Bild
Brak zdjęćia
Картина недоступна

Picture not available
Image non disponible
Imagen no disponible
Immagine non disponibile
Nicht verfügbares Bild
Brak zdjęćia
Картина недоступна

BRUSH HOLDER 09 182231
SEP:SEPARATED REGULATOR -INC:BUILT-IN REGULATOR 02*098047
HARDWARE OF PULLEY 13 070921
Valeo 093182

A16R22 55 2V

28

Picture not available
Image non disponible
Imagen no disponible
Immagine non disponibile
Nicht verfügbares Bild
Brak zdjęćia
Картина недоступна

Picture not available
Image non disponible
Imagen no disponible
Immagine non disponibile
Nicht verfügbares Bild
Brak zdjęćia
Картина недоступна

BRUSH HOLDER 09 182231
SEP:SEPARATED REGULATOR -INC:BUILT-IN REGULATOR 02*098047
HARDWARE OF PULLEY 13 070921
Valeo 072683

A16R232 120 2V

28

Picture not available
Image non disponible
Imagen no disponible
Immagine non disponibile
Nicht verfügbares Bild
Brak zdjęćia
Картина недоступна

Picture not available
Image non disponible
Imagen no disponible
Immagine non disponibile
Nicht verfügbares Bild
Brak zdjęćia
Картина недоступна

HARDWARE FOR FRONT BEARING 16 079811
BRUSH HOLDER 09 300686
COMPLÈTE TERMINAL "R" DIAMETER 5 18 097016
RECTIFIER OR DIODE BRIDGE ASSEMBLY 07 097764
ROTOR 04 182276
SEP:SEPARATED REGULATOR -INC:BUILT-IN REGULATOR 02*098047
HARDWARE OF PULLEY 13 070921
STATOR 05 093469
Valeo 097671

A16R23T 55 2V

28

Picture not available
Image non disponible
Imagen no disponible
Immagine non disponibile
Nicht verfügbares Bild
Brak zdjęćia
Картина недоступна

Picture not available
Image non disponible
Imagen no disponible
Immagine non disponibile
Nicht verfügbares Bild
Brak zdjęćia
Картина недоступна

BRUSH HOLDER 09 182231
SEP:SEPARATED REGULATOR -INC:BUILT-IN REGULATOR 02*098047
HARDWARE OF PULLEY 13 070921
Valeo 093245/436358

A16R25 55 2V

28

Picture not available
Image non disponible
Imagen no disponible
Immagine non disponibile
Nicht verfügbares Bild
Brak zdjęćia
Картина недоступна

Picture not available
Image non disponible
Imagen no disponible
Immagine non disponibile
Nicht verfügbares Bild
Brak zdjęćia
Картина недоступна

BRUSH HOLDER 09 182231
SEP:SEPARATED REGULATOR -INC:BUILT-IN REGULATOR 02*098047
HARDWARE OF PULLEY 13 070921
Valeo 093245/436358

A16R250T 100

28

Picture not available
Image non disponible
Imagen no disponible
Immagine non disponibile
Nicht verfügbares Bild
Brak zdjęćia
Картина недоступна

Picture not available
Image non disponible
Imagen no disponible
Immagine non disponibile
Nicht verfügbares Bild
Brak zdjęćia
Картина недоступна

THROUGH BOLTS 23 097011
AUXILIARY DIODE 08 097060
HARDWARE FOR FRONT BEARING 16 079811
BRUSH HOLDER 09 300686
"+" TERMINAL 20 100664
COMPLÈTE TERMINAL "R" DIAMETER 5 18 097016
CONDENSOR 14 589045
RECTIFIER OR DIODE BRIDGE ASSEMBLY 07 097764
FRONT BEARING 21 079349
REAR BRACKET 30 101314
ROTOR 04 182276
SEP:SEPARATED REGULATOR -INC:BUILT-IN REGULATOR 02093479
HARDWARE OF PULLEY 13 070921
STATOR 05 093469
Valeo 097674

A16R26 55 2V

28

Picture not available
Image non disponible
Imagen no disponible
Immagine non disponibile
Nicht verfügbares Bild
Brak zdjęćia
Картина недоступна

Picture not available
Image non disponible
Imagen no disponible
Immagine non disponibile
Nicht verfügbares Bild
Brak zdjęćia
Картина недоступна

BRUSH HOLDER 09 182231
HARDWARE OF PULLEY 13 070921
Valeo 093245/436358

A16R36T

70

2V

28



Picture not available
Image non disponible
Imagen no disponible
Immagine non disponibile
Nicht verfügbares Bild
Brak zdjęcia
Картина недоступна

Picture not available
Image non disponible
Imagen no disponible
Immagine non disponibile
Nicht verfügbares Bild
Brak zdjęcia
Картина недоступна

HARDWARE FOR FRONT BEARING 16

079811

BRUSH HOLDER 09

182231

PULLEY 11

930032

HARDWARE OF PULLEY 13

070921

Valeo**096956****A16R37T**

90

2V

28



Picture not available
Image non disponible
Imagen no disponible
Immagine non disponibile
Nicht verfügbares Bild
Brak zdjęcia
Картина недоступна

Picture not available
Image non disponible
Imagen no disponible
Immagine non disponibile
Nicht verfügbares Bild
Brak zdjęcia
Картина недоступна

HARDWARE FOR FRONT BEARING 16

079811

BRUSH HOLDER 09

182231

PULLEY 11

930032

HARDWARE OF PULLEY 13

070921

Valeo**101580/436357****A16R38T**

120

2V

28



Picture not available
Image non disponible
Imagen no disponible
Immagine non disponibile
Nicht verfügbares Bild
Brak zdjęcia
Картина недоступна

Picture not available
Image non disponible
Imagen no disponible
Immagine non disponibile
Nicht verfügbares Bild
Brak zdjęcia
Картина недоступна

HARDWARE FOR FRONT BEARING 16

079811

BRUSH HOLDER 09

182231

PULLEY 11

930032

SEP:SEPARATED REGULATOR -INC:BUILT-IN REGULATOR 02*098047

070921

HARDWARE OF PULLEY 13

070921

Valeo**096956****A16R39T**

90

2V

28



Picture not available
Image non disponible
Imagen no disponible
Immagine non disponibile
Nicht verfügbares Bild
Brak zdjęcia
Картина недоступна

Picture not available
Image non disponible
Imagen no disponible
Immagine non disponibile
Nicht verfügbares Bild
Brak zdjęcia
Картина недоступна

HARDWARE FOR FRONT BEARING 16

079811

BRUSH HOLDER 09

182231

PULLEY 11

930033

SEP:SEPARATED REGULATOR -INC:BUILT-IN REGULATOR 02*098047

070921

HARDWARE OF PULLEY 13

070921

Valeo**074219****A16R44T**

55

2V

28



Picture not available
Image non disponible
Imagen no disponible
Immagine non disponibile
Nicht verfügbares Bild
Brak zdjęcia
Картина недоступна

Picture not available
Image non disponible
Imagen no disponible
Immagine non disponibile
Nicht verfügbares Bild
Brak zdjęcia
Картина недоступна

BRUSH HOLDER 09

182231

SEP:SEPARATED REGULATOR -INC:BUILT-IN REGULATOR 02*098047

070921

HARDWARE OF PULLEY 13

070921

Valeo**078853****A16R45T**

55

2V

28



Picture not available
Image non disponible
Imagen no disponible
Immagine non disponibile
Nicht verfügbares Bild
Brak zdjęcia
Картина недоступна

Picture not available
Image non disponible
Imagen no disponible
Immagine non disponibile
Nicht verfügbares Bild
Brak zdjęcia
Картина недоступна

BRUSH HOLDER 09

182231

SEP:SEPARATED REGULATOR -INC:BUILT-IN REGULATOR 02*098047

070921

HARDWARE OF PULLEY 13

070921

Valeo**093245/436358****A16R46T**

55

28



Picture not available
Image non disponible
Imagen no disponible
Immagine non disponibile
Nicht verfügbares Bild
Brak zdjęcia
Картина недоступна

Picture not available
Image non disponible
Imagen no disponible
Immagine non disponibile
Nicht verfügbares Bild
Brak zdjęcia
Картина недоступна

BRUSH HOLDER 09

182231

Valeo**078853****A16R49T**

90

28



Picture not available
Image non disponible
Imagen no disponible
Immagine non disponibile
Nicht verfügbares Bild
Brak zdjęcia
Картина недоступна

Picture not available
Image non disponible
Imagen no disponible
Immagine non disponibile
Nicht verfügbares Bild
Brak zdjęcia
Картина недоступна

HARDWARE FOR FRONT BEARING 16

079811

BRUSH HOLDER 09

182231

SEP:SEPARATED REGULATOR -INC:BUILT-IN REGULATOR 02*098047

093329

Valeo

A16R53T 55 2V
28

Picture not available
Image non disponible
Imagen no disponible
Immagine non disponibile
Nicht verfügbares Bild
Brak zdjęć
Картина недоступна

Picture not available
Image non disponible
Imagen no disponible
Immagine non disponibile
Nicht verfügbares Bild
Brak zdjęć
Картина недоступна

BRUSH HOLDER 09 182231
SEP:SEPARATED REGULATOR -INC:BUILT-IN REGULATOR 02*098047
HARDWARE OF PULLEY 13 070921
Valeo 093245/436358

A16R59T 120 2V
28 Ø 74,39

Picture not available
Image non disponible
Imagen no disponible
Immagine non disponibile
Nicht verfügbares Bild
Brak zdjęć
Картина недоступна

Picture not available
Image non disponible
Imagen no disponible
Immagine non disponibile
Nicht verfügbares Bild
Brak zdjęć
Картина недоступна

HARDWARE FOR FRONT BEARING 16 079811
BRUSH HOLDER 09 182231
PULLEY 11 930033
SEP:SEPARATED REGULATOR -INC:BUILT-IN REGULATOR 02*098047
HARDWARE OF PULLEY 13 070921
Valeo 096956

A16R60T 90 2V
28

Picture not available
Image non disponible
Imagen no disponible
Immagine non disponibile
Nicht verfügbares Bild
Brak zdjęć
Картина недоступна

Picture not available
Image non disponible
Imagen no disponible
Immagine non disponibile
Nicht verfügbares Bild
Brak zdjęć
Картина недоступна

HARDWARE FOR FRONT BEARING 16 079811
BRUSH HOLDER 09 182231
SEP:SEPARATED REGULATOR -INC:BUILT-IN REGULATOR 02*098047
HARDWARE OF PULLEY 13 070921
Valeo 097671

CG25S013 250 7V
14 Ø 50

Picture not available
Image non disponible
Imagen no disponible
Immagine non disponibile
Nicht verfügbares Bild
Brak zdjęć
Картина недоступна

Picture not available
Image non disponible
Imagen no disponible
Immagine non disponibile
Nicht verfügbares Bild
Brak zdjęć
Картина недоступна

FRONT BEARING 21 *599058
REAR BEARING 22 *595470
PULLEY 11 *595469
Valeo 439747/440337

FG15T030 150 4 7V RL
14 90° Ø 50,08

Picture not available
Image non disponible
Imagen no disponible
Immagine non disponibile
Nicht verfügbares Bild
Brak zdjęć
Картина недоступна

Picture not available
Image non disponible
Imagen no disponible
Immagine non disponibile
Nicht verfügbares Bild
Brak zdjęć
Картина недоступна

FRONT BEARING 21 593563
REAR BEARING 22 593564
PROTECTION COVER 24 593969
PULLEY FREE WEEL + CAP PROTECTION 11c 593514
Valeo 439766/440358

FG15T036 150 4 6V
14 Ø 50

Picture not available
Image non disponible
Imagen no disponible
Immagine non disponibile
Nicht verfügbares Bild
Brak zdjęć
Картина недоступна

Picture not available
Image non disponible
Imagen no disponible
Immagine non disponibile
Nicht verfügbares Bild
Brak zdjęć
Картина недоступна

FRONT BEARING 21 593563
REAR BEARING 22 593564
PROTECTION COVER 24 595296
SEP:SEPARATED REGULATOR -INC:BUILT-IN REGULATOR 02*599083
FRONT HOUSING + STATOR 31+05 *599085
REAR BRACKET 30 *599086
ROTOR 04 *599084
Valeo 439679/440264

FG15T044 150 6V RL
14 Ø 50,76

Picture not available
Image non disponible
Imagen no disponible
Immagine non disponibile
Nicht verfügbares Bild
Brak zdjęć
Картина недоступна

Picture not available
Image non disponible
Imagen no disponible
Immagine non disponibile
Nicht verfügbares Bild
Brak zdjęć
Картина недоступна

FRONT BEARING 21 593563
REAR BEARING 22 593564
PULLEY FREE WEEL + CAP PROTECTION 11c *595317
Valeo 439759/440351

FG15T072 150 6V RL
14 Ø 50,76

Picture not available
Image non disponible
Imagen no disponible
Immagine non disponibile
Nicht verfügbares Bild
Brak zdjęć
Картина недоступна

Picture not available
Image non disponible
Imagen no disponible
Immagine non disponibile
Nicht verfügbares Bild
Brak zdjęć
Картина недоступна

FRONT BEARING 21 593563
REAR BEARING 22 593564
PULLEY FREE WEEL + CAP PROTECTION 11c *595317
Valeo 439759/440351



FG18D024

180 2 6V

14 ↻ 95° ∇ Ø 54,8 INC

Picture not available
Image non disponible
Imagen no disponible
Immagine non disponibile
Nicht verfügbares Bild
Brak zdjęcia
Картина недоступна

Picture not available
Image non disponible
Imagen no disponible
Immagine non disponibile
Nicht verfügbares Bild
Brak zdjęcia
Картина недоступна

FRONT BEARING 21 593563
REAR BEARING 22 593684
PROTECTION COVER 24 595270
SEP:SEPARATED REGULATOR -INC:BUILT-IN REGULATOR 02 *595446
RECTIFIER OR DIODE BRIDGE ASSEMBLY 07 *595364
FRONT HOUSING 31 *595461
PULLEY 11 595292
ROTOR 04 *595463
STATOR 05 *595311

Valeo**439652/440237****FG18D037**

160 4 6V RL

14 ↻ 43° ∇ Ø 54,5

Picture not available
Image non disponible
Imagen no disponible
Immagine non disponibile
Nicht verfügbares Bild
Brak zdjęcia
Картина недоступна

Picture not available
Image non disponible
Imagen no disponible
Immagine non disponibile
Nicht verfügbares Bild
Brak zdjęcia
Картина недоступна

FRONT BEARING 21 593563
REAR BEARING 22 593684
ROTOR 04 *595463
STATOR 05 *595311

Valeo**439722/440312****FG18D057**

150 3 6V RL

14 ↻ 95° ∇ Ø 55

Picture not available
Image non disponible
Imagen no disponible
Immagine non disponibile
Nicht verfügbares Bild
Brak zdjęcia
Картина недоступна

Picture not available
Image non disponible
Imagen no disponible
Immagine non disponibile
Nicht verfügbares Bild
Brak zdjęcia
Картина недоступна

FRONT BEARING 21 593563
REAR BEARING 22 593684
PROTECTION COVER 24 *599112
SEP:SEPARATED REGULATOR -INC:BUILT-IN REGULATOR 02 *595446
RECTIFIER OR DIODE BRIDGE ASSEMBLY 07 *595364
PULLEY FREE WHEEL + CAP PROTECTION 11c *599094
ROTOR 04 *595463
STATOR 05 *595311

Valeo**439708/440299****FG18S011**

180 2 7V

14 ↻ 95° ∇ Ø 54,8

Picture not available
Image non disponible
Imagen no disponible
Immagine non disponibile
Nicht verfügbares Bild
Brak zdjęcia
Картина недоступна

Picture not available
Image non disponible
Imagen no disponible
Immagine non disponibile
Nicht verfügbares Bild
Brak zdjęcia
Картина недоступна

FRONT BEARING 21 593563
REAR BEARING 22 593684
PROTECTION COVER 24 595270
SEP:SEPARATED REGULATOR -INC:BUILT-IN REGULATOR 02 *599095
RECTIFIER OR DIODE BRIDGE ASSEMBLY 07 *595364
FRONT HOUSING 31 *595461
PULLEY 11 *595462
STATOR 05 *595311

Valeo**439668/440255****FG18S012**

180 6V RL

14 ↻ Ø 51 INC

Picture not available
Image non disponible
Imagen no disponible
Immagine non disponibile
Nicht verfügbares Bild
Brak zdjęcia
Картина недоступна

Picture not available
Image non disponible
Imagen no disponible
Immagine non disponibile
Nicht verfügbares Bild
Brak zdjęcia
Картина недоступна

FRONT BEARING 21 593563
REAR BEARING 22 593684
PROTECTION COVER 24 595290
SEP:SEPARATED REGULATOR -INC:BUILT-IN REGULATOR 02 *599161
FRONT HOUSING 31 *595369
STATOR 05 *595311

Valeo**439653/440238****FG18S013**

180 4 5V

14 ↻ 98° ∇ Ø 77,7 INC

Picture not available
Image non disponible
Imagen no disponible
Immagine non disponibile
Nicht verfügbares Bild
Brak zdjęcia
Картина недоступна

Picture not available
Image non disponible
Imagen no disponible
Immagine non disponibile
Nicht verfügbares Bild
Brak zdjęcia
Картина недоступна

FRONT BEARING 21 593563
REAR BEARING 22 593684
PROTECTION COVER 24 593921
SEP:SEPARATED REGULATOR -INC:BUILT-IN REGULATOR 02 *599103
RECTIFIER OR DIODE BRIDGE ASSEMBLY 07 *595329
FRONT HOUSING 31 *595330
PULLEY 11 *595326
STATOR 05 *595311

Valeo**439618/440175**

FG18S014

180

3

6V

14



95°

Ø 54

INC

Picture not available
Image non disponible
Imagen no disponible
Immagine non disponibile
Nicht verfügbares Bild
Brak zdjęcia
Картина недоступна

Picture not available
Image non disponible
Imagen no disponible
Immagine non disponibile
Nicht verfügbares Bild
Brak zdjęcia
Картина недоступна

FRONT BEARING 21

593563

REAR BEARING 22

593684

PROTECTION COVER 24

593921

SEP:SEPARATED REGULATOR -INC:BUILT-IN REGULATOR 02 *599221**PULLEY** 11

*595331

STATOR 05

*595311

Valeo**439675/440252****FG18S016**

180

4

6V

14



Ø 50

INC

Picture not available
Image non disponible
Imagen no disponible
Immagine non disponibile
Nicht verfügbares Bild
Brak zdjęcia
Картина недоступна

Picture not available
Image non disponible
Imagen no disponible
Immagine non disponibile
Nicht verfügbares Bild
Brak zdjęcia
Картина недоступна

FRONT BEARING 21

593563

REAR BEARING 22

593684

PROTECTION COVER 24

*595367

RECTIFIER OR DIODE BRIDGE ASSEMBLY 07

*595370

FRONT HOUSING 31

*595369

PULLEY 11

*595368

STATOR 05

*595311

Valeo**439649/440219****FG18S017**

180

4

6V RL

14



80°

Ø 57,5

INC

**FRONT BEARING** 21

593563

REAR BEARING 22

593684

PROTECTION COVER 24

*595355

SEP:SEPARATED REGULATOR -INC:BUILT-IN REGULATOR 02 *595354**RECTIFIER OR DIODE BRIDGE ASSEMBLY** 07

*595353

PULLEY FREE WHEEL + CAP PROTECTION 11c

593832

ROTOR 04

*595312

STATOR 05

*595311

Valeo**439620/440177****FG18S019**

180

3

6V

14



95°

Ø 54,8

INC

B+(M8)

Picture not available
Image non disponible
Imagen no disponible
Immagine non disponibile
Nicht verfügbares Bild
Brak zdjęcia
Картина недоступна

Picture not available
Image non disponible
Imagen no disponible
Immagine non disponibile
Nicht verfügbares Bild
Brak zdjęcia
Картина недоступна

FRONT BEARING 21

593563

REAR BEARING 22

593684

PROTECTION COVER 24

595270

SEP:SEPARATED REGULATOR -INC:BUILT-IN REGULATOR 02 *599095**RECTIFIER OR DIODE BRIDGE ASSEMBLY** 07

*595364

PULLEY 11

595292

STATOR 05

*595311

Valeo**439613/440183****FG18S022**

180

2

6V RL

14



63°

Ø 56,25

INC

Picture not available
Image non disponible
Imagen no disponible
Immagine non disponibile
Nicht verfügbares Bild
Brak zdjęcia
Картина недоступна

Picture not available
Image non disponible
Imagen no disponible
Immagine non disponibile
Nicht verfügbares Bild
Brak zdjęcia
Картина недоступна

FRONT BEARING 21

593563

REAR BEARING 22

593684

PROTECTION COVER 24

593921

SEP:SEPARATED REGULATOR -INC:BUILT-IN REGULATOR 02 593813**RECTIFIER OR DIODE BRIDGE ASSEMBLY** 07

*595313

FRONT HOUSING 31

*595315

PULLEY FREE WHEEL + CAP PROTECTION 11c

*595309

STATOR 05

*595311

Valeo**439630/440197****FG18S023**

180

2

7V

14



25°

Ø 56,18

INC

Picture not available
Image non disponible
Imagen no disponible
Immagine non disponibile
Nicht verfügbares Bild
Brak zdjęcia
Картина недоступна

Picture not available
Image non disponible
Imagen no disponible
Immagine non disponibile
Nicht verfügbares Bild
Brak zdjęcia
Картина недоступна

FRONT BEARING 21

593563

REAR BEARING 22

593684

PROTECTION COVER 24

593921

SEP:SEPARATED REGULATOR -INC:BUILT-IN REGULATOR 02 593813**RECTIFIER OR DIODE BRIDGE ASSEMBLY** 07

*595314

FRONT HOUSING 31

*595316

PULLEY 11

*595310

ROTOR 04

*595312

STATOR 05

*595311

Valeo**439631/440198**

FG18S027

180 4 6V RL

14  78°  Ø 55,29

Picture not available
Image non disponible
Imagen no disponible
Immagine non disponibile
Nicht verfügbares Bild
Brak zdjęcia
Картина недоступна

Picture not available
Image non disponible
Imagen no disponible
Immagine non disponibile
Nicht verfügbares Bild
Brak zdjęcia
Картина недоступна

FRONT BEARING  21 593563
REAR BEARING  22 593564
PROTECTION COVER  24 *595498
RECTIFIER OR DIODE BRIDGE ASSEMBLY  07 *595353
PULLEY FREE WHEEL + CAP PROTECTION  11c 593832
STATOR  05 *595311
Valeo 439690/440275







FG18S029

180 4 6V

14  55°  Ø 50,98

Picture not available
Image non disponible
Imagen no disponible
Immagine non disponibile
Nicht verfügbares Bild
Brak zdjęcia
Картина недоступна

Picture not available
Image non disponible
Imagen no disponible
Immagine non disponibile
Nicht verfügbares Bild
Brak zdjęcia
Картина недоступна

FRONT BEARING  21 593563
REAR BEARING  22 593684
PROTECTION COVER  24 *599069
SEP:SEPARATED REGULATOR -INC:BUILT-IN REGULATOR  02 *599125
FRONT HOUSING  31 *599070
PULLEY  11 *595368
STATOR  05 *595311
Valeo 439741/440331







FG18S032

180 6V

14  Ø 50,98

Picture not available
Image non disponible
Imagen no disponible
Immagine non disponibile
Nicht verfügbares Bild
Brak zdjęcia
Картина недоступна

Picture not available
Image non disponible
Imagen no disponible
Immagine non disponibile
Nicht verfügbares Bild
Brak zdjęcia
Картина недоступна

FRONT BEARING  21 593563
REAR BEARING  22 593684
PROTECTION COVER  24 *599069
SEP:SEPARATED REGULATOR -INC:BUILT-IN REGULATOR  02 *599125
FRONT HOUSING  31 *595369
PULLEY  11 *595368
Valeo 439739/440329

FG18S036

180 2 7V

14  100°  Ø 54,5 INC

Picture not available
Image non disponible
Imagen no disponible
Immagine non disponibile
Nicht verfügbares Bild
Brak zdjęcia
Картина недоступна

Picture not available
Image non disponible
Imagen no disponible
Immagine non disponibile
Nicht verfügbares Bild
Brak zdjęcia
Картина недоступна

FRONT BEARING  21 593563
REAR BEARING  22 593684
PROTECTION COVER  24 593921
SEP:SEPARATED REGULATOR -INC:BUILT-IN REGULATOR  02 *599103
RECTIFIER OR DIODE BRIDGE ASSEMBLY  07 *595329
FRONT HOUSING  31 *595330
PULLEY FREE WHEEL + CAP PROTECTION  11c *595425
Valeo 439639/440205



FG18S039

180 4 6V

14  55°  Ø 50,98

Picture not available
Image non disponible
Imagen no disponible
Immagine non disponibile
Nicht verfügbares Bild
Brak zdjęcia
Картина недоступна

Picture not available
Image non disponible
Imagen no disponible
Immagine non disponibile
Nicht verfügbares Bild
Brak zdjęcia
Картина недоступна

FRONT BEARING  21 593563
REAR BEARING  22 593684
PROTECTION COVER  24 595270
SEP:SEPARATED REGULATOR -INC:BUILT-IN REGULATOR  02 *599077
STATOR  05 *595311
Valeo 439715/440305





FG18S040

180 6V

14  Ø 57

Picture not available
Image non disponible
Imagen no disponible
Immagine non disponibile
Nicht verfügbares Bild
Brak zdjęcia
Картина недоступна

Picture not available
Image non disponible
Imagen no disponible
Immagine non disponibile
Nicht verfügbares Bild
Brak zdjęcia
Картина недоступна

FRONT BEARING  21 593563
REAR BEARING  22 593684
PROTECTION COVER  24 *595367
RECTIFIER OR DIODE BRIDGE ASSEMBLY  07 *595370
FRONT HOUSING  31 *595369
Valeo 439682/440267







FG18S043

180 4 6V

14  90°  Ø 58

Picture not available
Image non disponible
Imagen no disponible
Immagine non disponibile
Nicht verfügbares Bild
Brak zdjęcia
Картина недоступна

Picture not available
Image non disponible
Imagen no disponible
Immagine non disponibile
Nicht verfügbares Bild
Brak zdjęcia
Картина недоступна

FRONT BEARING  21 593563
REAR BEARING  22 593684
PROTECTION COVER  24 593921
SEP:SEPARATED REGULATOR -INC:BUILT-IN REGULATOR  02 *599103
PULLEY  11 *595308
STATOR  05 *595311
Valeo 439681/440266

FG18S045

180

3

6V RL

14



95°

Ø 55

Picture not available
Image non disponible
Imagen no disponible
Immagine non disponibile
Nicht verfügbares Bild
Brak zdjęcia
Картина недоступна

Picture not available
Image non disponible
Imagen no disponible
Immagine non disponibile
Nicht verfügbares Bild
Brak zdjęcia
Картина недоступна

FRONT BEARING 21

593563

REAR BEARING 22

593684

PROTECTION COVER 24

*599112

SEP:SEPARATED REGULATOR -INC:BUILT-IN REGULATOR 02 *599212**RECTIFIER OR DIODE BRIDGE ASSEMBLY** 07

*595364

PULLEY FREE WEEL + CAP PROTECTION 11c

*599094

STATOR 05

*595311

Valeo

439793/440430

FG18S046

180

6V

14



Ø 50,98

Picture not available
Image non disponible
Imagen no disponible
Immagine non disponibile
Nicht verfügbares Bild
Brak zdjęcia
Картина недоступна

Picture not available
Image non disponible
Imagen no disponible
Immagine non disponibile
Nicht verfügbares Bild
Brak zdjęcia
Картина недоступна

FRONT BEARING 21

593563

REAR BEARING 22

593684

PROTECTION COVER 24

*599109

SEP:SEPARATED REGULATOR -INC:BUILT-IN REGULATOR 02 *599107**PULLEY** 11

*595368

STATOR 05

*595311

Valeo

439717/440307

FG18S047

180

6V

14



Ø 51

Picture not available
Image non disponible
Imagen no disponible
Immagine non disponibile
Nicht verfügbares Bild
Brak zdjęcia
Картина недоступна

Picture not available
Image non disponible
Imagen no disponible
Immagine non disponibile
Nicht verfügbares Bild
Brak zdjęcia
Картина недоступна

FRONT BEARING 21

593563

REAR BEARING 22

593684

PROTECTION COVER 24

595270

SEP:SEPARATED REGULATOR -INC:BUILT-IN REGULATOR 02 *599077**FRONT HOUSING** 31

*595369

STATOR 05

*595311

Valeo

439704/440295

FG18S048

180

4

6V RL

14



78°

Ø 55,29

Picture not available
Image non disponible
Imagen no disponible
Immagine non disponibile
Nicht verfügbares Bild
Brak zdjęcia
Картина недоступна

Picture not available
Image non disponible
Imagen no disponible
Immagine non disponibile
Nicht verfügbares Bild
Brak zdjęcia
Картина недоступна

FRONT BEARING 21

593563

REAR BEARING 22

593564

PROTECTION COVER 24

*595496

SEP:SEPARATED REGULATOR -INC:BUILT-IN REGULATOR 02 *595354**RECTIFIER OR DIODE BRIDGE ASSEMBLY** 07

*595353

PULLEY FREE WEEL + CAP PROTECTION 11c

593832

STATOR 05

*595311

Valeo

439698/440288

FG18S052

180

3

6V RL

14



95°

Ø 55

Picture not available
Image non disponible
Imagen no disponible
Immagine non disponibile
Nicht verfügbares Bild
Brak zdjęcia
Картина недоступна

Picture not available
Image non disponible
Imagen no disponible
Immagine non disponibile
Nicht verfügbares Bild
Brak zdjęcia
Картина недоступна

FRONT BEARING 21

593563

REAR BEARING 22

593684

PROTECTION COVER 24

*599112

SEP:SEPARATED REGULATOR -INC:BUILT-IN REGULATOR 02 *599095**RECTIFIER OR DIODE BRIDGE ASSEMBLY** 07

*595364

PULLEY FREE WEEL + CAP PROTECTION 11c

*599094

STATOR 05

*595311

Valeo

439709/440300

FG18S056

180

7V RL

14



Ø 51,31

Picture not available
Image non disponible
Imagen no disponible
Immagine non disponibile
Nicht verfügbares Bild
Brak zdjęcia
Картина недоступна

Picture not available
Image non disponible
Imagen no disponible
Immagine non disponibile
Nicht verfügbares Bild
Brak zdjęcia
Картина недоступна

FRONT BEARING 21

593563

REAR BEARING 22

593684

PROTECTION COVER 24

*599130

SEP:SEPARATED REGULATOR -INC:BUILT-IN REGULATOR 02 *599161**FRONT HOUSING** 31

*595369

PULLEY FREE WEEL + CAP PROTECTION 11c

593960

STATOR 05

*595311

Valeo

439744/440334



FG18S060

180

3

6V

14



95°

Ø 54,8

Picture not available
Image non disponible
Imagen no disponible
Immagine non disponibile
Nicht verfügbares Bild
Brak zdjęcia
Картина недоступна

Picture not available
Image non disponible
Imagen no disponible
Immagine non disponibile
Nicht verfügbares Bild
Brak zdjęcia
Картина недоступна

FRONT BEARING 21 593563
REAR BEARING 22 593684
PROTECTION COVER 24 *599112
SEP:SEPARATED REGULATOR -INC:BUILT-IN REGULATOR 02 *599095
RECTIFIER OR DIODE BRIDGE ASSEMBLY 07 *595364
PULLEY 11 595292
STATOR 05 *595311
Valeo 439732/440322

FG18S061

180

4

6V RL

14



55°

Ø 51

Picture not available
Image non disponible
Imagen no disponible
Immagine non disponibile
Nicht verfügbares Bild
Brak zdjęcia
Картина недоступна

Picture not available
Image non disponible
Imagen no disponible
Immagine non disponibile
Nicht verfügbares Bild
Brak zdjęcia
Картина недоступна

FRONT BEARING 21 593563
REAR BEARING 22 593684
PROTECTION COVER 24 *599069
SEP:SEPARATED REGULATOR -INC:BUILT-IN REGULATOR 02 *599125
FRONT HOUSING 31 *599070
STATOR 05 *595311
Valeo 439762/440354

FG18S073

180

4

6V

14



60°

Ø 51

Picture not available
Image non disponible
Imagen no disponible
Immagine non disponibile
Nicht verfügbares Bild
Brak zdjęcia
Картина недоступна

Picture not available
Image non disponible
Imagen no disponible
Immagine non disponibile
Nicht verfügbares Bild
Brak zdjęcia
Картина недоступна

FRONT BEARING 21 593563
REAR BEARING 22 593684
PROTECTION COVER 24 595270
SEP:SEPARATED REGULATOR -INC:BUILT-IN REGULATOR 02 *599077
STATOR 05 *595311
Valeo 439712/440303

FG18S077

180

6V

14



Ø 50,98

Picture not available
Image non disponible
Imagen no disponible
Immagine non disponibile
Nicht verfügbares Bild
Brak zdjęcia
Картина недоступна

Picture not available
Image non disponible
Imagen no disponible
Immagine non disponibile
Nicht verfügbares Bild
Brak zdjęcia
Картина недоступна

FRONT BEARING 21 593563
REAR BEARING 22 593684
PROTECTION COVER 24 *599069
FRONT HOUSING 31 *595369
PULLEY 11 *595368
Valeo 439738/440328

FG18S078

180

7V

14



Ø 51

Picture not available
Image non disponible
Imagen no disponible
Immagine non disponibile
Nicht verfügbares Bild
Brak zdjęcia
Картина недоступна

Picture not available
Image non disponible
Imagen no disponible
Immagine non disponibile
Nicht verfügbares Bild
Brak zdjęcia
Картина недоступна

FRONT BEARING 21 593563
REAR BEARING 22 593684
PROTECTION COVER 24 *599130
FRONT HOUSING 31 *595369
PULLEY 11 *599184
STATOR 05 *595311
Valeo 439769/440360

FG18S083

180

6V

14



Ø 50,98

Picture not available
Image non disponible
Imagen no disponible
Immagine non disponibile
Nicht verfügbares Bild
Brak zdjęcia
Картина недоступна

Picture not available
Image non disponible
Imagen no disponible
Immagine non disponibile
Nicht verfügbares Bild
Brak zdjęcia
Картина недоступна

FRONT BEARING 21 593563
REAR BEARING 22 593684
PROTECTION COVER 24 595270
SEP:SEPARATED REGULATOR -INC:BUILT-IN REGULATOR 02 *599077
FRONT HOUSING 31 *595369
PULLEY 11 *595368
STATOR 05 *595311
Valeo 439745/440335

FG18S095

180

4

6V RL

14



78°

Ø 55,29

Picture not available
Image non disponible
Imagen no disponible
Immagine non disponibile
Nicht verfügbares Bild
Brak zdjęcia
Картина недоступна

Picture not available
Image non disponible
Imagen no disponible
Immagine non disponibile
Nicht verfügbares Bild
Brak zdjęcia
Картина недоступна

FRONT BEARING 21 593563
REAR BEARING 22 593684
PROTECTION COVER 24 *595498
RECTIFIER OR DIODE BRIDGE ASSEMBLY 07 *595353
PULLEY FREE WEEL + CAP PROTECTION 11c 593832
Valeo 439779/440275

FG18S098

180

6V RL

14



Ø 51

Picture not available
Image non disponible
Imagen no disponible
Immagine non disponibile
Nicht verfügbares Bild
Brak zdjęcia
Картина недоступна

Picture not available
Image non disponible
Imagen no disponible
Immagine non disponibile
Nicht verfügbares Bild
Brak zdjęcia
Картина недоступна

FRONT BEARING 21 593563
REAR BEARING 22 593684
PROTECTION COVER 24 *599069
SEP:SEPARATED REGULATOR -INC:BUILT-IN REGULATOR 02 *599125
FRONT HOUSING 31 *595369
STATOR 05 *595311
Valeo 439772/440405

FG18S099

180

6V RL

14



Ø 51

Picture not available
Image non disponible
Imagen no disponible
Immagine non disponibile
Nicht verfügbares Bild
Brak zdjęcia
Картина недоступна

Picture not available
Image non disponible
Imagen no disponible
Immagine non disponibile
Nicht verfügbares Bild
Brak zdjęcia
Картина недоступна

FRONT BEARING 21

593563

REAR BEARING 22

593684

PROTECTION COVER 24

*599109

SEP:SEPARATED REGULATOR -INC:BUILT-IN REGULATOR 02*599107**FRONT HOUSING** 31

*595369

STATOR 05

*595311

Valeo**439773/440406****FG18S100**

180

4

6V RL

14



Ø 57,2

Picture not available
Image non disponible
Imagen no disponible
Immagine non disponibile
Nicht verfügbares Bild
Brak zdjęcia
Картина недоступна

Picture not available
Image non disponible
Imagen no disponible
Immagine non disponibile
Nicht verfügbares Bild
Brak zdjęcia
Картина недоступна

FRONT BEARING 21

593563

REAR BEARING 22

593684

PROTECTION COVER 24

593921

SEP:SEPARATED REGULATOR -INC:BUILT-IN REGULATOR 02*599103**PULLEY FREE WEEL + CAP PROTECTION** 11c

*599143

STATOR 05

*595311

FG18S100

180

4

6V RL

14



Ø 57,2

Picture not available
Image non disponible
Imagen no disponible
Immagine non disponibile
Nicht verfügbares Bild
Brak zdjęcia
Картина недоступна

Picture not available
Image non disponible
Imagen no disponible
Immagine non disponibile
Nicht verfügbares Bild
Brak zdjęcia
Картина недоступна

FRONT BEARING 21

593563

REAR BEARING 22

593684

PROTECTION COVER 24

593921

SEP:SEPARATED REGULATOR -INC:BUILT-IN REGULATOR 02*599103**PULLEY FREE WEEL + CAP PROTECTION** 11c

*599143

STATOR 05

*595311

Valeo**439777/440410****FG18T033**

180

4

6V RL

14



Ø 57,2

INC

Picture not available
Image non disponible
Imagen no disponible
Immagine non disponibile
Nicht verfügbares Bild
Brak zdjęcia
Картина недоступна

Picture not available
Image non disponible
Imagen no disponible
Immagine non disponibile
Nicht verfügbares Bild
Brak zdjęcia
Картина недоступна

FRONT BEARING 21

593563

REAR BEARING 22

593564

PROTECTION COVER 24

593991

RECTIFIER OR DIODE BRIDGE ASSEMBLY 07

*595437

PULLEY FREE WEEL + CAP PROTECTION 11c

593600

REGULATOR + COVER 02+24

593940

ROTOR 04

*595447

Valeo**439667/440253****FG18T041**

180

4

7V RL

14



Ø 57,2

Picture not available
Image non disponible
Imagen no disponible
Immagine non disponibile
Nicht verfügbares Bild
Brak zdjęcia
Картина недоступна

Picture not available
Image non disponible
Imagen no disponible
Immagine non disponibile
Nicht verfügbares Bild
Brak zdjęcia
Картина недоступна

FRONT BEARING 21

593563

REAR BEARING 22

593564

PROTECTION COVER 24

593991

SEP:SEPARATED REGULATOR -INC:BUILT-IN REGULATOR 02*599065**RECTIFIER OR DIODE BRIDGE ASSEMBLY** 07

*595437

PULLEY FREE WEEL + CAP PROTECTION 11c

*595448

ROTOR 04

*595447

Valeo**439686/440271****FG18T042**

180

4

6V

14



Ø 58

Picture not available
Image non disponible
Imagen no disponible
Immagine non disponibile
Nicht verfügbares Bild
Brak zdjęcia
Картина недоступна

Picture not available
Image non disponible
Imagen no disponible
Immagine non disponibile
Nicht verfügbares Bild
Brak zdjęcia
Картина недоступна

FRONT BEARING 21

593563

REAR BEARING 22

593564

PROTECTION COVER 24

593991

SEP:SEPARATED REGULATOR -INC:BUILT-IN REGULATOR 02*599065**RECTIFIER OR DIODE BRIDGE ASSEMBLY** 07

*599066

FRONT HOUSING + STATOR 31+05

*595454

PULLEY 11

*595308

ROTOR 04

*595447

Valeo**439687/440272****FG18T051**

180

4

6V RL

14



Ø 57,2

Picture not available
Image non disponible
Imagen no disponible
Immagine non disponibile
Nicht verfügbares Bild
Brak zdjęcia
Картина недоступна

Picture not available
Image non disponible
Imagen no disponible
Immagine non disponibile
Nicht verfügbares Bild
Brak zdjęcia
Картина недоступна

FRONT BEARING 21

593563

REAR BEARING 22

593564

PROTECTION COVER 24

593991

SEP:SEPARATED REGULATOR -INC:BUILT-IN REGULATOR 02*599103**RECTIFIER OR DIODE BRIDGE ASSEMBLY** 07

*595437

PULLEY FREE WEEL + CAP PROTECTION 11c

593600

ROTOR 04

*595447

Valeo**439718/440308**

FG18T062

180

4

6V RL

14



90°

Ø 50,58

Picture not available
Image non disponible
Imagen no disponible
Immagine non disponibile
Nicht verfügbares Bild
Brak zdjęcia
Картина недоступна

Picture not available
Image non disponible
Imagen no disponible
Immagine non disponibile
Nicht verfügbares Bild
Brak zdjęcia
Картина недоступна

FRONT BEARING 21 593563
REAR BEARING 22 593564
PROTECTION COVER 24 593991
SEP:SEPARATED REGULATOR -INC:BUILT-IN REGULATOR 02 593813
RECTIFIER OR DIODE BRIDGE ASSEMBLY 07 *595437
PULLEY FREE WEEL + CAP PROTECTION 11c 595282
ROTOR 04 *595447
Valeo 439751/440341

FG18T063

180

6V DC

14



Ø 57,2

Picture not available
Image non disponible
Imagen no disponible
Immagine non disponibile
Nicht verfügbares Bild
Brak zdjęcia
Картина недоступна

Picture not available
Image non disponible
Imagen no disponible
Immagine non disponibile
Nicht verfügbares Bild
Brak zdjęcia
Картина недоступна

FRONT BEARING 21 593563
REAR BEARING 22 593564
PROTECTION COVER 24 593991
SEP:SEPARATED REGULATOR -INC:BUILT-IN REGULATOR 02 *599098
RECTIFIER OR DIODE BRIDGE ASSEMBLY 07 *599100
FRONT HOUSING + STATOR 31+05 *599099
ROTOR 04 *595447
Valeo 439710/440301

FG18T070

180

4

7V RL

14



90°

Ø 57,2

Picture not available
Image non disponible
Imagen no disponible
Immagine non disponibile
Nicht verfügbares Bild
Brak zdjęcia
Картина недоступна

Picture not available
Image non disponible
Imagen no disponible
Immagine non disponibile
Nicht verfügbares Bild
Brak zdjęcia
Картина недоступна

FRONT BEARING 21 593563
REAR BEARING 22 593564
PROTECTION COVER 24 593991
SEP:SEPARATED REGULATOR -INC:BUILT-IN REGULATOR 02 *599103
RECTIFIER OR DIODE BRIDGE ASSEMBLY 07 *595437
PULLEY FREE WEEL + CAP PROTECTION 11c *595448
ROTOR 04 *595447
Valeo 439735/440325

FG18T071

180

4

6V

14



90°

Ø 58

Picture not available
Image non disponible
Imagen no disponible
Immagine non disponibile
Nicht verfügbares Bild
Brak zdjęcia
Картина недоступна

Picture not available
Image non disponible
Imagen no disponible
Immagine non disponibile
Nicht verfügbares Bild
Brak zdjęcia
Картина недоступна

FRONT BEARING 21 593563
REAR BEARING 22 593564
PROTECTION COVER 24 593991
SEP:SEPARATED REGULATOR -INC:BUILT-IN REGULATOR 02 *599103
RECTIFIER OR DIODE BRIDGE ASSEMBLY 07 *599066
FRONT HOUSING + STATOR 31+05 *595454
PULLEY 11 *595308
ROTOR 04 *595447
Valeo 439713/440304

FG18T072

180

4

6V

14



90°

Ø 57,2

Picture not available
Image non disponible
Imagen no disponible
Immagine non disponibile
Nicht verfügbares Bild
Brak zdjęcia
Картина недоступна

Picture not available
Image non disponible
Imagen no disponible
Immagine non disponibile
Nicht verfügbares Bild
Brak zdjęcia
Картина недоступна

FRONT BEARING 21 593563
REAR BEARING 22 593564
PROTECTION COVER 24 593991
SEP:SEPARATED REGULATOR -INC:BUILT-IN REGULATOR 02 *595327
RECTIFIER OR DIODE BRIDGE ASSEMBLY 07 *599066
FRONT HOUSING + STATOR 31+05 *595454
PULLEY 11 599137
ROTOR 04 *595447
Valeo 439750/440340

FG18T074

180

6V

14



Ø 57,2

Picture not available
Image non disponible
Imagen no disponible
Immagine non disponibile
Nicht verfügbares Bild
Brak zdjęcia
Картина недоступна

Picture not available
Image non disponible
Imagen no disponible
Immagine non disponibile
Nicht verfügbares Bild
Brak zdjęcia
Картина недоступна

FRONT BEARING 21 593563
REAR BEARING 22 593564
PROTECTION COVER 24 593991
SEP:SEPARATED REGULATOR -INC:BUILT-IN REGULATOR 02 593813
RECTIFIER OR DIODE BRIDGE ASSEMBLY 07 *599100
ROTOR 04 *595447
Valeo 439736/440326

FG18T079

180

4

6V RL

14



90°

Ø 50,5

Picture not available
Image non disponible
Imagen no disponible
Immagine non disponibile
Nicht verfügbares Bild
Brak zdjęćia
Картина недоступна

Picture not available
Image non disponible
Imagen no disponible
Immagine non disponibile
Nicht verfügbares Bild
Brak zdjęćia
Картина недоступна

FRONT BEARING 21 593563
REAR BEARING 22 593564
PROTECTION COVER 24 593991
RECTIFIER OR DIODE BRIDGE ASSEMBLY 07 *595437
PULLEY FREE WEEL + CAP PROTECTION 11c 595282
Valeo 439783/440415

FG18T094

180

4

6V RL

14



90°

Ø 57,2

Picture not available
Image non disponible
Imagen no disponible
Immagine non disponibile
Nicht verfügbares Bild
Brak zdjęćia
Картина недоступна

Picture not available
Image non disponible
Imagen no disponible
Immagine non disponibile
Nicht verfügbares Bild
Brak zdjęćia
Картина недоступна

FRONT BEARING 21 593563
REAR BEARING 22 593564
PROTECTION COVER 24 593991
RECTIFIER OR DIODE BRIDGE ASSEMBLY 07 *599066
FRONT HOUSING + STATOR 31+05 *595454
PULLEY FREE WEEL + CAP PROTECTION 11c *599143
ROTOR 04 *595447
Valeo 439784/440416

FG20S011

180

4

6V RL

14



90°

Ø 57,2

Picture not available
Image non disponible
Imagen no disponible
Immagine non disponibile
Nicht verfügbares Bild
Brak zdjęćia
Картина недоступна

Picture not available
Image non disponible
Imagen no disponible
Immagine non disponibile
Nicht verfügbares Bild
Brak zdjęćia
Картина недоступна

FRONT BEARING 21 593563
REAR BEARING 22 593684
PROTECTION COVER 24 593921
SEP:SEPARATED REGULATOR -INC:BUILT-IN REGULATOR 02 *599191
PULLEY FREE WEEL + CAP PROTECTION 11c *599143
Valeo 439781/440413

FG20S014

180

4

6V RL

14



90°

Ø 50,5

Picture not available
Image non disponible
Imagen no disponible
Immagine non disponibile
Nicht verfügbares Bild
Brak zdjęćia
Картина недоступна

Picture not available
Image non disponible
Imagen no disponible
Immagine non disponibile
Nicht verfügbares Bild
Brak zdjęćia
Картина недоступна

FRONT BEARING 21 593563
REAR BEARING 22 593684
PROTECTION COVER 24 593921
SEP:SEPARATED REGULATOR -INC:BUILT-IN REGULATOR 02 *599191
PULLEY FREE WEEL + CAP PROTECTION 11c 595282
Valeo 439771/440362

FG20S017

180

6V RL

14



Ø 61,8

Picture not available
Image non disponible
Imagen no disponible
Immagine non disponibile
Nicht verfügbares Bild
Brak zdjęćia
Картина недоступна

Picture not available
Image non disponible
Imagen no disponible
Immagine non disponibile
Nicht verfügbares Bild
Brak zdjęćia
Картина недоступна

FRONT BEARING 21 593563
REAR BEARING 22 593684
PROTECTION COVER 24 593921
SEP:SEPARATED REGULATOR -INC:BUILT-IN REGULATOR 02 *599218
PULLEY FREE WEEL + CAP PROTECTION 11c *595333
Valeo 439795/440435

FG23S010

230

7V

14



Ø 50

INC

B+(M8)

Picture not available
Image non disponible
Imagen no disponible
Immagine non disponibile
Nicht verfügbares Bild
Brak zdjęćia
Картина недоступна

Picture not available
Image non disponible
Imagen no disponible
Immagine non disponibile
Nicht verfügbares Bild
Brak zdjęćia
Картина недоступна

FRONT BEARING 21 593563
REAR BEARING 22 593684
SEP:SEPARATED REGULATOR -INC:BUILT-IN REGULATOR 02 *595464
RECTIFIER OR DIODE BRIDGE ASSEMBLY 07 *595468
FRONT HOUSING 31 *595465
PULLEY 11 *595469
PROTECTION COVER 24 *595471
ROTOR 04 *595466
STATOR 05 *595467
Valeo 439636/440203

FG23S012

220

7V RL

14



Ø 51,31

Picture not available
Image non disponible
Imagen no disponible
Immagine non disponibile
Nicht verfügbares Bild
Brak zdjęćia
Картина недоступна

Picture not available
Image non disponible
Imagen no disponible
Immagine non disponibile
Nicht verfügbares Bild
Brak zdjęćia
Картина недоступна

FRONT BEARING 21 593563
REAR BEARING 22 593684
PROTECTION COVER 24 *599130
SEP:SEPARATED REGULATOR -INC:BUILT-IN REGULATOR 02 *599067
FRONT HOUSING 31 *595369
PULLEY FREE WEEL + CAP PROTECTION 11c 593960
ROTOR 04 *595466
STATOR 05 *595467
Valeo 439765/440357



FG23S013

220

6V

14



Ø 50,98

Picture not available
Image non disponible
Imagen no disponible
Immagine non disponibile
Nicht verfügbares Bild
Brak zdjęcia
Картина недоступна

Picture not available
Image non disponible
Imagen no disponible
Immagine non disponibile
Nicht verfügbares Bild
Brak zdjęcia
Картина недоступна

FRONT BEARING 21

593563

REAR BEARING 22

593684

PROTECTION COVER 24

*599069

SEP:SEPARATED REGULATOR -INC:BUILT-IN REGULATOR 02 *599127**FRONT HOUSING** 31

*595369

PULLEY 11

*595368

ROTOR 04

*595466

Valeo**439688/440273****FG23S021**

220

4

6V

14



55°

Ø 50,98

Picture not available
Image non disponible
Imagen no disponible
Immagine non disponibile
Nicht verfügbares Bild
Brak zdjęcia
Картина недоступна

Picture not available
Image non disponible
Imagen no disponible
Immagine non disponibile
Nicht verfügbares Bild
Brak zdjęcia
Картина недоступна

FRONT BEARING 21

593563

REAR BEARING 22

593684

PROTECTION COVER 24

*599069

SEP:SEPARATED REGULATOR -INC:BUILT-IN REGULATOR 02 *599127**RECTIFIER OR DIODE BRIDGE ASSEMBLY** 07

*599071

FRONT HOUSING 31

*599070

PULLEY 11

*595368

ROTOR 04

*595466

Valeo**439689/440274****FG23S022**

230

4

6V RL

14



78°

Ø 58,7

INC

Picture not available
Image non disponible
Imagen no disponible
Immagine non disponibile
Nicht verfügbares Bild
Brak zdjęcia
Картина недоступна

Picture not available
Image non disponible
Imagen no disponible
Immagine non disponibile
Nicht verfügbares Bild
Brak zdjęcia
Картина недоступна

FRONT BEARING 21

*599058

REAR BEARING 22

*595470

PROTECTION COVER 24

*599059

RECTIFIER OR DIODE BRIDGE ASSEMBLY 07

*599056

ROTOR 04

*599063

STATOR 05

*595467

Valeo**439641/440207****FG23S025**

230

4

7V RL

14



90°

Ø 57,2

Picture not available
Image non disponible
Imagen no disponible
Immagine non disponibile
Nicht verfügbares Bild
Brak zdjęcia
Картина недоступна

Picture not available
Image non disponible
Imagen no disponible
Immagine non disponibile
Nicht verfügbares Bild
Brak zdjęcia
Картина недоступна

FRONT BEARING 21

593563

REAR BEARING 22

593684

PROTECTION COVER 24

593921

SEP:SEPARATED REGULATOR -INC:BUILT-IN REGULATOR 02 *599062**RECTIFIER OR DIODE BRIDGE ASSEMBLY** 07

*599064

FRONT HOUSING 31

*599051

PULLEY FREE WEEL + CAP PROTECTION 11c

*595448

ROTOR 04

*599063

STATOR 05

*595467

Valeo**439684/440269****FG23S026**

230

4

6V

14



90°

Ø 58

Picture not available
Image non disponible
Imagen no disponible
Immagine non disponibile
Nicht verfügbares Bild
Brak zdjęcia
Картина недоступна

Picture not available
Image non disponible
Imagen no disponible
Immagine non disponibile
Nicht verfügbares Bild
Brak zdjęcia
Картина недоступна

FRONT BEARING 21

593563

REAR BEARING 22

593684

PROTECTION COVER 24

593921

SEP:SEPARATED REGULATOR -INC:BUILT-IN REGULATOR 02 *599062**RECTIFIER OR DIODE BRIDGE ASSEMBLY** 07

*595499

FRONT HOUSING 31

*599051

PULLEY 11

*595308

ROTOR 04

*599063

STATOR 05

*595467

Valeo**439685/440270****FG23S027**

220

6V

14



Ø 50,98

Picture not available
Image non disponible
Imagen no disponible
Immagine non disponibile
Nicht verfügbares Bild
Brak zdjęcia
Картина недоступна

Picture not available
Image non disponible
Imagen no disponible
Immagine non disponibile
Nicht verfügbares Bild
Brak zdjęcia
Картина недоступна

FRONT BEARING 21

593563

REAR BEARING 22

593684

PROTECTION COVER 24

*599109

SEP:SEPARATED REGULATOR -INC:BUILT-IN REGULATOR 02 *599128**FRONT HOUSING** 31

*595369

PULLEY 11

*595368

ROTOR 04

*595466

STATOR 05

*595467

Valeo**439743/440333**

FG23S028

230

4

7V RL

14



90°

Ø 57,2

Picture not available
Image non disponible
Imagen no disponible
Immagine non disponibile
Nicht verfügbares Bild
Brak zdjęcia
Картина недоступна

Picture not available
Image non disponible
Imagen no disponible
Immagine non disponibile
Nicht verfügbares Bild
Brak zdjęcia
Картина недоступна

FRONT BEARING 21

593563

REAR BEARING 22

593684

PROTECTION COVER 24

593921

SEP:SEPARATED REGULATOR -INC:BUILT-IN REGULATOR 02 *599159**RECTIFIER OR DIODE BRIDGE ASSEMBLY** 07

*599064

FRONT HOUSING 31

*599051

PULLEY FREE WEEL + CAP PROTECTION 11c

*595448

ROTOR 04

*599063

STATOR 05

*595467

Valeo**439711/440302****FG23S031**

230

4

6V

14



90°

Ø 58

Picture not available
Image non disponible
Imagen no disponible
Immagine non disponibile
Nicht verfügbares Bild
Brak zdjęcia
Картина недоступна

Picture not available
Image non disponible
Imagen no disponible
Immagine non disponibile
Nicht verfügbares Bild
Brak zdjęcia
Картина недоступна

FRONT BEARING 21

593563

REAR BEARING 22

593684

PROTECTION COVER 24

593921

SEP:SEPARATED REGULATOR -INC:BUILT-IN REGULATOR 02 *599159**RECTIFIER OR DIODE BRIDGE ASSEMBLY** 07

*595499

FRONT HOUSING 31

*599051

PULLEY 11

*595308

ROTOR 04

*599063

STATOR 05

*595467

Valeo**439716/440306****FG23S032**

220

3

6V RL

14



95°

Ø 55

Picture not available
Image non disponible
Imagen no disponible
Immagine non disponibile
Nicht verfügbares Bild
Brak zdjęcia
Картина недоступна

Picture not available
Image non disponible
Imagen no disponible
Immagine non disponibile
Nicht verfügbares Bild
Brak zdjęcia
Картина недоступна

FRONT BEARING 21

593563

REAR BEARING 22

593684

PROTECTION COVER 24

*599112

SEP:SEPARATED REGULATOR -INC:BUILT-IN REGULATOR 02 *595464**RECTIFIER OR DIODE BRIDGE ASSEMBLY** 07

*599186

PULLEY FREE WEEL + CAP PROTECTION 11c

*599094

STATOR 05

*595467

Valeo**439730/440320****FG23S033**

220

3

6V RL

14



95°

Ø 55

Picture not available
Image non disponible
Imagen no disponible
Immagine non disponibile
Nicht verfügbares Bild
Brak zdjęcia
Картина недоступна

Picture not available
Image non disponible
Imagen no disponible
Immagine non disponibile
Nicht verfügbares Bild
Brak zdjęcia
Картина недоступна

FRONT BEARING 21

593563

REAR BEARING 22

593684

PROTECTION COVER 24

*599112

SEP:SEPARATED REGULATOR -INC:BUILT-IN REGULATOR 02 *599215**RECTIFIER OR DIODE BRIDGE ASSEMBLY** 07

*599186

PULLEY FREE WEEL + CAP PROTECTION 11c

*599094

STATOR 05

*595467

Valeo**439788/440419****FG23S035**

230

4

6V RL

14



90°

Ø 57,2

Picture not available
Image non disponible
Imagen no disponible
Immagine non disponibile
Nicht verfügbares Bild
Brak zdjęcia
Картина недоступна

Picture not available
Image non disponible
Imagen no disponible
Immagine non disponibile
Nicht verfügbares Bild
Brak zdjęcia
Картина недоступна

FRONT BEARING 21

593563

REAR BEARING 22

593684

PROTECTION COVER 24

593921

SEP:SEPARATED REGULATOR -INC:BUILT-IN REGULATOR 02 *599141**PULLEY FREE WEEL + CAP PROTECTION** 11c

*599143

ROTOR 04

*599063

Valeo**439756/440346****FG23S039**

220

4

6V RL

14



55°

Ø 51

Picture not available
Image non disponible
Imagen no disponible
Immagine non disponibile
Nicht verfügbares Bild
Brak zdjęcia
Картина недоступна

Picture not available
Image non disponible
Imagen no disponible
Immagine non disponibile
Nicht verfügbares Bild
Brak zdjęcia
Картина недоступна

FRONT BEARING 21

593563

REAR BEARING 22

593684

PROTECTION COVER 24

*599069

SEP:SEPARATED REGULATOR -INC:BUILT-IN REGULATOR 02 *599127**RECTIFIER OR DIODE BRIDGE ASSEMBLY** 07

*599071

FRONT HOUSING 31

*599070

ROTOR 04

*595466

STATOR 05

*595467

Valeo**439742/440332**

FG23S040

220

3

6V

14



95°

Ø 54,8

Picture not available
Image non disponible
Imagen no disponible
Immagine non disponibile
Nicht verfügbares Bild
Brak zdjęcia
Картина недоступна

Picture not available
Image non disponible
Imagen no disponible
Immagine non disponibile
Nicht verfügbares Bild
Brak zdjęcia
Картина недоступна

FRONT BEARING 21 593563
REAR BEARING 22 593684
PROTECTION COVER 24 *599112
SEP:SEPARATED REGULATOR -INC:BUILT-IN REGULATOR 02 *595464
RECTIFIER OR DIODE BRIDGE ASSEMBLY 07 *599186
PULLEY 11 595292
STATOR 05 *595467
Valeo **439731/440321**

FG23S041

220

3

6V

14



95°

Ø 54,8

Picture not available
Image non disponible
Imagen no disponible
Immagine non disponibile
Nicht verfügbares Bild
Brak zdjęcia
Картина недоступна

Picture not available
Image non disponible
Imagen no disponible
Immagine non disponibile
Nicht verfügbares Bild
Brak zdjęcia
Картина недоступна

FRONT BEARING 21 593563
REAR BEARING 22 593684
PROTECTION COVER 24 *599112
RECTIFIER OR DIODE BRIDGE ASSEMBLY 07 *599186
PULLEY 11 595292
STATOR 05 *595467
Valeo **439794/440434**

FG23S043

230

7V

14



Ø 50

INC

B+(M8)

Picture not available
Image non disponible
Imagen no disponible
Immagine non disponibile
Nicht verfügbares Bild
Brak zdjęcia
Картина недоступна

Picture not available
Image non disponible
Imagen no disponible
Immagine non disponibile
Nicht verfügbares Bild
Brak zdjęcia
Картина недоступна

FRONT BEARING 21 593563
REAR BEARING 22 593684
SEP:SEPARATED REGULATOR -INC:BUILT-IN REGULATOR 02 *595464
RECTIFIER OR DIODE BRIDGE ASSEMBLY 07 *595468
FRONT HOUSING 31 *595465
PULLEY 11 *595469
PROTECTION COVER 24 *595471
Valeo **439636/440203**

FG23S046

230

4

6V

14



90°

Ø 57,2

Picture not available
Image non disponible
Imagen no disponible
Immagine non disponibile
Nicht verfügbares Bild
Brak zdjęcia
Картина недоступна

Picture not available
Image non disponible
Imagen no disponible
Immagine non disponibile
Nicht verfügbares Bild
Brak zdjęcia
Картина недоступна

FRONT BEARING 21 593563
REAR BEARING 22 593684
PROTECTION COVER 24 593921
PULLEY 11 599137
ROTOR 04 *599063
Valeo **439749/440339**

FG23S048

220

7V

14



Ø 51

Picture not available
Image non disponible
Imagen no disponible
Immagine non disponibile
Nicht verfügbares Bild
Brak zdjęcia
Картина недоступна

Picture not available
Image non disponible
Imagen no disponible
Immagine non disponibile
Nicht verfügbares Bild
Brak zdjęcia
Картина недоступна

FRONT BEARING 21 593563
REAR BEARING 22 593684
PROTECTION COVER 24 *599130
SEP:SEPARATED REGULATOR -INC:BUILT-IN REGULATOR 02 *599181
FRONT HOUSING 31 *595369
PULLEY 11 *599184
ROTOR 04 *595466
STATOR 05 *595467
Valeo **439770/440361**

FG23S049

220

6V

14



Ø 50,98

Picture not available
Image non disponible
Imagen no disponible
Immagine non disponibile
Nicht verfügbares Bild
Brak zdjęcia
Картина недоступна

Picture not available
Image non disponible
Imagen no disponible
Immagine non disponibile
Nicht verfügbares Bild
Brak zdjęcia
Картина недоступна

FRONT BEARING 21 593563
REAR BEARING 22 593684
PROTECTION COVER 24 *599069
SEP:SEPARATED REGULATOR -INC:BUILT-IN REGULATOR 02 *599181
FRONT HOUSING 31 *595369
PULLEY 11 *595368
ROTOR 04 *595466
STATOR 05 *595467
Valeo **439740/440330**

FG23S054

230

7V

14



Ø 50

INC

B+(M8)

Picture not available
Image non disponible
Imagen no disponible
Immagine non disponibile
Nicht verfügbares Bild
Brak zdjęcia
Картина недоступна

Picture not available
Image non disponible
Imagen no disponible
Immagine non disponibile
Nicht verfügbares Bild
Brak zdjęcia
Картина недоступна

FRONT BEARING 21 593563
REAR BEARING 22 *595470
SEP:SEPARATED REGULATOR -INC:BUILT-IN REGULATOR 02 *595464
RECTIFIER OR DIODE BRIDGE ASSEMBLY 07 *595468
FRONT HOUSING 31 *595465
PULLEY 11 *595469
PROTECTION COVER 24 *595471
STATOR 05 *595467
Valeo **439636/440203**

FG23S057

230

4

6V RL

14



90°

Ø 57,2

Picture not available
Image non disponible
Imagen no disponible
Immagine non disponibile
Nicht verfügbares Bild
Brak zdjęcia
Картина недоступна

Picture not available
Image non disponible
Imagen no disponible
Immagine non disponibile
Nicht verfügbares Bild
Brak zdjęcia
Картина недоступна

FRONT BEARING 21

593563

REAR BEARING 22

593684

PROTECTION COVER 24

593921

SEP:SEPARATED REGULATOR -INC:BUILT-IN REGULATOR 02*599096**PULLEY FREE WEEL + CAP PROTECTION** 11c

*599143

ROTOR 04

*599063

STATOR 05

*595467

Valeo**439774/440407****FG23S058**

220

3

6V

14



95°

Ø 54,8

Picture not available
Image non disponible
Imagen no disponible
Immagine non disponibile
Nicht verfügbares Bild
Brak zdjęcia
Картина недоступна

Picture not available
Image non disponible
Imagen no disponible
Immagine non disponibile
Nicht verfügbares Bild
Brak zdjęcia
Картина недоступна

FRONT BEARING 21

593563

REAR BEARING 22

593684

PROTECTION COVER 24

*599112

SEP:SEPARATED REGULATOR -INC:BUILT-IN REGULATOR 02*599088**RECTIFIER OR DIODE BRIDGE ASSEMBLY** 07

*599186

PULLEY 11

595292

STATOR 05

*595467

Valeo**439731/440321****FG23S061**

230

4

6V RL

14



90°

Ø 57,2

Picture not available
Image non disponible
Imagen no disponible
Immagine non disponibile
Nicht verfügbares Bild
Brak zdjęcia
Картина недоступна

Picture not available
Image non disponible
Imagen no disponible
Immagine non disponibile
Nicht verfügbares Bild
Brak zdjęcia
Картина недоступна

FRONT BEARING 21

593563

REAR BEARING 22

593684

PROTECTION COVER 24

593921

SEP:SEPARATED REGULATOR -INC:BUILT-IN REGULATOR 02*599183**PULLEY FREE WEEL + CAP PROTECTION** 11c

*599143

ROTOR 04

*599063

Valeo**439756/440346****FG23S063**

230

4

6V RL

14



80°

Ø 58,7

Picture not available
Image non disponible
Imagen no disponible
Immagine non disponibile
Nicht verfügbares Bild
Brak zdjęcia
Картина недоступна

Picture not available
Image non disponible
Imagen no disponible
Immagine non disponibile
Nicht verfügbares Bild
Brak zdjęcia
Картина недоступна

FRONT BEARING 21

593563

REAR BEARING 22

593684

PROTECTION COVER 24

*599059

RECTIFIER OR DIODE BRIDGE ASSEMBLY 07

*599056

ROTOR 04

*599063

STATOR 05

*595467

Valeo**439789/440426****FG9T011**

90

2

6V

14



8°

Ø 60,98

Picture not available
Image non disponible
Imagen no disponible
Immagine non disponibile
Nicht verfügbares Bild
Brak zdjęcia
Картина недоступна

Picture not available
Image non disponible
Imagen no disponible
Immagine non disponibile
Nicht verfügbares Bild
Brak zdjęcia
Картина недоступна

SEP:SEPARATED REGULATOR -INC:BUILT-IN REGULATOR 02*599162**Valeo****439763/440355****FG9T012**

90

2

4V RL

14



28°

Ø 53,7

Picture not available
Image non disponible
Imagen no disponible
Immagine non disponibile
Nicht verfügbares Bild
Brak zdjęcia
Картина недоступна

Picture not available
Image non disponible
Imagen no disponible
Immagine non disponibile
Nicht verfügbares Bild
Brak zdjęcia
Картина недоступна

SEP:SEPARATED REGULATOR -INC:BUILT-IN REGULATOR 02*599162**PULLEY FREE WEEL + CAP PROTECTION** 11c

*599209

Valeo**439787/440418****SG10B010**

120

2

6V

14



35°

Ø 58,18

Picture not available
Image non disponible
Imagen no disponible
Immagine non disponibile
Nicht verfügbares Bild
Brak zdjęcia
Картина недоступна

Picture not available
Image non disponible
Imagen no disponible
Immagine non disponibile
Nicht verfügbares Bild
Brak zdjęcia
Картина недоступна

FRONT BEARING 21

593563

REAR BEARING 22

593564

PROTECTION COVER 24

593837

RECTIFIER OR DIODE BRIDGE ASSEMBLY 07

593397

FRONT HOUSING 31

593633

REGULATOR + COVER 02+24

593936

ROTOR 04

593800

STATOR 05

593801

Valeo**439267/437184**

SG10B011 120 2 6V

14 ↻ ∇ Ø 58,18 INC



FRONT BEARING 21 593563
 REAR BEARING 22 593564
 PROTECTION COVER 24 593837
 RECTIFIER OR DIODE BRIDGE ASSEMBLY 07 593399
 FRONT HOUSING 31 593776
 REGULATOR + COVER 02+24 593936
 ROTOR 04 593800
 STATOR 05 593801
Valeo 439266/437183

SG10B013 60 2 SP

28 ↻ 20° ∇

Picture not available
 Image non disponible
 Imagen no disponible
 Immagine non disponibile
 Nicht verfügbares Bild
 Brak zdjęcia
 Картина недоступна

Picture not available
 Image non disponible
 Imagen no disponible
 Immagine non disponibile
 Nicht verfügbares Bild
 Brak zdjęcia
 Картина недоступна

FRONT BEARING 21 593563
 REAR BEARING 22 593564
Valeo 439309/437314

SG10B016 120 6V

14 ↻ ∇ Ø 58,18 INC



FRONT BEARING 21 593563
 REAR BEARING 22 593564
 PROTECTION COVER 24 593837
 RECTIFIER OR DIODE BRIDGE ASSEMBLY 07 593418
 FRONT HOUSING 31 593640
 PULLEY 11 593610
 REGULATOR + COVER 02+24 593936
 ROTOR 04 593325
 STATOR 05 593583
Valeo 439318/437321

SG10B019 120 2 6V

14 ↻ 35° ∇ Ø 59,4 INC



FRONT BEARING 21 593563
 REAR BEARING 22 593564
 PROTECTION COVER 24 593680
 RECTIFIER OR DIODE BRIDGE ASSEMBLY 07 593397
 FRONT HOUSING 31 593633
 PULLEY FREE WHEEL + CAP PROTECTION 11c 593515
 REGULATOR + COVER 02+24 593937
 ROTOR 04 593800
 STATOR 05 593801

SG10B019 120 2 6V

14 ↻ 35° ∇ Ø 59,4 INC



FRONT BEARING 21 593563
 REAR BEARING 22 593564
 PROTECTION COVER 24 593680
 RECTIFIER OR DIODE BRIDGE ASSEMBLY 07 593397
 FRONT HOUSING 31 593633
 PULLEY FREE WHEEL + CAP PROTECTION 11c 593515
 REGULATOR + COVER 02+24 593937
 ROTOR 04 593800
 STATOR 05 593801
Valeo 439319/437347

SG10B020 SP 120

14 ↻ INC



FRONT BEARING 21 593563
 REAR BEARING 22 593564
 PROTECTION COVER 24 593837
 RECTIFIER OR DIODE BRIDGE ASSEMBLY 07 593418
 FRONT HOUSING 31 593640
 REGULATOR + COVER 02+24 593936
 ROTOR 04 593325
 STATOR 05 593583
Valeo 439313/437318

SG10B021

97

4

6V

14



40°

Ø 57,5

INC

**B+(M8)**
L(M5)

FRONT BEARING	21	593563
REAR BEARING	22	593564
PROTECTION COVER	24	593510
SEP:SEPARATED REGULATOR -INC:BUILT-IN REGULATOR	02	593534
RECTIFIER OR DIODE BRIDGE ASSEMBLY	07	593530
FRONT HOUSING	31	593651
PULLEY	11	593519
ROTOR	04	593147
STATOR	05	593586

SG10B021

97

4

6V

14



40°

Ø 57,5

INC

**B+(M8)**
L(M5)

FRONT BEARING	21	593563
REAR BEARING	22	593564
PROTECTION COVER	24	593510
SEP:SEPARATED REGULATOR -INC:BUILT-IN REGULATOR	02	593534
RECTIFIER OR DIODE BRIDGE ASSEMBLY	07	593530
FRONT HOUSING	31	593651
PULLEY	11	593519
ROTOR	04	593147
STATOR	05	593586

Valeo**439248/437139****SG10B022**

90

4

6V

14



80°

Ø 57,5

INC



FRONT BEARING	21	593563
REAR BEARING	22	593564
PROTECTION COVER	24	593531
SEP:SEPARATED REGULATOR -INC:BUILT-IN REGULATOR	02	593529
RECTIFIER OR DIODE BRIDGE ASSEMBLY	07	593530
FRONT HOUSING	31	593651
PULLEY	11	593519
ROTOR	04	593147
STATOR	05	593586

SG10B022

90

4

6V

14



80°

Ø 57,5

INC



FRONT BEARING	21	593563
REAR BEARING	22	593564
PROTECTION COVER	24	593531
SEP:SEPARATED REGULATOR -INC:BUILT-IN REGULATOR	02	593529
RECTIFIER OR DIODE BRIDGE ASSEMBLY	07	593530
FRONT HOUSING	31	593651
PULLEY	11	593519
ROTOR	04	593147
STATOR	05	593586

SG10B022

90

4

6V

14



80°

Ø 57,5

INC



FRONT BEARING	21	593563
REAR BEARING	22	593564
PROTECTION COVER	24	593531
SEP:SEPARATED REGULATOR -INC:BUILT-IN REGULATOR	02	593529
RECTIFIER OR DIODE BRIDGE ASSEMBLY	07	593530
FRONT HOUSING	31	593651
PULLEY	11	593519
ROTOR	04	593147
STATOR	05	593586

SG10B022

90

4

6V

14



80°

Ø 57,5

INC

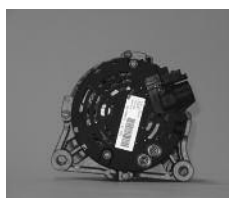

FRONT BEARING	21	593563
REAR BEARING	22	593564
PROTECTION COVER	24	593531
SEP:SEPARATED REGULATOR -INC:BUILT-IN REGULATOR	02	593529
RECTIFIER OR DIODE BRIDGE ASSEMBLY	07	593530
FRONT HOUSING	31	593651
PULLEY	11	593519
ROTOR	04	593147
STATOR	05	593586

Valeo**439276/437357**

SG10B023

90 4 6V

14 ↻ 40° ∇ Ø 52 INC

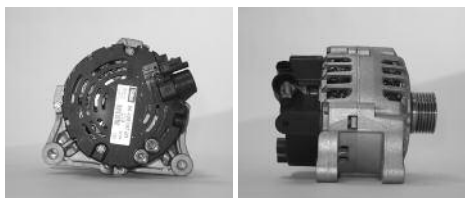

FRONT BEARING 21 593563
 REAR BEARING 22 593564
 PROTECTION COVER 24 593531
 SEP:SEPARATED REGULATOR -INC:BUILT-IN REGULATOR 02 593529
 RECTIFIER OR DIODE BRIDGE ASSEMBLY 07 593530
 FRONT HOUSING 31 593651
 PULLEY 11 593619
 ROTOR 04 593147
 STATOR 05 593586

Valeo

439449/437409

SG10B031

120 2 6V

14 ↻ 0° ∇ Ø 58,18 INC

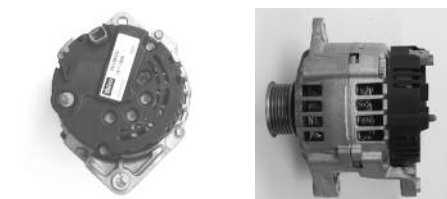

FRONT BEARING 21 593563
 REAR BEARING 22 593564
 PROTECTION COVER 24 593837
 RECTIFIER OR DIODE BRIDGE ASSEMBLY 07 593399
 FRONT HOUSING 31 593776
 REGULATOR + COVER 02+24 593936
 ROTOR 04 593800
 STATOR 05 593801

Valeo

439266/437183

SG10B032

120 2 6V

14 ↻ 0° ∇ Ø 59,4 INC



FRONT BEARING 21 593563
 REAR BEARING 22 593564
 PROTECTION COVER 24 593837
 RECTIFIER OR DIODE BRIDGE ASSEMBLY 07 593399
 FRONT HOUSING 31 593776
 PULLEY FREE WEEL + CAP PROTECTION 11c 593515
 REGULATOR + COVER 02+24 593936
 ROTOR 04 593800
 STATOR 05 593801

SG10B032

120 2 6V

14 ↻ 0° ∇ Ø 59,4 INC



FRONT BEARING 21 593563
 REAR BEARING 22 593564
 PROTECTION COVER 24 593837
 RECTIFIER OR DIODE BRIDGE ASSEMBLY 07 593399
 FRONT HOUSING 31 593776
 PULLEY FREE WEEL + CAP PROTECTION 11c 593515
 REGULATOR + COVER 02+24 593936
 ROTOR 04 593800
 STATOR 05 593801

Valeo

439480/437443

SG10B035

120 2 6V

14 ↻ 0° ∇ Ø 58,18 INC

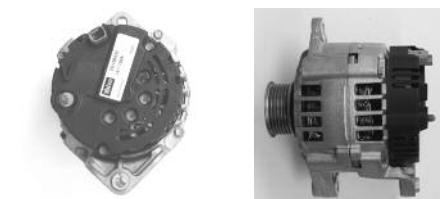

FRONT BEARING 21 593563
 REAR BEARING 22 593564
 PROTECTION COVER 24 593837
 RECTIFIER OR DIODE BRIDGE ASSEMBLY 07 593399
 FRONT HOUSING 31 593776
 REGULATOR + COVER 02+24 593936
 ROTOR 04 593800
 STATOR 05 593801

SG10B035

120 2 6V

14 ↻ 0° ∇ Ø 58,18 INC

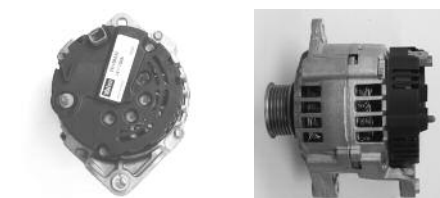

FRONT BEARING 21 593563
 REAR BEARING 22 593564
 PROTECTION COVER 24 593837
 RECTIFIER OR DIODE BRIDGE ASSEMBLY 07 593399
 FRONT HOUSING 31 593776
 REGULATOR + COVER 02+24 593936
 ROTOR 04 593800
 STATOR 05 593801

Valeo

439266/437353

SG10B048

97

4

6V

14



40°

Ø 57,5

INC

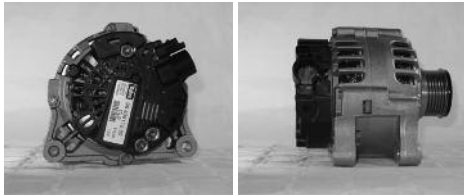

FRONT BEARING 21 593563
 REAR BEARING 22 593564
 PROTECTION COVER 24 593531
 SEP:SEPARATED REGULATOR -INC:BUILT-IN REGULATOR 02 593529
 RECTIFIER OR DIODE BRIDGE ASSEMBLY 07 593530
 PULLEY FREE WEEL + CAP PROTECTION 11c 593832
 ROTOR 04 593147
 STATOR 05 593586

Valeo

439553/437550

SG11B010

110

6V

14



Ø 50,31

Picture not available
 Image non disponible
 Imagen no disponible
 Immagine non disponibile
 Nicht verfügbares Bild
 Brak zdjęcia
 Картина недоступна

Picture not available
 Image non disponible
 Imagen no disponible
 Immagine non disponibile
 Nicht verfügbares Bild
 Brak zdjęcia
 Картина недоступна

FRONT BEARING 21 593563
 REAR BEARING 22 593564
 PROTECTION COVER 24 593471
 SEP:SEPARATED REGULATOR -INC:BUILT-IN REGULATOR 02 595256
 PULLEY FREE WEEL + CAP PROTECTION 11c 595203
 ROTOR 04 593147

Valeo

439484/437449

SG12B010

120

2

5V

14



60°

Ø 57,2

INC

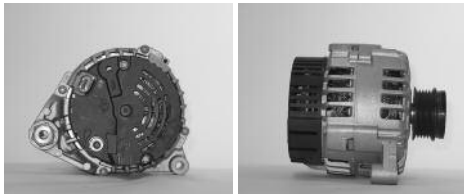

FRONT BEARING 21 593563
 REAR BEARING 22 593564
 PROTECTION COVER 24 593834
 SEP:SEPARATED REGULATOR -INC:BUILT-IN REGULATOR 02 593522
 RECTIFIER OR DIODE BRIDGE ASSEMBLY 07 593542
 FRONT HOUSING 31 593627
 PULLEY FREE WEEL + CAP PROTECTION 11c 593490
 REGULATOR + COVER 02+24 593941
 ROTOR 04 593570
 STATOR 05 593580

Valeo

439271/437188

SG12B011

120

2

6V

14



60°

Ø 66

INC

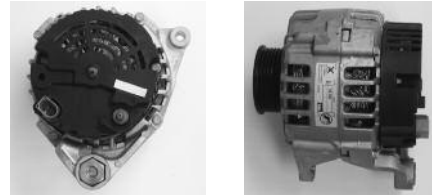

FRONT BEARING 21 593563
 REAR BEARING 22 593564
 PROTECTION COVER 24 593834
 SEP:SEPARATED REGULATOR -INC:BUILT-IN REGULATOR 02 593522
 RECTIFIER OR DIODE BRIDGE ASSEMBLY 07 593542
 FRONT HOUSING 31 593627
 PULLEY 11 593593
 REGULATOR + COVER 02+24 593941
 ROTOR 04 593570
 STATOR 05 593580

Valeo

439265/437178

SG12B012

120

2

5V

14



90°

Ø 57,2

INC

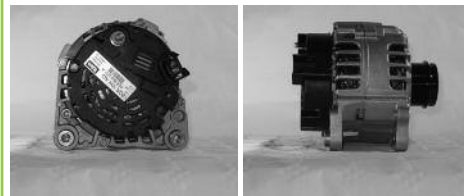

FRONT BEARING 21 593563
 REAR BEARING 22 593564
 PROTECTION COVER 24 593834
 SEP:SEPARATED REGULATOR -INC:BUILT-IN REGULATOR 02 593813
 RECTIFIER OR DIODE BRIDGE ASSEMBLY 07 593547
 FRONT HOUSING 31 593632
 PULLEY FREE WEEL + CAP PROTECTION 11c 593490
 ROTOR 04 593570
 STATOR 05 593580

Valeo

439328/437341

SG12B015

120

2

6V

14



90°

Ø 57,2

INC

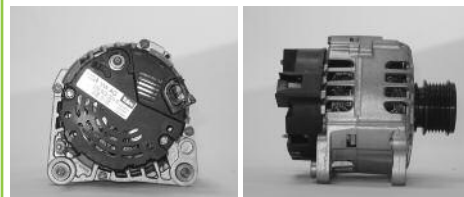

FRONT BEARING 21 593563
 REAR BEARING 22 593564
 PROTECTION COVER 24 593417
 PROTECTION COVER 24 593848
 SEP:SEPARATED REGULATOR -INC:BUILT-IN REGULATOR 02 593480
 RECTIFIER OR DIODE BRIDGE ASSEMBLY 07 593415
 FRONT HOUSING 31 593632
 PULLEY FREE WEEL + CAP PROTECTION 11c 593600
 REGULATOR + COVER 02+24 593940
 ROTOR 04 593570
 STATOR 05 593580

Valeo

439312/437317

SG12B016

120 2 6V

14 ↻ 60° ∇ Ø 59 INC



FRONT BEARING	↗ 21	593563
REAR BEARING	↗ 22	593564
PROTECTION COVER	↗ 24	593834
RECTIFIER OR DIODE BRIDGE ASSEMBLY	↗ 07	593542
FRONT HOUSING	↗ 31	593627
PULLEY	↗ 11	593594
REGULATOR + COVER	↗ 02+24	593941
ROTOR	↗ 04	593570
STATOR	↗ 05	593580

Valeo

439272/437189

SG12B017

125 2 6V / 7V RL

14 ↻ 90° ∇ Ø 52,3 INC

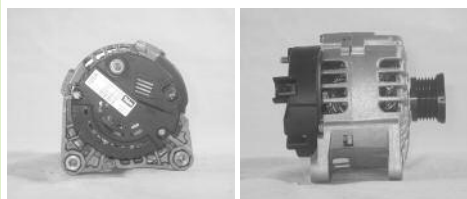

FRONT BEARING	↗ 21	593563
REAR BEARING	↗ 22	593564
PROTECTION COVER	↗ 24	593680
RECTIFIER OR DIODE BRIDGE ASSEMBLY	↗ 07	593830
FRONT HOUSING	↗ 31	593632
PULLEY FREE WHEEL + CAP PROTECTION	↗ 11c	593514
REGULATOR + COVER	↗ 02+24	593937
ROTOR	↗ 04	593568
STATOR	↗ 05	593580

SG12B017

125 2 6V / 7V RL

14 ↻ 90° ∇ Ø 52,3 INC

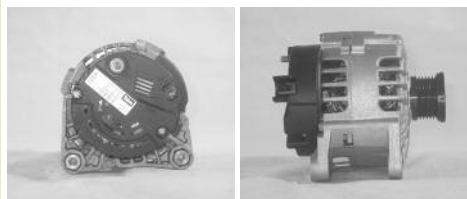

FRONT BEARING	↗ 21	593563
REAR BEARING	↗ 22	593564
PROTECTION COVER	↗ 24	593680
RECTIFIER OR DIODE BRIDGE ASSEMBLY	↗ 07	593830
FRONT HOUSING	↗ 31	593632
PULLEY FREE WHEEL + CAP PROTECTION	↗ 11c	593514
REGULATOR + COVER	↗ 02+24	593937
ROTOR	↗ 04	593568
STATOR	↗ 05	593580

Valeo

439292/437208

SG12B018

120 2 5V

14 ↻ 60° ∇ Ø 57,2 INC

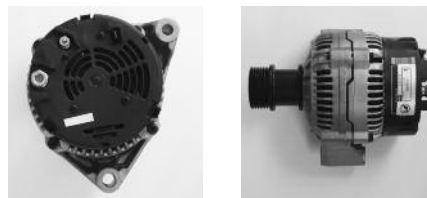

FRONT BEARING	↗ 21	593563
REAR BEARING	↗ 22	593564
PROTECTION COVER	↗ 24	593834
SEP:SEPARATED REGULATOR -INC:BUILT-IN REGULATOR	↗ 02	593522
RECTIFIER OR DIODE BRIDGE ASSEMBLY	↗ 07	593542
FRONT HOUSING	↗ 31	593627
PULLEY	↗ 11	593592
REGULATOR + COVER	↗ 02+24	593941
ROTOR	↗ 04	593570
STATOR	↗ 05	593580

Valeo

439263/437176

SG12B021

120 1 6V

14 ↻ Ø 57 INC

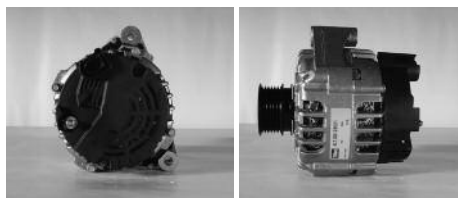

FRONT BEARING	↗ 21	593563
REAR BEARING	↗ 22	593564
PROTECTION COVER	↗ 24	593553
RECTIFIER OR DIODE BRIDGE ASSEMBLY	↗ 07	593393
FRONT HOUSING	↗ 31	593629
PULLEY	↗ 11	593596
REGULATOR + COVER	↗ 02+24	593944
ROTOR	↗ 04	593570
STATOR	↗ 05	593580

Valeo

439296/437222

SG12B022

120 1 6V

14 ↻ 60° ∇ Ø 57 INC



FRONT BEARING	↗ 21	593563
REAR BEARING	↗ 22	593564
PROTECTION COVER	↗ 24	593553
RECTIFIER OR DIODE BRIDGE ASSEMBLY	↗ 07	593393
FRONT HOUSING	↗ 31	593629
PULLEY	↗ 11	593596
REGULATOR + COVER	↗ 02+24	593943
ROTOR	↗ 04	593570
STATOR	↗ 05	593580

Valeo

439297/437223

SG12B023

120

1

6V

14



60°

Ø 51

INC

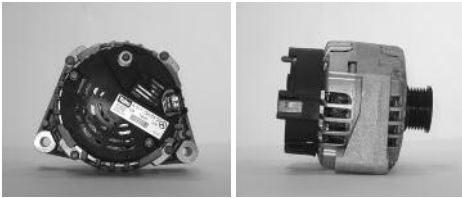

FRONT BEARING	593563
REAR BEARING	593564
PROTECTION COVER	593553
RECTIFIER OR DIODE BRIDGE ASSEMBLY	593393
FRONT HOUSING	593629
PULLEY	593597
REGULATOR + COVER	593944
ROTOR	593570
STATOR	593580

Valeo

439298/437224

SG12B024

120

1

6V

14



60°

Ø 51

INC

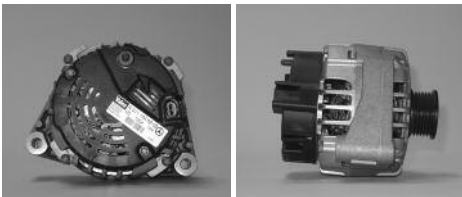

FRONT BEARING	593563
REAR BEARING	593564
PROTECTION COVER	593553
RECTIFIER OR DIODE BRIDGE ASSEMBLY	593393
FRONT HOUSING	593629
PULLEY	593597
REGULATOR + COVER	593943
ROTOR	593570
STATOR	593580

Valeo

439307/437312

SG12B025

120

2

6V

14



60°

Ø 66

INC

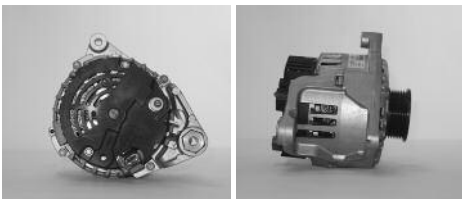

FRONT BEARING	593563
REAR BEARING	593564
PROTECTION COVER	593834
SEP:SEPARATED REGULATOR -INC:BUILT-IN REGULATOR	595452
RECTIFIER OR DIODE BRIDGE ASSEMBLY	593542
FRONT HOUSING	593627
PULLEY	593593
REGULATOR + COVER	595229
ROTOR	593570
STATOR	593580

Valeo

439260/437173

SG12B027

120

1

6V

14



60°

Ø 49

INC

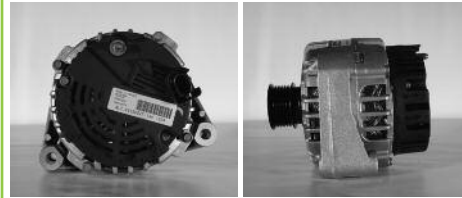

FRONT BEARING	593563
REAR BEARING	593564
PROTECTION COVER	593553
RECTIFIER OR DIODE BRIDGE ASSEMBLY	593393
FRONT HOUSING	593629
PULLEY	593598
REGULATOR + COVER	593944
ROTOR	593570
STATOR	593580

Valeo

439299/437225

SG12B028

120

1

6V

14



60°

Ø 49

INC

Picture not available
Image non disponible
Imagen no disponible
Immagine non disponibile
Nicht verfügbares Bild
Brak zdjęcia
Картина недоступна

Picture not available
Image non disponible
Imagen no disponible
Immagine non disponibile
Nicht verfügbares Bild
Brak zdjęcia
Картина недоступна

FRONT BEARING	593563
REAR BEARING	593564
PROTECTION COVER	593553
RECTIFIER OR DIODE BRIDGE ASSEMBLY	593393
FRONT HOUSING	593629
PULLEY	593598
REGULATOR + COVER	593943
ROTOR	593570
STATOR	593580

Valeo

439300/437226

SG12B029

120

2

6V

14



95°

Ø 51

INC



FRONT BEARING	593563
REAR BEARING	593564
SEP:SEPARATED REGULATOR -INC:BUILT-IN REGULATOR	593423
RECTIFIER OR DIODE BRIDGE ASSEMBLY	593464
FRONT HOUSING	593645
PULLEY	593602
ROTOR	593568
STATOR	593580

Valeo

439398/437367



SG12B030

125 2 6V

14 ↻ 90° ∅ 52,3 INC

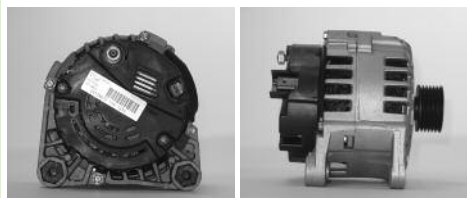

FRONT BEARING	↻ 21	593563
REAR BEARING	↻ 22	593564
PROTECTION COVER	↻ 24	593680
RECTIFIER OR DIODE BRIDGE ASSEMBLY	↻ 07	593830
FRONT HOUSING	↻ 31	593632
REGULATOR + COVER	↻ 02+24	593937
ROTOR	↻ 04	593569
STATOR	↻ 05	593580
Valeo		439464/437423

SG12B038 SP

120 2

14 ↻ 90° INC

Picture not available
Image non disponible
Imagem no disponibile
Immagine non disponibile
Nicht verfügbares Bild
Brak zdjęcia
Картина недоступна

Picture not available
Image non disponible
Imagem no disponibile
Immagine non disponibile
Nicht verfügbares Bild
Brak zdjęcia
Картина недоступна

FRONT BEARING	↻ 21	593563
REAR BEARING	↻ 22	593564
PROTECTION COVER	↻ 24	593680
RECTIFIER OR DIODE BRIDGE ASSEMBLY	↻ 07	593830
FRONT HOUSING	↻ 31	593632
REGULATOR + COVER	↻ 02+24	593937
ROTOR	↻ 04	593569
STATOR	↻ 05	593580
Valeo		440236

SG12B039

120 2 6V

14 ↻ 95° ∅ 54,2 INC

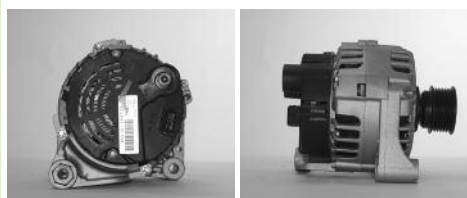

FRONT BEARING	↻ 21	593563
REAR BEARING	↻ 22	593564
PROTECTION COVER	↻ 24	593425
SEP:SEPARATED REGULATOR -INC:BUILT-IN REGULATOR	↻ 02	593423
RECTIFIER OR DIODE BRIDGE ASSEMBLY	↻ 07	593464
FRONT HOUSING	↻ 31	593645
PULLEY	↻ 11	593601
ROTOR	↻ 04	593570
STATOR	↻ 05	593580
Valeo		439317/437320

SG12B040

120 2 6V

14 ↻ 20° ∅ 60 INC

**B+(M8)
L(M5)**

FRONT BEARING	↻ 21	593674
REAR BEARING	↻ 22	593564
SEP:SEPARATED REGULATOR -INC:BUILT-IN REGULATOR	↻ 02	593434
RECTIFIER OR DIODE BRIDGE ASSEMBLY	↻ 07	593447
FRONT HOUSING	↻ 31	593652
PULLEY	↻ 11	593608
REGULATOR + COVER	↻ 02+24	593967
ROTOR	↻ 04	593570
STATOR	↻ 05	593580
Valeo		439339/437349

SG12B041

125 3 6V

14 ↻ 35° ∅ 57,81

Picture not available
Image non disponible
Imagem no disponibile
Immagine non disponibile
Nicht verfügbares Bild
Brak zdjęcia
Картина недоступна

Picture not available
Image non disponible
Imagem no disponibile
Immagine non disponibile
Nicht verfügbares Bild
Brak zdjęcia
Картина недоступна

FRONT BEARING	↻ 21	593563
REAR BEARING	↻ 22	593564
STATOR	↻ 05	593580
Valeo		439316

SG12B042

120 2 6V

14 ↻ 90° ∅ 49,08 INC



FRONT BEARING	↻ 21	593563
REAR BEARING	↻ 22	593564
PROTECTION COVER	↻ 24	*593417
PROTECTION COVER	↻ 24	593848
SEP:SEPARATED REGULATOR -INC:BUILT-IN REGULATOR	↻ 02	593480
RECTIFIER OR DIODE BRIDGE ASSEMBLY	↻ 07	593415
FRONT HOUSING	↻ 31	593632
PULLEY	↻ 11	593603
REGULATOR + COVER	↻ 02+24	593940
ROTOR	↻ 04	593570
STATOR	↻ 05	593580
Valeo		439326/437339

SG12B044

120

6V

14



Ø 49

INC

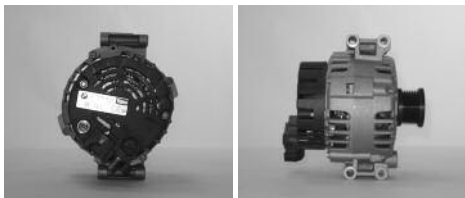

FRONT BEARING 21 593563
 REAR BEARING 22 593564
 PROTECTION COVER 24 593471
 RECTIFIER OR DIODE BRIDGE ASSEMBLY 07 593472
 FRONT HOUSING 31 593649
 PULLEY 11 593607
 ROTOR 04 593568
 STATOR 05 593580

Valeo**439419/437375****SG12B047**

120

6V

14



Ø 57,2

INC

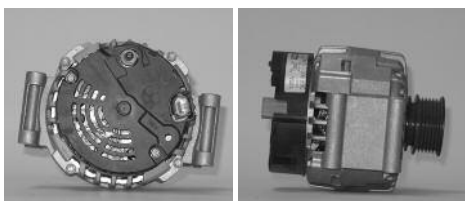

FRONT BEARING 21 593563
 REAR BEARING 22 593564
 PROTECTION COVER 24 *593417
 PROTECTION COVER 24 593848
 RECTIFIER OR DIODE BRIDGE ASSEMBLY 07 593979
 FRONT HOUSING 31 593642
 PULLEY FREE WEEL + CAP PROTECTION 11c 593494
 REGULATOR + COVER 02+24 593940
 ROTOR 04 593570
 STATOR 05 593580

Valeo**439395/437364****SG12B049**

120

2

5V RL

14



90°

Ø 57,2

INC

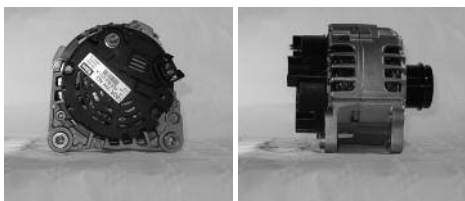

FRONT BEARING 21 593563
 REAR BEARING 22 593564
 PROTECTION COVER 24 593834
 RECTIFIER OR DIODE BRIDGE ASSEMBLY 07 593547
 PULLEY FREE WEEL + CAP PROTECTION 11c 593490
 REGULATOR + COVER 02+24 593941
 ROTOR 04 593570
 STATOR 05 593580

Valeo**439328/437341****SG12B050**

120

4

5V

14



90°

Ø 50,08

INC

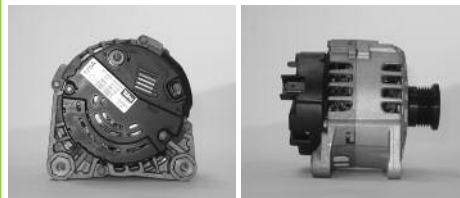

FRONT BEARING 21 593563
 REAR BEARING 22 593564
 PROTECTION COVER 24 593680
 RECTIFIER OR DIODE BRIDGE ASSEMBLY 07 593830
 FRONT HOUSING 31 593632
 PULLEY FREE WEEL + CAP PROTECTION 11c 593516
 REGULATOR + COVER 02+24 593937
 ROTOR 04 593570
 STATOR 05 593580

Valeo**439341/437351****SG12B052**

125

2

7V

14



90°

Ø 52,3

INC

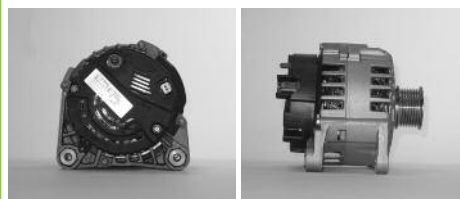

FRONT BEARING 21 593563
 REAR BEARING 22 593564
 PROTECTION COVER 24 593680
 SEP:SEPARATED REGULATOR -INC:BUILT-IN REGULATOR 02 593689
 RECTIFIER OR DIODE BRIDGE ASSEMBLY 07 593830
 FRONT HOUSING 31 593632
 PULLEY 11 593836
 REGULATOR + COVER 02+24 593935
 ROTOR 04 593569

Valeo**439478/437437****SG12B054**

120

2

6V

14



60°

Ø 66

INC



FRONT BEARING 21 593563
 REAR BEARING 22 593564
 PROTECTION COVER 24 593834
 RECTIFIER OR DIODE BRIDGE ASSEMBLY 07 593542
 FRONT HOUSING 31 593627
 PULLEY 11 593593
 REGULATOR + COVER 02+24 593941
 ROTOR 04 593570
 STATOR 05 593580

Valeo**439391/437358**

SG12B055

125 2 6V

14 ↻ 90° ∅ 59,4 INC

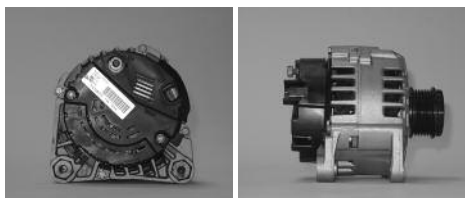

FRONT BEARING 21 593563
 REAR BEARING 22 593564
 PROTECTION COVER 24 593680
 SEP:SEPARATED REGULATOR -INC:BUILT-IN REGULATOR 02 593689
 RECTIFIER OR DIODE BRIDGE ASSEMBLY 07 593830
 FRONT HOUSING 31 593632
 PULLEY FREE WEEL + CAP PROTECTION 11c 593517
 REGULATOR + COVER 02+24 593935
 ROTOR 04 593570
 STATOR 05 593580

Valeo

439394/437361

SG12B060

120 1 8V

14 ↻ 0° ∅ 51 INC



FRONT BEARING 21 593563
 REAR BEARING 22 593564
 PROTECTION COVER 24 593553
 RECTIFIER OR DIODE BRIDGE ASSEMBLY 07 593393
 FRONT HOUSING 31 593629
 PULLEY 11 593605
 REGULATOR + COVER 02+24 593944
 ROTOR 04 593570
 STATOR 05 593580

Valeo

439420/437376

SG12B062

120 7V RL

14 ↻ ∅ 57 INC



FRONT BEARING 21 593563
 REAR BEARING 22 593564
 PROTECTION COVER 24 593553
 SEP:SEPARATED REGULATOR -INC:BUILT-IN REGULATOR 02 593873
 RECTIFIER OR DIODE BRIDGE ASSEMBLY 07 593393
 FRONT HOUSING 31 593659
 PULLEY FREE WEEL + CAP PROTECTION 11c 595258
 ROTOR 04 593570
 STATOR 05 593580

Valeo

439471/437430

SG12B063

120 1 7V

14 ↻ 60° ∅ 53,1 INC

B+(M8)
L(M5)

FRONT BEARING 21 593563
 REAR BEARING 22 593564
 PROTECTION COVER 24 593672
 SEP:SEPARATED REGULATOR -INC:BUILT-IN REGULATOR 02 593550
 RECTIFIER OR DIODE BRIDGE ASSEMBLY 07 593393
 FRONT HOUSING 31 593629
 PULLEY 11 593621
 ROTOR 04 593570
 STATOR 05 593580

Valeo

439468/437425

SG12B065

120 6V

14 ↻ ∅ 50,3 INC



FRONT BEARING 21 593563
 REAR BEARING 22 593564
 PROTECTION COVER 24 593471
 SEP:SEPARATED REGULATOR -INC:BUILT-IN REGULATOR 02 595336
 RECTIFIER OR DIODE BRIDGE ASSEMBLY 07 593472
 FRONT HOUSING 31 593649
 PULLEY FREE WEEL + CAP PROTECTION 11c 595203
 ROTOR 04 593568
 STATOR 05 593580

Valeo

439419/437375

SG12B068

125 2 6V

14 ↻ 90° ∅ 52,3 INC

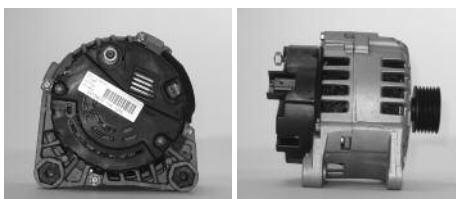







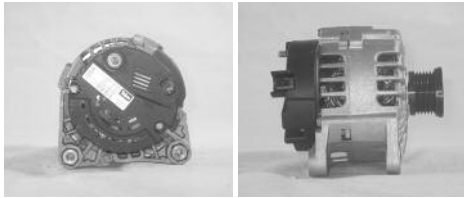



FRONT BEARING 21 593563
 REAR BEARING 22 593564
 PROTECTION COVER 24 593680
 RECTIFIER OR DIODE BRIDGE ASSEMBLY 07 593830
 FRONT HOUSING 31 593632
 REGULATOR + COVER 02+24 593935
 ROTOR 04 593569
 STATOR 05 593580









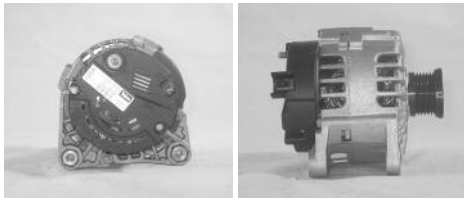

Valeo

439464/437423

SG12B071 120 4 6V / 7V RL14  90°  Ø 50,08 INC







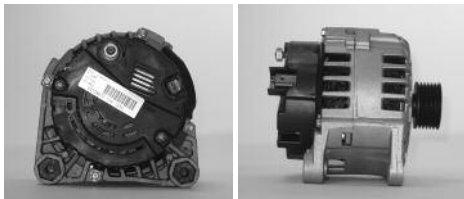

FRONT BEARING 	21	593563
REAR BEARING 	22	593564
PROTECTION COVER 	24	593680
SEP:SEPARATED REGULATOR -INC:BUILT-IN REGULATOR 	02	593689
RECTIFIER OR DIODE BRIDGE ASSEMBLY 	07	593830
FRONT HOUSING 	31	593632
PULLEY FREE WEEL + CAP PROTECTION 	11c	593514
PULLEY FREE WEEL + CAP PROTECTION 	11c	*593554
REGULATOR + COVER 	02+24	593935
ROTOR 	04	593570
STATOR 	05	593580

SG12B071 120 4 6V / 7V RL14  90°  Ø 50,08 INC

FRONT BEARING 	21	593563
REAR BEARING 	22	593564
PROTECTION COVER 	24	593680
SEP:SEPARATED REGULATOR -INC:BUILT-IN REGULATOR 	02	593689
RECTIFIER OR DIODE BRIDGE ASSEMBLY 	07	593830
FRONT HOUSING 	31	593632
PULLEY FREE WEEL + CAP PROTECTION 	11c	593514
PULLEY FREE WEEL + CAP PROTECTION 	11c	*593554
REGULATOR + COVER 	02+24	593935
ROTOR 	04	593570
STATOR 	05	593580







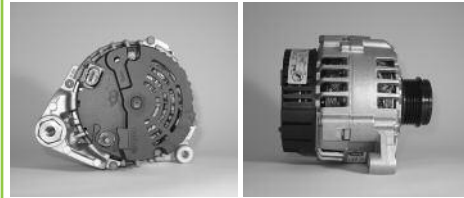

Valeo 439292/437208

SG12B072 125 4 6V14  90°  Ø 50,48 INC

FRONT BEARING 	21	593563
REAR BEARING 	22	593564
PROTECTION COVER 	24	593386
PROTECTION COVER 	24	593680
SEP:SEPARATED REGULATOR -INC:BUILT-IN REGULATOR 	02	593689
RECTIFIER OR DIODE BRIDGE ASSEMBLY 	07	593830
FRONT HOUSING 	31	593632
REGULATOR + COVER 	02+24	593935
ROTOR 	04	593569

Valeo 439464/437423

SG12B074 120 1 5V14  60°  Ø 57,2 INC

FRONT BEARING 	21	593563
REAR BEARING 	22	593564
PROTECTION COVER 	24	593834
RECTIFIER OR DIODE BRIDGE ASSEMBLY 	07	593542
FRONT HOUSING 	31	593627
PULLEY FREE WEEL + CAP PROTECTION 	11c	593490
REGULATOR + COVER 	02+24	593941
ROTOR 	04	593570
STATOR 	05	593580



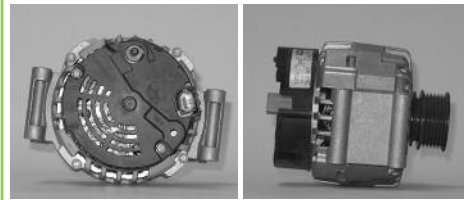





Valeo 439462/437420

SG12B075 120 6V RL14  Ø 57,2 INC

FRONT BEARING 	21	593563
REAR BEARING 	22	593564
PROTECTION COVER 	24	593834
SEP:SEPARATED REGULATOR -INC:BUILT-IN REGULATOR 	02	593480
RECTIFIER OR DIODE BRIDGE ASSEMBLY 	07	593393
FRONT HOUSING 	31	593659
PULLEY FREE WEEL + CAP PROTECTION 	11c	593778
REGULATOR + COVER 	02+24	593941
ROTOR 	04	593570

Valeo 439395/437364

SG12B080 120 2 5V14  35°  Ø 54,8 INC

FRONT BEARING 	21	593563
REAR BEARING 	22	593564
PROTECTION COVER 	24	593425
SEP:SEPARATED REGULATOR -INC:BUILT-IN REGULATOR 	02	593846
RECTIFIER OR DIODE BRIDGE ASSEMBLY 	07	593464
FRONT HOUSING 	31	593645
PULLEY 	11	593755
ROTOR 	04	593570

Valeo 439301/437227



SG12B081

125

4

7V

14



90°

Ø 56,4

INC

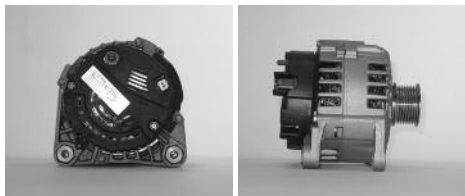

FRONT BEARING	593563
REAR BEARING	593564
PROTECTION COVER	593680
SEP:SEPARATED REGULATOR -INC:BUILT-IN REGULATOR	02593689
RECTIFIER OR DIODE BRIDGE ASSEMBLY	07 593830
FRONT HOUSING	31 593632
PULLEY	11 593836
ROTOR	04 593569

Valeo

439478/437437

SG12B082

120

1

7V

14



60°

Ø 53,1

INC

B+(M8)
L(M5)

FRONT BEARING	21 593563
REAR BEARING	22 593564
PROTECTION COVER	24 593672
SEP:SEPARATED REGULATOR -INC:BUILT-IN REGULATOR	02593550
RECTIFIER OR DIODE BRIDGE ASSEMBLY	07 593393
FRONT HOUSING	31 593629
PULLEY	11 593621
ROTOR	04 593568
ROTOR	04 593570
STATOR	05 593580

Valeo

439468/437425

SG12B087

120

6V

14



Ø 50,3

INC

B+(M8)D+(M5)
W(M5)

FRONT BEARING	21 593563
REAR BEARING	22 593564
PROTECTION COVER	24 593672
SEP:SEPARATED REGULATOR -INC:BUILT-IN REGULATOR	02593966
RECTIFIER OR DIODE BRIDGE ASSEMBLY	07 593393
FRONT HOUSING	31 593659
PULLEY FREE WEEL + CAP PROTECTION	11c 593537
ROTOR	04 593570
STATOR	05 593580

SG12B087

120

6V

14



Ø 50,3

INC

B+(M8)D+(M5)
W(M5)

FRONT BEARING	21 593563
REAR BEARING	22 593564
PROTECTION COVER	24 593672
SEP:SEPARATED REGULATOR -INC:BUILT-IN REGULATOR	02593966
RECTIFIER OR DIODE BRIDGE ASSEMBLY	07 593393
FRONT HOUSING	31 593659
PULLEY FREE WEEL + CAP PROTECTION	11c 593537
ROTOR	04 593570
STATOR	05 593580

Valeo

439540/437625

SG12B089

125

4

6V

14



90°

Ø 56,28

INC

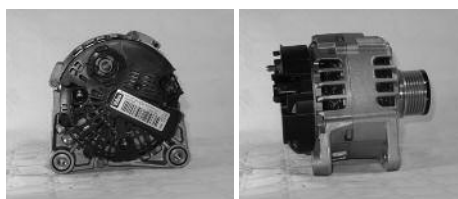

FRONT BEARING	21 593563
REAR BEARING	22 593564
PROTECTION COVER	24 593680
SEP:SEPARATED REGULATOR -INC:BUILT-IN REGULATOR	02593546
RECTIFIER OR DIODE BRIDGE ASSEMBLY	07 593830
FRONT HOUSING	31 593632
PULLEY FREE WEEL + CAP PROTECTION	11c *595407
ROTOR	04 593570

Valeo

439562/437559

SG12B090

120

2

6V

14



90°

Ø 57,2

INC

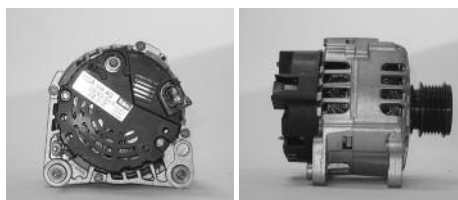

FRONT BEARING	21 593563
REAR BEARING	22 593564
PROTECTION COVER	24 593848
SEP:SEPARATED REGULATOR -INC:BUILT-IN REGULATOR	02593813
RECTIFIER OR DIODE BRIDGE ASSEMBLY	07 593415
FRONT HOUSING	31 593632
PULLEY FREE WEEL + CAP PROTECTION	11c 593600
ROTOR	04 593570
STATOR	05 593580

Valeo

439312/437317

SG12B092

120

4

7V

14



90°

Ø 50,48

INC

Picture not available
Image non disponible
Imagem no disponibile
Immagine non disponibile
Nicht verfügbares Bild
Brak zdjęcia
Картина недоступна

Picture not available
Image non disponible
Imagem no disponibile
Immagine non disponibile
Nicht verfügbares Bild
Brak zdjęcia
Картина недоступна

FRONT BEARING 21

593563

REAR BEARING 22

593564

PROTECTION COVER 24

595235

SEP:SEPARATED REGULATOR -INC:BUILT-IN REGULATOR 02 595252**RECTIFIER OR DIODE BRIDGE ASSEMBLY** 07

595247

FRONT HOUSING 31

593632

PULLEY 11

593836

ROTOR 04

593570

STATOR 05

595248

Valeo**439587/440059****SG12B095**

125

4

5V

14



90°

Ø 50,08

INC

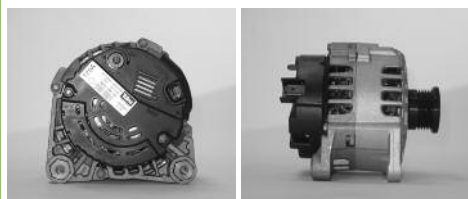
**FRONT BEARING** 21

593563

REAR BEARING 22

593564

PROTECTION COVER 24

593680

SEP:SEPARATED REGULATOR -INC:BUILT-IN REGULATOR 02 593546**RECTIFIER OR DIODE BRIDGE ASSEMBLY** 07

593830

FRONT HOUSING 31

593632

PULLEY FREE WEEL + CAP PROTECTION 11c

593516

ROTOR 04

593570

Valeo**439341/437351****SG12B096**

125

4

6V / 7V RL

14



90°

Ø 50,08

INC

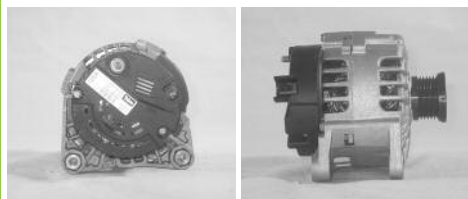
**FRONT BEARING** 21

593563

REAR BEARING 22

593564

PROTECTION COVER 24

593680

SEP:SEPARATED REGULATOR -INC:BUILT-IN REGULATOR 02 593689**RECTIFIER OR DIODE BRIDGE ASSEMBLY** 07

593830

FRONT HOUSING 31

593632

PULLEY FREE WEEL + CAP PROTECTION 11c

593514

ROTOR 04

593570

Valeo**439292/437208****SG12B097**

125

4

6V

14



90°

Ø 50,48

INC

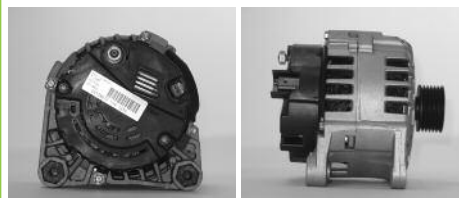
**FRONT BEARING** 21

593563

REAR BEARING 22

593564

PROTECTION COVER 24

593680

SEP:SEPARATED REGULATOR -INC:BUILT-IN REGULATOR 02 593689**RECTIFIER OR DIODE BRIDGE ASSEMBLY** 07

593830

FRONT HOUSING 31

593632

ROTOR 04

593569

Valeo**439464/437423****SG12B098**

125

4

7V

14



90°

Ø 56,4

INC

**FRONT BEARING** 21

593563

REAR BEARING 22

593564

PROTECTION COVER 24

593680

SEP:SEPARATED REGULATOR -INC:BUILT-IN REGULATOR 02 593689**RECTIFIER OR DIODE BRIDGE ASSEMBLY** 07

593830

FRONT HOUSING 31

593632

PULLEY 11

593836

ROTOR 04

593569

Valeo**439478/437437****SG12B105**

120

4

6V RL

14



90°

Ø 56,47

INC

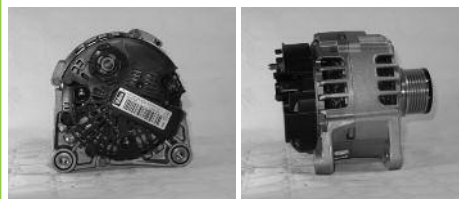
**FRONT BEARING** 21

593563

REAR BEARING 22

593564

PROTECTION COVER 24

595235

SEP:SEPARATED REGULATOR -INC:BUILT-IN REGULATOR 02 593689**RECTIFIER OR DIODE BRIDGE ASSEMBLY** 07

595247

FRONT HOUSING 31

593632

PULLEY FREE WEEL + CAP PROTECTION 11c

*595407

ROTOR 04

593570

STATOR 05

595248

SG12B105

120

4

6V RL

14



90°

Ø 56,47

INC



FRONT BEARING	593563
REAR BEARING	593564
PROTECTION COVER	595235
SEP:SEPARATED REGULATOR -INC:BUILT-IN REGULATOR	02593689
RECTIFIER OR DIODE BRIDGE ASSEMBLY	595247
FRONT HOUSING	593632
PULLEY FREE WHEEL + CAP PROTECTION	*595407
ROTOR	593570
STATOR	595248

Valeo**439584/440056****SG12B107**

125

4

6V

14



90°

Ø 50,48

INC

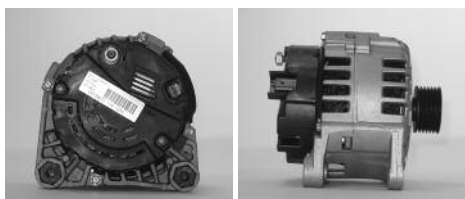

FRONT BEARING	593563
REAR BEARING	593564
PROTECTION COVER	595235
SEP:SEPARATED REGULATOR -INC:BUILT-IN REGULATOR	02593689
RECTIFIER OR DIODE BRIDGE ASSEMBLY	595247
FRONT HOUSING	593632
ROTOR	593570
STATOR	595248

Valeo**439464/437423****SG12B108**

120

4

5V RL

14



90°

Ø 50,08

INC



FRONT BEARING	593563
REAR BEARING	593564
PROTECTION COVER	595235
SEP:SEPARATED REGULATOR -INC:BUILT-IN REGULATOR	02593546
RECTIFIER OR DIODE BRIDGE ASSEMBLY	595247
FRONT HOUSING	593632
PULLEY FREE WHEEL + CAP PROTECTION	593516
ROTOR	593570
STATOR	595248

Valeo**439341/437351****SG12B109**

120

4

7V

14



90°

Ø 50,48

INC



FRONT BEARING	593563
REAR BEARING	593564
PROTECTION COVER	595235
SEP:SEPARATED REGULATOR -INC:BUILT-IN REGULATOR	02593689
RECTIFIER OR DIODE BRIDGE ASSEMBLY	595247
FRONT HOUSING	593632
PULLEY	593836
ROTOR	593570
STATOR	595248

Valeo**439478/437437****SG12B110**

120

4

6V / 7V RL

14



90°

Ø 50,08

INC

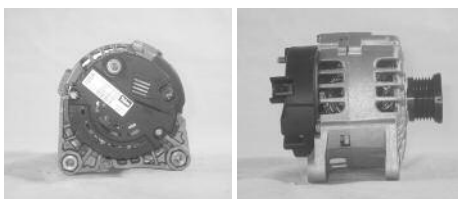

FRONT BEARING	593563
REAR BEARING	593564
PROTECTION COVER	595235
SEP:SEPARATED REGULATOR -INC:BUILT-IN REGULATOR	02593689
RECTIFIER OR DIODE BRIDGE ASSEMBLY	595247
FRONT HOUSING	593632
PULLEY FREE WHEEL + CAP PROTECTION	593514
ROTOR	593570
STATOR	595248

Valeo**439292/437208****SG12B116**

120

4

5V RL

14



90°

Ø 50,08

INC

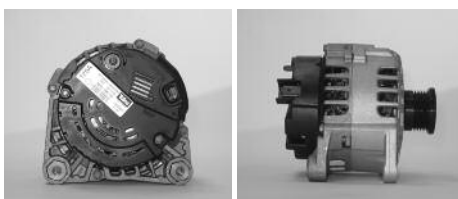

FRONT BEARING	593563
REAR BEARING	593564
PROTECTION COVER	595235
SEP:SEPARATED REGULATOR -INC:BUILT-IN REGULATOR	02593546
RECTIFIER OR DIODE BRIDGE ASSEMBLY	595247
FRONT HOUSING	593632
PULLEY FREE WHEEL + CAP PROTECTION	593516
ROTOR	593570
STATOR	595248

Valeo**439341/437351**

SG12B122

120

4

6V

14



90°

Ø 50,48

INC



FRONT BEARING	21	593563
REAR BEARING	22	593564
PROTECTION COVER	24	595235
SEP:SEPARATED REGULATOR -INC:BUILT-IN REGULATOR	02	593689
RECTIFIER OR DIODE BRIDGE ASSEMBLY	07	595247
FRONT HOUSING	31	593632
ROTOR	04	593570
STATOR	05	595248

Valeo

439464/437423

SG12B123

120

4

6V / 7V RL

14



90°

Ø 50,08

INC

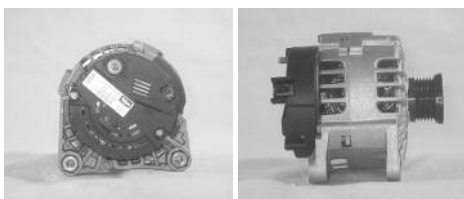

FRONT BEARING	21	593563
REAR BEARING	22	593564
PROTECTION COVER	24	595235
SEP:SEPARATED REGULATOR -INC:BUILT-IN REGULATOR	02	593689
RECTIFIER OR DIODE BRIDGE ASSEMBLY	07	595247
FRONT HOUSING	31	593632
PULLEY FREE WHEEL + CAP PROTECTION	11c	593514
ROTOR	04	593570
STATOR	05	595248

Valeo

439292/437208

SG12B124

120

4

7V

14



90°

Ø 50,38

INC

Picture not available
Image non disponible
Imagen no disponible
Immagine non disponibile
Nicht verfügbares Bild
Brak zdjęcia
Картина недоступна

Picture not available
Image non disponible
Imagen no disponible
Immagine non disponibile
Nicht verfügbares Bild
Brak zdjęcia
Картина недоступна

FRONT BEARING	21	593563
REAR BEARING	22	593564
PROTECTION COVER	24	595235
SEP:SEPARATED REGULATOR -INC:BUILT-IN REGULATOR	02	595252
RECTIFIER OR DIODE BRIDGE ASSEMBLY	07	595247
FRONT HOUSING	31	593632
PULLEY	11	593836
ROTOR	04	593570
STATOR	05	595248

Valeo

439587/440059

SG12B127

120

4

6V

14



90°

Ø 50,5

INC



FRONT BEARING	21	593563
REAR BEARING	22	593564
PROTECTION COVER	24	*595452
SEP:SEPARATED REGULATOR -INC:BUILT-IN REGULATOR	02*	595450
RECTIFIER OR DIODE BRIDGE ASSEMBLY	07	593415
PULLEY	11	592920
ROTOR	04	593570

Valeo

439669/437392

SG12S019

120

2

6V

14



40°

Ø 54,4

INC

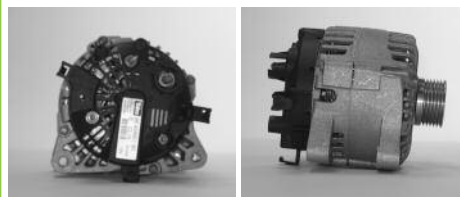
B+(M8)
L(M5)

FRONT BEARING	21	593563
REAR BEARING	22	593564
PROTECTION COVER	24	593436
SEP:SEPARATED REGULATOR -INC:BUILT-IN REGULATOR	02	593434
RECTIFIER OR DIODE BRIDGE ASSEMBLY	07	593435
FRONT HOUSING	31	593636
PULLEY	11	593613
ROTOR	04	593570
STATOR	05	593580

Valeo

439470/437328

SG12S073

120

6V

14



Ø 48

INC

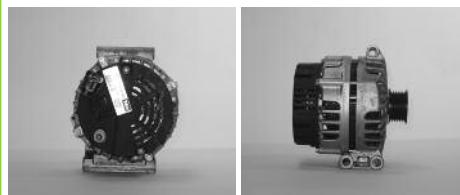

FRONT BEARING	21	593563
REAR BEARING	22	593564
PROTECTION COVER	24	593553
SEP:SEPARATED REGULATOR -INC:BUILT-IN REGULATOR	02	593551
RECTIFIER OR DIODE BRIDGE ASSEMBLY	07	593552
FRONT HOUSING	31	593656
PULLEY	11	593622
ROTOR	04	593876
STATOR	05	593580

Valeo

439469/437426

SG14B010

140

6V

14



Ø 57,2

INC



FRONT BEARING	593563
REAR BEARING	593564
PROTECTION COVER	*593417
PROTECTION COVER	593848
RECTIFIER OR DIODE BRIDGE ASSEMBLY	593979
FRONT HOUSING	593642
PULLEY FREE WHEEL + CAP PROTECTION	593494
REGULATOR + COVER	593940
ROTOR	593569
STATOR	593591

Valeo**439393/437360****SG14B013**

140

2

6V

14



60°

Ø 66

INC

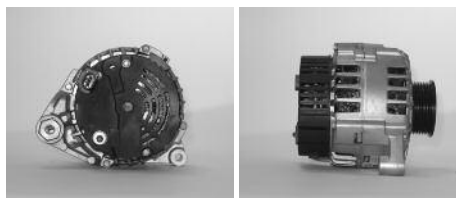

FRONT BEARING	593563
REAR BEARING	593564
PROTECTION COVER	593834
RECTIFIER OR DIODE BRIDGE ASSEMBLY	593542
FRONT HOUSING	593627
PULLEY	593593
REGULATOR + COVER	595229
ROTOR	593569
STATOR	593591

Valeo**439460/437418****SG14B011**

140

2

5V

14



90°

Ø 57,2

INC

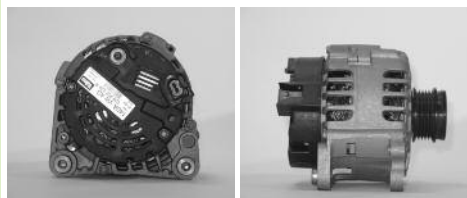

FRONT BEARING	593563
REAR BEARING	593564
PROTECTION COVER	593834
RECTIFIER OR DIODE BRIDGE ASSEMBLY	593547
FRONT HOUSING	593632
PULLEY FREE WHEEL + CAP PROTECTION	593490
REGULATOR + COVER	593941
ROTOR	593569
STATOR	593591

Valeo**439421/437377****SG14B016**

140

6V

14



Ø 57,2

INC



FRONT BEARING	593563
REAR BEARING	593564
PROTECTION COVER	593834
SEP:SEPARATED REGULATOR -INC:BUILT-IN REGULATOR	593480
RECTIFIER OR DIODE BRIDGE ASSEMBLY	593393
FRONT HOUSING	593659
PULLEY FREE WHEEL + CAP PROTECTION	593778
REGULATOR + COVER	593941
ROTOR	593569
STATOR	593591

Valeo**439393/437360****SG14B012**

140

2

6V

14



60°

Ø 66

INC



FRONT BEARING	593563
REAR BEARING	593564
PROTECTION COVER	593834
RECTIFIER OR DIODE BRIDGE ASSEMBLY	593542
FRONT HOUSING	593627
PULLEY	593593
REGULATOR + COVER	593941
ROTOR	593569
STATOR	593591

Valeo**439392/437359****SG14B017**

140

6V

14



Ø 49



FRONT BEARING	593563
REAR BEARING	593564
PROTECTION COVER	593471
SEP:SEPARATED REGULATOR -INC:BUILT-IN REGULATOR	*595334
RECTIFIER OR DIODE BRIDGE ASSEMBLY	593472
FRONT HOUSING	593649
PULLEY FREE WHEEL + CAP PROTECTION	595203
ROTOR	593570
STATOR	593591

Valeo**439476/437435**

SG14B019

140

2

6V

14



33°

Ø 51

INC



FRONT BEARING 21 593563
 REAR BEARING 22 593564
 SEP:SEPARATED REGULATOR -INC:BUILT-IN REGULATOR 02 593423
 RECTIFIER OR DIODE BRIDGE ASSEMBLY 07 593464
 FRONT HOUSING 31 593645
 PULLEY 11 593602
 PROTECTION COVER 24 593870
 ROTOR 04 593569
 STATOR 05 593591

Valeo**439507/437500****SG14B020**

140

2

6V

14



33°

Ø 51

INC



FRONT BEARING 21 593563
 REAR BEARING 22 593564
 RECTIFIER OR DIODE BRIDGE ASSEMBLY 07 593464
 FRONT HOUSING 31 593645
 PULLEY 11 593602
 PROTECTION COVER 24 593870
 ROTOR 04 593569
 STATOR 05 593591

Valeo**439507/437500****SG14B022**

140

6V RL

14



Ø 57,2

INC



FRONT BEARING 21 593563
 REAR BEARING 22 593564
 PROTECTION COVER 24 593834
 RECTIFIER OR DIODE BRIDGE ASSEMBLY 07 593393
 FRONT HOUSING 31 593659
 PULLEY FREE WEEL + CAP PROTECTION 11c 593778
 REGULATOR + COVER 02+24 593940
 ROTOR 04 593569
 STATOR 05 593591

Valeo**439393/437360****SG15L012**

150

5V

14



Ø 51

INC

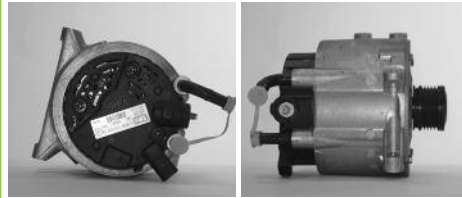

FRONT BEARING 21 593563
 REAR BEARING 22 593684
 PROTECTION COVER 24 593513
 SEP:SEPARATED REGULATOR -INC:BUILT-IN REGULATOR 02 593779
 RECTIFIER OR DIODE BRIDGE ASSEMBLY 07 593512
 FRONT HOUSING 31 593867
 PULLEY FREE WEEL + CAP PROTECTION 11c 599104
 ROTOR 04 593681

Valeo**439455/437415****SG15L020**

155

4

7V

14



90°

Ø 52,3

INC

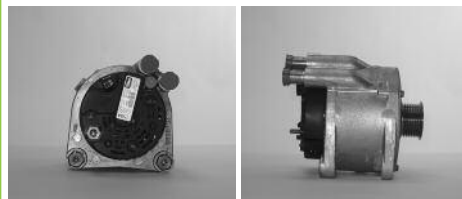

FRONT BEARING 21 593674
 REAR BEARING 22 593684
 PROTECTION COVER 24 593669
 SEP:SEPARATED REGULATOR -INC:BUILT-IN REGULATOR 02 593666
 RECTIFIER OR DIODE BRIDGE ASSEMBLY 07 593667
 FRONT HOUSING 31 593867
 PULLEY 11 593836
 REAR BRACKET + STATOR 30+05 595227
 ROTOR 04 593681

Valeo**439474/437433****SG15L023**

155

4

7V

14



90°

Ø 50,08

INC

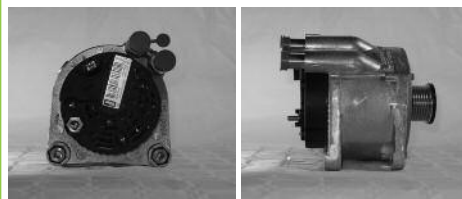

FRONT BEARING 21 593563
 REAR BEARING 22 593684
 PROTECTION COVER 24 593669
 SEP:SEPARATED REGULATOR -INC:BUILT-IN REGULATOR 02 593666
 RECTIFIER OR DIODE BRIDGE ASSEMBLY 07 593667
 FRONT HOUSING 31 593867
 PULLEY FREE WEEL + CAP PROTECTION 11c 595226
 REAR BRACKET + STATOR 30+05 *593682
 ROTOR 04 593681

Valeo**439571/440012**

SG15L026

150

5V

14



Ø 51

INC

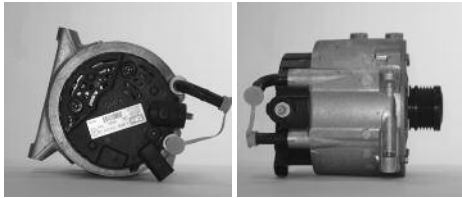

FRONT BEARING 21 593563
 REAR BEARING 22 593684
 PROTECTION COVER 24 593513
 SEP:SEPARATED REGULATOR -INC:BUILT-IN REGULATOR 02 593779
 RECTIFIER OR DIODE BRIDGE ASSEMBLY 07 593512
 FRONT HOUSING 31 593867
 PULLEY FREE WEEL + CAP PROTECTION 11c 599104
 ROTOR 04 593681

Valeo**439455/437415****SG15L027**

150

4

7V

14



Ø 52,3

INC

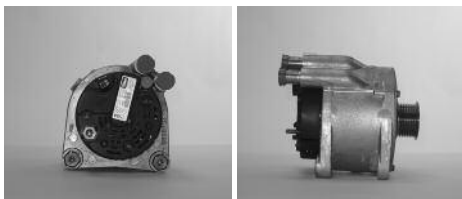

FRONT BEARING 21 593563
 REAR BEARING 22 593684
 PROTECTION COVER 24 593669
 SEP:SEPARATED REGULATOR -INC:BUILT-IN REGULATOR 02 593666
 RECTIFIER OR DIODE BRIDGE ASSEMBLY 07 593667
 FRONT HOUSING 31 593867
 PULLEY 11 593836
 REAR BRACKET + STATOR 30+05 *593682
 ROTOR 04 593681

Valeo**439474/437433****SG15L033**

155

4

7V

14



Ø 50,08

INC

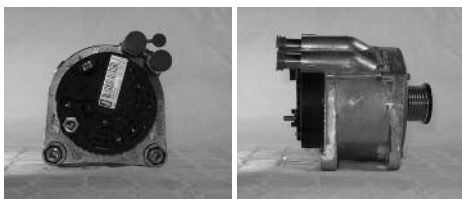

FRONT BEARING 21 593563
 REAR BEARING 22 593684
 PROTECTION COVER 24 593669
 SEP:SEPARATED REGULATOR -INC:BUILT-IN REGULATOR 02 593666
 RECTIFIER OR DIODE BRIDGE ASSEMBLY 07 593667
 FRONT HOUSING 31 593867
 PULLEY FREE WEEL + CAP PROTECTION 11c 595226
 REAR BRACKET + STATOR 30+05 595227
 ROTOR 04 593681

Valeo**439571/440012****SG15L034**

150

4

7V

14



Ø 52,3

INC

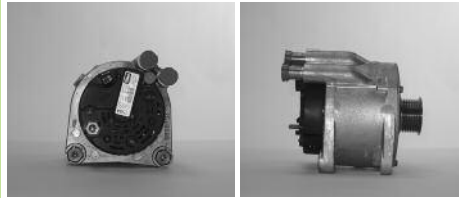

FRONT BEARING 21 593563
 REAR BEARING 22 593684
 PROTECTION COVER 24 593669
 SEP:SEPARATED REGULATOR -INC:BUILT-IN REGULATOR 02 593666
 RECTIFIER OR DIODE BRIDGE ASSEMBLY 07 593667
 FRONT HOUSING 31 593867
 PULLEY 11 593836
 REAR BRACKET + STATOR 30+05 595227
 ROTOR 04 593681

Valeo**439474/437433****SG15L035**

155

4

7V

14



Ø 50,38

INC

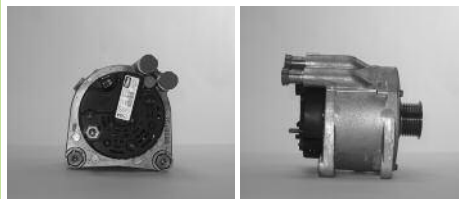

FRONT BEARING 21 593563
 REAR BEARING 22 593684
 PROTECTION COVER 24 593669
 SEP:SEPARATED REGULATOR -INC:BUILT-IN REGULATOR 02 593666
 RECTIFIER OR DIODE BRIDGE ASSEMBLY 07 *595382
 FRONT HOUSING 31 593867
 PULLEY 11 593836
 ROTOR 04 593681

Valeo**439474/437433****SG15L036**

155

4

7V RL

14



Ø 50,08

INC

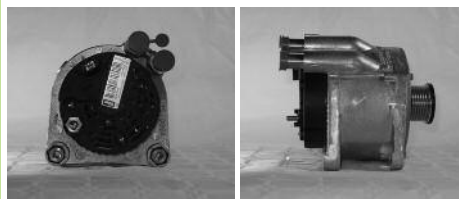

FRONT BEARING 21 593563
 REAR BEARING 22 593684
 PROTECTION COVER 24 593669
 SEP:SEPARATED REGULATOR -INC:BUILT-IN REGULATOR 02 593666
 RECTIFIER OR DIODE BRIDGE ASSEMBLY 07 *595382
 FRONT HOUSING 31 593867
 PULLEY FREE WEEL + CAP PROTECTION 11c 593514
 ROTOR 04 593681

Valeo**439571/440012**

SG15S010

150

2

6V

14



20°

Ø 60

INC

**B+(M8)**
L(M5)

FRONT BEARING 21 593674
REAR BEARING 22 593564
SEP:SEPARATED REGULATOR -INC:BUILT-IN REGULATOR 02 593290
RECTIFIER OR DIODE BRIDGE ASSEMBLY 07 593444
FRONT HOUSING 31 593646
PULLEY 11 593609
ROTOR 04 593285
STATOR 05 593286

Valeo**439340/437350****SG15S016**

150

4

6V

14



40°

Ø 57,5

INC

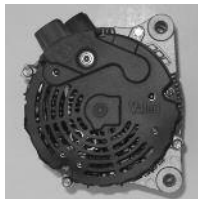
**B+(M8)**
L(M5)

FRONT BEARING 21 593674
REAR BEARING 22 593564
PROTECTION COVER 24 593528
SEP:SEPARATED REGULATOR -INC:BUILT-IN REGULATOR 02 593532
RECTIFIER OR DIODE BRIDGE ASSEMBLY 07 593526
FRONT HOUSING 31 593658
PULLEY 11 593620
ROTOR 04 593285
STATOR 05 593588

Valeo**439257/437171****SG15S017**

150

4

6V

14



40°

Ø 57,5

INC



FRONT BEARING 21 593563
REAR BEARING 22 593564
PROTECTION COVER 24 *599076
SEP:SEPARATED REGULATOR -INC:BUILT-IN REGULATOR 02 593773
RECTIFIER OR DIODE BRIDGE ASSEMBLY 07 593526
FRONT HOUSING 31 593658
PULLEY 11 593620
ROTOR 04 593285
STATOR 05 593588

Valeo**439477/437436****SG15S018**

150

4

6V RL

14



79°

Ø 57,5

INC

**B+(M8)D+(M5)**

FRONT BEARING 21 593563
REAR BEARING 22 593564
PROTECTION COVER 24 593528
SEP:SEPARATED REGULATOR -INC:BUILT-IN REGULATOR 02 593532
RECTIFIER OR DIODE BRIDGE ASSEMBLY 07 593526
FRONT HOUSING 31 593658
PULLEY FREE WEEL + CAP PROTECTION 11c 593907
ROTOR 04 593285
STATOR 05 593588

Valeo**439294/437210****SG15S019**

150

4

6V RL

14



79°

Ø 57,5

INC



FRONT BEARING 21 593563
REAR BEARING 22 593564
PROTECTION COVER 24 593677
RECTIFIER OR DIODE BRIDGE ASSEMBLY 07 593676
FRONT HOUSING 31 593678
PULLEY FREE WEEL + CAP PROTECTION 11c 593907
REGULATOR + COVER 02+24 *599123
ROTOR 04 593285
STATOR 05 593588

Valeo**439473/437432****SG15S021**

150

4

6V

14



40°

Ø 57,5

INC

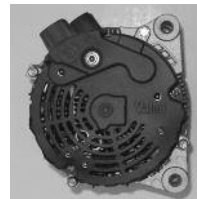
**B+(M8)**
L(M5)

FRONT BEARING 21 593674
REAR BEARING 22 593564
PROTECTION COVER 24 593528
SEP:SEPARATED REGULATOR -INC:BUILT-IN REGULATOR 02 593525
RECTIFIER OR DIODE BRIDGE ASSEMBLY 07 593526
FRONT HOUSING 31 593658
PULLEY 11 593620
ROTOR 04 593285
STATOR 05 593588

Valeo**439257/437171**

SG15S022

150

4

6V

14



40°

Ø 57,5

INC

**B+(M8)D+(M5)**

FRONT BEARING	↗ 21	593674
REAR BEARING	↗ 22	593564
PROTECTION COVER	↗ 24	593528
SEP:SEPARATED REGULATOR -INC:BUILT-IN REGULATOR	↗ 02	593525
RECTIFIER OR DIODE BRIDGE ASSEMBLY	↗ 07	593526
FRONT HOUSING	↗ 31	593658
PULLEY FREE WHEEL + CAP PROTECTION	↗ 11c	593907
ROTOR	↗ 04	593285
STATOR	↗ 05	593588

Valeo**439294/437210****SG15S024**

150

4

6V

14



40°

Ø 57,5

INC



FRONT BEARING	↗ 21	593563
REAR BEARING	↗ 22	593564
PROTECTION COVER	↗ 24	*599076
SEP:SEPARATED REGULATOR -INC:BUILT-IN REGULATOR	↗ 02	593828
RECTIFIER OR DIODE BRIDGE ASSEMBLY	↗ 07	593526
FRONT HOUSING	↗ 31	593658
PULLEY FREE WHEEL + CAP PROTECTION	↗ 11c	593907
ROTOR	↗ 04	593285
STATOR	↗ 05	593588

Valeo**439493/437458****SG15S025**

150

4

6V

14



40°

Ø 57,5

INC

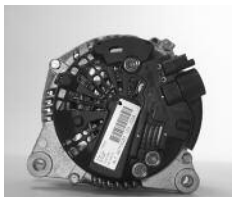

FRONT BEARING	↗ 21	593563
REAR BEARING	↗ 22	593564
PROTECTION COVER	↗ 24	*599076
SEP:SEPARATED REGULATOR -INC:BUILT-IN REGULATOR	↗ 02	593773
RECTIFIER OR DIODE BRIDGE ASSEMBLY	↗ 07	593526
FRONT HOUSING	↗ 31	593678
PULLEY FREE WHEEL + CAP PROTECTION	↗ 11c	593907
ROTOR	↗ 04	593285
STATOR	↗ 05	593588

Valeo**439447/437407****SG15S030**

150

2

5V

14



33°

Ø 54,8

INC



FRONT BEARING	↗ 21	593563
REAR BEARING	↗ 22	593564
PROTECTION COVER	↗ 24	593841
SEP:SEPARATED REGULATOR -INC:BUILT-IN REGULATOR	↗ 02	593839
RECTIFIER OR DIODE BRIDGE ASSEMBLY	↗ 07	593840
FRONT HOUSING	↗ 31	593844
PULLEY	↗ 11	593728
ROTOR	↗ 04	593285
STATOR	↗ 05	593588

Valeo**439463/437421****SG15S031**

150

4

6V

14



40°

Ø 57,5

INC



FRONT BEARING	↗ 21	593563
REAR BEARING	↗ 22	593564
PROTECTION COVER	↗ 24	*599076
SEP:SEPARATED REGULATOR -INC:BUILT-IN REGULATOR	↗ 02	593857
RECTIFIER OR DIODE BRIDGE ASSEMBLY	↗ 07	593526
FRONT HOUSING	↗ 31	593678
PULLEY	↗ 11	593620
ROTOR	↗ 04	593285
STATOR	↗ 05	593588

Valeo**439492/437457****SG15S032**

150

2

6V

14



20°

Ø 60

INC

**B+(M8)
L(M5)**

FRONT BEARING	↗ 21	593674
REAR BEARING	↗ 22	593564
PROTECTION COVER	↗ 24	593903
SEP:SEPARATED REGULATOR -INC:BUILT-IN REGULATOR	↗ 02	593434
RECTIFIER OR DIODE BRIDGE ASSEMBLY	↗ 07	593902
FRONT HOUSING	↗ 31	593646
PULLEY	↗ 11	593609
ROTOR	↗ 04	593285
STATOR	↗ 05	593588

Valeo**439340/437350**

SG7S010	75	6V	
14	↻	Ø 58,18	INC

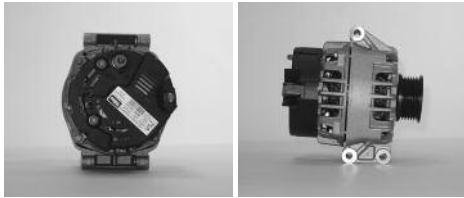

- FRONT BEARING 21 593687
- REAR BEARING 22 593688
- PROTECTION COVER 24 593476
- RECTIFIER OR DIODE BRIDGE ASSEMBLY 07 593475
- FRONT HOUSING 31 593635
- PULLEY 11 593518
- REGULATOR + COVER 02+24 593939
- ROTOR 04 593571
- STATOR 05 593590

SG7S010	75	6V	
14	↻	Ø 58,18	INC

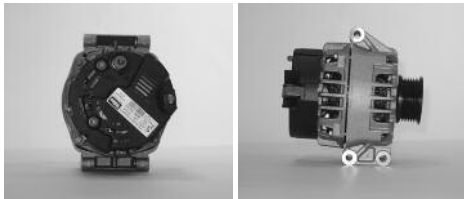

- FRONT BEARING 21 593687
- REAR BEARING 22 593688
- PROTECTION COVER 24 593476
- RECTIFIER OR DIODE BRIDGE ASSEMBLY 07 593475
- FRONT HOUSING 31 593635
- PULLEY 11 593518
- REGULATOR + COVER 02+24 593939
- ROTOR 04 593571
- STATOR 05 593590

Valeo 439226/437393

SG7S012	75	2	3V
14	↻	66-82°	Ø 62,1 INC

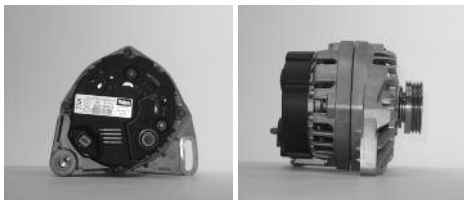

- FRONT BEARING 21 593563
- REAR BEARING 22 593688
- PROTECTION COVER 24 593476
- RECTIFIER OR DIODE BRIDGE ASSEMBLY 07 593555
- FRONT HOUSING 31 593654
- PULLEY 11 593623
- REGULATOR + COVER 02+24 593939
- ROTOR 04 593571
- STATOR 05 593590

Valeo 439429/437428

SG7S013	75	6V	
14	↻	Ø 58,18	INC

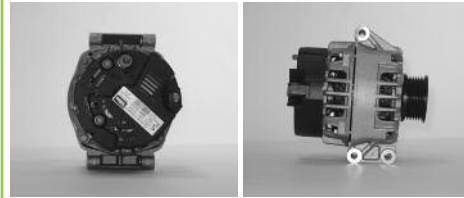

- FRONT BEARING 21 593687
- REAR BEARING 22 593688
- PROTECTION COVER 24 593476
- RECTIFIER OR DIODE BRIDGE ASSEMBLY 07 593475
- FRONT HOUSING 31 593635
- PULLEY 11 593624
- REGULATOR + COVER 02+24 593939
- ROTOR 04 593571
- STATOR 05 593590

Valeo 439430/437393

SG7S014	70	4	6V
14	↻	40°	Ø 57,5 INC

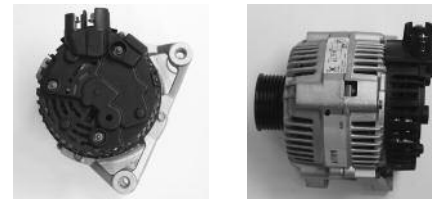

B+(M8)
L(M5)

- FRONT BEARING 21 593563
- REAR BEARING 22 593688
- PROTECTION COVER 24 593479
- SEP:SEPARATED REGULATOR -INC:BUILT-IN REGULATOR 02 593534
- RECTIFIER OR DIODE BRIDGE ASSEMBLY 07 593478
- FRONT HOUSING 31 593657
- PULLEY 11 593519
- ROTOR 04 593571
- STATOR 05 593590

Valeo 439246/437137

SG7S015	70	4	6V
14	↻	40°	Ø 57,5 INC

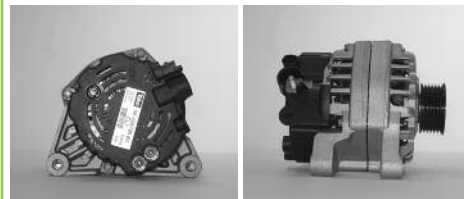

- FRONT BEARING 21 593563
- REAR BEARING 22 593688
- PROTECTION COVER 24 593545
- SEP:SEPARATED REGULATOR -INC:BUILT-IN REGULATOR 02 593529
- RECTIFIER OR DIODE BRIDGE ASSEMBLY 07 593478
- FRONT HOUSING 31 593657
- PULLEY 11 593519
- ROTOR 04 593571
- STATOR 05 593590

Valeo 439275/437355



SG7S016

70 4 6V

14 ↻ 40° ∇ Ø 52 INC

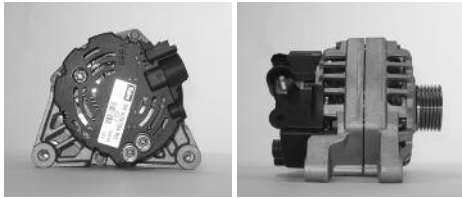

FRONT BEARING 21 593563
 REAR BEARING 22 593688
 PROTECTION COVER 24 593545
 SEP:SEPARATED REGULATOR -INC:BUILT-IN REGULATOR 02 593529
 RECTIFIER OR DIODE BRIDGE ASSEMBLY 07 593478
 FRONT HOUSING 31 593657
 PULLEY 11 593331
 ROTOR 04 593571
 STATOR 05 593590

Valeo

439494/437460

SG7S020

70 4 6V

14 ↻ 60° ∇ Ø 50 INC

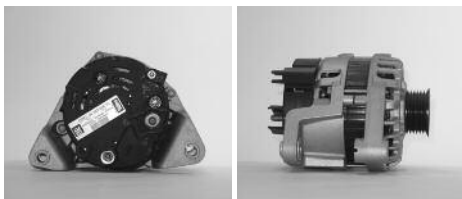

B+(M8)D+(M5)

FRONT BEARING 21 593563
 REAR BEARING 22 593688
 PROTECTION COVER 24 593507
 SEP:SEPARATED REGULATOR -INC:BUILT-IN REGULATOR 02 593505
 RECTIFIER OR DIODE BRIDGE ASSEMBLY 07 593506
 FRONT HOUSING 31 593655
 PULLEY 11 593616
 ROTOR 04 593571
 STATOR 05 593590

Valeo

439453/437413

SG7S021

70 2 5V

14 ↻ 0° ∇ Ø 54 INC



B+(M8)D+(M5)

FRONT BEARING 21 593563
 REAR BEARING 22 593688
 PROTECTION COVER 24 593507
 SEP:SEPARATED REGULATOR -INC:BUILT-IN REGULATOR 02 593505
 RECTIFIER OR DIODE BRIDGE ASSEMBLY 07 593508
 FRONT HOUSING 31 593653
 PULLEY 11 593617
 ROTOR 04 593571
 STATOR 05 593590

Valeo

439454/437414

SG7S024

70 4 6V

14 ↻ 40° ∇ Ø 57,5 INC

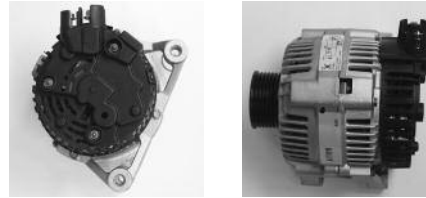
B+(M8)
L(M5)

FRONT BEARING 21 593563
 REAR BEARING 22 593688
 PROTECTION COVER 24 593479
 SEP:SEPARATED REGULATOR -INC:BUILT-IN REGULATOR 02 593534
 RECTIFIER OR DIODE BRIDGE ASSEMBLY 07 593478
 FRONT HOUSING 31 593657
 PULLEY 11 593519
 ROTOR 04 593571
 STATOR 05 593590

Valeo

439246/437137

SG7S026

70 2 1V

14 ↻ 0° ∇ Ø 67 INC



B+(M8)D+(M5)

FRONT BEARING 21 593563
 REAR BEARING 22 593688
 PROTECTION COVER 24 593507
 RECTIFIER OR DIODE BRIDGE ASSEMBLY 07 593508
 FRONT HOUSING 31 593653
 PULLEY 11 096882
 ROTOR 04 593571
 STATOR 05 593590

SG7S026

70 2 1V

14 ↻ 0° ∇ Ø 67 INC



B+(M8)D+(M5)

FRONT BEARING 21 593563
 REAR BEARING 22 593688
 PROTECTION COVER 24 593507
 RECTIFIER OR DIODE BRIDGE ASSEMBLY 07 593508
 FRONT HOUSING 31 593653
 PULLEY 11 096882
 ROTOR 04 593571
 STATOR 05 593590

Valeo

439499/437211

SG7S028

75

2

4V

14



69 - 82,5°

Ø 61,1

INC

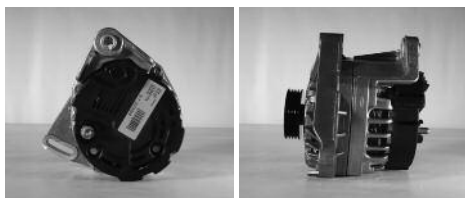

FRONT BEARING	21	593563
REAR BEARING	22	593688
PROTECTION COVER	24	593476
SEP:SEPARATED REGULATOR -INC:BUILT-IN REGULATOR	02	593546
RECTIFIER OR DIODE BRIDGE ASSEMBLY	07	593555
FRONT HOUSING	31	593654
PULLEY	11	593753
ROTOR	04	593571
STATOR	05	593590

Valeo

439308/437313

SG7S070

70

2

3V

14



59.8-70.8°

Ø 61,1

INC

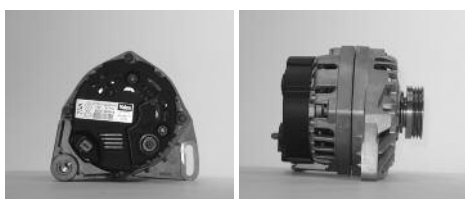

FRONT BEARING	21	593563
REAR BEARING	22	593688
PROTECTION COVER	24	593476
RECTIFIER OR DIODE BRIDGE ASSEMBLY	07	593555
FRONT HOUSING	31	593654
PULLEY	11	593623
REGULATOR + COVER	02+24	593939
ROTOR	04	593571
STATOR	05	593590

SG7S070

70

2

3V

14



59.8-70.8°

Ø 61,1

INC

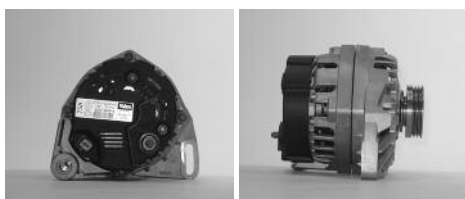

FRONT BEARING	21	593563
REAR BEARING	22	593688
PROTECTION COVER	24	593476
RECTIFIER OR DIODE BRIDGE ASSEMBLY	07	593555
FRONT HOUSING	31	593654
PULLEY	11	593623
REGULATOR + COVER	02+24	593939
ROTOR	04	593571
STATOR	05	593590

Valeo

439429/437428

SG7S071

70

6V

14



Ø 56,26

INC

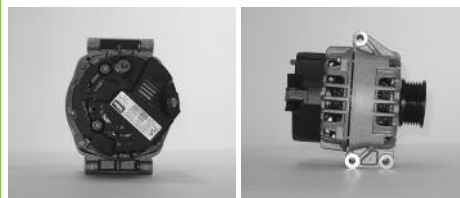

FRONT BEARING	21	593687
REAR BEARING	22	593688
PROTECTION COVER	24	593476
RECTIFIER OR DIODE BRIDGE ASSEMBLY	07	*595424
FRONT HOUSING	31	593635
PULLEY	11	593518
REGULATOR + COVER	02+24	593939
ROTOR	04	593571
STATOR	05	593590

SG7S071

70

6V

14



Ø 56,26

INC

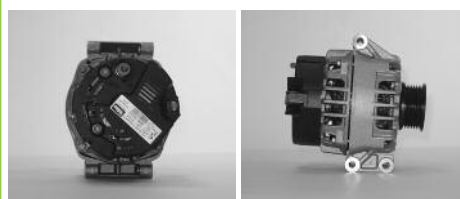

FRONT BEARING	21	593687
REAR BEARING	22	593688
PROTECTION COVER	24	593476
RECTIFIER OR DIODE BRIDGE ASSEMBLY	07	*595424
FRONT HOUSING	31	593635
PULLEY	11	593518
REGULATOR + COVER	02+24	593939
ROTOR	04	593571
STATOR	05	593590

Valeo

439430/437393

SG7S074

75

2

4V

14



69 - 82,5°

Ø 61,1

INC

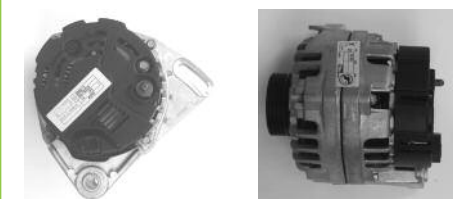

FRONT BEARING	21	593563
REAR BEARING	22	593688
PROTECTION COVER	24	593476
SEP:SEPARATED REGULATOR -INC:BUILT-IN REGULATOR	02	593546
RECTIFIER OR DIODE BRIDGE ASSEMBLY	07	593555
FRONT HOUSING	31	593654
PULLEY	11	593753
ROTOR	04	593571
STATOR	05	593590

SG7S074

75 2 4V

14 ↻ 69 - 82,5° ∇ Ø 61,1 INC



FRONT BEARING 21 593563
 REAR BEARING 22 593688
 PROTECTION COVER 24 593476
 SEP:SEPARATED REGULATOR -INC:BUILT-IN REGULATOR 02 593546
 RECTIFIER OR DIODE BRIDGE ASSEMBLY 07 593555
 FRONT HOUSING 31 593654
 PULLEY 11 593753
 ROTOR 04 593571
 STATOR 05 593590

Valeo

439308/437313

SG8B010

70 2 5V

14 ↻ 60° ∇ Ø 57,2 INC

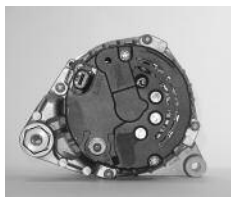

FRONT BEARING 21 593563
 REAR BEARING 22 593564
 PROTECTION COVER 24 593373
 SEP:SEPARATED REGULATOR -INC:BUILT-IN REGULATOR 02 593522
 RECTIFIER OR DIODE BRIDGE ASSEMBLY 07 593372
 FRONT HOUSING 31 593628
 PULLEY 11 593592
 STATOR 05 593579

Valeo

439264/437177

SG8B011

70 2 6V

14 ↻ 90° ∇ Ø 59,2 INC



FRONT BEARING 21 593563
 REAR BEARING 22 593564
 PROTECTION COVER 24 593848
 SEP:SEPARATED REGULATOR -INC:BUILT-IN REGULATOR 02 593480
 RECTIFIER OR DIODE BRIDGE ASSEMBLY 07 593414
 FRONT HOUSING 31 593644
 REGULATOR + COVER 02+24 593940
 ROTOR 04 593926
 STATOR 05 593579

Valeo

439310/437315

SG8B013

70 2 6V

14 ↻ 90° ∇ Ø 59,2 INC

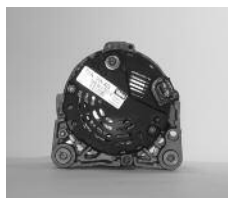

FRONT BEARING 21 593563
 REAR BEARING 22 593564
 PROTECTION COVER 24 593848
 SEP:SEPARATED REGULATOR -INC:BUILT-IN REGULATOR 02 593480
 RECTIFIER OR DIODE BRIDGE ASSEMBLY 07 593414
 FRONT HOUSING 31 593644
 PULLEY FREE WHEEL + CAP PROTECTION 11c 593600
 REGULATOR + COVER 02+24 593940
 ROTOR 04 593926
 STATOR 05 593579

Valeo

439436/437395

SG8B015

70 2 6V

14 ↻ 90° ∇ Ø 59,2 INC



FRONT BEARING 21 593563
 REAR BEARING 22 593564
 PROTECTION COVER 24 593848
 SEP:SEPARATED REGULATOR -INC:BUILT-IN REGULATOR 02 593480
 RECTIFIER OR DIODE BRIDGE ASSEMBLY 07 593482
 FRONT HOUSING 31 593644
 PULLEY 11 599137
 REGULATOR + COVER 02+24 593940
 ROTOR 04 593926
 STATOR 05 593579

Valeo

439437/437396

SG8B016

70 2 6V

14 ↻ 75-88° ∇ Ø 59,2 INC



FRONT BEARING 21 593563
 REAR BEARING 22 593564
 PROTECTION COVER 24 593848
 SEP:SEPARATED REGULATOR -INC:BUILT-IN REGULATOR 02 593480
 RECTIFIER OR DIODE BRIDGE ASSEMBLY 07 593483
 FRONT HOUSING 31 593631
 PULLEY 11 599137
 ROTOR 04 593926
 STATOR 05 593579

Valeo

439438/437397

SG8B017

70

3

6V

14



75-88°

Ø 50,5

INC

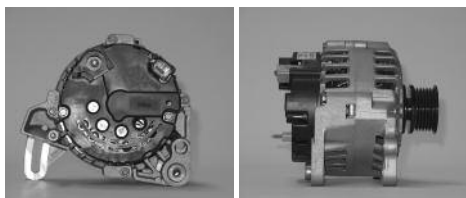

FRONT BEARING	21	593563
REAR BEARING	22	593564
PROTECTION COVER	24	593848
SEP:SEPARATED REGULATOR -INC:BUILT-IN REGULATOR	02	593480
RECTIFIER OR DIODE BRIDGE ASSEMBLY	07	593483
FRONT HOUSING	31	593631
PULLEY	11	592920
REGULATOR + COVER	02+24	593940
ROTOR	04	593567
ROTOR	04	593926
STATOR	05	593579

Valeo**439439/437398****SG8B018**

70

2

6V

14



90°

Ø 53,2

INC

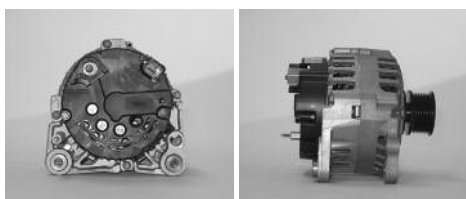

FRONT BEARING	21	593563
REAR BEARING	22	593564
PROTECTION COVER	24	593848
SEP:SEPARATED REGULATOR -INC:BUILT-IN REGULATOR	02	593480
RECTIFIER OR DIODE BRIDGE ASSEMBLY	07	593482
FRONT HOUSING	31	593644
PULLEY	11	592920
REGULATOR + COVER	02+24	593940
ROTOR	04	593567
ROTOR	04	593926
STATOR	05	593579

Valeo**439440/437399****SG8B020**

80

4

6V

14



40°

Ø 57,5

INC

**B+(M8)
L(M5)**

FRONT BEARING	21	593563
REAR BEARING	22	593564
PROTECTION COVER	24	593510
SEP:SEPARATED REGULATOR -INC:BUILT-IN REGULATOR	02	593534
RECTIFIER OR DIODE BRIDGE ASSEMBLY	07	593509
FRONT HOUSING	31	593650
PULLEY	11	593519
ROTOR	04	593574
STATOR	05	593579

Valeo**439247/437138****SG8B021**

80

4

6V

14



80°

Ø 57,5

INC

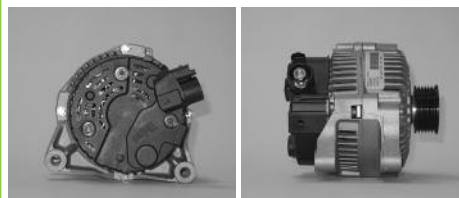

FRONT BEARING	21	593563
REAR BEARING	22	593564
PROTECTION COVER	24	593531
SEP:SEPARATED REGULATOR -INC:BUILT-IN REGULATOR	02	593529
RECTIFIER OR DIODE BRIDGE ASSEMBLY	07	593509
FRONT HOUSING	31	593650
PULLEY	11	593519
ROTOR	04	593574
STATOR	05	593579

Valeo**439277/437356****SG8B022**

80

4

6V

14



40°

Ø 52

INC

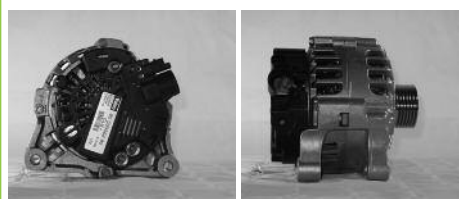

FRONT BEARING	21	593563
REAR BEARING	22	593564
PROTECTION COVER	24	593531
SEP:SEPARATED REGULATOR -INC:BUILT-IN REGULATOR	02	593529
RECTIFIER OR DIODE BRIDGE ASSEMBLY	07	593509
FRONT HOUSING	31	593650
PULLEY	11	593619
ROTOR	04	593567
ROTOR	04	593574
STATOR	05	593579

Valeo**439495/437461****SG8B023**

70

4

6V

14



90°

Ø 57,2

INC



FRONT BEARING	21	593563
REAR BEARING	22	593564
PROTECTION COVER	24	593858
SEP:SEPARATED REGULATOR -INC:BUILT-IN REGULATOR	02	593480
RECTIFIER OR DIODE BRIDGE ASSEMBLY	07	593503
FRONT HOUSING	31	593644
PULLEY	11	593615
REGULATOR + COVER	02+24	593942
ROTOR	04	593926
STATOR	05	593579

Valeo**439452/437412**

SG8B026

90

4

6V

14



90°

Ø 50,5

INC

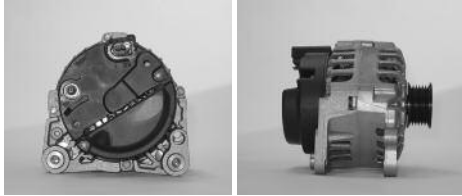

FRONT BEARING	↗ 21	593563
REAR BEARING	↗ 22	593564
PROTECTION COVER	↗ 24	593858
SEP:SEPARATED REGULATOR -INC:BUILT-IN REGULATOR	↗ 02	593480
RECTIFIER OR DIODE BRIDGE ASSEMBLY	↗ 07	593503
FRONT HOUSING	↗ 31	593644
PULLEY	↗ 11	593777
REGULATOR + COVER	↗ 02+24	593942
ROTOR	↗ 04	593567
ROTOR	↗ 04	593926
STATOR	↗ 05	593579

Valeo**439482/437445****SG8B027**

70

4

6V

14



90°

Ø 57,2

INC

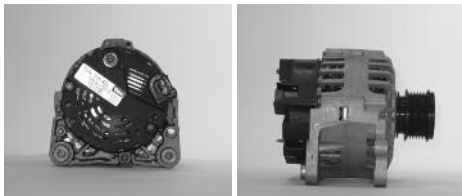

FRONT BEARING	↗ 21	593563
REAR BEARING	↗ 22	593564
PROTECTION COVER	↗ 24	593848
SEP:SEPARATED REGULATOR -INC:BUILT-IN REGULATOR	↗ 02	593813
RECTIFIER OR DIODE BRIDGE ASSEMBLY	↗ 07	593414
FRONT HOUSING	↗ 31	593644
PULLEY FREE WEEL + CAP PROTECTION	↗ 11c	593600
ROTOR	↗ 04	593926
STATOR	↗ 05	593579

Valeo**439436/437395****SG8B029**

70

4

6V

14



90°

Ø 59,2

INC

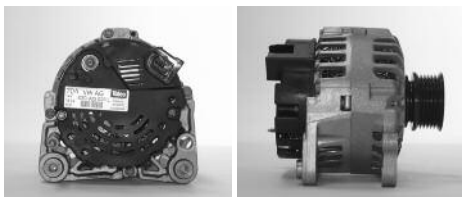

FRONT BEARING	↗ 21	593563
REAR BEARING	↗ 22	593564
PROTECTION COVER	↗ 24	593848
SEP:SEPARATED REGULATOR -INC:BUILT-IN REGULATOR	↗ 02	593813
RECTIFIER OR DIODE BRIDGE ASSEMBLY	↗ 07	593482
FRONT HOUSING	↗ 31	593644
PULLEY	↗ 11	599137
ROTOR	↗ 04	593926
STATOR	↗ 05	593579

Valeo**439437/437396****SG9B010**

90

2

5V

14



30°

Ø 57,2

INC

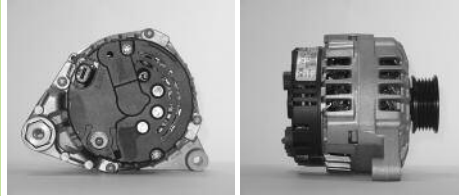

FRONT BEARING	↗ 21	593563
REAR BEARING	↗ 22	593564
PROTECTION COVER	↗ 24	593834
SEP:SEPARATED REGULATOR -INC:BUILT-IN REGULATOR	↗ 02	593522
RECTIFIER OR DIODE BRIDGE ASSEMBLY	↗ 07	593372
FRONT HOUSING	↗ 31	593628
PULLEY	↗ 11	593592
REGULATOR + COVER	↗ 02+24	593941
ROTOR	↗ 04	593926
STATOR	↗ 05	593579

SG9B010

90

2

5V

14



30°

Ø 57,2

INC

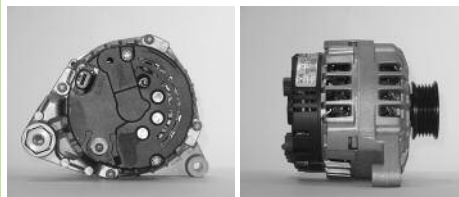

FRONT BEARING	↗ 21	593563
REAR BEARING	↗ 22	593564
PROTECTION COVER	↗ 24	593834
SEP:SEPARATED REGULATOR -INC:BUILT-IN REGULATOR	↗ 02	593522
RECTIFIER OR DIODE BRIDGE ASSEMBLY	↗ 07	593372
FRONT HOUSING	↗ 31	593628
PULLEY	↗ 11	593592
REGULATOR + COVER	↗ 02+24	593941
ROTOR	↗ 04	593926
STATOR	↗ 05	593579

Valeo**439338/437348****SG9B011**

90

2

6V

14



60°

Ø 66

INC

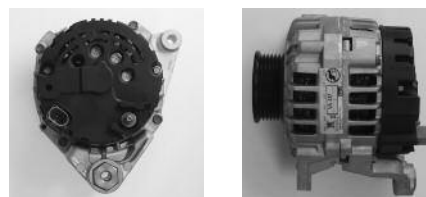

FRONT BEARING	↗ 21	593563
REAR BEARING	↗ 22	593564
PROTECTION COVER	↗ 24	593834
SEP:SEPARATED REGULATOR -INC:BUILT-IN REGULATOR	↗ 02	593522
RECTIFIER OR DIODE BRIDGE ASSEMBLY	↗ 07	593372
FRONT HOUSING	↗ 31	593628
PULLEY	↗ 11	593593
REGULATOR + COVER	↗ 02+24	593941
ROTOR	↗ 04	593567
STATOR	↗ 05	593579

Valeo**439261/437174**

SG9B013

90

2

6V

14



90°

Ø 57,2

INC

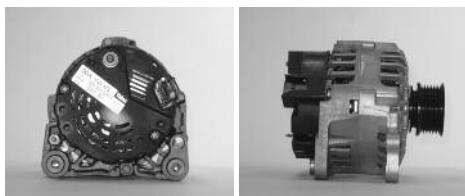

FRONT BEARING 21 593563
 REAR BEARING 22 593564
 PROTECTION COVER 24 593848
 SEP:SEPARATED REGULATOR -INC:BUILT-IN REGULATOR 02 593480
 RECTIFIER OR DIODE BRIDGE ASSEMBLY 07 593414
 FRONT HOUSING 31 593644
 PULLEY 11 599137
 REGULATOR + COVER 02+24 593940
 ROTOR 04 593567
 STATOR 05 593579

Valeo**439311/437316****SG9B015**

90

4

6V RL

14



90°

Ø 57,2

INC

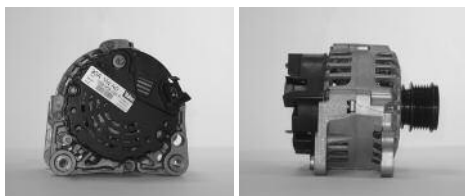

FRONT BEARING 21 593563
 REAR BEARING 22 593564
 PROTECTION COVER 24 593848
 SEP:SEPARATED REGULATOR -INC:BUILT-IN REGULATOR 02 593480
 SEP:SEPARATED REGULATOR -INC:BUILT-IN REGULATOR 02 593813
 RECTIFIER OR DIODE BRIDGE ASSEMBLY 07 593414
 FRONT HOUSING 31 593644
 PULLEY FREE WHEEL + CAP PROTECTION 11c 593600
 REGULATOR + COVER 02+24 593940
 ROTOR 04 593926
 STATOR 05 593579

Valeo**439441/437400****SG9B018**

90

2

6V

14



90°

Ø 59,2

INC

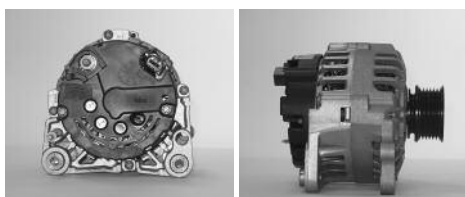

FRONT BEARING 21 593563
 REAR BEARING 22 593564
 PROTECTION COVER 24 593848
 SEP:SEPARATED REGULATOR -INC:BUILT-IN REGULATOR 02 593480
 RECTIFIER OR DIODE BRIDGE ASSEMBLY 07 593482
 FRONT HOUSING 31 593644
 PULLEY 11 599137
 REGULATOR + COVER 02+24 593940
 ROTOR 04 593567
 STATOR 05 593579

Valeo**439442/437401****SG9B019**

90

3

6V

14



75-88°

Ø 59,2

INC

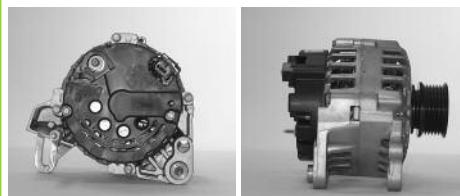

FRONT BEARING 21 593563
 REAR BEARING 22 593564
 PROTECTION COVER 24 593848
 SEP:SEPARATED REGULATOR -INC:BUILT-IN REGULATOR 02 593480
 RECTIFIER OR DIODE BRIDGE ASSEMBLY 07 593483
 FRONT HOUSING 31 593631
 PULLEY 11 599137
 ROTOR 04 593567
 STATOR 05 593579

Valeo**439443/437402****SG9B023**

90

3

6V

14



75-88°

Ø 53,2

INC

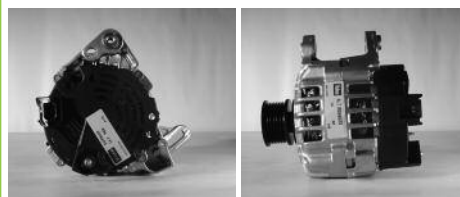

FRONT BEARING 21 593563
 REAR BEARING 22 593564
 PROTECTION COVER 24 593848
 SEP:SEPARATED REGULATOR -INC:BUILT-IN REGULATOR 02 593480
 RECTIFIER OR DIODE BRIDGE ASSEMBLY 07 593483
 FRONT HOUSING 31 593631
 PULLEY 11 592920
 REGULATOR + COVER 02+24 593940
 ROTOR 04 593567
 STATOR 05 593579

Valeo**439444/437403****SG9B024**

90

2

6V

14



90°

Ø 50,5

INC

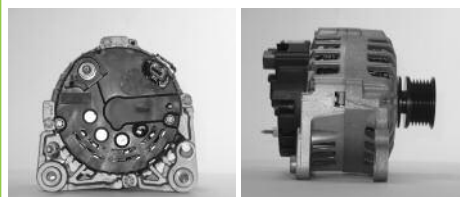

FRONT BEARING 21 593563
 REAR BEARING 22 593564
 PROTECTION COVER 24 593848
 SEP:SEPARATED REGULATOR -INC:BUILT-IN REGULATOR 02 593480
 RECTIFIER OR DIODE BRIDGE ASSEMBLY 07 593482
 FRONT HOUSING 31 593644
 PULLEY 11 592920
 REGULATOR + COVER 02+24 593940
 ROTOR 04 593926
 STATOR 05 593579

Valeo**439445/437404**

SG9B025

95

2

6V

14



66°

Ø 65

INC



FRONT BEARING 21 593563
 REAR BEARING 22 593564
 PROTECTION COVER 24 593388
 SEP:SEPARATED REGULATOR -INC:BUILT-IN REGULATOR 02 593389
 PULLEY 11 593595
 ROTOR 04 593996
 STATOR 05 593579

Valeo

439295/437221

SG9B027

90

2

6V

14



60°

Ø 66

INC



FRONT BEARING 21 593563
 REAR BEARING 22 593564
 PROTECTION COVER 24 593834
 RECTIFIER OR DIODE BRIDGE ASSEMBLY 07 593372
 FRONT HOUSING 31 593628
 PULLEY 11 593593
 REGULATOR + COVER 02+24 595229
 ROTOR 04 593567
 STATOR 05 593579

Valeo

439262/437175

SG9B029

90

2

6V

14



90°

Ø 51

INC



FRONT BEARING 21 593563
 REAR BEARING 22 593564
 SEP:SEPARATED REGULATOR -INC:BUILT-IN REGULATOR 02 593423
 RECTIFIER OR DIODE BRIDGE ASSEMBLY 07 593463
 FRONT HOUSING 31 593638
 PULLEY 11 593602
 ROTOR 04 593567
 STATOR 05 593579

Valeo

439397/437366

SG9B033

95

6V

14



Ø 58,18

INC

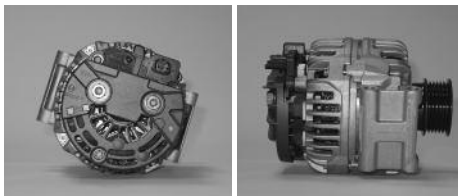

FRONT BEARING 21 593563
 REAR BEARING 22 593564
 PROTECTION COVER 24 593837
 RECTIFIER OR DIODE BRIDGE ASSEMBLY 07 593408
 FRONT HOUSING 31 593639
 PULLEY 11 593610
 REGULATOR + COVER 02+24 593936
 ROTOR 04 593996
 STATOR 05 593579

Valeo

439306/437311

SG9B035

95

2

3V

14



70-83°

Ø 68,2

INC

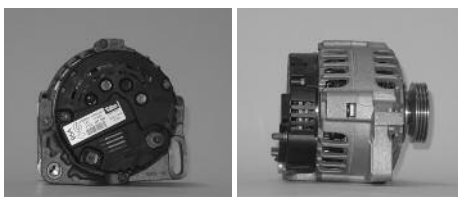

FRONT BEARING 21 593563
 REAR BEARING 22 593564
 PROTECTION COVER 24 593837
 RECTIFIER OR DIODE BRIDGE ASSEMBLY 07 593469
 FRONT HOUSING 31 593641
 PULLEY 11 593614
 REGULATOR + COVER 02+24 593936
 ROTOR 04 593996
 STATOR 05 593579

Valeo

439417/437373

SG9B037

90

5V

14



Ø 53

INC

B+(M8)
L(M6)

FRONT BEARING 21 593563
 REAR BEARING 22 593564
 PROTECTION COVER 24 593875
 SEP:SEPARATED REGULATOR -INC:BUILT-IN REGULATOR 02* 593874
 RECTIFIER OR DIODE BRIDGE ASSEMBLY 07 593441
 FRONT HOUSING 31 593643
 PULLEY 11 593604
 REGULATOR + COVER 02+24 593945
 ROTOR 04 593996
 STATOR 05 593579

Valeo

439206/436732

SG9B038

90

5V

14



Ø 53

INC

**B+(M8)**
L(M6)

FRONT BEARING	21	593563
REAR BEARING	22	593564
PROTECTION COVER	24	593875
SEP:SEPARATED REGULATOR -INC:BUILT-IN REGULATOR	02*	593874
RECTIFIER OR DIODE BRIDGE ASSEMBLY	07	593441
FRONT HOUSING	31	593643
PULLEY FREE WEEL + CAP PROTECTION	11c	*595391
REGULATOR + COVER	02+24	593945
ROTOR	04	593996
STATOR	05	593579

Valeo**439232/437114****SG9B039**

90

5V

14



Ø 51

INC

**B+(M8)**
L(M6)

FRONT BEARING	21	593563
REAR BEARING	22	593564
PROTECTION COVER	24	593875
SEP:SEPARATED REGULATOR -INC:BUILT-IN REGULATOR	02	593440
RECTIFIER OR DIODE BRIDGE ASSEMBLY	07	593441
FRONT HOUSING	31	593643
PULLEY FREE WEEL + CAP PROTECTION	11c	*595391
ROTOR	04	593996
STATOR	05	593579

Valeo**439333/437346****SG9B040**

90

6V

14



Ø 49

INC

Picture not available
Image non disponible
Imagen no disponible
Immagine non disponibile
Nicht verfügbares Bild
Brak zdjęcia
Картина недоступна

Picture not available
Image non disponible
Imagen no disponible
Immagine non disponibile
Nicht verfügbares Bild
Brak zdjęcia
Картина недоступна

FRONT BEARING	21	593563
REAR BEARING	22	593564
PROTECTION COVER	24	593471
SEP:SEPARATED REGULATOR -INC:BUILT-IN REGULATOR	02	593536
FRONT HOUSING	31	593648
PULLEY	11	593606
ROTOR	04	593567
STATOR	05	593579

Valeo**439418/437374****SG9B042**

90

2

5V

14



90°

Ø 57,2

INC



FRONT BEARING	21	593563
REAR BEARING	22	593564
PROTECTION COVER	24	593834
RECTIFIER OR DIODE BRIDGE ASSEMBLY	07	593439
FRONT HOUSING	31	593644
PULLEY FREE WEEL + CAP PROTECTION	11c	593490
REGULATOR + COVER	02+24	593941
ROTOR	04	593567
STATOR	05	593579

Valeo**439327/437340****SG9B047 SP**

95

14



INC

Picture not available
Image non disponible
Imagen no disponible
Immagine non disponibile
Nicht verfügbares Bild
Brak zdjęcia
Картина недоступна

Picture not available
Image non disponible
Imagen no disponible
Immagine non disponibile
Nicht verfügbares Bild
Brak zdjęcia
Картина недоступна

FRONT BEARING	21	593563
REAR BEARING	22	593564
PROTECTION COVER	24	593837
RECTIFIER OR DIODE BRIDGE ASSEMBLY	07	593408
FRONT HOUSING	31	593639
REGULATOR + COVER	02+24	593936
ROTOR	04	593996
STATOR	05	593579

Valeo**439431/440227****SG9B048**

90

4

6V

14



90°

Ø 57,2

INC



FRONT BEARING	21	593563
REAR BEARING	22	593564
PROTECTION COVER	24	593858
SEP:SEPARATED REGULATOR -INC:BUILT-IN REGULATOR	02	593480
RECTIFIER OR DIODE BRIDGE ASSEMBLY	07	593503
FRONT HOUSING	31	593644
PULLEY	11	593615
REGULATOR + COVER	02+24	593942
ROTOR	04	593567
STATOR	05	593579

SG9B048

90

4

6V

14



90°

Ø 57,2

INC



FRONT BEARING	↗ 21	593563
REAR BEARING	↗ 22	593564
PROTECTION COVER	↗ 24	593858
SEP:SEPARATED REGULATOR -INC:BUILT-IN REGULATOR	↗ 02	593480
RECTIFIER OR DIODE BRIDGE ASSEMBLY	↗ 07	593503
FRONT HOUSING	↗ 31	593644
PULLEY	↗ 11	593615
REGULATOR + COVER	↗ 02+24	593942
ROTOR	↗ 04	593567
STATOR	↗ 05	593579

Valeo**439451/437412****SG9B049**

90

2

6V

14



90°

Ø 59,2

INC

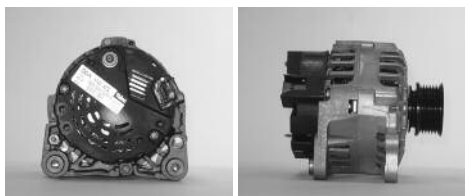

FRONT BEARING	↗ 21	593563
REAR BEARING	↗ 22	593564
PROTECTION COVER	↗ 24	593848
SEP:SEPARATED REGULATOR -INC:BUILT-IN REGULATOR	↗ 02	593480
RECTIFIER OR DIODE BRIDGE ASSEMBLY	↗ 07	593414
FRONT HOUSING	↗ 31	593644
PULLEY	↗ 11	599137
REGULATOR + COVER	↗ 02+24	593940
ROTOR	↗ 04	593567
STATOR	↗ 05	593579

Valeo**439311/437316****SG9B050**

90

6V

14



Ø 50,3

INC

Picture not available
Image non disponible
Imagen no disponible
Immagine non disponibile
Nicht verfügbares Bild
Brak zdjęcia
Картина недоступна

Picture not available
Image non disponible
Imagen no disponible
Immagine non disponibile
Nicht verfügbares Bild
Brak zdjęcia
Картина недоступна

FRONT BEARING	↗ 21	593563
REAR BEARING	↗ 22	593564
PROTECTION COVER	↗ 24	593471
SEP:SEPARATED REGULATOR -INC:BUILT-IN REGULATOR	↗ 02	593536
FRONT HOUSING	↗ 31	593648
PULLEY FREE WHEEL + CAP PROTECTION	↗ 11c	593537
ROTOR	↗ 04	593567
STATOR	↗ 05	593579

Valeo**439418/437374****SG9B052**

90

2

6V

14



34°

Ø 51

INC



FRONT BEARING	↗ 21	593563
REAR BEARING	↗ 22	593564
PROTECTION COVER	↗ 24	593817
SEP:SEPARATED REGULATOR -INC:BUILT-IN REGULATOR	↗ 02*	595337
RECTIFIER OR DIODE BRIDGE ASSEMBLY	↗ 07	593463
FRONT HOUSING	↗ 31	593638
PULLEY	↗ 11	593602
ROTOR	↗ 04	593567
STATOR	↗ 05	593579

Valeo**439496/437463****SG9B053**

95

2

6V

14



90°

Ø 52,3

INC

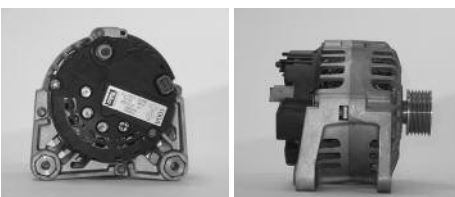

FRONT BEARING	↗ 21	593563
REAR BEARING	↗ 22	593564
PROTECTION COVER	↗ 24	593850
SEP:SEPARATED REGULATOR -INC:BUILT-IN REGULATOR	↗ 02	593689
RECTIFIER OR DIODE BRIDGE ASSEMBLY	↗ 07	593548
FRONT HOUSING	↗ 31	593647
REGULATOR + COVER	↗ 02+24	593938
ROTOR	↗ 04	593996
STATOR	↗ 05	593579

Valeo**439467/437424****SG9B054**

90

2

6V

14



20°

Ø 60

INC

**B+(M8)
L(M5)**

FRONT BEARING	↗ 21	593674
REAR BEARING	↗ 22	593564
PROTECTION COVER	↗ 24	593672
SEP:SEPARATED REGULATOR -INC:BUILT-IN REGULATOR	↗ 02	593434
RECTIFIER OR DIODE BRIDGE ASSEMBLY	↗ 07	593671
PULLEY	↗ 11	593608
REGULATOR + COVER	↗ 02+24	593967
ROTOR	↗ 04	593567
STATOR	↗ 05	593579

Valeo**439472/437431**

SG9B055

90 4 6V

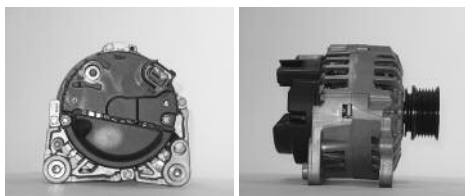
14  90°  Ø 57,2 INC

FRONT BEARING  21 593563
 REAR BEARING  22 593564
 PROTECTION COVER  24 593858
 SEP:SEPARATED REGULATOR -INC:BUILT-IN REGULATOR  02 593480
 RECTIFIER OR DIODE BRIDGE ASSEMBLY  07 593541
 FRONT HOUSING  31 593644
 PULLEY  11 599137
 REGULATOR + COVER  02+24 593940
 ROTOR  04 593926
 STATOR  05 593579

Valeo**439461/437419****SG9B057**

90 4 6V

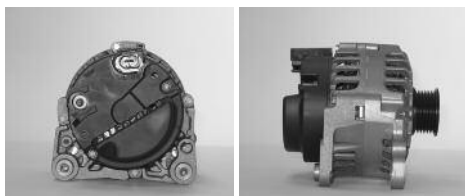
14  90°  Ø 50,5 INC

FRONT BEARING  21 593563
 REAR BEARING  22 593564
 PROTECTION COVER  24 593858
 SEP:SEPARATED REGULATOR -INC:BUILT-IN REGULATOR  02 593480
 RECTIFIER OR DIODE BRIDGE ASSEMBLY  07 593503
 FRONT HOUSING  31 593644
 PULLEY  11 593777
 REGULATOR + COVER  02+24 593942
 ROTOR  04 593926
 STATOR  05 593579

Valeo**439481/437444****SG9B059**

90 4 6V

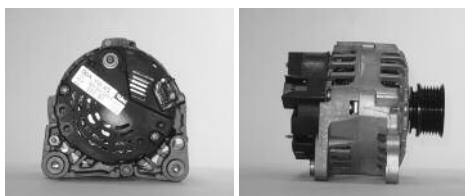



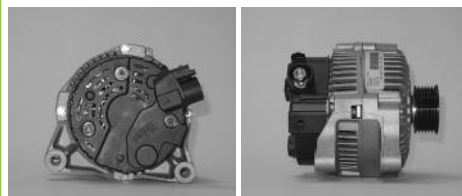

14  90°  Ø 57,2 INC

FRONT BEARING  21 593563
 REAR BEARING  22 593564
 PROTECTION COVER  24 593848
 SEP:SEPARATED REGULATOR -INC:BUILT-IN REGULATOR  02 593813
 RECTIFIER OR DIODE BRIDGE ASSEMBLY  07 593414
 FRONT HOUSING  31 593644
 PULLEY  11 599137
 ROTOR  04 593567
 STATOR  05 593869

Valeo**439311/437316****SG9B063**

80 4 6V





14  40°  Ø 57,5 INC

FRONT BEARING  21 593563
 REAR BEARING  22 593564
 PROTECTION COVER  24 593531
 SEP:SEPARATED REGULATOR -INC:BUILT-IN REGULATOR  02 593529
 RECTIFIER OR DIODE BRIDGE ASSEMBLY  07 593509
 FRONT HOUSING  31 593650
 PULLEY  11 593519
 ROTOR  04 593996
 STATOR  05 593579

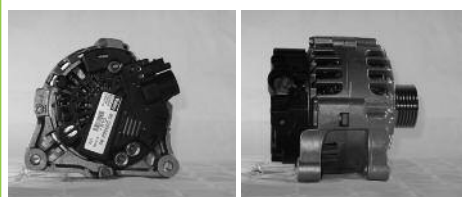
Valeo**439277/437356****SG9B064**

80 4 6V





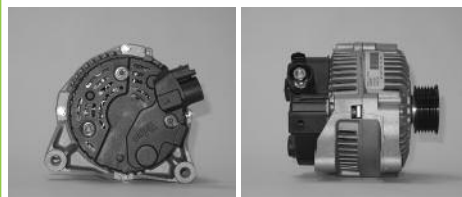

14  40°  Ø 52 INC

FRONT BEARING  21 593563
 REAR BEARING  22 593564
 PROTECTION COVER  24 593531
 SEP:SEPARATED REGULATOR -INC:BUILT-IN REGULATOR  02 593529
 RECTIFIER OR DIODE BRIDGE ASSEMBLY  07 593509
 FRONT HOUSING  31 593650
 PULLEY  11 593619
 ROTOR  04 593996
 STATOR  05 593579

Valeo**439495/437461****SG9B066**

90 4 6V

14  80°  Ø 57,5 INC

FRONT BEARING  21 593563
 REAR BEARING  22 593564
 PROTECTION COVER  24 593531
 SEP:SEPARATED REGULATOR -INC:BUILT-IN REGULATOR  02 593529
 RECTIFIER OR DIODE BRIDGE ASSEMBLY  07 593509
 FRONT HOUSING  31 593650
 PULLEY  11 593519
 ROTOR  04 593996
 STATOR  05 593579

Valeo**439277/437356**

SG9B067

90 4 6V

14 ↻ 40° ∇ Ø 52 INC

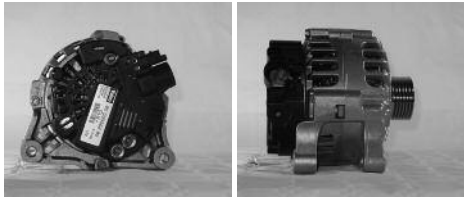

FRONT BEARING	↻ 21	593563
REAR BEARING	↻ 22	593564
PROTECTION COVER	↻ 24	593531
SEP:SEPARATED REGULATOR -INC:BUILT-IN REGULATOR	↻ 02	593529
RECTIFIER OR DIODE BRIDGE ASSEMBLY	↻ 07	593509
FRONT HOUSING	↻ 31	593650
PULLEY	↻ 11	593611
ROTOR	↻ 04	593996
STATOR	↻ 05	593579

Valeo

439495/437461

SG9B069

90 3 6V

14 ↻ Trou oblong 72-86° ∇ Ø 50,5 INC



FRONT BEARING	↻ 21	593563
REAR BEARING	↻ 22	593564
PROTECTION COVER	↻ 24	593848
SEP:SEPARATED REGULATOR -INC:BUILT-IN REGULATOR	↻ 02	593813
RECTIFIER OR DIODE BRIDGE ASSEMBLY	↻ 07	593483
FRONT HOUSING	↻ 31	593631
PULLEY	↻ 11	593868
REGULATOR + COVER	↻ 02+24	593940
ROTOR	↻ 04	593926
STATOR	↻ 05	593869

Valeo

439444/437403

SG9B077

80 2 6V

14 ↻ 20° ∇ Ø 59,4 INC

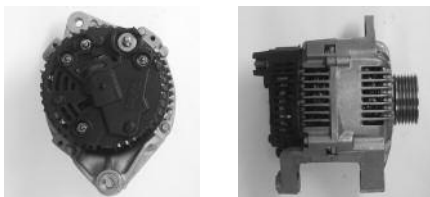

B+(M8)D+(M5)

FRONT BEARING	↻ 21	593563
REAR BEARING	↻ 22	593564
PROTECTION COVER	↻ 24	595223
SEP:SEPARATED REGULATOR -INC:BUILT-IN REGULATOR	↻ 02	593534
RECTIFIER OR DIODE BRIDGE ASSEMBLY	↻ 07	595221
FRONT HOUSING	↻ 31	595224
PULLEY	↻ 11	595222
ROTOR	↻ 04	593996
STATOR	↻ 05	593952

Valeo

439023/436476

SG9B078

90 4 6V RL

14 ↻ 90° ∇ Ø 57,2 INC

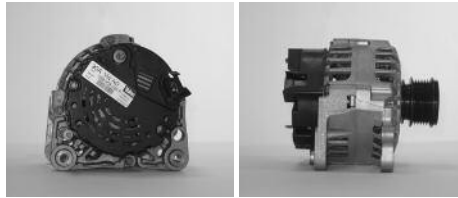

FRONT BEARING	↻ 21	593563
REAR BEARING	↻ 22	593564
PROTECTION COVER	↻ 24	593848
SEP:SEPARATED REGULATOR -INC:BUILT-IN REGULATOR	↻ 02	593813
RECTIFIER OR DIODE BRIDGE ASSEMBLY	↻ 07	593414
FRONT HOUSING	↻ 31	593644
PULLEY FREE WHEEL + CAP PROTECTION	↻ 11c	593600
ROTOR	↻ 04	593567
STATOR	↻ 05	593579

Valeo

439441/437400

SG9B079

90 5V

14 ↻ Ø 53 INC

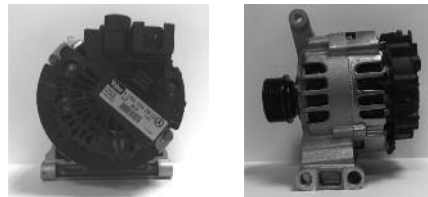

FRONT BEARING	↻ 21	593563
REAR BEARING	↻ 22	593564
PROTECTION COVER	↻ 24	593951
SEP:SEPARATED REGULATOR -INC:BUILT-IN REGULATOR	↻ 02	593948
RECTIFIER OR DIODE BRIDGE ASSEMBLY	↻ 07	593949
FRONT HOUSING	↻ 31	*595473
PULLEY	↻ 11	593950
ROTOR	↻ 04	593567
ROTOR	↻ 04	593996
STATOR	↻ 05	593952

Valeo

439544/437537

SG9B087

90 4 6V

14 ↻ 90° ∇ Ø 57,2 INC

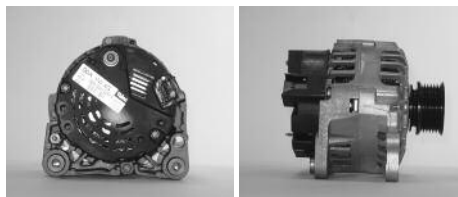

FRONT BEARING	↻ 21	593563
REAR BEARING	↻ 22	593564
PROTECTION COVER	↻ 24	593848
SEP:SEPARATED REGULATOR -INC:BUILT-IN REGULATOR	↻ 02	593813
RECTIFIER OR DIODE BRIDGE ASSEMBLY	↻ 07	593414
FRONT HOUSING	↻ 31	593644
PULLEY	↻ 11	599137
REGULATOR + COVER	↻ 02+24	593940
ROTOR	↻ 04	593926
STATOR	↻ 05	593579

Valeo

439311/437316

SG9B088

90

4

6V

14



90°

Ø 57,2

INC

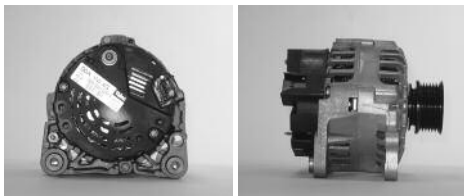

FRONT BEARING	↗21	593563
REAR BEARING	↗22	593564
PROTECTION COVER	↗24	593848
RECTIFIER OR DIODE BRIDGE ASSEMBLY	↗07	593414
FRONT HOUSING	↗31	593644
PULLEY	↗11	599137
REGULATOR + COVER	↗02+24	593940
ROTOR	↗04	593926
STATOR	↗05	593869

Valeo

439311/437316

SG9B089

95

2

6V

14



90°

Ø 52,3

INC

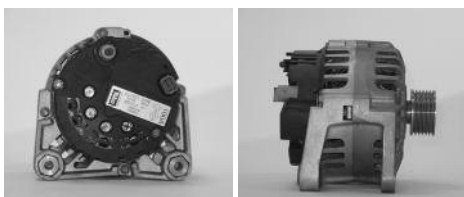

FRONT BEARING	↗21	593563
REAR BEARING	↗22	593564
PROTECTION COVER	↗24	593850
SEP:SEPARATED REGULATOR -INC:BUILT-IN REGULATOR	↗02	593689
RECTIFIER OR DIODE BRIDGE ASSEMBLY	↗07	595225
FRONT HOUSING	↗31	593647
ROTOR	↗04	593567
ROTOR	↗04	593996
STATOR	↗05	593579

Valeo

439467/437424

SG9B095

90

4

6V

14



90°

Ø 57,5

INC

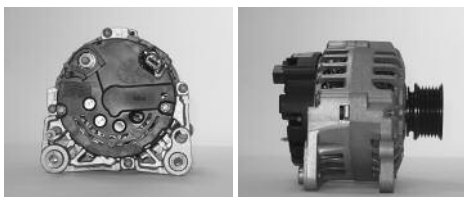

FRONT BEARING	↗21	593563
REAR BEARING	↗22	593564
PROTECTION COVER	↗24	593848
SEP:SEPARATED REGULATOR -INC:BUILT-IN REGULATOR	↗02	593813
RECTIFIER OR DIODE BRIDGE ASSEMBLY	↗07	593482
FRONT HOUSING	↗31	593644
REGULATOR + COVER	↗02+24	593940
ROTOR	↗04	593926
STATOR	↗05	593579

Valeo

439442/437401

SG9B107

95

2

3V

14



34à 45°

Ø 66,28

Picture not available
Image non disponible
Imagen no disponible
Immagine non disponibile
Nicht verfügbares Bild
Brak zdjęcia
Картина недоступна

Picture not available
Image non disponible
Imagen no disponible
Immagine non disponibile
Nicht verfügbares Bild
Brak zdjęcia
Картина недоступна

FRONT BEARING	↗21	593563
REAR BEARING	↗22	593564
PROTECTION COVER	↗24	593837
RECTIFIER OR DIODE BRIDGE ASSEMBLY	↗07	593408
FRONT HOUSING	↗31	593641
PULLEY	↗11	593614
REGULATOR + COVER	↗02+24	593936
ROTOR	↗04	593996
STATOR	↗05	593579

Valeo

439417/ 437373

SG9B108

100

4

6V

14



90°

Ø 50,48

INC

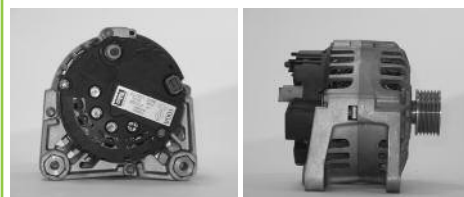

FRONT BEARING	↗21	593563
REAR BEARING	↗22	593564
PROTECTION COVER	↗24	593850
SEP:SEPARATED REGULATOR -INC:BUILT-IN REGULATOR	↗02	593689
RECTIFIER OR DIODE BRIDGE ASSEMBLY	↗07	595225
FRONT HOUSING	↗31	593647
ROTOR	↗04	593996
STATOR	↗05	593579

Valeo

439467/437424

SG9B121

90

5V

14



Ø 53

INC

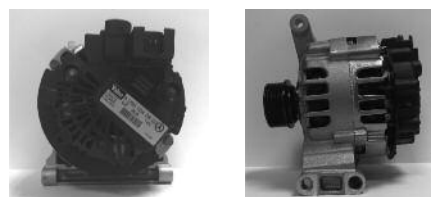

FRONT BEARING	↗21	593563
REAR BEARING	↗22	593564
PROTECTION COVER	↗24	593951
SEP:SEPARATED REGULATOR -INC:BUILT-IN REGULATOR	↗02	593948
RECTIFIER OR DIODE BRIDGE ASSEMBLY	↗07	593949
FRONT HOUSING	↗31	*595473
PULLEY	↗11	593950
ROTOR	↗04	593996
STATOR	↗05	593952

Valeo

439544/437537

STARS ST35C010 150 4 6V

14 ↻ 40° ∇ ∅ 53,7

Picture not available
Image non disponible
Imagen no disponible
Immagine non disponibile
Nicht verfügbares Bild
Brak zdjęcia
Картина недоступна

Picture not available
Image non disponible
Imagen no disponible
Immagine non disponibile
Nicht verfügbares Bild
Brak zdjęcia
Картина недоступна

STARS POWER CONNECTION 📎32

595420

Valeo**439900****STARS ST35C015** 130 6V

14 ↻ ∅ 52

Picture not available
Image non disponible
Imagen no disponible
Immagine non disponibile
Nicht verfügbares Bild
Brak zdjęcia
Картина недоступна

Picture not available
Image non disponible
Imagen no disponible
Immagine non disponibile
Nicht verfügbares Bild
Brak zdjęcia
Картина недоступна

STARS POWER CONNECTION 📎32

595422

Valeo**439902****STARS ST35C016** 120 2 6V

14 ↻ 85° ∇ ∅ 51,6

Picture not available
Image non disponible
Imagen no disponible
Immagine non disponibile
Nicht verfügbares Bild
Brak zdjęcia
Картина недоступна

Picture not available
Image non disponible
Imagen no disponible
Immagine non disponibile
Nicht verfügbares Bild
Brak zdjęcia
Картина недоступна

STARS POWER CONNECTION 📎32

595421

STARS POWER CONNECTION 📎32

595423

Valeo**439901****STARS ST35C017** 120 2 6V

14 ↻ 85° ∇ ∅ 51,6

Picture not available
Image non disponible
Imagen no disponible
Immagine non disponibile
Nicht verfügbares Bild
Brak zdjęcia
Картина недоступна

Picture not available
Image non disponible
Imagen no disponible
Immagine non disponibile
Nicht verfügbares Bild
Brak zdjęcia
Картина недоступна

STARS POWER CONNECTION 📎32

595421

STARS POWER CONNECTION 📎32

595423

STARS POWER CONNECTION 📎32

*599138

STARS POWER CONNECTION 📎32

*599139

Valeo**439901****TG10B013** 97 4 6V RL

14 ↻ 40° ∇ ∅ 57,5 INC

**FRONT BEARING** 📎21

593563

REAR BEARING 📎22

593564

SEP:SEPARATED REGULATOR -INC:BUILT-IN REGULATOR 📎02 593857**RECTIFIER OR DIODE BRIDGE ASSEMBLY** 📎07 593980**PULLEY FREE WHEEL + CAP PROTECTION** 📎11c 593832**ROTOR** 📎04 593800**STATOR** 📎05 593982**Valeo** **439553/437550****TG10B024** 97 4 6V RL

14 ↻ 40° ∇ ∅ 57,5 INC

**FRONT BEARING** 📎21

593563

REAR BEARING 📎22

593564

SEP:SEPARATED REGULATOR -INC:BUILT-IN REGULATOR 📎02 593857**RECTIFIER OR DIODE BRIDGE ASSEMBLY** 📎07 593980**PULLEY FREE WHEEL + CAP PROTECTION** 📎11c 593832**ROTOR** 📎04 593800**STATOR** 📎05 593982**Valeo** **439553/437550****TG10B025** 110 3 4V

14 ↻ 20° ∇ ∅ 56,28 INC

Picture not available
Image non disponible
Imagen no disponible
Immagine non disponibile
Nicht verfügbares Bild
Brak zdjęcia
Картина недоступна

Picture not available
Image non disponible
Imagen no disponible
Immagine non disponibile
Nicht verfügbares Bild
Brak zdjęcia
Картина недоступна

FRONT BEARING 📎21

593563

REAR BEARING 📎22

593564

PROTECTION COVER 📎24 *595430**SEP:SEPARATED REGULATOR -INC:BUILT-IN REGULATOR** 📎02 595253**RECTIFIER OR DIODE BRIDGE ASSEMBLY** 📎07 *595428**FRONT HOUSING** 📎31 *595427**PULLEY** 📎11 *595429**STATOR** 📎05 593982**Valeo** **439659/440245**

TG11C010

110

4

7V

14



90°

Ø 52,3

INC

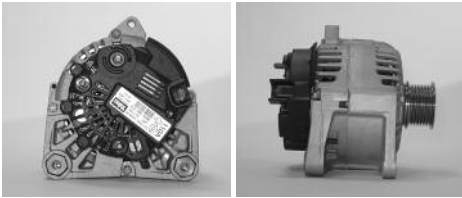

FRONT BEARING 21 593563
 REAR BEARING 22 593564
 PROTECTION COVER 24 593969
 SEP:SEPARATED REGULATOR -INC:BUILT-IN REGULATOR 02 593689
 FRONT HOUSING + STATOR 31+05 593665
 PULLEY 11 593836
 ROTOR 04 593800
Valeo 439479/437439

TG11C011 SP

110

4

14



90°

INC

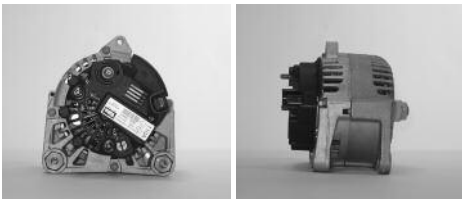

FRONT BEARING 21 593563
 REAR BEARING 22 593564
 PROTECTION COVER 24 593969
 SEP:SEPARATED REGULATOR -INC:BUILT-IN REGULATOR 02 593689
 FRONT HOUSING + STATOR 31+05 593665
 ROTOR 04 593800
Valeo 439475/437434

TG11C014

110

4

6V

14



90°

Ø 50,5

INC

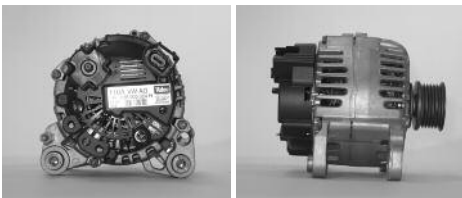

FRONT BEARING 21 593563
 REAR BEARING 22 593564
 PROTECTION COVER 24 593826
 SEP:SEPARATED REGULATOR -INC:BUILT-IN REGULATOR 02 593813
 RECTIFIER OR DIODE BRIDGE ASSEMBLY 07 593883
 FRONT HOUSING + STATOR 31+05 593827
 PULLEY 11 593868
 REGULATOR + COVER 02+24 593940
 ROTOR 04 593800
Valeo 439511/437502

TG11C015

110

4

6V

14



90°

Ø 50,5

INC

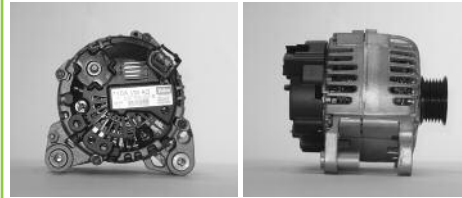

FRONT BEARING 21 593563
 REAR BEARING 22 593564
 PROTECTION COVER 24 593826
 SEP:SEPARATED REGULATOR -INC:BUILT-IN REGULATOR 02 593813
 RECTIFIER OR DIODE BRIDGE ASSEMBLY 07 593824
 FRONT HOUSING + STATOR 31+05 593827
 PULLEY 11 593825
 REGULATOR + COVER 02+24 593940
 ROTOR 04 593800
Valeo 439491/437456

TG11C016

110

4

6V

14



90°

Ø 57,2

INC

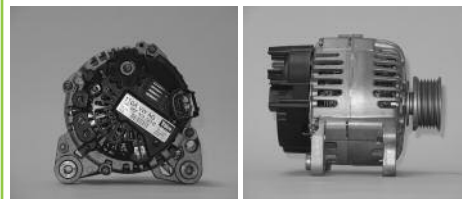

FRONT BEARING 21 593563
 REAR BEARING 22 593564
 PROTECTION COVER 24 593826
 SEP:SEPARATED REGULATOR -INC:BUILT-IN REGULATOR 02 593813
 RECTIFIER OR DIODE BRIDGE ASSEMBLY 07 593852
 FRONT HOUSING + STATOR 31+05 593854
 PULLEY 11 599137
 ROTOR 04 593800
Valeo 439500/437469

TG11C017

110

4

6V RL

14



90°

Ø 57,2

INC

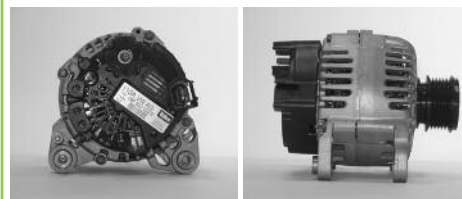

FRONT BEARING 21 593563
 REAR BEARING 22 593564
 PROTECTION COVER 24 593826
 SEP:SEPARATED REGULATOR -INC:BUILT-IN REGULATOR 02 593813
 RECTIFIER OR DIODE BRIDGE ASSEMBLY 07 593852
 FRONT HOUSING + STATOR 31+05 593854
 PULLEY FREE WHEEL + CAP PROTECTION 11c 593600
 REGULATOR + COVER 02+24 593940
 ROTOR 04 593800
Valeo 439501/437470



TG11C022

110 4 7V

14 ↻ 90° ∅ 52,3 INC

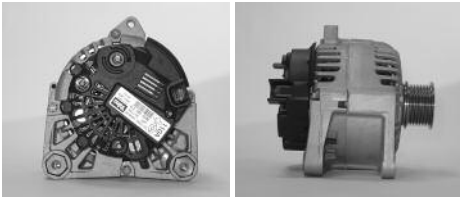

FRONT BEARING 🛠️ 21 593563
REAR BEARING 🛠️ 22 593564
PROTECTION COVER 🛠️ 24 593969
SEP:SEPARATED REGULATOR -INC:BUILT-IN REGULATOR 🛠️ 02 593689
FRONT HOUSING + STATOR 🛠️ 31+05 593665
PULLEY 🛠️ 11 593836
ROTOR 🛠️ 04 593800
Valeo 439479/437439

TG11C024

110 2 6V

14 ↻ 66° ∅ 62 INC

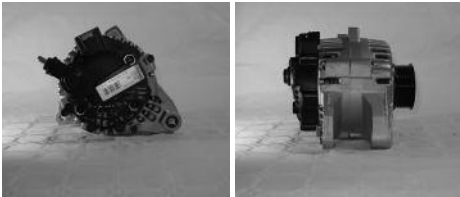

FRONT BEARING 🛠️ 21 593563
REAR BEARING 🛠️ 22 593564
PROTECTION COVER 🛠️ 24 593887
SEP:SEPARATED REGULATOR -INC:BUILT-IN REGULATOR 🛠️ 02 593884
RECTIFIER OR DIODE BRIDGE ASSEMBLY 🛠️ 07 593885
FRONT HOUSING + STATOR 🛠️ 31+05 593889
PULLEY 🛠️ 11 593886
ROTOR 🛠️ 04 593888

TG11C024

110 2 6V

14 ↻ 66° ∅ 62 INC

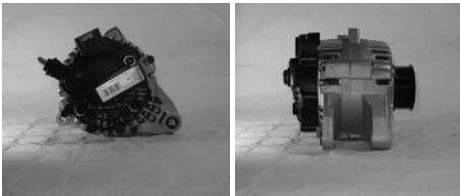

FRONT BEARING 🛠️ 21 593563
REAR BEARING 🛠️ 22 593564
PROTECTION COVER 🛠️ 24 593887
SEP:SEPARATED REGULATOR -INC:BUILT-IN REGULATOR 🛠️ 02 593884
RECTIFIER OR DIODE BRIDGE ASSEMBLY 🛠️ 07 593885
FRONT HOUSING + STATOR 🛠️ 31+05 593889
PULLEY 🛠️ 11 593886
ROTOR 🛠️ 04 593888

TG11C024

110 2 6V

14 ↻ 66° ∅ 62 INC

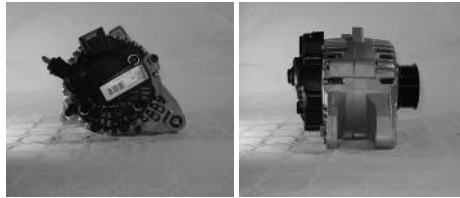

FRONT BEARING 🛠️ 21 593563
REAR BEARING 🛠️ 22 593564
PROTECTION COVER 🛠️ 24 593887
SEP:SEPARATED REGULATOR -INC:BUILT-IN REGULATOR 🛠️ 02 593884
RECTIFIER OR DIODE BRIDGE ASSEMBLY 🛠️ 07 593885
FRONT HOUSING + STATOR 🛠️ 31+05 593889
PULLEY 🛠️ 11 593886
ROTOR 🛠️ 04 593888

TG11C024

110 2 6V

14 ↻ 66° ∅ 62 INC

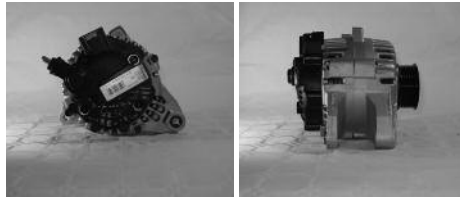

FRONT BEARING 🛠️ 21 593563
REAR BEARING 🛠️ 22 593564
PROTECTION COVER 🛠️ 24 593887
SEP:SEPARATED REGULATOR -INC:BUILT-IN REGULATOR 🛠️ 02 593884
RECTIFIER OR DIODE BRIDGE ASSEMBLY 🛠️ 07 593885
FRONT HOUSING + STATOR 🛠️ 31+05 593889
PULLEY 🛠️ 11 593886
ROTOR 🛠️ 04 593888
Valeo 439295/437488

TG11C027

110 4 6V

14 ↻ 90° ∅ 56,38 INC



FRONT BEARING 🛠️ 21 593563
REAR BEARING 🛠️ 22 593564
PROTECTION COVER 🛠️ 24 593969
SEP:SEPARATED REGULATOR -INC:BUILT-IN REGULATOR 🛠️ 02 593689
FRONT HOUSING + STATOR 🛠️ 31+05 593665
PULLEY 🛠️ 11 595217
ROTOR 🛠️ 04 593800
Valeo 439578/440036

TG11C034

110

4

6V

14



90°

Ø 56,28

INC

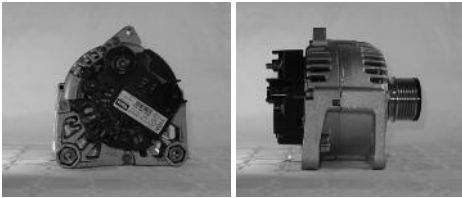

FRONT BEARING 21 593563
 REAR BEARING 22 593564
 PROTECTION COVER 24 593969
 SEP:SEPARATED REGULATOR -INC:BUILT-IN REGULATOR 02 593689
 FRONT HOUSING + STATOR 31+05 593665
 PULLEY FREE WEEL + CAP PROTECTION 11c *595407
 ROTOR 04 593800
Valeo 439561/437558

TG11C035

115

5V RL

14



Ø 53,3

INC



FRONT BEARING 21 *595474
 REAR BEARING 22 593564
 PROTECTION COVER 24 593951
 SEP:SEPARATED REGULATOR -INC:BUILT-IN REGULATOR 02 *595385
 RECTIFIER OR DIODE BRIDGE ASSEMBLY 07 593976
 FRONT HOUSING + STATOR 31+05 593978
 PULLEY FREE WEEL + CAP PROTECTION 11c *595386
 ROTOR 04 593800
Valeo 439551/437544

TG11C036

115

1

5V

14



33°

Ø 51

INC

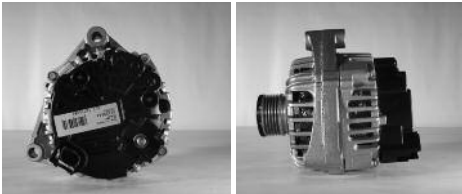

FRONT BEARING 21 593563
 REAR BEARING 22 593564
 PROTECTION COVER 24 593826
 SEP:SEPARATED REGULATOR -INC:BUILT-IN REGULATOR 02 593928
 RECTIFIER OR DIODE BRIDGE ASSEMBLY 07 593929
 ROTOR 04 593800
Valeo 439538/437532

TG11C040

110

4

7V

14



90°

Ø 50,48

INC

Picture not available
 Image non disponible
 Imagen no disponible
 Immagine non disponibile
 Nicht verfügbares Bild
 Brak zdjęcia
 Картина недоступна

Picture not available
 Image non disponible
 Imagen no disponible
 Immagine non disponibile
 Nicht verfügbares Bild
 Brak zdjęcia
 Картина недоступна

FRONT BEARING 21 593563
 REAR BEARING 22 593564
 PROTECTION COVER 24 593969
 SEP:SEPARATED REGULATOR -INC:BUILT-IN REGULATOR 02 595253
 FRONT HOUSING + STATOR 31+05 593665
 PULLEY 11 593836
 ROTOR 04 593800
Valeo 439588/440060

TG11C041

110

4

6V RL

14



90°

Ø 56,47

INC

Picture not available
 Image non disponible
 Imagen no disponible
 Immagine non disponibile
 Nicht verfügbares Bild
 Brak zdjęcia
 Картина недоступна

Picture not available
 Image non disponible
 Imagen no disponible
 Immagine non disponibile
 Nicht verfügbares Bild
 Brak zdjęcia
 Картина недоступна

FRONT BEARING 21 593563
 REAR BEARING 22 593564
 PROTECTION COVER 24 593969
 SEP:SEPARATED REGULATOR -INC:BUILT-IN REGULATOR 02 595253
 FRONT HOUSING + STATOR 31+05 593665
 PULLEY FREE WEEL + CAP PROTECTION 11c *595407
 ROTOR 04 593800
Valeo 439593/440068

TG11C048

110

4

6V RL

14



90°

Ø 50,5

INC

Picture not available
 Image non disponible
 Imagen no disponible
 Immagine non disponibile
 Nicht verfügbares Bild
 Brak zdjęcia
 Картина недоступна

Picture not available
 Image non disponible
 Imagen no disponible
 Immagine non disponibile
 Nicht verfügbares Bild
 Brak zdjęcia
 Картина недоступна

FRONT BEARING 21 593563
 REAR BEARING 22 593564
 PROTECTION COVER 24 593826
 SEP:SEPARATED REGULATOR -INC:BUILT-IN REGULATOR 02 593813
 RECTIFIER OR DIODE BRIDGE ASSEMBLY 07 593824
 FRONT HOUSING + STATOR 31+05 593827
 PULLEY FREE WEEL + CAP PROTECTION 11c *595440
 REGULATOR + COVER 02+24 593940
 ROTOR 04 593800
Valeo 439580/440038



TG11C049

110 4 7V

14 ↻ 90° ▷ ∅ 50,48 INC

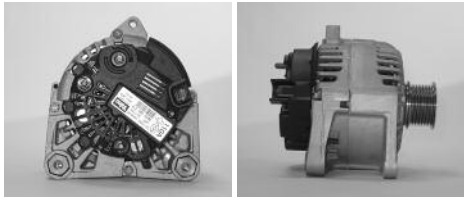

FRONT BEARING 🛠️ 21	593563
REAR BEARING 🛠️ 22	593564
PROTECTION COVER 🛠️ 24	593969
SEP:SEPARATED REGULATOR -INC:BUILT-IN REGULATOR 🛠️ 02	593689
FRONT HOUSING + STATOR 🛠️ 31+05	593665
PULLEY 🛠️ 11	593836
ROTOR 🛠️ 04	593800
Valeo	439479/437439

TG11C055

110 4 6V

14 ↻ 90° ▷ ∅ 56,38 INC

Picture not available Image non disponible Imagen no disponible Immagine non disponibile Nicht verfügbares Bild Brak zdjęcia Картина недоступна	Picture not available Image non disponible Imagen no disponible Immagine non disponibile Nicht verfügbares Bild Brak zdjęcia Картина недоступна
---	---

FRONT BEARING 🛠️ 21	593563
REAR BEARING 🛠️ 22	593564
PROTECTION COVER 🛠️ 24	593969
SEP:SEPARATED REGULATOR -INC:BUILT-IN REGULATOR 🛠️ 02	595253
FRONT HOUSING + STATOR 🛠️ 31+05	593665
PULLEY 🛠️ 11	595217
ROTOR 🛠️ 04	593800
Valeo	439591/440065

TG11C056

115 4 7V

14 ↻ 90° ▷ ∅ 56 INC

Picture not available Image non disponible Imagen no disponible Immagine non disponibile Nicht verfügbares Bild Brak zdjęcia Картина недоступна	Picture not available Image non disponible Imagen no disponible Immagine non disponibile Nicht verfügbares Bild Brak zdjęcia Картина недоступна
---	---

SEP:SEPARATED REGULATOR -INC:BUILT-IN REGULATOR 🛠️ 02	595253
RECTIFIER OR DIODE BRIDGE ASSEMBLY 🛠️ 07	595261
Valeo	439596/440092

TG11C057

110 4 6V

14 ↻ 90° ▷ ∅ 50,5 INC

Picture not available Image non disponible Imagen no disponible Immagine non disponibile Nicht verfügbares Bild Brak zdjęcia Картина недоступна	Picture not available Image non disponible Imagen no disponible Immagine non disponibile Nicht verfügbares Bild Brak zdjęcia Картина недоступна
---	---

FRONT BEARING 🛠️ 21	593563
REAR BEARING 🛠️ 22	593564
PROTECTION COVER 🛠️ 24	593826
RECTIFIER OR DIODE BRIDGE ASSEMBLY 🛠️ 07	593824
FRONT HOUSING + STATOR 🛠️ 31+05	593827
PULLEY 🛠️ 11	*595356
REGULATOR + COVER 🛠️ 02+24	593940
ROTOR 🛠️ 04	593800
Valeo	439637/440204

TG11C059

115 1 5V RL

14 ↻ 70° ▷ ∅ 51 INC

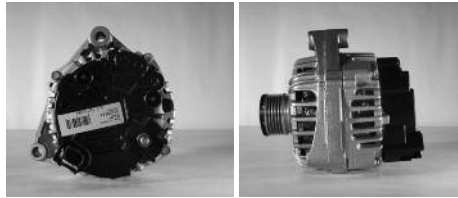

FRONT BEARING 🛠️ 21	593563
REAR BEARING 🛠️ 22	593564
PROTECTION COVER 🛠️ 24	593826
SEP:SEPARATED REGULATOR -INC:BUILT-IN REGULATOR 🛠️ 02*	595476
RECTIFIER OR DIODE BRIDGE ASSEMBLY 🛠️ 07	593929
PULLEY FREE WHEEL + CAP PROTECTION 🛠️ 11c	599104
ROTOR 🛠️ 04	593800
Valeo	439538/437532

TG11C060

110 4 6V

14 ↻ 90° ▷ ∅ 56,38 INC

Picture not available Image non disponible Imagen no disponible Immagine non disponibile Nicht verfügbares Bild Brak zdjęcia Картина недоступна	Picture not available Image non disponible Imagen no disponible Immagine non disponibile Nicht verfügbares Bild Brak zdjęcia Картина недоступна
---	---

FRONT BEARING 🛠️ 21	593563
REAR BEARING 🛠️ 22	593564
PROTECTION COVER 🛠️ 24	593969
SEP:SEPARATED REGULATOR -INC:BUILT-IN REGULATOR 🛠️ 02	595253
RECTIFIER OR DIODE BRIDGE ASSEMBLY 🛠️ 07	595362
FRONT HOUSING + STATOR 🛠️ 31+05	593665
PULLEY 🛠️ 11	595217
ROTOR 🛠️ 04	593800
Valeo	439591/440065

TG11C061

110 4 7V

14 ↻ 90° ▷ ∅ 50,38 INC

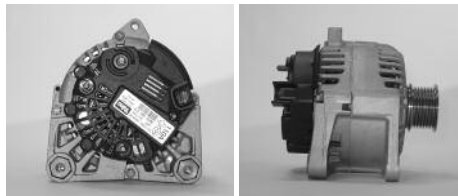

FRONT BEARING 🛠️ 21	593563
REAR BEARING 🛠️ 22	593564
PROTECTION COVER 🛠️ 24	593969
SEP:SEPARATED REGULATOR -INC:BUILT-IN REGULATOR 🛠️ 02	593689
RECTIFIER OR DIODE BRIDGE ASSEMBLY 🛠️ 07	595362
FRONT HOUSING + STATOR 🛠️ 31+05	593665
PULLEY 🛠️ 11	593836
ROTOR 🛠️ 04	593800
Valeo	439479/437439

TG11C063

110

4

6V

14



90°

Ø 56,38

INC

Picture not available
Image non disponible
Imagen no disponible
Immagine non disponibile
Nicht verfügbares Bild
Brak zdjęcia
Картина недоступна

Picture not available
Image non disponible
Imagen no disponible
Immagine non disponibile
Nicht verfügbares Bild
Brak zdjęcia
Картина недоступна

FRONT BEARING 21 593563**REAR BEARING** 22 593564**PROTECTION COVER** 24 593969**SEP:SEPARATED REGULATOR -INC:BUILT-IN REGULATOR** 02 593689**RECTIFIER OR DIODE BRIDGE ASSEMBLY** 07 593362**FRONT HOUSING + STATOR** 31+05 593665**PULLEY** 11 595217**ROTOR** 04 593800**Valeo****439578/440036****TG11C064**

110

4

6V RL

14



90°

Ø 56,47

INC

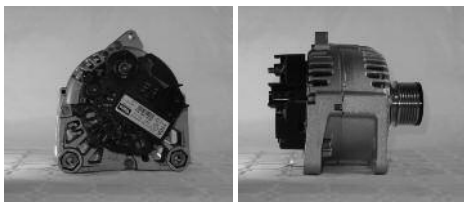
**FRONT BEARING** 21 593563**REAR BEARING** 22 593564**PROTECTION COVER** 24 593969**SEP:SEPARATED REGULATOR -INC:BUILT-IN REGULATOR** 02 593689**RECTIFIER OR DIODE BRIDGE ASSEMBLY** 07 593362**FRONT HOUSING + STATOR** 31+05 593665**PULLEY FREE WHEEL + CAP PROTECTION** 11c *595407**ROTOR** 04 593800**Valeo****439561/437558****TG11C065**

110

4

7V

14



90°

Ø 50,38

INC

Picture not available
Image non disponible
Imagen no disponible
Immagine non disponibile
Nicht verfügbares Bild
Brak zdjęcia
Картина недоступна

Picture not available
Image non disponible
Imagen no disponible
Immagine non disponibile
Nicht verfügbares Bild
Brak zdjęcia
Картина недоступна

FRONT BEARING 21 593563**REAR BEARING** 22 593564**PROTECTION COVER** 24 593969**SEP:SEPARATED REGULATOR -INC:BUILT-IN REGULATOR** 02 593689**RECTIFIER OR DIODE BRIDGE ASSEMBLY** 07 593362**FRONT HOUSING + STATOR** 31+05 593665**PULLEY** 11 593836**ROTOR** 04 593800**Valeo****439588/440060****TG11C066**

110

4

6V RL

14



90°

Ø 56,47

INC

Picture not available
Image non disponible
Imagen no disponible
Immagine non disponibile
Nicht verfügbares Bild
Brak zdjęcia
Картина недоступна

Picture not available
Image non disponible
Imagen no disponible
Immagine non disponibile
Nicht verfügbares Bild
Brak zdjęcia
Картина недоступна

FRONT BEARING 21 593563**REAR BEARING** 22 593564**PROTECTION COVER** 24 593969**SEP:SEPARATED REGULATOR -INC:BUILT-IN REGULATOR** 02 593689**FRONT HOUSING + STATOR** 31+05 593665**PULLEY FREE WHEEL + CAP PROTECTION** 11c *595407**ROTOR** 04 593800**Valeo****439593/440068****TG11C067**

110

4

6V RL

14



90°

Ø 50,5

Picture not available
Image non disponible
Imagen no disponible
Immagine non disponibile
Nicht verfügbares Bild
Brak zdjęcia
Картина недоступна

Picture not available
Image non disponible
Imagen no disponible
Immagine non disponibile
Nicht verfügbares Bild
Brak zdjęcia
Картина недоступна

FRONT BEARING 21 593563**REAR BEARING** 22 593564**PROTECTION COVER** 24 593826**SEP:SEPARATED REGULATOR -INC:BUILT-IN REGULATOR** 02 593813**RECTIFIER OR DIODE BRIDGE ASSEMBLY** 07 593852**FRONT HOUSING + STATOR** 31+05 593854**PULLEY FREE WHEEL + CAP PROTECTION** 11c 595282**ROTOR** 04 *595434**Valeo****439752/440342****TG11C068**

110

4

7V

14



90°

Ø 56,08

INC

Picture not available
Image non disponible
Imagen no disponible
Immagine non disponibile
Nicht verfügbares Bild
Brak zdjęcia
Картина недоступна

Picture not available
Image non disponible
Imagen no disponible
Immagine non disponibile
Nicht verfügbares Bild
Brak zdjęcia
Картина недоступна

FRONT BEARING 21 593563**REAR BEARING** 22 593564**PROTECTION COVER** 24 593969**SEP:SEPARATED REGULATOR -INC:BUILT-IN REGULATOR** 02 593689**RECTIFIER OR DIODE BRIDGE ASSEMBLY** 07 593362**FRONT HOUSING + STATOR** 31+05 593665**PULLEY** 11 *595409**ROTOR** 04 *593664**Valeo****439596/440092**

TG11C069

110 4 6V RL

14 ↻ 90° ▷ ∅ 56,47 INC

Picture not available
Image non disponible
Imagen no disponible
Immagine non disponibile
Nicht verfügbares Bild
Brak zdjęcia
Картина недоступна

Picture not available
Image non disponible
Imagen no disponible
Immagine non disponibile
Nicht verfügbares Bild
Brak zdjęcia
Картина недоступна

FRONT BEARING 📏21 593563
REAR BEARING 📏22 593564
PROTECTION COVER 📏24 593969
SEP:SEPARATED REGULATOR -INC:BUILT-IN REGULATOR 📏02 595253
RECTIFIER OR DIODE BRIDGE ASSEMBLY 📏07 593362
FRONT HOUSING + STATOR 📏31+05 593665
PULLEY FREE WEEL + CAP PROTECTION 📏11c *595407
ROTOR 📏04 593800

Valeo

439593/440068

TG11C073

110 2 6V

14 ↻ 75-85° ▷ ∅ 50,5

Picture not available
Image non disponible
Imagen no disponible
Immagine non disponibile
Nicht verfügbares Bild
Brak zdjęcia
Картина недоступна

Picture not available
Image non disponible
Imagen no disponible
Immagine non disponibile
Nicht verfügbares Bild
Brak zdjęcia
Картина недоступна

FRONT BEARING 📏21 593563
REAR BEARING 📏22 593564
PROTECTION COVER 📏24 593826
SEP:SEPARATED REGULATOR -INC:BUILT-IN REGULATOR 📏02 593813
RECTIFIER OR DIODE BRIDGE ASSEMBLY 📏07 *595435
PULLEY 📏11 593868
REAR BRACKET + STATOR 📏30+05 *595433
ROTOR 📏04 *595434

Valeo

439666/440251

TG11C074

115 5V RL

14 ↻ ∅ 53,3 INC

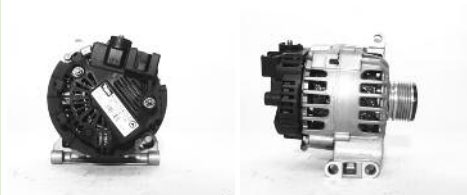

FRONT BEARING 📏21 593563
REAR BEARING 📏22 593564
PROTECTION COVER 📏24 593951
SEP:SEPARATED REGULATOR -INC:BUILT-IN REGULATOR 📏02 *595385
RECTIFIER OR DIODE BRIDGE ASSEMBLY 📏07 593976
FRONT HOUSING + STATOR 📏31+05 *595475
PULLEY FREE WEEL + CAP PROTECTION 📏11c *595386
ROTOR 📏04 593800

Valeo

439551/437544

TG11C086

110 4 6V RL

14 ↻ 90° ▷ ∅ 50,5

Picture not available
Image non disponible
Imagen no disponible
Immagine non disponibile
Nicht verfügbares Bild
Brak zdjęcia
Картина недоступна

Picture not available
Image non disponible
Imagen no disponible
Immagine non disponibile
Nicht verfügbares Bild
Brak zdjęcia
Картина недоступна

FRONT BEARING 📏21 593563
REAR BEARING 📏22 593564
PROTECTION COVER 📏24 593826
SEP:SEPARATED REGULATOR -INC:BUILT-IN REGULATOR 📏02 593813
RECTIFIER OR DIODE BRIDGE ASSEMBLY 📏07 593883
FRONT HOUSING + STATOR 📏31+05 593827
PULLEY FREE WEEL + CAP PROTECTION 📏11c *595440
ROTOR 📏04 593800

Valeo

439733/440323

TG11C094

110 4 6V RL

14 ↻ 90° ▷ ∅ 50,5

Picture not available
Image non disponible
Imagen no disponible
Immagine non disponibile
Nicht verfügbares Bild
Brak zdjęcia
Картина недоступна

Picture not available
Image non disponible
Imagen no disponible
Immagine non disponibile
Nicht verfügbares Bild
Brak zdjęcia
Картина недоступна

FRONT BEARING 📏21 593563
REAR BEARING 📏22 593564
PROTECTION COVER 📏24 593826
SEP:SEPARATED REGULATOR -INC:BUILT-IN REGULATOR 📏02 *599140
RECTIFIER OR DIODE BRIDGE ASSEMBLY 📏07 593883
FRONT HOUSING + STATOR 📏31+05 593827
PULLEY FREE WEEL + CAP PROTECTION 📏11c *595440
ROTOR 📏04 593800

Valeo

439755/440345

TG11C095

110 4 6V RL

14 ↻ 90° ▷ ∅ 50,5

Picture not available
Image non disponible
Imagen no disponible
Immagine non disponibile
Nicht verfügbares Bild
Brak zdjęcia
Картина недоступна

Picture not available
Image non disponible
Imagen no disponible
Immagine non disponibile
Nicht verfügbares Bild
Brak zdjęcia
Картина недоступна

FRONT BEARING 📏21 593563
REAR BEARING 📏22 593564
PROTECTION COVER 📏24 593826
SEP:SEPARATED REGULATOR -INC:BUILT-IN REGULATOR 📏02 *599140
RECTIFIER OR DIODE BRIDGE ASSEMBLY 📏07 593824
FRONT HOUSING + STATOR 📏31+05 593827
PULLEY FREE WEEL + CAP PROTECTION 📏11c *595440
ROTOR 📏04 593800

Valeo

439754/440344

TG11C096

110

4

6V RL

14



90°

Ø 57,2

Picture not available
Image non disponible
Imagen no disponible
Immagine non disponibile
Nicht verfügbares Bild
Brak zdjęćia
Картина недоступна

Picture not available
Image non disponible
Imagen no disponible
Immagine non disponibile
Nicht verfügbares Bild
Brak zdjęćia
Картина недоступна

FRONT BEARING 21

593563

REAR BEARING 22

593564

PROTECTION COVER 24

593826

SEP:SEPARATED REGULATOR -INC:BUILT-IN REGULATOR 02 593813**RECTIFIER OR DIODE BRIDGE ASSEMBLY** 07

593883

FRONT HOUSING + STATOR 31+05

593827

PULLEY FREE WEEL + CAP PROTECTION 11c

593600

ROTOR 04

593800

Valeo

439719/440309

TG12C013

110

6V

14



Ø 61

INC

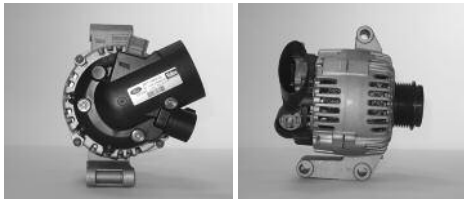
**FRONT BEARING** 21

593563

REAR BEARING 22

593564

SEP:SEPARATED REGULATOR -INC:BUILT-IN REGULATOR 02 593675**FRONT HOUSING + STATOR** 31+05

593784

PULLEY FREE WEEL + CAP PROTECTION 11c

593782

PROTECTION COVER 24

593908

ROTOR 04

593800

Valeo

439483/437448

TG12C015

120

6V

14



Ø 60

INC

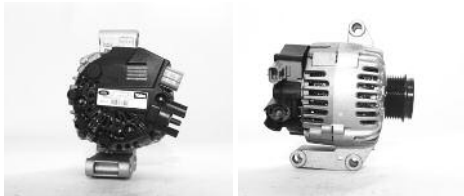
**FRONT BEARING** 21

593563

REAR BEARING 22

593564

PROTECTION COVER 24 *599122**FRONT HOUSING + STATOR** 31+05

593784

PULLEY FREE WEEL + CAP PROTECTION 11c

593782

REGULATOR + COVER 02+24

*599121

ROTOR 04

593800

Valeo

439533/437524

TG12C016

110

6V

14



Ø 65

INC

**FRONT BEARING** 21

593563

REAR BEARING 22

593564

SEP:SEPARATED REGULATOR -INC:BUILT-IN REGULATOR 02 593845**FRONT HOUSING + STATOR** 31+05

593784

PULLEY FREE WEEL + CAP PROTECTION 11c

593782

ROTOR 04

593800

Valeo

439569/437585

TG12C026

120

7V RL

14



Ø 57

INC

Picture not available
Image non disponible
Imagen no disponible
Immagine non disponibile
Nicht verfügbares Bild
Brak zdjęćia
Картина недоступна

Picture not available
Image non disponible
Imagen no disponible
Immagine non disponibile
Nicht verfügbares Bild
Brak zdjęćia
Картина недоступна

FRONT BEARING 21

593563

REAR BEARING 22

593564

PROTECTION COVER 24

595296

SEP:SEPARATED REGULATOR -INC:BUILT-IN REGULATOR 02 595294**SEP:SEPARATED REGULATOR -INC:BUILT-IN REGULATOR** 02* 595476**RECTIFIER OR DIODE BRIDGE ASSEMBLY** 07

595300

FRONT HOUSING + STATOR 31+05

595301

PULLEY FREE WEEL + CAP PROTECTION 11c

595258

ROTOR 04

593800

Valeo

439611/440128

TG12C033 Sans Marquage KIA

120

2

5V RL

14



55°

Ø 58,33

INC

Picture not available
Image non disponible
Imagen no disponible
Immagine non disponibile
Nicht verfügbares Bild
Brak zdjęćia
Картина недоступна

Picture not available
Image non disponible
Imagen no disponible
Immagine non disponibile
Nicht verfügbares Bild
Brak zdjęćia
Картина недоступна

FRONT BEARING 21

593563

REAR BEARING 22

593564

PROTECTION COVER 24 *595335**SEP:SEPARATED REGULATOR -INC:BUILT-IN REGULATOR** 02 595283**RECTIFIER OR DIODE BRIDGE ASSEMBLY** 07

595284

FRONT HOUSING + STATOR 31+05

595285

PULLEY FREE WEEL + CAP PROTECTION 11c

595286

ROTOR 04

593800

Valeo

439607/440123



TG12C038

120 2 6V RL

14 ↻ 79° ∇ ∅ 55,29 INC

Picture not available
Image non disponible
Imagen no disponible
Imagine non disponibile
Nicht verfügbares Bild
Brak zdjęcia
Картина недоступна

Picture not available
Image non disponible
Imagen no disponible
Imagine non disponibile
Nicht verfügbares Bild
Brak zdjęcia
Картина недоступна

FRONT BEARING 📏21 593563
REAR BEARING 📏22 593564
PROTECTION COVER 📏24 *595373
SEP:SEPARATED REGULATOR -INC:BUILT-IN REGULATOR 📏02 *595393
RECTIFIER OR DIODE BRIDGE ASSEMBLY 📏07 *595374
PULLEY FREE WEEL + CAP PROTECTION 📏11c 593832
ROTOR 📏04 593800

Valeo**439632/440199****TG12C059**

125 6V RL

14 ↻ ∅ 53,2 INC

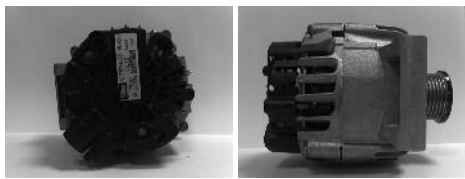
B+(M8)

FRONT BEARING 📏21 593563
REAR BEARING 📏22 593564
SEP:SEPARATED REGULATOR -INC:BUILT-IN REGULATOR 📏02 *599149
RECTIFIER OR DIODE BRIDGE ASSEMBLY 📏07 *595321
FRONT HOUSING + STATOR 📏31+05 *595320
PULLEY FREE WEEL + CAP PROTECTION 📏11c *595317
ROTOR 📏04 *595413

Valeo**439617/440174****TG12C062**

120 4 7V

14 ↻ 90° ∇ ∅ 52,3 INC

Picture not available
Image non disponible
Imagen no disponible
Imagine non disponibile
Nicht verfügbares Bild
Brak zdjęcia
Картина недоступна

Picture not available
Image non disponible
Imagen no disponible
Imagine non disponibile
Nicht verfügbares Bild
Brak zdjęcia
Картина недоступна

FRONT BEARING 📏21 593563
REAR BEARING 📏22 593564
PROTECTION COVER 📏24 593969
RECTIFIER OR DIODE BRIDGE ASSEMBLY 📏07 *595414
PULLEY 📏11 593836
ROTOR 📏04 *595413

Valeo**439648/440218****TG12C063**

120 6V RL

14 ↻ ∅ 51

Picture not available
Image non disponible
Imagen no disponible
Imagine non disponibile
Nicht verfügbares Bild
Brak zdjęcia
Картина недоступна

Picture not available
Image non disponible
Imagen no disponible
Imagine non disponibile
Nicht verfügbares Bild
Brak zdjęcia
Картина недоступна

FRONT BEARING 📏21 593563
REAR BEARING 📏22 593564
PROTECTION COVER 📏24 595296
SEP:SEPARATED REGULATOR -INC:BUILT-IN REGULATOR 📏02 *595476
RECTIFIER OR DIODE BRIDGE ASSEMBLY 📏07 595300
ROTOR 📏04 593800

Valeo**439678/440263****TG12C077**

120 4 7V RL

14 ↻ 90° ∇ ∅ 50,08

Picture not available
Image non disponible
Imagen no disponible
Imagine non disponibile
Nicht verfügbares Bild
Brak zdjęcia
Картина недоступна

Picture not available
Image non disponible
Imagen no disponible
Imagine non disponibile
Nicht verfügbares Bild
Brak zdjęcia
Картина недоступна

FRONT BEARING 📏21 593563
REAR BEARING 📏22 593564
PROTECTION COVER 📏24 593969
RECTIFIER OR DIODE BRIDGE ASSEMBLY 📏07 *595414
PULLEY FREE WEEL + CAP PROTECTION 📏11c 593514
ROTOR 📏04 *595413

Valeo**439662/440247****TG12C078**

120 4 6V RL

14 ↻ 90° ∇ ∅ 56,47

Picture not available
Image non disponible
Imagen no disponible
Imagine non disponibile
Nicht verfügbares Bild
Brak zdjęcia
Картина недоступна

Picture not available
Image non disponible
Imagen no disponible
Imagine non disponibile
Nicht verfügbares Bild
Brak zdjęcia
Картина недоступна

FRONT BEARING 📏21 593563
REAR BEARING 📏22 593564
PROTECTION COVER 📏24 593969
RECTIFIER OR DIODE BRIDGE ASSEMBLY 📏07 *595414
PULLEY FREE WEEL + CAP PROTECTION 📏11c *595407
ROTOR 📏04 *595413

Valeo**439677/440262****TG12C090**

120 2 5V RL

14 ↻ 55° ∇ ∅ 58,33

Picture not available
Image non disponible
Imagen no disponible
Imagine non disponibile
Nicht verfügbares Bild
Brak zdjęcia
Картина недоступна

Picture not available
Image non disponible
Imagen no disponible
Imagine non disponibile
Nicht verfügbares Bild
Brak zdjęcia
Картина недоступна

FRONT BEARING 📏21 593563
REAR BEARING 📏22 593564
PROTECTION COVER 📏24 *599061
RECTIFIER OR DIODE BRIDGE ASSEMBLY 📏07 595284
PULLEY FREE WEEL + CAP PROTECTION 📏11c 595286
REGULATOR + COVER 📏02+24 *599160
ROTOR 📏04 593800

Valeo**439683/440268**

TG12C092

120

4

7V RL

14



90°

Ø 50,08

Picture not available
Image non disponible
Imagen no disponible
Immagine non disponibile
Nicht verfügbares Bild
Brak zdjęcia
Картина недоступна

Picture not available
Image non disponible
Imagen no disponible
Immagine non disponibile
Nicht verfügbares Bild
Brak zdjęcia
Картина недоступна

FRONT BEARING 21

593563

REAR BEARING 22

593564

PROTECTION COVER 24

593969

SEP:SEPARATED REGULATOR -INC:BUILT-IN REGULATOR 02 593689**RECTIFIER OR DIODE BRIDGE ASSEMBLY** 07 *595414**PULLEY FREE WEEL + CAP PROTECTION** 11c 593514**ROTOR** 04 *595413**Valeo**

439790/440427

TG12C094

120

2

6V RL

14



90°

Ø 56,47 INC

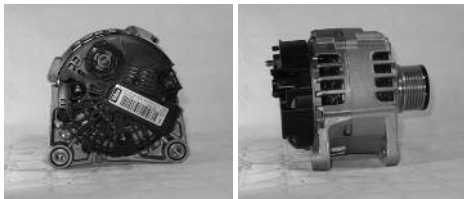
**FRONT BEARING** 21

593563

REAR BEARING 22

593564

PROTECTION COVER 24

593969

SEP:SEPARATED REGULATOR -INC:BUILT-IN REGULATOR 02 593689**RECTIFIER OR DIODE BRIDGE ASSEMBLY** 07 *595414**PULLEY FREE WEEL + CAP PROTECTION** 11c *595407**ROTOR** 04 *595413**TG12C094**

120

2

6V RL

14



90°

Ø 56,47 INC

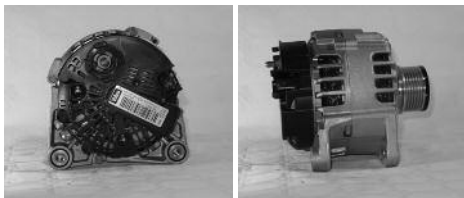
**FRONT BEARING** 21

593563

REAR BEARING 22

593564

PROTECTION COVER 24

593969

SEP:SEPARATED REGULATOR -INC:BUILT-IN REGULATOR 02 593689**RECTIFIER OR DIODE BRIDGE ASSEMBLY** 07 *595414**PULLEY FREE WEEL + CAP PROTECTION** 11c *595407**ROTOR** 04 *595413**Valeo**

439680/440265

TG12C106

120

4

6V RL

14



78°

Ø 55,29

Picture not available
Image non disponible
Imagen no disponible
Immagine non disponibile
Nicht verfügbares Bild
Brak zdjęcia
Картина недоступна

Picture not available
Image non disponible
Imagen no disponible
Immagine non disponibile
Nicht verfügbares Bild
Brak zdjęcia
Картина недоступна

FRONT BEARING 21

593563

REAR BEARING 22

593564

PULLEY FREE WEEL + CAP PROTECTION 11c 593832**ROTOR** 04 593800**Valeo**

439758/440350

TG12C118

120

2

5V RL

14



55°

Ø 58,25

Picture not available
Image non disponible
Imagen no disponible
Immagine non disponibile
Nicht verfügbares Bild
Brak zdjęcia
Картина недоступна

Picture not available
Image non disponible
Imagen no disponible
Immagine non disponibile
Nicht verfügbares Bild
Brak zdjęcia
Картина недоступна

FRONT BEARING 21

593563

REAR BEARING 22

593564

PROTECTION COVER 24

*599061

RECTIFIER OR DIODE BRIDGE ASSEMBLY 07 *599201**REGULATOR + COVER** 02+24 *599160**ROTOR** 04 593800**Valeo**

439760/440352

TG12C120

120

6V RL

14



Ø 50,76

INC

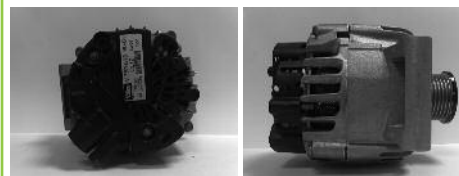
**B+(M8)****FRONT BEARING** 21

593563

REAR BEARING 22

593564

PROTECTION COVER 24

*595460

SEP:SEPARATED REGULATOR -INC:BUILT-IN REGULATOR 02 *599149**RECTIFIER OR DIODE BRIDGE ASSEMBLY** 07 *595321**FRONT HOUSING + STATOR** 31+05 *595320**PULLEY FREE WEEL + CAP PROTECTION** 11c *595317**ROTOR** 04 *595413**Valeo**

439617/440174

TG12C140

120

2

5V RL

14



55°

Ø 58,33

Picture not available
Image non disponible
Imagen no disponible
Immagine non disponibile
Nicht verfügbares Bild
Brak zdjęcia
Картина недоступна

Picture not available
Image non disponible
Imagen no disponible
Immagine non disponibile
Nicht verfügbares Bild
Brak zdjęcia
Картина недоступна

FRONT BEARING 21

593563

REAR BEARING 22

593564

RECTIFIER OR DIODE BRIDGE ASSEMBLY 07 *599201**PULLEY FREE WEEL + CAP PROTECTION** 11c 595286**ROTOR** 04 593800**Valeo**

439683/440268

TG12C141

120

2

5V RL

14



55°

Ø 58,25

Picture not available
Image non disponible
Imagen no disponible
Immagine non disponibile
Nicht verfügbares Bild
Brak zdjęcia
Картина недоступна

Picture not available
Image non disponible
Imagen no disponible
Immagine non disponibile
Nicht verfügbares Bild
Brak zdjęcia
Картина недоступна

FRONT BEARING 21

593563

REAR BEARING 22

593564

RECTIFIER OR DIODE BRIDGE ASSEMBLY 07 *599201**ROTOR** 04 593800**Valeo**

439760/440352

TG12S101

120

4

6V RL

14



Ø 55,4

Picture not available
Image non disponible
Imagen no disponible
Immagine non disponibile
Nicht verfügbares Bild
Brak zdjęcia
Картина недоступна

Picture not available
Image non disponible
Imagen no disponible
Immagine non disponibile
Nicht verfügbares Bild
Brak zdjęcia
Картина недоступна

FRONT BEARING 21 593563
REAR BEARING 22 593564
PROTECTION COVER 24 593892
SEP:SEPARATED REGULATOR -INC:BUILT-IN REGULATOR 02*595389
RECTIFIER OR DIODE BRIDGE ASSEMBLY 07 593859
FRONT HOUSING 31 593862
PULLEY FREE WEEL + CAP PROTECTION 11c 593860
ROTOR 04 *595390
STATOR 05 *595442

Valeo**439707/440298****TG12S111**

120

6V RL

14



Ø 55,39

Picture not available
Image non disponible
Imagen no disponible
Immagine non disponibile
Nicht verfügbares Bild
Brak zdjęcia
Картина недоступна

Picture not available
Image non disponible
Imagen no disponible
Immagine non disponibile
Nicht verfügbares Bild
Brak zdjęcia
Картина недоступна

FRONT BEARING 21 593563
REAR BEARING 22 593564
SEP:SEPARATED REGULATOR -INC:BUILT-IN REGULATOR 02*599197
RECTIFIER OR DIODE BRIDGE ASSEMBLY 07 593859
FRONT HOUSING 31 593862
PULLEY FREE WEEL + CAP PROTECTION 11c 593860
ROTOR 04 *595390
STATOR 05 *595442

Valeo**439780/440412****TG14C011**

140

4

6V RL

14



Ø 57,2

INC

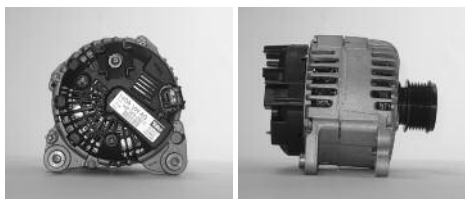

FRONT BEARING 21 593563
REAR BEARING 22 593564
PROTECTION COVER 24 593991
SEP:SEPARATED REGULATOR -INC:BUILT-IN REGULATOR 02593813
RECTIFIER OR DIODE BRIDGE ASSEMBLY 07 593814
FRONT HOUSING + STATOR 31+05 593815
PULLEY FREE WEEL + CAP PROTECTION 11c 593600
REGULATOR + COVER 02+24 593940
ROTOR 04 595303

Valeo**439489/437454****TG14C012**

140

4

6V RL

14



Ø 50,5

INC

Picture not available
Image non disponible
Imagen no disponible
Immagine non disponibile
Nicht verfügbares Bild
Brak zdjęcia
Картина недоступна

Picture not available
Image non disponible
Imagen no disponible
Immagine non disponibile
Nicht verfügbares Bild
Brak zdjęcia
Картина недоступна

FRONT BEARING 21 593563
REAR BEARING 22 593564
PROTECTION COVER 24 593991
SEP:SEPARATED REGULATOR -INC:BUILT-IN REGULATOR 02593813
FRONT HOUSING + STATOR 31+05 595220
PULLEY FREE WEEL + CAP PROTECTION 11c *595440
REGULATOR + COVER 02+24 593940
ROTOR 04 595303

Valeo**439563/437562****TG14C014**

140

4

6V

14



Ø 58

INC



FRONT BEARING 21 593563
REAR BEARING 22 593564
PROTECTION COVER 24 593991
SEP:SEPARATED REGULATOR -INC:BUILT-IN REGULATOR 02593813
RECTIFIER OR DIODE BRIDGE ASSEMBLY 07 593814
FRONT HOUSING + STATOR 31+05 593815
PULLEY 11 593900
REGULATOR + COVER 02+24 593940
ROTOR 04 595303

Valeo**439556/437553****TG14C015**

140

4

6V

14



Ø 57,2

Picture not available
Image non disponible
Imagen no disponible
Immagine non disponibile
Nicht verfügbares Bild
Brak zdjęcia
Картина недоступна

Picture not available
Image non disponible
Imagen no disponible
Immagine non disponibile
Nicht verfügbares Bild
Brak zdjęcia
Картина недоступна

FRONT BEARING 21 593563
REAR BEARING 22 593564
PROTECTION COVER 24 593991
SEP:SEPARATED REGULATOR -INC:BUILT-IN REGULATOR 02593813
RECTIFIER OR DIODE BRIDGE ASSEMBLY 07 593814
FRONT HOUSING + STATOR 31+05 593815
PULLEY FREE WEEL + CAP PROTECTION 11c 593600
REGULATOR + COVER 02+24 593940
ROTOR 04 595303

Valeo**439534/437526**

TG14C016

140

4

6V

14



90°

Ø 57,2

INC

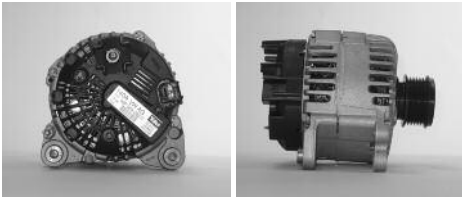

FRONT BEARING 21 593563
REAR BEARING 22 593564
PROTECTION COVER 24 593991
SEP:SEPARATED REGULATOR -INC:BUILT-IN REGULATOR 02 593813
RECTIFIER OR DIODE BRIDGE ASSEMBLY 07 593814
FRONT HOUSING + STATOR 31+05 593815
PULLEY FREE WHEEL + CAP PROTECTION 11c 593600
ROTOR 04 593561

Valeo**439489/437454****TG14C018**

140

6V RL

14



Ø 61,8

INC

Picture not available
Image non disponible
Imagen no disponible
Immagine non disponibile
Nicht verfügbares Bild
Brak zdjęcia
Картина недоступна

Picture not available
Image non disponible
Imagen no disponible
Immagine non disponibile
Nicht verfügbares Bild
Brak zdjęcia
Картина недоступна

FRONT BEARING 21 593563
REAR BEARING 22 593564
PROTECTION COVER 24 593991
SEP:SEPARATED REGULATOR -INC:BUILT-IN REGULATOR 02 *599119
PULLEY FREE WHEEL + CAP PROTECTION 11c *595333

Valeo**439657/440243****TG14C019**

140

6V RL

14



Ø 57,2

Picture not available
Image non disponible
Imagen no disponible
Immagine non disponibile
Nicht verfügbares Bild
Brak zdjęcia
Картина недоступна

Picture not available
Image non disponible
Imagen no disponible
Immagine non disponibile
Nicht verfügbares Bild
Brak zdjęcia
Картина недоступна

FRONT BEARING 21 593563
REAR BEARING 22 593564
PROTECTION COVER 24 593991
SEP:SEPARATED REGULATOR -INC:BUILT-IN REGULATOR 02 *599119

Valeo**439792/440429****TG14C020**

140

4

6V

14



90°

Ø 50,5

INC

Picture not available
Image non disponible
Imagen no disponible
Immagine non disponibile
Nicht verfügbares Bild
Brak zdjęcia
Картина недоступна

Picture not available
Image non disponible
Imagen no disponible
Immagine non disponibile
Nicht verfügbares Bild
Brak zdjęcia
Картина недоступна

FRONT BEARING 21 593563
REAR BEARING 22 593564
PROTECTION COVER 24 593991
SEP:SEPARATED REGULATOR -INC:BUILT-IN REGULATOR 02 *599119
PULLEY FREE WHEEL + CAP PROTECTION 11c 595282

Valeo**439642/440208****TG14C022**

140

4

6V

14



90°

Ø 58

INC

Picture not available
Image non disponible
Imagen no disponible
Immagine non disponibile
Nicht verfügbares Bild
Brak zdjęcia
Картина недоступна

Picture not available
Image non disponible
Imagen no disponible
Immagine non disponibile
Nicht verfügbares Bild
Brak zdjęcia
Картина недоступна

FRONT BEARING 21 593563
REAR BEARING 22 593564
PROTECTION COVER 24 593991
SEP:SEPARATED REGULATOR -INC:BUILT-IN REGULATOR 02 *599119
RECTIFIER OR DIODE BRIDGE ASSEMBLY 07 *595455
FRONT HOUSING + STATOR 31+05 *595454
PULLEY 11 *595308

Valeo**439643/440209****TG14C023**

140

4

6V

14



90°

Ø 50,5

INC

Picture not available
Image non disponible
Imagen no disponible
Immagine non disponibile
Nicht verfügbares Bild
Brak zdjęcia
Картина недоступна

Picture not available
Image non disponible
Imagen no disponible
Immagine non disponibile
Nicht verfügbares Bild
Brak zdjęcia
Картина недоступна

FRONT BEARING 21 593563
REAR BEARING 22 593564
PROTECTION COVER 24 593991
SEP:SEPARATED REGULATOR -INC:BUILT-IN REGULATOR 02 593813
RECTIFIER OR DIODE BRIDGE ASSEMBLY 07 593814
FRONT HOUSING + STATOR 31+05 593815
PULLEY FREE WHEEL + CAP PROTECTION 11c 595282
REGULATOR + COVER 02+24 593940
ROTOR 04 *599205

Valeo**439608/440240****TG14C025**

140

6V RL

14



Ø 57,2

INC



FRONT BEARING 21 593563
REAR BEARING 22 593564
PROTECTION COVER 24 593991
SEP:SEPARATED REGULATOR -INC:BUILT-IN REGULATOR 02 593813
PULLEY FREE WHEEL + CAP PROTECTION 11c 593778

Valeo**439393/437360**

TG14C026

140 2 6V

14 ↻ 90° ▷ ∅ 57,2 INC

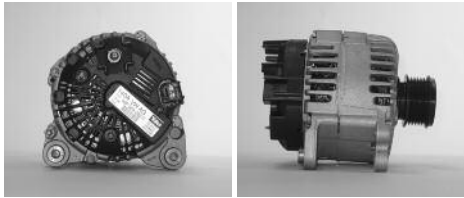

FRONT BEARING 21 593563
REAR BEARING 22 593564
PROTECTION COVER 24 593991
SEP:SEPARATED REGULATOR -INC:BUILT-IN REGULATOR 02 593813
RECTIFIER OR DIODE BRIDGE ASSEMBLY 07 *599075
PULLEY FREE WEEL + CAP PROTECTION 11c 593600

TG14C026

140 2 6V

14 ↻ 90° ▷ ∅ 57,2 INC

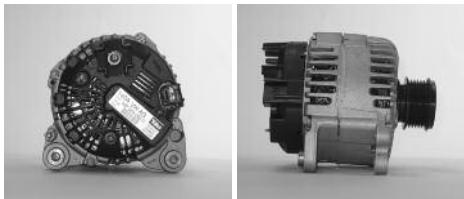

FRONT BEARING 21 593563
REAR BEARING 22 593564
PROTECTION COVER 24 593991
SEP:SEPARATED REGULATOR -INC:BUILT-IN REGULATOR 02 593813
RECTIFIER OR DIODE BRIDGE ASSEMBLY 07 *599075
PULLEY FREE WEEL + CAP PROTECTION 11c 593600
Valeo 439664/440249

TG14C027

140 2 6V

14 ↻ 90° ▷ ∅ 50,5 INC

Picture not available
Image non disponible
Imagen no disponible
Immagine non disponibile
Nicht verfügbares Bild
Brak zdjęcia
Картина недоступна

Picture not available
Image non disponible
Imagen no disponible
Immagine non disponibile
Nicht verfügbares Bild
Brak zdjęcia
Картина недоступна

FRONT BEARING 21 593563
REAR BEARING 22 593564
PROTECTION COVER 24 593991
SEP:SEPARATED REGULATOR -INC:BUILT-IN REGULATOR 02 593813
RECTIFIER OR DIODE BRIDGE ASSEMBLY 07 *595439
PULLEY FREE WEEL + CAP PROTECTION 11c *595440
Valeo 439665/440250

TG14C028

150 4 6V RL

14 ↻ 90° ▷ ∅ 50,5

Picture not available
Image non disponible
Imagen no disponible
Immagine non disponibile
Nicht verfügbares Bild
Brak zdjęcia
Картина недоступна

Picture not available
Image non disponible
Imagen no disponible
Immagine non disponibile
Nicht verfügbares Bild
Brak zdjęcia
Картина недоступна

FRONT BEARING 21 593563
REAR BEARING 22 593564
PROTECTION COVER 24 593991
SEP:SEPARATED REGULATOR -INC:BUILT-IN REGULATOR 02 *599119
RECTIFIER OR DIODE BRIDGE ASSEMBLY 07 *595439
PULLEY FREE WEEL + CAP PROTECTION 11c *595440
Valeo 439720/440310

TG14C031

140 4 6V

14 ↻ 90° ▷ ∅ 57,2

Picture not available
Image non disponible
Imagen no disponible
Immagine non disponibile
Nicht verfügbares Bild
Brak zdjęcia
Картина недоступна

Picture not available
Image non disponible
Imagen no disponible
Immagine non disponibile
Nicht verfügbares Bild
Brak zdjęcia
Картина недоступна

FRONT BEARING 21 593563
REAR BEARING 22 593564
PROTECTION COVER 24 593991
SEP:SEPARATED REGULATOR -INC:BUILT-IN REGULATOR 02 *599119
PULLEY FREE WEEL + CAP PROTECTION 11c 593600
Valeo 439724/440314

TG14C034

140 4 6V RL

14 ↻ 90° ▷ ∅ 50,5

Picture not available
Image non disponible
Imagen no disponible
Immagine non disponibile
Nicht verfügbares Bild
Brak zdjęcia
Картина недоступна

Picture not available
Image non disponible
Imagen no disponible
Immagine non disponibile
Nicht verfügbares Bild
Brak zdjęcia
Картина недоступна

FRONT BEARING 21 593563
REAR BEARING 22 593564
PROTECTION COVER 24 593991
SEP:SEPARATED REGULATOR -INC:BUILT-IN REGULATOR 02 593813
RECTIFIER OR DIODE BRIDGE ASSEMBLY 07 *599075
PULLEY FREE WEEL + CAP PROTECTION 11c 595282
Valeo 439753/440343

TG14C035

140 4 6V RL

14 ↻ 90° ▷ ∅ 57,2

Picture not available
Image non disponible
Imagen no disponible
Immagine non disponibile
Nicht verfügbares Bild
Brak zdjęcia
Картина недоступна

Picture not available
Image non disponible
Imagen no disponible
Immagine non disponibile
Nicht verfügbares Bild
Brak zdjęcia
Картина недоступна

FRONT BEARING 21 593563
REAR BEARING 22 593564
PROTECTION COVER 24 593991
SEP:SEPARATED REGULATOR -INC:BUILT-IN REGULATOR 02 *599119
PULLEY FREE WEEL + CAP PROTECTION 11c 593600
Valeo 439721/440311

TG14C036

140 4 6V RL

14 ↻ 90° ▷ ∅ 57,2

Picture not available
Image non disponible
Imagen no disponible
Immagine non disponibile
Nicht verfügbares Bild
Brak zdjęcia
Картина недоступна

Picture not available
Image non disponible
Imagen no disponible
Immagine non disponibile
Nicht verfügbares Bild
Brak zdjęcia
Картина недоступна

FRONT BEARING 21 593563
REAR BEARING 22 593564
PROTECTION COVER 24 593991
SEP:SEPARATED REGULATOR -INC:BUILT-IN REGULATOR 02 593813
PULLEY FREE WEEL + CAP PROTECTION 11c 593600
Valeo 439734/440324

TG14C037

140

6V RL

14



Ø 57,2

Picture not available
Image non disponible
Imagen no disponible
Immagine non disponibile
Nicht verfügbares Bild
Brak zdjęćia
Картина недоступна

Picture not available
Image non disponible
Imagen no disponible
Immagine non disponibile
Nicht verfügbares Bild
Brak zdjęćia
Картина недоступна

FRONT BEARING 21

593563

REAR BEARING 22

593564

PROTECTION COVER 24

593991

SEP:SEPARATED REGULATOR -INC:BUILT-IN REGULATOR 02*599119**PULLEY FREE WEEL + CAP PROTECTION** 11c

593778

Valeo**439725/440315****TG14C039**

140

4

6V RL

14



90°

Ø 50,5

Picture not available
Image non disponible
Imagen no disponible
Immagine non disponibile
Nicht verfügbares Bild
Brak zdjęćia
Картина недоступна

Picture not available
Image non disponible
Imagen no disponible
Immagine non disponibile
Nicht verfügbares Bild
Brak zdjęćia
Картина недоступна

FRONT BEARING 21

593563

REAR BEARING 22

593564

PROTECTION COVER 24

593991

SEP:SEPARATED REGULATOR -INC:BUILT-IN REGULATOR 02*599119**PULLEY FREE WEEL + CAP PROTECTION** 11c

*595440

Valeo**439768/440359****TG14C042**

140

4

6V

14



90°

Ø 58

INC

Picture not available
Image non disponible
Imagen no disponible
Immagine non disponibile
Nicht verfügbares Bild
Brak zdjęćia
Картина недоступна

Picture not available
Image non disponible
Imagen no disponible
Immagine non disponibile
Nicht verfügbares Bild
Brak zdjęćia
Картина недоступна

FRONT BEARING 21

593563

REAR BEARING 22

593564

PROTECTION COVER 24

593991

SEP:SEPARATED REGULATOR -INC:BUILT-IN REGULATOR 02*595305**RECTIFIER OR DIODE BRIDGE ASSEMBLY** 07

*595455

PULLEY 11

*595308

REAR BRACKET + STATOR 30+05

*595453

ROTOR 04

595297

Valeo**439643/440209****TG14C043**

140

4

6V RL

14



90°

Ø 50,58

Picture not available
Image non disponible
Imagen no disponible
Immagine non disponibile
Nicht verfügbares Bild
Brak zdjęćia
Картина недоступна

Picture not available
Image non disponible
Imagen no disponible
Immagine non disponibile
Nicht verfügbares Bild
Brak zdjęćia
Картина недоступна

FRONT BEARING 21

593563

REAR BEARING 22

593684

PROTECTION COVER 24

593991

RECTIFIER OR DIODE BRIDGE ASSEMBLY 07

*599075

PULLEY FREE WEEL + CAP PROTECTION 11c

595282

ROTOR 04

*599093

Valeo**439791/440428****TG14C044**

140

4

6V RL

14



90°

Ø 50,5

Picture not available
Image non disponible
Imagen no disponible
Immagine non disponibile
Nicht verfügbares Bild
Brak zdjęćia
Картина недоступна

Picture not available
Image non disponible
Imagen no disponible
Immagine non disponibile
Nicht verfügbares Bild
Brak zdjęćia
Картина недоступна

FRONT BEARING 21

593563

REAR BEARING 22

593564

PROTECTION COVER 24

593991

SEP:SEPARATED REGULATOR -INC:BUILT-IN REGULATOR 02*599119**RECTIFIER OR DIODE BRIDGE ASSEMBLY** 07

*599075

PULLEY FREE WEEL + CAP PROTECTION 11c

595282

Valeo**439764/440356****TG14C047**

140

4

6V RL

14



90°

Ø 57,2

INC

Picture not available
Image non disponible
Imagen no disponible
Immagine non disponibile
Nicht verfügbares Bild
Brak zdjęćia
Картина недоступна

Picture not available
Image non disponible
Imagen no disponible
Immagine non disponibile
Nicht verfügbares Bild
Brak zdjęćia
Картина недоступна

FRONT BEARING 21

593563

REAR BEARING 22

593564

PROTECTION COVER 24

593991

SEP:SEPARATED REGULATOR -INC:BUILT-IN REGULATOR 02*595305**RECTIFIER OR DIODE BRIDGE ASSEMBLY** 07

*595455

PULLEY FREE WEEL + CAP PROTECTION 11c

*599143

REAR BRACKET + STATOR 30+05

*595453

ROTOR 04

595297

TG14C047

140

4

6V RL

14



90°

Ø 57,2

INC

Picture not available
Image non disponible
Imagen no disponible
Immagine non disponibile
Nicht verfügbares Bild
Brak zdjęćia
Картина недоступна

Picture not available
Image non disponible
Imagen no disponible
Immagine non disponibile
Nicht verfügbares Bild
Brak zdjęćia
Картина недоступна

FRONT BEARING 21

593563

REAR BEARING 22

593564

PROTECTION COVER 24

593991

SEP:SEPARATED REGULATOR -INC:BUILT-IN REGULATOR 02*595305**RECTIFIER OR DIODE BRIDGE ASSEMBLY** 07

*595455

PULLEY FREE WEEL + CAP PROTECTION 11c

*599143

REAR BRACKET + STATOR 30+05

*595453

ROTOR 04

595297

Valeo**439776/440409**

TG15C012

150 2 6V

14 ↻ 47° ∇ Ø 54,8 INC

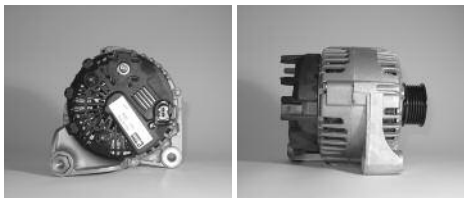

FRONT BEARING 21 593563
 REAR BEARING 22 593564
 PROTECTION COVER 24 593790
 SEP:SEPARATED REGULATOR -INC:BUILT-IN REGULATOR 02 593793
 RECTIFIER OR DIODE BRIDGE ASSEMBLY 07 593788
 RECTIFIER OR DIODE BRIDGE ASSEMBLY 07 593914
 FRONT HOUSING + STATOR 31+05 593792
 PULLEY 11 593794
 ROTOR 04 593561

Valeo

439487/437452

TG15C015

150 4 6V

14 ↻ 40° ∇ Ø 54,4 INC

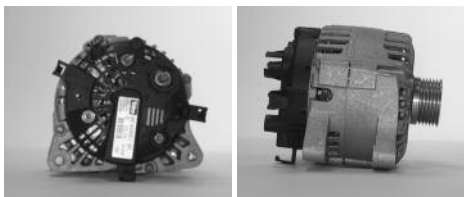
B+(M8)
L(M5)

FRONT BEARING 21 593563
 REAR BEARING 22 593564
 PROTECTION COVER 24 593560
 SEP:SEPARATED REGULATOR -INC:BUILT-IN REGULATOR 02 593534
 RECTIFIER OR DIODE BRIDGE ASSEMBLY 07 593558
 FRONT HOUSING + STATOR 31+05 593562
 ROTOR 04 593561

Valeo

439470/437429

TG15C017

150 6V

14 ↻ Ø 57,2 INC



FRONT BEARING 21 593563
 REAR BEARING 22 593564
 PROTECTION COVER 24 593991
 SEP:SEPARATED REGULATOR -INC:BUILT-IN REGULATOR 02 593813
 RECTIFIER OR DIODE BRIDGE ASSEMBLY 07 593855
 FRONT HOUSING + STATOR 31+05 593856
 PULLEY FREE WHEEL + CAP PROTECTION 11c 593778
 ROTOR 04 593561

Valeo

439498/437468

TG15C018

150 2 6V

14 ↻ 47° ∇ Ø 51 INC

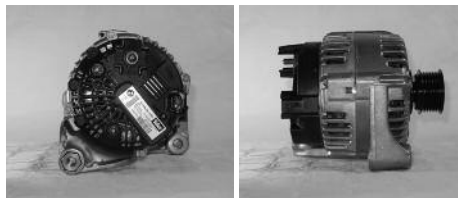

FRONT BEARING 21 593563
 REAR BEARING 22 593564
 PROTECTION COVER 24 593790
 SEP:SEPARATED REGULATOR -INC:BUILT-IN REGULATOR 02 593873
 RECTIFIER OR DIODE BRIDGE ASSEMBLY 07 593788
 RECTIFIER OR DIODE BRIDGE ASSEMBLY 07 593914
 FRONT HOUSING + STATOR 31+05 593792
 PULLEY 11 593789
 ROTOR 04 593561

Valeo

439486/437451

TG15C018b

150 2 6V

14 ↻ 47° ∇ Ø 51 INC

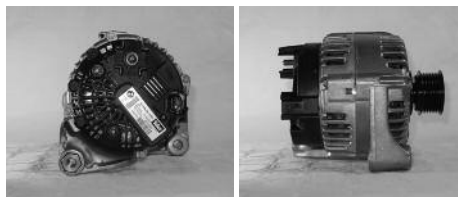

FRONT BEARING 21 593563
 REAR BEARING 22 593564
 PROTECTION COVER 24 593790
 SEP:SEPARATED REGULATOR -INC:BUILT-IN REGULATOR 02 593873
 RECTIFIER OR DIODE BRIDGE ASSEMBLY 07 593914
 FRONT HOUSING + STATOR 31+05 593792
 PULLEY 11 593789
 ROTOR 04 593561

Valeo

439486/437451

TG15C020

150 4 6V RL

14 ↻ 40° ∇ Ø 57,5 INC

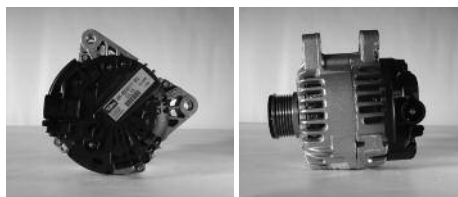

FRONT BEARING 21 593563
 REAR BEARING 22 593564
 PROTECTION COVER 24 *599076
 SEP:SEPARATED REGULATOR -INC:BUILT-IN REGULATOR 02 593857
 RECTIFIER OR DIODE BRIDGE ASSEMBLY 07 593803
 FRONT HOUSING + STATOR 31+05 593807
 PULLEY FREE WHEEL + CAP PROTECTION 11c 593832
 ROTOR 04 593561

Valeo

439502/437471

TG15C022

150

4

6V

14



40°

Ø 57,5

INC

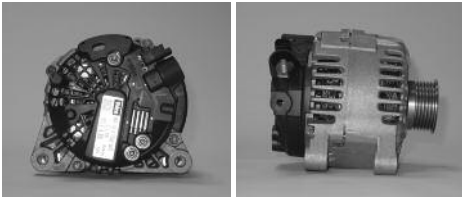

FRONT BEARING 21 593563
 REAR BEARING 22 593564
 PROTECTION COVER 24 *599076
 SEP:SEPARATED REGULATOR -INC:BUILT-IN REGULATOR 02 593857
 RECTIFIER OR DIODE BRIDGE ASSEMBLY 07 593803
 FRONT HOUSING + STATOR 31+05 593807
 PULLEY 11 593804
 ROTOR 04 593561

Valeo**439503/437472****TG15C023**

150

4

6V

14



40°

Ø 57,5

INC

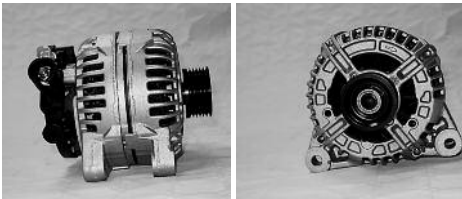

FRONT BEARING 21 593563
 REAR BEARING 22 593564
 PROTECTION COVER 24 *599076
 SEP:SEPARATED REGULATOR -INC:BUILT-IN REGULATOR 02 593857
 RECTIFIER OR DIODE BRIDGE ASSEMBLY 07 593803
 FRONT HOUSING + STATOR 31+05 593807
 PULLEY 11 593804
 ROTOR 04 593561

Valeo**439492/437457****TG15C027**

150

2

6V

14



47°

Ø 54,8

INC

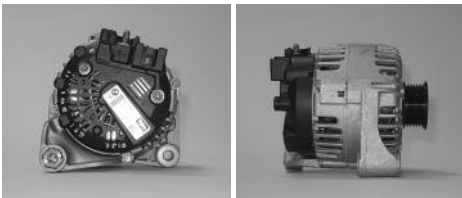

FRONT BEARING 21 593563
 REAR BEARING 22 593564
 PROTECTION COVER 24 593957
 SEP:SEPARATED REGULATOR -INC:BUILT-IN REGULATOR 02 *595348
 RECTIFIER OR DIODE BRIDGE ASSEMBLY 07 593955
 FRONT HOUSING + STATOR 31+05 593792
 PULLEY 11 593956
 ROTOR 04 593561

Valeo**439545/437538****TG15C027b**

150

2

6V

14



47°

Ø 54,8

INC

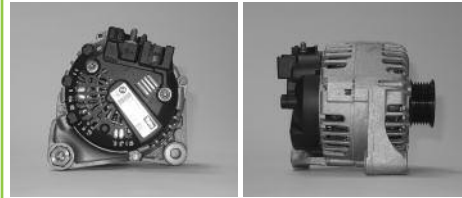

FRONT BEARING 21 593563
 REAR BEARING 22 593564
 PROTECTION COVER 24 593957
 SEP:SEPARATED REGULATOR -INC:BUILT-IN REGULATOR 02 *595348
 RECTIFIER OR DIODE BRIDGE ASSEMBLY 07 593955
 FRONT HOUSING + STATOR 31+05 593792
 PULLEY 11 593956
 ROTOR 04 593561

Valeo**439545/437538****TG15C028**

150

4

6V

14



40°

Ø 57,5

INC



FRONT BEARING 21 593563
 REAR BEARING 22 593564
 PROTECTION COVER 24 *599076
 SEP:SEPARATED REGULATOR -INC:BUILT-IN REGULATOR 02 593857
 RECTIFIER OR DIODE BRIDGE ASSEMBLY 07 593803
 FRONT HOUSING + STATOR 31+05 593807
 PULLEY FREE WHEEL + CAP PROTECTION 11c 593832
 ROTOR 04 593561

Valeo**439502/437471****TG15C038**

150

2

5V

14



48°

Ø 54,8

INC



FRONT BEARING 21 593563
 REAR BEARING 22 593564
 PROTECTION COVER 24 593790
 SEP:SEPARATED REGULATOR -INC:BUILT-IN REGULATOR 02 593793
 RECTIFIER OR DIODE BRIDGE ASSEMBLY 07 593788
 FRONT HOUSING + STATOR 31+05 593792
 PULLEY 11 593849
 ROTOR 04 593561

Valeo**439459/437417**

TG15C043

150 2 6V

14 ↻ 60° ∇ Ø 66 INC



FRONT BEARING 21 593563
 REAR BEARING 22 593564
 PROTECTION COVER 24 593991
 SEP:SEPARATED REGULATOR -INC:BUILT-IN REGULATOR 02 593813
 FRONT HOUSING + STATOR 31+05 595232
 PULLEY 11 595231
 ROTOR 04 593561
Valeo **439574/440025**

TG15C054

150 4 6V

14 ↻ 40° ∇ Ø 57,5 INC

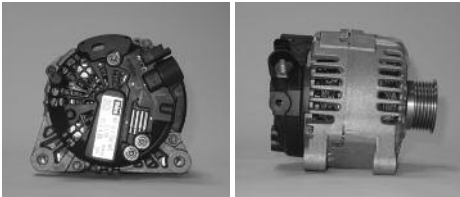

FRONT BEARING 21 593563
 REAR BEARING 22 593564
 PROTECTION COVER 24 *599076
 SEP:SEPARATED REGULATOR -INC:BUILT-IN REGULATOR 02 593857
 RECTIFIER OR DIODE BRIDGE ASSEMBLY 07 593803
 FRONT HOUSING + STATOR 31+05 595228
 PULLEY 11 593804
 ROTOR 04 593561
Valeo **439503/437472**

TG15C057

140 5V

14 ↻ Ø 51 INC

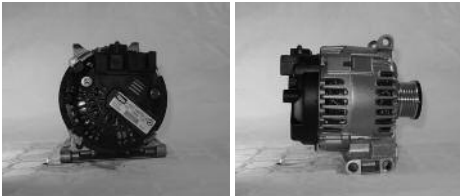

FRONT BEARING 21 593563
 REAR BEARING 22 593564
 PROTECTION COVER 24 593972
 SEP:SEPARATED REGULATOR -INC:BUILT-IN REGULATOR 02 593970
 RECTIFIER OR DIODE BRIDGE ASSEMBLY 07 593971
 FRONT HOUSING + STATOR 31+05 593974
 PULLEY FREE WHEEL + CAP PROTECTION 11c 599104
 ROTOR 04 593973
Valeo **439552/437545**

TG15C057b

140 5V

14 ↻ Ø 51 INC



FRONT BEARING 21 593563
 REAR BEARING 22 593564
 PROTECTION COVER 24 593972
 SEP:SEPARATED REGULATOR -INC:BUILT-IN REGULATOR 02 593970
 RECTIFIER OR DIODE BRIDGE ASSEMBLY 07 593971
 FRONT HOUSING + STATOR 31+05 593974
 PULLEY FREE WHEEL + CAP PROTECTION 11c 599104
 ROTOR 04 593973
Valeo **439552/437545**

TG15C057c

140 5V

14 ↻ Ø 50 INC

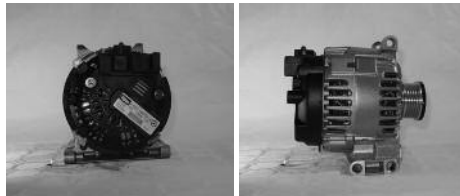

FRONT BEARING 21 593563
 REAR BEARING 22 593564
 PROTECTION COVER 24 593972
 SEP:SEPARATED REGULATOR -INC:BUILT-IN REGULATOR 02 593970
 RECTIFIER OR DIODE BRIDGE ASSEMBLY 07 593971
 FRONT HOUSING + STATOR 31+05 593974
 PULLEY FREE WHEEL + CAP PROTECTION 11c 599104
 ROTOR 04 593973
Valeo **439552/437545**

TG15C058

150 4 7V RL

14 ↻ 90° ∇ Ø 50,08 INC



FRONT BEARING 21 593563
 REAR BEARING 22 593564
 PROTECTION COVER 24 595235
 SEP:SEPARATED REGULATOR -INC:BUILT-IN REGULATOR 02 593689
 RECTIFIER OR DIODE BRIDGE ASSEMBLY 07 595233
 FRONT HOUSING + STATOR 31+05 *595378
 PULLEY FREE WHEEL + CAP PROTECTION 11c 593514
 ROTOR 04 *595380
Valeo **439576/440034**

TG15C060

150

4

6V

14



40°

INC

Picture not available
Image non disponible
Imagem no disponibile
Immagine non disponibile
Nicht verfügbares Bild
Brak zdjęcia
Картина недоступна

Picture not available
Image non disponible
Imagem no disponibile
Immagine non disponibile
Nicht verfügbares Bild
Brak zdjęcia
Картина недоступна

B+(M8)
L(M5)

FRONT BEARING 21	593563
REAR BEARING 22	593564
PROTECTION COVER 24	593528
SEP:SEPARATED REGULATOR -INC:BUILT-IN REGULATOR 02	593857
RECTIFIER OR DIODE BRIDGE ASSEMBLY 07	595304
FRONT HOUSING + STATOR 31+05	593807
ROTOR 04	595303
Valeo	439655/440241

TG15C064

150

2

6V

14



90°

Ø 54,8

INC

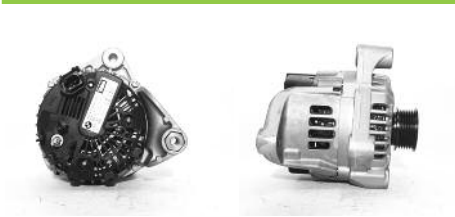

FRONT BEARING 21	593563
REAR BEARING 22	593564
PROTECTION COVER 24	593790
SEP:SEPARATED REGULATOR -INC:BUILT-IN REGULATOR 02	595214
FRONT HOUSING + STATOR 31+05	593792
PULLEY 11	595272
ROTOR 04	595303
Valeo	439567/437583

TG15C065

150

6V RL

14



Ø 57,2

INC



FRONT BEARING 21	593563
REAR BEARING 22	593564
PROTECTION COVER 24	593991
SEP:SEPARATED REGULATOR -INC:BUILT-IN REGULATOR 02	593813
RECTIFIER OR DIODE BRIDGE ASSEMBLY 07	593855
FRONT HOUSING + STATOR 31+05	593856
PULLEY FREE WHEEL + CAP PROTECTION 11c	593778
REGULATOR + COVER 02+24	593940
ROTOR 04	595303
Valeo	439498/437468

TG15C072

150

2

6V

14



95°

Ø 54,8

INC

Picture not available
Image non disponible
Imagem no disponibile
Immagine non disponibile
Nicht verfügbares Bild
Brak zdjęcia
Картина недоступна

Picture not available
Image non disponible
Imagem no disponibile
Immagine non disponibile
Nicht verfügbares Bild
Brak zdjęcia
Картина недоступна

FRONT BEARING 21	593563
REAR BEARING 22	593564
PROTECTION COVER 24	593790
FRONT HOUSING + STATOR 31+05	593792
PULLEY 11	595272
ROTOR 04	595303
Valeo	439621/440179

TG15C073

150

2

6V

14



90°

Ø 54,8

INC

Picture not available
Image non disponible
Imagem no disponibile
Immagine non disponibile
Nicht verfügbares Bild
Brak zdjęcia
Картина недоступна

Picture not available
Image non disponible
Imagem no disponibile
Immagine non disponibile
Nicht verfügbares Bild
Brak zdjęcia
Картина недоступна

B+(M8)

FRONT BEARING 21	593563
REAR BEARING 22	593564
PROTECTION COVER 24	593957
SEP:SEPARATED REGULATOR -INC:BUILT-IN REGULATOR 02	595348
RECTIFIER OR DIODE BRIDGE ASSEMBLY 07	*595343
FRONT HOUSING + STATOR 31+05	595255
ROTOR 04	593973
Valeo	439600/440106

TG15C075

150

7V RL

14



Ø 57

INC

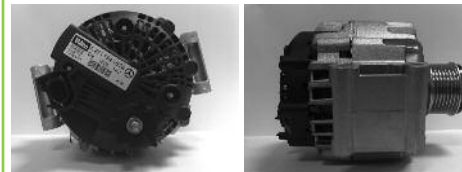

FRONT BEARING 21	593563
REAR BEARING 22	593564
PROTECTION COVER 24	593790
SEP:SEPARATED REGULATOR -INC:BUILT-IN REGULATOR 02	*595387
RECTIFIER OR DIODE BRIDGE ASSEMBLY 07	595298
PULLEY FREE WHEEL + CAP PROTECTION 11c	595258
ROTOR 04	595297
Valeo	439610/440127

TG15C091

150 4 7V

14 ↻ 90° ↘ ∅ 50,08 INC

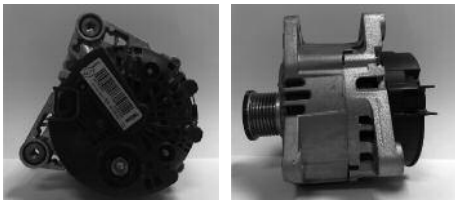

FRONT BEARING 📏21 593563
REAR BEARING 📏22 593564
PROTECTION COVER 📏24 595235
SEP:SEPARATED REGULATOR -INC:BUILT-IN REGULATOR 📏02 595237
RECTIFIER OR DIODE BRIDGE ASSEMBLY 📏07 595233
FRONT HOUSING + STATOR 📏31+05 595236
PULLEY FREE WEEL + CAP PROTECTION 📏11c 595226
ROTOR 📏04 593561

Valeo

439577/440035

TG15C093

150 2 6V

14 ↻ 47° ↘ ∅ 54,8 INC

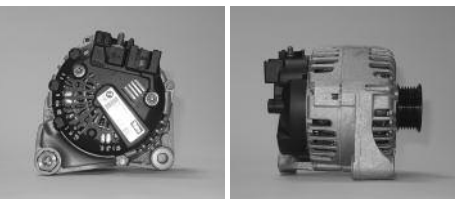

FRONT BEARING 📏21 593563
REAR BEARING 📏22 593564
PROTECTION COVER 📏24 593957
SEP:SEPARATED REGULATOR -INC:BUILT-IN REGULATOR 📏02* 595348
RECTIFIER OR DIODE BRIDGE ASSEMBLY 📏07 593955
FRONT HOUSING + STATOR 📏31+05 595255
PULLEY 📏11 593956
ROTOR 📏04 593973

Valeo

439545/437538

TG15C094

150 6V RL

14 ↻ ↘ ∅ 61,8 INC

Picture not available
 Image non disponible
 Imagen no disponible
 Immagine non disponibile
 Nicht verfügbares Bild
 Brak zdjęcia
 Картина недоступна

Picture not available
 Image non disponible
 Imagen no disponible
 Immagine non disponibile
 Nicht verfügbares Bild
 Brak zdjęcia
 Картина недоступна

FRONT BEARING 📏21 593563
REAR BEARING 📏22 593564
PROTECTION COVER 📏24 593991
SEP:SEPARATED REGULATOR -INC:BUILT-IN REGULATOR 📏02* 595305
PULLEY FREE WEEL + CAP PROTECTION 📏11c *595333
ROTOR 📏04 595297

Valeo

439658/440244

TG15C095

150 4 6V

14 ↻ 90° ↘ ∅ 58 INC

Picture not available
 Image non disponible
 Imagen no disponible
 Immagine non disponibile
 Nicht verfügbares Bild
 Brak zdjęcia
 Картина недоступна

Picture not available
 Image non disponible
 Imagen no disponible
 Immagine non disponibile
 Nicht verfügbares Bild
 Brak zdjęcia
 Картина недоступна

FRONT BEARING 📏21 593563
REAR BEARING 📏22 593564
PROTECTION COVER 📏24 593991
SEP:SEPARATED REGULATOR -INC:BUILT-IN REGULATOR 📏02* 595305
RECTIFIER OR DIODE BRIDGE ASSEMBLY 📏07 *595455
PULLEY 📏11 *595308
REAR BRACKET + STATOR 📏30+05 *595453
ROTOR 📏04 595297

Valeo

439644/440211

TG15C098

150 2 6V

14 ↻ 90° ↘ ∅ 54,2 INC



FRONT BEARING 📏21 593563
REAR BEARING 📏22 593564
PROTECTION COVER 📏24 593790
SEP:SEPARATED REGULATOR -INC:BUILT-IN REGULATOR 📏02 593873
RECTIFIER OR DIODE BRIDGE ASSEMBLY 📏07 593914
FRONT HOUSING + STATOR 📏31+05 595255
PULLEY 📏11 595254
ROTOR 📏04 593973

Valeo

439590/440064

TG15C103

150 2 6V RL

14 ↻ 79° ↘ ∅ 55,29 INC

Picture not available
 Image non disponible
 Imagen no disponible
 Immagine non disponibile
 Nicht verfügbares Bild
 Brak zdjęcia
 Картина недоступна

Picture not available
 Image non disponible
 Imagen no disponible
 Immagine non disponibile
 Nicht verfügbares Bild
 Brak zdjęcia
 Картина недоступна

FRONT BEARING 📏21 593563
REAR BEARING 📏22 593564
PROTECTION COVER 📏24 *595373
SEP:SEPARATED REGULATOR -INC:BUILT-IN REGULATOR 📏02* 595393
RECTIFIER OR DIODE BRIDGE ASSEMBLY 📏07 *595376
FRONT HOUSING + STATOR 📏31+05 *595375
PULLEY FREE WEEL + CAP PROTECTION 📏11c 593832
ROTOR 📏04 595297

Valeo

439633/440200

TG15C112

150

4

6V RL

14



80°

Ø 57,5

INC

Picture not available
Image non disponible
Imagem no disponibile
Immagine non disponibile
Nicht verfügbares Bild
Brak zdjęcia
Картина недоступна

Picture not available
Image non disponible
Imagem no disponibile
Immagine non disponibile
Nicht verfügbares Bild
Brak zdjęcia
Картина недоступна

FRONT BEARING 21

593563

REAR BEARING 22

593564

PROTECTION COVER 24

*599076

SEP:SEPARATED REGULATOR -INC:BUILT-IN REGULATOR 02

593857

RECTIFIER OR DIODE BRIDGE ASSEMBLY 07

*593559

FRONT HOUSING + STATOR 31+05

*595361

PULLEY FREE WEEL + CAP PROTECTION 11c

*595360

ROTOR 04

595303

Valeo

439622/440180

TG15C117

150

4

6V

14



80°

Ø 54,4

INC

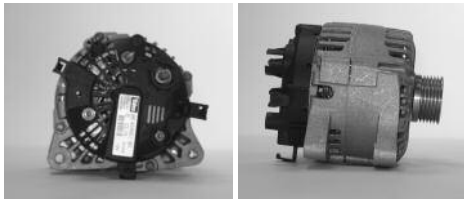
**B+(M8)**
L(M5)**FRONT BEARING** 21

593563

REAR BEARING 22

593564

PROTECTION COVER 24

593560

SEP:SEPARATED REGULATOR -INC:BUILT-IN REGULATOR 02

593534

RECTIFIER OR DIODE BRIDGE ASSEMBLY 07

593558

FRONT HOUSING + STATOR 31+05

593562

ROTOR 04

593561

TG15C117

150

4

6V

14



80°

Ø 54,4

INC

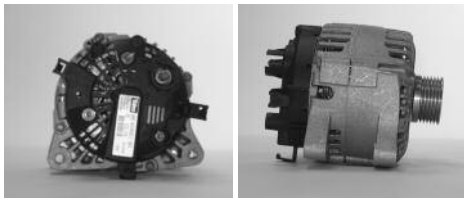
**B+(M8)**
L(M5)**FRONT BEARING** 21

593563

REAR BEARING 22

593564

PROTECTION COVER 24

593560

SEP:SEPARATED REGULATOR -INC:BUILT-IN REGULATOR 02

593534

RECTIFIER OR DIODE BRIDGE ASSEMBLY 07

593558

FRONT HOUSING + STATOR 31+05

593562

ROTOR 04

593561

TG15C117

150

4

6V

14



80°

Ø 54,4

INC

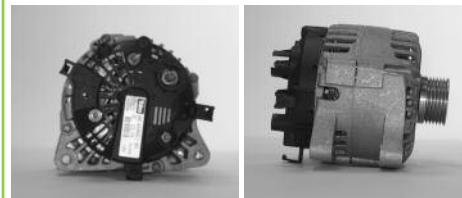
**B+(M8)**
L(M5)**FRONT BEARING** 21

593563

REAR BEARING 22

593564

PROTECTION COVER 24

593560

SEP:SEPARATED REGULATOR -INC:BUILT-IN REGULATOR 02

593534

RECTIFIER OR DIODE BRIDGE ASSEMBLY 07

593558

FRONT HOUSING + STATOR 31+05

593562

ROTOR 04

593561

Valeo

439470/437429

TG15C118

150

4

6V RL

14



80°

Ø 57,5

INC

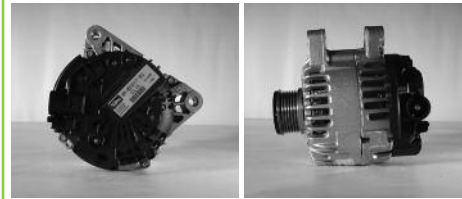
**FRONT BEARING** 21

593563

REAR BEARING 22

593564

PROTECTION COVER 24

*599076

SEP:SEPARATED REGULATOR -INC:BUILT-IN REGULATOR 02

593857

RECTIFIER OR DIODE BRIDGE ASSEMBLY 07

593803

FRONT HOUSING + STATOR 31+05

595228

PULLEY FREE WEEL + CAP PROTECTION 11c

593832

ROTOR 04

595303

Valeo

439502/437471

TG15C119

150

4

6V

14



80°

Ø 57,5

INC

**FRONT BEARING** 21

593563

REAR BEARING 22

593564

PROTECTION COVER 24

*599076

SEP:SEPARATED REGULATOR -INC:BUILT-IN REGULATOR 02

593857

RECTIFIER OR DIODE BRIDGE ASSEMBLY 07

593803

FRONT HOUSING + STATOR 31+05

595228

PULLEY 11

593804

ROTOR 04

595303



TG15C119

150

4

6V

14



80°

Ø 57,5

INC

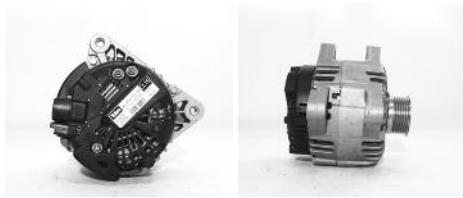

FRONT BEARING	593563
REAR BEARING	593564
PROTECTION COVER	*599076
SEP:SEPARATED REGULATOR -INC:BUILT-IN REGULATOR	02593857
RECTIFIER OR DIODE BRIDGE ASSEMBLY	07 593803
FRONT HOUSING + STATOR	31+05 595228
PULLEY	11 593804
ROTOR	04 595303

TG15C119

150

4

6V

14



80°

Ø 57,5

INC

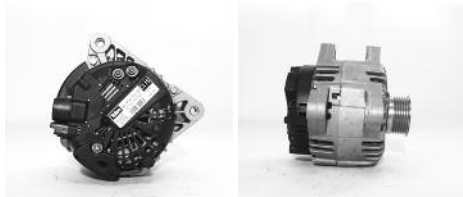

FRONT BEARING	593563
REAR BEARING	593564
PROTECTION COVER	*599076
SEP:SEPARATED REGULATOR -INC:BUILT-IN REGULATOR	02593857
RECTIFIER OR DIODE BRIDGE ASSEMBLY	07 593803
FRONT HOUSING + STATOR	31+05 595228
PULLEY	11 593804
ROTOR	04 595303

Valeo**439503/437472****TG15C120**

150

4

6V

14



80°

Ø 52,19

INC

Picture not available
Image non disponible
Imagen no disponible
Immagine non disponibile
Nicht verfügbares Bild
Brak zdjęcia
Картина недоступна

Picture not available
Image non disponible
Imagen no disponible
Immagine non disponibile
Nicht verfügbares Bild
Brak zdjęcia
Картина недоступна

FRONT BEARING	593563
REAR BEARING	593564
SEP:SEPARATED REGULATOR -INC:BUILT-IN REGULATOR	02*595478
RECTIFIER OR DIODE BRIDGE ASSEMBLY	07 593558
FRONT HOUSING + STATOR	31+05 593562
ROTOR	04 593561

Valeo**439634/440201****TG15C121**

140

5V RL

14



Ø 51

INC



FRONT BEARING	593563
REAR BEARING	593564
PROTECTION COVER	593972
SEP:SEPARATED REGULATOR -INC:BUILT-IN REGULATOR	02593970
RECTIFIER OR DIODE BRIDGE ASSEMBLY	07 *595346
FRONT HOUSING + STATOR	31+05 *595345
PULLEY FREE WHEEL + CAP PROTECTION	11c 599104
ROTOR	04 593973

Valeo**439552/437545****TG15C123**

150

4

6V

14



90°

Ø 52,58

INC

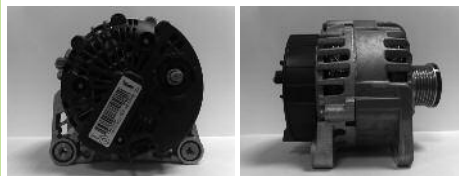

FRONT BEARING	593563
REAR BEARING	593564
PROTECTION COVER	595235
RECTIFIER OR DIODE BRIDGE ASSEMBLY	07 595233
FRONT HOUSING + STATOR	31+05 *595378
PULLEY FREE WHEEL + CAP PROTECTION	11c *595410
ROTOR	04 *595380

Valeo**439627/440187****TG15C124**

150

4

7V

14



90°

Ø 50,38

INC

Picture not available
Image non disponible
Imagen no disponible
Immagine non disponibile
Nicht verfügbares Bild
Brak zdjęcia
Картина недоступна

Picture not available
Image non disponible
Imagen no disponible
Immagine non disponibile
Nicht verfügbares Bild
Brak zdjęcia
Картина недоступна

FRONT BEARING	593563
REAR BEARING	593564
PROTECTION COVER	595235
RECTIFIER OR DIODE BRIDGE ASSEMBLY	07 595233
FRONT HOUSING + STATOR	31+05 *595378
PULLEY	11 593836
ROTOR	04 *595380

Valeo**439628/440188**

TG15C125

150

4

7V

14



90°

Ø 50,08

INC

**FRONT BEARING** 21

593563

REAR BEARING 22

593564

PROTECTION COVER 24

595235

RECTIFIER OR DIODE BRIDGE ASSEMBLY 07

595233

FRONT HOUSING + STATOR 31+05

*595378

PULLEY FREE WHEEL + CAP PROTECTION 11c

593514

ROTOR 04

*595380

Valeo**439577/440035****TG15C127**

150

2

6V RL

14



78°

Ø 55,29

INC

Picture not available
Image non disponible
Imagen no disponible
Immagine non disponibile
Nicht verfügbares Bild
Brak zdjęć
Картина недоступна

Picture not available
Image non disponible
Imagen no disponible
Immagine non disponibile
Nicht verfügbares Bild
Brak zdjęć
Картина недоступна

FRONT BEARING 21

593563

REAR BEARING 22

593564

PROTECTION COVER 24

*599076

SEP:SEPARATED REGULATOR -INC:BUILT-IN REGULATOR 02

593857

RECTIFIER OR DIODE BRIDGE ASSEMBLY 07

593803

FRONT HOUSING + STATOR 31+05

595228

PULLEY FREE WHEEL + CAP PROTECTION 11c

593832

ROTOR 04

595303

Valeo**439626/440186****TG15C128**

150

4

6V

14



90°

Ø 52,58

INC

Picture not available
Image non disponible
Imagen no disponible
Immagine non disponibile
Nicht verfügbares Bild
Brak zdjęć
Картина недоступна

Picture not available
Image non disponible
Imagen no disponible
Immagine non disponibile
Nicht verfügbares Bild
Brak zdjęć
Картина недоступна

FRONT BEARING 21

593563

REAR BEARING 22

593564

PROTECTION COVER 24

595235

RECTIFIER OR DIODE BRIDGE ASSEMBLY 07

*595406

FRONT HOUSING + STATOR 31+05

*565408

PULLEY FREE WHEEL + CAP PROTECTION 11c

*595410

ROTOR 04

*595380

Valeo**439647/440217****TG15C130**

150

6V RL

14



Ø 51

Picture not available
Image non disponible
Imagen no disponible
Immagine non disponibile
Nicht verfügbares Bild
Brak zdjęć
Картина недоступна

Picture not available
Image non disponible
Imagen no disponible
Immagine non disponibile
Nicht verfügbares Bild
Brak zdjęć
Картина недоступна

FRONT BEARING 21

593563

REAR BEARING 22

593564

PROTECTION COVER 24

593961

SEP:SEPARATED REGULATOR -INC:BUILT-IN REGULATOR 02

*595387

RECTIFIER OR DIODE BRIDGE ASSEMBLY 07

*595346

FRONT HOUSING + STATOR 31+05

*595443

ROTOR 04

593973

Valeo**439671/440257****TG15C131**

150

6V RL

14



Ø 51

Picture not available
Image non disponible
Imagen no disponible
Immagine non disponibile
Nicht verfügbares Bild
Brak zdjęć
Картина недоступна

Picture not available
Image non disponible
Imagen no disponible
Immagine non disponibile
Nicht verfügbares Bild
Brak zdjęć
Картина недоступна

FRONT BEARING 21

593563

REAR BEARING 22

593564

PROTECTION COVER 24

593957

RECTIFIER OR DIODE BRIDGE ASSEMBLY 07

*595346

FRONT HOUSING + STATOR 31+05

*595443

ROTOR 04

593973

Valeo**439672/440258****TG15C133**

150

6V RL

14



Ø 51

Picture not available
Image non disponible
Imagen no disponible
Immagine non disponibile
Nicht verfügbares Bild
Brak zdjęć
Картина недоступна

Picture not available
Image non disponible
Imagen no disponible
Immagine non disponibile
Nicht verfügbares Bild
Brak zdjęć
Картина недоступна

FRONT BEARING 21

593563

REAR BEARING 22

593564

PROTECTION COVER 24

593790

SEP:SEPARATED REGULATOR -INC:BUILT-IN REGULATOR 02

*595387

RECTIFIER OR DIODE BRIDGE ASSEMBLY 07

595298

FRONT HOUSING + STATOR 31+05

*595489

ROTOR 04

595297

Valeo**439679/440264**

TG15C134

150 4 6V RL

14 ↻ 80° 57,5

Picture not available
Image non disponible
Imagen no disponible
Immagine non disponibile
Nicht verfügbares Bild
Brak zdjęcia
Картина недоступна

Picture not available
Image non disponible
Imagen no disponible
Immagine non disponibile
Nicht verfügbares Bild
Brak zdjęcia
Картина недоступна

FRONT BEARING 21 593563
REAR BEARING 22 593564
PROTECTION COVER 24 *595484
SEP:SEPARATED REGULATOR -INC:BUILT-IN REGULATOR 02 593857
RECTIFIER OR DIODE BRIDGE ASSEMBLY 07 *595483
PULLEY FREE WHEEL + CAP PROTECTION 11c 593832
ROTOR 04 *595482
Valeo **439674/440260**

TG15C135

150 4 6V RL

14 ↻ 78° 55,29

Picture not available
Image non disponible
Imagen no disponible
Immagine non disponibile
Nicht verfügbares Bild
Brak zdjęcia
Картина недоступна

Picture not available
Image non disponible
Imagen no disponible
Immagine non disponibile
Nicht verfügbares Bild
Brak zdjęcia
Картина недоступна

FRONT BEARING 21 593563
REAR BEARING 22 593564
PROTECTION COVER 24 *595494
RECTIFIER OR DIODE BRIDGE ASSEMBLY 07 *595483
PULLEY FREE WHEEL + CAP PROTECTION 11c 593832
ROTOR 04 *595482
Valeo **439701/440286**

TG15C137

150 4 7V

14 ↻ 90° 50,38

Picture not available
Image non disponible
Imagen no disponible
Immagine non disponibile
Nicht verfügbares Bild
Brak zdjęcia
Картина недоступна

Picture not available
Image non disponible
Imagen no disponible
Immagine non disponibile
Nicht verfügbares Bild
Brak zdjęcia
Картина недоступна

FRONT BEARING 21 593563
REAR BEARING 22 593564
PROTECTION COVER 24 595235
SEP:SEPARATED REGULATOR -INC:BUILT-IN REGULATOR 02 593689
RECTIFIER OR DIODE BRIDGE ASSEMBLY 07 *595406
PULLEY 11 593836
ROTOR 04 *595403
Valeo **439663/440248**

TG15C141

150 4 7V

14 ↻ 90° 50,38 INC

Picture not available
Image non disponible
Imagen no disponible
Immagine non disponibile
Nicht verfügbares Bild
Brak zdjęcia
Картина недоступна

Picture not available
Image non disponible
Imagen no disponible
Immagine non disponibile
Nicht verfügbares Bild
Brak zdjęcia
Картина недоступна

FRONT BEARING 21 593563
REAR BEARING 22 593564
PROTECTION COVER 24 595235
RECTIFIER OR DIODE BRIDGE ASSEMBLY 07 595233
FRONT HOUSING + STATOR 31+05 *595402
PULLEY 11 593836
ROTOR 04 *595403
Valeo **439628/440188**

TG15C143

150 2 7V RL

14 ↻ 90° 50,08 INC

Picture not available
Image non disponible
Imagen no disponible
Immagine non disponibile
Nicht verfügbares Bild
Brak zdjęcia
Картина недоступна

Picture not available
Image non disponible
Imagen no disponible
Immagine non disponibile
Nicht verfügbares Bild
Brak zdjęcia
Картина недоступна

FRONT BEARING 21 593563
REAR BEARING 22 593564
PROTECTION COVER 24 595235
RECTIFIER OR DIODE BRIDGE ASSEMBLY 07 595233
FRONT HOUSING + STATOR 31+05 *595402
PULLEY FREE WHEEL + CAP PROTECTION 11c 593514
ROTOR 04 *595403
Valeo **439645/440215**

TG15C144

150 6V

14 ↻ 57,2 INC

Picture not available
Image non disponible
Imagen no disponible
Immagine non disponibile
Nicht verfügbares Bild
Brak zdjęcia
Картина недоступна

Picture not available
Image non disponible
Imagen no disponible
Immagine non disponibile
Nicht verfügbares Bild
Brak zdjęcia
Картина недоступна

FRONT BEARING 21 593563
REAR BEARING 22 593564
PROTECTION COVER 24 593991
SEP:SEPARATED REGULATOR -INC:BUILT-IN REGULATOR 02 *595305
PULLEY FREE WHEEL + CAP PROTECTION 11c 593778
ROTOR 04 595297
Valeo **439656/440242**

TG15C145

150

6V RL

14



Ø 66

INC



FRONT BEARING 21 593563
REAR BEARING 22 593564
PROTECTION COVER 24 593991
SEP:SEPARATED REGULATOR -INC:BUILT-IN REGULATOR 02*595305
RECTIFIER OR DIODE BRIDGE ASSEMBLY 07 *595358
PULLEY FREE WEEL + CAP PROTECTION 11c 593920
ROTOR 04 595297
Valeo 439535/437527

TG15C146

150

4

6V

14



90°

Ø 56,47

INC

Picture not available
Image non disponible
Imagen no disponible
Immagine non disponibile
Nicht verfügbares Bild
Brak zdjęcia
Картина недоступна

Picture not available
Image non disponible
Imagen no disponible
Immagine non disponibile
Nicht verfügbares Bild
Brak zdjęcia
Картина недоступна

FRONT BEARING 21 593563
REAR BEARING 22 593564
PROTECTION COVER 24 595235
RECTIFIER OR DIODE BRIDGE ASSEMBLY 07 *595406
PULLEY FREE WEEL + CAP PROTECTION 11c *595407
ROTOR 04 *595403
Valeo 439646/440216

TG15C149

150

4

6V RL

14



90°

Ø 50,5

Picture not available
Image non disponible
Imagen no disponible
Immagine non disponibile
Nicht verfügbares Bild
Brak zdjęcia
Картина недоступна

Picture not available
Image non disponible
Imagen no disponible
Immagine non disponibile
Nicht verfügbares Bild
Brak zdjęcia
Картина недоступна

FRONT BEARING 21 593563
REAR BEARING 22 593564
PROTECTION COVER 24 593991
SEP:SEPARATED REGULATOR -INC:BUILT-IN REGULATOR 02*595305
FRONT HOUSING 31 *599074
PULLEY FREE WEEL + CAP PROTECTION 11c 595282
ROTOR 04 595297
Valeo 439748/440338

TG15C154

150

4

6V RL

14



78°

Ø 55,29

Picture not available
Image non disponible
Imagen no disponible
Immagine non disponibile
Nicht verfügbares Bild
Brak zdjęcia
Картина недоступна

Picture not available
Image non disponible
Imagen no disponible
Immagine non disponibile
Nicht verfügbares Bild
Brak zdjęcia
Картина недоступна

FRONT BEARING 21 593563
REAR BEARING 22 593564
PROTECTION COVER 24 *595484
SEP:SEPARATED REGULATOR -INC:BUILT-IN REGULATOR 02593857
RECTIFIER OR DIODE BRIDGE ASSEMBLY 07 *595359
FRONT HOUSING + STATOR 31+05 *595492
PULLEY FREE WEEL + CAP PROTECTION 11c *595360
ROTOR 04 595303
Valeo 439697/440282

TG15C156

150

4

6V RL

14



78°

Ø 55,29

INC



FRONT BEARING 21 593563
REAR BEARING 22 593564
PROTECTION COVER 24 *595484
SEP:SEPARATED REGULATOR -INC:BUILT-IN REGULATOR 02593857
RECTIFIER OR DIODE BRIDGE ASSEMBLY 07 593803
FRONT HOUSING + STATOR 31+05 *595490
PULLEY 11 593804
ROTOR 04 595303

TG15C156

150

4

6V RL

14



78°

Ø 55,29

INC



FRONT BEARING 21 593563
REAR BEARING 22 593564
PROTECTION COVER 24 *595484
SEP:SEPARATED REGULATOR -INC:BUILT-IN REGULATOR 02593857
RECTIFIER OR DIODE BRIDGE ASSEMBLY 07 593803
FRONT HOUSING + STATOR 31+05 *595490
PULLEY 11 593804
ROTOR 04 595303



TG15C156

150 4 6V RL

14 ↻ 78° ∇ ∅ 55,29 INC



FRONT BEARING	593563
REAR BEARING	593564
PROTECTION COVER	*595484
SEP:SEPARATED REGULATOR -INC:BUILT-IN REGULATOR	02593857
RECTIFIER OR DIODE BRIDGE ASSEMBLY	593803
FRONT HOUSING + STATOR	*595490
PULLEY	593804
ROTOR	595303

TG15C156

150 4 6V RL

14 ↻ 78° ∇ ∅ 55,29 INC



FRONT BEARING	593563
REAR BEARING	593564
PROTECTION COVER	*595484
SEP:SEPARATED REGULATOR -INC:BUILT-IN REGULATOR	02593857
RECTIFIER OR DIODE BRIDGE ASSEMBLY	593803
FRONT HOUSING + STATOR	*595490
PULLEY	593804
ROTOR	595303

TG15C156

150 4 6V RL

14 ↻ 78° ∇ ∅ 55,29 INC



FRONT BEARING	593563
REAR BEARING	593564
PROTECTION COVER	*595484
SEP:SEPARATED REGULATOR -INC:BUILT-IN REGULATOR	02593857
RECTIFIER OR DIODE BRIDGE ASSEMBLY	593803
FRONT HOUSING + STATOR	*595490
PULLEY	593804
ROTOR	595303

Valeo**439696/440281****TG15C157**

150 2 5V

14 ↻ 95° ∇ ∅ 54,8

Picture not available
Image non disponible
Imagen no disponible
Immagine non disponibile
Nicht verfügbares Bild
Brak zdjęcia
Картина недоступна

Picture not available
Image non disponible
Imagen no disponible
Immagine non disponibile
Nicht verfügbares Bild
Brak zdjęcia
Картина недоступна

FRONT BEARING	593563
REAR BEARING	593564
PROTECTION COVER	593997
SEP:SEPARATED REGULATOR -INC:BUILT-IN REGULATOR	02*595348
FRONT HOUSING + STATOR	31+05 595255
ROTOR	04 593973

Valeo**439723/440313****TG15C165**

150 2 6V

14 ↻ 90° ∇ ∅ 50,5

Picture not available
Image non disponible
Imagen no disponible
Immagine non disponibile
Nicht verfügbares Bild
Brak zdjęcia
Картина недоступна

Picture not available
Image non disponible
Imagen no disponible
Immagine non disponibile
Nicht verfügbares Bild
Brak zdjęcia
Картина недоступна

FRONT BEARING	593563
REAR BEARING	593564
PROTECTION COVER	593991
SEP:SEPARATED REGULATOR -INC:BUILT-IN REGULATOR	02593813
RECTIFIER OR DIODE BRIDGE ASSEMBLY	07 *590975
FRONT HOUSING	31 *590974
PULLEY FREE WHEEL + CAP PROTECTION	11c 595282
ROTOR	04 595297

Valeo**439700/440285****TG15C177**

150 6V RL

14 ↻ ∅ 57,2

Picture not available
Image non disponible
Imagen no disponible
Immagine non disponibile
Nicht verfügbares Bild
Brak zdjęcia
Картина недоступна

Picture not available
Image non disponible
Imagen no disponible
Immagine non disponibile
Nicht verfügbares Bild
Brak zdjęcia
Картина недоступна

FRONT BEARING	593563
REAR BEARING	593564
PROTECTION COVER	593991
SEP:SEPARATED REGULATOR -INC:BUILT-IN REGULATOR	02*599199
ROTOR	04 595297

Valeo**439782/440414**

TG15C181

150

6V

14



Ø 50,98

Picture not available
Image non disponible
Imagen no disponible
Immagine non disponibile
Nicht verfügbares Bild
Brak zdjęcia
Картина недоступна

Picture not available
Image non disponible
Imagen no disponible
Immagine non disponibile
Nicht verfügbares Bild
Brak zdjęcia
Картина недоступна

FRONT BEARING	21	593563
REAR BEARING	22	593564
PROTECTION COVER	24	593957
RECTIFIER OR DIODE BRIDGE ASSEMBLY	07	*595346
FRONT HOUSING + STATOR	31+05	*595443
PULLEY	11	*595368
ROTOR	04	593973
Valeo		439757/440347

TG15C182

150

6V

14



Ø 50,98

Picture not available
Image non disponible
Imagen no disponible
Immagine non disponibile
Nicht verfügbares Bild
Brak zdjęcia
Картина недоступна

Picture not available
Image non disponible
Imagen no disponible
Immagine non disponibile
Nicht verfügbares Bild
Brak zdjęcia
Картина недоступна

FRONT BEARING	21	593563
REAR BEARING	22	593564
PROTECTION COVER	24	593961
SEP:SEPARATED REGULATOR -INC:BUILT-IN REGULATOR	02*	595387
RECTIFIER OR DIODE BRIDGE ASSEMBLY	07	*595346
FRONT HOUSING + STATOR	31+05	*595443
PULLEY	11	*595368
ROTOR	04	593973
Valeo		439746/440336

TG15C189

150

4

6V RL

14



78°

Ø 55,29

Picture not available
Image non disponible
Imagen no disponible
Immagine non disponibile
Nicht verfügbares Bild
Brak zdjęcia
Картина недоступна

Picture not available
Image non disponible
Imagen no disponible
Immagine non disponibile
Nicht verfügbares Bild
Brak zdjęcia
Картина недоступна

FRONT BEARING	21	593563
REAR BEARING	22	593564
PROTECTION COVER	24	*595494
RECTIFIER OR DIODE BRIDGE ASSEMBLY	07	*595483
PULLEY FREE WHEEL + CAP PROTECTION	11c	593832
ROTOR	04	*595482
Valeo		439701/440286

TG15C190

150

4

6V RL

14



90°

Ø 57,2

INC

Picture not available
Image non disponible
Imagen no disponible
Immagine non disponibile
Nicht verfügbares Bild
Brak zdjęcia
Картина недоступна

Picture not available
Image non disponible
Imagen no disponible
Immagine non disponibile
Nicht verfügbares Bild
Brak zdjęcia
Картина недоступна

FRONT BEARING	21	593563
REAR BEARING	22	593564
PROTECTION COVER	24	593991
SEP:SEPARATED REGULATOR -INC:BUILT-IN REGULATOR	02*	595305
RECTIFIER OR DIODE BRIDGE ASSEMBLY	07	*595455
PULLEY FREE WHEEL + CAP PROTECTION	11c	*599143
REAR BRACKET + STATOR	30+05	*595453
ROTOR	04	595297

TG15C190

150

4

6V RL

14



90°

Ø 57,2

INC

Picture not available
Image non disponible
Imagen no disponible
Immagine non disponibile
Nicht verfügbares Bild
Brak zdjęcia
Картина недоступна

Picture not available
Image non disponible
Imagen no disponible
Immagine non disponibile
Nicht verfügbares Bild
Brak zdjęcia
Картина недоступна

FRONT BEARING	21	593563
REAR BEARING	22	593564
PROTECTION COVER	24	593991
SEP:SEPARATED REGULATOR -INC:BUILT-IN REGULATOR	02*	595305
RECTIFIER OR DIODE BRIDGE ASSEMBLY	07	*595455
PULLEY FREE WHEEL + CAP PROTECTION	11c	*599143
REAR BRACKET + STATOR	30+05	*595453
ROTOR	04	595297
Valeo		439775/440408

TG16C010

150

6V

14



Ø 66

INC



FRONT BEARING	21	593563
REAR BEARING	22	593564
PROTECTION COVER	24	593991
SEP:SEPARATED REGULATOR -INC:BUILT-IN REGULATOR	02*	595457
RECTIFIER OR DIODE BRIDGE ASSEMBLY	07	593924
FRONT HOUSING + STATOR	31+05	593925
PULLEY FREE WHEEL + CAP PROTECTION	11c	593920
ROTOR	04	593285
Valeo		439535/437527



TG16C011

150

6V RL

14



Ø 66

INC



FRONT BEARING 21 593563
 REAR BEARING 22 593564
 PROTECTION COVER 24 593991
 SEP:SEPARATED REGULATOR -INC:BUILT-IN REGULATOR 02 595339
 RECTIFIER OR DIODE BRIDGE ASSEMBLY 07 593924
 FRONT HOUSING + STATOR 31+05 593925
 PULLEY FREE WEEL + CAP PROTECTION 11c 593920
 ROTOR 04 593285

Valeo**439564/437563****TG16C012**

150

4

6V

14



90°

Ø 58

INC

Picture not available
 Image non disponible
 Imagen no disponible
 Immagine non disponibile
 Nicht verfügbares Bild
 Brak zdjęcia
 Картина недоступна

Picture not available
 Image non disponible
 Imagen no disponible
 Immagine non disponibile
 Nicht verfügbares Bild
 Brak zdjęcia
 Картина недоступна

FRONT BEARING 21 593563
 REAR BEARING 22 593564
 PROTECTION COVER 24 593991
 SEP:SEPARATED REGULATOR -INC:BUILT-IN REGULATOR 02 595458
 RECTIFIER OR DIODE BRIDGE ASSEMBLY 07 593899
 FRONT HOUSING + STATOR 31+05 593968
 PULLEY 11 593900
 ROTOR 04 593285

Valeo**439548/437541****TG16C013**

150

4

6V

14



90°

Ø 58

INC



FRONT BEARING 21 593563
 REAR BEARING 22 593564
 PROTECTION COVER 24 593991
 SEP:SEPARATED REGULATOR -INC:BUILT-IN REGULATOR 02 595339
 RECTIFIER OR DIODE BRIDGE ASSEMBLY 07 593899
 FRONT HOUSING + STATOR 31+05 593968
 PULLEY 11 593900
 ROTOR 04 593285

Valeo**439557/437554****TG16C014**

150

6V RL

14



Ø 57,2

INC

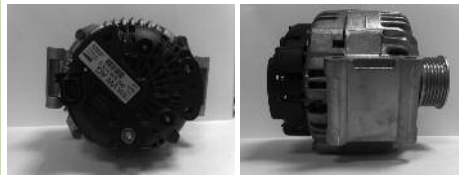

FRONT BEARING 21 593563
 REAR BEARING 22 593564
 PROTECTION COVER 24 593991
 SEP:SEPARATED REGULATOR -INC:BUILT-IN REGULATOR 02* 595457
 RECTIFIER OR DIODE BRIDGE ASSEMBLY 07 593924
 FRONT HOUSING + STATOR 31+05 593925
 PULLEY FREE WEEL + CAP PROTECTION 11c 593778
 ROTOR 04 593285

Valeo**439581/440039****TG17C010**

170

2

6V

14



95°

Ø 53,8

INC

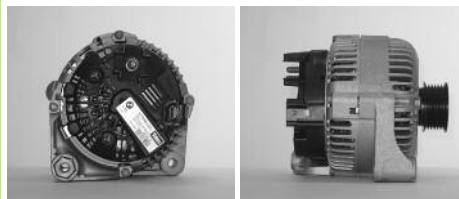

FRONT BEARING 21 593563
 REAR BEARING 22 593564
 PROTECTION COVER 24 593790
 SEP:SEPARATED REGULATOR -INC:BUILT-IN REGULATOR 02* 599101
 RECTIFIER OR DIODE BRIDGE ASSEMBLY 07 593797
 FRONT HOUSING + STATOR 31+05 593799
 PULLEY 11 593794
 ROTOR 04 593798

Valeo**439485/437450****TG17C010b**

170

2

6V

14



95°

Ø 53,8

INC

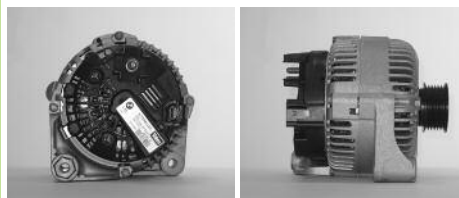

FRONT BEARING 21 593563
 REAR BEARING 22 593564
 PROTECTION COVER 24 593790
 SEP:SEPARATED REGULATOR -INC:BUILT-IN REGULATOR 02* 599101
 RECTIFIER OR DIODE BRIDGE ASSEMBLY 07 593797
 FRONT HOUSING + STATOR 31+05 593799
 PULLEY 11 595272
 ROTOR 04 593798

Valeo**439485/437450**

TG17C011

170

2

6V

14



90°

Ø 54

INC

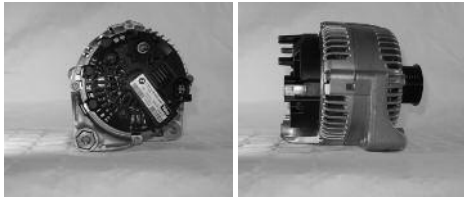

FRONT BEARING 21 593563
 REAR BEARING 22 593564
 PROTECTION COVER 24 593790
 SEP:SEPARATED REGULATOR -INC:BUILT-IN REGULATOR 02*599101
 RECTIFIER OR DIODE BRIDGE ASSEMBLY 07 593797
 FRONT HOUSING + STATOR 31+05 593799
 PULLEY 11 593985
 ROTOR 04 593798

Valeo**439559/437556****TG17C015**

180

6V RL

14



Ø 50,31

INC

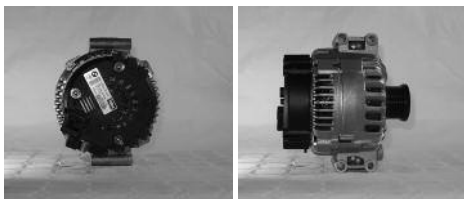

FRONT BEARING 21 593563
 REAR BEARING 22 593684
 PROTECTION COVER 24 595270
 SEP:SEPARATED REGULATOR -INC:BUILT-IN REGULATOR 02593984
 RECTIFIER OR DIODE BRIDGE ASSEMBLY 07 595202
 FRONT HOUSING + STATOR 31+05 595204
 PULLEY FREE WHEEL + CAP PROTECTION 11c 595203
 ROTOR 04 593881

TG17C015

180

6V RL

14



Ø 50,31

INC

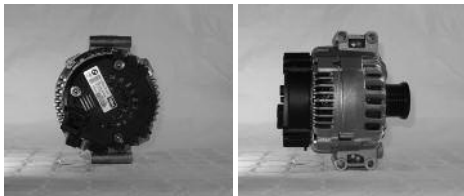

FRONT BEARING 21 593563
 REAR BEARING 22 593684
 PROTECTION COVER 24 595270
 SEP:SEPARATED REGULATOR -INC:BUILT-IN REGULATOR 02593984
 RECTIFIER OR DIODE BRIDGE ASSEMBLY 07 595202
 FRONT HOUSING + STATOR 31+05 595204
 PULLEY FREE WHEEL + CAP PROTECTION 11c 595203
 ROTOR 04 593881

Valeo**439560/437557****TG17C016b**

170

2

7V

14



95°

Ø 51,7

INC

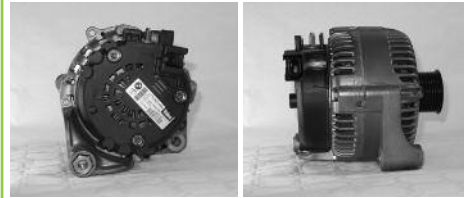

FRONT BEARING 21 593563
 REAR BEARING 22 593684
 PROTECTION COVER 24 595270
 SEP:SEPARATED REGULATOR -INC:BUILT-IN REGULATOR 02599102
 RECTIFIER OR DIODE BRIDGE ASSEMBLY 07 593878
 PULLEY 11 595269
 ROTOR 04 593881

Valeo**439565/437564****TG17C019**

180

4

6V

14



90°

Ø 57,2

INC

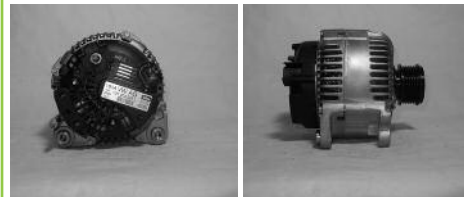

FRONT BEARING 21 593563
 REAR BEARING 22 593684
 PROTECTION COVER 24 593991
 SEP:SEPARATED REGULATOR -INC:BUILT-IN REGULATOR 02595339
 RECTIFIER OR DIODE BRIDGE ASSEMBLY 07 593899
 FRONT HOUSING + STATOR 31+05 593901
 PULLEY FREE WHEEL + CAP PROTECTION 11c 593600
 ROTOR 04 593798

Valeo**439558/437555****TG17C020**

180

4

6V

14



90°

Ø 58

INC

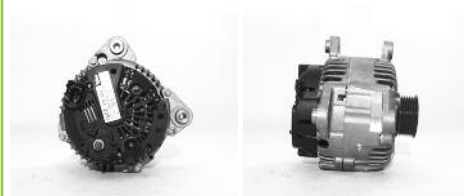

FRONT BEARING 21 593563
 REAR BEARING 22 593684
 PROTECTION COVER 24 593991
 SEP:SEPARATED REGULATOR -INC:BUILT-IN REGULATOR 02595458
 RECTIFIER OR DIODE BRIDGE ASSEMBLY 07 593899
 FRONT HOUSING + STATOR 31+05 593901
 PULLEY 11 593900
 ROTOR 04 593798

Valeo**439527/437507**

TG17C021

180 2 6V

14 ↻ 47° ∇ Ø 50 INC

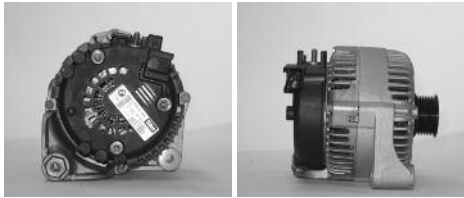

FRONT BEARING 21 593563
 REAR BEARING 22 593684
 PROTECTION COVER 24 593880
 SEP:SEPARATED REGULATOR -INC:BUILT-IN REGULATOR 02 599102
 RECTIFIER OR DIODE BRIDGE ASSEMBLY 07 593878
 PULLEY 11 593879
 ROTOR 04 593881
Valeo 439510/437498

TG17C023

180 6V

14 ↻ Ø 66 INC



FRONT BEARING 21 593563
 REAR BEARING 22 593564
 PROTECTION COVER 24 593921
 SEP:SEPARATED REGULATOR -INC:BUILT-IN REGULATOR 02 595458
 RECTIFIER OR DIODE BRIDGE ASSEMBLY 07 593919
 FRONT HOUSING + STATOR 31+05 593922
 PULLEY FREE WHEEL + CAP PROTECTION 11c 593920
 ROTOR 04 593798
Valeo 439536/437528

TG17C021b

180 2 6v

14 ↻ 47° ∇ Ø 50 INC

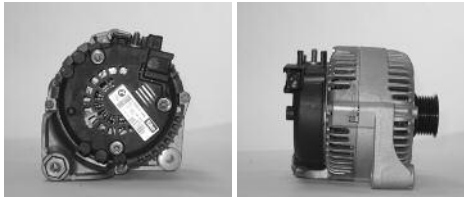

FRONT BEARING 21 593563
 REAR BEARING 22 593684
 PROTECTION COVER 24 593880
 SEP:SEPARATED REGULATOR -INC:BUILT-IN REGULATOR 02 599102
 RECTIFIER OR DIODE BRIDGE ASSEMBLY 07 593878
 PULLEY 11 593879
 ROTOR 04 593881
Valeo 439510/437498

TG17C024

180 4 6V

14 ↻ 90° ∇ Ø 57,2 INC



FRONT BEARING 21 593563
 REAR BEARING 22 593564
 PROTECTION COVER 24 593991
 SEP:SEPARATED REGULATOR -INC:BUILT-IN REGULATOR 02 595458
 RECTIFIER OR DIODE BRIDGE ASSEMBLY 07 593899
 FRONT HOUSING + STATOR 31+05 593901
 PULLEY FREE WHEEL + CAP PROTECTION 11c 593600
 ROTOR 04 593798
Valeo 439549/437542

TG17C022

180 4 6V

14 ↻ 90° ∇ Ø 58 INC

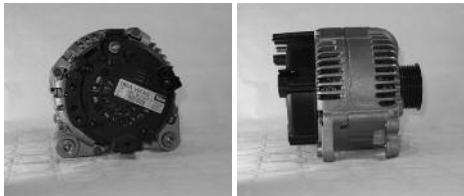

FRONT BEARING 21 593563
 REAR BEARING 22 593564
 PROTECTION COVER 24 593921
 RECTIFIER OR DIODE BRIDGE ASSEMBLY 07 593932
 FRONT HOUSING + STATOR 31+05 593933
 PULLEY 11 593900
 ROTOR 04 593798
Valeo 439541/437535

TG17C026

180 7V RL

14 ↻ Ø 51,3



FRONT BEARING 21 593563
 REAR BEARING 22 593564
 PROTECTION COVER 24 593957
 SEP:SEPARATED REGULATOR -INC:BUILT-IN REGULATOR 02 595238
 RECTIFIER OR DIODE BRIDGE ASSEMBLY 07 593959
 FRONT HOUSING + STATOR 31+05 593988
 PULLEY FREE WHEEL + CAP PROTECTION 11c 593960
 ROTOR 04 593798
Valeo 439579/440037

TG17C027

180

2

6V

14



47°

Ø 51,7

INC

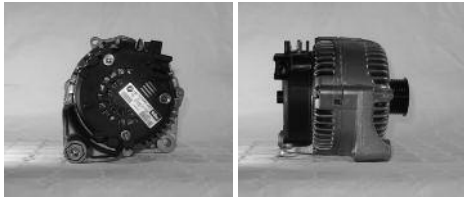

FRONT BEARING 21 593563
 REAR BEARING 22 593684
 PROTECTION COVER 24 593880
 SEP:SEPARATED REGULATOR -INC:BUILT-IN REGULATOR 02 599102
 RECTIFIER OR DIODE BRIDGE ASSEMBLY 07 593878
 PULLEY 11 593917
 ROTOR 04 593881
Valeo 439537/437529

TG17C027b

180

2

6V

14



47°

Ø 51,7

INC

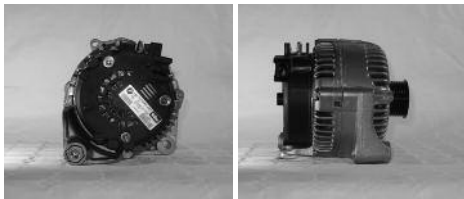

FRONT BEARING 21 593563
 PROTECTION COVER 24 593880
 SEP:SEPARATED REGULATOR -INC:BUILT-IN REGULATOR 02 599102
 RECTIFIER OR DIODE BRIDGE ASSEMBLY 07 593878
 PULLEY 11 593917
 ROTOR 04 593881
Valeo 439537/437529

TG17C028

180

7V RL

14



Ø 51,3

INC

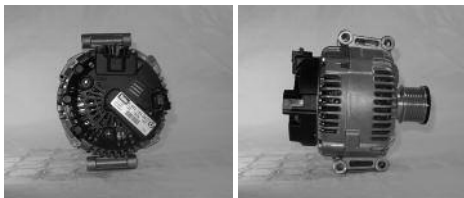

FRONT BEARING 21 593563
 REAR BEARING 22 593564
 PROTECTION COVER 24 593961
 SEP:SEPARATED REGULATOR -INC:BUILT-IN REGULATOR 02 595243
 RECTIFIER OR DIODE BRIDGE ASSEMBLY 07 593959
 FRONT HOUSING + STATOR 31+05 593988
 PULLEY FREE WEEL + CAP PROTECTION 11c 593960
 ROTOR 04 593798
Valeo 439546/437539

TG17C030

180

7V

14



Ø 51,3

INC

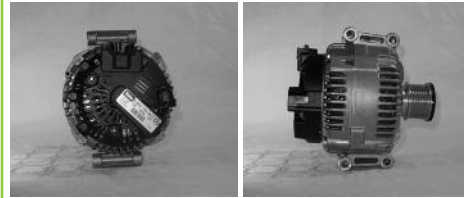

FRONT BEARING 21 593563
 REAR BEARING 22 593564
 PROTECTION COVER 24 593961
 SEP:SEPARATED REGULATOR -INC:BUILT-IN REGULATOR 02 595243
 RECTIFIER OR DIODE BRIDGE ASSEMBLY 07 593959
 FRONT HOUSING + STATOR 31+05 593962
 PULLEY FREE WEEL + CAP PROTECTION 11c 593960
 ROTOR 04 593798
Valeo 439546/437539

TG17C030b

180

7V RL

14



Ø 51,3

INC

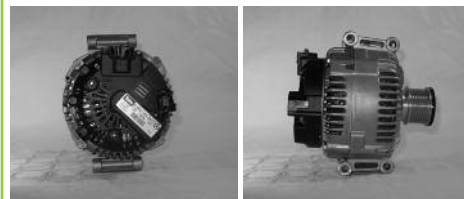

FRONT BEARING 21 593563
 REAR BEARING 22 593564
 PROTECTION COVER 24 593961
 SEP:SEPARATED REGULATOR -INC:BUILT-IN REGULATOR 02 595243
 RECTIFIER OR DIODE BRIDGE ASSEMBLY 07 593959
 FRONT HOUSING + STATOR 31+05 593988
 PULLEY FREE WEEL + CAP PROTECTION 11c 593960
 ROTOR 04 593881
Valeo 439546/437539

TG17C032

180

8V RL

14



Ø 51,3

INC

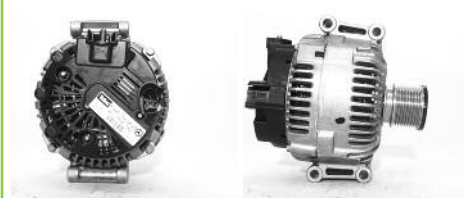

FRONT BEARING 21 593563
 REAR BEARING 22 593564
 PROTECTION COVER 24 593961
 SEP:SEPARATED REGULATOR -INC:BUILT-IN REGULATOR 02 595243
 RECTIFIER OR DIODE BRIDGE ASSEMBLY 07 593959
 FRONT HOUSING + STATOR 31+05 593988
 PULLEY FREE WEEL + CAP PROTECTION 11c 595239
 ROTOR 04 *599230
Valeo 439583/440053









TG17C034

170 2 6V

14 ↻ 95° ∇ ∅ 53,8

Picture not available
Image non disponible
Imagen no disponible
Immagine non disponibile
Nicht verfügbares Bild
Brak zdjęcia
Картина недоступна

Picture not available
Image non disponible
Imagen no disponible
Immagine non disponibile
Nicht verfügbares Bild
Brak zdjęcia
Картина недоступна





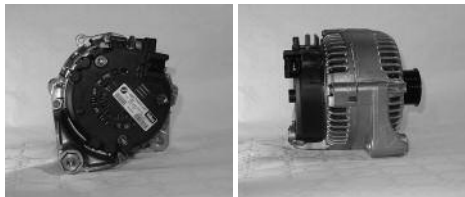

FRONT BEARING  21 593563
REAR BEARING  22 593564
PROTECTION COVER  24 593957
SEP:SEPARATED REGULATOR -INC:BUILT-IN REGULATOR  02599102
RECTIFIER OR DIODE BRIDGE ASSEMBLY  07 595279
FRONT HOUSING + STATOR  31+05 593799
ROTOR  04 593798
Valeo **439605/440108**

TG17C035

180 2 6V

14 ↻ 95° ∇ ∅ 50 INC

**B+(M8)**

FRONT BEARING  21 593563
REAR BEARING  22 593684
PROTECTION COVER  24 595270
SEP:SEPARATED REGULATOR -INC:BUILT-IN REGULATOR  02593984
RECTIFIER OR DIODE BRIDGE ASSEMBLY  07 593878
PULLEY  11 593879
ROTOR  04 593881
Valeo **439566/437579**

TG17C036







180 2 7V

14 ↻ 95° ∇ ∅ 51,7 INC

Picture not available
Image non disponible
Imagen no disponible
Immagine non disponibile
Nicht verfügbares Bild
Brak zdjęcia
Картина недоступна

Picture not available
Image non disponible
Imagen no disponible
Immagine non disponibile
Nicht verfügbares Bild
Brak zdjęcia
Картина недоступна

B+(M8)

FRONT BEARING  21 593563
REAR BEARING  22 593684
PROTECTION COVER  24 595270
SEP:SEPARATED REGULATOR -INC:BUILT-IN REGULATOR  02599102
RECTIFIER OR DIODE BRIDGE ASSEMBLY  07 593878
PULLEY  11 595269
ROTOR  04 593881
Valeo **439601/440097**

TG17C039

180 4 7V RL

14 ↻ 90° ∇ ∅ 57,2 INC

Picture not available
Image non disponible
Imagen no disponible
Immagine non disponibile
Nicht verfügbares Bild
Brak zdjęcia
Картина недоступна

Picture not available
Image non disponible
Imagen no disponible
Immagine non disponibile
Nicht verfügbares Bild
Brak zdjęcia
Картина недоступна

FRONT BEARING  21 593563
REAR BEARING  22 593564
PROTECTION COVER  24 593921
SEP:SEPARATED REGULATOR -INC:BUILT-IN REGULATOR  02595458
RECTIFIER OR DIODE BRIDGE ASSEMBLY  07 *595400
FRONT HOUSING + STATOR  31+05 593933
PULLEY FREE WEEL + CAP PROTECTION  11c *595448
ROTOR  04 593798
Valeo **439624/440184**







TG17C040

180 6V RL

14 ↻ ∅ 57,2

Picture not available
Image non disponible
Imagen no disponible
Immagine non disponibile
Nicht verfügbares Bild
Brak zdjęcia
Картина недоступна

Picture not available
Image non disponible
Imagen no disponible
Immagine non disponibile
Nicht verfügbares Bild
Brak zdjęcia
Картина недоступна







FRONT BEARING  21 593563
REAR BEARING  22 593564
PROTECTION COVER  24 593991
SEP:SEPARATED REGULATOR -INC:BUILT-IN REGULATOR  02595458
RECTIFIER OR DIODE BRIDGE ASSEMBLY  07 593924
FRONT HOUSING + STATOR  31+05 595241
ROTOR  04 593798
Valeo **439582/440042**

TG17C041

180 6V RL

14 ↻ ∅ 51 INC



FRONT BEARING  21 593563
REAR BEARING  22 593564
PROTECTION COVER  24 593790
SEP:SEPARATED REGULATOR -INC:BUILT-IN REGULATOR  02595243
RECTIFIER OR DIODE BRIDGE ASSEMBLY  07 593924
FRONT HOUSING + STATOR  31+05 595246
ROTOR  04 593881
Valeo **439585/440057**

TG17C044

180

6V RL

14



Ø 66

INC



FRONT BEARING 21 593563
 REAR BEARING 22 593564
 PROTECTION COVER 24 593921
 SEP:SEPARATED REGULATOR -INC:BUILT-IN REGULATOR 02 595458
 RECTIFIER OR DIODE BRIDGE ASSEMBLY 07 *595459
 FRONT HOUSING + STATOR 31+05 593922
 PULLEY FREE WEEL + CAP PROTECTION 11c 593920
 ROTOR 04 593798

Valeo

439554/437528

TG17C048

170

2

6V

14



95°

Ø 53,8

INC

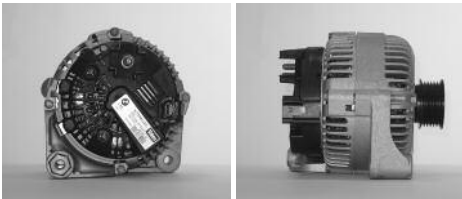

B+(M8)

FRONT BEARING 21 593563
 REAR BEARING 22 593564
 PROTECTION COVER 24 593790
 SEP:SEPARATED REGULATOR -INC:BUILT-IN REGULATOR 02 *599101
 RECTIFIER OR DIODE BRIDGE ASSEMBLY 07 593797
 FRONT HOUSING + STATOR 31+05 593799
 PULLEY 11 595272
 ROTOR 04 593798

TG17C048

170

2

6V

14



95°

Ø 53,8

INC

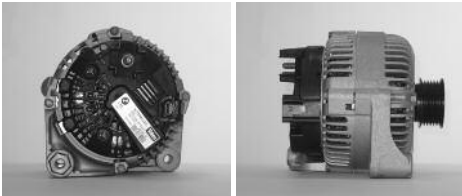

B+(M8)

FRONT BEARING 21 593563
 REAR BEARING 22 593564
 PROTECTION COVER 24 593790
 SEP:SEPARATED REGULATOR -INC:BUILT-IN REGULATOR 02 *599101
 RECTIFIER OR DIODE BRIDGE ASSEMBLY 07 593797
 FRONT HOUSING + STATOR 31+05 593799
 PULLEY 11 595272
 ROTOR 04 593798

Valeo

439485/440107

TG17C054

180

4

6V RL

14



90°

Ø 57,2

INC

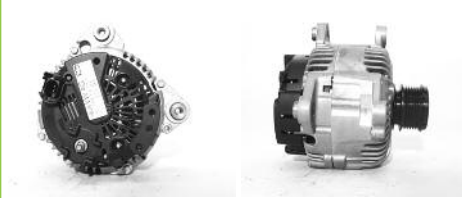

FRONT BEARING 21 593563
 REAR BEARING 22 593564
 PROTECTION COVER 24 593991
 SEP:SEPARATED REGULATOR -INC:BUILT-IN REGULATOR 02 595458
 RECTIFIER OR DIODE BRIDGE ASSEMBLY 07 593899
 FRONT HOUSING + STATOR 31+05 593901
 PULLEY FREE WEEL + CAP PROTECTION 11c 593600
 ROTOR 04 593798

Valeo

439549/437542

TG17C061

180

6V RL

14



Ø 51

INC

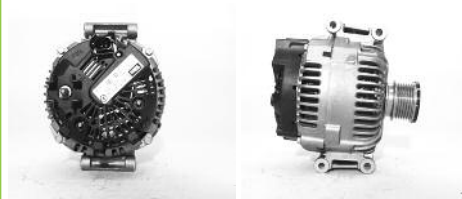

FRONT BEARING 21 593563
 REAR BEARING 22 593564
 PROTECTION COVER 24 593790
 SEP:SEPARATED REGULATOR -INC:BUILT-IN REGULATOR 02 595325
 RECTIFIER OR DIODE BRIDGE ASSEMBLY 07 *595344
 FRONT HOUSING + STATOR 31+05 595246
 ROTOR 04 593881

TG17C061

180

6V RL

14



Ø 51

INC

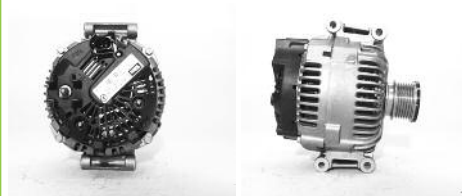

FRONT BEARING 21 593563
 REAR BEARING 22 593564
 PROTECTION COVER 24 593790
 SEP:SEPARATED REGULATOR -INC:BUILT-IN REGULATOR 02 595325
 RECTIFIER OR DIODE BRIDGE ASSEMBLY 07 *595344
 FRONT HOUSING + STATOR 31+05 595246
 ROTOR 04 593881

Valeo

439619/440176



TG17C062

180 4 7V

14 ↻ 90° ↙ ∅ 57

Picture not available
Image non disponible
Imagen no disponible
Immagine non disponibile
Nicht verfügbares Bild
Brak zdjęcia
Картина недоступна

Picture not available
Image non disponible
Imagen no disponible
Immagine non disponibile
Nicht verfügbares Bild
Brak zdjęcia
Картина недоступна

FRONT BEARING 📏21 593563
REAR BEARING 📏22 593564
PROTECTION COVER 📏24 *595367
SEP:SEPARATED REGULATOR -INC:BUILT-IN REGULATOR 📏02 595339
RECTIFIER OR DIODE BRIDGE ASSEMBLY 📏07 *595400
FRONT HOUSING + STATOR 📏31+05 593933
ROTOR 📏04 593798
Valeo 439650

TG17C065

180 6V RL

14 ↻ ∅ 57,2

Picture not available
Image non disponible
Imagen no disponible
Immagine non disponibile
Nicht verfügbares Bild
Brak zdjęcia
Картина недоступна

Picture not available
Image non disponible
Imagen no disponible
Immagine non disponibile
Nicht verfügbares Bild
Brak zdjęcia
Картина недоступна

FRONT BEARING 📏21 593563
REAR BEARING 📏22 593564
PROTECTION COVER 📏24 593991
SEP:SEPARATED REGULATOR -INC:BUILT-IN REGULATOR 📏02 595458
RECTIFIER OR DIODE BRIDGE ASSEMBLY 📏07 593924
FRONT HOUSING + STATOR 📏31+05 595241
PULLEY FREE WHEEL + CAP PROTECTION 📏11c 593778
ROTOR 📏04 593798
Valeo 439582/440042

TG23C011

230 3 7V

14 ↻ 95° ↙ ∅ 51,7 INC

**B+(M8)**

FRONT BEARING 📏21 593563
REAR BEARING 📏22 593684
PROTECTION COVER 📏24 595270
SEP:SEPARATED REGULATOR -INC:BUILT-IN REGULATOR 📏02 *599232
FRONT HOUSING + STATOR 📏31+05 595275
PULLEY 📏11 595269
ROTOR 📏04 595274
Valeo 439602/440095

TG23C012

230 2 6V

14 ↻ 95° ↙ ∅ 58,9

Picture not available
Image non disponible
Imagen no disponible
Immagine non disponibile
Nicht verfügbares Bild
Brak zdjęcia
Картина недоступна

Picture not available
Image non disponible
Imagen no disponible
Immagine non disponibile
Nicht verfügbares Bild
Brak zdjęcia
Картина недоступна

FRONT BEARING 📏21 593563
REAR BEARING 📏22 593684
PROTECTION COVER 📏24 595270
SEP:SEPARATED REGULATOR -INC:BUILT-IN REGULATOR 📏02 *599232
FRONT HOUSING + STATOR 📏31+05 595280
ROTOR 📏04 595274
Valeo 439606/440109

TG23C013

230 7V RL

14 ↻ ∅ 50,31

Picture not available
Image non disponible
Imagen no disponible
Immagine non disponibile
Nicht verfügbares Bild
Brak zdjęcia
Картина недоступна

Picture not available
Image non disponible
Imagen no disponible
Immagine non disponibile
Nicht verfügbares Bild
Brak zdjęcia
Картина недоступна

FRONT BEARING 📏21 593563
REAR BEARING 📏22 593684
PROTECTION COVER 📏24 595270
SEP:SEPARATED REGULATOR -INC:BUILT-IN REGULATOR 📏02 *599232
FRONT HOUSING + STATOR 📏31+05 595276
PULLEY FREE WHEEL + CAP PROTECTION 📏11c 595264
ROTOR 📏04 595274
Valeo 439603/440096

TG23C017

220 6V RL

14 ↻ ∅ 51,3 INC

Picture not available
Image non disponible
Imagen no disponible
Immagine non disponibile
Nicht verfügbares Bild
Brak zdjęcia
Картина недоступна

Picture not available
Image non disponible
Imagen no disponible
Immagine non disponibile
Nicht verfügbares Bild
Brak zdjęcia
Картина недоступна

FRONT BEARING 📏21 593563
REAR BEARING 📏22 593684
PROTECTION COVER 📏24 *595290
SEP:SEPARATED REGULATOR -INC:BUILT-IN REGULATOR 📏02 599171
RECTIFIER OR DIODE BRIDGE ASSEMBLY 📏07 *595289
ROTOR 📏04 595274
Valeo 439597/440178

TG23C018

230

8V

14



33°

Ø 51

INC

Picture not available
Image non disponible
Imagen no disponible
Immagine non disponibile
Nicht verfügbares Bild
Brak zdjęć
Картина недоступна

Picture not available
Image non disponible
Imagen no disponible
Immagine non disponibile
Nicht verfügbares Bild
Brak zdjęć
Картина недоступна

FRONT BEARING 21 593563
REAR BEARING 22 593684
PROTECTION COVER 24 595270
SEP:SEPARATED REGULATOR -INC:BUILT-IN REGULATOR 02*599232
FRONT HOUSING + STATOR 31+05 *595351
PULLEY 11 *595350
ROTOR 04 595274
Valeo 439640/440206

TG23C019

220

7V RL

14



Ø 51,3

Picture not available
Image non disponible
Imagen no disponible
Immagine non disponibile
Nicht verfügbares Bild
Brak zdjęć
Картина недоступна

Picture not available
Image non disponible
Imagen no disponible
Immagine non disponibile
Nicht verfügbares Bild
Brak zdjęć
Картина недоступна

FRONT BEARING 21 593563
REAR BEARING 22 593684
PROTECTION COVER 24 *595290
SEP:SEPARATED REGULATOR -INC:BUILT-IN REGULATOR 02*599171
RECTIFIER OR DIODE BRIDGE ASSEMBLY 07 *595289
FRONT HOUSING + STATOR 31+05 *595288
PULLEY FREE WHEEL + CAP PROTECTION 11c 593960
ROTOR 04 595274
Valeo 439609/440124

TG23C022

220

6V

14



Ø 51,3

INC

Picture not available
Image non disponible
Imagen no disponible
Immagine non disponibile
Nicht verfügbares Bild
Brak zdjęć
Картина недоступна

Picture not available
Image non disponible
Imagen no disponible
Immagine non disponibile
Nicht verfügbares Bild
Brak zdjęć
Картина недоступна

FRONT BEARING 21 593563
REAR BEARING 22 593684
PROTECTION COVER 24 *595290
SEP:SEPARATED REGULATOR -INC:BUILT-IN REGULATOR 02*595324
RECTIFIER OR DIODE BRIDGE ASSEMBLY 07 *595289
ROTOR 04 595274
Valeo 439599/440182

TG23C033

230

8V

14



33°

Ø 51

INC

Picture not available
Image non disponible
Imagen no disponible
Immagine non disponibile
Nicht verfügbares Bild
Brak zdjęć
Картина недоступна

Picture not available
Image non disponible
Imagen no disponible
Immagine non disponibile
Nicht verfügbares Bild
Brak zdjęć
Картина недоступна

FRONT BEARING 21 593563
REAR BEARING 22 593684
PROTECTION COVER 24 595270
SEP:SEPARATED REGULATOR -INC:BUILT-IN REGULATOR 02*599232
FRONT HOUSING + STATOR 31+05 *595351
PULLEY 11 *595350
ROTOR 04 595274
Valeo 439640/440206

TG7S010

70

4

6V

14



80°

Ø 55,2

INC



FRONT BEARING 21 593563
REAR BEARING 22 593684
SEP:SEPARATED REGULATOR -INC:BUILT-IN REGULATOR 02*593993
RECTIFIER OR DIODE BRIDGE ASSEMBLY 07 593994
FRONT HOUSING 31 593657
PULLEY 11 593519
ROTOR 04 593820
STATOR 05 593590

TG7S010

70

4

6V

14



80°

Ø 55,2

INC



FRONT BEARING 21 593563
REAR BEARING 22 593684
SEP:SEPARATED REGULATOR -INC:BUILT-IN REGULATOR 02*593993
RECTIFIER OR DIODE BRIDGE ASSEMBLY 07 593994
FRONT HOUSING 31 593657
PULLEY 11 593519
ROTOR 04 593820
STATOR 05 593590
Valeo 439275/437355



TG7S011

70 4 6V

14 ↻ 40° ∇ Ø 52 INC

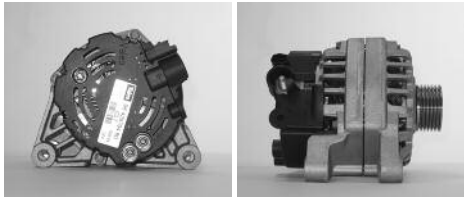

FRONT BEARING	↗ 21	593563
REAR BEARING	↗ 22	593564
SEP:SEPARATED REGULATOR -INC:BUILT-IN REGULATOR	↗ 02	593993
RECTIFIER OR DIODE BRIDGE ASSEMBLY	↗ 07	593994
FRONT HOUSING	↗ 31	593657
PULLEY	↗ 11	593331
ROTOR	↗ 04	593820
STATOR	↗ 05	593590

Valeo **439494/437460**

TG7S012

80 6V

14 ↻ Ø 50 INC

Picture not available Image non disponible Imagen no disponible Immagine non disponibile Nicht verfügbares Bild Brak zdjęcia Картина недоступна	Picture not available Image non disponible Imagen no disponible Immagine non disponibile Nicht verfügbares Bild Brak zdjęcia Картина недоступна
---	---

FRONT BEARING	↗ 21	593563
REAR BEARING	↗ 22	593564
PROTECTION COVER	↗ 24	*599122
RECTIFIER OR DIODE BRIDGE ASSEMBLY	↗ 07	595249
FRONT HOUSING	↗ 31	595250
PULLEY	↗ 11	593809
REGULATOR + COVER	↗ 02+24	*599121
ROTOR	↗ 04	593820
STATOR	↗ 05	595251

Valeo **439589/440063**

TG7S013

70 4 6V

14 ↻ 80° ∇ Ø 52 INC

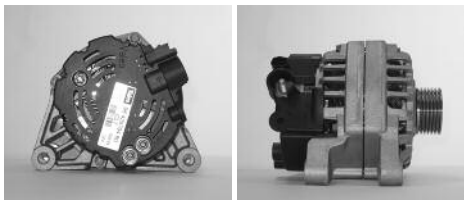

FRONT BEARING	↗ 21	593563
REAR BEARING	↗ 22	593564
SEP:SEPARATED REGULATOR -INC:BUILT-IN REGULATOR	↗ 02	593993
RECTIFIER OR DIODE BRIDGE ASSEMBLY	↗ 07	593994
FRONT HOUSING	↗ 31	593657
PULLEY	↗ 11	593331
ROTOR	↗ 04	593820
STATOR	↗ 05	593590

Valeo **439494/437460**

TG7S014

70 4 6V

14 ↻ 79° ∇ Ø 55,29 INC

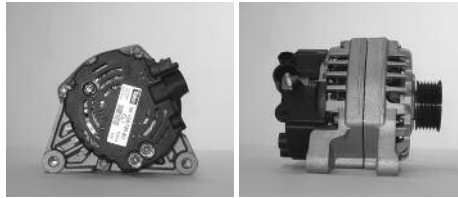

FRONT BEARING	↗ 21	593563
REAR BEARING	↗ 22	593564
SEP:SEPARATED REGULATOR -INC:BUILT-IN REGULATOR	↗ 02	593993
RECTIFIER OR DIODE BRIDGE ASSEMBLY	↗ 07	593994
FRONT HOUSING	↗ 31	593657
PULLEY	↗ 11	593519
ROTOR	↗ 04	593820
STATOR	↗ 05	593590

TG7S014

70 4 6V

14 ↻ 79° ∇ Ø 55,29 INC

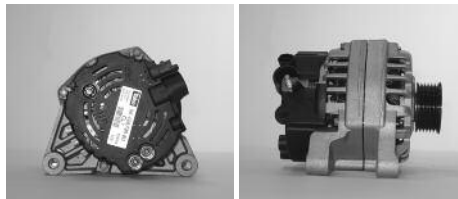

FRONT BEARING	↗ 21	593563
REAR BEARING	↗ 22	593564
SEP:SEPARATED REGULATOR -INC:BUILT-IN REGULATOR	↗ 02	593993
RECTIFIER OR DIODE BRIDGE ASSEMBLY	↗ 07	593994
FRONT HOUSING	↗ 31	593657
PULLEY	↗ 11	593519
ROTOR	↗ 04	593820
STATOR	↗ 05	593590

Valeo **439691/440284**

TG8C011

80 2 4V

14 ↻ 44° ∇ Ø 56,2 INC

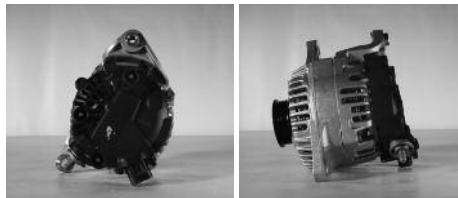

FRONT BEARING	↗ 21	593563
REAR BEARING	↗ 22	593564
PROTECTION COVER	↗ 24	593823
SEP:SEPARATED REGULATOR -INC:BUILT-IN REGULATOR	↗ 02	593818
RECTIFIER OR DIODE BRIDGE ASSEMBLY	↗ 07	593819
FRONT HOUSING + STATOR	↗ 31+05	593821
PULLEY	↗ 11	593822
ROTOR	↗ 04	593820

Valeo **439490/437455**

TG8C018

80

2

4V

14



44°

Ø 56,2

INC

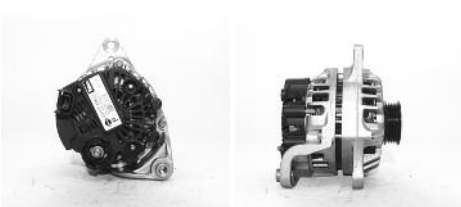

FRONT BEARING 21 593563
 REAR BEARING 22 593564
 PROTECTION COVER 24 593969
 SEP:SEPARATED REGULATOR -INC:BUILT-IN REGULATOR 02 593915
 RECTIFIER OR DIODE BRIDGE ASSEMBLY 07 593916
 FRONT HOUSING + STATOR 31+05 593821
 PULLEY 11 593822
 ROTOR 04 593820

Valeo

439550/437543

TG8S010

75

6V

14



Ø 55

INC

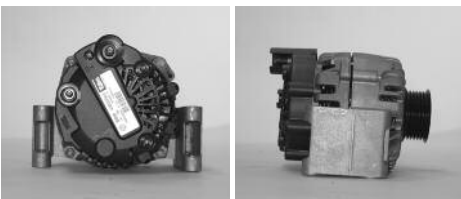

B+(M8)D+(M5)

FRONT BEARING 21 593563
 REAR BEARING 22 593564
 PROTECTION COVER 24 593892
 RECTIFIER OR DIODE BRIDGE ASSEMBLY 07 593859
 FRONT HOUSING 31 593862
 PULLEY 11 593865
 REGULATOR + COVER 02+24 593947
 ROTOR 04 593820
 STATOR 05 593590

Valeo

439506/437475

TG8S012

75

6V RL

14



Ø 55,39

INC

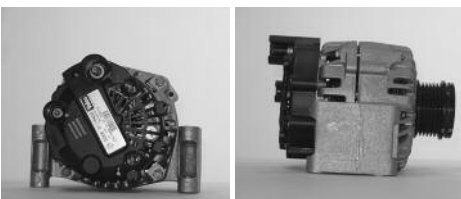

B+(M8)D+(M5)

FRONT BEARING 21 593563
 REAR BEARING 22 593564
 PROTECTION COVER 24 593892
 RECTIFIER OR DIODE BRIDGE ASSEMBLY 07 593859
 FRONT HOUSING 31 593862
 PULLEY FREE WEEL + CAP PROTECTION 11c 593860
 REGULATOR + COVER 02+24 593947
 ROTOR 04 593820
 STATOR 05 593590

Valeo

439504/437473

TG8S013

75

6V RL

14



Ø 55,5

INC



B+(M8)D+(M5)

FRONT BEARING 21 593563
 REAR BEARING 22 593564
 PROTECTION COVER 24 593892
 SEP:SEPARATED REGULATOR -INC:BUILT-IN REGULATOR 02 593890
 RECTIFIER OR DIODE BRIDGE ASSEMBLY 07 593859
 FRONT HOUSING 31 593862
 PULLEY FREE WEEL + CAP PROTECTION 11c 593860
 ROTOR 04 593820
 STATOR 05 593590

Valeo

439523/437503

TG8S014

75

6 V RL

14



Ø 55,5

INC



B+(M8)D+(M5)

PULLEY FREE WEEL + CAP PROTECTION 11c 593860

Valeo

439523/437503

TG8S016

75

6V RL

14



Ø 55,5

INC



B+(M8)D+(M5)

FRONT BEARING 21 593563
 REAR BEARING 22 593564
 PROTECTION COVER 24 593892
 SEP:SEPARATED REGULATOR -INC:BUILT-IN REGULATOR 02 593890
 RECTIFIER OR DIODE BRIDGE ASSEMBLY 07 593859
 FRONT HOUSING 31 593862
 PULLEY FREE WEEL + CAP PROTECTION 11c *599223
 ROTOR 04 593820
 STATOR 05 593590

TG8S016

75

6V RL

14



Ø 55,5

INC

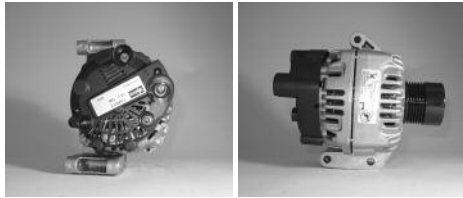
**B+(M8)D+(M5)**

FRONT BEARING	593563
REAR BEARING	593564
PROTECTION COVER	593892
SEP:SEPARATED REGULATOR -INC:BUILT-IN REGULATOR	02593890
RECTIFIER OR DIODE BRIDGE ASSEMBLY	593859
FRONT HOUSING	593862
PULLEY FREE WHEEL + CAP PROTECTION	11c *599223
ROTOR	04 593820
STATOR	05 593590

Valeo**439705/440296****TG8S017**

75

2

6V

14



0°

Ø 58,18

INC

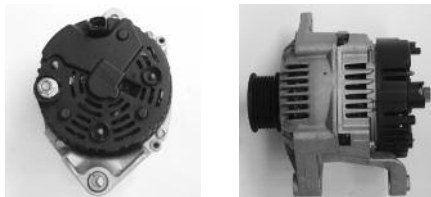

FRONT BEARING	21 593563
REAR BEARING	22 593564
PROTECTION COVER	24 593969
SEP:SEPARATED REGULATOR -INC:BUILT-IN REGULATOR	02593689
RECTIFIER OR DIODE BRIDGE ASSEMBLY	07 595205
FRONT HOUSING	31 595207
ROTOR	04 593820
STATOR	05 593590

Valeo**439230/437112****TG8S019**

80

2

4V

14



44°

Ø 56,2

INC

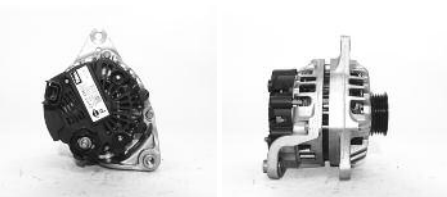

FRONT BEARING	21 593563
REAR BEARING	22 593564
PROTECTION COVER	24 593969
SEP:SEPARATED REGULATOR -INC:BUILT-IN REGULATOR	02593915
RECTIFIER OR DIODE BRIDGE ASSEMBLY	07 595215
FRONT HOUSING	31 595216
PULLEY	11 593822
ROTOR	04 593820
STATOR	05 593590

Valeo**439550/437543****TG8S021**

75

6V

14



Ø 55

INC

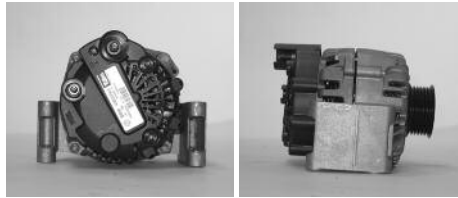
**B+(M8)D+(M5)**

FRONT BEARING	21 593563
REAR BEARING	22 593564
PROTECTION COVER	24 593892
SEP:SEPARATED REGULATOR -INC:BUILT-IN REGULATOR	02*595389
RECTIFIER OR DIODE BRIDGE ASSEMBLY	07 593859
FRONT HOUSING	31 593862
PULLEY	11 593865
ROTOR	04 593820
STATOR	05 593590

Valeo**439506/437475****TG8S022**

75

6V RL

14



Ø 55,39

INC

**B+(M8)D+(M5)**

FRONT BEARING	21 593563
REAR BEARING	22 593564
PROTECTION COVER	24 593892
SEP:SEPARATED REGULATOR -INC:BUILT-IN REGULATOR	02*595389
RECTIFIER OR DIODE BRIDGE ASSEMBLY	07 593859
FRONT HOUSING	31 593862
PULLEY FREE WHEEL + CAP PROTECTION	11c 593860
ROTOR	04 593820
STATOR	05 593590

Valeo**439504/437473****TG8S024**

80

3

4V

14



23°

Ø 51,4

INC



FRONT BEARING	21 593563
REAR BEARING	22 593564
PROTECTION COVER	24 593969
SEP:SEPARATED REGULATOR -INC:BUILT-IN REGULATOR	02593915
RECTIFIER OR DIODE BRIDGE ASSEMBLY	07 595215
FRONT HOUSING	31 595216
PULLEY	11 595257
ROTOR	04 593820
STATOR	05 593590

Valeo**439595/440074**

TG8S025

80

3

6V

14



0°

Ø 56,26

INC



FRONT BEARING 21 593563
 REAR BEARING 22 593564
 PROTECTION COVER 24 593969
 SEP:SEPARATED REGULATOR -INC:BUILT-IN REGULATOR 02 593689
 RECTIFIER OR DIODE BRIDGE ASSEMBLY 07 *593381
 FRONT HOUSING 31 595207
 ROTOR 04 593820
 STATOR 05 593590

Valeo**439230/437112****TG9B024**

90

4

6V

14



80°

Ø 55,29

INC



FRONT BEARING 21 593563
 REAR BEARING 22 593564
 SEP:SEPARATED REGULATOR -INC:BUILT-IN REGULATOR 02 593993
 RECTIFIER OR DIODE BRIDGE ASSEMBLY 07 593995
 FRONT HOUSING 31 593650
 PULLEY 11 593519
 ROTOR 04 593926
 STATOR 05 593952

TG9B024

90

4

6V

14



80°

Ø 55,29

INC

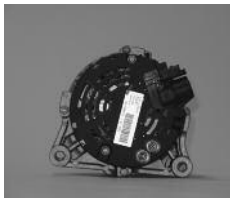

FRONT BEARING 21 593563
 REAR BEARING 22 593564
 SEP:SEPARATED REGULATOR -INC:BUILT-IN REGULATOR 02 593993
 RECTIFIER OR DIODE BRIDGE ASSEMBLY 07 593995
 FRONT HOUSING 31 593650
 PULLEY 11 593519
 ROTOR 04 593926
 STATOR 05 593952

TG9B024

90

4

6V

14



80°

Ø 55,29

INC

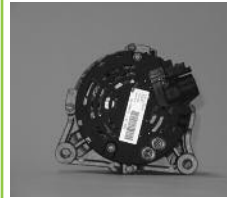

FRONT BEARING 21 593563
 REAR BEARING 22 593564
 SEP:SEPARATED REGULATOR -INC:BUILT-IN REGULATOR 02 593993
 RECTIFIER OR DIODE BRIDGE ASSEMBLY 07 593995
 FRONT HOUSING 31 593650
 PULLEY 11 593519
 ROTOR 04 593926
 STATOR 05 593952

TG9B024

90

4

6V

14



80°

Ø 55,29

INC



FRONT BEARING 21 593563
 REAR BEARING 22 593564
 SEP:SEPARATED REGULATOR -INC:BUILT-IN REGULATOR 02 593993
 RECTIFIER OR DIODE BRIDGE ASSEMBLY 07 593995
 FRONT HOUSING 31 593650
 PULLEY 11 593519
 ROTOR 04 593926
 STATOR 05 593952

Valeo**439277/437357****TG9B025**

90

4

6V

14



40°

Ø 52

INC



FRONT BEARING 21 593674
 REAR BEARING 22 593564
 SEP:SEPARATED REGULATOR -INC:BUILT-IN REGULATOR 02 593993
 RECTIFIER OR DIODE BRIDGE ASSEMBLY 07 593995
 FRONT HOUSING 31 593650
 PULLEY 11 593619
 ROTOR 04 593996
 STATOR 05 593952

Valeo**439495/437461**

TG9B026

90

4

6V

14



40°

Ø 57,5

INC



FRONT BEARING 21 593563
 REAR BEARING 22 593564
 SEP:SEPARATED REGULATOR -INC:BUILT-IN REGULATOR 02 593857
 RECTIFIER OR DIODE BRIDGE ASSEMBLY 07 595208
 FRONT HOUSING 31 595209
 PULLEY FREE WEEL + CAP PROTECTION 11c 593832
 ROTOR 04 593996
 STATOR 05 593952

Valeo

439568/437584

TG9B028

90

4

6V

14



40°

Ø 57,5

INC



FRONT BEARING 21 593563
 REAR BEARING 22 593564
 SEP:SEPARATED REGULATOR -INC:BUILT-IN REGULATOR 02 593857
 RECTIFIER OR DIODE BRIDGE ASSEMBLY 07 595208
 FRONT HOUSING 31 595209
 PULLEY 11 593804
 ROTOR 04 593996
 STATOR 05 593952

Valeo

439573/440017

TG9B042

95

4

7V

14



90°

Ø 56,08

INC

Picture not available
 Image non disponible
 Imagen no disponible
 Immagine non disponibile
 Nicht verfügbares Bild
 Brak zdjęcia
 Картина недоступна

Picture not available
 Image non disponible
 Imagen no disponible
 Immagine non disponibile
 Nicht verfügbares Bild
 Brak zdjęcia
 Картина недоступна

B+(M8)

FRONT BEARING 21 593563
 REAR BEARING 22 593564
 PROTECTION COVER 24 593969
 SEP:SEPARATED REGULATOR -INC:BUILT-IN REGULATOR 02 *595416
 RECTIFIER OR DIODE BRIDGE ASSEMBLY 07 *595418
 FRONT HOUSING 31 *595417
 ROTOR 04 593996
 STATOR 05 593952

Valeo

439625/440185

TG9B043

90

4

6V

14



80°

Ø 49,79

INC



FRONT BEARING 21 593563
 REAR BEARING 22 593564
 SEP:SEPARATED REGULATOR -INC:BUILT-IN REGULATOR 02 593993
 RECTIFIER OR DIODE BRIDGE ASSEMBLY 07 593995
 FRONT HOUSING 31 593650
 PULLEY 11 593619
 ROTOR 04 593926
 STATOR 05 593952

TG9B043

90

4

6V

14



80°

Ø 49,79

INC



FRONT BEARING 21 593563
 REAR BEARING 22 593564
 SEP:SEPARATED REGULATOR -INC:BUILT-IN REGULATOR 02 593993
 RECTIFIER OR DIODE BRIDGE ASSEMBLY 07 593995
 FRONT HOUSING 31 593650
 PULLEY 11 593619
 ROTOR 04 593926
 STATOR 05 593952

Valeo

439495/437461

TG9B044

90

4

6V RL

14



80°

Ø 57,5

INC

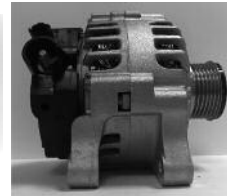

FRONT BEARING 21 593563
 REAR BEARING 22 593564
 SEP:SEPARATED REGULATOR -INC:BUILT-IN REGULATOR 02 593857
 RECTIFIER OR DIODE BRIDGE ASSEMBLY 07 595208
 FRONT HOUSING 31 595209
 PULLEY FREE WEEL + CAP PROTECTION 11c 593832
 ROTOR 04 593926
 STATOR 05 593952

Valeo

439568/437584

TG9B045

90

4

6V

14



80°

Ø 57,5

INC

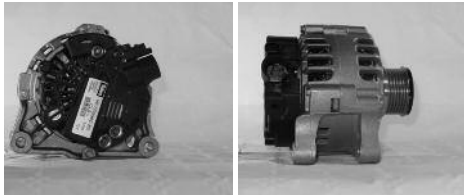

FRONT BEARING	21	593563
REAR BEARING	22	593564
SEP:SEPARATED REGULATOR -INC:BUILT-IN REGULATOR	02	593857
RECTIFIER OR DIODE BRIDGE ASSEMBLY	07	595208
FRONT HOUSING	31	595209
PULLEY	11	593804
ROTOR	04	593926
STATOR	05	593952

Valeo

439573/440017

TG9B047

95

4

6V

14



90°

Ø 56,38

Picture not available
Image non disponible
Imagen no disponible
Immagine non disponibile
Nicht verfügbares Bild
Brak zdjęcia
Картина недоступна

Picture not available
Image non disponible
Imagen no disponible
Immagine non disponibile
Nicht verfügbares Bild
Brak zdjęcia
Картина недоступна

FRONT BEARING	21	593563
REAR BEARING	22	593564
PROTECTION COVER	24	593969
SEP:SEPARATED REGULATOR -INC:BUILT-IN REGULATOR	02	593689
RECTIFIER OR DIODE BRIDGE ASSEMBLY	07	*595418
FRONT HOUSING	31	*595417
PULLEY	11	595217
ROTOR	04	593996
STATOR	05	593952

Valeo

439661/440246

TG9B049

90

4

6V RL

14



89°

Ø 57,5

INC

Picture not available
Image non disponible
Imagen no disponible
Immagine non disponibile
Nicht verfügbares Bild
Brak zdjęcia
Картина недоступна

Picture not available
Image non disponible
Imagen no disponible
Immagine non disponibile
Nicht verfügbares Bild
Brak zdjęcia
Картина недоступна

FRONT BEARING	21	593563
REAR BEARING	22	593564
PROTECTION COVER	24	*595319
SEP:SEPARATED REGULATOR -INC:BUILT-IN REGULATOR	02	*595366
RECTIFIER OR DIODE BRIDGE ASSEMBLY	07	595208
FRONT HOUSING	31	595209
PULLEY FREE WEEL + CAP PROTECTION	11c	593832
ROTOR	04	593926
STATOR	05	593952

Valeo

439635/440202

TG9B052

95

4

6V RL

14



90°

Ø 56,47

Picture not available
Image non disponible
Imagen no disponible
Immagine non disponibile
Nicht verfügbares Bild
Brak zdjęcia
Картина недоступна

Picture not available
Image non disponible
Imagen no disponible
Immagine non disponibile
Nicht verfügbares Bild
Brak zdjęcia
Картина недоступна

FRONT BEARING	21	593563
REAR BEARING	22	593564
PROTECTION COVER	24	593969
SEP:SEPARATED REGULATOR -INC:BUILT-IN REGULATOR	02	593689
RECTIFIER OR DIODE BRIDGE ASSEMBLY	07	*595418
FRONT HOUSING	31	*595417
PULLEY FREE WEEL + CAP PROTECTION	11c	*595407
ROTOR	04	593996
STATOR	05	593952

Valeo

439676/440261

TG9B053

95

4

6V

14



90°

Ø 56,38

Picture not available
Image non disponible
Imagen no disponible
Immagine non disponibile
Nicht verfügbares Bild
Brak zdjęcia
Картина недоступна

Picture not available
Image non disponible
Imagen no disponible
Immagine non disponibile
Nicht verfügbares Bild
Brak zdjęcia
Картина недоступна

FRONT BEARING	21	593563
REAR BEARING	22	593564
PROTECTION COVER	24	593969
SEP:SEPARATED REGULATOR -INC:BUILT-IN REGULATOR	02	593689
RECTIFIER OR DIODE BRIDGE ASSEMBLY	07	*595418
FRONT HOUSING	31	*595417
PULLEY	11	595217
ROTOR	04	593996
STATOR	05	593952

Valeo

439661/440246

TG9B064

90

4

6V

14



80°

Ø 55,66

Picture not available
Image non disponible
Imagen no disponible
Immagine non disponibile
Nicht verfügbares Bild
Brak zdjęcia
Картина недоступна

Picture not available
Image non disponible
Imagen no disponible
Immagine non disponibile
Nicht verfügbares Bild
Brak zdjęcia
Картина недоступна

FRONT BEARING	21	593563
REAR BEARING	22	593564
SEP:SEPARATED REGULATOR -INC:BUILT-IN REGULATOR	02	593993
RECTIFIER OR DIODE BRIDGE ASSEMBLY	07	593995
FRONT HOUSING	31	593650
PULLEY	11	593519
ROTOR	04	593926
STATOR	05	593952

Valeo

439692/440277



TG9B065

90 4 6V

14 ↻ 78° ∇ Ø 49,79 INC

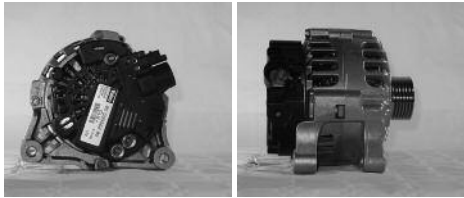

FRONT BEARING	593563
REAR BEARING	593564
SEP:SEPARATED REGULATOR -INC:BUILT-IN REGULATOR	02593993
RECTIFIER OR DIODE BRIDGE ASSEMBLY	07 593995
FRONT HOUSING	31 593650
PULLEY	11 593619
ROTOR	04 593926
STATOR	05 593952

TG9B065

90 4 6V

14 ↻ 78° ∇ Ø 49,79 INC

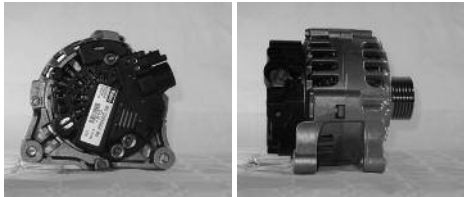

FRONT BEARING	21 593563
REAR BEARING	22 593564
SEP:SEPARATED REGULATOR -INC:BUILT-IN REGULATOR	02593993
RECTIFIER OR DIODE BRIDGE ASSEMBLY	07 593995
FRONT HOUSING	31 593650
PULLEY	11 593619
ROTOR	04 593926
STATOR	05 593952

Valeo**439693/440289****TG9B066**

90 4 6V RL

14 ↻ 80° ∇ Ø 55,29

Picture not available
Image non disponible
Imagen no disponible
Immagine non disponibile
Nicht verfügbares Bild
Brak zdjęcia
Картина недоступна

Picture not available
Image non disponible
Imagen no disponible
Immagine non disponibile
Nicht verfügbares Bild
Brak zdjęcia
Картина недоступна

FRONT BEARING	21 593563
REAR BEARING	22 593564
SEP:SEPARATED REGULATOR -INC:BUILT-IN REGULATOR	02593857
RECTIFIER OR DIODE BRIDGE ASSEMBLY	07 595208
FRONT HOUSING	31 595209
PULLEY FREE WHEEL + CAP PROTECTION	11c 593832
ROTOR	04 593926
STATOR	05 593952

Valeo**439694/440279****TG9B067**

90 4 6V RL

14 ↻ 78° ∇ Ø 55,29

Picture not available
Image non disponible
Imagen no disponible
Immagine non disponibile
Nicht verfügbares Bild
Brak zdjęcia
Картина недоступна

Picture not available
Image non disponible
Imagen no disponible
Immagine non disponibile
Nicht verfügbares Bild
Brak zdjęcia
Картина недоступна

FRONT BEARING	21 593563
REAR BEARING	22 593564
SEP:SEPARATED REGULATOR -INC:BUILT-IN REGULATOR	02593857
RECTIFIER OR DIODE BRIDGE ASSEMBLY	07 595208
FRONT HOUSING	31 595209
PULLEY	11 593804
ROTOR	04 593926
STATOR	05 593952

Valeo**439695/440280****TG9B068**

90 4 6V RL

14 ↻ 78° ∇ Ø 55,29

Picture not available
Image non disponible
Imagen no disponible
Immagine non disponibile
Nicht verfügbares Bild
Brak zdjęcia
Картина недоступна

Picture not available
Image non disponible
Imagen no disponible
Immagine non disponibile
Nicht verfügbares Bild
Brak zdjęcia
Картина недоступна

FRONT BEARING	21 593563
REAR BEARING	22 593564
PROTECTION COVER	24 *595460
SEP:SEPARATED REGULATOR -INC:BUILT-IN REGULATOR	02 *595366
RECTIFIER OR DIODE BRIDGE ASSEMBLY	07 595208
FRONT HOUSING	31 595209
PULLEY FREE WHEEL + CAP PROTECTION	11c 593832
ROTOR	04 593926
STATOR	05 593952

Valeo**439703/440291****TG9C013**

90 6V

14 ↻ Ø 50 INC

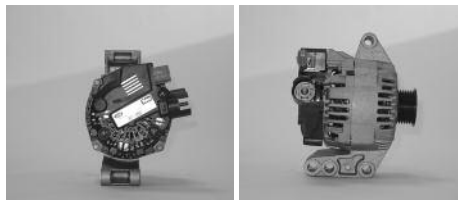

FRONT BEARING	21 593563
REAR BEARING	22 593564
PROTECTION COVER	24 *599122
RECTIFIER OR DIODE BRIDGE ASSEMBLY	07 593808
FRONT HOUSING + STATOR	31+05 593812
PULLEY	11 593809
REGULATOR + COVER	02+24 *599121
ROTOR	04 593811

Valeo**439488/437453**

TG9S010 90 6V
14 Ø 55,39 INC

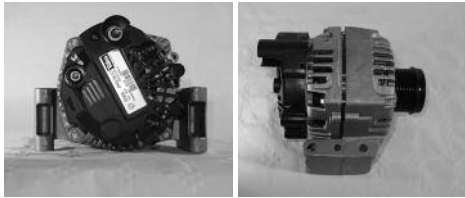

B+(M8)D+(M5)

- FRONT BEARING 21 593563
- REAR BEARING 22 593564
- PROTECTION COVER 24 593892
- RECTIFIER OR DIODE BRIDGE ASSEMBLY 07 593859
- FRONT HOUSING 31 593862
- PULLEY FREE WEEL + CAP PROTECTION 11c 593860
- REGULATOR + COVER 02+24 593947
- ROTOR 04 *595390
- STATOR 05 593864

Valeo

439505/437474

TG9S011 105 6V
14 Ø 55,39 INC

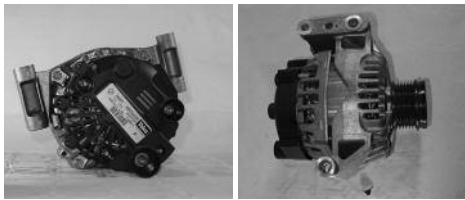

B+(M8)D+(M5)

- FRONT BEARING 21 593563
- REAR BEARING 22 593564
- PROTECTION COVER 24 593892
- SEP:SEPARATED REGULATOR -INC:BUILT-IN REGULATOR 02 593890
- RECTIFIER OR DIODE BRIDGE ASSEMBLY 07 593859
- FRONT HOUSING 31 593862
- PULLEY FREE WEEL + CAP PROTECTION 11c 593860
- ROTOR 04 *595390
- STATOR 05 593927

Valeo

439539/437533

TG9S015 90 6V
14 Ø 55,5 INC

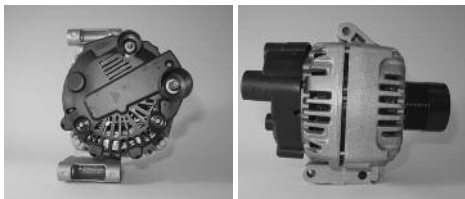

B+(M8)D+(M5)

- FRONT BEARING 21 593563
- REAR BEARING 22 593564
- PROTECTION COVER 24 593892
- SEP:SEPARATED REGULATOR -INC:BUILT-IN REGULATOR 02 593890
- RECTIFIER OR DIODE BRIDGE ASSEMBLY 07 593859
- FRONT HOUSING 31 593862
- PULLEY FREE WEEL + CAP PROTECTION 11c 593860
- ROTOR 04 *595390
- STATOR 05 593864

Valeo

439524/437504

TG9S021 90 6V RL
14 Ø 55,39 INC

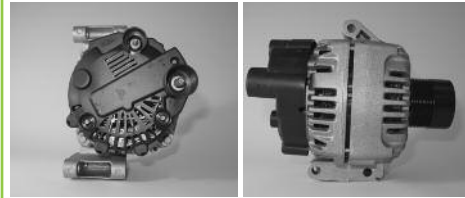

B+(M8)D+(M5)

- FRONT BEARING 21 593563
- REAR BEARING 22 593564
- PROTECTION COVER 24 593892
- SEP:SEPARATED REGULATOR -INC:BUILT-IN REGULATOR 02 593890
- RECTIFIER OR DIODE BRIDGE ASSEMBLY 07 593859
- FRONT HOUSING 31 593862
- PULLEY FREE WEEL + CAP PROTECTION 11c *599223
- ROTOR 04 *595390
- STATOR 05 593864

Valeo

439524/437504

TG9S022 90 6V RL
14 Ø 55,5 INC

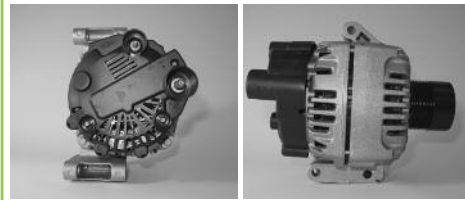

B+(M8)D+(M5)

- FRONT BEARING 21 593563
- REAR BEARING 22 593564
- PROTECTION COVER 24 593892
- SEP:SEPARATED REGULATOR -INC:BUILT-IN REGULATOR 02 593890
- RECTIFIER OR DIODE BRIDGE ASSEMBLY 07 593859
- FRONT HOUSING 31 593862
- PULLEY FREE WEEL + CAP PROTECTION 11c *599223
- ROTOR 04 *595390
- STATOR 05 593864

Valeo

439524/437504

TG9S027 115 6V
14 Ø 54,12 INC



B+(M8)D+(M5)

- FRONT BEARING 21 593563
- REAR BEARING 22 593564
- PROTECTION COVER 24 593892
- SEP:SEPARATED REGULATOR -INC:BUILT-IN REGULATOR 02 593890
- RECTIFIER OR DIODE BRIDGE ASSEMBLY 07 593859
- FRONT HOUSING 31 593862
- PULLEY FREE WEEL + CAP PROTECTION 11c *599223
- ROTOR 04 *595390
- STATOR 05 593927

Valeo

439615/440151



TG9S036

90

6V RL

14



Ø 55,39

INC

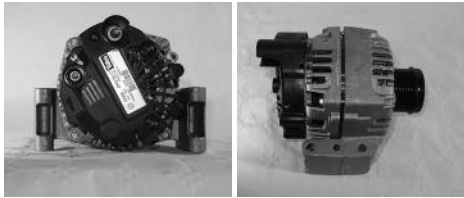
**B+(M8)D+(M5)**

FRONT BEARING	593563
REAR BEARING	593564
PROTECTION COVER	593892
SEP:SEPARATED REGULATOR -INC:BUILT-IN REGULATOR	*595389
RECTIFIER OR DIODE BRIDGE ASSEMBLY	593859
FRONT HOUSING	593862
PULLEY FREE WEEL + CAP PROTECTION	593860
ROTOR	*595390
STATOR	593864

Valeo**439505/437474****TG9S037**

90

6V

14



Ø 55

INC

Picture not available
Image non disponible
Imagen no disponible
Imagine non disponibile
Nicht verfügbares Bild
Brak zdjęcia
Картина недоступна

Picture not available
Image non disponible
Imagen no disponible
Imagine non disponibile
Nicht verfügbares Bild
Brak zdjęcia
Картина недоступна

B+(M8)D+(M5)

FRONT BEARING	593563
REAR BEARING	593564
PROTECTION COVER	593892
SEP:SEPARATED REGULATOR -INC:BUILT-IN REGULATOR	*595389
RECTIFIER OR DIODE BRIDGE ASSEMBLY	593859
FRONT HOUSING	593862
PULLEY	593865
ROTOR	*595390
STATOR	593864

Valeo**439654/440239****TG9S038**

90

6V RL

14



Ø 55,5

INC

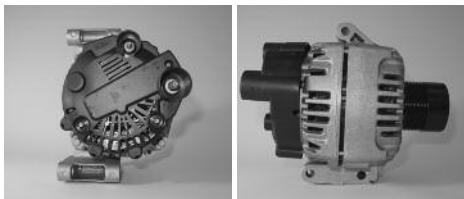
**B+(M8)D+(M5)**

FRONT BEARING	593563
REAR BEARING	593564
PROTECTION COVER	593892
SEP:SEPARATED REGULATOR -INC:BUILT-IN REGULATOR	*595389
RECTIFIER OR DIODE BRIDGE ASSEMBLY	593859
FRONT HOUSING	593862
PULLEY FREE WEEL + CAP PROTECTION	*599223
ROTOR	*595390
STATOR	593864

Valeo**439524/437504****TG9S039**

105

6V RL

14



Ø 55,39

INC

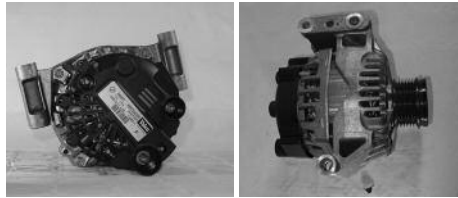
**B+(M8)D+(M5)**

FRONT BEARING	593563
REAR BEARING	593564
PROTECTION COVER	593892
SEP:SEPARATED REGULATOR -INC:BUILT-IN REGULATOR	*595389
RECTIFIER OR DIODE BRIDGE ASSEMBLY	593859
FRONT HOUSING	593862
PULLEY FREE WEEL + CAP PROTECTION	593860
ROTOR	*595390
STATOR	593927

Valeo**439539/437533****TG9S040**

115

6V RL

14



Ø 55,5

INC

Picture not available
Image non disponible
Imagen no disponible
Imagine non disponibile
Nicht verfügbares Bild
Brak zdjęcia
Картина недоступна

Picture not available
Image non disponible
Imagen no disponible
Imagine non disponibile
Nicht verfügbares Bild
Brak zdjęcia
Картина недоступна

B+(M8)D+(M5)

FRONT BEARING	593563
REAR BEARING	593564
PROTECTION COVER	593892
SEP:SEPARATED REGULATOR -INC:BUILT-IN REGULATOR	*595389
RECTIFIER OR DIODE BRIDGE ASSEMBLY	593859
FRONT HOUSING	593862
PULLEY FREE WEEL + CAP PROTECTION	*599223
ROTOR	*595390
STATOR	593927

Valeo**439615/440151****TG9S060**

105

3

6V

14



Ø 54

Picture not available
Image non disponible
Imagen no disponible
Imagine non disponibile
Nicht verfügbares Bild
Brak zdjęcia
Картина недоступна

Picture not available
Image non disponible
Imagen no disponible
Imagine non disponibile
Nicht verfügbares Bild
Brak zdjęcia
Картина недоступна

FRONT BEARING	593563
REAR BEARING	593564
PROTECTION COVER	593892
SEP:SEPARATED REGULATOR -INC:BUILT-IN REGULATOR	*595389
RECTIFIER OR DIODE BRIDGE ASSEMBLY	593859
FRONT HOUSING	593862
PULLEY	593865
ROTOR	*595390
STATOR	*599087

Valeo**439706/440297**

TG9S063

90

6V RL

14



Ø 55,39

INC

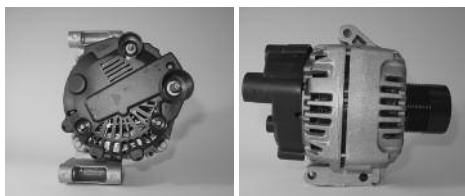
**B+(M8)D+(M5)**

FRONT BEARING 21	593563
REAR BEARING 22	593564
PROTECTION COVER 24	593892
SEP:SEPARATED REGULATOR -INC:BUILT-IN REGULATOR 02	593890
RECTIFIER OR DIODE BRIDGE ASSEMBLY 07	593859
FRONT HOUSING 31	593862
PULLEY FREE WHEEL + CAP PROTECTION 11c	593860
ROTOR 04	*595390
STATOR 05	593864

Valeo**439524/437504****TG9S100**

105

6V

14



Ø 55

Picture not available
Image non disponible
Imagen no disponible
Immagine non disponibile
Nicht verfügbares Bild
Brak zdjęcia
Картина недоступна

Picture not available
Image non disponible
Imagen no disponible
Immagine non disponibile
Nicht verfügbares Bild
Brak zdjęcia
Картина недоступна

FRONT BEARING 21	593563
REAR BEARING 22	593564
SEP:SEPARATED REGULATOR -INC:BUILT-IN REGULATOR 02*	599204
RECTIFIER OR DIODE BRIDGE ASSEMBLY 07	593859
FRONT HOUSING 31	593862
PULLEY 11	593865
ROTOR 04	*595390
STATOR 05	593927

Valeo**439786/440417**

