



Lighting



Electrical  
Components



Workshop  
Consumables

## ACCESSORIES

# Lighting, Electrical Components, & Workshop Consumables 2016/2017



# HC-CARGO Always Online

The products you require are only a few clicks away!

[www.hc-cargo.com](http://www.hc-cargo.com)





# ACCESSORIES

## LIGHTING, ELECTRICAL COMPONENTS, & WORKSHOP CONSUMABLES



For full program overview visit  
[www.hc-cargo.com](http://www.hc-cargo.com)

Edition 2016/2017







This new HC-CARGO Accessories catalogue covers these product groups:



### Lighting

HC-CARGO offers a wide range of bright, long-lasting and economical lighting products for interior and exterior vehicle lighting. They meet the strictest mandatory safety regulations. Regular product testing and supplier audits ensure the quality and durability of HC-CARGO lighting products. The range is continuously extended with innovative products, including LED products:

- Rotating beacons
- Rear multi-function lamps
- Bulbs
- Work lamps
- Reflectors
- LED lamps



### Electrical Components

Electrical components required at the auto electrical workshop or by the specialist who has excelled in building complete electrical systems for the automotive customer:

- CCTV rear observation systems for professional and private use
- Fans and blowers
- Main Switches
- Power management products such as Inverters and Converters  
...and many more electrical related products



### Workshop Consumables

We offer a comprehensive range of the components most commonly used in the automotive workshop.

These include cables, wiring and installation materials specifically for fitting electrical components and accessories.

We also offer a wide range of:

- Universal relays
- Specific relays for diesel applications
- Crimping tools and special tools for the purpose of dismantling and assembling starters and alternators
- Other electrical tools, including multi-meters and trailer connector testers.

In addition to the extended product program, the catalogue provides a new an easy overview of each individual product range.

Moreover, you can also find more precise product information and detailed drawings on a larger number of products than before.

### Other Accessories and Tools

We offer many more parts for your daily business:

Electrical pumps. Horns. Blowers. Ignition switches. Wiper motors. Gauges. Battery isolators. Universal lambda sensors. Parking assistants. Reverse alarms. Glow plugs. Shutdown solenoids. Wiring. Fuses. Relays. Plugs. Sockets. Multifunction testers. Extractors. Switches. Contacts.

PAGE

ACCESSORIES

<u>Acoustic Warning</u> .....	184
Buzzers .....	184
Horns .....	185
Reversing Alarms .....	184
<u>Adhesive</u> .....	520
Cyanoacrylate .....	520
Silicone Compound .....	520
<u>Assembly Parts</u> .....	529
Brass Olives .....	533
Eye Union .....	532
Fork Heads .....	531
Hollow Screws .....	532
Hose Nipples .....	531
Joints .....	530
Pipe Nipples .....	532
Retaining Rings for Shaft and Bores .....	532
Seals & Wire .....	529
Spring Pins .....	533
Valves .....	529
<u>Assortments</u> .....	575
ABS Connectors & Tools .....	575
ATO Blade Fuses .....	574
ATO/Mini/Maxi Fuses .....	584
ATO/Mini/PAL Fuses .....	584
Batteries .....	581
Battery Terminals II .....	582
Blue Crimp Terminals - Insulated .....	577
Butt Splices .....	579
Cable Clips .....	579
Cable Joints .....	578
Cable Lugs .....	586
Cable Ties .....	576
Connectors & Insulators .....	574
Cord End Terminals .....	581
Crimp Seal Terminals .....	578
Crimp Terminals - Non-insulated .....	574
DT Connectors .....	584
DTM Connectors .....	586
Festoon Bulbs .....	172
Fuses - Micro / Mini Low Profile / PAL .....	586
Glow Plugs .....	318
Heat Shrink Pipes I .....	580
Heat Shrink Pipes II .....	585
Hollow Screws & Hose Nipples .....	318
Hose Nipples .....	587
HSS Drills .....	572
Insulated Crimp Terminals .....	583
Insulated Terminals .....	574
Insulated Terminals w/ Tool .....	583
Junior-Timer/Junior-Power-Timer II .....	581
Lock Washer .....	579

PAGE

<u>Assortments</u> .....	575
Machine Screws & Nuts .....	576
Maxi Blade Fuses I .....	584
Maxi Blade Fuses II .....	585
Mega Blade Fuses .....	581
Micro Relays .....	588
Midi Blade Fuses .....	583
Mini Blade Fuses .....	583
Mini Clamps .....	577
Mini Relays 12 V .....	588
Mini Rocker Switches .....	588
PAL Fuses II .....	580
PG Cable Glands .....	582
Pin Terminals - Non-insulated I .....	582
Pin Terminals - Non-insulated II .....	585
Protection Caps .....	578
PVC Caps .....	577
Red Crimp Terminals - Insulated .....	577
Ring Crimp Terminals - Insulated .....	575
Ring Nipples & Hose Sleeves .....	318
Rubber Clamps .....	575
Rubber Grommets & Blankings .....	576
Sealing Rings I .....	575
Single Core Cables .....	580
Strip Fuses .....	582
Strip Fuses - Closed Type .....	585
Super Seal Connectors .....	580
Tapping Screws I .....	579
Thermal Washers .....	318
Thin Wall Cables .....	586
Toggle Switches .....	588
Torpedo & Glass Fuses .....	576
Wedge-base Bulbs 12 V II .....	172
Wedge-base Bulbs 12 V. III .....	172
Wedge-Base Bulbs 12 V. I .....	172
Wedge-Base Bulbs 24 V .....	173
Yellow Crimp Terminals - Insulated .....	578
<u>Bulbs</u> .....	156
Conventional .....	166
Electric Vehicles and Forklifts .....	169
Festoon .....	165
Flash and Penlight .....	169
H1 Halogen .....	156
H2 Halogen .....	156
H3 Halogen .....	156
H4 Halogen .....	157
H6W Halogen .....	158
H7 Halogen .....	158
H8 American Types .....	160
H9 American Types .....	160
H10 American Types .....	160
H11 American Types .....	160
H13 Halogen .....	158

Care is taken to ensure the accuracy of descriptions and applications of each item, but assumes no responsibility for possible errors. O.E.M. names and numbers are used for reference purposes only.  
Printed in Germany. Copyright © 2016 Holger Christiansen A/S, A Bosch Group Company

	PAGE
<u>Bulbs</u> .....	156
H15 Halogen .....	158
H21W Halogen .....	159
H27W/1 American Types .....	160
H27W/2 American Types .....	160
Halogen .....	168
HB1 American Types .....	159
HB3 A American Types .....	159
HB3 American Types .....	159
HB4 A American Types .....	159
HB4 American Types .....	159
HB5 American Types .....	159
High Intensity Discharge .....	161
Instrument Panel .....	167
MH6 Halogen .....	157
Parking and Flasher - Postiion .....	163
Spare Lamp Kits .....	170
Stop and Flasher - Position .....	162
Stop and Tail Lamps .....	161
Wedge Base .....	164
Wedge Base - Covers .....	165
<u>Battery Terminals</u> .....	370
Brass Casting .....	370
For French Applications .....	377
Formpressed .....	376
Leads and Earth Straps .....	377
<u>Beacon Sockets</u> .....	37
Spare Parts .....	39
<u>Bulb Holders</u> .....	149
<u>Cabin Heaters</u> .....	272
Accessories .....	274
Connectors .....	273
Heater Motors .....	273
<u>Cable &amp; Wiring</u> .....	493
Alligator and Universal Clips .....	513
Cable Clips .....	493
Cable Coils .....	514
Cable Eyelets .....	515
Cable Ties .....	495
Cables .....	502
Charging Clips .....	510
Chassis Clips .....	494
Connectors .....	496
End Plug .....	499
Flexible Convoluted Split Tubing .....	497
Flexible Convoluted Tubing .....	497
Glands .....	497
Grommet .....	499
Heat Shrink Tubing .....	500
Ignition .....	515

	PAGE
<u>Cable &amp; Wiring</u> .....	493
Pipe Clips .....	494
Polyurethan Wire Sleeving .....	499
PVC Sleeveings .....	500
Spiral Bindings .....	500
Tie Mount .....	495
Tools .....	501
<u>Camera &amp; Parking Sensors</u> .....	176
CCTV Rear Observation System .....	176
Parking Sensors .....	183
<u>Circuit Breakers</u> .....	431
ATO Blade Fuse Type .....	431
Panel Mount Type .....	431
<u>Clamps</u> .....	518
Ear Clips .....	519
Hose .....	518
Mini .....	518
Tools .....	518
Pipe .....	519
<u>Crimp Terminals</u> .....	320
Insulated .....	320
Non Insulated .....	323
Single Wire Seal .....	335
Terminal Cover .....	336
Tools .....	333
<u>Dashboard Gauges</u> .....	291
Ammeter .....	291
Fuel Gauges .....	292
Hour Meter .....	292
Oil Pressure Gauges .....	293
Voltmeter .....	291
Water Temp. Gauges .....	293
<u>Diesel Parts</u> .....	241
Bearings .....	241
Diesel Pump Parts .....	241
Feed Pumps .....	244
Filter Parts .....	251
Glow Plug Relays .....	259
Glow Plugs .....	257
Governor Parts .....	252
Injection Pipe Holders .....	252
Injection Pipes .....	252
Nozzle Holder Parts .....	254
Nozzles .....	252
Sealing Rings .....	255
Throttle Shafts .....	256
VE Pump Parts .....	256
VE Throttle Shafts .....	256

**ABBREVIATIONS:**

A/C=Air Condition, Alu=Aluminium, Amp=Ampere, AT=Automatic Transmission, Cat.=Catalyzer, Cyl.=Cylinder, CW=Clockwise rotation, Eur.=European application, FWD.=Front Wheel Drive, H=Hight, HD=Heavy Duty construction, HP=Horse Power, ID=Inner Diameter, kW.=Kilowatt, L=Length, LHD=Left Hand Drive, LL.=Lead Length, M=Minimum supply, MT=Manual Transmission, m=Metre, OD=Outer Diameter, OE=Original Equipment, PS=Power Steering, RHD=Right Hand Drive, Th.=Thickness, V=Volt, w/=With, w/o=Without, W.=Width, 4WD.=Four Wheel Drive.

## ACCESSORIES

O. E. M. names and numbers are used for reference purposes only.

**PAGE**

<u>Dry Batteries</u> .....	523
Alkaline .....	523
Battery Charger .....	527
Button .....	525
Carbon-Zink .....	523
Lithium .....	523
Rechargeable .....	526
<u>Fans &amp; Blowers</u> .....	260
Axial Fans .....	266
Blower Resistors .....	263
Blowers .....	260
Fan/Heater Motors .....	264
<u>Fastening Parts</u> .....	558
Bushings .....	569
Cotter Pins .....	569
Flame Arresters .....	565
Hex Screws .....	559
Machine Screws .....	561
Nuts .....	563
Rivets .....	570
Tapping Screws .....	558
Washers .....	566
<u>Filters &amp; Filter Parts</u> .....	236
Fuel Filters .....	236
Fuel Heaters .....	238
Spare Parts .....	238
Water Separator .....	238
<u>Forward Lighting</u> .....	60
Driving Lamp Conventional .....	65
Driving Lamp LED .....	66
Flasher-Position Lamps Conventional .....	71
Flasher-Position Lamps LED .....	72
Fog Lamps .....	64
Headlight Inserts .....	63
LED Daytime Running Light Sets .....	67
Position Lamps Conventional .....	67
Position Lamps LED .....	68
Sealed Beams .....	63
Tractor Head Lamps .....	60
<u>Fuses</u> .....	413
ATO Blade .....	414
Car Radio Fuses .....	413
Compact .....	417
Fuse Boxes .....	419
Fuse Cards .....	418
Fuse Holders .....	421
Glass .....	413
HSB .....	415
Maxi Blade .....	414
Mega .....	414
Micro Blade .....	413
Midi .....	414
Mini Blade .....	414
Mini Blade Low Profile .....	413
PAL 283 .....	416
PAL 293 .....	415

**PAGE**

<u>Fuses</u> .....	413
PAL 2935 .....	415
PAL 2938 .....	415
PAL 294 .....	415
PAL 295 .....	416
PAL JCase .....	416
PAL Low Profile .....	416
Strip .....	416
Tester/Extractors .....	418
Torpedo .....	413
<u>Hand Lamps Conventional</u> .....	147
Spare Parts/Accessories .....	148
<u>Hand Lamps LED</u> .....	148
<u>Hoses</u> .....	
Armoured Plastic .....	516
Heater .....	516
Non-woven .....	515
Overflow .....	516
Plastic .....	515
Polyamid .....	516
Synthetic Rubber Steel Wire .....	516
Vacuum .....	516
Woven .....	515
<u>Ignition Components</u> .....	293
Electronic Kits .....	302
Ignition Coils .....	293
Modules .....	297
<u>Indicator Lights</u> .....	428
LED .....	429
<u>Industrial Battery Connectors</u> .....	380
50 Ampere .....	380
80 Ampere .....	381
100 Ampere .....	381
160 Ampere .....	381
175 Ampere .....	382
250 Ampere .....	383
300 Ampere .....	384
320 Ampere .....	384
350 Ampere .....	384
<u>Interior Lamps Conventional</u> .....	129
<u>Interior Lamps Fluorescent</u> .....	134
Spare Parts .....	135
<u>Interior Lamps LED</u> .....	129
<u>Junction Boxes</u> .....	489
Accessories .....	491
<u>Multiple Connectors</u> .....	337
3 Pole .....	366
4 Pole .....	366
Cables .....	367
Deutsch-Connector Accessories .....	355
Deutsch-Connector DT .....	343
Deutsch-Connector DTM .....	348
Deutsch-Connector DTP .....	354
Deutsch-Connector HD .....	356



	PAGE
<u>Multiple Connectors</u> .....	337
Deutsch-Connector HDP .....	356
Holders .....	339
Insulators .....	337
Junior-Power-Timer Accessories .....	363
Junior-Power-Timer Connector .....	361
Junior-Timer Connector .....	360
Power .....	366
Superseal .....	357
Tools .....	363
<u>Oil &amp; Grease</u> .....	521
Bearing Grease .....	521
Heat Transfer Compound .....	522
Multi Purpose Grease .....	522
<u>Pen-/Torch Lights</u> .....	146
Pen-/Torch Lights LED .....	147
Torch Light Conventional .....	146
Torch Light LED .....	146
Torch Light LED/UV .....	146
<u>Pipes</u> .....	517
Connections .....	517
Hose Sleeves .....	517
Nuts .....	517
Straight Connections .....	517
<u>Plugs &amp; Sockets</u> .....	385
Accessories .....	406
Adapters - 12/24 V .....	389
Adapters 12 V .....	389
Adapters 24 V .....	391
Cable kits 12 V .....	403
DIN and Cigarette Lighter .....	385
Distributor Box .....	392
NATO Cable Connectors .....	407
Trailer Coils 12 V .....	403
Trailer Coils 24 V .....	404
Trailer Plugs - 6/24 V .....	402
Trailer Plugs - 12 V .....	398
Trailer Plugs - 24 V .....	400
Trailer Sockets - 12 V .....	392
Trailer Sockets - 24 V .....	395
<u>Power Management Components</u> .....	189
Battery Isolators .....	202
Chargers .....	201
Load Resistors .....	200
Power Guard .....	202
Relay Boxes .....	192
Voltage Converters .....	189
Voltage Inverters .....	193
Voltage Reducer .....	200
<u>Power-Bloks</u> .....	464
Accessories .....	467
Bridge .....	467
<u>Protecting Caps, Tubes &amp; Plugs</u> .....	
Protecting Caps .....	528
Protecting Plugs .....	528

	PAGE
<u>Protecting Caps, Tubes &amp; Plugs</u> .....	
Protecting Tubes .....	528
Rubber Boots .....	528
<u>Pumps &amp; Pump Parts</u> .....	225
Electrical Bilge Pumps .....	225
Electrical Fluid Pumps .....	228
Electrical Fuel Pumps .....	230
Electrical Fuel Pumps .....	230
Electrical Water Pumps .....	226
Fuel Injection Pumps .....	235
<u>Radio Accessories</u> .....	288
Aerials .....	288
Capacitors .....	290
Loudspeaker Built-in .....	291
Loudspeaker in Cabinet .....	290
Radio Mounting Kits .....	291
<u>Reflectors</u> .....	135
Accessories .....	138
Container Marking .....	144
Hazard Warning Lights .....	145
Miscellaneous Rear Marking .....	138
Rear Marking Trailers .....	140
Rear Marking Trucks .....	141
Triangles .....	144
Warning Triangles .....	144
<u>Relays</u> .....	432
Acoustic Warning .....	432
Boxes .....	464
Change Over - 12 V .....	443
Change Over - 24 V .....	445
Charge Relays .....	456
Daytime Running Lights .....	432
Flasher Units - 6 V .....	451
Flasher Units - 12 V .....	451
Flasher Units - 24 V .....	455
Flip Flop .....	446
Fuel Pumps .....	449
Glow Plug Relays .....	457
Hazard Warning Light System .....	451
Multi Plugs .....	462
Multitimer .....	448
Radiator Fans .....	448
Time Delay - 12 V .....	447
Time Delay - 24 V .....	447
Timing Devices .....	448
Trailer Switch Boxes .....	464
Work Relays .....	433
<u>Side Indicators Conventional</u> .....	72
Spare Parts .....	73
<u>Side Indicators LED</u> .....	74
<u>Side Marker Lamps Conventional</u> .....	74
Spare Parts .....	74
<u>Side Marker Lamps LED</u> .....	75
Accessories .....	76

## ACCESSORIES

O. E. M. names and numbers are used for reference purposes only.

**PAGE**

<u>Solenoids</u> .....	215
Advance Solenoids .....	222
Solenoid Shutdown .....	217
Solenoid Shutdown-Kits .....	215
Solenoid Stop .....	223
<u>Spot Lights Conventional</u> .....	59
Accessories .....	59
<u>Spot Lights LED</u> .....	60
<u>Surface Cleaning</u> .....	521
Abrasive Cloths .....	521
<u>Switches</u> .....	204, 468
Battery Switches .....	204
Control Boxes .....	211
Diesel Starter .....	213
Door & Burglar Alarm .....	487
Emergency Stop Switches .....	211
Ignition Starter .....	212
Ignition/Light .....	212
Mini Rocker .....	468
Multi Purpose .....	486
Push Button .....	483
Push-Pull .....	482
Push-Push .....	484
Rocker .....	470
Rotating .....	468
Spare Parts .....	214
Toggle .....	478
<u>Switches &amp; Sensors - Engine Management</u> .....	302
Sensors .....	311
Switches .....	302
Thermo Sensor Switches .....	309
<u>Tail Lights</u> .....	78
Multi Function Lamps .....	81
Numberplate Lamps Conventional .....	122
Numberplate Lamps LED .....	123
Rear Fog Lamps Conventional .....	79
Rear Fog Lamps LED .....	80
Reversing Lamps Conventional .....	78
Reversing Lamps LED .....	78
Tail Lamps Conventional .....	114
Tail Lamps LED .....	114
Tail Position Lamps Conventional .....	116
Tail Position Lamps LED .....	118
Tail-Lift Lamps Conventional .....	125
Tail-Lift Lamps LED .....	125
Trailer Lighting Sets .....	126
<u>Tapes</u> .....	519
Field Coil Tape .....	519
Insulation Tape .....	519
Masking .....	520
Textile Tape .....	519
Thread Seal Tape .....	520
<u>Tools</u> .....	533
A/C Parts .....	556
Adjustment Tools .....	546

**PAGE**

<u>Tools</u> .....	533
Bits 1/4" .....	557
Bits 5/16" .....	558
Combi Tools .....	539
Dies and Taps .....	539
Drive Tools .....	546
Hose Clamp Screwdrivers .....	539
HSS Drills .....	533
Lambda Sensor Tool .....	544
Protecting Masks .....	538
Remove/Install .....	544
Safety Glasses .....	538
Soldering .....	534
Solenoid Coil .....	546
Solenoid Tools .....	545
Special Tools .....	547
Test Injection Pipes .....	546
Threaded Inserts .....	538
Work Gloves .....	537
Works and Test Equipment .....	548
<u>Warning Lights</u> .....	10
Flash Lights LED .....	24
Light Bars Conventional .....	31
Light Bars LED .....	32
Rotating Beacons Conventional .....	10
Rotating Beacons LED .....	16
Rotating Beacons Xenon .....	21
<u>Wiper Systems</u> .....	274
Windscreen Washers .....	283
Wiper Arms .....	276
Wiper Blades .....	274
Wiper Motors .....	278
<u>Work Lamps Conventional</u> .....	40
<u>Work Lamps HID</u> .....	57
Spare Parts .....	58
<u>Work Lamps LED</u> .....	45
Accessories .....	54
Work Light Bars LED .....	55
<u>Cross Reference List</u> .....	589
<u>Index</u> .....	633



# Lighting

Edition 2016/2017

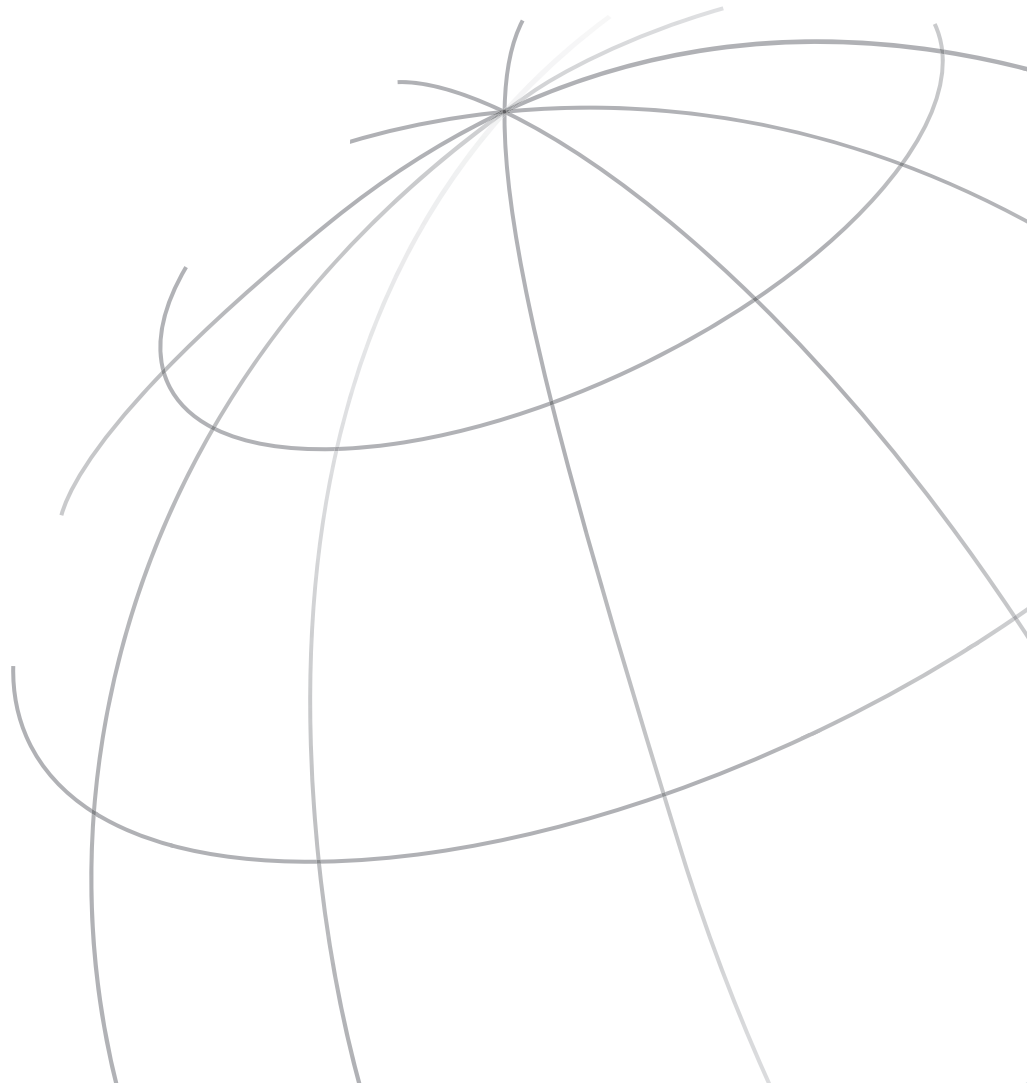

## WARNING LIGHTS

### ROTATING BEACONS CONVENTIONAL

#### 170295 Rotating Beacon Std pkg 1

Dome: HC-CARGO 170308, 170366. Motor: HC-CARGO 170505. Base Plate: HC-CARGO 170309.

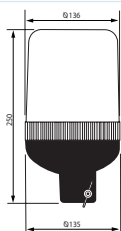

Bulb incl.: Yes  
Voltage: 12

OD: 136 mm  
Height: 250 mm

Bulb type: H1  
Lens type: PMMA/ACRYL  
Colour: Orange  
Model: AEB TYPE 590  
Mount.: Standard ISO A - Rod  
E-approval: Yes  
Alternativ no. 171399

#### 170296 Rotating Beacon Std pkg 1

Dome: HC-CARGO 170308, 170366. Motor: HC-CARGO 170506. Base Plate: HC-CARGO 170309.

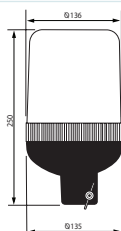

Bulb incl.: Yes  
Voltage: 24

OD: 136 mm  
Height: 250 mm

Bulb type: H1  
Lens type: PMMA/ACRYL  
Colour: Orange  
Model: AEB TYPE 590  
Mount.: Standard ISO A - Rod  
E-approval: Yes  
Alternativ no. 171399

#### 170435 Rotating Beacon Std pkg 1

Dome: HC-CARGO 170308, 170366. Motor: HC-CARGO 170505. Base Plate: HC-CARGO 170309.

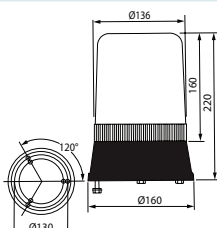

Bulb incl.: Yes  
Voltage: 12

OD: 160 mm  
Height: 220 mm

Bulb type: H1  
Lens type: PMMA/ACRYL  
Colour: Orange  
Model: AEB TYPE 595  
Mount.: Standard ISO B2 (and B1) - Base  
E-approval: Yes

#### 170436 Rotating Beacon Std pkg 1

Dome: HC-CARGO 170308, 170366. Motor: HC-CARGO 170506. Base Plate: HC-CARGO 170309.

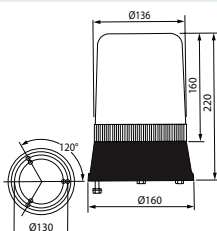

Bulb incl.: Yes  
Voltage: 24

OD: 160 mm  
Height: 220 mm

Bulb type: H1  
Lens type: PMMA/ACRYL  
Colour: Orange  
Model: AEB TYPE 595  
Mount.: Standard ISO B2 (and B1) - Base  
E-approval: Yes

#### 170437 Rotating Beacon Std pkg 1

Dome: HC-CARGO 170308, 170366. Motor: HC-CARGO 170505. Base Plate: HC-CARGO 170309. Coil cable: length 2 m.

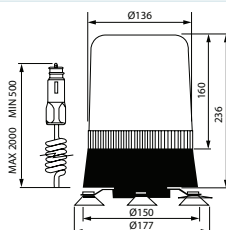

Bulb incl.: Yes  
Voltage: 12

OD: 177 mm  
Height: 236 mm

Bulb type: H1  
Lens type: PMMA/ACRYL  
Colour: Orange  
Model: AEB TYPE 595 M  
Mount.: 3 magnets  
Base: Magnetic  
Coiled cable incl.: Yes  
E-approval: Yes

#### 170438 Rotating Beacon Std pkg 1



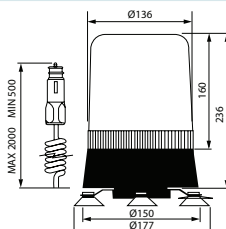





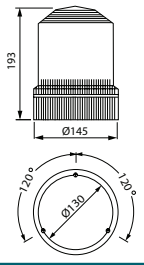

Dome: HC-CARGO 170308, 170366. Motor: HC-CARGO 170505. Base Plate: HC-CARGO 170309. Coil cable: length 2 m.

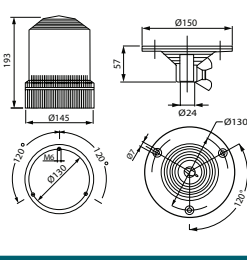

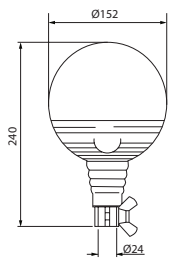
Bulb incl.: Yes  
Voltage: 24

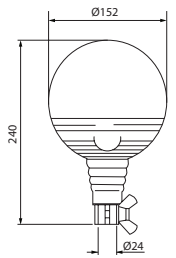
OD: 177 mm  
Height: 236 mm

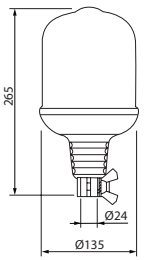
Bulb type: H1  
Lens type: PMMA/ACRYL  
Colour: Orange  
Model: AEB TYPE 595 M  
Mount.: 3 magnets  
Base: Magnetic  
Coiled cable incl.: Yes  
E-approval: Yes

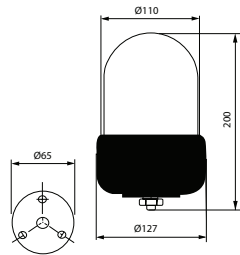
170490 Rotating Beacon		Std pkg 1			
Dome: HC-CARGO 170492. Beacon Socket: HC-CARGO 170525. Base Plate: HC-CARGO 170528.					
		Bulb incl.: No Voltage: 12/24	OD: 145 mm Height: 193 mm	Bulb type: H1 Lens type: PMMA/ACRYL Colour: Orange Model: TYPE FT 6 Mount.: Standard ISO B2 (and B1) - Base Tightness norm: IP 55 E-approval: Yes	
170491 Rotating Beacon		Std pkg 1			
Dome: HC-CARGO 170492. Base Plate: HC-CARGO 170528.					
		Bulb incl.: No Voltage: 12/24	OD: 150 mm Height: 250 mm	Bulb type: H1 Lens type: PMMA/ACRYL Colour: Orange Model: TYPE FT 6 Mount.: Standard ISO-DIN A or B fixing Base: Rigid Tightness norm: IP 55 E-approval: Yes	
170540 Rotating Beacon		Std pkg 1			
Dome: HC-CARGO 170543.					
		Bulb incl.: Yes Voltage: 12	OD: 152 mm Height: 240 mm	Bulb type: H1 Lens type: Polycarbonate Colour: Orange Model: Boule Mount.: Standard ISO A - Rod Base: Flexible Hi impact: Yes Waterproof: Yes Tightness norm: IP 66 E-approval: Yes	
170541 Rotating Beacon		Std pkg 1			
Dome: HC-CARGO 170543.					
		Bulb incl.: Yes Voltage: 24	OD: 152 mm Height: 240 mm	Bulb type: H1 Lens type: Polycarbonate Colour: Orange Model: Boule Mount.: Rod (ISO-DIN A) Base: Flexible Hi impact: Yes Tightness norm: IP 66 E-approval: Yes	
170551 Rotating Beacon		Std pkg 1			
		Bulb incl.: Yes Voltage: 12	OD: 135 mm Height: 265 mm	Bulb type: H1 Lens type: Polycarbonate Colour: Orange Model: TYPE GF 8.8 FLX Mount.: Standard ISO A - Rod Base: Flexible Hi impact: Yes Tightness norm: IP 54 E-approval: Yes	
170598 Rotating Beacon		Std pkg 1			
Dome: HC-CARGO 170691.					
		Bulb incl.: No Voltage: 12/24	OD: 127 mm Height: 200 mm	Bulb type: H1 Lens type: PMMA/ACRYL Colour: Orange Model: AEB TYPE 525 Mount.: Single bolt E-approval: Yes	

**170599 Rotating Beacon**

Std pkg 1

Dome: HC-CARGO 170691.

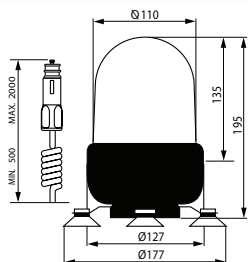

 Bulb incl.: No  
Voltage: 12/24

 OD: 127 mm  
Cable length: 2000 mm  
Height: 195 mm

 Bulb type: H1  
Lens type: PMMA/ACRYL  
Colour: Orange  
Model: AEB TYPE 525 M  
Mount.: 3 magnets  
Base: Magnetic  
Coiled cable incl.: Yes  
E-approval: Yes

**170601 Rotating Beacon**

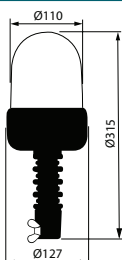
Std pkg 1

 Bulb incl.: No  
Voltage: 12/24

 OD: 127 mm  
Height: 315 mm

 Bulb type: H1  
Lens type: Polycarbonate  
Colour: Orange  
Model: AEB TYPE 530 B  
Mount.: Standard ISO A - Rod  
Base: Flexible  
Hi impact: Yes  
E-approval: Yes

**170798 Rotating Beacon**

Std pkg 1

Dome: HC-CARGO 170308, 170366. Motor: HC-CARGO 170505, 170506. Base Plate: HC-CARGO 170309.

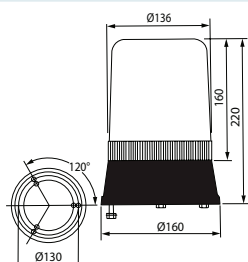
 Bulb incl.: No  
Voltage: 12/24

 OD: 160 mm  
Height: 220 mm

 Bulb type: H1  
Lens type: PMMA/ACRYL  
Colour: Blue  
Model: AEB TYPE 595  
Mount.: Standard ISO B2 (and B1) - Base  
E-approval: Yes

**170830 Rotating Beacon**

Std pkg 1

Dome: HC-CARGO 170945.

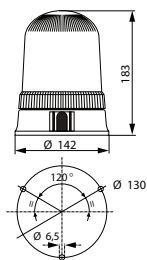

 Bulb incl.: No  
Voltage: 12/24

 OD: 142 mm  
Height: 183 mm

 Bulb type: H1  
Lens type: PMMA/ACRYL  
Colour: Orange  
Mount.: Standard ISO B2 (and B1) - Base  
E-approval: Yes

**171019 Rotating Beacon**

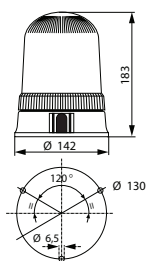
Std pkg 1



 Bulb incl.: No  
Voltage: 12/24

 OD: 142 mm  
Height: 183 mm

 Bulb type: H1  
Lens type: PMMA/ACRYL  
Colour: Blue  
Model: Astral  
Mount.: Standard ISO B2 (and B1) - Base  
E-approval: Yes



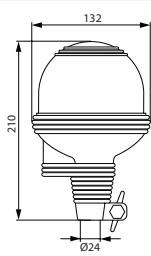





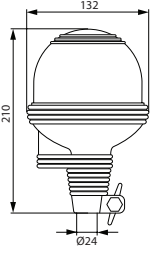

**171060 Rotating Beacon**

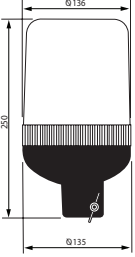
Std pkg 1

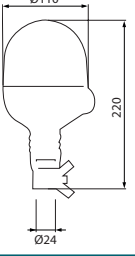
 Bulb incl.: Yes  
Voltage: 12

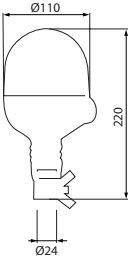
 OD: 132 mm  
Height: 210 mm

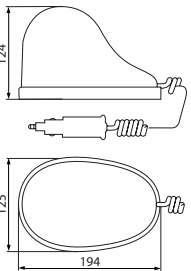
 Bulb type: H1  
Lens type: Polycarbonate  
Colour: Orange  
Model: Megalux  
Mount.: Standard ISO A - Rod  
Base: Flexible  
Hi impact: Yes  
E-approval: Yes

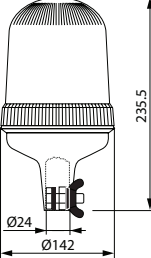
		EL. SPECIFICATIONS	DIMENSIONS	ADDITIONAL SPECIFICATIONS
<b>171061 Rotating Beacon</b> Std pkg 1				
		Bulb incl.: Yes Voltage: 24	OD: 132 mm Height: 210 mm	Bulb type: H1 Lens type: Polycarbonate Colour: Orange Model: Megalux Mount.: Standard ISO A - Rod Base: Flexible Hi impact: Yes E-approval: Yes
<b>171399 Rotating Beacon</b> Std pkg 1				
<i>Dome: HC-CARGO 170308, 170366. Motor: HC-CARGO 170505, 170506. Base Plate: HC-CARGO 170309.</i>				
		Bulb incl.: No Voltage: 12/24	OD: 136 mm Height: 250 mm	Bulb type: H1 Lens type: PMMA/ACRYL Colour: Orange Model: 590 DVO Mount.: Standard ISO A - Rod E-approval: Yes
<b>171423 Rotating Beacon</b> Std pkg 1				
		Bulb incl.: Yes Voltage: 12 Watt: 55	OD: 110 mm Height: 220 mm	Bulb type: H1 Lens type: Polycarbonate Colour: Orange Model: Microboule Mount.: Standard ISO A - Rod Base: Flexible Hi impact: Yes Tightness norm: IP 55 Approvals: CE E-approval: Yes
<b>171424 Rotating Beacon</b> Std pkg 1				
		Bulb incl.: Yes Voltage: 24 Watt: 55	OD: 110 mm Height: 220 mm	Bulb type: H1 Lens type: Polycarbonate Colour: Orange Model: Microboule Mount.: Rod (ISO-DIN A) Base: Flexible Hi impact: Yes Tightness norm: IP 55 Approvals: CE E-approval: Yes
<b>171494 Rotating Beacon</b> Std pkg 1				
<i>Tested for 200 kmh. Dome: HC-CARGO 171512. 2 mtr. coiled cable. Rubber base. Coiled Cable: HC-CARGO 171562.</i>				
		Bulb incl.: Yes Voltage: 12	OD: 125x194 mm Length: 194 mm Height: 124 mm	Bulb type: H1 Lens type: Polycarbonate Colour: Orange Model: GDO Mount.: 1 magnet Base: Magnetic Hi impact: Yes Coiled cable incl.: Yes Tightness norm: IP 55 E-approval: Yes
<b>171577 Rotating Beacon</b> Std pkg 1				
<i>Dome: HC-CARGO 170945.</i>				
		Bulb incl.: Yes Voltage: 12	OD: 142 mm Height: 235.5 mm	Bulb type: H1 Colour: Orange Model: Astral Mount.: Standard ISO A - Rod Base: Rigid E-approval: Yes

## ACCESSORIES - Lighting

O.E.M. names and numbers are used for reference purposes only.

**171587 Rotating Beacon** Std pkg 1

Dome: HC-CARGO 170945.

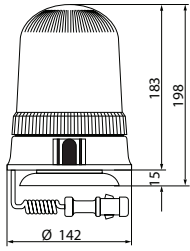

Bulb incl.: No  
Voltage: 12/24

OD: 142 mm  
Height: 198 mm

Bulb type: H1  
Colour: Orange  
Model: Astral  
Mount.: 1 magnet  
Coiled cable incl.: Yes  
E-approval: Yes

**171588 Rotating Beacon** Std pkg 1

Dome: HC-CARGO 170945.

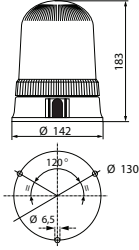

Bulb incl.: No  
Voltage: 12/24

OD: 142 mm  
Height: 183 mm

Bulb type: H1  
Colour: Orange  
Model: Astral  
Mount.: Single bolt  
E-approval: Yes

**171705 Rotating Beacon** Std pkg 1

Dome: HC-CARGO 170308. Motor: HC-CARGO 170505, 170506.

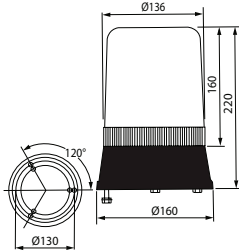

Bulb incl.: No  
Voltage: 12/24

OD: 160 mm  
Height: 220 mm

Bulb type: H1  
Lens type: PMMA/ACRYL  
Colour: Orange  
Model: AEB TYPE 595  
Mount.: Plan (ISO-DIN B)  
E-approval: Yes

**171793 Rotating Beacon** Std pkg 1

Dome: HC-CARGO 170945.

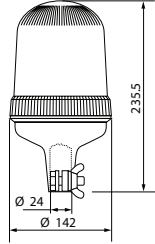

Bulb incl.: No  
Voltage: 12/24

OD: 142 mm  
Height: 235.5 mm

Bulb type: H1  
Lens type: Polycarbonate  
Colour: Orange  
Model: Astral flex  
Mount.: Standard ISO A - Rod  
Base: Flexible  
Hi impact: Yes  
E-approval: Yes

**SPARE PARTS**

**170308 Dome** Std pkg 1 Servicing: HC-CARGO 170295, 170296, 170435, 170436, 170437, 170438, 170798, 171399, 171705

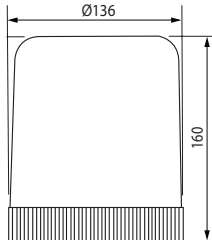

OD: 136 mm  
Height: 160 mm

Lens type: PMMA/ACRYL  
Colour: Orange  
Model: TYPE 590/595/595M

**170309 Base Plate** Std pkg 1 Servicing: HC-CARGO 170295, 170296, 170435, 170436, 170437, 170438, 170798, 171399

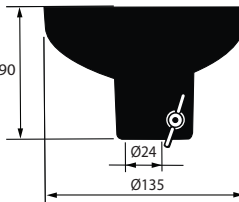

OD: 135 mm  
Height: 90 mm

Model: TYPE 590/595/595M









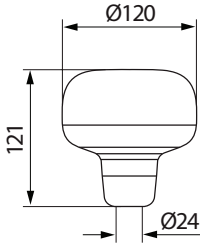

EL. SPECIFICATIONS		DIMENSIONS	ADDITIONAL SPECIFICATIONS
<b>170366 Dome</b> Std pkg 1 Servicing: HC-CARGO 170295, 170296, 170435, 170436, 170437, 170438, 170798, 171399			OD: 136 mm Height: 160 mm Lens type: PMMA/ACRYL Colour: Blue Model: TYPE 590/595/595M
<b>170492 Dome</b> Std pkg 1 Servicing: HC-CARGO 170490, 170491			OD: 134 mm Height: 151 mm Lens type: PMMA/ACRYL Colour: Orange Model: TYPE FT 6 Hi impact: No
<b>170505 Beacon Motor</b> Std pkg 1 Servicing: HC-CARGO 170295, 170435, 170437, 170438, 170798, 171399, 171705			Voltage: 12 Height: 65 mm Width: 30 mm Model: TYPE 590/595/595M
<b>170506 Beacon Motor</b> Std pkg 1 Servicing: HC-CARGO 170296, 170436, 170798, 171399, 171705			Voltage: 24 Height: 65 mm Width: 30 mm Model: TYPE 590/595/595M
<b>170528 Base Plate</b> Std pkg 1 Servicing: HC-CARGO 170491, 170490, 170650, 170651, 171498, 170680			OD: 150 mm Height: 58 mm Model: TYPE FT 6 Mount.: Standard ISO A - Rod
<b>170543 Dome</b> Std pkg 1 Servicing: HC-CARGO 170540, 170541			OD: 152.5 mm Height: 120.5 mm Lens type: Polycarbonate Colour: Orange Model: Boule Hi impact: Yes
<b>170945 Dome</b> Std pkg 1 Servicing: HC-CARGO 170830, 171019, 171577, 171587, 171588, 171793, 172027, 172028, 172029, 172030, 172075			OD: 127 mm Height: 148 mm Lens type: PMMA/ACRYL Colour: Orange Model: Astral E-approval: Yes Alternativ no. 171463

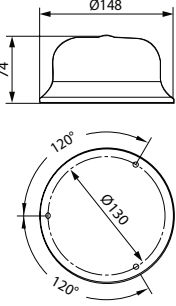
## ACCESSORIES - Lighting

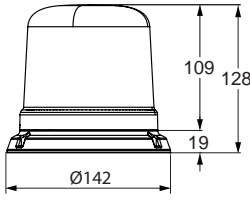
O.E.M. names and numbers are used for reference purposes only.

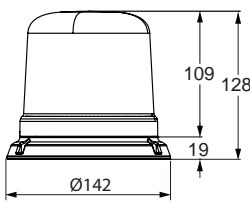
		EL. SPECIFICATIONS	DIMENSIONS	ADDITIONAL SPECIFICATIONS
<b>171518</b> Coiled Cable		Std pkg 1	Servicing: HC-CARGO 170292, 170387, 170405, 170788, 170406, 170562, 170789, 170537, 171576, 170419, 170460	
			Working length: 2 m	Plug type: Cigar plug Plug: 2 ISO norm: 4165
<b>171562</b> Coiled Cable		Std pkg 1	Servicing: HC-CARGO 171494, 171495	
			Working length: 3 m	Plug type: Cigar plug
<b>172110</b> Dome		Std pkg 1	Servicing: HC-CARGO 172099, 172100, 172101	
			OD: 140 mm	Lens type: PMMA/ACRYL Colour: Orange E-approval: Yes
<b>ACCESSORIES</b>				
<b>170525</b> Beacon Socket		Std pkg 1	Servicing: HC-CARGO 170490, 171017	
			Cable length: 2000 mm Height: 28 mm Width: 147 mm	Model: TYPE FT 6 Mount.: 3 magnets Base: Magnetic Coiled cable incl.: Yes Tightness norm: IP 55
<b>ROTATING BEACONS LED</b>				
<b>171673</b> LED Beacon		Std pkg 1		
		Voltage: 11-110 Amp: 0.7 Watt: 6	OD: 98 mm Length: 98 mm Cable length: 300 mm Height: 130 mm Width: 72 mm	Bulb type: 6 LED Lens type: Polycarbonate Flash rate: 45 min. Colour: Orange Mount.: Plan Hi impact: Yes Coiled cable incl.: No Waterproof: Yes Tightness norm: IP 66 Approvals: SAE/CE E-approval: No
<b>171674</b> LED Beacon		Std pkg 1		
		Voltage: 11-110 Amp: 0.7 Watt: 6	OD: 130 mm Length: 130 mm Cable length: 300 mm Height: 98 mm Width: 86 mm	Bulb type: 6 LED Lens type: Polycarbonate Flash rate: 45 min. Colour: Orange Mount.: Plan Hi impact: Yes Coiled cable incl.: No Waterproof: Yes Tightness norm: IP 66 Approvals: SAE/CE E-approval: No

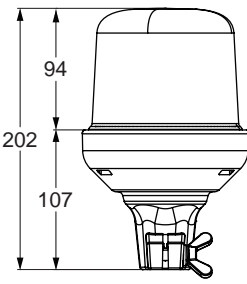
		EL. SPECIFICATIONS	DIMENSIONS	ADDITIONAL SPECIFICATIONS
<b>171763 LED Beacon</b> Std pkg 1  		Voltage: 12/24 Amp: 1.7/0.8	OD: 120 mm Height: 121 mm	Bulb type: LED Lens type: Polycarbonate Flash rate: 130 min. Colour: Orange Material: Aluminium Mount.: Standard ISO A - Rod Base: Rigid Flash patterns: 2 Hi impact: Yes Waterproof: Yes Tightness norm: IP 66 Approvals: ECE-R65 E-approval: Yes
<b>171764 LED Beacon</b> Std pkg 1  		Voltage: 12/24 Amp: 1.7/0.8	OD: 148 mm Height: 74 mm Dist. mount. holes: 130 mm	Bulb type: LED Lens type: Polycarbonate Flash rate: 130 min. Colour: Orange Material: Aluminium Mount.: Plan Flash patterns: 2 Hi impact: Yes Waterproof: Yes Tightness norm: IP 66 Approvals: ECE-R65 E-approval: Yes
<b>171918 LED Beacon</b> Std pkg 1 Dome: HC-CARGO 171941.  		Voltage: 12-24 Amp: 1.2/2.9 Watt: 37	OD: 142 mm Cable length: 400 mm Height: 128 mm	Bulb type: 10 LED Lens type: Polycarbonate Colour: Orange Material: Aluminium Mount.: Plan Flash patterns: 11 Hi impact: Yes Coiled cable incl.: No Waterproof: Yes Tightness norm: IP 65 Approvals: SAE/ECE-R65 E-approval: Yes
<b>171919 LED Beacon</b> Std pkg 1 Dome: HC-CARGO 171941.  		Voltage: 12-24 Amp: 1.2/2.9 Watt: 37	OD: 142 mm Cable length: 3000 mm Height: 128 mm	Bulb type: 10 LED Lens type: Polycarbonate Colour: Orange Material: Aluminium Mount.: Lighter Socket Base: Magnetic Flash patterns: 11 Hi impact: Yes Waterproof: Yes Tightness norm: IP 65 Approvals: SAE/ECE-R65 E-approval: Yes
<b>171920 LED Beacon</b> Std pkg 1 Dome: HC-CARGO 171941.  		Voltage: 12-24 Amp: 1.2/2.9 Watt: 37	OD: 130 mm Height: 202 mm	Bulb type: 10 LED Lens type: Polycarbonate Colour: Orange Material: Aluminium Mount.: Standard ISO A - Rod Flash patterns: 11 Hi impact: Yes Waterproof: Yes Tightness norm: IP 65 Approvals: SAE/ECE-R65 E-approval: Yes

**171921 LED Beacon** Std pkg 1

Dome: HC-CARGO 171942.

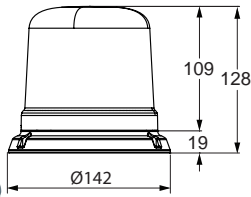

 Voltage: 12-24  
 Amp: 1.2/2.9  
 Watt: 37

 OD: 142 mm  
 Height: 128 mm

 Bulb type: LED  
 Lens type: Polycarbonate  
 Colour: Blue  
 Material: Aluminium  
 Mount.: Plan  
 Flash patterns: 11  
 Hi impact: Yes  
 Coiled cable incl.: No  
 Waterproof: Yes  
 Tightness norm: IP 65  
 Approvals: SAE/ECE-R65  
 E-approval: Yes

**171922 LED Beacon** Std pkg 1

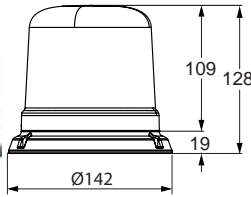
Dome: HC-CARGO 171942.



 Voltage: 12-24  
 Amp: 1.2/2.9  
 Watt: 37

 OD: 142 mm  
 Height: 128 mm

 Bulb type: LED  
 Lens type: Polycarbonate  
 Colour: Blue  
 Material: Aluminium  
 Mount.: 3 magnets  
 Flash patterns: 11  
 Hi impact: Yes  
 Coiled cable incl.: Yes  
 Waterproof: Yes  
 Tightness norm: IP 65  
 Approvals: SAE/ECE-R65  
 E-approval: Yes

**171923 LED Beacon** Std pkg 1

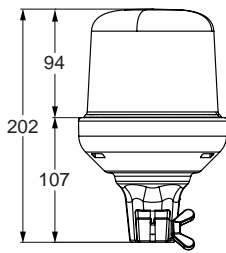
Dome: HC-CARGO 171942.

 Voltage: 12-24  
 Amp: 1.2/2.9  
 Watt: 37

 OD: 130 mm  
 Height: 202 mm

 Bulb type: LED  
 Lens type: Polycarbonate  
 Colour: Blue  
 Material: Aluminium  
 Mount.: Standard ISO A - Rod  
 Flash patterns: 11  
 Hi impact: Yes  
 Waterproof: Yes  
 Tightness norm: IP 65  
 Approvals: SAE/ECE-R65  
 E-approval: Yes

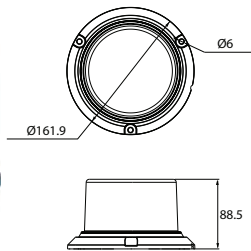
**171931 LED Beacon** Std pkg 1

 Voltage: 12-36  
 Amp: 2.9/1.8  
 Watt: 35/44

 OD: 161.9 mm  
 Cable length: 340 mm  
 Height: 88.5 mm

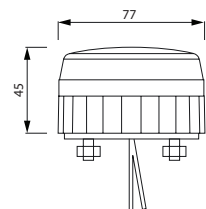
 Bulb type: 12 LED  
 Colour: Orange  
 Mount.: Plan  
 Flash patterns: 5  
 Waterproof: Yes  
 Tightness norm: IP 67  
 Approvals: EMC-R10/ECE-R65  
 E-approval: Yes

**171957 LED Beacon** Std pkg 1

 Voltage: 10-100  
 Amp: 0.1  
 Watt: 1.2



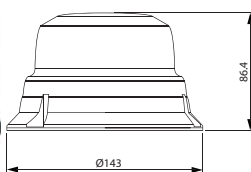





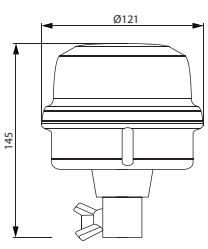

 OD: 77 mm  
 Cable length: 410 mm  
 Height: 45 mm  
 Dist. mount. holes:  
 45 mm

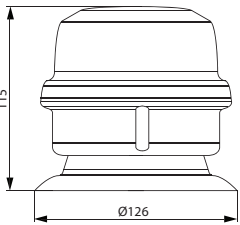
 Bulb type: 12 LED  
 Lens type: Polycarbonate  
 Colour: Orange  
 Material: Polycarbonate  
 Mount.: Plan  
 Flash patterns: 4  
 Hi impact: Yes  
 Tightness norm: IP 67  
 Approvals: CE/EMC  
 E-approval: No

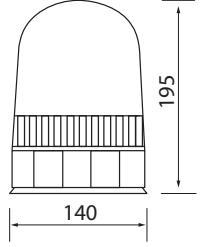
**171971 LED Beacon** Std pkg 1

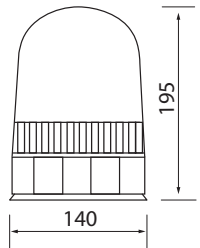
 Voltage: 12-24  
 Amp: 2  
 Watt: 15

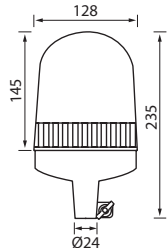
 OD: 143 mm  
 Cable length: 150 mm  
 Height: 86.4 mm

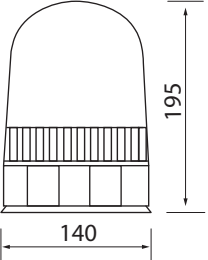
 Bulb type: 8 LED  
 Colour: Orange  
 Material: Polycarbonate  
 Mount.: Plan  
 Flash patterns: 1  
 Tightness norm: IP 66  
 Approvals: CE/EMC/ECE-R65  
 E-approval: Yes

EL. SPECIFICATIONS		DIMENSIONS	ADDITIONAL SPECIFICATIONS
<b>171972 LED Beacon</b> Std pkg 1			
 	<b>Voltage:</b> 12-24 <b>Amp:</b> 2 <b>Watt:</b> 15	<b>OD:</b> 121 mm <b>Height:</b> 143 mm	<b>Bulb type:</b> 6 LED <b>Colour:</b> Orange <b>Material:</b> Polycarbonate <b>Mount.:</b> Standard ISO A - Rod <b>Flash patterns:</b> 1 <b>Hi impact:</b> Yes <b>Tightness norm:</b> IP 66 <b>Approvals:</b> CE/EMC/ECE-R65 <b>E-approval:</b> Yes
<b>171973 LED Beacon</b> Std pkg 1			
 	<b>Voltage:</b> 12-24 <b>Amp:</b> 2 <b>Watt:</b> 15	<b>OD:</b> 126 mm <b>Cable length:</b> 2000 mm <b>Height:</b> 115 mm	<b>Bulb type:</b> 8 LED <b>Colour:</b> Orange <b>Material:</b> Polycarbonate <b>Mount.:</b> Lighter Socket <b>Base:</b> Magnetic/vacuum <b>Flash patterns:</b> 1 <b>Hi impact:</b> Yes <b>Coiled cable incl.:</b> Yes <b>Tightness norm:</b> IP 66 <b>Approvals:</b> CE/EMC/ECE-R65 <b>E-approval:</b> Yes
<b>172027 LED Beacon</b> Std pkg 1			
<i>Dome: HC-CARGO 170945.</i>			
 	<b>Voltage:</b> 10-30 <b>Amp:</b> 1.5 <b>Watt:</b> 18	<b>OD:</b> 140 mm <b>Cable length:</b> 180 mm <b>Height:</b> 195 mm <b>Dist. mount. holes:</b> 107 mm	<b>Bulb type:</b> 80 LED <b>Lens type:</b> Polycarbonate <b>Colour:</b> Orange <b>Material:</b> Plastic/nylon/rubber <b>Mount.:</b> Lighter Socket <b>Base:</b> Magnetic/vacuum <b>Flash patterns:</b> 3 <b>Hi impact:</b> Yes <b>Coiled cable incl.:</b> Yes <b>Tightness norm:</b> IP 65 <b>Approvals:</b> ECE-R65 <b>E-approval:</b> Yes
<b>172028 LED Beacon</b> Std pkg 1			
<i>Dome: HC-CARGO 170945.</i>			
 	<b>Voltage:</b> 10-30 <b>Amp:</b> 1.5 <b>Watt:</b> 18	<b>OD:</b> 140 mm <b>Cable length:</b> 95 mm <b>Height:</b> 195 mm <b>Dist. mount. holes:</b> 107 mm	<b>Bulb type:</b> 80 LED <b>Lens type:</b> Polycarbonate <b>Colour:</b> Orange <b>Material:</b> Plastic/nylon/rubber <b>Mount.:</b> Plan <b>Base:</b> Vacuum <b>Flash patterns:</b> 3 <b>Hi impact:</b> Yes <b>Tightness norm:</b> IP 65 <b>Approvals:</b> ECE-R65 <b>E-approval:</b> Yes
<b>172029 LED Beacon</b> Std pkg 1			
<i>Dome: HC-CARGO 170945.</i>			
 	<b>Voltage:</b> 10-30 <b>Amp:</b> 1.5 <b>Watt:</b> 18	<b>OD:</b> 128 mm <b>Height:</b> 235 mm	<b>Bulb type:</b> 80 LED <b>Lens type:</b> Polycarbonate <b>Colour:</b> Orange <b>Material:</b> Plastic/nylon/rubber <b>Mount.:</b> Standard ISO A - Rod <b>Base:</b> Rigid <b>Flash patterns:</b> 3 <b>Hi impact:</b> Yes <b>Tightness norm:</b> IP 65 <b>Approvals:</b> ECE-R65 <b>E-approval:</b> Yes
<b>172030 LED Beacon</b> Std pkg 1			
<i>Dome: HC-CARGO 170945. w/ battery. For Rotating pattern: 2 hrs, For Triple Flash pattern: 2.5 ~ 3 hrs, For Single Flash pattern: 7-8 hrs.</i>			
 	<b>Voltage:</b> 12 <b>Amp:</b> 1.5 <b>Watt:</b> 18	<b>OD:</b> 140 mm <b>Height:</b> 195 mm <b>Dist. mount. holes:</b> 107 mm	<b>Bulb type:</b> 80 LED <b>Lens type:</b> Polycarbonate <b>Colour:</b> Orange <b>Material:</b> Plastic/nylon/rubber <b>Mount.:</b> Plan <b>Base:</b> Magnetic/vacuum <b>Flash patterns:</b> 3 <b>Hi impact:</b> Yes <b>Wall charger 230 V:</b> Yes <b>Tightness norm:</b> IP 65 <b>Approvals:</b> ECE-R65 <b>E-approval:</b> Yes

**172075 LED Beacon UK Version** Std pkg 1 Servicing: UK - Visit [www.hc-cargo.com](http://www.hc-cargo.com) for further information.

Dome: HC-CARGO 170945. w/ battery.

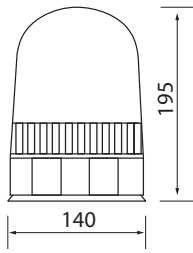

Voltage: 10-30  
Amp: 1.5  
Watt: 18

OD: 140 mm  
Height: 195 mm  
Dist. mount. holes:  
107 mm

Bulb type: 80 LED  
Lens type: Polycarbonate  
Colour: Orange  
Material: Plastic/nylon/rubber  
Mount.: Plan  
Base: Magnetic/vacuum  
Flash patterns: 3  
Hi impact: Yes  
Tightness norm: IP 65  
Approvals: ECE-R65  
E-approval: Yes  
Alternativ no. 172030UK

**172099 LED Beacon** Std pkg 1

Dome: HC-CARGO 172110.

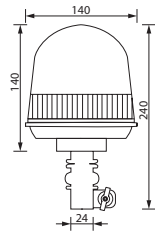

Voltage: 10-30  
Watt: 9

OD: 140 mm  
Height: 240 mm

Bulb type: 40 LED  
Lens type: Polycarbonate  
Colour: Orange  
Material: Plastic/nylon/rubber  
Mount.: Standard ISO A - Rod  
Base: Flexible  
Flash patterns: 3  
Tightness norm: IP 65  
Approvals: ECE-R65  
E-approval: Yes

**172100 LED Beacon** Std pkg 1

Dome: HC-CARGO 172110.

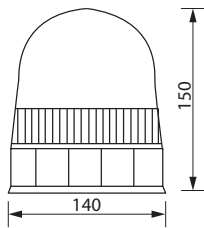

Voltage: 10-30  
Watt: 9

OD: 140 mm  
Height: 150 mm  
Dist. mount. holes:  
107 mm

Bulb type: 40 LED  
Lens type: Polycarbonate  
Colour: Orange  
Material: Plastic/nylon/rubber  
Mount.: Plan  
Flash patterns: 3  
Tightness norm: IP 65  
Approvals: ECE-R65  
E-approval: Yes

**172101 LED Beacon** Std pkg 1

Max. 120 kph. Dome: HC-CARGO 172110.

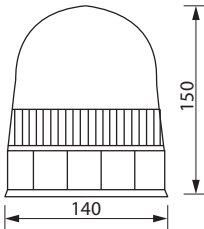

Voltage: 10-30  
Watt: 9

OD: 140 mm  
Height: 150 mm  
Dist. mount. holes:  
107 mm

Bulb type: 40 LED  
Lens type: Polycarbonate  
Colour: Orange  
Material: Plastic/nylon/rubber  
Mount.: Plan  
Base: Magnetic/vacuum  
Flash patterns: 3  
Coiled cable incl.: Yes  
Tightness norm: IP 65  
Approvals: ECE-R65  
E-approval: Yes

**172114 LED Beacon** Std pkg 1

Dome: HC-CARGO 171590.

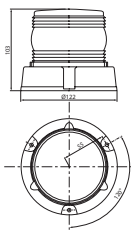

Voltage: 10-100  
Amp: 0.3  
Watt: 5.5

OD: 122 mm  
Height: 103 mm

Bulb type: 9 LED  
Lens type: PMMA  
Colour: Orange  
Mount.: Standard ISO B2 (and B1) - Base  
Flash patterns: 1  
Approvals: CE/EMC

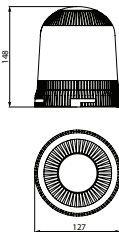

**SPARE PARTS**

**170945 Dome** Std pkg 1 Servicing: HC-CARGO 170830, 171019, 171577, 171587, 171588, 171793, 172027, 172028, 172029, 172030, 172075







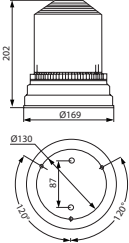

OD: 127 mm  
Height: 148 mm

Lens type: PMMA/ACRYL  
Colour: Orange  
Model: Astral  
E-approval: Yes  
Alternativ no. 171463

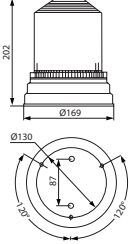
EL. SPECIFICATIONS	DIMENSIONS	ADDITIONAL SPECIFICATIONS
<b>171941 Dome</b> Std pkg 1 Servicing: HC-CARGO 171918, 171919, 171920		
	OD: 130 mm Height: 94 mm	Lens type: Polycarbonate Colour: Orange
<b>171942 Dome</b> Std pkg 1 Servicing: HC-CARGO 171921, 171922, 171923		
	OD: 130 mm Height: 94 mm	Lens type: Polycarbonate Colour: Blue

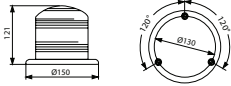
## ROTATING BEACONS XENON

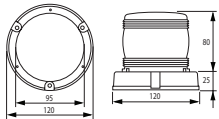
<b>170650 Xenon Beacon</b> Std pkg 1 <i>Beacon Socket: HC-CARGO 170653. Base Plate: HC-CARGO 170528. Xenon Bulb: HC-CARGO 170654.</i>		
 	Bulb incl.: Yes Voltage: 12 Amp: 1.5	OD: 169 mm Height: 202 mm
		Bulb type: LX10J Lens type: Polycarbonate Colour: Orange Model: XENON FT6 AG ELECTRONIC Mount.: Standard ISO B2 (and B1) - Base Hi impact: Yes Tightness norm: IP 55 E-approval: Yes
<b>170651 Xenon Beacon</b> Std pkg 1 <i>Beacon Socket: HC-CARGO 170653. Base Plate: HC-CARGO 170528. Xenon Bulb: HC-CARGO 170654.</i>		
 	Bulb incl.: Yes Voltage: 24 Amp: 1.5	OD: 169 mm Height: 202 mm
		Bulb type: LX10J Lens type: PMMA/ACRYL Colour: Orange Model: XENON FT6 AG ELECTRONIC Mount.: Standard ISO B2 (and B1) - Base Tightness norm: IP 55 E-approval: Yes
<b>170680 Xenon Beacon</b> Std pkg 1 <i>Xenon Bulb: HC-CARGO 171376. Base Plate: HC-CARGO 170528.</i>		
 	Bulb incl.: Yes Voltage: 10-100 Amp: 200/50 mAmpere	OD: 150 mm Height: 121 mm
		Bulb type: LX1J Lens type: Polycarbonate Colour: Orange Material: Polycarbonate Model: FLASH ELEV Mount.: Standard ISO B2 (and B1) - Base Base: Rigid Hi impact: Yes Tightness norm: IP 54 Approvals: CE/EMC Alternativ no. 171005
<b>171005 Xenon Beacon</b> Std pkg 1 <i>w/ Xenon tube. Dome: HC-CARGO 171590. Xenon Bulb: HC-CARGO 170654.</i>		
 	Bulb incl.: Yes Voltage: 10-100	OD: 120 mm Height: 105 mm
		Bulb type: LX10J Lens type: PMMA/ACRYL Colour: Orange Model: TYPE TRASPOT XENON Mount.: Standard ISO B2 (and B1) - Base Approvals: CE/EMC Alternativ no. 170680

**171495 Xenon Beacon** Std pkg 1

Tested for 200 kmh. Dome: HC-CARGO 171512. Coiled Cable: HC-CARGO 171562.

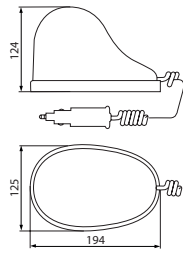

 Bulb incl.: Yes  
 Voltage: 12  
 Amp: 1.5

 OD: 125x194 mm  
 Length: 194 mm  
 Height: 124 mm  
 Width: 125 mm

 Bulb type: LX8J  
 Lens type: Polycarbonate  
 Colour: Orange  
 Material: Rubber  
 Model: GDO FLASH  
 Mount.: 1 magnet  
 Base: Magnetic  
 Hi impact: Yes  
 Coiled cable incl.: Yes  
 Tightness norm: IP 55  
 Approvals: CE  
 E-approval: Yes

**171497 Xenon Beacon** Std pkg 1

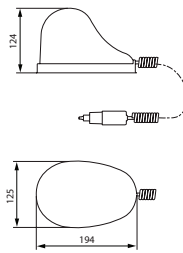
Tested for 200 kmh.



 Bulb incl.: Yes  
 Voltage: 12  
 Amp: 1.5

 OD: 125x194 mm  
 Length: 194 mm  
 Height: 124 mm  
 Width: 125 mm

 Bulb type: LX8J  
 Lens type: Polycarbonate  
 Colour: Blue  
 Material: Rubber  
 Model: GDO FLASH  
 Mount.: 1 magnet  
 Base: Magnetic  
 Hi impact: Yes  
 Coiled cable incl.: Yes  
 Tightness norm: IP 55  
 Approvals: CE  
 E-approval: Yes

**171498 Xenon Beacon** Std pkg 1

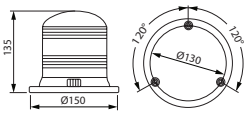
w/ built-in audible signal. Xenon Bulb: HC-CARGO 171376. Base Plate: HC-CARGO 170528.



 Bulb incl.: Yes  
 Voltage: 10-100  
 Amp: 200/50  
 mAmpere

 OD: 150 mm  
 Height: 135 mm

 Bulb type: LX1J  
 Lens type: Polycarbonate  
 Colour: Orange  
 Model: FLASH ELEV SL  
 Mount.: Standard ISO B2 (and B1) - Base  
 Hi impact: Yes  
 Tightness norm: IP 20

**171505 Xenon Beacon** Std pkg 1

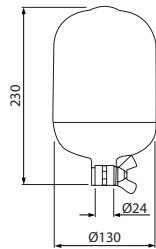
Xenon Bulb: HC-CARGO 170654.

 Bulb incl.: Yes  
 Voltage: 12  
 Amp: 3

 OD: 130 mm  
 Height: 230 mm

 Bulb type: LX10J  
 Lens type: Polycarbonate  
 Colour: Orange  
 Model: XENON GF 8.8 FLASH  
 Mount.: Plan (ISO-DIN B)  
 Base: Rigid  
 Hi impact: Yes  
 Tightness norm: IP 44  
 Approvals: CE  
 E-approval: Yes

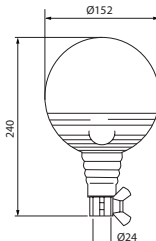
**171540 Xenon Beacon** Std pkg 1

 Bulb incl.: Yes  
 Voltage: 12  
 Amp: 1.5

 OD: 152 mm  
 Height: 240 mm

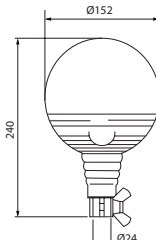
 Bulb type: LX8J  
 Lens type: Polycarbonate  
 Colour: Orange  
 Model: BOULE FLASH  
 Mount.: Standard ISO A - Rod  
 Base: Flexible  
 Hi impact: Yes  
 Tightness norm: IP 66  
 E-approval: Yes

**171541 Xenon Beacon** Std pkg 1

 Bulb incl.: Yes  
 Voltage: 24  
 Amp: 1.5

 OD: 152 mm  
 Height: 240 mm

 Bulb type: LX8J  
 Lens type: Polycarbonate  
 Colour: Orange  
 Model: BOULE FLASH  
 Mount.: Standard ISO A - Rod  
 Base: Flexible  
 Hi impact: Yes  
 Tightness norm: IP 66  
 E-approval: Yes



<b>171561 Xenon Beacon</b> Std pkg 1 <i>w/ Xenon tube. Dome: HC-CARGO 171590.</i>			<b>Bulb incl.:</b> Yes <b>Voltage:</b> 10-100	<b>OD:</b> 120 mm <b>Height:</b> 112 mm	<b>Lens type:</b> PMMA/ACRYL <b>Colour:</b> Orange <b>Model:</b> Type TRASPOT <b>Mount.:</b> Standard ISO B2 (and B1) - Base <b>Base:</b> Magnetic <b>Coiled cable incl.:</b> Yes <b>Approvals:</b> CE/EMC <b>Alternativ no.</b> 170680
<b>171614 Xenon Beacon</b> Std pkg 1			<b>Bulb incl.:</b> Yes <b>Voltage:</b> 10-30	<b>OD:</b> 132 mm <b>Height:</b> 210 mm	<b>Bulb type:</b> LX10J <b>Lens type:</b> Polycarbonate <b>Colour:</b> Orange <b>Model:</b> Xenon <b>Mount.:</b> Standard ISO A - Rod <b>Hi impact:</b> Yes <b>E-approval:</b> Yes
<b>171708 Xenon Beacon</b> Std pkg 1			<b>Bulb incl.:</b> Yes <b>Voltage:</b> 11-120 <b>Amp:</b> 0.2	<b>Length:</b> 139 mm <b>Height:</b> 67 mm <b>Dist. mount. holes:</b> 130 mm	<b>Bulb type:</b> Xenon <b>Lens type:</b> Polycarbonate <b>Flash rate:</b> 72 min. <b>Colour:</b> Orange <b>Mount.:</b> Plan <b>Hi impact:</b> Yes <b>Waterproof:</b> Yes <b>Approvals:</b> CE
<b>171798 Xenon Beacon</b> Std pkg 1			<b>Voltage:</b> 10-100 <b>Watt:</b> 5	<b>OD:</b> 77 mm <b>Height:</b> 45 mm <b>Dist. mount. holes:</b> 45 mm	<b>Bulb type:</b> Xenon <b>Lens type:</b> Polycarbonate <b>Flash rate:</b> 75 min. <b>Colour:</b> Orange <b>Material:</b> Polycarbonate <b>Mount.:</b> Plan <b>Hi impact:</b> Yes <b>Tightness norm:</b> IP 67 <b>Approvals:</b> CE
<b>SPARE PARTS</b>					
<b>170654 Xenon Bulb</b> Std pkg 1 Servicing: HC-CARGO 170650, 170651, 171505, 171005			<b>Bulb incl.:</b> Yes <b>Voltage:</b> 12/24 <b>Watt:</b> 16		<b>Bulb type:</b> LX10J <b>Model:</b> XENON FT6 /FLX ELECTRONIC
<b>171376 Xenon Bulb</b> Std pkg 1 Servicing: HC-CARGO 171498, 170680					<b>Bulb type:</b> LX1J <b>Model:</b> FLASH ELEV
<b>171590 Dome</b> Std pkg 1 Servicing: HC-CARGO 171005, 171561, 172114				<b>OD:</b> 95 mm <b>Height:</b> 80 mm	<b>Lens type:</b> PMMA/ACRYL <b>Colour:</b> Orange <b>Model:</b> TRANSPORT XENON <b>Alternativ no.</b> 170680

**ACCESSORIES**
**170525** Beacon Socket

Std pkg 1 Servicing: HC-CARGO 170490, 171017

 Cable length: 2000 mm  
 Height: 28 mm  
 Width: 147 mm

 Model: TYPE FT 6  
 Mount.: 3 magnets  
 Base: Magnetic  
 Coiled cable incl.: Yes  
 Tightness norm: IP 55

**170528** Base Plate

Std pkg 1 Servicing: HC-CARGO 170491, 170490, 170650, 170651, 171498, 170680

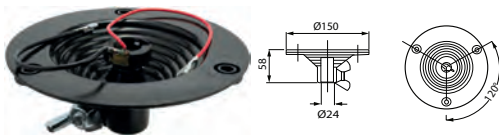
 Height: 58 mm  
 Width: 150 mm

 Model: TYPE FT 6  
 Mount.: Standard ISO A - Rod

**170653** Beacon Socket

Std pkg 1 Servicing: HC-CARGO 170650, 170651, 171466



 Cable length: 2000 mm  
 Height: 30 mm  
 Width: 168 mm

 Mount.: 3 magnets  
 Base: Magnetic  
 Coiled cable incl.: Yes  
 Tightness norm: IP 55  
 E-approval: Yes

**FLASH LIGHTS LED**
**171642** LED Flash, white

Std pkg 1

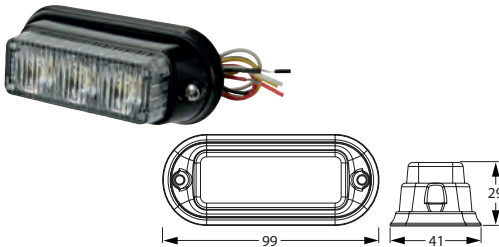
Multi-module synchronization. Bracket: HC-CARGO 171657. Rubber adapter for flush mount: HC-CARGO 171728.

 Voltage: 12/24  
 Amp: 0.35/0.18  
 Watt: 6

 Length: 99 mm  
 Height: 29 mm  
 Width: 41 mm

 Bulb type: 3 LED  
 Lens type: Polycarbonate  
 Colour: White  
 Material: Aluminium  
 Flash patterns: 12  
 Waterproof: Yes  
 Approvals: CE/EMC

**171644** LED Flash, blue

Std pkg 1

Multi-module synchronization. Bracket: HC-CARGO 171657. Rubber adapter for flush mount: HC-CARGO 171728.

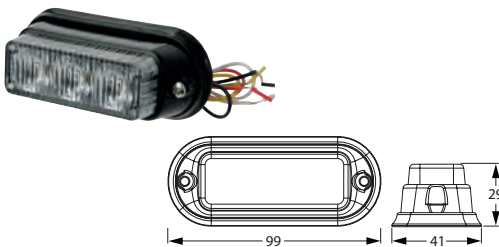
 Voltage: 12/24  
 Amp: 0.35/0.18  
 Watt: 6

 Length: 99 mm  
 Height: 29 mm  
 Width: 41 mm

 Bulb type: 3 LED  
 Lens type: Polycarbonate  
 Colour: Blue  
 Material: Aluminium  
 Flash patterns: 12  
 Waterproof: Yes  
 Approvals: CE/EMC

**171646** LED Flash, white

Std pkg 1

Multi-module synchronization. Bracket: HC-CARGO 171658. Rubber adapter for flush mount: HC-CARGO 171675.

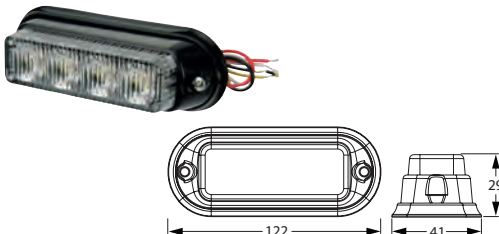
 Voltage: 12/24  
 Amp: 0.64/0.34  
 Watt: 8.2

 Length: 122 mm  
 Height: 29 mm  
 Width: 41 mm

 Bulb type: 4 LED  
 Lens type: Polycarbonate  
 Colour: White  
 Material: Aluminium  
 Flash patterns: 19  
 Waterproof: Yes  
 Approvals: CE/EMC

<b>171648 LED Flash, blue</b> Std pkg 1 <i>Multi-module synchronization. Bracket: HC-CARGO 171658. Rubber adapter for flush mount: HC-CARGO 171675.</i>		
	Voltage: 12/24 Amp: 0.64/0.34 Watt: 8.2	Length: 122 mm Height: 29 mm Width: 41 mm
<b>171661 LED Flash, amber</b> Std pkg 1 <i>Multi-module synchronization. Bracket: HC-CARGO 171663.</i>		
	Voltage: 12/24 Amp: 0.55/0.26 Watt: 6	Length: 116 mm Cable length: 200 mm Height: 23.8 mm Width: 47 mm
<b>171662 LED Flash, amber</b> Std pkg 1 <i>Multi-module synchronization. Bracket: HC-CARGO 171664.</i>		
	Voltage: 12/24 Amp: 0.46/0.24 Watt: 6	Length: 148 mm Cable length: 200 mm Height: 23 mm Width: 47 mm
<b>171746 LED Flash, amber</b> Std pkg 1		
	Voltage: 12/24 Amp: 0.27-0.13 Watt: 3.5	Length: 109 mm Cable length: 1200 mm Height: 28 mm Width: 72 mm
<b>171813 LED Flash, blue</b> Std pkg 1 <i>Fits w/ rubber adapter for flush mount: HC-CARGO 171817.</i>		
	Voltage: 12/24 Amp: 0.39/0.20 Watt: 0.48	Length: 127.5 mm Cable length: 200 mm Height: 17.2 mm Width: 27.8 mm
<b>171814 LED Flash, amber</b> Std pkg 1 <i>Fits w/ rubber adapter for flush mount: HC-CARGO 171817.</i>		
	Voltage: 12/24 Amp: 0.39/0.20 Watt: 0.48	Length: 127.5 mm Cable length: 970 mm Height: 17.2 mm Width: 27.8 mm

**171904 LED Flash, amber** Std pkg 1

Multi-module synchronization. Bracket: HC-CARGO 171658. Rubber adapter for flush mount: HC-CARGO 171675.

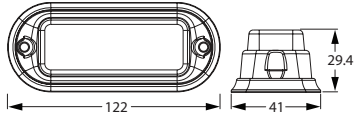

 Voltage: 12-24  
 Amp: 0.32/0.17  
 Watt: 4.1

 Length: 122 mm  
 Cable length: 200 mm  
 Height: 29.4 mm  
 Width: 41 mm

 Bulb type: 4 LED  
 Lens type: Polycarbonate  
 Colour: Orange  
 Material: Aluminium  
 Flash patterns: 23  
 Waterproof: Yes  
 Approvals: SAE/ECE-R65  
 E-approval: Yes

**171905 LED Flash, amber** Std pkg 1

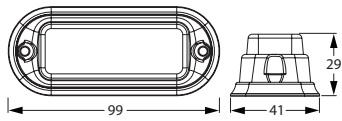
Multi-module synchronization. Bracket: HC-CARGO 171657. Rubber adapter for flush mount: HC-CARGO 171728.



 Voltage: 12-24  
 Amp: 0.32/0.16  
 Watt: 4.1

 Length: 99 mm  
 Cable length: 200 mm  
 Height: 29 mm  
 Width: 41 mm

 Bulb type: 3 LED  
 Lens type: Polycarbonate  
 Colour: Orange  
 Material: Aluminium  
 Flash patterns: 12  
 Waterproof: Yes  
 Approvals: SAE/ECE-R65  
 E-approval: Yes

**171906 LED Flash, amber** Std pkg 1

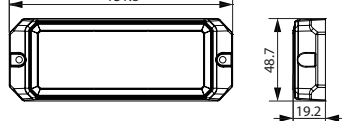
Multi-module synchronization. Bracket: HC-CARGO 171908. Rubber adapter for flush mount: HC-CARGO 171907.



 Voltage: 12-24  
 Amp: 0.75/0.38  
 Watt: 9

 Length: 131.8 mm  
 Cable length: 200 mm  
 Height: 48.7 mm  
 Width: 19.2 mm

 Bulb type: 12 LED  
 Lens type: Polycarbonate  
 Colour: Orange  
 Material: Aluminium  
 Flash patterns: 25  
 Waterproof: Yes  
 Approvals: SAE/ECE-R65  
 E-approval: Yes

**171926 LED Flash, amber** Std pkg 1

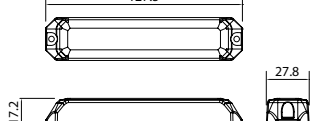
Fits w/ rubber adapter for flush mount: HC-CARGO 171817.

 Voltage: 12-24  
 Amp: 0.39/0.20  
 Watt: 9.6

 Length: 127.5 mm  
 Cable length: 3000 mm  
 Height: 17.2 mm  
 Width: 27.8 mm

 Bulb type: 6 LED  
 Lens type: Polycarbonate  
 Colour: Orange  
 Material: Aluminium  
 Mount.: 3 m ADR Cable  
 Flash patterns: 5  
 Waterproof: Yes  
 Approvals: SAE/ECE-R65  
 E-approval: Yes

**171933 LED Flash, amber** Std pkg 1

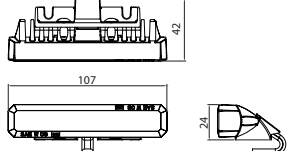



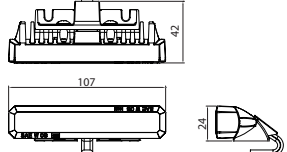

 Voltage: 12-24  
 Amp: 0.55/0.26  
 Watt: 9.6

 Length: 107 mm  
 Cable length: 970 mm  
 Height: 24 mm  
 Width: 42 mm

 Bulb type: 6 LED  
 Lens type: Polycarbonate  
 Colour: Orange  
 Material: Aluminium  
 Flash patterns: 19  
 Waterproof: Yes  
 Approvals: SAE/ECE-R65  
 E-approval: Yes  
 Alternativ no. 171814

**171934 LED Flash, blue** Std pkg 1

 Voltage: 12-24  
 Amp: 0.43/0.29  
 Watt: 13.8

 Length: 107 mm  
 Height: 24 mm  
 Width: 42 mm

 Bulb type: 6 LED  
 Lens type: Polycarbonate  
 Colour: Blue  
 Material: Aluminium  
 Mount.: Plan  
 Flash patterns: 5  
 Waterproof: Yes  
 Approvals: SAE/ECE-R65  
 E-approval: Yes

EL. SPECIFICATIONS		DIMENSIONS	ADDITIONAL SPECIFICATIONS
<b>171943</b> LED Flash, white 	Std pkg 1	Voltage: 12/24 Amp: 0.27-0.13 Watt: 3.5	Length: 109 mm Cable length: 1200 mm Height: 28 mm Width: 72 mm Bulb type: LED Lens type: Polycarbonate Colour: White Material: Aluminium Flash patterns: 19 Hi impact: Yes Coiled cable incl.: No Waterproof: Yes Approvals: SAE/CE
<b>172011</b> LED Flash, amber 	Std pkg 1	Voltage: 12/24 Amp: 0.5/0.25 Watt: 6	Length: 129.2 mm Cable length: 250 mm Height: 31.4 mm Width: 16.8 mm Bulb type: 6 LED Lens type: Polycarbonate Colour: Orange Material: Aluminium Flash patterns: 15 Waterproof: Yes Approvals: ECE-R65 E-approval: Yes
<b>172012</b> LED Flash, amber 	Std pkg 1	Voltage: 12/24 Amp: 0.88/0.44 Watt: 10.5	Length: 129 mm Cable length: 250 mm Height: 16.8 mm Width: 50 mm Bulb type: 12 LED Lens type: Polycarbonate Colour: Orange Material: Aluminium Flash patterns: 15 Waterproof: Yes Approvals: ECE-R65 E-approval: Yes
<b>172013</b> LED Flash, amber 	Std pkg 1	Voltage: 12/24 Amp: 0.25/0.125 Watt: 3	Length: 130.5 mm Cable length: 200 mm Height: 6.6 mm Width: 30 mm Bulb type: 6 LED Lens type: Polycarbonate Colour: Orange Material: Aluminium Flash patterns: 23 Waterproof: Yes Approvals: SAE/CE E-approval: Yes
<b>172076</b> LED Flash, amber 	Std pkg 1	Voltage: 12-24 Amp: 0.75/0.38 Watt: 9	Length: 131.8 mm Cable length: 2000 mm Height: 48.7 mm Width: 19.2 mm Bulb type: 12 LED Lens type: Polycarbonate Colour: Orange Material: Aluminium Flash patterns: 25 Waterproof: Yes Approvals: SAE/ECE-R65 E-approval: Yes
<i>Multi-module synchronization. Bracket: HC-CARGO 171908. Rubber adapter for flush mount: HC-CARGO 171907.</i>			
<b>172085</b> LED Flash, amber 	Std pkg 1	Voltage: 12-36 Amp: 1.5/0.8	Length: 127.3 mm Cable length: 1800 mm Height: 78.8 mm Width: 38 mm Bulb type: 6 LED Lens type: Polycarbonate Colour: Orange Material: Aluminium Tightness norm: IP 67 Approvals: ECE-R10/ECE-R65 E-approval: Yes
<b>172086</b> LED Flash, amber 	Std pkg 1	Voltage: 12-36 Amp: 1.5/0.8	Length: 143.6 mm Cable length: 1800 mm Height: 95.9 mm Width: 37.7 mm Bulb type: 6 LED Lens type: Polycarbonate Colour: Orange Material: Aluminium Mount.: Plan Tightness norm: IP 67 Approvals: ECE-R10/ECE-R65 E-approval: Yes

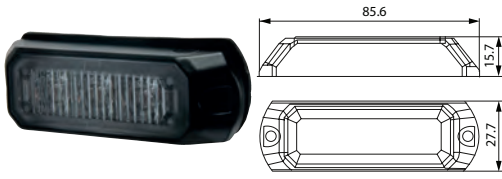
**172087 LED Flash, amber** Std pkg 1

*Rubber Adapter for Flush Mount: HC-CARGO 171816.*

**Voltage:** 12-24

**Length:** 85.6 mm  
**Height:** 15.7 mm  
**Width:** 27.7 mm

**Bulb type:** 3 LED  
**Lens type:** Polycarbonate  
**Colour:** Orange  
**Material:** Aluminium  
**Flash patterns:** 12  
**Waterproof:** Yes  
**Approvals:** SAE/ECE-R65  
**E-approval:** Yes  
**Alternativ no.** 171815

**172089 LED Safety Flash** Std pkg 1

*With hook. Battery: 3x HC-CARGO 200738.*

**OD:** 105 mm  
**Height:** 35 mm

**Bulb type:** 12 LED  
**Colour:** Orange  
**Mount.:** 1 magnet  
**Flash patterns:** 9  
**Tightness norm:** IP 67  
**Approvals:** CE/EMC

**172090 LED Safety Flash** Std pkg 1

*Rechargeable.*

**Voltage:** 12/24  
**Amp:** 1.5

**OD:** 120 mm  
**Height:** 35 mm

**Bulb type:** 16 LED  
**Colour:** Orange  
**Mount.:** 1 magnet  
**Flash patterns:** 9  
**Wall charger 230 V:** Yes  
**Charger 12 V:** Yes  
**Tightness norm:** IP 67  
**Approvals:** CE/EMC

**172091 LED Safety Flash** Std pkg 1

*Rechargeable. Suitcase w/ 6 pcs.*

**Voltage:** 12/24  
**Amp:** 1.5

**OD:** 120 mm  
**Height:** 35 mm

**Bulb type:** 16 LED  
**Colour:** Orange  
**Mount.:** 1 magnet  
**Flash patterns:** 9  
**Wall charger 230 V:** Yes  
**Charger 12 V:** Yes  
**Tightness norm:** IP 67  
**Approvals:** CE/EMC

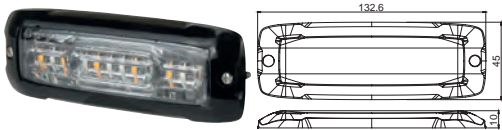
**172108 LED Flash, blue/orange** Std pkg 1

**Voltage:** 12-24  
**Amp:** 0.88/0.44  
**Watt:** 10.5

**Length:** 132.6 mm  
**Cable length:** 250 mm  
**Height:** 45 mm  
**Width:** 10 mm

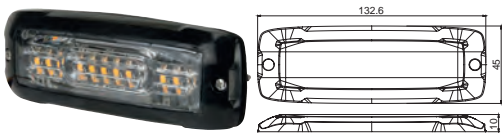
**Bulb type:** 12 LED  
**Lens type:** Polycarbonate  
**Colour:** Blue/Orange  
**Material:** Aluminium  
**Mount.:** Plan  
**Flash patterns:** 16  
**Waterproof:** Yes  
**Approvals:** EMC/ECE-R65  
**E-approval:** Yes

**172109 LED Flash, amber** Std pkg 1

**Voltage:** 12-24  
**Amp:** 0.88/0.44  
**Watt:** 10.5

**Length:** 132.6 mm  
**Cable length:** 250 mm  
**Height:** 45 mm  
**Width:** 10 mm

**Bulb type:** 12 LED  
**Lens type:** Polycarbonate  
**Colour:** Orange  
**Material:** Aluminium  
**Mount.:** Plan  
**Flash patterns:** 16  
**Waterproof:** Yes  
**Approvals:** EMC/ECE-R65  
**E-approval:** Yes



**172112 LED Flash, amber** Std pkg 1

**Voltage:** 12-24  
**Amp:** 0.88/0.44  
**Watt:** 10.5

**Length:** 98.54 mm  
**Cable length:** 250 mm  
**Height:** 35.07 mm  
**Width:** 10 mm

**Bulb type:** 6 LED  
**Lens type:** Polycarbonate  
**Colour:** Orange  
**Material:** Aluminium  
**Mount.:** Plan  
**Flash patterns:** 16  
**Waterproof:** Yes  
**Approvals:** EMC/ECE-R65  
**E-approval:** Yes

EL. SPECIFICATIONS		DIMENSIONS	ADDITIONAL SPECIFICATIONS
<b>172113 LED Flash, amber</b> Std pkg 1			
 	Voltage: 12/24 Amp: 0.27-0.13 Watt: 3.5	Length: 109 mm Cable length: 1200 mm Height: 28 mm Width: 72 mm	Bulb type: LED Lens type: Polycarbonate Colour: Orange Material: Aluminium Flash patterns: 19 Coiled cable incl.: No Waterproof: Yes Approvals: SAE/ECE-R65
<b>172118 LED Safety Flash UK</b> Std pkg 1			
<i>Rechargeable. Suitcase w/ 6 pcs.</i>			
	Voltage: 12/24 Amp: 1.5	OD: 120 mm Height: 35 mm	Bulb type: 16 LED Colour: Orange Mount.: 1 magnet Flash patterns: 9 Wall charger 230 V: Yes Charger 12 V: Yes Tightness norm: IP 67 Approvals: CE/EMC
<b>172121 LED Safety Flash UK</b> Std pkg 1			
<i>Rechargeable.</i>			
	Voltage: 12/24 Amp: 1.5	OD: 120 mm Height: 35 mm	Bulb type: 16 LED Colour: Orange Mount.: 1 magnet Flash patterns: 9 Wall charger 230 V: Yes Charger 12 V: Yes Tightness norm: IP 67 Approvals: CE/EMC
<b>172122 LED Flash, amber</b> Std pkg 1			
	Voltage: 12/24 Amp: 0.24/0.12 Watt: 2.82	Cable length: 200 mm Height: 17 mm Dist. mount. holes: 32.5 mm Width: 46.7 mm	Bulb type: 3 LED Colour: Orange Mount.: Plan Flash patterns: 12 Tightness norm: IP 67 Approvals: SAE/CE
<b>172123 LED Flash, blue</b> Std pkg 1			
<i>Mounting Bracket: HC-CARGO 172125.</i>			
	Voltage: 12/24 Amp: 0.24/0.12 Watt: 2.85	Cable length: 200 mm Height: 39 mm Width: 36 mm	Bulb type: 3 LED Colour: Blue Mount.: Built-in Flash patterns: 16 Tightness norm: IP 67 Approvals: SAE/ECE-R65 E-approval: Yes
<b>172124 LED Flash, amber</b> Std pkg 1			
<i>Mounting Bracket: HC-CARGO 172125.</i>			
	Voltage: 12/24 Amp: 0.24/0.12 Watt: 2.85	Cable length: 200 mm Height: 39 mm Width: 36 mm	Bulb type: 3 LED Colour: Orange Mount.: Built-in Flash patterns: 16 Tightness norm: IP 67 Approvals: SAE/ECE-R65 E-approval: Yes
<b>ACCESSORIES</b>			
<b>171657 Mounting Bracket</b> Std pkg 1 Servicing: HC-CARGO 171642, 171644, 171905			
<i>Angled. For single head.</i>			
		Length: 100 mm Thickness: 24 mm Width: 55 mm	

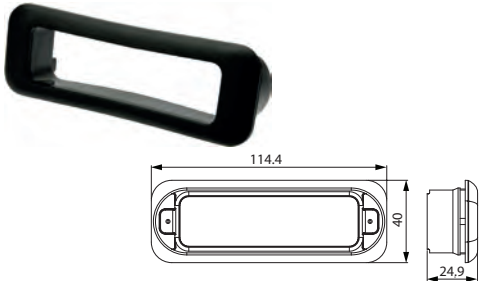
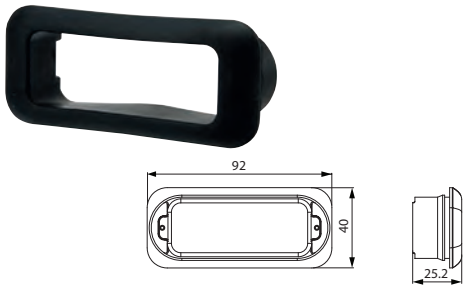
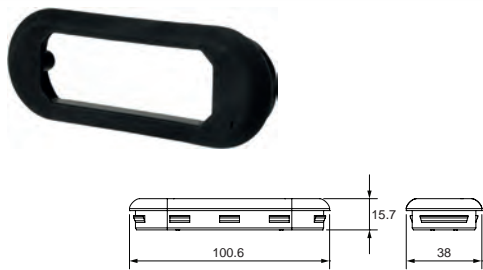
		EL. SPECIFICATIONS	DIMENSIONS	ADDITIONAL SPECIFICATIONS
<b>171658</b> Mounting Bracket <i>Angled. For single head.</i>		Std pkg 1 Servicing: HC-CARGO 171646, 171648, 171904	Length: 123 mm Thickness: 55 mm Width: 24 mm	
				
<b>171663</b> Mounting Bracket <i>Angled 100°.</i>		Std pkg 1 Servicing: HC-CARGO 171661	Length: 153 mm Thickness: 55 mm Width: 25 mm	
				
<b>171664</b> Mounting Bracket <i>Adjustable.</i>		Std pkg 1 Servicing: HC-CARGO 171662	Length: 156 mm Thickness: 42 mm Width: 30 mm	
				
<b>171675</b> Rubber Adapter for Flush Mount 		Std pkg 1 Servicing: HC-CARGO 171646, 171648, 171904	Length: 114.4 mm Height: 24.9 mm Width: 40 mm	Colour: Black Material: Rubber
<b>171728</b> Rubber Adapter for Flush Mount 		Std pkg 1 Servicing: HC-CARGO 171641, 171642, 171644, 171905	Length: 92 mm Height: 25.2 mm Width: 40 mm	Colour: Black Material: Rubber
<b>171816</b> Rubber Adapter for Flush Mount 		Std pkg 1 Servicing: HC-CARGO 171815, 172087	Length: 100.6 mm Height: 15.7 mm Width: 38 mm	Colour: Black Material: Rubber



EL. SPECIFICATIONS	DIMENSIONS	ADDITIONAL SPECIFICATIONS
<b>171817</b> Rubber Adapter for Flush Mount    Std pkg 1    Servicing: HC-CARGO 171813, 171814, 171926		
 	Length: 142 mm Height: 17.5 mm Width: 41 mm	Colour: Black Material: Rubber
<b>171907</b> Rubber Adapter for Flush Mount    Std pkg 1    Servicing: HC-CARGO 171906, 172076		
	Length: 144 mm Height: 61 mm Width: 20 mm	Colour: Black Material: Rubber
<b>171908</b> Mounting Bracket    Std pkg 1    Servicing: HC-CARGO 171906, 172076		
<i>Angled. For single head.</i>		
		
<b>172125</b> Mounting Bracket    Std pkg 1    Servicing: HC-CARGO 172123, 172124		
<div style="border: 1px solid black; border-radius: 50%; padding: 20px; width: fit-content; margin: 0 auto;"> <p><b>NEW PRODUCT</b>  <a href="http://www.hc-cargo.com">www.hc-cargo.com</a></p> </div>		
<h3>LIGHT BARS CONVENTIONAL</h3>		
<b>171681</b> Mini Light Bar    Std pkg 1		
<i>Belt for Mini Light Bar: HC-CARGO 171820.</i>		
 	Bulb incl.: Yes 12 V Voltage: 12/24	Length: 400 mm Height: 134 mm Width: 180 mm  Bulb type: H1 12 V Lens type: Polycarbonate Colour: Orange Material: ABS plastic Mount.: Plan Base: Rigid Hi impact: Yes Coiled cable incl.: No Waterproof: Yes Tightness norm: IP 56 Approvals: CE E-approval: Yes
<h3>SPARE PARTS</h3>		
<b>171820</b> Belt for Mini Light Bar    Std pkg 1    Servicing: HC-CARGO 171681		
		Colour: Black

## LIGHT BARS LED

### 171680 LED Mini Light Bar Std pkg 1

Bracket for permanent mounting: HC-CARGO 171682. Change flash pattern on cigarplug. Can also be connected permanently.



Voltage: 12/24  
Amp: 2.6/1.36  
Watt: 33.3

Length: 422 mm  
Cable length: 4570 mm  
Height: 65 mm  
Width: 278 mm

Bulb type: 40x1W LED  
Lens type: Polycarbonate  
Colour: Orange  
Model: FALCON  
Mount.: Plan  
Base: Magnetic/vacuum  
Flash patterns: 26  
Hi impact: Yes  
Waterproof: Yes  
Tightness norm: IP 64K  
Approvals: SAE/CE  
E-approval: No

### 171760 LED Light bar Std pkg 1

Spare Parts: HC-CARGO 171778. Accessories: HC-CARGO 171777, 171779, 171780, 171781, 171762.

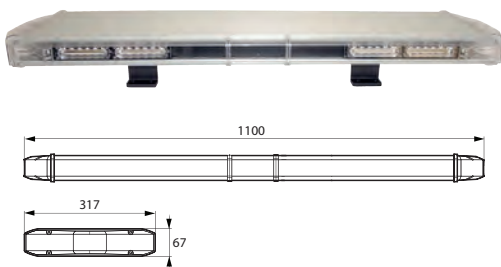

Voltage: 12/24  
Amp: 16

Length: 1100 mm  
Cable length: 5750 mm  
Height: 67 mm  
Width: 317 mm

Lens type: Polycarbonate  
Colour: Orange  
Material: Aluminium  
Model: 110 cm/44"  
Mount.: Plan  
Base: Flexible  
Flash patterns: 22  
Hi impact: Yes  
Waterproof: Yes  
Tightness norm: IP 64K  
Approvals: SAE/CE  
E-approval: No

### 171761 LED Light bar Std pkg 1

Spare Parts: HC-CARGO 171778. Accessories: HC-CARGO 171777, 171779, 171780, 171781, 171762.

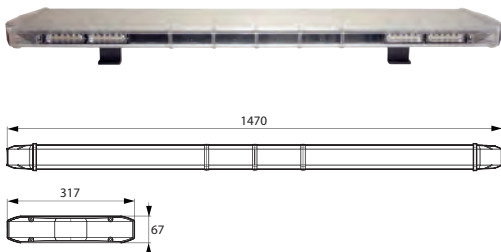

Voltage: 12/24  
Amp: 16.7

Length: 1470 mm  
Cable length: 5750 mm  
Height: 67 mm  
Width: 317 mm

Lens type: Polycarbonate  
Colour: Orange  
Material: Aluminium  
Model: 147 cm/59"  
Mount.: Plan  
Base: Flexible  
Flash patterns: 22  
Hi impact: Yes  
Waterproof: Yes  
Tightness norm: IP 64K  
Approvals: SAE/CE  
E-approval: No

### 171849 LED Light bar Std pkg 1

Spare Parts: HC-CARGO 171856, 171858. Accessories: HC-CARGO 171781, 171762. Recommended fuse 15 A.

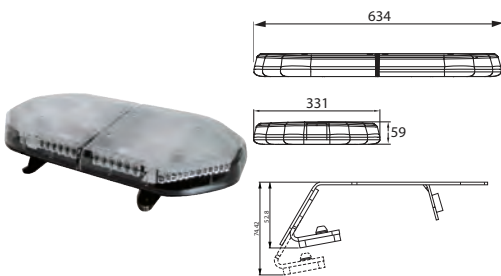

Voltage: 12/24  
Amp: 5.2

Length: 634 mm  
Cable length: 5750 mm  
Height: 59 mm  
Width: 331 mm

Lens type: Polycarbonate  
Colour: Orange  
Material: Aluminium  
Model: 65 cm/24"  
Mount.: Plan  
Base: Flexible  
Flash patterns: 6  
Hi impact: Yes  
Waterproof: Yes  
Tightness norm: IP 64K  
Approvals: SAE/ECE-R65  
E-approval: Yes

### 171850 LED Light bar Std pkg 1

Spare Parts: HC-CARGO 171856, 171858. Accessories: HC-CARGO 171781, 171762. Recommended fuse 20 A.



Voltage: 12/24  
Amp: 15

Length: 1087 mm  
Cable length: 5750 mm  
Height: 59 mm  
Width: 331 mm

Lens type: Polycarbonate  
Colour: Orange  
Material: Aluminium  
Model: 110 cm/43"  
Mount.: Plan  
Base: Flexible  
Flash patterns: 21  
Hi impact: Yes  
Waterproof: Yes  
Tightness norm: IP 64K  
Approvals: SAE/ECE-R65  
E-approval: Yes

<p><b>171851 LED Light bar</b> Std pkg 1</p> <p><i>Spare Parts: HC-CARGO 171857, 171859. Accessories: HC-CARGO 171865, 171762. Recommended fuse 15 A.</i></p>		
	<p><b>Voltage:</b> 12/24 <b>Amp:</b> 8</p>	<p><b>Length:</b> 1087 mm <b>Cable length:</b> 5750 mm <b>Height:</b> 59 mm <b>Width:</b> 331 mm</p>
<p><b>Lens type:</b> Polycarbonate <b>Colour:</b> Orange <b>Material:</b> Aluminium <b>Model:</b> 110 cm/43" <b>Mount.:</b> Plan <b>Base:</b> Flexible <b>Flash patterns:</b> 21 <b>Hi impact:</b> Yes <b>Waterproof:</b> Yes <b>Tightness norm:</b> IP 64K <b>Approvals:</b> SAE/ECE-R65 <b>E-approval:</b> Yes</p>		
<p><b>171852 LED Light bar</b> Std pkg 1</p> <p><i>Spare Parts: HC-CARGO 171856, 171858. Accessories: HC-CARGO 171781, 171762. Recommended fuse 25 A.</i></p>		
	<p><b>Voltage:</b> 12/24 <b>Amp:</b> 17</p>	<p><b>Length:</b> 1387 mm <b>Cable length:</b> 5750 mm <b>Height:</b> 59 mm <b>Width:</b> 331 mm</p>
<p><b>Lens type:</b> Polycarbonate <b>Colour:</b> Orange <b>Material:</b> Aluminium <b>Model:</b> 140 cm/54" <b>Mount.:</b> Plan <b>Base:</b> Flexible <b>Flash patterns:</b> 21 <b>Hi impact:</b> Yes <b>Waterproof:</b> Yes <b>Tightness norm:</b> IP 64K <b>Approvals:</b> SAE/ECE-R65 <b>E-approval:</b> Yes</p>		
<p><b>171853 LED Light bar</b> Std pkg 1</p> <p><i>Spare Parts: HC-CARGO 171857, 171859. Accessories: HC-CARGO 171865, 171762. Recommended fuse 15 A.</i></p>		
	<p><b>Voltage:</b> 12/24 <b>Amp:</b> 17</p>	<p><b>Length:</b> 1387 mm <b>Cable length:</b> 5750 mm <b>Height:</b> 59 mm <b>Width:</b> 331 mm</p>
<p><b>Lens type:</b> Polycarbonate <b>Colour:</b> Orange <b>Material:</b> Aluminium <b>Model:</b> 140 cm/54" <b>Mount.:</b> Plan <b>Base:</b> Flexible <b>Flash patterns:</b> 21 <b>Hi impact:</b> Yes <b>Waterproof:</b> Yes <b>Tightness norm:</b> IP 64K <b>Approvals:</b> SAE/ECE-R65 <b>E-approval:</b> Yes</p>		
<p><b>171854 LED Micro Light Bar</b> Std pkg 1</p> <p><i>Bracket for permanent mounting: HC-CARGO 171855. Change flash pattern on cigarplug. Can also be connected permanently.</i></p>		
	<p><b>Voltage:</b> 12/24 <b>Amp:</b> 4.2/1.05</p>	<p><b>OD:</b> 248x172 mm <b>Length:</b> 248 mm <b>Cable length:</b> 3000 mm <b>Height:</b> 37 mm <b>Width:</b> 172 mm</p>
<p><b>Bulb type:</b> 30x1 W LED <b>Lens type:</b> Polycarbonate <b>Colour:</b> Orange <b>Mount.:</b> Plan <b>Base:</b> Magnetic <b>Flash patterns:</b> 23 <b>Hi impact:</b> Yes <b>Waterproof:</b> Yes <b>Tightness norm:</b> IP 64K <b>Approvals:</b> SAE/ECE-R65 <b>E-approval:</b> Yes</p>		
<p><b>171909 LED Light bar</b> Std pkg 1</p> <p><i>Spare Parts: HC-CARGO 171915, 171916. Accessories: HC-CARGO 171781, 171762. Recommended fuse 25 A.</i></p>		
	<p><b>Voltage:</b> 12/24 <b>Amp:</b> 16.4</p>	<p><b>Length:</b> 1087 mm <b>Height:</b> 59 mm <b>Width:</b> 331 mm</p>
<p><b>Lens type:</b> Polycarbonate <b>Colour:</b> Blue <b>Material:</b> Aluminium <b>Model:</b> 110 cm/43" <b>Mount.:</b> Plan <b>Base:</b> Flexible <b>Hi impact:</b> Yes <b>Waterproof:</b> Yes <b>Approvals:</b> SAE/ECE-R65 <b>E-approval:</b> Yes</p>		

**171910 LED Light bar** Std pkg 1

Spare Parts: HC-CARGO 171856, 171858. Accessories: HC-CARGO 171781, 171762. Recommended fuse 20 A.



Voltage: 12/24  
Amp: 8

Length: 935 mm  
Cable length: 5750 mm  
Height: 59 mm  
Width: 331 mm

Lens type: Polycarbonate  
Colour: Orange  
Material: Aluminium  
Model: 91.4 cm - 36"  
Mount.: Plan  
Base: Flexible  
Flash patterns: 21  
Hi impact: Yes  
Waterproof: Yes  
Tightness norm: IP 64K  
Approvals: SAE/ECE-R65  
E-approval: Yes

**171911 LED Light bar** Std pkg 1

Spare Parts: HC-CARGO 171857, 171859. Accessories: HC-CARGO 171865, 171762. Recommended fuse 15 A.

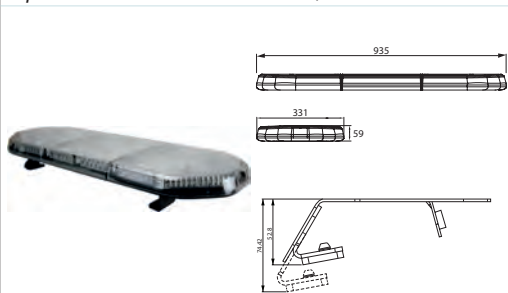

Voltage: 12/24  
Amp: 8

Length: 935 mm  
Cable length: 5750 mm  
Height: 59 mm  
Width: 331 mm

Lens type: Polycarbonate  
Colour: Orange  
Material: Aluminium  
Model: 91.4cm - 36"  
Mount.: Plan  
Base: Flexible  
Flash patterns: 21  
Hi impact: Yes  
Waterproof: Yes  
Tightness norm: IP 64K  
Approvals: SAE/ECE-R65  
E-approval: Yes

**171912 LED Light bar** Std pkg 1

Spare Parts: HC-CARGO 171856, 171858. Accessories: HC-CARGO 171781, 171762. Recommended fuse 25 A.



Voltage: 12/24  
Amp: 16

Length: 1252 mm  
Cable length: 5750 mm  
Height: 59 mm  
Width: 331 mm

Lens type: Polycarbonate  
Colour: Orange  
Material: Aluminium  
Model: 124.5 cm/49"  
Mount.: Plan  
Base: Flexible  
Flash patterns: 21  
Hi impact: Yes  
Waterproof: Yes  
Tightness norm: IP 64K  
Approvals: SAE/ECE-R65  
E-approval: Yes

**171913 LED Light bar** Std pkg 1

Spare Parts: HC-CARGO 171857, 171859. Accessories: HC-CARGO 171865, 171762. Recommended fuse 15 A.



Voltage: 12/24  
Amp: 16

Length: 1252 mm  
Cable length: 5750 mm  
Height: 59 mm  
Width: 331 mm

Lens type: Polycarbonate  
Colour: Orange  
Material: Aluminium  
Model: 124.5 cm/49"  
Mount.: Plan  
Base: Flexible  
Flash patterns: 21  
Hi impact: Yes  
Waterproof: Yes  
Tightness norm: IP 64K  
Approvals: SAE/ECE-R65  
E-approval: Yes

**171914 LED Light bar** Std pkg 1

Spare Parts: HC-CARGO 171857, 171859. Accessories: HC-CARGO 171865, 171762. Recommended fuse 20 A.



Voltage: 12/24  
Amp: 18

Length: 1524 mm  
Cable length: 5750 mm  
Height: 59 mm  
Width: 331 mm

Lens type: Polycarbonate  
Colour: Orange  
Material: Aluminium  
Model: 152.4 cm/60"  
Mount.: Plan  
Base: Flexible  
Flash patterns: 21  
Hi impact: Yes  
Waterproof: Yes  
Tightness norm: IP 64K  
Approvals: SAE/ECE-R65  
E-approval: Yes

<b>172094 LED Mini Light Bar</b> Std pkg 1 Switch Panel: HC-CARGO 171762.		Voltage: 12/24 Amp: 2.88/1.44 Watt: 34.5	Length: 355 mm Cable length: 3000 mm Height: 53 mm Width: 205 mm Dist. mount. holes: 204 mm	Bulb type: 24 LED Lens type: Polycarbonate Colour: Orange Material: Shockproof plastic Mount.: Screw Flash patterns: 23 Waterproof: Yes Tightness norm: IP 64K Approvals: EMC-R10/ECE-R65 E-approval: Yes
--	--	--	---	--

<b>172115 LED Mini Light Bar</b> Std pkg 1 Switch Panel: HC-CARGO 171762.		Voltage: 12/24 Amp: 2.88/1.44 Watt: 34.5	Length: 355 mm Cable length: 3000 mm Height: 53 mm Width: 205 mm Dist. mount. holes: 204 mm	Bulb type: 24 LED Lens type: Polycarbonate Colour: Blue Material: Shockproof plastic Mount.: Screw Flash patterns: 23 Waterproof: Yes Tightness norm: IP 64K Approvals: ECE-R10/ECE-R65 E-approval: Yes
--	--	--	---	--

**ACCESSORIES**



<b>171682 Mounting Bracket for LED Mini Light Bar</b> Std pkg 1 Servicing: HC-CARGO 171680		Thickness: 3 mm Dist. mount. holes: 212 mm		
--	--	---	--	--







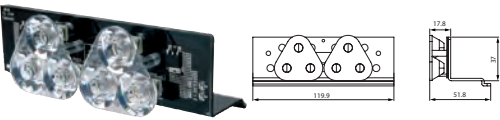

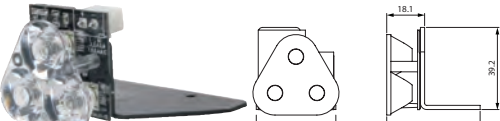
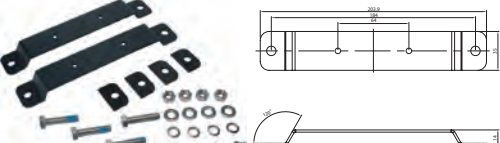
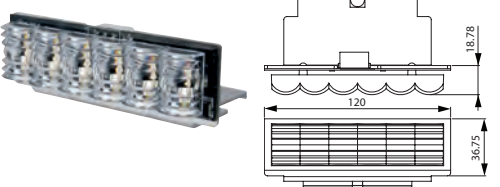
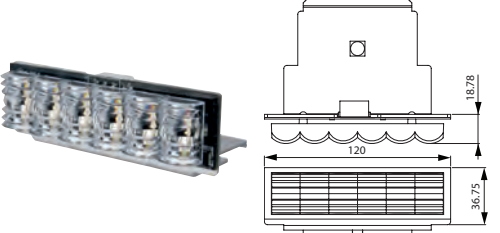
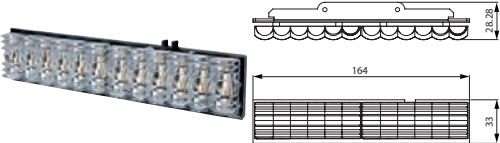

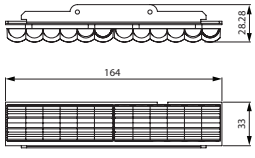
<b>171762 Switch Panel</b> Std pkg 1 Servicing: HC-CARGO 171760, 171761, 171849, 171850, 171851, 171852, 171853, 171909, 171910, 171911, 171912, 171913, 171914, 172094		Dim.: 134x39x23 mm Mount. hole size: 4 mm	Type/terminal: Flat Colour: Black Button colour: Black Material: Metal Switch: S1-S4 On/Off, S5 Shift
---	--	--	---

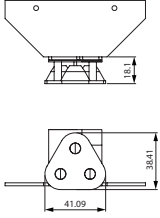
<b>171777 LED Flash, amber</b> Std pkg 1 Servicing: HC-CARGO 171760, 171761		Voltage: 12	Length: 119.9 mm Height: 39.9 mm Width: 18.8 mm	Bulb type: 6 LED Colour: Orange
---	--	-------------	---	------------------------------------

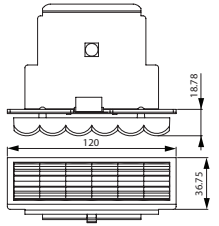
<b>171778 LED Corner Flash, orange</b> Std pkg 1 Servicing: HC-CARGO 171760, 171761		Voltage: 12	Length: 166 mm Height: 37 mm Width: 18.8 mm	Bulb type: 12 LED Colour: Orange
---	--	-------------	---	-------------------------------------

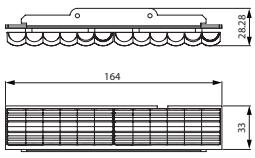
**ACCESSORIES - Lighting**

		EL. SPECIFICATIONS	DIMENSIONS	ADDITIONAL SPECIFICATIONS
<b>171779</b> LED Work Lamp	Std pkg 1	Servicing: HC-CARGO 171760, 170761		
		Voltage: 12	Length: 119.9 mm Height: 37 mm Width: 17.8 mm	Bulb type: 6 LED Colour: Transparent
<b>171780</b> LED Work Lamp	Std pkg 1	Servicing: HC-CARGO 171760, 171761		
		Voltage: 12	Length: 119.9 mm Height: 37 mm Width: 17.8 mm	Bulb type: 9 LED Colour: Transparent
<b>171781</b> LED Alley light	Std pkg 1	Servicing: HC-CARGO 171760, 171761, 171849, 171850, 171852, 171909, 171910, 171912		
		Voltage: 12	Length: 38 mm Height: 39.2 mm Width: 18.1 mm	Bulb type: 3 LED Colour: Transparent Approvals: SAE/ECE-R65 E-approval: Yes
<b>171855</b> Mounting Bracket for LED Micro Light Bar	Std pkg 1	Servicing: HC-CARGO 171854		
			Total length: 203.9 mm Height: 14 mm Dist. mount. holes: 64/184 mm Width: 35 mm	
<b>171856</b> LED Flash, amber	Std pkg 1	Servicing: HC-CARGO 171849, 171850, 171852, 171910, 171912		
		Voltage: 12	Length: 120 mm Height: 36.75 mm Width: 18.78 mm	Bulb type: 6 LED Colour: Orange Approvals: SAE/ECE-R65 E-approval: Yes
<b>171857</b> LED Flash, amber	Std pkg 1	Servicing: HC-CARGO 171851, 171853, 171911, 171913, 171914		
		Voltage: 24	Length: 120 mm Height: 36.75 mm Width: 18.78 mm	Bulb type: 6 LED Colour: Orange Approvals: SAE/ECE-R65 E-approval: Yes
<b>171858</b> LED Corner Flash, orange	Std pkg 1	Servicing: HC-CARGO 171849, 171850, 171852, 171910, 171912		
		Voltage: 12	Length: 164 mm Height: 33 mm Width: 28.28 mm	Bulb type: 12 LED Colour: Orange Approvals: SAE/ECE-R65 E-approval: Yes

EL. SPECIFICATIONS		DIMENSIONS	ADDITIONAL SPECIFICATIONS
<b>171859</b> LED Corner Flash, orange Std pkg 1 Servicing: HC-CARGO 171851, 171853, 171911, 171913, 171914			
		<b>Voltage:</b> 24 <b>Length:</b> 164 mm <b>Height:</b> 33 mm <b>Width:</b> 28.28 mm	<b>Bulb type:</b> 12 LED <b>Colour:</b> Orange <b>Approvals:</b> SAE/ECE-R65 <b>E-approval:</b> Yes
<b>171865</b> LED Alley light Std pkg 1 Servicing: HC-CARGO 171851, 171853, 171911, 171913, 171914			
		<b>Voltage:</b> 24 <b>Height:</b> 38.41 mm	<b>Bulb type:</b> 3 LED <b>Approvals:</b> SAE/ECE-R65 <b>E-approval:</b> Yes
<b>171915</b> LED Flash, blue Std pkg 1 Servicing: HC-CARGO 171909			
		<b>Voltage:</b> 12 <b>Length:</b> 120 mm <b>Height:</b> 36.75 mm <b>Width:</b> 18.78 mm	<b>Bulb type:</b> 6 LED <b>Colour:</b> Blue <b>Approvals:</b> SAE/ECE-R65 <b>E-approval:</b> Yes
<b>171916</b> LED Corner Flash Std pkg 1 Servicing: HC-CARGO 171909			
		<b>Voltage:</b> 12 <b>Length:</b> 164 mm <b>Height:</b> 33 mm <b>Width:</b> 28.28 mm	<b>Bulb type:</b> 12 LED <b>Colour:</b> Blue <b>Approvals:</b> SAE/ECE-R65 <b>E-approval:</b> Yes
<b>BEACON SOCKETS</b>			
<b>170292</b> Beacon Socket Std pkg 1			
<i>Rubber Body: HC-CARGO 171513. Coiled Cable: HC-CARGO 171518. Socket: HC-CARGO 180376.</i>			
		<b>Length:</b> 100 mm	<b>Material:</b> Steel <b>Mount.:</b> Weld <b>Bracket:</b> Straight <b>Socket:</b> DIN 72591 1 terminal
<b>170387</b> Beacon Socket Std pkg 1			
<i>Rubber Body: HC-CARGO 171513. Coiled Cable: HC-CARGO 171518. Socket: HC-CARGO 180376.</i>			
		<b>Length:</b> 130 mm	<b>Material:</b> Electro galvanized <b>Mount.:</b> w/ nuts <b>Bracket:</b> Straight <b>Socket:</b> DIN 72591 1 terminal
<b>170405</b> Beacon Socket Std pkg 1			
<i>Rubber Body: HC-CARGO 171513. Coiled Cable: HC-CARGO 171518. Socket: HC-CARGO 180377.</i>			
		<b>Length:</b> 108 mm <b>Mount. hole size:</b> 10 mm	<b>Material:</b> Galvanized steel <b>Mount.:</b> Flat <b>Bracket:</b> Angled 90° <b>Socket:</b> DIN 72591 2 terminal

EL. SPECIFICATIONS		DIMENSIONS	ADDITIONAL SPECIFICATIONS
<b>170406 Beacon Socket</b> Std pkg 1 <i>Rubber Body: HC-CARGO 171513. Coiled Cable: HC-CARGO 171518. Socket: HC-CARGO 180377.</i>			<b>Length:</b> 170 mm  <b>Material:</b> Galvanized steel <b>Mount.:</b> 2 screws <b>Bracket:</b> Adjustable <b>Socket:</b> DIN 72591 2 terminal
<b>170419 Beacon Socket</b> Std pkg 1 <i>Rubber Body: HC-CARGO 171513. Coiled Cable: HC-CARGO 171518. Socket: HC-CARGO 180377.</i>			<b>Length:</b> 260 mm  <b>Material:</b> Galvanized steel <b>Mount.:</b> Vertical <b>Bracket:</b> Angled 90° <b>Socket:</b> DIN 72591 2 terminal
<b>170460 Beacon Socket</b> Std pkg 1 <i>Servicing: John Deere tractor etc - Visit <a href="http://www.hc-cargo.com">www.hc-cargo.com</a> for further information.</i> <i>Rubber Body: HC-CARGO 171513. Coiled Cable: HC-CARGO 171518. Socket: HC-CARGO 180377.</i>			<b>Length:</b> 160 mm  <b>Material:</b> Galvanized steel <b>Mount.:</b> 1 bolt <b>Bracket:</b> Angled <b>Socket:</b> DIN 72591 2 terminal
<b>170531 Extension</b> Std pkg 1 <i>Rubber Body: HC-CARGO 171513. Coiled Cable: HC-CARGO 171518. Socket: HC-CARGO 180377.</i>			<b>Length:</b> 500 mm <b>Mount. hole size:</b> 24 mm  <b>Material:</b> Galvanized steel <b>Bracket:</b> Straight <b>Socket:</b> DIN 72591 2 terminal
<b>170537 Beacon Socket</b> Std pkg 1 <i>Rubber Body: HC-CARGO 171513. Coiled Cable: HC-CARGO 171518. Socket: HC-CARGO 180377.</i>			<b>Length:</b> 150 mm  <b>Material:</b> Electro galvanized <b>Mount.:</b> Vertical <b>Bracket:</b> Straight <b>Socket:</b> DIN 72591 2 terminal
<b>170562 Beacon Socket</b> Std pkg 1 <i>Rubber Body: HC-CARGO 171513. Coiled Cable: HC-CARGO 171518. Socket: HC-CARGO 180377.</i>			<b>Length:</b> 150 mm  <b>Material:</b> Galvanized steel <b>Mount.:</b> 2 screws <b>Bracket:</b> Angled 90° <b>Socket:</b> DIN 72591 2 terminal
<b>170788 Beacon Socket</b> Std pkg 1 <i>Rubber Body: HC-CARGO 171513. Coiled Cable: HC-CARGO 171518. Socket: HC-CARGO 180376.</i>			<b>Length:</b> 102 mm <b>Mount. hole size:</b> 10 mm  <b>Material:</b> Electro galvanized <b>Mount.:</b> Flat <b>Bracket:</b> Angled <b>Socket:</b> DIN 72591 1 terminal



EL. SPECIFICATIONS	DIMENSIONS	ADDITIONAL SPECIFICATIONS
<b>170789 Beacon Socket</b> Std pkg 1		
<i>Rubber Body: HC-CARGO 171513. Coiled Cable: HC-CARGO 171518. Socket: HC-CARGO 180376.</i>		
	Length: 180 mm	Material: Electro galvanized Bracket: Adjustable Socket: DIN 72591 1 terminal
<b>171576 Beacon Socket</b> Std pkg 1 Servicing: IH/CASE - Visit <a href="http://www.hc-cargo.com">www.hc-cargo.com</a> for further information.		
<i>Rubber Body: HC-CARGO 171513. Coiled Cable: HC-CARGO 171518. Socket: HC-CARGO 180377.</i>		
	Length: 190 mm	Material: Steel Mount.: Vertical Bracket: Straight Socket: DIN 72591 2 terminal
<h3>SPARE PARTS</h3>		
<b>171513 Rubber Body for Beacon Socket</b> Std pkg 10 Servicing: HC-CARGO 170292, 170387, 170405, 170788, 170406, 170562, 170789, 170537, 171576, 170419, 170460		
		Material: Rubber
<b>171518 Coiled Cable</b> Std pkg 1 Servicing: HC-CARGO 170292, 170387, 170405, 170788, 170406, 170562, 170789, 170537, 171576, 170419, 170460		
	Working length: 2 m	Plug type: Cigar plug Plug: 2 ISO norm: 4165
<b>171562 Coiled Cable</b> Std pkg 1 Servicing: HC-CARGO 171494, 171495		
	Working length: 3 m	Plug type: Cigar plug
<b>180376 DIN Socket</b> Std pkg 5 Servicing: HC-CARGO 170292, 170387, 170788, 170789		
<i>Also used in sockets for beacons.</i>		
	ID/mount. hole: 18.5 mm	Material: Brass No./poles: 1 Connection: Terminal Male/female: Female DIN norm: 72591
<b>180377 DIN Socket</b> Std pkg 5 Servicing: HC-CARGO 170405, 170406, 170419, 170460, 170531, 170537, 170562, 171576		
<i>Also used in sockets for beacons.</i>		
	ID/mount. hole: 18.5 mm	Material: Brass No./poles: 2 Connection: Terminal Male/female: Female DIN norm: 72591

## WORK LAMPS CONVENTIONAL

### 170093 Work Lamp

Std pkg 1

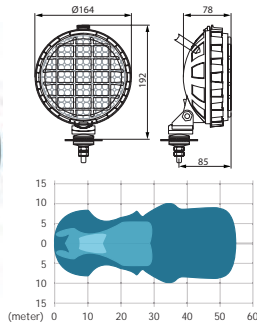

Bulb incl.: No

 Dim.: 164x192x85 mm  
 Light aperture:  
 136 mm

 Bulb type: H3  
 Socket type: PK22s  
 Colour: Black  
 Material/dome: Glass  
 Material/house: Plastic  
**Reflector system:** Single  
 Shape: Round  
 Switch: w/  
 Mount. bracket: Single bolt fixing  
 Grill: w/  
 Handle: w/

### 170237 Work Lamp

Std pkg 1

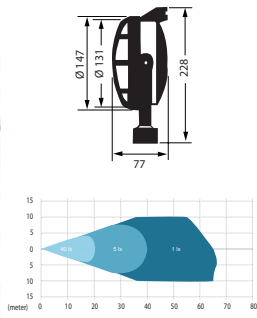

Bulb incl.: No

 Dim.: 228x77 mm  
 Light aperture:  
 131 mm

 Bulb type: H3  
 Socket type: PK22s  
 Colour: Black  
 Material/dome: Glass  
 Material/house: Shockproof plastic  
**Reflector system:** Single  
 Shape: Round  
 Switch: w/  
 Mount. bracket: U-bracket w/ 2 holes  
 Grill: w/  
 Handle: w/

### 170313 Work Lamp

Std pkg 1

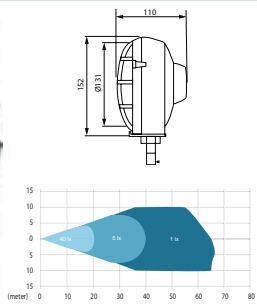

Bulb incl.: No

 Dim.: 152x110 mm  
 Light aperture:  
 131 mm

 Bulb type: H3  
 Socket type: PK22s  
 Colour: Black  
 Material/dome: Glass  
 Material/house: Shockproof plastic  
**Reflector system:** Single  
 Shape: Round  
 Switch: w/o  
 Mount. bracket: Single bolt fixing  
 Grill: w/  
 Handle: w/o

### 170488 Work Lamp

Std pkg 1

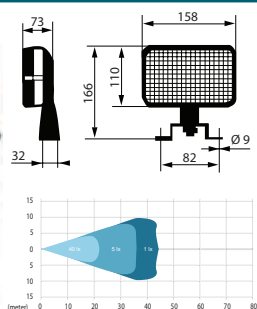

Bulb incl.: No

 Dim.: 166x158x73 mm  
 Light aperture:  
 155x104 mm

 Bulb type: H3  
 Socket type: PK22s  
 Colour: Black  
 Material/dome: Glass  
 Material/house: Shockproof plastic  
**Reflector system:** Single  
 Shape: Rectangular  
 Switch: w/o  
 Mount. bracket: U-bracket w/ 4 holes  
 Grill: w/  
 Handle: w/o

### 170489 Work Lamp

Std pkg 1

w/o U-bracket.

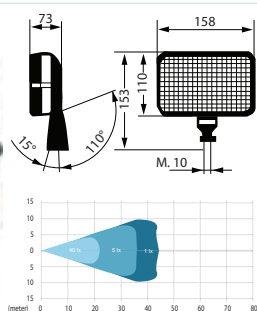

Bulb incl.: No

 Dim.: 158x153x73 mm  
 Light aperture:  
 155x104 mm

 Bulb type: H3  
 Socket type: PK22s  
 Colour: Black  
 Material/dome: Glass  
 Material/house: Shockproof plastic  
**Reflector system:** Single  
 Shape: Rectangular  
 Switch: w/o  
 Mount. bracket: Single bolt fixing  
 Grill: w/  
 Handle: w/o

**170534 Work Lamp**

Std pkg 1

Bracket: HC-CARGO 171936.

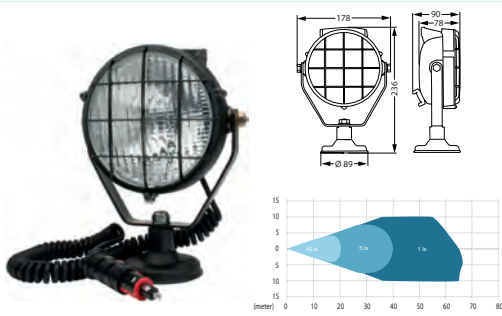

Bulb incl.: No

Dim.: 178x236x90 mm  
Coiled cable: 2000 mm  
Light aperture:  
130 mm

Bulb type: H3  
Socket type: PK22s  
Colour: Black  
Material/dome: Glass  
Material/house: Polyamid  
Shape: Round  
Switch: w/  
Grill: w/  
Magnet base: w/  
Lighter plug incl.: Yes  
Handle: w/  
Coiled cable incl.: Yes

**170851 Work Lamp**

Std pkg 1

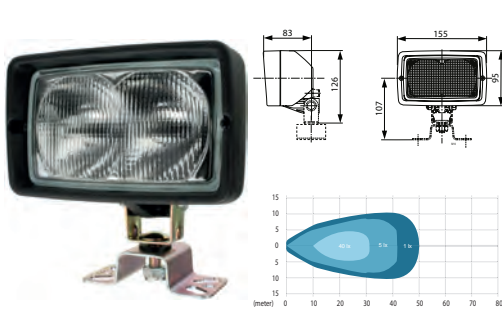

Bulb incl.: No

Dim.: 155x95x83 mm  
Light aperture:  
136x88 mm

Bulb type: H3  
Socket type: PK22s  
Colour: Black  
Material/dome: Glass  
Material/house: Shockproof plastic  
Reflector system: Dual  
Shape: Rectangular  
Switch: w/o  
Mount. bracket: U-bracket w/ 6 holes  
Handle: w/o  
Tightness norm: IP 54  
Alternativ no. 170980

**170857 Work Lamp**

Std pkg 1

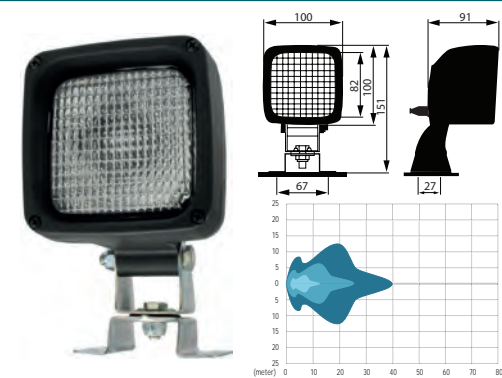

Bulb incl.: No

Dim.: 100x151x91 mm  
Light aperture:  
73x73 mm

Bulb type: H3  
Socket type: PK22s  
Colour: Black  
Material/dome: Glass  
Material/house: Shockproof plastic  
Reflector system: Free form  
Shape: Square  
Mount.: Upright/pendant  
Switch: w/o  
Mount. bracket: U-bracket w/ 4 holes  
Grill: w/o  
Handle: w/o  
2 poles: w/  
Tightness norm: IP 66  
Alternativ no. 170982

**170859 Work Lamp**

Std pkg 1

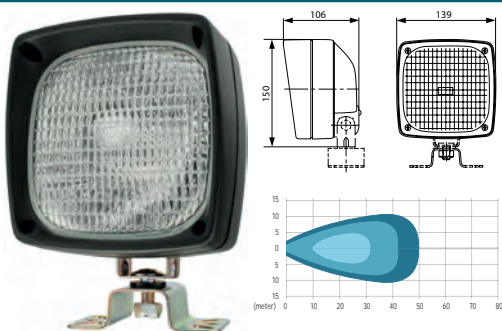

Bulb incl.: No

Dim.: 139x150x106 mm  
Light aperture:  
123x123 mm

Bulb type: H3  
Socket type: PK22s  
Colour: Black  
Material/dome: Glass  
Material/house: Shockproof plastic  
Reflector system: Free form  
Shape: Square  
Switch: w/o  
Mount. bracket: U-bracket w/ 6 holes  
Handle: w/o

**170970 Work Lamp**

Std pkg 1

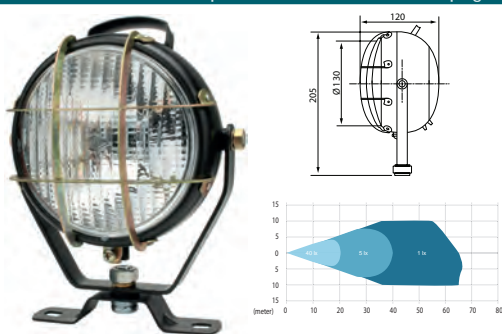

Bulb incl.: No

Dim.: 205x120 mm  
Light aperture:  
130 mm

Bulb type: H3  
Socket type: PK22s  
Colour: Black  
Material/dome: Glass  
Material/house: Metal  
Shape: Round  
Switch: w/  
Mount. bracket: U-bracket w/ 2 holes  
Grill: w/  
Handle: w/

**170979 Work Lamp** Std pkg 1

External plug for flat plug connection.

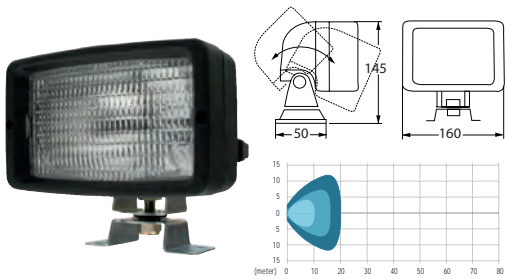

Bulb incl.: No

Dim.: 160x145x50 mm  
Light aperture:  
123x72 mm

Bulb type: H3  
Socket type: PK22s  
Colour: Black  
Material/dome: Glass  
Material/house: Shockproof plastic  
Shape: Rectangular  
Mount.: Flat  
Switch: w/o  
Mount. bracket: U-bracket w/ 4 holes  
Grill: w/o  
Handle: w/o

**170980 Work Lamp** Std pkg 1

Servicing: Universal - Visit [www.hc-cargo.com](http://www.hc-cargo.com) for further information.

External plug for flat plug connection.

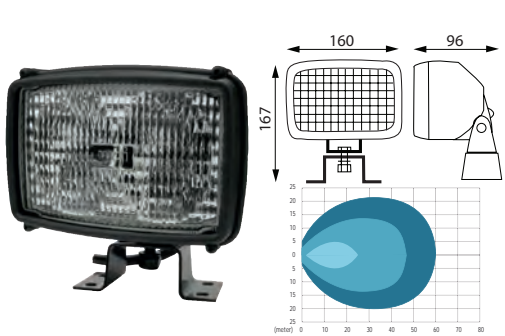

Bulb incl.: No

Dim.: 160x167x96 mm  
Light aperture:  
123x78 mm

Bulb type: H3  
Socket type: PK22s  
Colour: Black  
Material/dome: Glass  
Material/house: Shockproof plastic  
Reflector system: Dual  
Shape: Rectangular  
Mount.: Flat  
Switch: w/o  
Mount. bracket: U-bracket w/ 4 holes  
Grill: w/o  
Handle: w/o  
2 poles: w/o  
Tightness norm: IP 65  
Alternativ no. 170851

**170981 Work Lamp** Std pkg 1

External plug for flat plug connection.

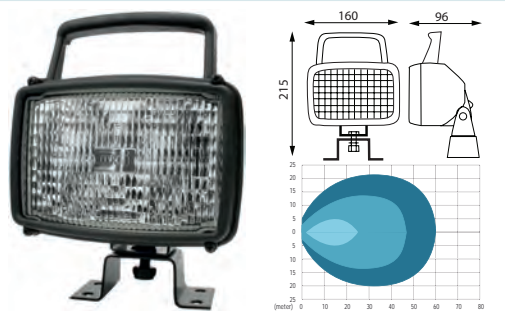

Bulb incl.: No

Dim.: 160x215x96 mm  
Light aperture:  
123x78 mm

Bulb type: H3  
Socket type: PK22s  
Colour: Black  
Material/dome: Glass  
Material/house: Shockproof plastic  
Reflector system: Dual  
Shape: Rectangular  
Mount.: Flat  
Switch: w/  
Mount. bracket: U-bracket w/ 4 holes  
Handle: w/  
2 poles: w/o  
Tightness norm: IP 65

**170982 Work Lamp** Std pkg 1

External plug for 6.3 mm flat plug connection.

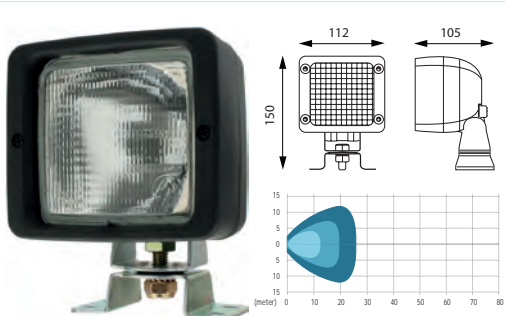

Bulb incl.: No

Dim.: 112x150x105 mm  
Light aperture:  
73x73 mm

Bulb type: H3  
Socket type: PK22s  
Colour: Black  
Material/dome: Glass  
Material/house: Shockproof plastic  
Reflector system: Single  
Shape: Square  
Mount.: Flat  
Switch: w/o  
Mount. bracket: U-bracket w/ 4 holes  
Grill: w/o  
Handle: w/o  
Tightness norm: IP 67  
Alternativ no. 170857

**170983 Work Lamp** Std pkg 1









External plug for 6.3 mm flat plug connection.

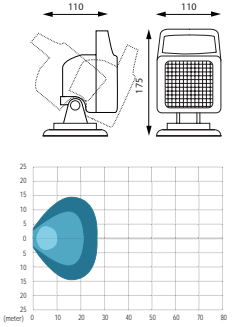

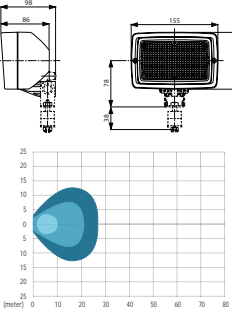
Bulb incl.: No

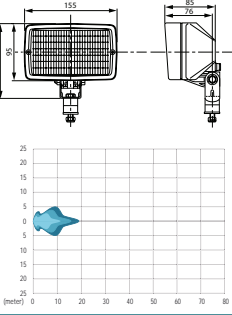
Dim.: 112x200x105 mm  
Light aperture:  
73x73 mm

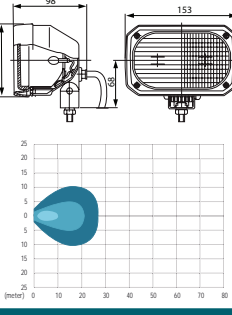
Bulb type: H3  
Socket type: PK22s  
Colour: Black  
Material/dome: Glass  
Material/house: Shockproof plastic  
Reflector system: Single  
Shape: Square  
Mount.: Flat  
Switch: w/  
Mount. bracket: U-bracket w/ 4 holes  
Handle: w/  
Tightness norm: IP 65

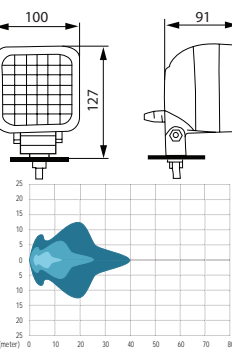
170984 Work Lamp		Std pkg 1	
<i>External plug for 6.3 mm flat plug connection.</i>			
 	<p>Bulb incl.: No</p>	<p>Dim.: 110x175x110 mm Coiled cable: 2000 mm Light aperture: 73x73 mm</p>	<p>Bulb type: H3 Socket type: PK22s Colour: Black Material/dome: Glass Material/house: Shockproof plastic Reflector system: Single Shape: Square Switch: w/ Magnet base: w/ Lighter plug incl.: Yes Handle: w/ 2 poles: w/ Coiled cable incl.: Yes</p>
171167 Work Lamp		Std pkg 1	
 	<p>Bulb incl.: No</p>	<p>Dim.: 155x95x86 mm Light aperture: 136x88 mm</p>	<p>Bulb type: H3 Socket type: PK22s Colour: Black Material/dome: Glass Material/house: Shockproof plastic Reflector system: Dual Shape: Rectangular Switch: w/o Mount. bracket: U-bracket w/ 6 holes Handle: w/o Tightness norm: IP 54</p>
171168 Work Lamp		Std pkg 1	
 	<p>Bulb incl.: No</p>	<p>Dim.: 155x126x85 mm Light aperture: 123x72 mm</p>	<p>Bulb type: H3 Socket type: PK22s Inclination/downwards: 40° Inclination/upwards: 100° Colour: Black Material/dome: Glass Material/house: Shockproof plastic Reflector system: Single Shape: Rectangular Switch: w/o Grill: w/o Handle: w/o</p>
171347 Work Lamp		Std pkg 1	
 	<p>Bulb incl.: No</p>	<p>Dim.: 153x96x98 mm Light aperture: 124x72 mm</p>	<p>Bulb type: H3 Socket type: PK22s Colour: Black Material/dome: Glass Material/house: Shockproof plastic Reflector system: Single Shape: Rectangular Mount.: Upright/pendant Switch: w/o Mount. bracket: Single bolt fixing Grill: w/o Handle: w/o</p>
171449 Work Lamp		Std pkg 1	
<i>External plug for multiplug connection.</i>			
 	<p>Bulb incl.: No</p>	<p>Dim.: 100x127x91 mm Light aperture: 73x73 mm</p>	<p>Bulb type: H3 Socket type: PK22s Colour: Black Material/dome: Shockproof plastic Material/house: Glass Reflector system: Single Shape: Square Mount.: Upright/pendant Switch: w/o Mount. bracket: Single bolt fixing Grill: w/o Handle: w/o 2 poles: w/ Tightness norm: IP 66</p>

171564 Work Lamp

Std pkg 1

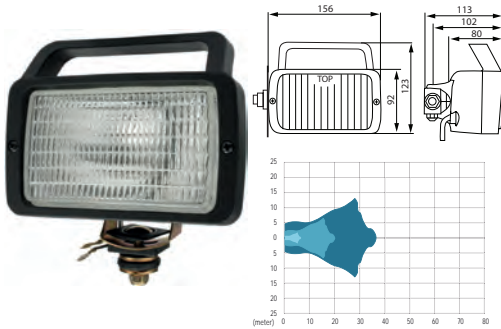

Bulb incl.: No

Dim.: 156x117x85 mm  
Light aperture:  
120x68 mm

Bulb type: H3  
Socket type: PK22s  
Material/dome: Shockproof plastic  
Material/house: Glass  
Shape: Rectangular  
Switch: w/  
Grill: w/o  
Handle: w/  
Tightness norm: IP 55

171566 Work Lamp

Std pkg 1

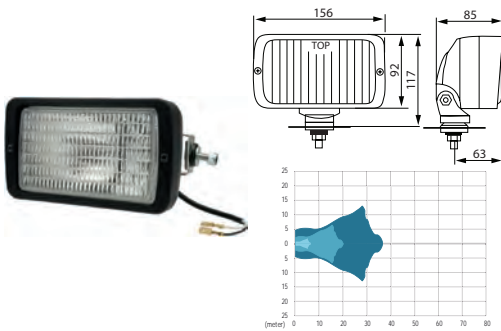

Bulb incl.: No

Dim.: 156x123x113 mm  
Light aperture:  
123x70 mm

Bulb type: H3  
Socket type: PK22s  
Inclination/downwards: 180°  
Inclination/upwards: 180°  
Inclination/sideways: 105°  
Colour: Black  
Material/dome: Glass  
Material/house: Shockproof plastic  
Shape: Rectangular  
Mount.: Sidemounted  
Switch: w/o  
Grill: w/o  
Handle: w/o  
Tightness norm: IP 55

171619 Work Lamp

Std pkg 1



Bulb incl.: No

Dim.: 160x165x90 mm  
Light aperture:  
77x130 mm

Bulb type: H3  
Socket type: PK22s  
Colour: Black  
Material/dome: Glass  
Material/house: Shockproof plastic  
Reflector system: Single  
Model: Compact 5000  
Shape: Oval  
Switch: w/o  
Mount. bracket: 4 holes  
2 poles: w/

171620 Work Lamp

Std pkg 1



Bulb incl.: No

Dim.: 160x165x90 mm  
Light aperture:  
77x130 mm

Bulb type: H3  
Socket type: PK22s  
Colour: Black  
Material/dome: Shockproof plastic  
Reflector system: Dual  
Model: Twin beam 5000  
Shape: Oval  
Switch: w/o  
Mount. bracket: 4 holes  
2 poles: w/

171745 Work Lamp

Std pkg 1



Bulb incl.: No

Dim.: 117x84x95 mm  
Light aperture: 69 mm

Bulb type: H3  
Socket type: PK22s  
Colour: Black  
Material/dome: Glass  
Material/house: ABS plastic  
Reflector system: Single  
Shape: Round  
Switch: w/o  
Mount. bracket: U-bracket w/ 1 bolt  
Handle: w/o  
2 poles: w/  
Tightness norm: IP 66

**171782 Work Lamp**

Std pkg 1

w/ Deutsch multiconnection.

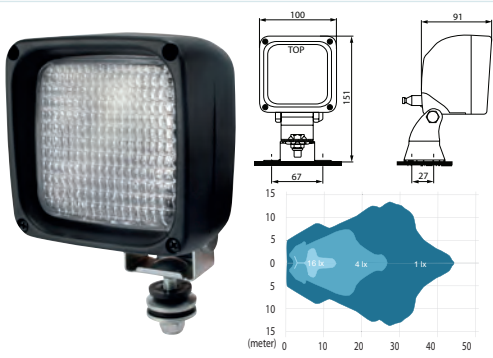

Bulb incl.: No

Dim.: 100x151x91 mm  
Light aperture:  
73x73 mm

Bulb type: H3  
Socket type: PK22s  
Colour: Black  
Material/dome: Glass  
Material/house: Shockproof plastic  
Reflector system: Single  
Shape: Square  
Mount.: Upright/pendant  
Switch: w/  
Mount. bracket: Single bolt fixing  
Handle: w/o  
2 poles: w/  
Tightness norm: IP 66

**171845 Work Lamp**

Std pkg 1

Servicing: Marine - Visit [www.hc-cargo.com](http://www.hc-cargo.com) for further information.

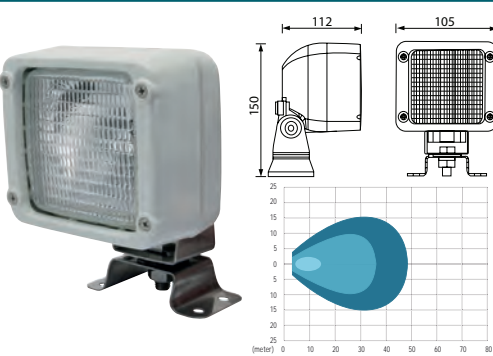

Bulb incl.: No

Dim.: 105x150x112 mm

Bulb type: H3  
Socket type: PK22s  
Colour: White  
Material/dome: Glass  
Shape: Square  
Mount.: Single bolt fixing  
Switch: w/o  
Mount. bracket: Mounting bracket  
Tightness norm: IP 65

**171848 Work Lamp**

Std pkg 1



Bulb incl.: No

Dim.: 123x172x71 mm

Bulb type: H3  
Socket type: PK22s  
Colour: Black  
Material/dome: Glass  
Material/house: PVC  
Shape: Round  
Switch: w/o  
Mount. bracket: Single bolt fixing

**171936 Magnetic base for Lamps**

Std pkg 1

Servicing: HC-CARGO 170534. 171375



Coiled cable: 2000 mm

Colour: Black  
Mount.: Magnetic  
Mount. bracket: U-bracket w/ 2 holes  
Magnet base: w/  
Lighter plug incl.: Yes  
Coiled cable incl.: Yes

**WORK LAMPS LED**

**171640 LED Work Lamp**

Std pkg 1

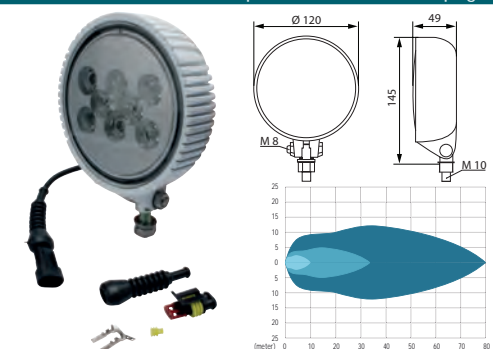

Voltage: 9-30  
Watt: 24  
Lumen: 1440

Dim.: 120x145x49 mm  
Cable length: 150 mm  
Light aperture:  
130 mm

Bulb type: 8 LED  
Colour: Grey  
Material/house: Aluminium  
Shape: Round  
Switch: w/o  
Mount. bracket: 1 nut  
Magnet base: w/o  
Handle: w/o  
Beam shape: Spot  
2 poles: w/  
Tightness norm: IP 69K  
Approvals: EMC/ADR/GGVS

**171671 LED Work Lamp** Std pkg 1

4 diodes. Black cable negative.

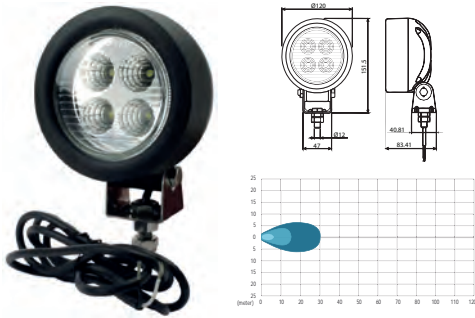

Voltage: 10-64  
Watt: 8.5  
Candela: 800  
Kelvin: 5000-6500  
Lumen: 450

Dim.: 151.5x120x83.41 mm  
Cable length: 2000 mm  
Light aperture: 100 mm

Bulb type: 4 LED  
Colour: Black  
Material/dome: Shockproof plastic  
Material/house: Shock thermo plastic  
Shape: Round  
Switch: w/o  
Mount. bracket: 1 nut  
Magnet base: w/o  
Handle: w/o  
Beam shape: Spot  
Tightness norm: IP 66  
Approvals: CE

**171672 LED Work Lamp** Std pkg 1

4 diodes.

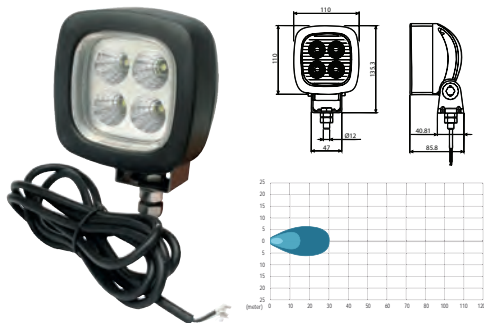

Voltage: 10-64  
Watt: 8.5  
Candela: 800  
Kelvin: 5000-6500  
Lumen: 450

Dim.: 135.5x110x85.8 mm  
Cable length: 2000 mm  
Light aperture: 100 mm

Bulb type: 4 LED  
Colour: Black  
Material/dome: Shockproof plastic  
Material/house: Shockproof plastic  
Shape: Square  
Switch: w/o  
Mount. bracket: 1 nut  
Beam shape: Spot  
Tightness norm: IP 66  
Approvals: CE

**171723 LED Work Lamp** Std pkg 1

Servicing: Marine - Visit [www.hc-cargo.com](http://www.hc-cargo.com) for further information.

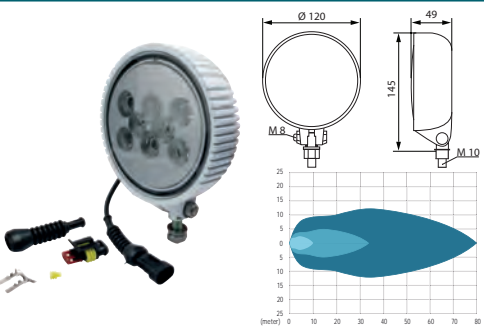

Voltage: 9-30  
Watt: 24  
Lumen: 1440

Dim.: 120x145x49 mm  
Cable length: 150 mm  
Light aperture: 130 mm

Bulb type: 8 LED  
Colour: White  
Material/house: Aluminium  
Shape: Round  
Switch: w/o  
Mount. bracket: 1 nut  
Beam shape: Spot  
2 poles: w/  
Tightness norm: IP 69K  
Approvals: EMC/ADR/GGVS

**171727 LED Work Lamp** Std pkg 1

Grey lead +, white lead -.

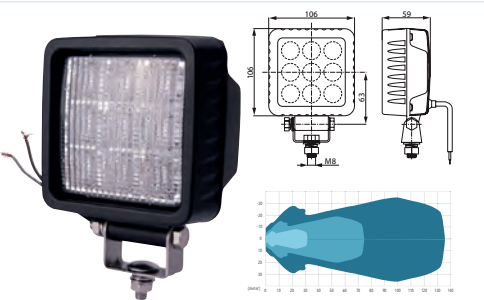

Voltage: 9-33  
Watt: 9  
Kelvin: 5000-5500  
Lumen: 900

Dim.: 106x106x59 mm  
Cable length: 450 mm  
Light aperture: 85x85 mm

Bulb type: 9 LED  
Colour: Black  
Material/dome: Shockproof plastic  
Material/house: Cast aluminum  
Shape: Square  
Switch: w/o  
Mount. bracket: U-bracket w/ 1 bolt  
Handle: w/o  
Beam shape: Flood  
Tightness norm: IP 67  
Approvals: CE/EMC

**171751 LED Work Lamp** Std pkg 1

White cable to ground. Black cable to +12/36 V.



Voltage: 9-36  
Watt: 19  
Candela: 2210  
Lumen: 1200

Dim.: 104.9x162.3x54.2 mm  
Cable length: 280 mm  
Light aperture: 100x100 mm

Bulb type: 6 LED  
Colour: Black  
Material/dome: Polycarbonate  
Material/house: Cast aluminum  
Shape: Square  
Switch: w/o  
Mount. bracket: U-bracket w/ 1 bolt  
Handle: w/o  
Beam shape: Flood  
Tightness norm: IP 69K  
Approvals: CE/EMC



171752 LED Work Lamp		Std pkg 1					
<p>White cable to ground. Black cable to +12/36 V.</p>		<p>Voltage: 12-36 Watt: 20 Candela: 3600 Lumen: 1800</p>		<p>Dim.: 125x176x60.1 mm Cable length: 280 mm Light aperture: 93x83 mm</p>		<p>Bulb type: 9 LED Colour: Black Material/dome: Polycarbonate Material/house: Cast aluminum Shape: Square Switch: w/o Mount. bracket: U-bracket w/ 1 bolt Beam shape: Flood Tightness norm: IP 69K Approvals: CE/EMC</p>	
<p>171753 LED Work Lamp</p>		<p>Std pkg 1</p> <p>Voltage: 11-70 Watt: 22 Lumen: 1000</p>		<p>Dim.: 110.4x184x67 mm Cable length: 1200 mm Light aperture: 88x88 mm</p>		<p>Bulb type: 6 LED Colour: Black Material/house: Cast aluminum Shape: Square Switch: w/o Mount. bracket: Single bolt fixing Beam shape: Flood Tightness norm: IP 67 Approvals: EMC</p>	
<p>171755 LED Work Lamp</p>		<p>Std pkg 1</p> <p>Voltage: 11-70 Watt: 27 Lumen: 1900</p>		<p>Dim.: 110.4x184x67 mm Cable length: 1200 mm Light aperture: 88x88 mm</p>		<p>Bulb type: 6 LED Colour: Black Material/house: Cast aluminum Shape: Square Switch: w/o Mount. bracket: Single bolt fixing Beam shape: Flood Tightness norm: IP 67 Approvals: EMC E-approval: No</p>	
<p>171774 LED Work Lamp</p>		<p>Std pkg 1</p> <p>Voltage: 11-30 Watt: 40 Lumen: 3200</p>		<p>Dim.: 112x112x49 mm Cable length: 150 mm</p>		<p>Bulb type: 12 LED Colour: Silver Material/house: Cast aluminum Shape: Square Switch: w/o Mount. bracket: U-bracket w/ 1 bolt Beam shape: Flood 2 poles: w/ Tightness norm: IP 69K Approvals: EMC/ADR/GGVS</p>	
<p>171775 LED Work Lamp</p>		<p>Std pkg 1</p> <p>Voltage: 11-30 Watt: 36 Lumen: 1800</p>		<p>Dim.: 112x112x49 mm Cable length: 150 mm</p>		<p>Bulb type: 12 LED Colour: Silver Material/house: Cast aluminum Shape: Square Switch: w/o Mount. bracket: U-bracket w/ 1 bolt Beam shape: Flood 2 poles: w/ Tightness norm: IP 69K Approvals: EMC/ADR/GGVS</p>	

**171811 LED Work Lamp**

Std pkg 1

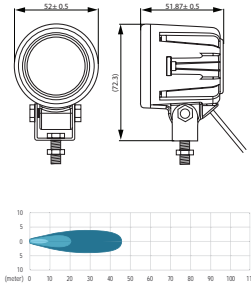

Voltage: 10-80  
Watt: 5  
Candela: 2000  
Kelvin: 5000-6500  
Lumen: 600

Dim.: 72.3x52x51.87 mm  
Cable length: 300 mm  
Light aperture: 35 mm

Bulb type: 1 LED  
Inclination/downwards: Yes  
Inclination/upwards: Yes  
Colour: Black  
Material/dome: Plastic  
Material/house: Aluminium  
Shape: Round  
Switch: w/o  
Mount. bracket: U-bracket w/ 1 bolt  
Beam shape: Spot  
Tightness norm: IP 66  
Approvals: CE

**171838 LED Work Lamp**

Std pkg 1

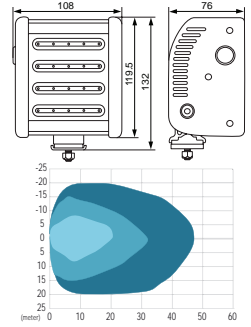

Voltage: 9-36  
Amp: 1.2/2.5  
Watt: 28-30  
Lumen: 3000

Dim.: 132x108x76 mm  
Cable length: 150 mm

Bulb type: 20 LED  
Colour: Black  
Material/dome: Polycarbonate  
Material/house: Aluminium  
Shape: Square  
Switch: w/o  
Mount. bracket: Single bolt fixing  
Beam shape: Flood  
2 poles: w/  
Tightness norm: IP 67  
Approvals: CE/EMC

**171846 LED Work Lamp**

Std pkg 1

2 pin AMP connector.

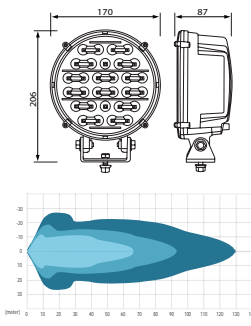

Voltage: 9-36  
Amp: 6/3  
Watt: 67.5  
Lumen: 5400

Dim.: 170x206x87 mm  
Cable length: 450 mm

Bulb type: 30 LED  
Inclination/downwards: 45°  
Inclination/upwards: 45°  
Colour: Black  
Material/dome: Polycarbonate  
Material/house: Aluminium  
Shape: Round  
Switch: w/o  
Mount. bracket: U-bracket w/ 1 bolt  
Beam shape: Spot  
2 poles: w/  
Tightness norm: IP 67  
Approvals: SAE/CE

**171847 LED Work Lamp**

Std pkg 1

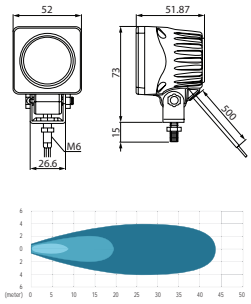

Voltage: 10-80  
Amp: 0.3  
Watt: 5  
Candela: 2000  
Kelvin: 5000-6500  
Lumen: 600

Dim.: 52x51.9x72.3 mm  
Cable length: 500 mm

Bulb type: 1 LED  
Inclination/downwards: Yes  
Inclination/upwards: Yes  
Colour: Black  
Shape: Square  
Switch: w/o  
Beam shape: Spot  
Tightness norm: IP 67  
Approvals: CE

**171938 LED Work Lamp**



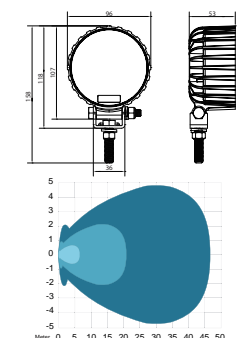





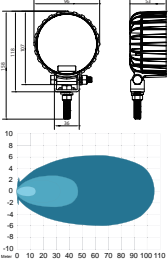

Std pkg 1

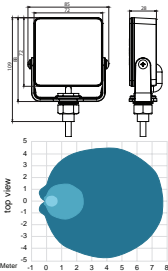

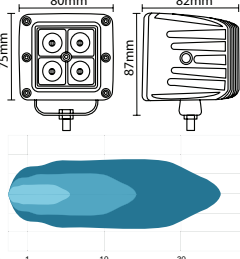
Voltage: 9-50  
Amp: <0.55  
Watt: 10.8  
Lumen: 900

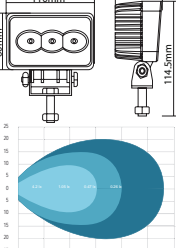
Dim.: 96x118x53 mm  
Cable length: 380 mm  
Light aperture: 90 mm

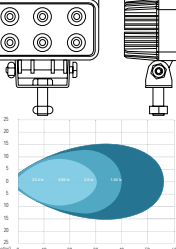
Bulb type: 4 LED  
Colour: Black  
Material/dome: Polycarbonate  
Material/house: Aluminium  
Shape: Round  
Switch: w/o  
Mount. bracket: 1 bolt  
Beam shape: Flood  
Tightness norm: IP 68  
Approvals: CE/EMC

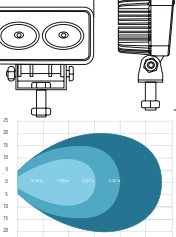
		EL. SPECIFICATIONS	DIMENSIONS	ADDITIONAL SPECIFICATIONS
<b>171939 LED Work Lamp</b>		<b>Std pkg 1</b>		
		Voltage: 9-50 Amp: <0.65 Watt: 11 Lumen: 900	Dim.: 96x118 mm Cable length: 380 mm Light aperture: 90 mm	Bulb type: 4 LED Colour: Black Material/dome: Polycarbonate Material/house: Aluminium Shape: Round Switch: w/o Mount. bracket: 1 bolt Beam shape: Spot Tightness norm: IP 68 Approvals: CE/EMC
<b>171940 LED Work Lamp</b>		<b>Std pkg 1</b>		
		Voltage: 12-24 Amp: 0.37 Watt: 7.5 Lumen: 300	Dim.: 88x85 mm Cable length: 380 mm Light aperture: 72 mm	Bulb type: 4 LED Material/dome: Polycarbonate Material/house: Aluminium Shape: Square Switch: w/o Mount. bracket: U-bracket w/ 1 bolt Beam shape: Flood Tightness norm: IP 67 Approvals: CE
<b>171944 LED Work Lamp</b>		<b>Std pkg 1</b>		
		Voltage: 10-30 Watt: 16 Kelvin: 6000 Lumen: 800	Dim.: 87x80x75 mm Cable length: 400 mm	Bulb type: 4 LED Colour: Black Material/ bracket: Stainless steel Material/dome: Polycarbonate Material/house: Cast aluminum Shape: Square Mount.: Cable Switch: w/o Beam shape: Flood Tightness norm: IP 67 Approvals: CE/EMC
<b>171945 LED Work Lamp</b>		<b>Std pkg 1</b>		
		Voltage: 10-30 Watt: 9 Kelvin: 6000 Lumen: 600	Dim.: 60x110x56 mm Cable length: 400 mm	Bulb type: 3 LED Colour: Black Material/ bracket: Stainless steel Material/dome: Polycarbonate Material/house: Cast aluminum Shape: Rectangular Mount.: Cable Switch: w/o Beam shape: Flood Tightness norm: IP 67 Approvals: CE/EMC
<b>171946 LED Work Lamp</b>		<b>Std pkg 1</b>		
		Voltage: 10-30 Watt: 18 Kelvin: 6000 Lumen: 1200	Dim.: 60x110x56 mm Cable length: 400 mm	Bulb type: 6 LED Colour: Black Material/ bracket: Stainless steel Material/dome: Polycarbonate Material/house: Cast aluminum Shape: Rectangular Mount.: Cable Switch: w/o Beam shape: Flood Tightness norm: IP 67 Approvals: CE
<b>171947 LED Work Lamp</b>		<b>Std pkg 1</b>		
		Voltage: 10-30 Watt: 20 Kelvin: 6000 Lumen: 1600	Dim.: 60x110x56 mm Cable length: 400 mm	Bulb type: 2 LED Colour: Black Material/ bracket: Stainless steel Material/dome: Polycarbonate Material/house: Cast aluminum Shape: Rectangular Mount.: Cable Switch: w/o Beam shape: Flood Tightness norm: IP 67 Approvals: CE/EMC

## ACCESSORIES - Lighting

O.E.M. names and numbers are used for reference purposes only.

**171948 LED Work Lamp** Std pkg 1

Handle: HC-CARGO 172008.

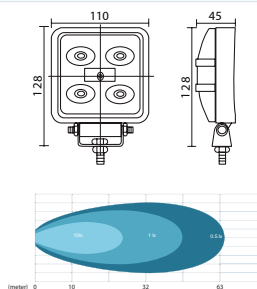

Voltage: 10-30  
Watt: 15  
Kelvin: 6000  
Lumen: 1100

Dim.: 128x110x45 mm  
Cable length: 400 mm

Bulb type: 5 LED  
Colour: Black  
Material/ bracket: Stainless steel  
Material/dome: Polycarbonate  
Material/house: Cast aluminum  
Shape: Square  
Mount.: Cable  
Switch: w/o  
Beam shape: Flood  
Tightness norm: IP 67  
Approvals: CE/EMC  
Alternativ no. 172119

**171949 LED Work Lamp** Std pkg 1

Handle: HC-CARGO 172008.

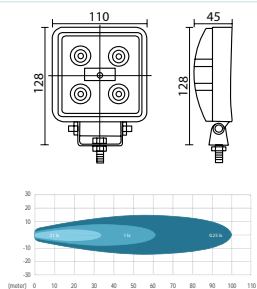

Voltage: 10-30  
Watt: 15  
Kelvin: 6000  
Lumen: 1100

Dim.: 128x110x45 mm  
Cable length: 400 mm

Bulb type: 5 LED  
Colour: Black  
Material/ bracket: Stainless steel  
Material/dome: Polycarbonate  
Material/house: Cast aluminum  
Shape: Square  
Mount.: Cable  
Switch: w/o  
Beam shape: Spot  
Tightness norm: IP 67  
Approvals: CE/EMC

**171950 LED Work Lamp** Std pkg 1

Handle: HC-CARGO 172008.

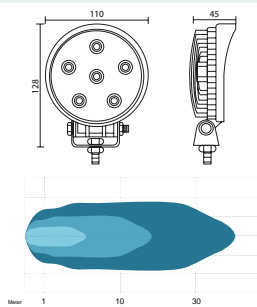

Voltage: 10-30  
Watt: 18  
Kelvin: 6000  
Lumen: 1200

Dim.: 128x110x45 mm  
Cable length: 400 mm

Bulb type: 6 LED  
Colour: Black  
Material/ bracket: Stainless steel  
Material/dome: Polycarbonate  
Material/house: Cast aluminum  
Shape: Round  
Mount.: Cable  
Switch: w/o  
Beam shape: Flood  
Tightness norm: IP 67  
Approvals: CE/EMC  
Alternativ no. 172120

**171951 LED Work Lamp** Std pkg 1

Handle: HC-CARGO 172008.

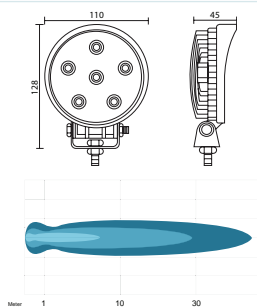

Voltage: 10-30  
Watt: 18  
Kelvin: 6000  
Lumen: 1200

Dim.: 128x110x45 mm  
Cable length: 400 mm

Bulb type: 6 LED  
Colour: Black  
Material/ bracket: Stainless steel  
Material/dome: Polycarbonate  
Material/house: Cast aluminum  
Shape: Round  
Mount.: Cable  
Switch: w/o  
Beam shape: Spot  
Tightness norm: IP 67  
Approvals: CE/EMC

**171955 LED Work Lamp** Std pkg 1

Accessories: HC-CARGO 190252, 190261, 191029, 193010. Bracket: HC-CARGO 172005.

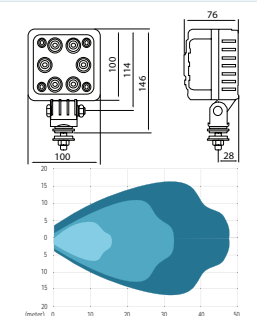

Voltage: 12-24  
Watt: 24  
Kelvin: 5000-7000  
Lumen: 1500

Dim.: 100x100x76 mm

Bulb type: 6 LED  
Inclination/downwards: 80°  
Inclination/upwards: 90°  
Inclination/sideways: 180°  
Colour: Black  
Material/dome: Plastic  
Material/house: ABS plastic/aluminium  
Shape: Square  
Switch: w/o  
Beam shape: Flood  
2 poles: w/  
Tightness norm: IP 69K  
Approvals: CE/EMC

**172001 LED Work Lamp**

Std pkg 1

Handle: HC-CARGO 172008.

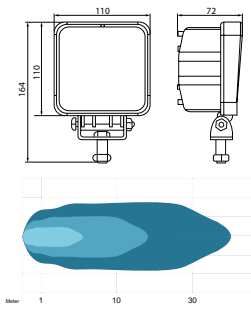

Voltage: 10-80  
Watt: 48  
Kelvin: 6000  
Lumen: 3500

Dim.: 164x110x72 mm  
Cable length: 400 mm

Bulb type: 16 LED  
Colour: Black  
Material/ bracket: Stainless steel  
Material/dome: Polycarbonate  
Material/house: Cast aluminum  
Shape: Square  
Mount.: Cable  
Switch: w/o  
Beam shape: Flood  
2 poles: w/  
Tightness norm: IP 67  
Approvals: CE/EMC

**172003 LED Work Lamp**

Std pkg 1

Bracket: HC-CARGO 172005.

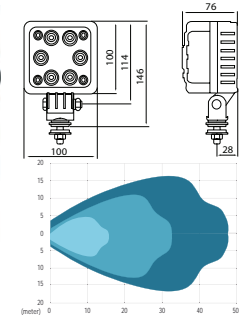

Voltage: 12-24  
Watt: 24  
Kelvin: 5000-7000  
Lumen: 1500

Dim.: 100x100x76 mm  
Cable length: 500 mm

Bulb type: 6 LED  
Inclination/downwards: 80°  
Inclination/upwards: 90°  
Inclination/sideways: 180°  
Colour: Black  
Material/dome: Plastic  
Material/house: ABS plastic/aluminium  
Shape: Square  
Switch: w/  
Beam shape: Flood  
Tightness norm: IP 69K  
Approvals: CE/EMC

**172004 LED Work Lamp**

Std pkg 1

Bracket: HC-CARGO 172005.

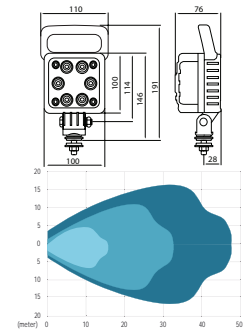

Voltage: 12-24  
Watt: 24  
Kelvin: 5000-7000  
Lumen: 1500

Dim.: 205x110x76 mm  
Cable length: 500 mm

Bulb type: 6 LED  
Inclination/downwards: 80°  
Inclination/upwards: 90°  
Inclination/sideways: 180°  
Colour: Black  
Material/dome: Plastic  
Material/house: ABS plastic/aluminium  
Shape: Square  
Switch: w/  
Handle: w/  
Beam shape: Flood  
Tightness norm: IP 69K  
Approvals: CE/EMC

**172010 LED Work Lamp**

Std pkg 1

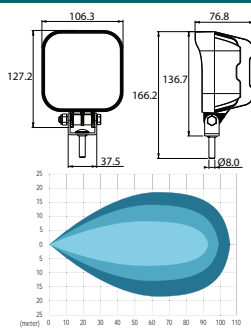

Voltage: 12-36  
Watt: 40  
Lumen: 3200

Dim.: 127.2x106.3x76.8 mm  
Cable length: 280 mm

Bulb type: 4 LED  
Colour: Black  
Material/house: Aluminium  
Shape: Square  
Switch: w/o  
Mount. bracket: U-bracket w/ 1 bolt  
Beam shape: Spot  
Tightness norm: IP 69K  
Approvals: CE/EMC  
Alternativ no. 171932

**172017 LED Work Lamp**

Std pkg 1

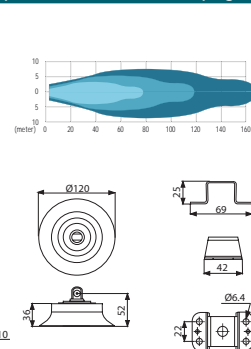

Voltage: 12-24  
Watt: 34  
Lumen: 2600

Dim.: 145x120x49 mm  
Cable length: 150 mm

v: 12 LED  
Material/house: Aluminium  
Shape: Round  
Switch: w/o  
Magnet base: w/  
Beam shape: Spot  
2 poles: w/  
Tightness norm: IP 69K  
Approvals: EMC/ADR/GGVS

**172018 LED Work Lamp**

Std pkg 1

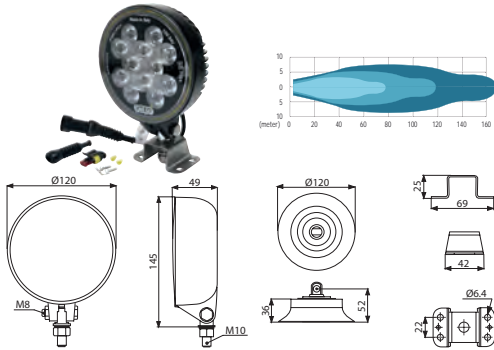

Voltage: 12-24  
Watt: 34  
Lumen: 2600

Dim.: 145x120x49 mm  
Cable length: 150 mm

Bulb type: 12 LED  
Material/house: Aluminium  
Shape: Round  
Switch: w/o  
Beam shape: Spot  
2 poles: w/  
Tightness norm: IP 69K  
Approvals: EMC/ADR/GGVS

**172019 LED Work Lamp**

Std pkg 1

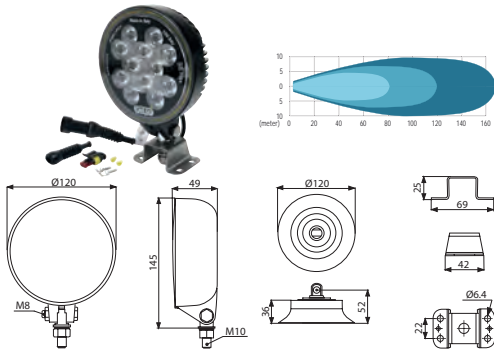

Voltage: 12-24  
Watt: 40  
Lumen: 4000

Dim.: 145x120x49 mm  
Cable length: 150 mm

Bulb type: 12 LED  
Material/house: Aluminium  
Shape: Round  
Switch: w/o  
Beam shape: Spot  
2 poles: w/  
Tightness norm: IP 69K  
Approvals: EMC/ADR/GGVS

**172020 LED Work Lamp**

Std pkg 1

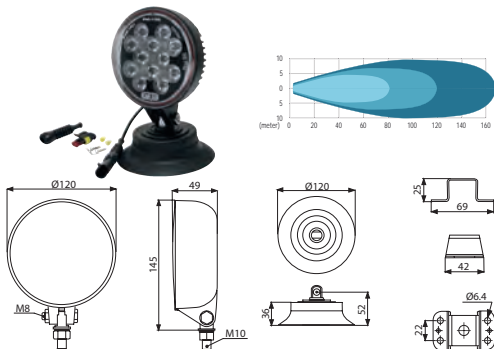

Voltage: 12-24  
Watt: 40  
Lumen: 4000

Dim.: 145x120x49 mm  
Cable length: 150 mm

Bulb type: 12 LED  
Material/house: Aluminium  
Shape: Round  
Switch: w/o  
Magnet base: w/  
Beam shape: Spot  
2 poles: w/  
Tightness norm: IP 69K  
Approvals: EMC/ADR/GGVS

**172031 LED Work Lamp**

Std pkg 1



Voltage: 10-80  
Watt: 24  
Kelvin: 6000  
Lumen: 1920

Dim.: 140x95x70 mm  
Cable length: 400 mm

Bulb type: 8 LED  
Material/dome: Acrylic  
Material/house: Cast aluminum  
Shape: Oval  
Switch: w/o  
Beam shape: Flood  
2 poles: w/  
Tightness norm: IP 69K  
Approvals: CE/EMC

**172032 LED Work Lamp**

Std pkg 1



Voltage: 10-80  
Watt: 36  
Kelvin: 6000  
Lumen: 2880

Dim.: 140x95x70 mm  
Cable length: 400 mm

Bulb type: 12 LED  
Material/dome: Acrylic  
Material/house: Cast aluminum  
Shape: Oval  
Switch: w/o  
Beam shape: Flood  
2 poles: w/  
Tightness norm: IP 69K  
Approvals: CE/EMC

		EL. SPECIFICATIONS	DIMENSIONS	ADDITIONAL SPECIFICATIONS
<b>172045 LED Work Lamp</b> Std pkg 1		Voltage: 10-80 Watt: 65 Kelvin: 6000 Lumen: 5850	Dim.: 165x142x94.5 mm Cable length: 500 mm	Bulb type: 13 LED Colour: Black Material/ bracket: Stainless steel Material/dome: Polycarbonate Material/house: Aluminium Shape: Oval Switch: w/o Beam shape: Flood 2 poles: w/ Tightness norm: IP 69K Approvals: CE
<b>172046 LED Work Lamp</b> Std pkg 1		Voltage: 10-80 Watt: 65 Kelvin: 6000 Lumen: 5850	Dim.: 165x142x94.5 mm Cable length: 500 mm	Bulb type: 13 LED Colour: Black Material/ bracket: Stainless steel Material/dome: Polycarbonate Material/house: Aluminium Shape: Oval Switch: w/o Beam shape: Spot 2 poles: w/ Tightness norm: IP 69K Approvals: CE
<b>172055 LED Work Lamp</b> Std pkg 1		Voltage: 10-80 Amp: 0.83/0.42 Watt: 10 Kelvin: 6000 Lumen: 900	Dim.: 92.4x49.6x45.7 mm Cable length: 500 mm	Bulb type: 2 LED Material/ bracket: Stainless steel Material/dome: Polycarbonate Material/house: Cast aluminum Shape: Rectangular Mount. bracket: U-bracket w/ 1 bolt Beam shape: Flood Switch: w/o 2 poles: w/ Tightness norm: IP 69K Approvals: CE
<b>172056 LED Work Lamp</b> Std pkg 1		Voltage: 10-80 Amp: 0.83/0.42 Watt: 10 Kelvin: 6000 Lumen: 900	Dim.: 92.4x49.6x45.7 mm Cable length: 500 mm	Bulb type: 2 LED Material/ bracket: Stainless steel Material/dome: Polycarbonate Material/house: Cast aluminum Shape: Rectangular Mount. bracket: U-bracket w/ 1 bolt Beam shape: Spot Switch: w/o 2 poles: w/ Tightness norm: IP 69K Approvals: CE
<b>172088 LED Work Lamp</b> Std pkg 1		Voltage: 10-30 Watt: 30 Kelvin: 6000 Lumen: 2400	Dim.: 150x90x90 mm Cable length: 350 mm	Bulb type: 6 LED Material/dome: Polycarbonate Material/house: Aluminium Shape: Rectangular Mount.: Sidemounted Beam shape: Flood Switch: w/o 2 poles: w/ Tightness norm: IP 69K Approvals: CE/EMC
<b>172105 LED Work Lamp</b> Std pkg 1		Voltage: 10-60 Watt: 15 Kelvin: 6000 Lumen: 1200	Dim.: 88x88x50 mm Cable length: 450 mm	Bulb type: 5 LED Colour: Black Material/dome: Polycarbonate Material/house: Aluminium Beam shape: Flood Switch: w/o 2 poles: Male/female Tightness norm: IP 69K Approvals: CE/EMC

## ACCESSORIES - Lighting

O.E.M. names and numbers are used for reference purposes only.

**172106 LED Work Lamp**

Std pkg 1

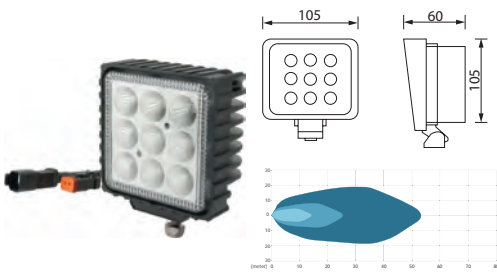
 Voltage: 10-30  
 Watt: 27  
 Kelvin: 6000  
 Lumen: 2160

 Dim.: 105x105x60 mm  
 Cable length: 450 mm

 Bulb type: 9 LED  
 Colour: Black  
 Material/dome: Polycarbonate  
 Material/house: Aluminium  
 Beam shape: Flood  
 Switch: w/o  
 2 poles: Male/female  
 Tightness norm: IP 69K  
 Approvals: CE/EMC

**172107 LED Work Lamp**

Std pkg 1



 Voltage: 10-30  
 Watt: 27  
 Kelvin: 6000  
 Lumen: 2160

 Dim.: 125x125x50 mm  
 Cable length: 450 mm

 Bulb type: 9 LED  
 Colour: Black  
 Material/dome: Polycarbonate  
 Material/house: Aluminium  
 Beam shape: Flood  
 Switch: w/o  
 2 poles: Male/female  
 Tightness norm: IP 69K  
 Approvals: CE/EMC

**172119 LED Work Lamp**

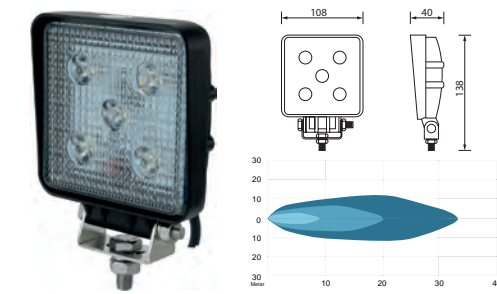
Std pkg 1



 Voltage: 10-30  
 Watt: 15  
 Kelvin: 6000  
 Lumen: 1100

 Dim.: 138x108x40 mm  
 Cable length: 265 mm

 Bulb type: 5 LED  
 Colour: Black  
 Material/ bracket: Stainless steel  
 Material/dome: Polycarbonate  
 Material/house: Cast aluminum  
 Shape: Square  
 Beam shape: Flood  
 Switch: w/o  
 Tightness norm: IP 67  
 Approvals: CE/EMC  
 Alternativ no. 171948

**172120 LED Work Lamp**

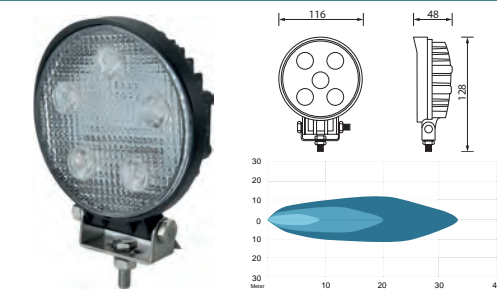
Std pkg 1

 Voltage: 10-30  
 Watt: 15  
 Kelvin: 6000  
 Lumen: 1100

 Dim.: 128x116x48 mm  
 Cable length: 265 mm

 Bulb type: 5 LED  
 Colour: Black  
 Material/ bracket: Stainless steel  
 Material/dome: Polycarbonate  
 Material/house: Cast aluminum  
 Shape: Round  
 Switch: w/o  
 Beam shape: Flood  
 Tightness norm: IP 67  
 Approvals: CE/EMC  
 Alternativ no. 171950

**ACCESSORIES**
**172005 Bracket**

Std pkg 1 Servicing: HC-CARGO 171955, 172003, 172004

 Dim.: 59x37 mm  
 Mount. hole size:  
 24 mm

 Material: Plastic  
 Mount.: Standard ISO A - Rod

**172008 Handle for LED Work Lamp**

Std pkg 1 Servicing: HC-CARGO 171948, 171949, 171950, 171951, 172001



 Colour: Black  
 Material/ bracket: Aluminium  
 Mount. bracket: 2 screws



## WORK LIGHT BARS LED

**172077** LED Work light bar Std pkg 1

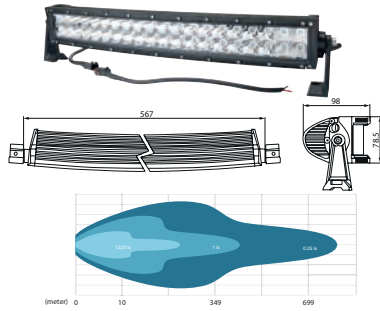
Mounting Bracket Kitt: HC-CARGO 172116.



Voltage: 10-30  
Watt: 120  
Kelvin: 6000  
Lumen: 10800

Dim.: 567x98x78.5 mm  
Cable length: 1000 mm

Bulb type: 40 LED  
Colour: Black  
Material/ bracket: Aluminium  
Material/dome: Polycarbonate  
Material/house: Aluminium  
Reflector system: Combo  
Shape: Curved  
Mount. bracket: Vertical  
Beam shape: Combo  
2 poles: Male/female  
Tightness norm: IP 67  
Approvals: CE/EMC  
E-approval: No

**172078** LED Work light bar Std pkg 1

Mounting Bracket Kitt: HC-CARGO 172116.

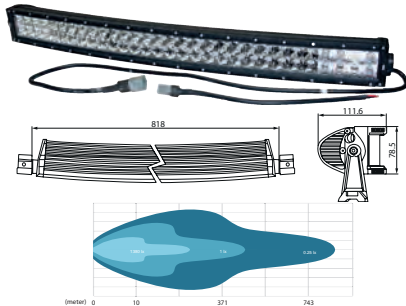

Voltage: 10-30  
Watt: 180  
Kelvin: 6000  
Lumen: 16200

Dim.: 818x111.6x78.5 mm  
Cable length: 1000 mm

Bulb type: 60 LED  
Colour: Black  
Material/ bracket: Aluminium  
Material/dome: Polycarbonate  
Material/house: Aluminium  
Reflector system: Combo  
Shape: Curved  
Mount. bracket: Vertical  
Beam shape: Combo  
2 poles: Male/female  
Tightness norm: IP 67  
Approvals: CE/EMC  
E-approval: No

**172079** LED Work light bar Std pkg 1

Mounting Bracket Kitt: HC-CARGO 172116.

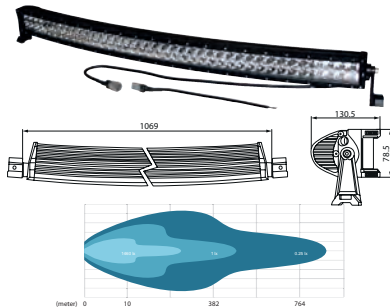

Voltage: 10-30  
Watt: 240  
Kelvin: 6000  
Lumen: 21600

Dim.: 1069x130.5x78.5 mm  
Cable length: 1000 mm

Bulb type: 80 LED  
Colour: Black  
Material/ bracket: Aluminium  
Material/dome: Polycarbonate  
Material/house: Aluminium  
Reflector system: Combo  
Shape: Curved  
Mount. bracket: Vertical  
Beam shape: Combo  
2 poles: Male/female  
Tightness norm: IP 67  
Approvals: CE/EMC  
E-approval: No

**172080** LED Work light bar Std pkg 1

Mounting Bracket Kitt: HC-CARGO 172116.

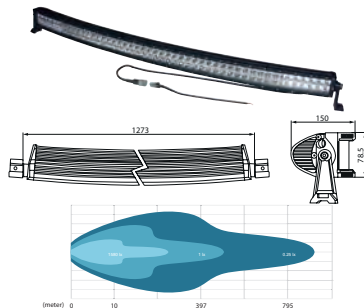

Voltage: 10-30  
Watt: 288  
Kelvin: 6000  
Lumen: 25920

Dim.: 1273x150x78.5 mm  
Cable length: 1000 mm

Bulb type: 96 LED  
Colour: Black  
Material/ bracket: Aluminium  
Material/dome: Polycarbonate  
Material/house: Aluminium  
Reflector system: Combo  
Shape: Curved  
Mount. bracket: Vertical  
Beam shape: Combo  
2 poles: Male/female  
Tightness norm: IP 67  
Approvals: CE/EMC  
E-approval: No

**172081** LED Work light bar Std pkg 1

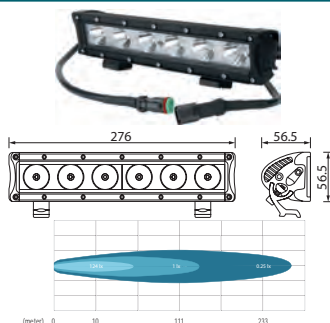

Voltage: 10-30  
Watt: 18  
Kelvin: 6000  
Lumen: 1620

Dim.: 276x56.6x56.5 mm  
Cable length: 500 mm

Bulb type: 6 LED  
Colour: Black  
Material/ bracket: Aluminium  
Material/dome: Polycarbonate  
Material/house: Aluminium  
Reflector system: Spot  
Shape: Straight  
Mount. bracket: Vertical  
Beam shape: Spot  
2 poles: Male/female  
Tightness norm: IP 67  
Approvals: CE/EMC  
E-approval: No

EL. SPECIFICATIONS

DIMENSIONS

ADDITIONAL SPECIFICATIONS

172082 LED Work light bar Std pkg 1

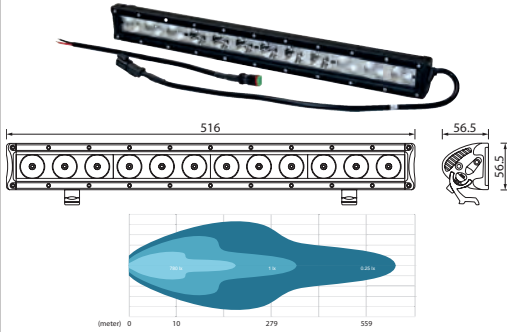

Voltage: 10-30  
Watt: 36  
Kelvin: 6000  
Lumen: 3240

Dim.: 516x56.5x56.5 mm  
Cable length: 500 mm

Bulb type: 12 LED  
Colour: Black  
Material/ bracket: Aluminium  
Material/dome: Polycarbonate  
Material/house: Aluminium  
Reflector system: Combo  
Shape: Straight  
Mount. bracket: Vertical  
Beam shape: Combo  
2 poles: Male/female  
Tightness norm: IP 67  
Approvals: CE/EMC  
E-approval: No

172083 LED Work light bar Std pkg 1

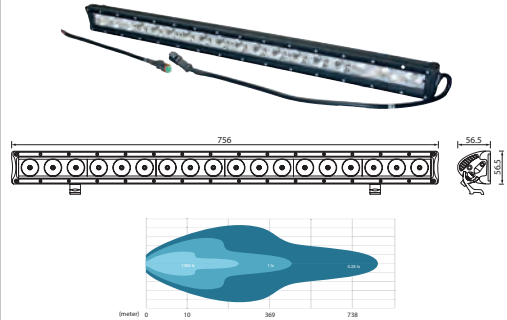

Voltage: 10-30  
Watt: 54  
Kelvin: 6000  
Lumen: 4860

Dim.: 756x56.5x56.5 mm  
Cable length: 500 mm

Bulb type: 18 LED  
Colour: Black  
Material/ bracket: Aluminium  
Material/dome: Polycarbonate  
Material/house: Aluminium  
Reflector system: Combo  
Shape: Straight  
Mount. bracket: Vertical  
Beam shape: Combo  
2 poles: Male/female  
Tightness norm: IP 67  
Approvals: CE/EMC  
E-approval: No

172084 LED Work light bar Std pkg 1

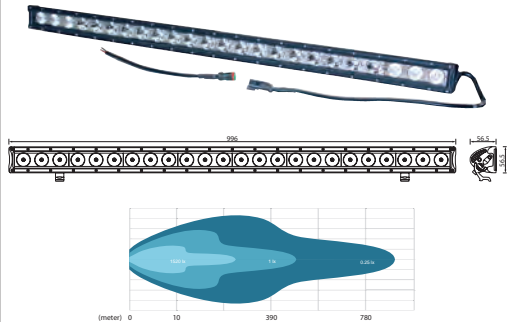

Voltage: 10-30  
Watt: 72  
Kelvin: 6000  
Lumen: 6480

Dim.: 996x56.5x56.5 mm  
Cable length: 500 mm

Bulb type: 24 LED  
Colour: Black  
Material/ bracket: Aluminium  
Material/dome: Polycarbonate  
Material/house: Aluminium  
Reflector system: Combo  
Shape: Straight  
Mount. bracket: Vertical  
Beam shape: Combo  
2 poles: Male/female  
Tightness norm: IP 67  
Approvals: CE/EMC  
E-approval: No

172095 LED Work light bar Std pkg 1

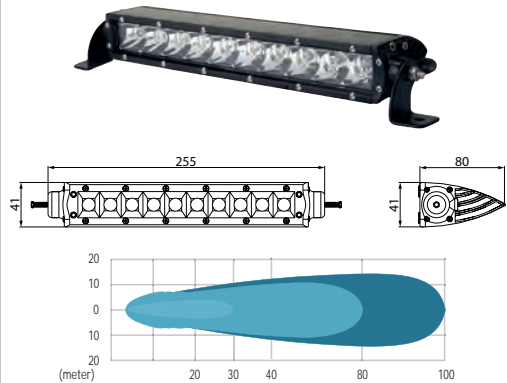

Voltage: 12/24  
Amp: 3.2/1.6  
Watt: 40  
Kelvin: 6000  
Lumen: 4000

Dim.: 255x80x41 mm  
Cable length: 220 mm

Bulb type: 10 LED  
Inclination/downwards: 90°  
Inclination/upwards: 15°  
Colour: Black  
Material/ bracket: Stainless steel  
Material/dome: Polycarbonate  
Material/house: Aluminium  
Reflector system: Spot  
Shape: Straight  
Mount.: Upright/pendant  
Mount. bracket: Sidemounted  
Beam shape: Spot  
2 poles: Male/female  
Tightness norm: IP 67  
Approvals: CE/EMC  
E-approval: No

172096 LED Work light bar Std pkg 1

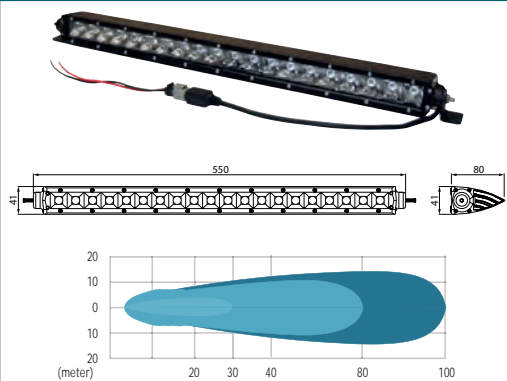

Voltage: 12/24  
Amp: 6.25/3.125  
Watt: 75  
Kelvin: 6000  
Lumen: 8000

Dim.: 550x80x41 mm  
Cable length: 220 mm

Bulb type: 20 LED  
Inclination/downwards: 90°  
Inclination/upwards: 15°  
Colour: Black  
Material/ bracket: Stainless steel  
Material/dome: Polycarbonate  
Material/house: Aluminium  
Reflector system: Spot  
Shape: Straight  
Mount.: Upright/pendant  
Mount. bracket: Sidemounted  
Beam shape: Spot  
2 poles: Male/female  
Tightness norm: IP 67  
Approvals: CE/EMC  
E-approval: No

**172097** LED Work light bar

Std pkg 1

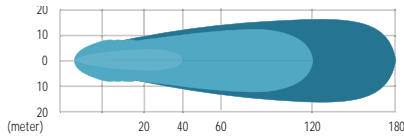

Voltage: 12/24  
Amp: 9.45/4.7  
Watt: 115  
Kelvin: 6000  
Lumen: 12000

Dim.: 805x80x41 mm  
Cable length: 3000 mm

Bulb type: 30 LED  
Inclination/downwards: 90°  
Inclination/upwards: 15°  
Colour: Black  
Material/ bracket: Stainless steel  
Material/dome: Polycarbonate  
Material/house: Aluminium  
Reflector system: Spot  
Shape: Straight  
Mount.: Upright/pendant  
Mount. bracket: Sidemounted  
Beam shape: Spot  
2 poles: Male/female  
Tightness norm: IP 67  
Approvals: CE/EMC  
E-approval: No

**172098** LED Work light bar

Std pkg 1

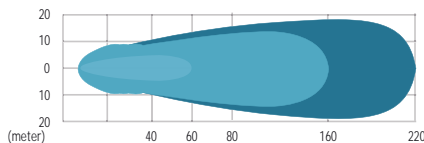
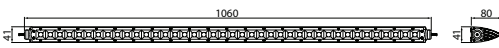
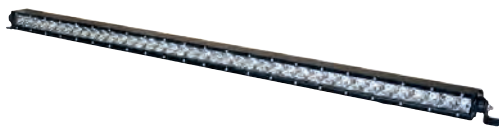

Voltage: 12/24  
Amp: 12.5/6.25  
Watt: 150  
Kelvin: 6000  
Lumen: 16000

Dim.: 1060x80x41 mm  
Cable length: 3000 mm

Bulb type: 40 LED  
Inclination/downwards: 90°  
Inclination/upwards: 15°  
Colour: Black  
Material/ bracket: Stainless steel  
Material/dome: Polycarbonate  
Material/house: Aluminium  
Reflector system: Spot  
Shape: Straight  
Mount.: Upright/pendant  
Mount. bracket: Sidemounted  
Beam shape: Spot  
2 poles: Male/female  
Tightness norm: IP 67  
Approvals: CE/EMC  
E-approval: No

**SPARE PARTS**

**172116** Mounting Bracket Kit

Std pkg 1

Servicing: HC-CARGO 172077, 172078, 172079, 172080



**WORK LAMPS HID**

**171594** HID Work Lamp

Std pkg 1

Bulb: HC-CARGO 171595.

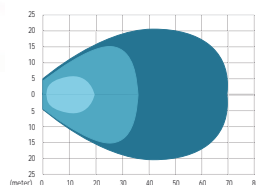
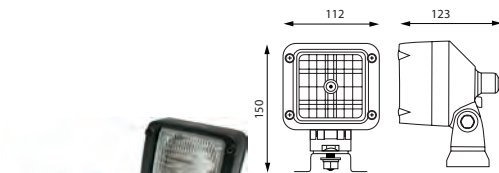

Bulb incl.: Yes  
Voltage: 12

Dim.: 112x150x123 mm  
Light aperture:  
73x73 mm

Bulb type: H3  
Colour: Black  
Material/dome: Glass  
Material/house: Shockproof plastic  
Shape: Square  
Switch: w/o  
Ballast: External  
Mount. bracket: Mounting bracket  
Magnet base: w/o  
Handle: w/o  
2 poles: w/  
Tightness norm: IP 65

**171611 HID Work Lamp**

Std pkg 1

Bulb: HC-CARGO 171595.



Bulb incl.: Yes  
Voltage: 24

Dim.: 112x150x123 mm  
Light aperture:  
73x73 mm

Bulb type: H3  
Colour: Black  
Material/dome: Glass  
Material/house: Shockproof plastic  
Model: HID  
Shape: Square  
Switch: w/o  
Ballast: External  
Mount. bracket: Mounting bracket  
Magnet base: w/o  
Handle: w/o  
2 poles: w/  
Tightness norm: IP 65

**171615 HID Work Lamp**

Std pkg 1

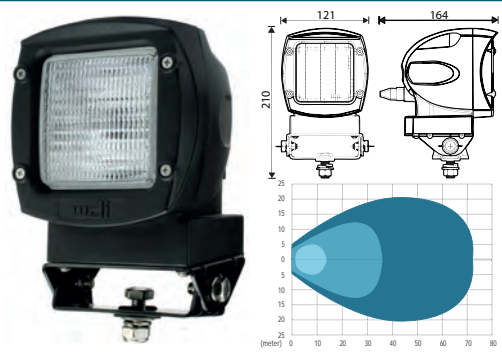

Bulb incl.: Yes  
Voltage: 12  
Watt: 35

Dim.: 210x164x121 mm  
Light aperture:  
73x73 mm

Bulb type: D1S  
Socket type: PK32d-2  
Colour: Black  
Material/dome: Glass  
Material/house: Shockproof plastic  
Reflector system: Single  
Shape: Square  
Switch: w/o  
Mount. bracket: Mounting bracket  
Magnet base: w/o  
Handle: w/o  
Tightness norm: IP 65

**171625 HID Work Lamp**

Std pkg 1

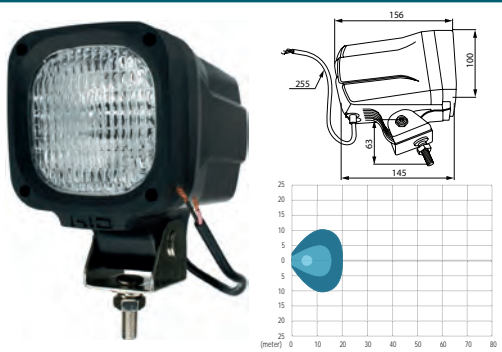

Bulb incl.: Yes  
Voltage: 12  
Watt: 35

Dim.: 156x100 mm  
Light aperture: 75 mm

Bulb type: D2S  
Socket type: PK32d-2  
Colour: Black  
Material/dome: Glass  
Material/house: Aluminium  
Reflector system: Single  
Shape: Square  
Switch: w/o  
Mount. bracket: U-bracket w/ 1 bolt  
Magnet base: w/o  
Handle: w/o  
2 poles: w/o

**171626 HID Work Lamp**

Std pkg 1

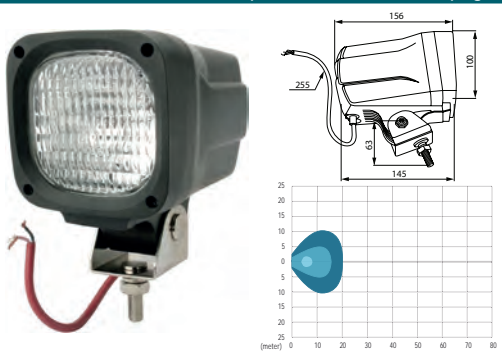

Bulb incl.: Yes  
Voltage: 24  
Watt: 35

Dim.: 156x100 mm  
Light aperture: 75 mm

Bulb type: D2S  
Socket type: PK32d-3  
Colour: Black  
Material/dome: Glass  
Material/house: Aluminium  
Reflector system: Single  
Shape: Square  
Mount.: Single bolt fixing  
Switch: w/o  
Mount. bracket: Mounting bracket  
Magnet base: w/o  
Handle: w/o  
2 poles: w/o

**SPARE PARTS**

**171595 Xenon Bulb**

Std pkg 1 Servicing: HC-CARGO 171594, 171611



Bulb type: Xenon  
H3

## SPOT LIGHTS CONVENTIONAL

**170293 Spot Light**

Std pkg 1

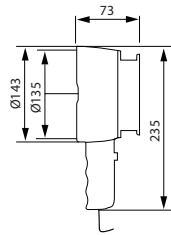
*Hand-held.*

**Bulb incl.:** Yes  
**Voltage:** 12  
**Watt:** 55

**Dim.:** 235x73 mm  
**Cable length:** 6000 mm  
**Connection cable:** w/  
**Light aperture:**  
 120 mm

**Bulb type:** Halogen, H3  
**Socket type:** PK22s  
**Colour:** Black  
**Material/house:** Shockproof plastic  
**Shape:** Round  
**Switch:** w/  
**Protective cover:** w/  
**Lighter plug incl.:** Yes  
**Connection cable:** w/

**170564 Spot Light**

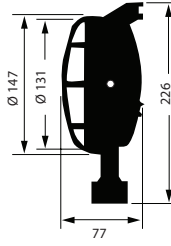
Std pkg 1



**Bulb incl.:** No

**Dim.:** 226x77 mm  
**Light aperture:**  
 131 mm

**Bulb type:** H3  
**Socket type:** PK22s  
**Inclination/sideways:** Yes  
**Colour:** Black  
**Material/dome:** Glass  
**Material/house:** Shockproof plastic  
**Switch:** w/  
**Grill:** w/  
**Handle:** w/

**171464 Spot Light**

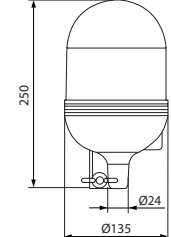
Std pkg 1

*Remote controlled by EU approved radio controller. Frequency 433.92 MHZ. Reach up to 100 m. Incl. 9 V battery. Battery: HC-CARGO 200742, 200769.*

**Bulb incl.:** Yes  
**Voltage:** 12  
**Watt:** 55

**OD:** 135 mm  
**Height:** 250 mm  
**Width:** 135 mm

**Bulb type:** H1  
**Lens type:** Polycarbonate  
**Mount.:** Standard ISO A - Rod  
**Base:** Rigid  
**Hi impact:** Yes  
**Tightness norm:** IP 55  
**Approval:** CE

**171466 Spot Light**

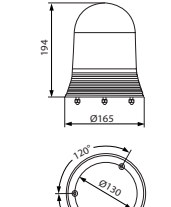
Std pkg 1

*Remote controlled by EU approved radio controller. Frequency 433.92 MHZ. Reach up to 100 m. Incl. 9 V battery. Battery: HC-CARGO 200742, 200769. Beacon Socket: HC-CARGO 170653.*

**Bulb incl.:** Yes  
**Voltage:** 12  
**Watt:** 55

**OD:** 160 mm  
**Height:** 194 mm  
**Width:** 165 mm

**Bulb type:** H1  
**Lens type:** Polycarbonate  
**Mount.:** Standard ISO B2 (and B1) - Base  
**Hi impact:** Yes  
**Tightness norm:** IP 55

## ACCESSORIES

**170653 Beacon Socket**

Std pkg 1 Servicing: HC-CARGO 170650, 170651, 171466

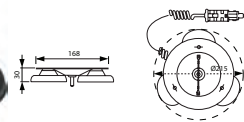
**Cable length:** 2000 mm  
**Height:** 30 mm  
**Width:** 168 mm

**Mount.:** 3 magnets  
**Base:** Magnetic  
**Coiled cable incl.:** Yes  
**Tightness norm:** IP 55  
**E-approval:** Yes

**171936 Magnetic base for Lamps**

Std pkg 1 Servicing: HC-CARGO 170534, 171375

**Coiled cable:** 2000 mm

**Colour:** Black  
**Mount.:** Magnetic  
**Mount. bracket:** U-bracket w/ 2 holes  
**Magnet base:** w/  
**Lighter plug incl.:** Yes  
**Coiled cable incl.:** Yes

## SPOT LIGHTS LED

**172053 LED Blue Spot**

Std pkg 1



**Voltage:** 10-80  
**Amp:** 0.5/0.25  
**Watt:** 6  
**Lumen:** 540

**Dim.:**  
 92.4x49.6x45.7 mm  
**Cable length:** 500 mm

**Bulb type:** 2 LED  
**Colour:** Blue  
**Material/ bracket:** Stainless steel  
**Material/dome:** Polycarbonate  
**Material/house:** Cast aluminum  
**Shape:** Rectangular  
**Mount. bracket:** U-bracket w/ 1 bolt  
**Switch:** w/o  
**2 poles:** w/  
**Tightness norm:** IP 69K  
**Approvals:** CE

**172054 LED Red Spot**

Std pkg 1



**Voltage:** 10-80  
**Amp:** 0.5/0.25  
**Watt:** 6  
**Lumen:** 540

**Dim.:**  
 92.4x49.6x45.7 mm  
**Cable length:** 500 mm

**Bulb type:** 2 LED  
**Colour:** Red  
**Material/ bracket:** Stainless steel  
**Material/dome:** Polycarbonate  
**Material/house:** Cast aluminum  
**Shape:** Rectangular  
**Mount. bracket:** U-bracket w/ 1 bolt  
**Switch:** w/o  
**2 poles:** w/  
**Tightness norm:** IP 69K  
**Approvals:** CE

## FORWARD LIGHTING

### TRACTOR HEAD LAMPS

**170132 Head Lamp**

Std pkg 1

*Light unit: HC-CARGO 170239.*



**Bulb incl.:** No  
**Watt:** 45/40  
**Watt 2:** 55/50  
**Watt 3:** 4

**Dim.:** 148x105 mm  
**Light aperture:**  
 130 mm

**Socket type:** P45t  
**Socket type 2:** P45t  
**Socket type 3:** BA9s  
**Colour:** Black  
**Material:** Metal  
**Material/dome:** Glass  
**Shape:** Round  
**Mount.:** 1 bolt  
**Sidemarkers:** w/  
**Grill:** w/o  
**Asymmetric light:** w/  
**RH/LH:** LH  
**E-approval:** Yes

**170310 Head Lamp**

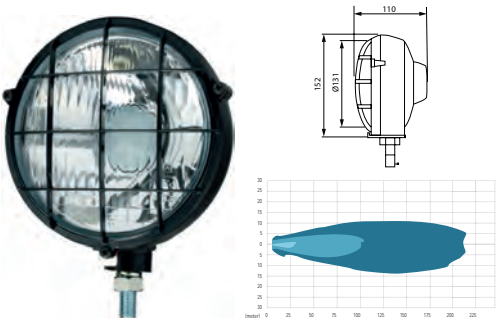
Std pkg 1

*For upright fixing.*

**Bulb incl.:** No  
**Watt:** 45/40  
**Watt 2:** 55/50  
**Watt 3:** 4

**Dim.:** 152x110 mm  
**Light aperture:**  
 131 mm

**Socket type:** P45t  
**Socket type 2:** P45t  
**Socket type 3:** BA9s  
**Colour:** Black  
**Material:** Plastic  
**Material/dome:** Glass  
**Shape:** Round  
**Mount.:** Vertical  
**Sidemarkers:** w/  
**Grill:** w/  
**Asymmetric light:** w/  
**RH/LH:** RH/LH  
**E-approval:** Yes

**170311 Head Lamp**

Std pkg 1

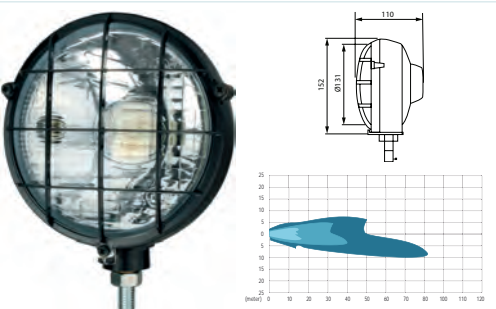
*Horizontal fixing.*

**Bulb incl.:** No  
**Watt:** 45/40  
**Watt 2:** 55/50  
**Watt 3:** 4

**Dim.:** 152x110 mm  
**Light aperture:**  
 131 mm

**Socket type:** P45t  
**Socket type 2:** P45t  
**Socket type 3:** BA9s  
**Colour:** Black  
**Material:** Plastic  
**Material/dome:** Glass  
**Shape:** Round  
**Mount.:** Horizontal  
**Sidemarkers:** w/  
**Grill:** w/  
**Asymmetric light:** w/  
**RH/LH:** LH  
**E-approval:** Yes

170843 Head Lamp		Std pkg 1			
<p><i>Light unit: HC-CARGO 170844.</i></p>					
		<p><b>Bulb incl.:</b> No  <b>Watt:</b> 45/40  <b>Watt 2:</b> 55/50  <b>Watt 3:</b> 4</p>		<p><b>Dim.:</b> 137x95 mm  <b>Light aperture:</b> 110 mm</p>	
		<p><b>Socket type:</b> BA20d  <b>Socket type 2:</b> BA20d  <b>Socket type 3:</b> BA9s  <b>Colour:</b> Black  <b>Material:</b> Metal  <b>Material/dome:</b> Glass  <b>Shape:</b> Round  <b>Mount.:</b> 1 bolt  <b>Sidemarkers:</b> w/  <b>Grill:</b> w/o  <b>Asymmetric light:</b> w/o  <b>RH/LH:</b> RH/LH  <b>E-approval:</b> Yes</p>			
<p><b>170865 Head Lamp</b> <span style="float: right;">Std pkg 1</span></p>					
<p><i>Bulb Gasket: HC-CARGO 171937.</i></p>					
		<p><b>Bulb incl.:</b> No  <b>Watt:</b> 60/55  <b>Watt 2:</b> 75/70</p>		<p><b>Dim.:</b> 184x118x110 mm  <b>Light aperture:</b> 156 mm</p>	
		<p><b>Bulb type:</b> H4  <b>Bulb type 2:</b> H4  <b>Socket type:</b> P43t  <b>Socket type 2:</b> P43t  <b>Colour:</b> Black  <b>Material:</b> Shockproof plastic  <b>Material/dome:</b> Glass  <b>Shape:</b> Rectangular  <b>Mount.:</b> Horizontal  <b>Asymmetric light:</b> w/  <b>RH/LH:</b> LH  <b>E-approval:</b> Yes</p>			
<p><b>170974 Head Lamp</b> <span style="float: right;">Std pkg 1</span></p>					
		<p><b>Bulb incl.:</b> No  <b>Watt:</b> 60/65  <b>Watt 2:</b> 75/70</p>		<p><b>Dim.:</b> 144x153x100 mm  <b>Light aperture:</b> 110 mm</p>	
		<p><b>Bulb type:</b> H4  <b>Bulb type 2:</b> H4  <b>Socket type:</b> P43t  <b>Socket type 2:</b> P43t  <b>Colour:</b> Black  <b>Material:</b> Shockproof plastic  <b>Material/dome:</b> Glass  <b>Shape:</b> Rectangular  <b>Mount.:</b> Horizontal/vertical  <b>Asymmetric light:</b> w/  <b>RH/LH:</b> LH  <b>E-approval:</b> Yes</p>			
<p><b>171006 Head Lamp</b> <span style="float: right;">Std pkg 1</span></p>					
<p><i>Light unit: HC-CARGO 171007. Lens: HC-CARGO 171008.</i></p>					
		<p><b>Bulb incl.:</b> Yes  <b>12 V</b>  <b>Watt:</b> 60/55  <b>Watt 2:</b> 75/70</p>		<p><b>Dim.:</b> 208x154x126 mm  <b>Light aperture:</b> 142 mm</p>	
		<p><b>Bulb type:</b> H4  <b>Bulb type 2:</b> H4  <b>Socket type:</b> P43t  <b>Socket type 2:</b> P43t  <b>Colour:</b> Black  <b>Material:</b> Shockproof plastic  <b>Material/dome:</b> Glass  <b>Shape:</b> Rectangular  <b>Mount.:</b> Horizontal/vertical  <b>Flasher light:</b> w/  <b>Sidemarkers:</b> w/  <b>Asymmetric light:</b> w/  <b>RH/LH:</b> RH/LH  <b>E-approval:</b> Yes</p>			
<p><b>171038 Head Lamp</b> <span style="float: right;">Std pkg 1</span></p>					
		<p><b>Bulb incl.:</b> No  <b>Watt:</b> 60/65  <b>Watt 2:</b> 75/70  <b>Watt 3:</b> 4</p>		<p><b>Dim.:</b> 144x153x100 mm  <b>Light aperture:</b> 110 mm</p>	
		<p><b>Bulb type:</b> H4  <b>Bulb type 2:</b> H4  <b>Socket type:</b> P43t  <b>Socket type 2:</b> P43t  <b>Socket type 3:</b> BA9s  <b>Colour:</b> Black  <b>Material:</b> Shockproof plastic  <b>Material/dome:</b> Glass  <b>Shape:</b> Rectangular  <b>Mount.:</b> Horizontal/vertical  <b>Sidemarkers:</b> w/  <b>Asymmetric light:</b> w/  <b>RH/LH:</b> LH  <b>E-approval:</b> Yes</p>			

171565 Head Lamp

Std pkg 1

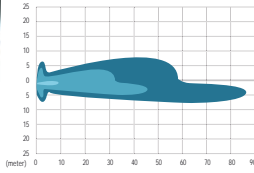
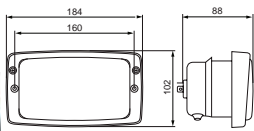

Bulb incl.: No  
Watt: 60/55  
Watt 2: 75/70  
Watt 3: 4

Dim.: 184x102x88 mm  
Light aperture:  
160 mm

Bulb type: H4  
Bulb type 2: H4  
Socket type: P43t  
Socket type 2: P43t  
Socket type 3: BA9s  
Colour: Black  
Material: Shockproof plastic  
Material/dome: Glass  
Shape: Square  
Mount.: Horizontal/vertical  
Sidemarker: w/  
Grill: w/o  
Asymmetric light: w/  
RH/LH: RH/LH  
E-approval: Yes

SPARE PARTS

170239 Light Unit

Std pkg 1 Servicing: HC-CARGO 170132

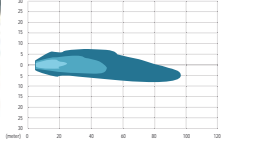
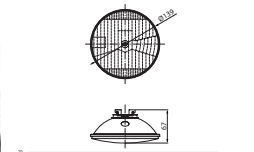

Bulb incl.: No  
Watt: 45/40  
Watt 2: 55/50  
Watt 3: 4

Dim.: 139x67 mm  
Light aperture:  
130 mm

Socket type: P45t  
Socket type 2: P45t  
Socket type 3: BA9s  
Material: Glass  
Shape: Round  
Sidemarker: w/  
Asymmetric light: w/  
RH/LH: LH  
E-approval: Yes

170844 Light Unit

Std pkg 1 Servicing: HC-CARGO 170843

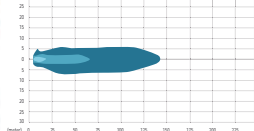
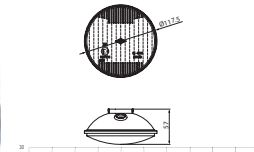

Bulb incl.: No  
Watt: 45/40  
Watt 2: 55/50  
Watt 3: 4

Dim.: 117.5x57 mm  
Light aperture:  
110 mm

Socket type: BA20d  
Socket type 2: BA20d  
Socket type 3: BA9s  
Shape: Round  
Asymmetric light: w/

171007 Light Unit

Std pkg 1 Servicing: HC-CARGO 171006, 170926

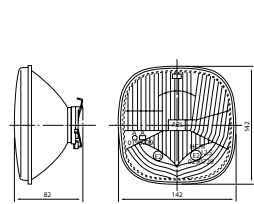

Bulb incl.: No  
Watt: 60/55  
Watt 2: 75/70

Dim.: 142x142x82 mm  
Light aperture:  
142 mm

Bulb type: H4  
Bulb type 2: H4  
Socket type: P43t  
Socket type 2: P43t  
Material: Glass  
Shape: Square  
Asymmetric light: w/  
E-approval: Yes

171008 Lens

Std pkg 1 Servicing: HC-CARGO 171006, 170926



Colour: Orange

171937 Bulb Gasket

Std pkg 1 Servicing: HC-CARGO 170865

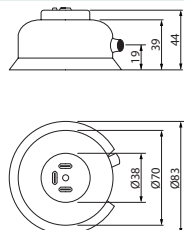

OD: 83 mm

Material: Rubber



## HEADLIGHT INSERTS

### 170690 Light Unit

Std pkg 1

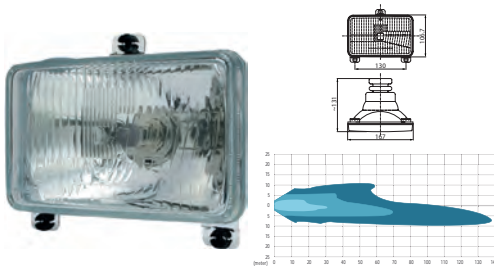
 Servicing: Chrysler, Fendt, Ford, GM, IH/Case, Isuzu, John Deere, Mazda - Visit [www.hc-cargo.com](http://www.hc-cargo.com) for further information.

 Bulb incl.: No  
 Watt: 60/55  
 Watt 2: 75/70

 Dim.: 167x106.7 mm  
 Dist. mount. holes:  
 130x110 mm

 Bulb type: H4  
 Bulb type 2: H4  
 Socket type: P43t  
 Socket type 2: P43t  
 Material: Metal  
 Material/dome: Glass  
 Shape: Rectangular  
 Fixing screw: 3  
 Asymmetric light: w/  
 RH/LH: LH  
 E-approval: Yes

### 170867 Head Lamp

Std pkg 1

Heat resistant plastic reflector bonded w/ glass lens. Flush fitting head lA. Build-in depth: 69 mm.

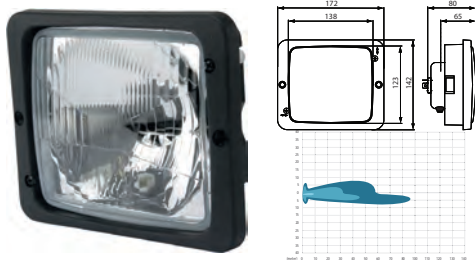

 Bulb incl.: No  
 Watt: 60/55  
 Watt 2: 75/70  
 Watt 3: 4

Dim.: 172x142x80 mm

 Bulb type: H4  
 Bulb type 2: H4  
 Socket type: P43t  
 Socket type 2: P43t  
 Socket type 3: BA9s  
 Material: Metal  
 Material/dome: Glass  
 Fixing screw: 2  
 Sidemarker: w/  
 E-approval: Yes

### 170868 Light Unit

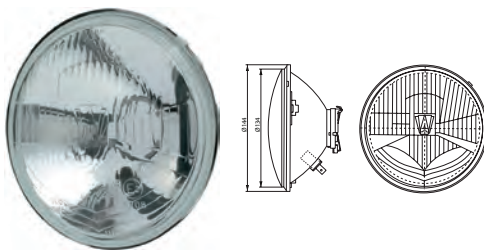
Std pkg 1

 Bulb incl.: No  
 Watt: 60/55  
 Watt 2: 75/70  
 Watt 3: 4

 Dim.: 163x84 mm  
 OD: 144 mm  
 Light aperture:  
 143 mm

 Bulb type: H4  
 Bulb type 2: H4  
 Socket type: P43t  
 Socket type 2: P43t  
 Socket type 3: BA9s  
 Material: Rubber  
 Material/dome: Glass  
 Shape: Round  
 Sidemarker: w/  
 Asymmetric light: w/o  
 RH/LH: RH/LH  
 E-approval: Yes

## SEALED BEAMS

### 4440X Sealed Beam

Std pkg 1

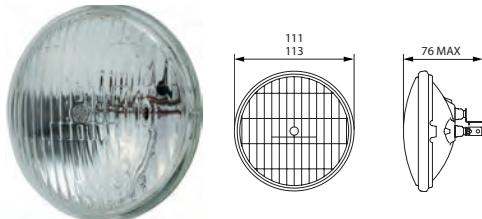
 Servicing: Ford - Visit [www.hc-cargo.com](http://www.hc-cargo.com) for further information.

 Bulb incl.: Yes  
 12 V  
 Voltage: 12  
 Watt: 40/40

Dim.: 113x76 mm

E-approval: No

### H4360 Sealed Beam

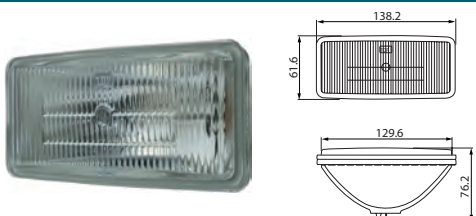
Std pkg 1

 Servicing: John Deere lawn equipment w/ cooling engine - Visit [www.hc-cargo.com](http://www.hc-cargo.com) for further information.

 Bulb incl.: Yes  
 12 V  
 Voltage: 12  
 Watt: 37.5

 Dim.:  
 138.2x61.6x76.2 mm

 E-approval: No  
 Alternativ no. h5360

### H5360 Sealed Beam

Std pkg 1

 Servicing: John Deere - Visit [www.hc-cargo.com](http://www.hc-cargo.com) for further information.

Longlife.

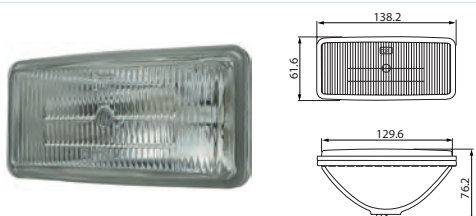

 Bulb incl.: Yes  
 12 V  
 Voltage: 12  
 Watt: 37.5

 Dim.:  
 138.2x61.6x76.2 mm

 E-approval: No  
 Alternativ no. h4360

**FOG LAMPS**
**170616 Fog Lamp**

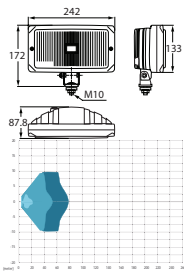
Std pkg 1



 Bulb incl.: No  
 Watt: 55  
 Watt 2: 70

 Dim.: 242x172x87.8 mm  
 Light aperture:  
 240x170 mm

 Type: Fog light  
 Bulb type: H3  
 Bulb type 2: H3  
 Socket type: PK22s  
 Socket type 2: PKY22s  
 Colour: Yellow  
 Material: Metal  
 Material/dome: Glass  
 Shape: Rectangular  
 Mount.: Upright/pendant  
 E-approval: Yes

**171360 Fog Lamp**

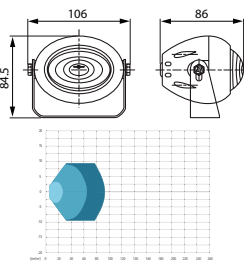
Std pkg 2



 Bulb incl.: No  
 Watt: 55  
 Watt 2: 70

 Dim.: 106x84.5x86 mm  
 Light aperture:  
 55x35 mm

 Type: Fog light  
 Bulb type: H3  
 Bulb type 2: H3  
 Socket type: PK22s  
 Socket type 2: PK22s  
 Material: Shockproof plastic  
 Material/dome: Glass  
 Shape: Oval  
 Mount.: U-bracket w/ 2 holes  
 E-approval: Yes

**171362 Fog Lamp**

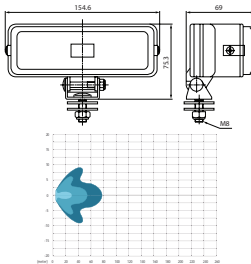
Std pkg 1



 Bulb incl.: No  
 Watt: 55  
 Watt 2: 70

 Dim.: 154.6x75.3x69 mm  
 Light aperture:  
 130x35 mm

 Type: Fog light  
 Bulb type: H3  
 Bulb type 2: H3  
 Socket type: PK22s  
 Socket type 2: PK22s  
 Material: Shockproof plastic  
 Material/dome: Glass  
 Shape: Rectangular  
 Mount.: U-bracket w/ 1 bolt  
 E-approval: No

**171364 Fog Lamp**

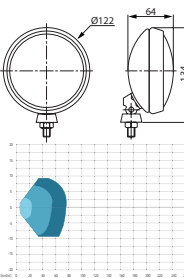
Std pkg 1



 Bulb incl.: No  
 Voltage: 12/24  
 Watt: 55  
 Watt 2: 70

 Dim.: 122x134x64 mm  
 Light aperture: 95 mm

 Type: Fog light  
 Bulb type: H3  
 Bulb type 2: H3  
 Socket type: PK22s  
 Socket type 2: PK22s  
 Colour: Black  
 Material: Metal  
 Material/dome: Glass  
 Shape: Round  
 Mount.: Mounted below  
 E-approval: No

**171366 Fog Lamp**

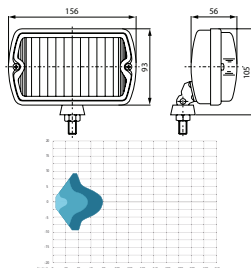
Std pkg 1



 Bulb incl.: No  
 Watt: 55  
 Watt 2: 70

 Dim.: 156x105x56 mm  
 Light aperture:  
 110x75 mm

 Type: Fog light  
 Bulb type: H3  
 Bulb type 2: H3  
 Socket type: PK22s  
 Socket type 2: PK22s  
 Colour: Black  
 Material: Metal  
 Material/dome: Glass  
 Shape: Rectangular  
 Mount.: Mounted below  
 E-approval: Yes

**171452 Fog Lamp Set**

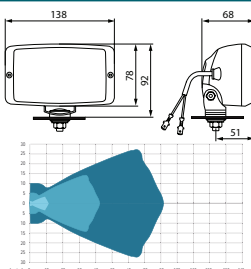
Std pkg 1

 Bulb incl.: Yes  
 Voltage: 12  
 Watt: 55

 Dim.: 138x78x68 mm  
 Light aperture:  
 110x60 mm

 Type: Fog light  
 Bulb type: H3  
 Socket type: PK22s  
 Material: Shockproof plastic  
 Material/dome: Glass  
 Shape: Rectangular  
 Mount.: Screw  
 Bracket: Pendant  
 E-approval: Yes

DRIVING LAMP CONVENTIONAL					
<b>170550</b> Driving Lamp Std pkg 1 Light unit: HC-CARGO 170621.					
		Bulb incl.: No Watt: 55 Watt 2: 70	Dim.: 242x166x92 mm Light aperture: 200x107 mm	Type: Driving lamp Bulb type: H3 Bulb type 2: H3 Socket type: PK22s Socket type 2: PK22s Colour: Black Material: Metal Material/dome: Glass Shape: Rectangular Mount.: Mounted below E-approval: Yes	
<b>171359</b> Driving Lamp Std pkg 2					
		Bulb incl.: No Watt: 55 Watt 2: 70	Dim.: 106x84.5x86 mm Light aperture: 55x35 mm	Type: Driving lamp Bulb type: H3 Bulb type 2: H3 Socket type: PK22s Socket type 2: PK22s Material: Shockproof plastic Material/dome: Glass Shape: Oval Mount.: U-bracket w/ 2 holes Asymmetric light: w/o E-approval: No	
<b>171361</b> Driving Lamp Std pkg 1					
		Bulb incl.: No Watt: 55 Watt 2: 70	Dim.: 154.6x75.3x69 mm Light aperture: 130x35 mm	Type: Driving lamp Bulb type: H3 Bulb type 2: H3 Socket type: PK22s Socket type 2: PK22s Material: Shockproof plastic Material/dome: Glass Shape: Rectangular Mount.: U-bracket w/ 1 bolt E-approval: No	
<b>171363</b> Driving Lamp Std pkg 1					
		Bulb incl.: No Voltage: 12/24 Watt: 55 Watt 2: 70	Dim.: 122x134x64 mm Light aperture: 95 mm	Type: Driving lamp Bulb type: H3 Bulb type 2: H3 Socket type: PK22s Socket type 2: PK22s Colour: Black Material: Metal Material/dome: Glass Shape: Round Mount.: Mounted below E-approval: No	
<b>171365</b> Driving Lamp Std pkg 1					
		Bulb incl.: No Watt: 55 Watt 2: 70	Dim.: 156x105x56 mm Light aperture: 110x75 mm	Type: Driving lamp Bulb type: H3 Bulb type 2: H3 Socket type: PK22s Socket type 2: PK22s Colour: Black Material: Metal Material/dome: Glass Shape: Rectangular Mount.: Mounted below E-approval: Yes	
<b>171451</b> Set of Driving Lamps Std pkg 1					
		Bulb incl.: Yes Voltage: 12 Watt: 55	Dim.: 138x78x68 mm Light aperture: 110x60 mm	Type: Driving lamp Bulb type: H3 Socket type: PK22s Material: Shockproof plastic Material/dome: Glass Shape: Rectangular Mount.: 1 bolt Bracket: Pendant E-approval: Yes	

**171597 Driving Lamp**

Std pkg 1

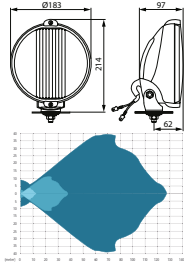

Bulb incl.: No  
Watt: 55/70  
Watt 2: 4

Dim.: 183x214x97 mm  
Light aperture:  
180 mm

Type: Driving lamp  
Bulb type: H3  
Socket type: PK22s  
Socket type 2: BA9s  
Colour: Black  
Material: Metal  
Material/dome: Glass  
Shape: Round  
Mount.: Mounted below  
Sidemarker: w/  
E-approval: Yes

**SPARE PARTS**

**170621 Light Unit**

Std pkg 1 Servicing: HC-CARGO 170550

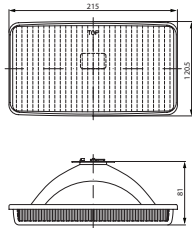

Bulb incl.: No  
Watt: 55  
Watt 2: 70

Dim.: 215x120.5x81 mm  
Light aperture:  
200x107 mm

Bulb type: H3  
Bulb type 2: H3  
Socket type: PK22s  
Socket type 2: PK22s  
Colour: Black  
Material: Metal  
Material/dome: Glass  
Shape: Rectangular  
Asymmetric light: w/o  
E-approval: Yes

**DRIVING LAMP LED**

**172059 LED Driving Lamp**

Std pkg 1

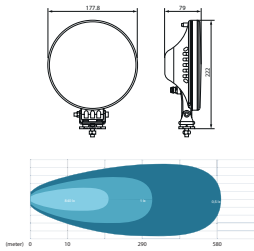

Voltage: 10-30  
Watt: 60  
Kelvin: 6000  
Lumen: 5400

Dim.: 222x177.8x79 mm

Type: LED Driving lamp  
Material: Cast aluminum  
Material/dome: Polycarbonate  
Shape: Round  
Sidemarker: w/  
No./LEDs: 6  
Tightness norm: IP 67  
Approvals: ECE R112  
E-approval: Yes

**172060 LED Driving Lamp**

Std pkg 1

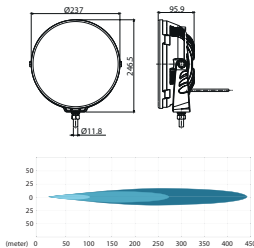

Voltage: 9-36  
Watt: 18  
Lumen: 4500

Dim.: 246.5x237x95.9 mm  
Cable length: 300 mm

Type: LED Driving lamp  
Material: Aluminium  
Material/dome: Polycarbonate  
Shape: Round  
Sidemarker: w/  
No./LEDs: 5  
Tightness norm: IP 69K  
Approvals: ECE R112  
E-approval: Yes

**172092 LED Driving Light Bar**

Std pkg 1

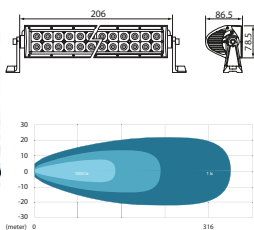

Voltage: 10-30  
Amp: 2.2/1.2  
Watt: 36  
Kelvin: 6000  
Lumen: 3240

Dim.: 206x86.5x78.5 mm  
Cable length: 500 mm

Bulb type: 12 LED  
Colour: Black  
Material/dome: Polycarbonate  
Material/house: Cast aluminum  
Shape: Straight  
Mount. bracket: Vertical  
2 poles: Male/female  
Tightness norm: IP 69K  
Approvals: ECE R112  
E-approval: Yes

**172093 LED Driving Light Bar**

Std pkg 1

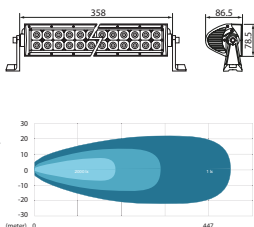

Voltage: 10-30  
Amp: 4.2/2.2  
Watt: 72  
Kelvin: 6000  
Lumen: 6480

Dim.: 358x86.5x78.5 mm  
Cable length: 500 mm

Bulb type: 24 LED  
Colour: Black  
Material/dome: Polycarbonate  
Material/house: Cast aluminum  
Shape: Straight  
Mount. bracket: Vertical  
2 poles: Male/female  
Tightness norm: IP 69K  
Approvals: ECE R112  
E-approval: Yes

**172102 LED Driving Light Bar** Std pkg 1

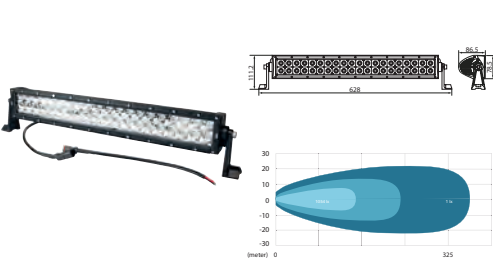

Voltage: 10-30  
Amp: 6.6/3.4  
Watt: 120  
Kelvin: 6000  
Lumen: 10800

Dim.: 628x111.2x86.5 mm  
Cable length: 500 mm

Bulb type: 40 LED  
Colour: Black  
Material/dome: Polycarbonate  
Material/house: Cast aluminum  
Shape: Straight  
Mount. bracket: Vertical  
2 poles: Male/female  
Tightness norm: IP 69K  
Approvals: ECE R112  
E-approval: Yes

**LED DAYTIME RUNNING LIGHT SETS**

**171739 Daytime Running Light** Std pkg 1

High beam 5 watt, low beam 0.5 watt.

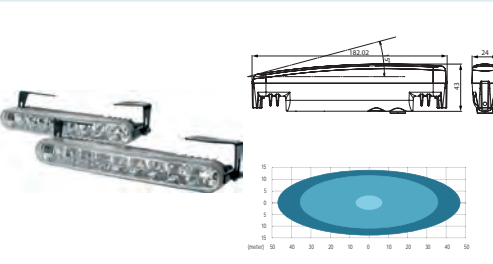

Voltage: 12/24  
Watt: 6-5.8

Dim.: 180.02x24x43 mm  
Cable length: 500 mm  
Dist. mount. holes: 110 mm

Type: LED  
Material: ABS plastic  
Material/dome: PMMA  
Shape: Rectangular  
Mount.: Bracket  
Bracket: Adjustable  
No./lamps: 2  
Fixing screw: 4  
No./LEDs: 2x18  
E-approval: Yes

**171740 Daytime Running Light** Std pkg 1

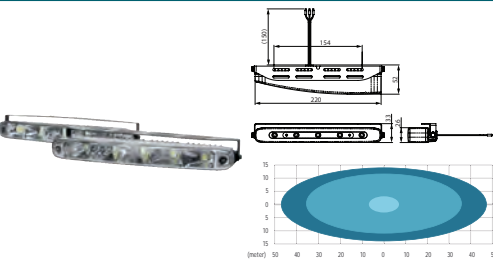

Voltage: 12/24  
Watt: 2x5

Dim.: 220x33x26 mm  
Cable length: 500 mm  
Dist. mount. holes: 215 mm

Type: LED  
Material: ABS plastic  
Material/dome: PMMA  
Shape: Rectangular  
Mount.: Bracket  
Bracket: Adjustable  
No./lamps: 2  
Fixing screw: 4  
No./LEDs: 2x5  
E-approval: Yes

**171741 Daytime Running Light** Std pkg 1

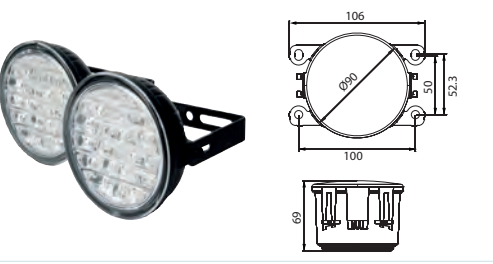

Voltage: 12/24  
Watt: 4

Dim.: 90x69 mm  
OD: 90 mm  
Cable length: 500 mm  
Dist. mount. holes: 40 mm  
Light aperture: 73 mm

Type: LED  
Material: ABS plastic  
Material/dome: PMMA  
Shape: Round  
Mount.: Bracket  
Bracket: Adjustable  
No./lamps: 2  
Fixing screw: 2  
No./LEDs: 2x18  
E-approval: Yes

**POSITION LAMPS CONVENTIONAL**

**170875 Position Lamp** Std pkg 1

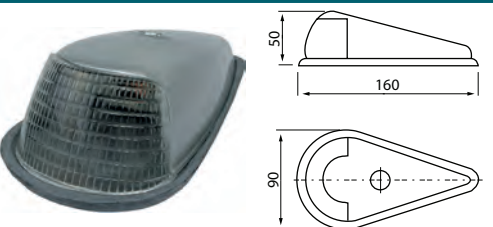

Bulb incl.: No  
Voltage: 12/24  
Watt: 5

Dim.: 160x59x45 mm  
Dist. mount. holes: 57 mm

Colour/glass: White  
Material: Plastic  
Fixing screw: 2

**170881 Position Lamp** Std pkg 1

Lens: HC-CARGO 170976.

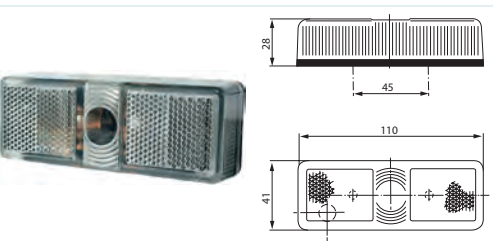

Bulb incl.: No  
Watt: 5

Dim.: 110x41x28 mm  
Dist. mount. holes: 45 mm

Socket type: S8.5  
Colour/glass: White  
Material: Shockproof plastic  
Shape: Rectangular  
Reflector: w/  
Fixing screw: 2  
Sidemark lamp: w/  
Tail light: w/  
E-approval: Yes

**170887** Position Lamp

Std pkg 1

Lens: HC-CARGO 170952.

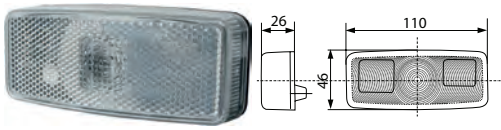

 Bulb incl.: No  
Watt: 5

 Dim.: 110x46x26 mm  
Dist. mount. holes:  
85 mm

 Socket type: T10  
Colour/glass: White  
Material: Shockproof plastic  
Shape: Rectangular  
**Reflector:** w/  
Fixing screw: 2  
Sidemark lamp: w/  
Tail light: w/  
E-approval: Yes

**171332** Position Lamp

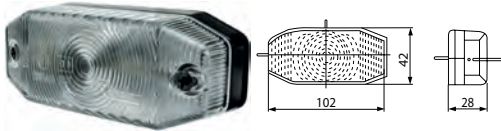
Std pkg 1



 Bulb incl.: No  
Watt: 5

 Dim.: 102x42x28 mm  
Dist. mount. holes:  
65 mm

 Socket type: S8.5  
Colour: Black  
Colour/glass: White  
Material: Plastic  
Fixing screw: 2  
E-approval: Yes

**171493** Position Lamp

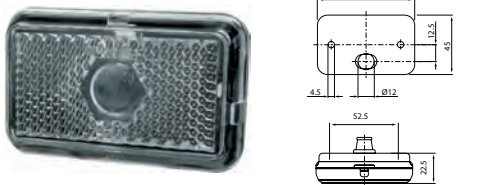
Std pkg 1

 Bulb incl.: No  
Watt: 5

 Dim.: 74x45x22.5 mm  
Dist. mount. holes:  
52 mm

 Socket type: S8.5  
Colour: Black  
Colour/glass: White  
Material: Plastic  
Shape: Rectangular  
**Reflector:** w/  
Fixing screw: 2  
E-approval: Yes

**SPARE PARTS**
**170952** Lens

Std pkg 1 Servicing: HC-CARGO 170887



Dim.: 110x46x26 mm

Shape: Rectangular

**170976** Lens

Std pkg 1 Servicing: HC-CARGO 170881

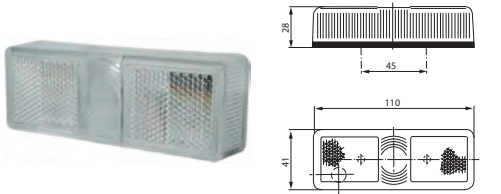

Dim.: 110x41x28 mm

Shape: Rectangular

**POSITION LAMPS LED**
**171610** LED Position Lamp

Std pkg 1

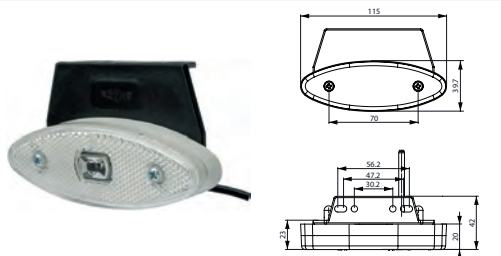
 Voltage: 24  
Watt: 0.44

 Dim.: 115x39.7x20 mm  
Cable length: 500 mm  
Dist. mount. holes:  
52 mm

 Type: LED  
Colour/glass: White  
Material: Shockproof plastic  
Shape: Oval  
Bracket: Angled  
**Reflector:** w/  
Fixing screw: 2  
Sidemark: w/  
No./LEDs: 1  
E-approval: Yes  
Alternativ no. 172044

**171638** LED Position Lamp

Std pkg 1

Angle Bracket: HC-CARGO 171639.

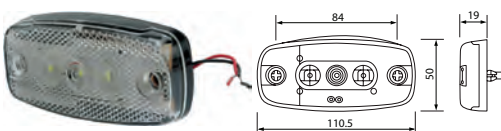
 Voltage: 9-36  
Watt: 0.9









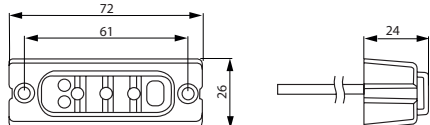

 Dim.: 110.5x50x19 mm  
Dist. mount. holes:  
83 mm

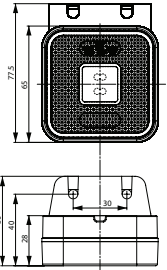
 Type: LED  
Colour/glass: White  
**Reflector:** w/  
Sidemark: w/  
No./LEDs: 3  
Approvals: ADR  
E-approval: Yes

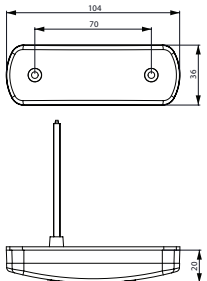
EL. SPECIFICATIONS		DIMENSIONS	ADDITIONAL SPECIFICATIONS
<b>171717 LED Position Lamp</b> Std pkg 1 		Voltage: 12/24 Watt: 0.4/0.8 Dim.: 130x57x42.5 mm	Type: LED Socket type: LED Colour/glass: White Material: Shockproof plastic Bracket: Angled Reflector: w/ Sidemarker: w/ No./LEDs: 1 E-approval: Yes
<b>171718 LED Position Lamp</b> Std pkg 1 		Voltage: 12/24 Watt: 0.4/0.8 Dim.: 130x32x20.5 mm	Type: LED Socket type: LED Colour/glass: White Material: Shockproof plastic Reflector: w/ Sidemarker: w/ No./LEDs: 1 E-approval: Yes
<b>171744 LED Position Lamp</b> Std pkg 1 		Voltage: 9-36 Dim.: 63x31 mm OD: 63 mm Cable length: 300 mm Dist. mount. holes: 30 mm	Type: LED Colour: Black Colour/glass: Transparent Material: PVC Material/dome: PMMA Shape: Round Mount.: 2 screws Sidemarker: w/ No./LEDs: 3 Approvals: ADR/SAE E-approval: Yes
<b>171841 LED Position Lamp</b> Std pkg 1 		Voltage: 12/24 Watt: 0.45-1.6 Dim.: 115x44x9.5 mm Cable length: 5000 mm Dist. mount. holes: 102 mm	Type: LED Colour: White Colour/glass: White Material: Polycarbonate Material/dome: Polycarbonate Shape: Rectangular Mount.: 2 screws Reflector: w/ Sidemarker: w/ No./LEDs: 3 Tightness norm: IP 67 Approvals: SAE E-approval: Yes
<b>171844 LED Position Lamp</b> Std pkg 1 		Voltage: 12/24 Dim.: 57x35x21 mm Cable length: 400 mm Dist. mount. holes: 28 mm	Type: LED Colour: Black Colour/glass: White Shape: Rectangular Fixing screw: 2 Sidemarker: w/ No./LEDs: 2 Tightness norm: IP 67 E-approval: Yes
<b>171862 LED Position Lamp</b> Std pkg 1 		Voltage: 12/24 Watt: 0.3-0.6 Dim.: 72x26x24 mm Cable length: 5000 mm Dist. mount. holes: 61 mm	Type: LED Colour: Black Colour/glass: White Material: PP Material/dome: PMMA Shape: Rectangular Sidemarker: w/ No./LEDs: 3 Approvals: CE E-approval: Yes

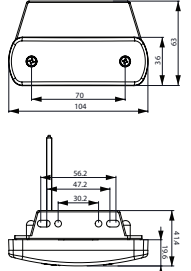
## ACCESSORIES - Lighting

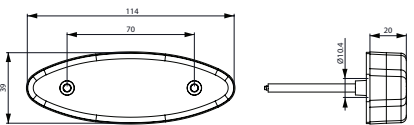
O.E.M. names and numbers are used for reference purposes only.

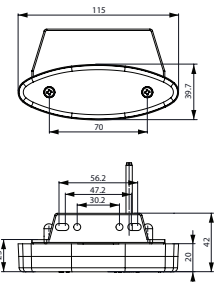
		EL. SPECIFICATIONS	DIMENSIONS	ADDITIONAL SPECIFICATIONS
<b>171868 LED Position Lamp</b> Std pkg 1				
		Voltage: 12/24 Watt: 0.3-0.6	Dim.: 72x26x24 mm Cable length: 5000 mm Dist. mount. holes: 61 mm	Type: LED Colour: Black Colour/glass: White Material: PP Material/dome: PMMA Shape: Rectangular Bracket: Adjustable Sidemarker lamp: w/ No./LEDs: 3 Approvals: CE E-approval: Yes
<b>171956 LED Side Marker Lamp</b> Std pkg 1				
		Voltage: 12-24 Watt: 1	Dim.: 65x65x28 mm Cable length: 220 mm Dist. mount. holes: 30 mm	Type: LED Colour/glass: White Material: ABS plastic Material/dome: PMMA Shape: Square Bracket: Angled Reflector: w/ Sidemarker lamp: w/ No./LEDs: 2 Tightness norm: IP 68 E-approval: Yes
<b>172038 LED Position Lamp</b> Std pkg 1				
		Voltage: 12/24 Watt: 0.49	Dim.: 104x36x20 mm Cable length: 500 mm Dist. mount. holes: 70 mm	Type: LED Colour/glass: White Material: Shockproof plastic Shape: Rectangular Reflector: w/ Fixing screw: 2 Sidemarker: w/ No./LEDs: 1 E-approval: Yes
<b>172039 LED Position Lamp</b> Std pkg 1				
		Voltage: 12/24 Watt: 0.49	Dim.: 104x36x19.6 mm Cable length: 500 mm Dist. mount. holes: 52 mm	Type: LED Colour/glass: White Material: Shockproof plastic Bracket: Angled Reflector: w/ Fixing screw: 2 Sidemarker: w/ No./LEDs: 1 E-approval: Yes
<b>172043 LED Position Lamp</b> Std pkg 1				
		Voltage: 12/24 Watt: 0.44	Dim.: 114x39x20 mm Cable length: 500 mm Dist. mount. holes: 70 mm	Type: LED Colour/glass: White Material: Shockproof plastic Reflector: w/ Fixing screw: 2 Sidemarker: w/ No./LEDs: 1 E-approval: Yes
<b>172044 LED Position Lamp</b> Std pkg 1				
		Voltage: 12/24 Watt: 0.44	Dim.: 115x39.7x20 mm Cable length: 500 mm Dist. mount. holes: 52 mm	Type: LED Colour/glass: White Material: Shockproof plastic Shape: Oval Bracket: Angled Reflector: w/ Fixing screw: 2 Sidemarker: w/ No./LEDs: 1 E-approval: Yes

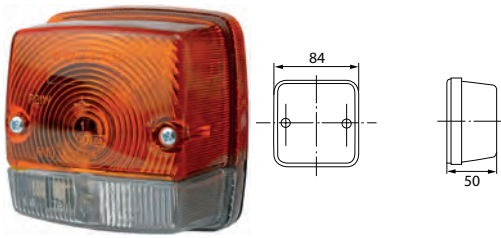

**FLASHER-POSITION LAMPS CONVENTIONAL**
**170925** Flasher/Position Lamp Std pkg 1

 Bulb incl.: No  
 Watt: 21  
 Watt 2: 5

 Dim.: 84x50 mm  
 Dist. mount. holes:  
 45 mm

 Socket type: BA15S  
 Socket type 2: S8.5  
 Material: Shockproof plastic  
 Shape: Square  
 Fixing screw: 2  
 RH/LH: RH/LH  
 E-approval: Yes

**170927** Flasher/Position Lamp Std pkg 1

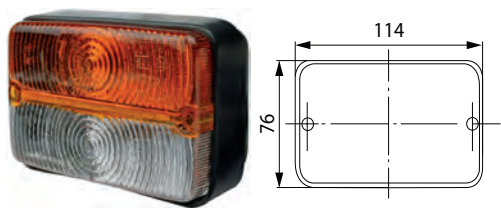
Lens: HC-CARGO 170989.



 Bulb incl.: No  
 Watt: 21  
 Watt 2: 5

 Dim.: 114x76 mm  
 Dist. mount. holes:  
 58 mm

 Socket type: BA15S  
 Socket type 2: BA15S  
 Material: Shockproof plastic  
 Shape: Rectangular  
 Fixing screw: 2  
 RH/LH: RH/LH  
 E-approval: Yes

**170941** Flasher/Position Lamp Std pkg 1 Servicing: HC-CARGO 170828

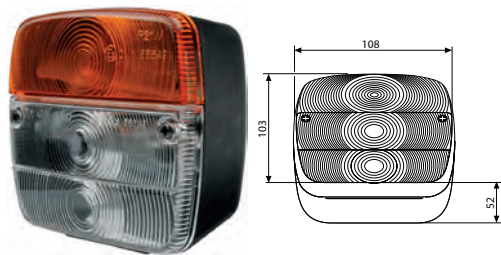
Lens: HC-CARGO 170834.



 Bulb incl.: No  
 Watt: 21  
 Watt 2: 5

 Dim.: 108x103x52 mm  
 Dist. mount. holes:  
 55 mm

 Socket type: BA15S  
 Socket type 2: S8.5  
 Material: Shockproof plastic  
 Shape: Square  
 Fixing screw: 2  
 Flasher light: w/  
 Sidemarker: w/  
 RH/LH: RH/LH  
 E-approval: Yes

**171217** Flasher/Position Lamp Std pkg 1

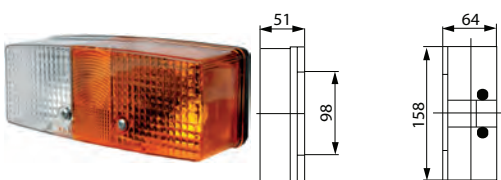
Right: HC-CARGO 171218.

 Bulb incl.: No  
 Watt: 21  
 Watt 2: 5

 Dim.: 158x64x51 mm  
 Dist. mount. holes:  
 98/45 mm

 Socket type: BA15S  
 Socket type 2: BA15S  
 Material: Shockproof plastic  
 Shape: Square  
 Fixing screw: 4  
 RH/LH: LH  
 E-approval: Yes

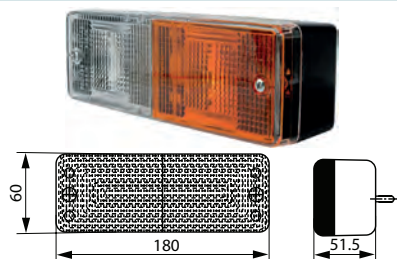
**171510** Flasher/Position Lamp Std pkg 1

 Bulb incl.: No  
 Watt: 21  
 Watt 2: 5

 Dim.: 180x60x51.5 mm  
 Dist. mount. holes:  
 134 mm

 Socket type: BA15S  
 Socket type 2: BA15S  
 Material: Shockproof plastic  
 Shape: Rectangular  
 Fixing screw: 2  
 RH/LH: RH/LH  
 E-approval: Yes

**SPARE PARTS**
**170834** Lens, Rear Lamp Std pkg 1 Servicing: HC-CARGO 170941

Dim.: 108x103x52 mm

 Shape: Square  
 Fixing screw: 2  
 Flasher light: w/  
 Sidemarker: w/

170989 Lens	Std pkg 1 Servicing: HC-CARGO 170927	Dim.: 114x76 mm	Shape: Rectangular

## FLASHER-POSITION LAMPS LED

171800 LED Flasher/Positions Lamp Std pkg 1	Voltage: 12/24	Dim.: 150x70x77 mm Cable length: 2100 mm Dist. mount. holes: 110/55 mm	Colour: Black Material: Shockproof plastic Shape: Rectangular Mount.: Upright/pendant Fixing screw: 2 No./LEDs: 14/3 RH/LH: LH E-approval: Yes

171801 LED Flasher/Positions Lamp 1	Voltage: 12/24	Dim.: 150x70x77 mm Cable length: 2100 mm Dist. mount. holes: 110/55 mm	Colour: Black Material: Shockproof plastic Shape: Rectangular Mount.: Upright/pendant Fixing screw: 2 No./LEDs: 14/3 RH/LH: RH E-approval: Yes

## SIDE INDICATORS CONVENTIONAL

170713 Side Indicator Std pkg 1	Lens: HC-CARGO 170670, 170671.		
	Bulb incl.: No Watt: 5	Dim.: 108x84x93 mm OD: 60 mm	Socket type: BA15S Colour/glass: Orange E-approval: Yes

171140 Side Indicator Std pkg 1	Servicing: Fiat, Ford, Lada, Universal - Visit <a href="http://www.hc-cargo.com">www.hc-cargo.com</a> for further information.		
		Bulb incl.: No Watt: 3	OD: 27 mm Dist. mount. holes: 28 mm
Socket type: BA9s Colour/glass: Orange E-approval: Yes			

171141 Side Indicator Std pkg 1	Servicing: Fiat 127, 129 - Visit <a href="http://www.hc-cargo.com">www.hc-cargo.com</a> for further information.		
		Bulb incl.: No	Dim.: 62x50x17 mm
Colour/glass: Orange E-approval: Yes			

171147 Side Indicator Std pkg 1	Servicing: Ford, Universal - Visit <a href="http://www.hc-cargo.com">www.hc-cargo.com</a> for further information.		
		Bulb incl.: No	Dim.: 34x34x60 mm
Colour/glass: Orange E-approval: Yes			

EL. SPECIFICATIONS		DIMENSIONS	ADDITIONAL SPECIFICATIONS
<b>171148</b> Side Indicator <span style="float: right;">Std pkg 1 Servicing: Universal, Ford, Rover Group - Visit <a href="http://www.hc-cargo.com">www.hc-cargo.com</a> for further information.</span>			
	Bulb incl.: No	Dim.: 76x24 mm	Socket type: BA9s Colour/glass: Orange E-approval: Yes
<b>171153</b> Side Indicator <span style="float: right;">Std pkg 1 Servicing: Audi, VW - Visit <a href="http://www.hc-cargo.com">www.hc-cargo.com</a> for further information.</span>			
	Bulb incl.: No Voltage: 12 Watt: 5	Dim.: 110x46x26 mm Dist. mount. holes: 86 mm	Type: Flasher lamp Colour/glass: Orange Material: Plastic Material/dome: Plastic Shape: Flat Mount.: Sidemounted No./lamps: 1 Flasher light: w/ RH/LH: RH/LH E-approval: Yes
<b>171183</b> Side Indicator <span style="float: right;">Std pkg 1</span>			
	Bulb incl.: No Watt: 5	Dim.: 80x42 mm Dist. mount. holes: 45 mm	Socket type: S8.5 Colour/glass: Orange Material: Shockproof plastic Fixing screw: 2 E-approval: Yes
<b>171337</b> Side Indicator <span style="float: right;">Std pkg 1</span>			
	Bulb incl.: No Watt: 10	Dim.: 95x73x83 mm Dist. mount. holes: 48 mm	Socket type: BA15S Colour: Black Colour/glass: Orange Material: Plastic Fixing screw: 2 E-approval: Yes
<b>171339</b> Side Indicator <span style="float: right;">Std pkg 1</span>			
	Bulb incl.: No Watt: 21	Dim.: 84x84x51 mm Dist. mount. holes: 45 mm	Socket type: BA15S Colour/glass: Orange Material: Plastic Fixing screw: 2 E-approval: Yes
<b>SPARE PARTS</b>			
<b>170670</b> Lens <span style="float: right;">Std pkg 1 Servicing: HC-CARGO 170713</span>			
			Colour/glass: Orange Material: Glass
<b>170671</b> Bulb Holder <span style="float: right;">Std pkg 1 Servicing: HC-CARGO 170640, 170668, 170713</span>			

## SIDE INDICATORS LED

171770 LED Flasher Lamp Std pkg 1

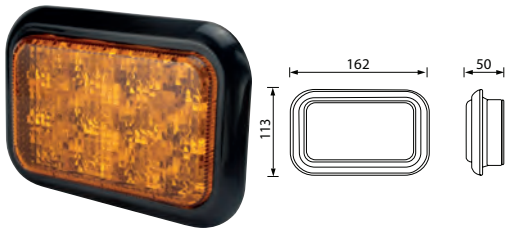

Voltage: 24  
Watt: 4

Dim.: 162x113x50 mm

Type: Flasher lamp  
Colour/glass: Orange  
Material: ABS plastic  
Material/dome: PMMA  
Shape: Rectangular  
Mount.: Plan installation  
Flasher light: w/  
No./LEDs: 16  
RH/LH: RH/LH  
E-approval: Yes

## SIDE MARKER LAMPS CONVENTIONAL

170880 Side Marker Lamp Std pkg 1

Lens: HC-CARGO 170975.

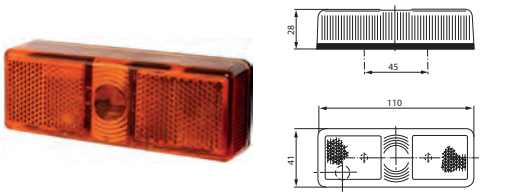

Bulb incl.: No  
Watt: 5

Dim.: 110x41x28 mm  
Dist. mount. holes:  
45 mm

Socket type: S8.5  
Colour: Black  
Colour/glass: Orange  
Material: Shockproof plastic  
Shape: Rectangular  
Reflector: w/  
Fixing screw: 2  
E-approval: Yes

170884 Side Marker Lamp Std pkg 1

Lens: HC-CARGO 170946.

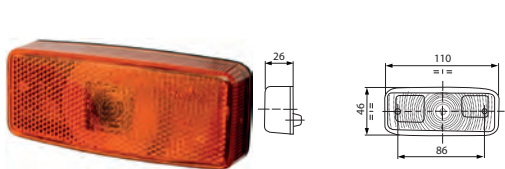

Bulb incl.: No  
Watt: 5

Dim.: 110x46x26 mm  
Dist. mount. holes:  
85 mm

Socket type: T10  
Colour/glass: Orange  
Material: Shockproof plastic  
Shape: Rectangular  
Reflector: w/  
Fixing screw: 2  
E-approval: Yes

170885 Side Marker Lamp Std pkg 1

Lens: HC-CARGO 170946.

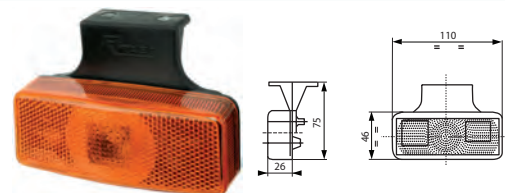

Bulb incl.: No  
Watt: 5

Dim.: 110x46x26 mm  
Dist. mount. holes:  
20/50 mm

Socket type: T10  
Colour/glass: Orange  
Material: Shockproof plastic  
Shape: Rectangular  
Bracket: Angled  
Reflector: w/  
E-approval: Yes

171343 Side Marker Lamp Std pkg 1



Bulb incl.: No  
Watt: 5

Dim.: 74x45x22.5 mm  
Dist. mount. holes:  
52 mm

Socket type: S8.5  
Colour: Black  
Colour/glass: Orange  
Material: Plastic  
Shape: Rectangular  
Fixing screw: 2  
E-approval: Yes

171369 Side Marker Lamp Std pkg 1

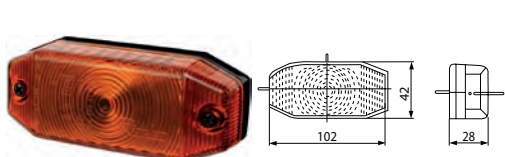

Bulb incl.: No  
Watt: 5

Dim.: 102x42x28 mm  
Dist. mount. holes:  
65 mm

Socket type: S8.5  
Colour: Black  
Colour/glass: Orange  
Material: Plastic  
Fixing screw: 2  
E-approval: Yes









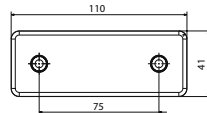
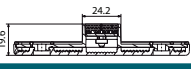

## SPARE PARTS

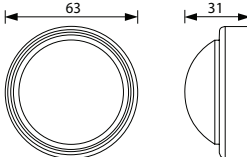

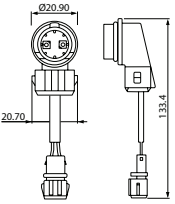
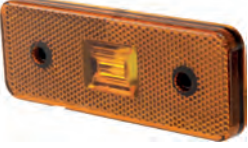
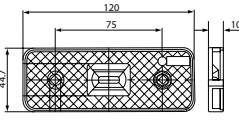

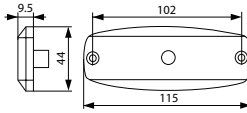

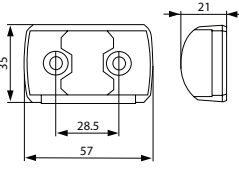

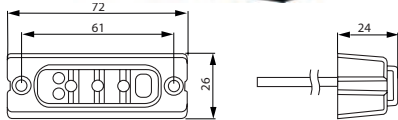
170946 Lens Std pkg 1 Servicing: HC-CARGO 170884, 170885

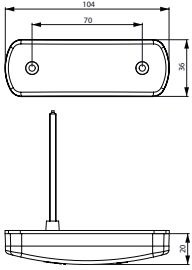

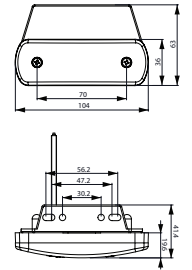
Dim.: 110x46 mm

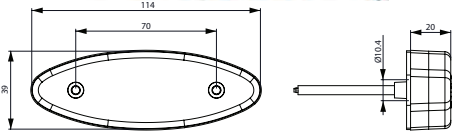
<b>170975 Lens</b> Std pkg 1 Servicing: HC-CARGO 170880				Dim.: 110x41x28 mm			
<b>SIDE MARKER LAMPS LED</b>							
<b>171618 LED Side Marker Lamp</b> Std pkg 1				Voltage: 9-36 Dim.: 131x40x34 mm Cable length: 28 mm Dist. mount. holes: 115 mm		Type: LED Colour/glass: Orange Material: PP/PMMA Material/dome: ABS plastic Mount.: Screw fastening No./lamps: 1 Fixing screw: 2 Sidemarker lamp: w/ No./LEDs: 3 Wiring system: w/ E-approval: Yes	
<b>171636 LED Side Marker Lamp</b> Std pkg 1 Angle Bracket: HC-CARGO 171639.				Voltage: 9-36 Watt: 0.9 Dim.: 109x49x18 mm Dist. mount. holes: 83 mm		Type: LED Colour/glass: Orange Shape: Rectangular Reflector: w/ Sidemarker lamp: w/ No./LEDs: 3 E-approval: Yes	
<b>171721 LED Side Marker Lamp</b> Std pkg 1				Voltage: 12/24 Dim.: 130x57x42.5 mm Dist. mount. holes: 50 mm		Type: LED Material: Shockproof plastic Shape: Rectangular Bracket: Angled Reflector: w/ Sidemarker lamp: w/ No./LEDs: 1 E-approval: Yes	
<b>171722 LED Side Marker Lamp</b> Std pkg 1				Voltage: 12/24 Dim.: 111x50.5x23 mm Dist. mount. holes: 116 mm		Type: LED Colour/glass: Orange Material: Shockproof plastic Shape: Rectangular Mount.: Flat w/ 2 fixing holes Reflector: w/ Fixing screw: 2 Sidemarker lamp: w/ No./LEDs: 1 E-approval: Yes	
<b>171729 LED Side Marker Lamp</b> Std pkg 1 Servicing: MAN - Visit <a href="http://www.hc-cargo.com">www.hc-cargo.com</a> for further information.				Voltage: 12/24 Watt: 1 Dim.: 65x65x28 mm Dist. mount. holes: 30 mm		Type: LED Colour/glass: Orange Material: ABS plastic Material/dome: PMMA Shape: Square Bracket: Angled Reflector: w/ Sidemarker lamp: w/ No./LEDs: 2 E-approval: Yes	
<b>171735 LED Side Marker Lamp</b> Std pkg 1				Voltage: 12 Dim.: 110x41x19.6 mm Cable length: 200 mm Dist. mount. holes: 75 mm		Type: LED Shape: Rectangular Sidemarker lamp: w/ No./LEDs: 1 E-approval: Yes	

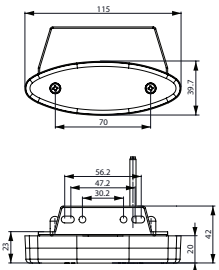
EL. SPECIFICATIONS		DIMENSIONS	ADDITIONAL SPECIFICATIONS
<b>171736 LED Side Marker Lamp</b> Std pkg 1   		Voltage: 24 Dim.: 110x41x19.6 mm Cable length: 20 mm Dist. mount. holes: 75 mm	Type: LED Shape: Rectangular Sidemarker lamp: w/ No./LEDs: 1 E-approval: Yes
<b>171742 LED Side Marker Lamp</b> Std pkg 1  		Voltage: 12/24 Dim.: 63x31 mm OD: 63 mm Cable length: 300 mm	Type: LED Colour: Black Colour/glass: Orange Material: PVC Material/dome: PMMA Mount.: 2 screws Sidemarker lamp: w/ No./LEDs: 3 Approvals: ADR/SAE E-approval: Yes
<b>171835 LED Adapter</b> Std pkg 1 <i>Lens: HC-CARGO 171836.</i>  		Voltage: 12/24	
<b>171836 Lens</b> Std pkg 1 <i>LED Adapter: HC-CARGO 171835.</i>  		Dim.: 120x44.7x10 mm	Shape: Square E-approval: Yes
<b>171839 LED Side Marker Lamp</b> Std pkg 1  		Voltage: 12/24 Watt: 0.45-1.6 Dim.: 115x44x9.5 mm Cable length: 5000 mm Dist. mount. holes: 102 mm	Type: LED Colour: White Colour/glass: Orange Material: Polycarbonate Material/dome: Polycarbonate Shape: Rectangular Mount.: 2 screws Reflector: w/ Sidemarker lamp: w/ No./LEDs: 3 Tightness norm: IP 67 Approvals: SAE E-approval: Yes
<b>171842 LED Side Marker Lamp</b> Std pkg 1  		Voltage: 12/24 Dim.: 57x35x21 mm Cable length: 400 mm Dist. mount. holes: 28.5 mm	Type: LED Colour: Black Colour/glass: Orange Material: ASA plastic Material/dome: PMMA Shape: Rectangular Fixing screw: 2 Sidemarker lamp: w/ No./LEDs: 2 Tightness norm: IP 67 E-approval: Yes
<b>171860 LED Side Marker Lamp</b> Std pkg 1  		Voltage: 12/24 Watt: 0.3-0.6 Dim.: 72x26x24 mm Cable length: 5000 mm Dist. mount. holes: 61 mm	Type: LED Colour: Black Colour/glass: Orange Material: PP Material/dome: PMMA Shape: Rectangular Fixing screw: 2 Sidemarker lamp: w/ No./LEDs: 3 Approvals: CE E-approval: Yes

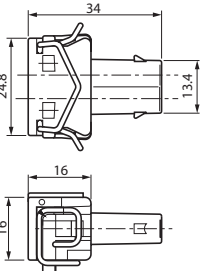
		EL. SPECIFICATIONS	DIMENSIONS	ADDITIONAL SPECIFICATIONS
<b>172036 LED Side Marker Lamp</b> Std pkg 1				
		Voltage: 12/24	Dim.: 104x36x20 mm Cable length: 500 mm Dist. mount. holes: 70 mm	Type: LED Colour/glass: Orange Material: Shockproof plastic Shape: Rectangular Reflector: w/ Fixing screw: 2 Sidemarker lamp: w/ No./LEDs: 1 E-approval: Yes
<b>172037 LED Side Marker Lamp</b> Std pkg 1				
		Voltage: 12/24	Dim.: 104x36x19.6 mm Cable length: 500 mm Dist. mount. holes: 70 mm	Type: LED Colour/glass: Orange Material: Shockproof plastic Shape: Rectangular Bracket: Angled Reflector: w/ Fixing screw: 2 Sidemarker lamp: w/ No./LEDs: 1 E-approval: Yes
<b>172041 LED Side Marker Lamp</b> Std pkg 1				
		Voltage: 12/24	Dim.: 114x39x20 mm Cable length: 500 mm Dist. mount. holes: 70 mm	Type: LED Colour/glass: Orange Material: Shockproof plastic Reflector: w/ Fixing screw: 2 Sidemarker lamp: w/ No./LEDs: 1 E-approval: Yes
<b>172042 LED Side Marker Lamp</b> Std pkg 1				
		Voltage: 12/24	Dim.: 115x39.7x20 mm Dist. mount. holes: 70 mm	Type: LED Colour/glass: Orange Material: Shockproof plastic Shape: Oval Bracket: Angled Reflector: w/ Fixing screw: 2 Sidemarker lamp: w/ No./LEDs: 1 E-approval: Yes
<b>ACCESSORIES</b>				
<b>171639 Angle Bracket</b> Std pkg 1		Servicing: HC-CARGO 171636, 171637, 171638		
				
<b>193119 Junior Power Timer Connector</b> Std pkg 10		Terminal: HC-CARGO 191551, 192155, 192175, 192176. Wire seal: HC-CARGO 192177, 192178. LED Adapter: HC-CARGO 171835.		
				Type/terminal: Junior Power Timer Colour: Black No./poles: 2 Plug: Female

## TAIL LIGHTS

### REVERSING LAMPS CONVENTIONAL

**170689** Reversing Lamp

Std pkg 1

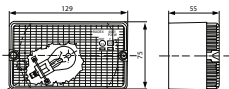

**Bulb incl.:** No  
**Watt:** 21

**Dim.:** 129x75x55 mm  
**Dist. mount. holes:** 56 mm

**Socket type:** BA15S  
**Shape:** Rectangular  
**Bracket:** Straight  
**Fixing screw:** 1  
**Reverse light:** w/  
**E-approval:** Yes

**170934** Reversing Lamp

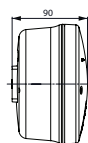
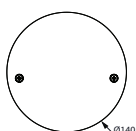
Std pkg 1



**Bulb incl.:** No  
**Watt:** 21

**Dim.:** 140x90 mm  
**Dist. mount. holes:** 45 mm

**Socket type:** BA15S  
**Colour:** Black  
**Material:** Shockproof plastic  
**Shape:** Round  
**Fixing screw:** 2  
**Reverse light:** w/  
**Wiring system:** w/  
**E-approval:** Yes

**170935** Reversing Lamp

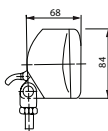
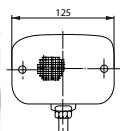
Std pkg 1



**Bulb incl.:** No  
**Watt:** 21

**Dim.:** 125x84x68 mm

**Socket type:** BA15S  
**Colour:** Black  
**Material:** Shockproof plastic  
**Shape:** Rectangular  
**Bracket:** Pendant  
**Fixing screw:** M10  
**Reverse light:** w/  
**E-approval:** Yes

**171222** Reversing Lamp

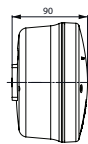
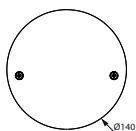
Std pkg 1



**Bulb incl.:** No  
**Voltage:** 12/24  
**Watt:** 55  
**Watt 2:** 70

**Dim.:** 140x90 mm  
**Dist. mount. holes:** 45 mm

**Bulb type:** H3  
**Bulb type 2:** H3  
**Socket type:** PK22s  
**Socket type 2:** PK22s  
**Colour:** Black  
**Material:** Shockproof plastic  
**Shape:** Round  
**Fixing screw:** 2  
**Wiring system:** w/  
**E-approval:** Yes

**172014** Reversing Lamp

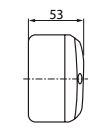
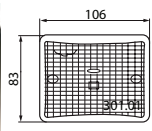
Std pkg 1

**Bulb incl.:** No  
**Watt:** 21

**Dim.:** 106x83x53 mm  
**Dist. mount. holes:** 66 mm

**Socket type:** BA15S  
**Colour:** Black  
**Colour/glass:** White  
**Material:** ABS plastic  
**Material/dome:** PMMA  
**Shape:** Rectangular  
**Fixing screw:** 2  
**Reverse light:** w/  
**Approvals:** CE  
**E-approval:** Yes  
**Alternativ no.** 170932

### REVERSING LAMPS LED

**170909** LED Fog/Reverse Lamp

Std pkg 1

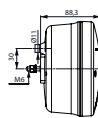
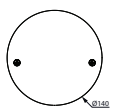
*Lens and o-ring: HC-CARGO 170910.*

**Voltage:** 12/24

**Dim.:** 140x88.3 mm  
**OD:** 140 mm  
**Dist. mount. holes:** 45 mm

**Type:** LED  
**Colour/glass:** White  
**Material:** Shockproof plastic  
**Shape:** Round  
**Fixing screw:** 2  
**Rear/fog lamp:** w/  
**Tail light:** w/  
**LEDs:** w/  
**No./LEDs:** 4  
**E-approval:** Yes



**171684 LED Reversing Lamp** Std pkg 1

Can be flush mounted by using HC-CARGO 171266.



Voltage: 9-33  
Watt: 8

Dim.: 140x52.5 mm  
Dist. mount. holes:  
45 mm

Type: Reversing lamp  
Colour: Transparent  
Material: Shockproof plastic  
Shape: Round  
No./LEDs: 61  
Approvals: ECE R23  
E-approval: Yes

**171726 LED Fog/Reverse Lamp** Std pkg 1

Ring: clear, center: red.

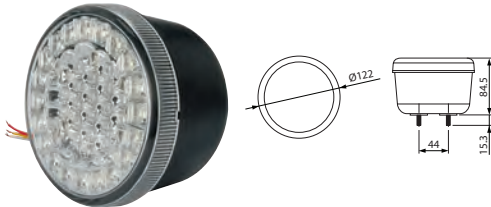

Voltage: 12/24

Dim.: 122x84.5 mm  
OD: 122 mm  
Cable length: 150 mm  
Dist. mount. holes:  
44 mm

Type: LED  
Material: Shockproof plastic  
Material/dome: Shockproof plastic  
Shape: Round  
Rear/fog lamp: w/  
Reverse light: w/  
No./LEDs: 38  
E-approval: Yes

**172007 LED Reversing Lamp** Std pkg 1

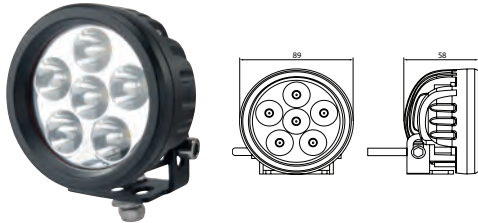

Voltage: 10-30  
Watt: 18  
Kelvin: 6000  
Lumen: 1260

Dim.: 89x58 mm

Type: Reversing lamp  
Bulb type: 6 LED  
Material: Cast aluminum  
Material/dome: Polycarbonate  
Shape: Round  
Reverse light: w/  
Tightness norm: IP 67  
Approvals: ECE R23  
E-approval: Yes

**SPARE PARTS**

**170910 Lens, Rear Lamp** Std pkg 1 Servicing: HC-CARGO 170909

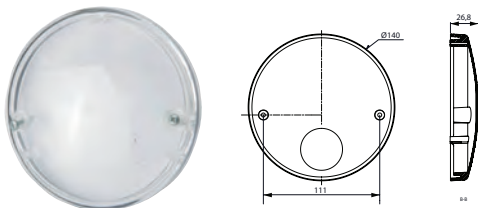

Dim.: 140x26.8 mm  
Dist. mount. holes:  
111 mm

Colour: White  
Shape: Round

**REAR FOG LAMPS CONVENTIONAL**

**170688 Rear Fog Lamp** Std pkg 1

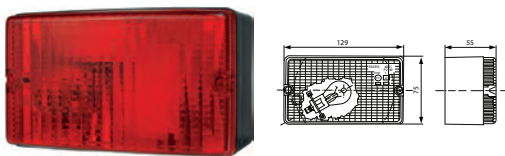

Bulb incl.: No  
Watt: 21

Dim.: 129x75x55 mm  
Dist. mount. holes:  
56 mm

Socket type: BA15S  
Shape: Rectangular  
Bracket: Straight  
Rear/fog lamp: w/  
E-approval: Yes

**170928 Rear Fog Lamp** Std pkg 1

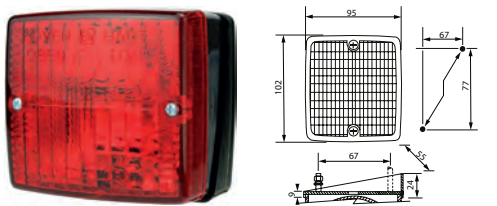

Bulb incl.: No  
Watt: 21

Dim.: 102x95x55 mm  
Dist. mount. holes:  
77 mm

Socket type: BA15S  
Colour: Black  
Material: Shockproof plastic  
Shape: Rectangular  
Fixing screw: 2  
E-approval: Yes

**170929 Rear Fog Lamp** Std pkg 1

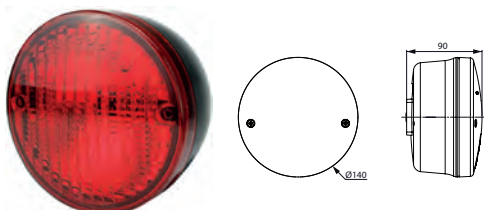

Bulb incl.: No  
Watt: 21

Dim.: 140x90 mm  
Dist. mount. holes:  
45 mm

Socket type: BA15S  
Colour: Black  
Material: Shockproof plastic  
Shape: Round  
Fixing screw: 2  
Rear/fog lamp: w/  
Wiring system: w/  
E-approval: Yes  
Alternativ no. 172117

**170930** Rear Fog Lamp

Std pkg 1

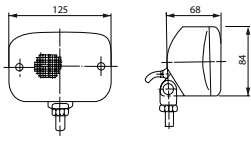
 Bulb incl.: No  
Watt: 21

Dim.: 125x84x68 mm

 Socket type: BA15S  
Colour: Black  
Material: Shockproof plastic  
Shape: Rectangular  
Bracket: Pendant  
Fixing screw: 1  
Rear/fog lamp: w/  
E-approval: Yes

**171220** Rear Fog Lamp

Std pkg 1

w/ Grommet.

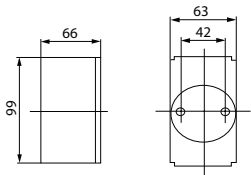
 Bulb incl.: No  
Watt: 21

 Dim.: 63x99x66 mm  
Dist. mount. holes:  
42 mm

 Socket type: BA15S  
Material: Shockproof plastic  
Shape: Rectangular  
Sidemarker: w/  
E-approval: Yes

**172117** Rear Fog Lamp

Std pkg 1

 Bulb incl.: No  
Watt: 21

 Dim.: 140x86.5 mm  
Dist. mount. holes:  
45 mm

 Socket type: BA15S  
Colour: Black  
Colour/glass: Red  
Material: Shockproof plastic  
Shape: Round  
Fixing screw: 2  
Rear/fog lamp: w/  
E-approval: Yes

**REAR FOG LAMPS LED**
**170909** LED Fog/Reverse Lamp

Std pkg 1

Lens and o-ring: HC-CARGO 170910.

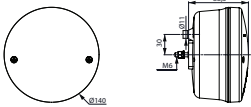

Voltage: 12/24

 Dim.: 140x88.3 mm  
OD: 140 mm  
Dist. mount. holes:  
45 mm

 Type: LED  
Colour/glass: White  
Material: Shockproof plastic  
Shape: Round  
Fixing screw: 2  
Rear/fog lamp: w/  
Tail light: w/  
LEDs: w/  
No./LEDs: 4  
E-approval: Yes

**171685** LED Rear Fog Lamp

Std pkg 1

Can be flush mounted by using HC-CARGO 171266.

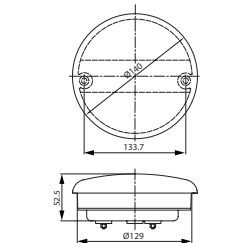

Voltage: 9-33

 Dim.: 140x52.5 mm  
Dist. mount. holes:  
45 mm

 Type: Rear fog lamp  
Colour: Red  
Material: Shockproof plastic  
Shape: Round  
Rear/fog lamp: w/  
No./LEDs: 61

**171726** LED Fog/Reverse Lamp

Std pkg 1

Ring: clear, center: red.

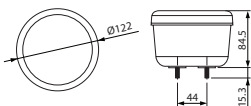

Voltage: 12/24

 Dim.: 122x84.5 mm  
OD: 122 mm  
Cable length: 150 mm  
Dist. mount. holes:  
44 mm

 Type: LED  
Material: Shockproof plastic  
Material/dome: Shockproof plastic  
Shape: Round  
Rear/fog lamp: w/  
Reverse light: w/  
No./LEDs: 38  
E-approval: Yes

**SPARE PARTS**

**170910** Lens, Rear Lamp      Std pkg 1      Servicing: HC-CARGO 170909

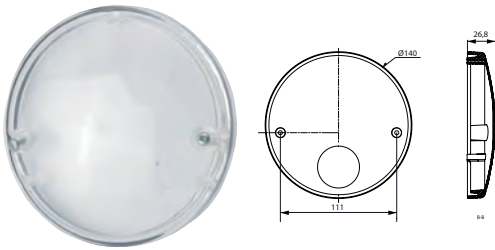

Dim.: 140x26.8 mm  
Dist. mount. holes:  
111 mm

Colour: White  
Shape: Round

**MULTI FUNCTION LAMPS**

**TRAILER LAMPS CONVENTIONAL**

**170685** Multi Function Lamp      Std pkg 1

Lens: HC-CARGO 170687.

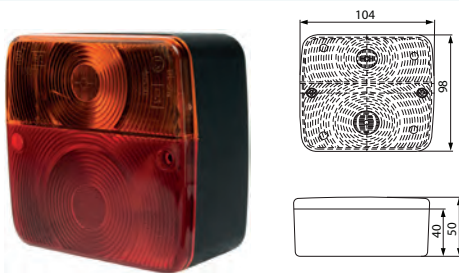

Bulb incl.: No  
Watt: 21  
Watt 2: 21/5

Dim.: 104x98x50 mm  
Dist. mount. holes:  
45/55 mm

Socket type: BA15S  
Socket type 2: BAY15d  
Material: Shockproof plastic  
Shape: Square  
Fixing screw: 2  
Flasher light: w/  
Numberplate light: With/without  
Tail light: w/  
Stop light: w/  
RH/LH: RH/LH  
E-approval: Yes

**170846** Multi Function Lamp      Std pkg 1

Lens: HC-CARGO 170847.

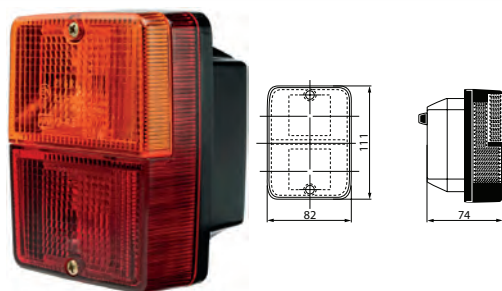

Bulb incl.: No  
Watt: 10  
Watt 2: 21/5

Dim.: 111x82x74 mm  
Dist. mount. holes:  
57/87 mm

Socket type: BA15S  
Socket type 2: BAY15d  
Material: Shockproof plastic  
Shape: Rectangular  
Fixing screw: 4  
Flasher light: w/  
Tail light: w/  
Stop light: w/  
RH/LH: RH/LH  
E-approval: Yes

**170939** Multi Function Lamp      Std pkg 1      Servicing: HC-CARGO 170809, 170828, 170829, 170835, 171049, 171935

Lens: HC-CARGO 170833.

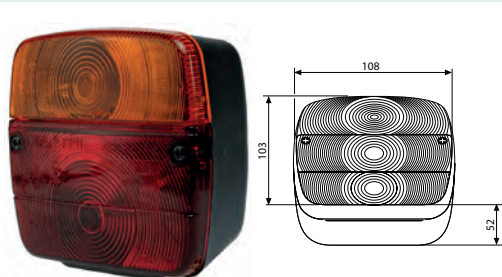

Bulb incl.: No  
Watt: 21  
Watt 2: 21/5

Dim.: 108x103x52 mm  
Dist. mount. holes:  
45/55 mm

Socket type: BA15S  
Socket type 2: BAY15d  
Material: Shockproof plastic  
Shape: Square  
Fixing screw: 2  
Flasher light: w/  
Tail light: w/  
Stop light: w/  
RH/LH: RH/LH  
E-approval: Yes

**170940** Multi Function Lamp      Std pkg 1      Servicing: HC-CARGO 170829

Lens: HC-CARGO 170833.

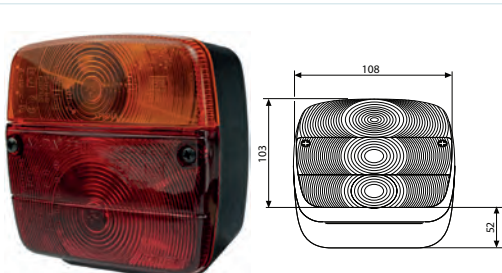

Bulb incl.: No  
Watt: 21  
Watt 2: 21/5

Dim.: 108x103x52 mm  
Dist. mount. holes:  
45/55 mm

Socket type: BA15S  
Socket type 2: BAY15d  
Material: Shockproof plastic  
Shape: Square  
Fixing screw: 2  
Flasher light: w/  
Numberplate light: w/  
Tail light: w/  
Stop light: w/  
RH/LH: RH/LH  
E-approval: Yes

**170943 Multi Function Lamp** Std pkg 1

Lens: HC-CARGO 170944.

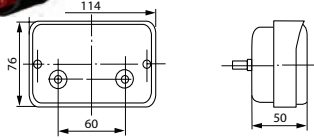

Bulb incl.: No  
Watt: 21  
Watt 2: 21/5

Dim.: 114x76x50 mm  
Dist. mount. holes:  
60 mm

Socket type: BA15S  
Socket type 2: BAY15d  
Material: Shockproof plastic  
Shape: Rectangular  
Fixing screw: 2  
Flasher light: w/  
Tail light: w/  
Stop light: w/  
RH/LH: RH/LH  
E-approval: Yes

**170985 Multi Function Lamp** Std pkg 1

Lens: HC-CARGO 170987.

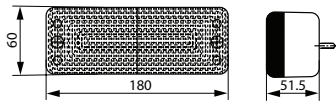

Bulb incl.: No  
Watt: 10  
Watt 2: 21/5

Dim.: 180x60x51.5 mm  
Dist. mount. holes:  
134 mm

Socket type: BA15S  
Socket type 2: BAY15d  
Material: Shockproof plastic  
Shape: Rectangular  
Fixing screw: 2  
Flasher light: w/  
Tail light: w/  
Stop light: w/  
RH/LH: RH/LH  
E-approval: Yes

**170986 Multi Function Lamp** Std pkg 1

Lens: HC-CARGO 170987.

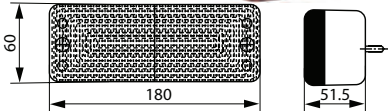

Bulb incl.: No  
Watt: 10  
Watt 2: 21/5

Dim.: 180x60x51.5 mm  
Dist. mount. holes:  
134 mm

Socket type: BA15S  
Socket type 2: BAY15d  
Material: Shockproof plastic  
Shape: Rectangular  
Fixing screw: 2  
Flasher light: w/  
Numberplate light: w/  
Tail light: w/  
Stop light: w/  
RH/LH: RH/LH  
E-approval: Yes

**171013 Multi Function Lamp** Std pkg 1

Lens: HC-CARGO 171015. Right: HC-CARGO 171014.

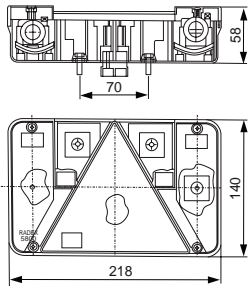

Bulb incl.: No  
Watt: 21  
Watt 2: 21/5

Dim.: 218x140x58 mm  
Dist. mount. holes:  
70 mm

Socket type: BA15S  
Socket type 2: BAY15d  
Material: Shockproof plastic  
Shape: Rectangular  
Reflector: w/  
Fixing screw: 2  
Flasher light: w/  
Numberplate light: w/  
Rear/fog lamp: w/o  
Reverse light: w/o  
Sidemarker lamp: w/o  
Tail light: w/  
Stop light: w/  
RH/LH: LH  
E-approval: Yes

**171014 Multi Function Lamp** Std pkg 1

Lens: HC-CARGO 171016. Left: HC-CARGO 171013.

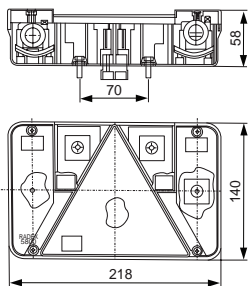

Bulb incl.: No  
Watt: 21  
Watt 2: 21/5

Dim.: 218x140x58 mm  
Dist. mount. holes:  
70 mm

Socket type: BA15S  
Socket type 2: BAY15d  
Material: Shockproof plastic  
Shape: Rectangular  
Reflector: w/  
Fixing screw: 2  
Flasher light: w/  
Numberplate light: w/  
Rear/fog lamp: w/o  
Reverse light: w/o  
Sidemarker lamp: w/o  
Tail light: w/  
Stop light: w/  
RH/LH: RH

**171050 Multi Function Lamp** Std pkg 1

Lens: HC-CARGO 171057. Plug: HC-CARGO 171372, 171373. Right: HC-CARGO 171053.

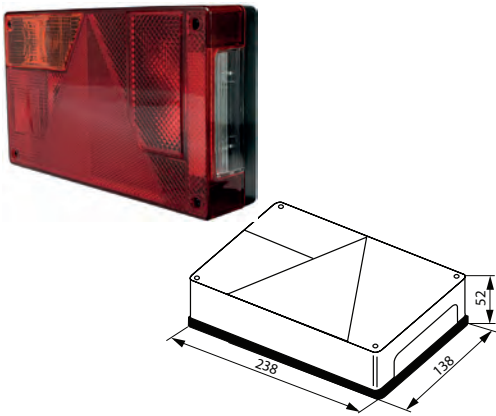

Bulb incl.: No  
Watt: 21  
Watt 2: 21/5  
Watt 3: 5

Dim.: 238x138x52 mm  
Dist. mount. holes:  
152 mm

Socket type: BA15S  
Socket type 2: BAY15d  
Socket type 3: S8.5  
Material: Shockproof plastic  
Shape: Rectangular  
Reflector: w/  
Fixing screw: 2  
Flasher light: w/  
Numberplate light: w/  
Rear/fog lamp: w/  
Reverse light: w/o  
Sidemarker lamp: w/o  
Tail light: w/  
Stop light: w/  
RH/LH: LH  
E-approval: Yes

**171051 Multi Function Lamp** Std pkg 1

Lens: HC-CARGO 171056. Plug: HC-CARGO 171372, 171373. Left: HC-CARGO 171054.

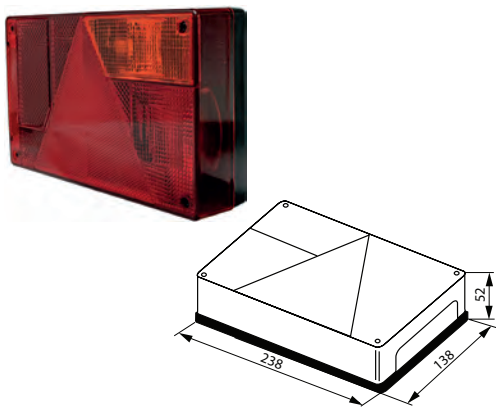

Bulb incl.: No  
Watt: 21  
Watt 2: 21/5  
Watt 3: 5

Dim.: 238x138x52 mm  
Dist. mount. holes:  
152 mm

Socket type: BA15S  
Socket type 2: BAY15d  
Socket type 3: S8.5  
Material: Shockproof plastic  
Shape: Rectangular  
Reflector: w/  
Fixing screw: 2  
Flasher light: w/  
Numberplate light: w/  
Rear/fog lamp: w/o  
Reverse light: w/o  
Sidemarker lamp: w/o  
Tail light: w/  
Stop light: w/  
RH/LH: RH  
E-approval: Yes

**171052 Multi Function Lamp** Std pkg 1

Lens: HC-CARGO 171058. Supplied w/ HC-CARGO 171372, 171373. Left: HC-CARGO 171055.

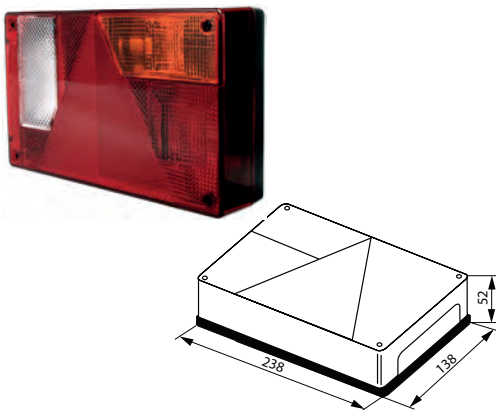

Bulb incl.: No  
Watt: 21  
Watt 2: 21/5  
Watt 3: 5

Dim.: 238x138x52 mm  
Dist. mount. holes:  
152 mm

Socket type: BA15S  
Socket type 2: BAY15d  
Socket type 3: S8.5  
Material: Shockproof plastic  
Shape: Rectangular  
Reflector: w/  
Fixing screw: 2  
Flasher light: w/  
Numberplate light: w/  
Reverse light: w/  
Rear/fog lamp: w/o  
Sidemarker lamp: w/o  
Tail light: w/  
Stop light: w/  
RH/LH: RH  
E-approval: Yes

**171053 Multi Function Lamp** Std pkg 1

Lens: HC-CARGO 171056. Multi Connector: HC-CARGO 171372, 171373. Left: HC-CARGO 171050.

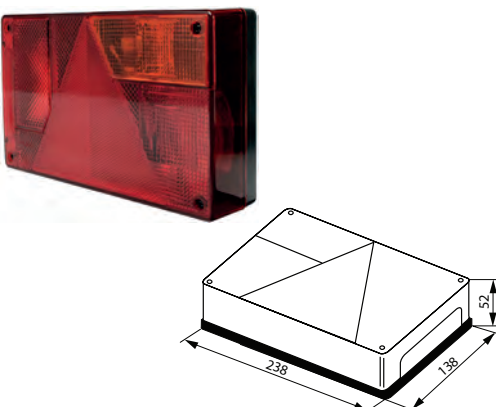

Bulb incl.: No  
Watt: 21  
Watt 2: 21/5  
Watt 3: 5

Dim.: 238x138x52 mm  
Dist. mount. holes:  
152 mm

Socket type: BA15S  
Socket type 2: BAY15d  
Socket type 3: S8.5  
Material: Shockproof plastic  
Shape: Rectangular  
Reflector: w/  
Fixing screw: 2  
Flasher light: w/  
Numberplate light: w/  
Rear/fog lamp: w/  
Reverse light: w/o  
Sidemarker lamp: w/o  
Tail light: w/  
Stop light: w/  
RH/LH: RH  
E-approval: Yes

**171054 Multi Function Lamp** Std pkg 1

Lens: HC-CARGO 171057. Plug: HC-CARGO 171372, 171373. Right: HC-CARGO 171051.

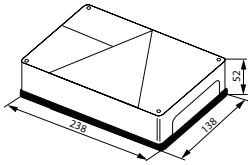

Bulb incl.: No  
Watt: 21  
Watt 2: 21/5  
Watt 3: 5

Dim.: 238x138x52 mm  
Dist. mount. holes:  
152 mm

Socket type: BA15S  
Socket type 2: BAY15d  
Socket type 3: S8.5  
Material: Shockproof plastic  
Shape: Rectangular  
Reflector: w/  
Fixing screw: 2  
Flasher light: w/  
Numberplate light: w/  
Rear/fog lamp: w/o  
Reverse light: w/o  
Sidemarker lamp: w/o  
Tail light: w/  
Stop light: w/  
RH/LH: LH  
E-approval: Yes

**171055 Multi Function Lamp** Std pkg 1

Lens: HC-CARGO 171059. Plug: HC-CARGO 171372, 171373. Right: HC-CARGO 171052.

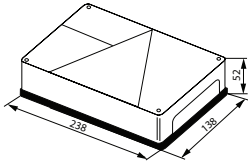

Bulb incl.: No  
Watt: 21  
Watt 2: 21/5  
Watt 3: 5

Dim.: 238x138x52 mm  
Dist. mount. holes:  
152 mm

Socket type: BA15S  
Socket type 2: BAY15d  
Socket type 3: S8.5  
Material: Shockproof plastic  
Shape: Rectangular  
Reflector: w/  
Fixing screw: 2  
Flasher light: w/  
Numberplate light: w/  
Reverse light: w/  
Rear/fog lamp: w/o  
Sidemarker lamp: w/o  
Tail light: w/  
Stop light: w/  
RH/LH: LH  
E-approval: Yes

**171192 Multi Function Lamp** Std pkg 1

Mounting kit: HC-CARGO 171266. Lens: HC-CARGO 171237.

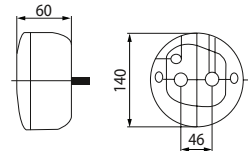

Bulb incl.: No  
Watt: 21  
Watt 2: 5

Dim.: 140x60 mm  
OD: 140 mm  
Dist. mount. holes:  
46 mm

Socket type: BA15S  
Socket type 2: BA15S  
Material: Shockproof plastic  
Shape: Round  
Fixing screw: 2  
Flasher light: w/  
Numberplate light: w/  
Tail light: w/  
Stop light: w/  
E-approval: Yes

**171193 Multi Function Lamp** Std pkg 1

Mounting kit: HC-CARGO 171266. Lens: HC-CARGO 171237.

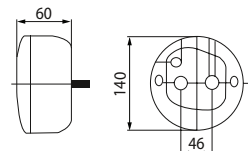

Bulb incl.: No  
Watt: 21  
Watt 2: 5

Dim.: 140x60 mm  
OD: 140 mm  
Dist. mount. holes:  
46 mm

Socket type: BA15S  
Socket type 2: BA15S  
Material: Shockproof plastic  
Shape: Round  
Fixing screw: 2  
Flasher light: w/  
Tail light: w/  
Stop light: w/  
E-approval: Yes

**171195 Multi Function Lamp** Std pkg 1

Mounting kit: HC-CARGO 171266. Lens: HC-CARGO 171237.

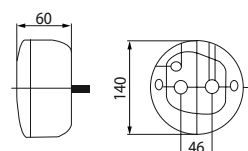

Bulb incl.: No  
Watt: 21  
Watt 2: 5

Dim.: 140x60 mm  
OD: 140 mm  
Dist. mount. holes:  
46 mm

Socket type: BA15S  
Socket type 2: BA15S  
Material: Shockproof plastic  
Shape: Round  
Fixing screw: 2  
Flasher light: w/  
Tail light: w/  
Stop light: w/  
E-approval: Yes

**171202 Multi Function Lamp** Std pkg 2

Lens: HC-CARGO 171253.

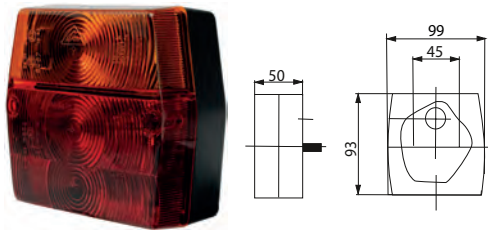

Bulb incl.: No  
Watt: 21  
Watt 2: 5

Dim.: 93x99x50 mm  
Dist. mount. holes:  
45 mm

Socket type: BA15S  
Socket type 2: S8.5  
Material: Shockproof plastic  
Shape: Hexagon  
Fixing screw: 2  
Flasher light: w/  
Tail light: w/  
Stop light: w/  
E-approval: Yes

**171203 Multi Function Lamp** Std pkg 1

Lens: HC-CARGO 171258. Right: HC-CARGO 171204.

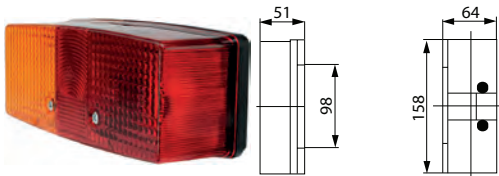

Bulb incl.: No  
Watt: 21/5  
Watt 2: 10

Dim.: 158x64x51 mm  
Dist. mount. holes:  
98/45 mm

Socket type: BAY15d  
Socket type 2: BA15S  
Material: Shockproof plastic  
Shape: Rectangular  
Reflector: w/  
Fixing screw: 4  
Flasher light: w/  
Numberplate light: w/  
Tail light: w/  
Stop light: w/  
RH/LH: LH  
E-approval: Yes

**171213 Multi Function Lamp** Std pkg 1

Lens: HC-CARGO 171264. Right: HC-CARGO 171214.

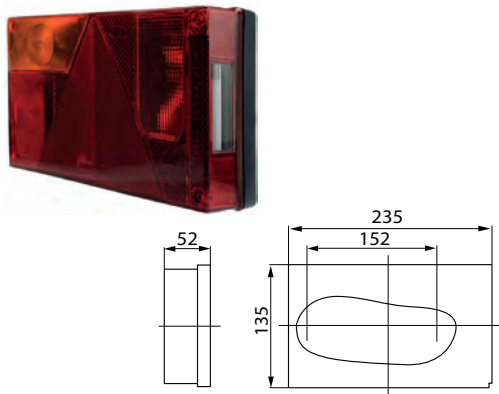

Bulb incl.: No  
Watt: 21  
Watt 2: 21/5  
Watt 3: 5

Dim.: 235x135x52 mm  
Dist. mount. holes:  
152 mm

Socket type: BA15S  
Socket type 2: BAY15d  
Socket type 3: S8.5  
Material: Shockproof plastic  
Shape: Rectangular  
Reflector: w/  
Fixing screw: 2  
Flasher light: w/  
Numberplate light: w/  
Rear/fog lamp: w/o  
Reverse light: w/o  
Sidemarker lamp: w/o  
Tail light: w/  
Stop light: w/  
RH/LH: LH  
E-approval: Yes  
Alternativ no. 171050

**171214 Multi Function Lamp** Std pkg 1

Lens: HC-CARGO 171265. Left: HC-CARGO 171213.

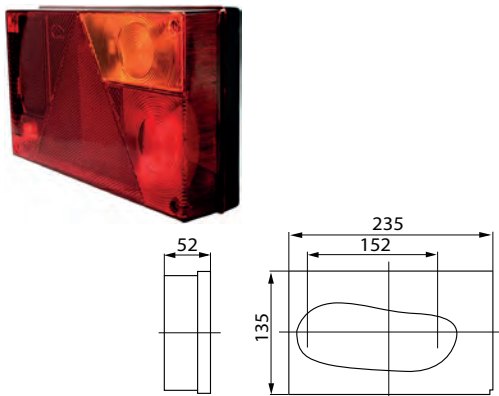

Bulb incl.: No  
Watt: 21  
Watt 2: 21/5  
Watt 3: 5

Dim.: 235x135x52 mm  
Dist. mount. holes:  
152 mm

Socket type: BA15S  
Socket type 2: BAY15d  
Socket type 3: S8.5  
Material: Shockproof plastic  
Shape: Rectangular  
Reflector: w/  
Fixing screw: 2  
Flasher light: w/  
Numberplate light: w/  
Rear/fog lamp: w/o  
Reverse light: w/o  
Sidemarker lamp: w/o  
Tail light: w/  
Stop light: w/  
RH/LH: RH  
E-approval: Yes  
Alternativ no. 171053

**171328 Multi Function Lamp** Std pkg 1

Lens: HC-CARGO 171330.

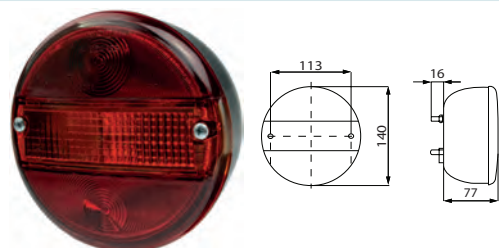

Bulb incl.: No  
Watt: 21  
Watt 2: 5

Dim.: 140x77 mm  
OD: 140 mm  
Dist. mount. holes:  
45 mm

Socket type: BA15S  
Socket type 2: BA15S  
Material: Shockproof plastic  
Shape: Round  
Fixing screw: 2  
Flasher light: w/  
Numberplate light: w/  
Tail light: w/  
Stop light: w/  
E-approval: Yes

**171329 Multi Function Lamp** Std pkg 1

Mounting kit: HC-CARGO 171266. Lens: HC-CARGO 171330.

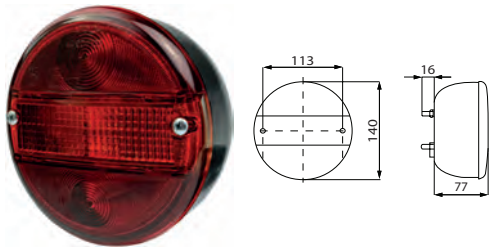

Bulb incl.: No

 Dim.: 140x77 mm  
 OD: 140 mm  
 Dist. mount. holes:  
 45 mm

 Socket type: BA15S  
 Material: Shockproof plastic  
 Shape: Round  
 Fixing screw: 2  
 Flasher light: w/  
 Tail light: w/  
 Stop light: w/  
 E-approval: Yes

**171533 Multi Function Lamp** Std pkg 1

Lens: HC-CARGO 171015. Plug: HC-CARGO 171537, 171538. Right: HC-CARGO 171534.

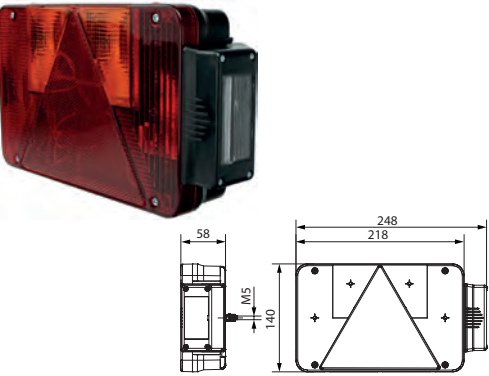

 Bulb incl.: No  
 Watt: 21  
 Watt 2: 21/5  
 Watt 3: 5

 Dim.: 248x140x58 mm  
 Dist. mount. holes:  
 70 mm

 Socket type: BA15S  
 Socket type 2: BAY15d  
 Socket type 3: S8.5  
 Material: Shockproof plastic  
 Shape: Rectangular  
 Reflector: w/  
 Fixing screw: 2  
 Flasher light: w/  
 Numberplate light: w/  
 Rear/fog lamp: w/o  
 Reverse light: w/o  
 Sidemarker lamp: w/o  
 Tail light: w/  
 Stop light: w/  
 RH/LH: LH  
 E-approval: Yes

**171534 Multi Function Lamp** Std pkg 1

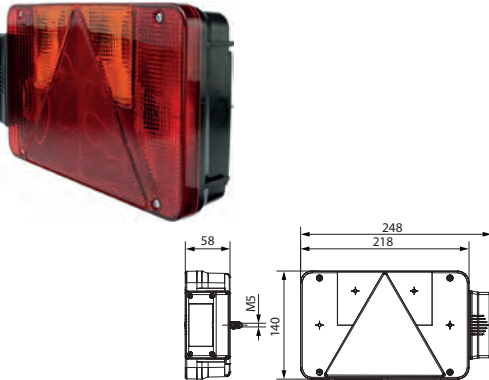
Lens: HC-CARGO 171016. Plug: HC-CARGO 171537, 171538. Left: HC-CARGO 171533.



 Bulb incl.: No  
 Watt: 21  
 Watt 2: 21/5  
 Watt 3: 5

 Dim.: 248x140x58 mm  
 Dist. mount. holes:  
 70 mm

 Socket type: BA15S  
 Socket type 2: BAY15d  
 Socket type 3: S8.5  
 Material: Shockproof plastic  
 Shape: Rectangular  
 Reflector: w/  
 Fixing screw: 2  
 Flasher light: w/  
 Numberplate light: w/  
 Rear/fog lamp: w/o  
 Reverse light: w/o  
 Sidemarker lamp: w/o  
 Tail light: w/  
 Stop light: w/  
 RH/LH: RH  
 E-approval: Yes

**171822 Multi Function Lamp** Std pkg 1 Servicing: HC-CARGO 171821

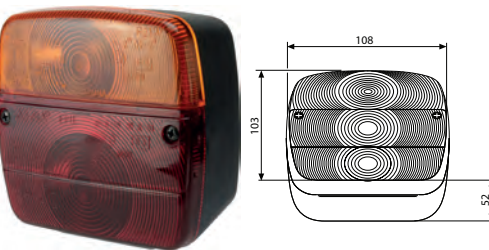
Multi connector: HC-CARGO 171372, 171373. Lens: HC-CARGO 170833.

 Bulb incl.: Yes  
 Watt: 21  
 Watt 2: 21/5

 Dim.: 108x103x52 mm  
 Dist. mount. holes:  
 45/55 mm

 Socket type: BA15S  
 Socket type 2: BAY15d  
 Shape: Square  
 Flasher light: w/  
 Sidemarker: w/  
 Stop light: w/  
 E-approval: Yes

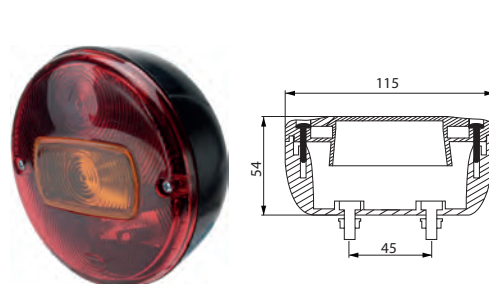
**171917 Multi Function Lamp** Std pkg 1

 Bulb incl.: No  
 Watt: 5  
 Watt 2: 18  
 Watt 3: 18

 Dim.: 115x54 mm  
 OD: 115 mm  
 Dist. mount. holes:  
 45 mm

 Bulb type: 10.5x36 mm  
 Bulb type 2: 15x41 mm  
 Bulb type 3: 15x41 mm  
 Socket type: S8.5  
 Socket type 2: S8.5  
 Socket type 3: S8.5  
 Colour/glass: Red/yellow  
 Material/dome: PMMA  
 Shape: Round  
 Fixing screw: 2  
 Flasher light: w/  
 Tail light: w/  
 Stop light: w/  
 RH/LH: RH/LH



**172021 Multi Function Lamp** Std pkg 1

Lens: HC-CARGO 172023. Multi Connector: HC-CARGO 171537, 171538. Right: HC-CARGO 172022.

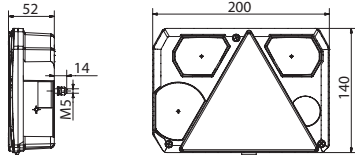

Bulb incl.: No  
Watt: 21  
Watt 2: 21/5  
Watt 3: 5

Dim.: 200x140x52 mm  
Dist. mount. holes: 152 mm

Socket type: BA15S  
Socket type 2: BAY15d  
Socket type 3: S8.5  
Material: Shockproof plastic  
Shape: Rectangular  
Reflector: w/  
Fixing screw: 2  
Flasher light: w/  
Numberplate light: w/  
Rear/fog lamp: w/  
Reverse light: w/o  
Sidemarker lamp: w/o  
Tail light: w/  
Stop light: w/  
RH/LH: LH  
E-approval: Yes

**172022 Multi Function Lamp** Std pkg 1

Lens: HC-CARGO 172024. Multi Connector: HC-CARGO 171537, 171538. Left: HC-CARGO 172021.

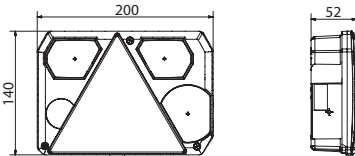

Bulb incl.: No  
Watt: 21  
Watt 2: 21/5  
Watt 3: 5

Dim.: 200x140x52 mm  
Dist. mount. holes: 152 mm

Socket type: BA15S  
Socket type 2: BAY15d  
Socket type 3: S8.5  
Material: Shockproof plastic  
Shape: Rectangular  
Reflector: w/  
Fixing screw: 2  
Flasher light: w/  
Numberplate light: w/  
Reverse light: w/  
Rear/fog lamp: w/o  
Sidemarker lamp: w/o  
Tail light: w/  
Stop light: w/  
RH/LH: RH  
E-approval: Yes

**172025 Multi Function Lamp** Std pkg 1

Lens: HC-CARGO 172023. Plug: HC-CARGO 171537, 171538. Right: HC-CARGO 172026

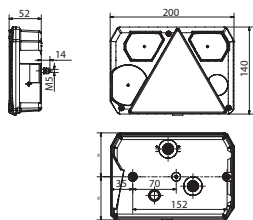

Bulb incl.: Yes  
Voltage: 12  
Watt: 21  
Watt 2: 21/5  
Watt 3: 5

Dim.: 200x140x52 mm  
Dist. mount. holes: 152 mm

Socket type: BA15S  
Socket type 2: BAY15d  
Socket type 3: S8.5  
Material: Shockproof plastic  
Shape: Rectangular  
Reflector: w/  
Fixing screw: 2  
Flasher light: w/  
Numberplate light: w/  
Rear/fog lamp: w/  
Reverse light: w/o  
Sidemarker lamp: w/o  
Tail light: w/  
Stop light: w/  
RH/LH: LH  
E-approval: Yes

**172026 Multi Function Lamp** Std pkg 1

Lens: HC-CARGO 172024. Plug: HC-CARGO 171537, 171538. Left: HC-CARGO 172025.

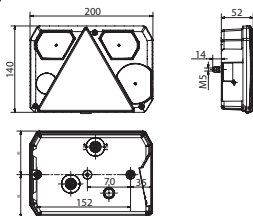

Bulb incl.: Yes  
Voltage: 12  
Watt: 21  
Watt 2: 21/5  
Watt 3: 5

Dim.: 200x140x52 mm  
Dist. mount. holes: 152 mm

Socket type: BA15S  
Socket type 2: BAY15d  
Socket type 3: S8.5  
Material: Shockproof plastic  
Shape: Rectangular  
Reflector: w/  
Fixing screw: 2  
Flasher light: w/  
Numberplate light: w/  
Reverse light: w/  
Rear/fog lamp: w/o  
Sidemarker lamp: w/o  
Tail light: w/  
Stop light: w/  
RH/LH: RH  
E-approval: Yes

**172047 Multi Function Lamp** Std pkg 1

Lens: HC-CARGO 172051. Plug: HC-CARGO 171537, 171538. Right: HC-CARGO 172048.

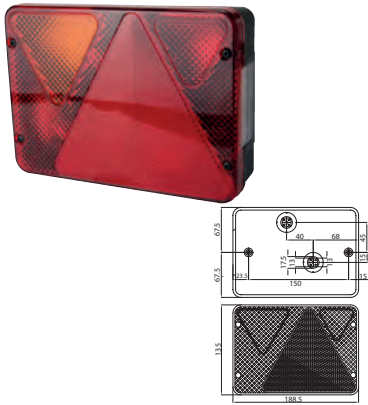

Bulb incl.: Yes  
Voltage: 12  
Watt: 21  
Watt 2: 21/5  
Watt 3: 5

Dim.:  
188.5x135x50.5 mm  
Dist. mount. holes:  
150 mm

Socket type: BA15S  
Socket type 2: BAY15d  
Socket type 3: S8.5  
Colour: Black  
Material: Polypropylene  
Material/dome: PMMA  
Shape: Rectangular  
Reflector: w/  
Fixing screw: 2  
Flasher light: w/  
Numberplate light: w/  
Rear/fog lamp: w/  
Reverse light: w/o  
Sidemarker lamp: w/o  
Tail light: w/  
Stop light: w/  
RH/LH: LH  
E-approval: Yes

**172048 Multi Function Lamp** Std pkg 1

Lens: HC-CARGO 172052. Plug: HC-CARGO 171537, 171538. Left: HC-CARGO 172047.

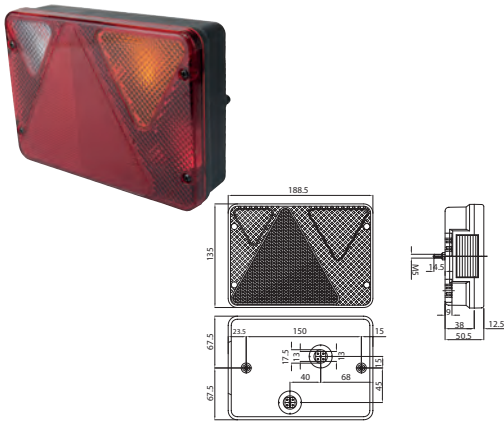

Bulb incl.: Yes  
Voltage: 12  
Watt: 21  
Watt 2: 21/5  
Watt 3: 5

Dim.:  
188.5x135x50.5 mm  
Dist. mount. holes:  
150 mm

Socket type: BA15S  
Socket type 2: BAY15d  
Socket type 3: S8.5  
Colour: Black  
Material: Polypropylene  
Material/dome: PMMA  
Shape: Rectangular  
Reflector: w/  
Fixing screw: 2  
Flasher light: w/  
Numberplate light: w/  
Rear/fog lamp: w/  
Reverse light: w/o  
Sidemarker lamp: w/o  
Tail light: w/  
Stop light: w/  
RH/LH: RH  
E-approval: Yes

**172049 Multi Function Lamp** Std pkg 1 Servicing: UK - Visit [www.hc-cargo.com](http://www.hc-cargo.com) for further information.

Lens: HC-CARGO 172057. Plug: HC-CARGO 171537, 171538. Left: HC-CARGO 172050.

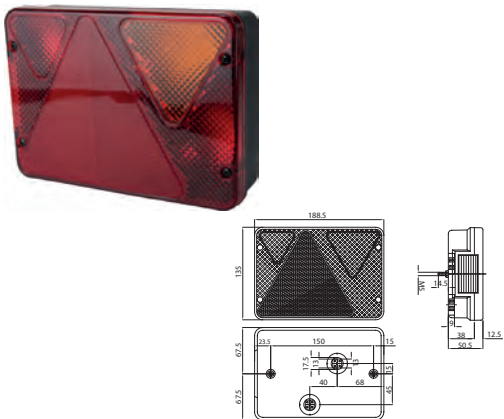

Bulb incl.: Yes  
Voltage: 12  
Watt: 21  
Watt 2: 21/5  
Watt 3: 5

Dim.:  
188.5x135x50.5 mm  
Dist. mount. holes:  
150 mm

Socket type: BA15S  
Socket type 2: BAY15d  
Socket type 3: S8.5  
Colour: Black  
Material: Polypropylene  
Material/dome: PMMA  
Shape: Rectangular  
Reflector: w/  
Fixing screw: 2  
Flasher light: w/  
Numberplate light: w/  
Rear/fog lamp: w/  
Reverse light: w/o  
Sidemarker lamp: w/o  
Tail light: w/  
Stop light: w/  
RH/LH: RH  
E-approval: Yes

**172050 Multi Function Lamp** Std pkg 1 Servicing: UK - Visit [www.hc-cargo.com](http://www.hc-cargo.com) for further information.

Lens: HC-CARGO 172058. Plug: HC-CARGO 171537, 171538. Right: HC-CARGO 172049.

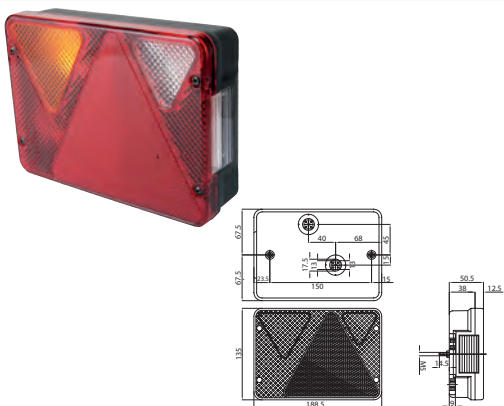

Bulb incl.: Yes  
Voltage: 12  
Watt: 21  
Watt 2: 21/5  
Watt 3: 5

Dim.:  
188.5x135x50.5 mm  
Dist. mount. holes:  
150 mm

Socket type: BA15S  
Socket type 2: BAY15d  
Socket type 3: S8.5  
Colour: Black  
Material: Polypropylene  
Material/dome: PMMA  
Shape: Rectangular  
Reflector: w/  
Fixing screw: 2  
Flasher light: w/  
Numberplate light: w/  
Rear/fog lamp: w/  
Reverse light: w/o  
Sidemarker lamp: w/o  
Tail light: w/  
Stop light: w/  
RH/LH: LH  
E-approval: Yes

**172068 Multi Function Lamp** Std pkg 1

Lens: HC-CARGO 172070. Plug: HC-CARGO 171537, 171538. Right: HC-CARGO 172069.

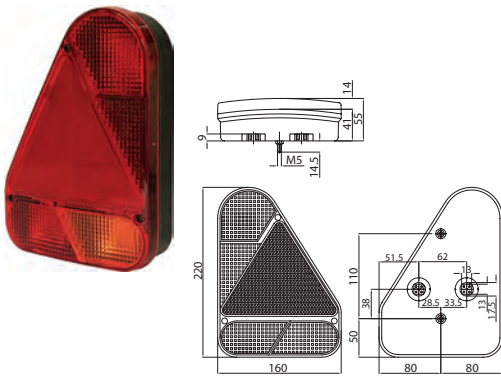

Bulb incl.: Yes  
Voltage: 12  
Watt: 21/5  
Watt 2: 21

Dim.: 220x160x55 mm  
Dist. mount. holes:  
110 mm

Socket type: BAY15d  
Socket type 2: BA15S  
Colour: Black  
Material: Polypropylene  
Material/dome: Polycarbonate  
Shape: Triangle  
Reflector: w/  
Fixing screw: 2  
Flasher light: w/  
Rear/fog lamp: w/  
Reverse light: w/o  
Sidemarker lamp: w/o  
Tail light: w/  
Stop light: w/  
RH/LH: LH  
E-approval: Yes

**172069 Multi Function Lamp** Std pkg 1

Lens: HC-CARGO 172071. Plug: HC-CARGO 171537, 171538. Right: HC-CARGO 172068.

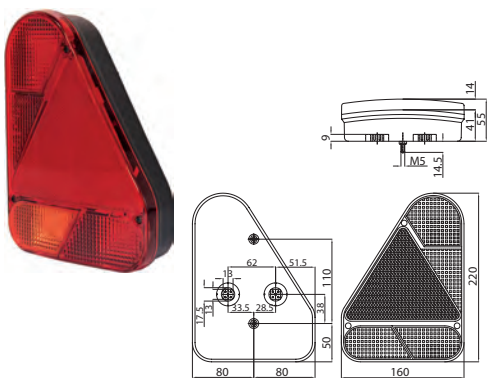

Bulb incl.: Yes  
Voltage: 12  
Watt: 21/5  
Watt 2: 21

Dim.: 220x160x55 mm  
Dist. mount. holes:  
110 mm

Socket type: BAY15d  
Socket type 2: BA15S  
Colour: Black  
Material: Polypropylene  
Material/dome: Polycarbonate  
Shape: Triangle  
Reflector: w/  
Fixing screw: 2  
Flasher light: w/  
Rear/fog lamp: w/  
Reverse light: w/o  
Sidemarker lamp: w/o  
Tail light: w/  
Stop light: w/  
RH/LH: RH  
E-approval: Yes

**SPARE PARTS**

**170687 Lens, Rear Lamp** Std pkg 1 Servicing: HC-CARGO 170685



Dim.: 104x98 mm

RH/LH: RH/LH  
Shape: Square

**170833 Lens, Rear Lamp** Std pkg 1 Servicing: HC-CARGO 170939, 170940, 171821, 171822, 171873



Dim.: 108x103x52 mm

Material: Shockproof plastic  
Shape: Square  
Flasher light: w/  
Tail light: w/  
Stop light: w/  
RH/LH: RH/LH

**170847 Lens, Rear Lamp** Std pkg 1 Servicing: HC-CARGO 170846



Dim.: 111x82 mm









Material: Shockproof plastic  
Shape: Rectangular  
RH/LH: RH/LH









**170944 Lens, Rear Lamp** Std pkg 1 Servicing: HC-CARGO 170943





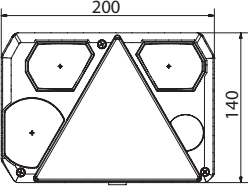

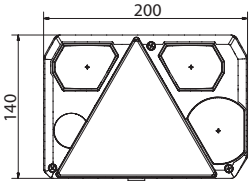

Dim.: 120x80 mm

Material: Shockproof plastic  
Shape: Rectangular  
RH/LH: RH/LH

EL. SPECIFICATIONS		DIMENSIONS	ADDITIONAL SPECIFICATIONS
<b>170987</b> Lens, Rear Lamp	Std pkg 1 Servicing: HC-CARGO 170985, 170986	Dim.: 180x60 mm	Material: Shockproof plastic Shape: Rectangular RH/LH: RH/LH
			
<b>171015</b> Lens, Rear Lamp	Std pkg 1 Servicing: HC-CARGO 171013, 171533	Dim.: 218x140 mm	Material: Shockproof plastic Shape: Rectangular Reflector: w/ RH/LH: LH
			
<b>171016</b> Lens, Rear Lamp	Std pkg 1 Servicing: HC-CARGO 171534, 171014	Dim.: 218x140 mm	Material: Shockproof plastic Shape: Rectangular Reflector: w/ RH/LH: RH
			
<b>171056</b> Lens, Rear Lamp	Std pkg 1 Servicing: HC-CARGO 171051, 171053	Dim.: 235x135x52 mm	Material: Shockproof plastic Shape: Rectangular Reflector: w/ Numberplate light: w/ RH/LH: RH
			
<b>171057</b> Lens, Rear Lamp	Std pkg 1 Servicing: HC-CARGO 171050, 171054	Dim.: 235x135x52 mm	Material: Shockproof plastic Shape: Rectangular Reflector: w/ Numberplate light: w/ RH/LH: LH
			
<b>171058</b> Lens, Rear Lamp	Std pkg 1 Servicing: HC-CARGO 171052	Dim.: 235x135 mm	Material: Shockproof plastic Shape: Rectangular Reflector: w/ Numberplate light: w/ RH/LH: RH
			
<b>171059</b> Lens, Rear Lamp	Std pkg 1 Servicing: HC-CARGO 171055	Dim.: 235x135 mm	Material: Shockproof plastic Shape: Rectangular Reflector: w/ Numberplate light: w/ RH/LH: LH
			
<b>171162</b> Lens, Rear Lamp	Std pkg 1 Servicing: Ford Transit 1986 - Visit <a href="http://www.hc-cargo.com">www.hc-cargo.com</a> for further information.	Dim.: 364x94 mm	Material: Shockproof plastic Shape: Rectangular Reflector: w/ E-approval: Yes
			

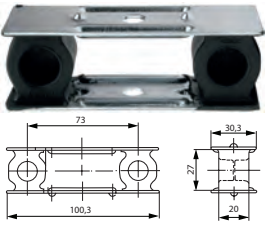
EL. SPECIFICATIONS		DIMENSIONS	ADDITIONAL SPECIFICATIONS
171253 Lens, Rear Lamp	Std pkg 1 Servicing: HC-CARGO 171202	Dim.: 93x99 mm	Material: Shockproof plastic Shape: Hexagon RH/LH: RH/LH
			
171258 Lens, Rear Lamp	Std pkg 1 Servicing: HC-CARGO 171203	Dim.: 158x64 mm	Material: Shockproof plastic Shape: Rectangular Reflector: w/ RH/LH: LH
			
171265 Lens, Rear Lamp	Std pkg 1 Servicing: HC-CARGO 171214	Dim.: 235x135 mm	Shape: Rectangular Reflector: w/ Numberplate light: w/ RH/LH: RH
			
171330 Lens, Rear Lamp	Std pkg 1 Servicing: HC-CARGO 171328, 171329	OD: 140 mm	Shape: Round RH/LH: RH/LH
			
172023 Lens, Rear Lamp	Std pkg 1 Servicing: HC-CARGO: 172021, 172025	Dim.: 200x140 mm	Shape: Rectangular Reflector: w/ RH/LH: LH
 			
172024 Lens, Rear Lamp	Std pkg 1 Servicing: HC-CARGO: 172022, 172026	Dim.: 200x140 mm	Shape: Rectangular Reflector: w/ Reverse light: w/ RH/LH: RH
 			
172051 Lens, Rear Lamp	Std pkg 1 Servicing: HC-CARGO 172047	Dim.: 188.5x135 mm	Material/dome: PMMA Shape: Rectangular
			
172052 Lens, Rear Lamp	Std pkg 1 Servicing: HC-CARGO 172048	Dim.: 188.5x135 mm	Material: PMMA Shape: Rectangular
			

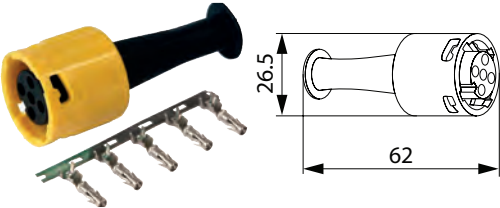
EL. SPECIFICATIONS		DIMENSIONS	ADDITIONAL SPECIFICATIONS
<b>172057</b> Lens, Rear Lamp	Std pkg 1 Servicing: HC-CARGO 172049		
		Dim.: 188.5x135 mm	Material/dome: PMMA Shape: Rectangular
<b>172058</b> Lens, Rear Lamp	Std pkg 1 Servicing: HC-CARGO 172050		
		Dim.: 188.5x135 mm	Material/dome: PMMA Shape: Rectangular
<b>172070</b> Lens, Rear Lamp	Std pkg 1 Servicing: HC-CARGO 172068		
		Dim.: 220x160 mm	Material/dome: Polycarbonate Shape: Triangle RH/LH: LH
<b>172071</b> Lens, Rear Lamp	Std pkg 1 Servicing: HC-CARGO 172069		
		Dim.: 220x160 mm	Material/dome: Polycarbonate Shape: Triangle RH/LH: RH
<b>ACCESSORIES</b>			
<b>170604</b> Vibration Damper	Std pkg 2 Servicing: HC-CARGO 170602, 170603		
<i>Gives a longer life to the bulbs.</i>			
			
<b>171266</b> Repair Kit	Std pkg 1 Servicing: HC-CARGO 171192, 171193, 171194, 171195, 171329, 171549, 171550, 171684, 171685		
<i>Circulars.</i>			
			
<b>171372</b> Multi Connector	Std pkg 1 Servicing: HC-CARGO 171050, 171051, 171052, 171053, 171054, 171055, 171818, 171821, 171822, 171873		
<i>Socket w/ quick connection. Terminal: HC-CARGO 191075.</i>			
		Dim.: 62x26.5 mm	Colour: Yellow RH/LH: LH E-approval: Yes

EL. SPECIFICATIONS		DIMENSIONS	ADDITIONAL SPECIFICATIONS
<b>171373</b> Multi Connector Std pkg 1		Servicing: HC-CARGO 171050, 171051, 171052, 171053, 171054, 171055, 171818, 171821, 171822, 171873	
<i>Socket w/ quick connection. Terminal: HC-CARGO 191075.</i>			
		Dim.: 62x26.5 mm	Colour: Green RH/LH: RH E-approval: Yes
<b>171537</b> Multi Connector Std pkg 1		Servicing: HC-CARGO 171533, 171534, 172021, 172022, 172025, 172026, 172047, 172048, 172049, 172050, 172068, 172069, 171870, 171871	
<i>Socket w/ quick connection. Terminal: HC-CARGO 191075.</i>			
		Dim.: 55x28 mm	Colour: Red RH/LH: LH
<b>171538</b> Multi Connector Std pkg 1		Servicing: HC-CARGO 171533, 171534, 172021, 172022, 172025, 172026, 172047, 172049, 172048, 172050, 172068, 172069, 171871, 171870	
<i>Socket w/ quick connection. Terminal: HC-CARGO 191075.</i>			
		Dim.: 55x28 mm	Colour: Green RH/LH: RH
<b>171788</b> Multiconnector 7 pin Std pkg 1		Servicing: HC-CARGO 171506, 171756, 171757, 171802, 171803, 171927, 171928, 171929, 171930, 172061, 172062, 172063, 172064	
<i>Gasket: HC-CARGO 192178. Terminal: HC-CARGO 193250.</i>			
			Type/terminal: Round Colour: Black No./poles: 7 Plug: Female
<b>172015</b> Cable w/ plug Std pkg 2		Servicing: HC-CARGO 171730, 171731, 171732, 171733, 171734, 172015	
<i>Cover of click-in connector HC-CARGO 172016.</i>			
			Type: Clip-on Type: Round
<b>172016</b> Cover of click-in connector Std pkg 10		Servicing: HC-CARGO 171730, 171731, 171732, 171733, 171734, 172015	
		ID: 12.8 mm Total length: 30.6 mm Height: 16.3 mm Width: 16.5 mm	

		EL. SPECIFICATIONS	DIMENSIONS	ADDITIONAL SPECIFICATIONS
<b>172066</b> Multiconnector 7 pin Std pkg 1		Servicing: HC-CARGO 171506, 171756, 171757, 171802, 171803, 171927, 171928, 171929, 171930, 172061, 172062, 172063, 172064		
				Type/terminal: Round Colour: Black No./poles: 7 Plug: Female
<b>181627</b> Bayonet connector Std pkg 1		Servicing: HC-CARGO 181617		
		Voltage: 12		Mount.: Terminal No./poles: 8
<b>TRAILER LAMPS LED</b>				
<b>171549</b> LED Multifunction Lamp Std pkg 1 <i>Mounting kit: HC-CARGO 171266.</i>				
		Voltage: 9-33	Dim.: 140x60 mm Dist. mount. holes: 45 mm	Type: LED Colour: Black Material: Shockproof plastic Shape: Round Fixing screw: 2 Flasher light: w/ Tail light: w/ Stop light: w/ No./LEDs: 63 E-approval: Yes
<b>171665</b> LED Multifunction Lamp Std pkg 1 <i>Right: HC-CARGO 171666.</i>				
		Voltage: 12/24	Dim.: 336x151x67 mm Dist. mount. holes: 152 mm	Type: LED Material: Shockproof plastic Shape: Rectangular Reflector: w/ Flasher light: w/ Reverse light: w/ Rear/fog lamp: w/o Sidemarket lamp: w/o Tail light: w/ Stop light: w/ RH/LH: LH E-approval: Yes
<b>171666</b> LED Multifunction Lamp Std pkg 1 <i>Left: HC-CARGO 171665.</i>				
		Voltage: 12/24	Dim.: 336x151x67 mm Dist. mount. holes: 152 mm	Type: LED Material: Shockproof plastic Shape: Rectangular Reflector: w/ Flasher light: w/ Reverse light: w/ Rear/fog lamp: w/o Sidemarket lamp: w/o Tail light: w/ Stop light: w/ RH/LH: RH E-approval: Yes
<b>171667</b> LED Multifunction Lamp Std pkg 1 <i>White = ground. Brown = tail light. Red = stop. Yellow = indicator.</i>				
		Voltage: 12/24	Dim.: 150x80x26.9 mm Dist. mount. holes: 100 mm	Type: LED Material: Plastic Shape: Rectangular Reflector: w/ Flasher light: w/ Tail light: w/ Stop light: w/ No./LEDs: 24 Tightness norm: IP 67 E-approval: Yes



**171668 LED Multifunction Lamp** Std pkg 1

White = ground. Brown = tail light. Red = stop. Yellow = indicator.

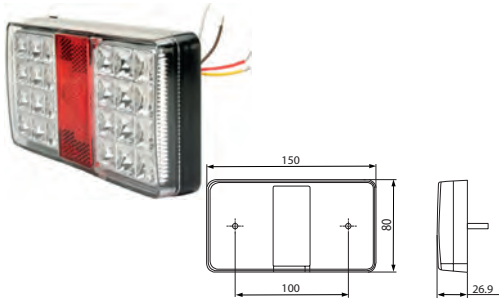

Voltage: 12/24

Dim.: 150x80x26.9 mm  
Dist. mount. holes: 100 mm

Type: LED  
Colour/glass: Transparent  
Material: Shockproof plastic  
Material/dome: Glass  
Shape: Rectangular  
Reflector: w/  
Flasher light: w/  
Tail light: w/  
Stop light: w/  
No./LEDs: 24  
Tightness norm: IP 67  
E-approval: Yes

**171725 LED Multifunction Lamp** Std pkg 1

Ring: amber, center: red.



Voltage: 12/24

Dim.: 122x84.5 mm  
OD: 122 mm  
Cable length: 150 mm  
Dist. mount. holes: 44 mm

Type: LED  
Material: Shockproof plastic  
Material/dome: Shockproof plastic  
Shape: Round  
Fixing screw: 6  
Flasher light: w/  
Tail light: w/  
Stop light: w/  
No./LEDs: 44  
E-approval: Yes

**171726 LED Fog/Reverse Lamp** Std pkg 1

Ring: clear, center: red.



Voltage: 12/24

Dim.: 122x84.5 mm  
OD: 122 mm  
Cable length: 150 mm  
Dist. mount. holes: 44 mm

Type: LED  
Material: Shockproof plastic  
Material/dome: Shockproof plastic  
Shape: Round  
Rear/fog lamp: w/  
Reverse light: w/  
No./LEDs: 38  
E-approval: Yes

**171756 LED Multifunction Lamp** Std pkg 1

Multi-plug: HC-CARGO 171788, 172066.

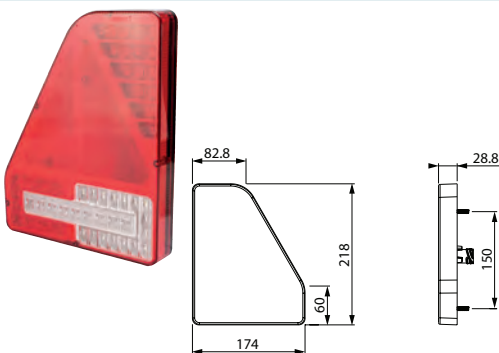

Voltage: 12/24

Dim.: 174x218x28.8 mm  
Dist. mount. holes: 150 mm

Type: Tail/position lamp  
Material: Shockproof plastic  
Material/dome: Shockproof plastic  
Shape: Triangle  
Reflector: w/  
Flasher light: w/  
Rear/fog lamp: w/  
Reverse light: w/  
Sidemarker lamp: w/o  
Tail light: w/  
Stop light: w/  
RH/LH: RH  
Tightness norm: IP 67  
E-approval: Yes

**171757 LED Multifunction Lamp** Std pkg 1

Multi-plug: HC-CARGO 171788, 172066.

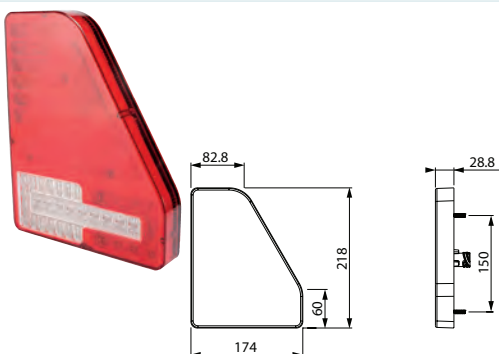

Voltage: 12/24

Dim.: 174x218x28.8 mm  
Dist. mount. holes: 150 mm

Type: Tail/position lamp  
Material: Shockproof plastic  
Material/dome: Shockproof plastic  
Shape: Triangle  
Reflector: w/  
Flasher light: w/  
Rear/fog lamp: w/  
Reverse light: w/  
Sidemarker lamp: w/o  
Tail light: w/  
Stop light: w/  
RH/LH: LH  
Tightness norm: IP 67  
E-approval: Yes

**171758 LED Multifunction Lamp** Std pkg 1

White = ground. Red = stop. Black = tail. Yellow = indicator. Brown = reverse.

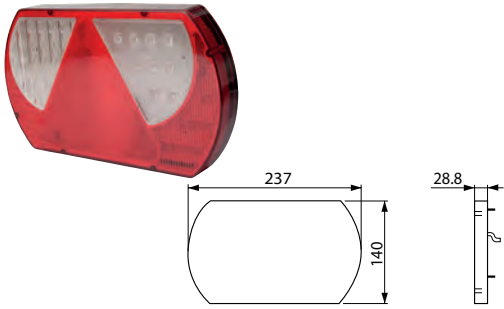

Voltage: 12/24

Dim.: 237x140x28.8 mm  
Cable length: 2000 mm  
Dist. mount. holes: 152 mm

Type: Tail lamp  
Material: Shockproof plastic  
Material/dome: Shockproof plastic  
Shape: Oval  
Mount.: 2 screws  
Reflector: w/  
Flasher light: w/  
Numberplate light: w/  
Reverse light: w/  
Rear/fog lamp: w/o  
Sidemarker lamp: w/o  
Tail light: w/  
Stop light: w/  
RH/LH: RH  
Tightness norm: IP 66  
E-approval: Yes

**171759 LED Multifunction Lamp** Std pkg 1

White = ground. Red = stop. Black = tail. Yellow = indicator. Blue = fog.

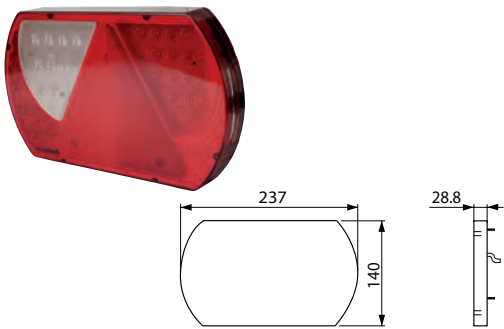

Voltage: 12/24

Dim.: 237x140x28.8 mm  
Cable length: 2000 mm  
Dist. mount. holes: 152 mm

Type: Tail lamp  
Material: Shockproof plastic  
Material/dome: Shockproof plastic  
Shape: Oval  
Mount.: 2 screws  
Reflector: w/  
Flasher light: w/  
Numberplate light: w/  
Reverse light: w/o  
Rear/fog lamp: w/  
Sidemarker lamp: w/o  
Tail light: w/  
Stop light: w/  
RH/LH: LH  
Tightness norm: IP 66  
E-approval: Yes

**171772 LED Multifunction Lamp** Std pkg 1

White=ground. Brown=tail. Yellow=flasher. Red=stop.

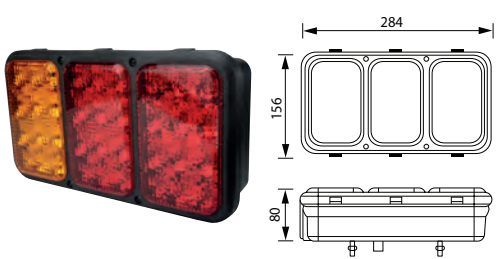

Voltage: 24

Dim.: 284x156x102 mm  
Dist. mount. holes: 130x78 mm

Type: Tail lamp  
Material: Polypropylene  
Material/dome: PMMA  
Shape: Rectangular  
Mount.: 4 screws  
Reflector: w/  
Flasher light: w/  
Tail light: w/  
Stop light: w/  
No./LEDs: 3x16  
RH/LH: RH/LH  
Tightness norm: IP 67  
E-approval: Yes

**171789 LED Multifunction Lamp** Std pkg 1

Vertical mount.

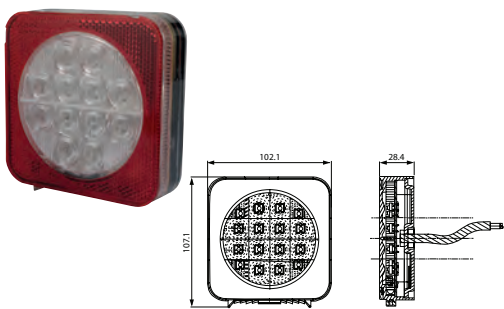

Voltage: 12/24

Dim.: 102.1x107.1x28.4 mm  
Cable length: 500 mm  
Dist. mount. holes: 45 mm

Type: Tail lamp  
Bulb type: LED  
Material: Polycarbonate  
Material/dome: Polycarbonate  
Shape: Square  
Mount.: 2 screws  
Reflector: w/  
Flasher light: w/  
Numberplate light: w/  
Tail light: w/  
Stop light: w/  
No./LEDs: 12  
RH/LH: RH/LH  
Tightness norm: IP 67  
E-approval: Yes

**171790 LED Multifunction Lamp** Std pkg 1

Vertical mount.

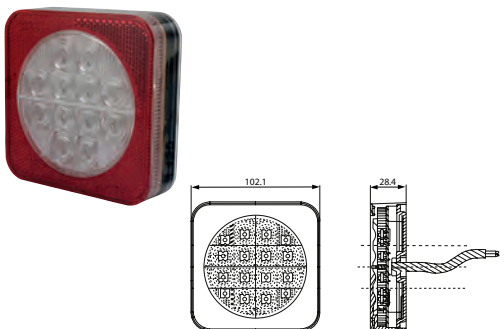

Voltage: 12/24

Dim.: 102.1x28.4 mm  
Cable length: 500 mm  
Dist. mount. holes: 45 mm

Type: Tail lamp  
Material: Polycarbonate  
Material/dome: Polycarbonate  
Shape: Square  
Mount.: 2 screws  
Reflector: w/  
Flasher light: w/  
Reverse light: w/o  
Rear/fog lamp: w/o  
Sidemarker lamp: w/o  
Tail light: w/  
Stop light: w/  
No./LEDs: 12  
RH/LH: RH/LH  
Tightness norm: IP 67  
E-approval: Yes

**171791 LED Multifunction Lamp** Std pkg 1

Horizontal mount.

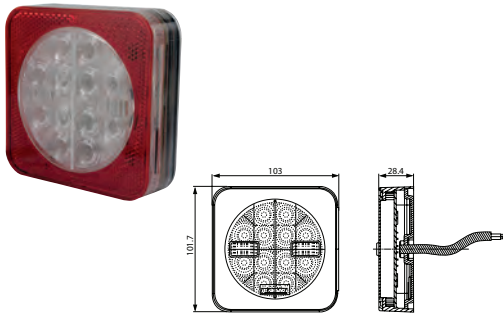

Voltage: 12/24

Dim.: 103x101.7x28.4 mm  
Cable length: 500 mm  
Dist. mount. holes: 45 mm

Type: Tail lamp  
Material: Polycarbonate  
Material/dome: Polycarbonate  
Shape: Square  
Mount.: 2 screws  
Reflector: w/  
Flasher light: w/  
Numberplate light: w/  
Tail light: w/  
Stop light: w/  
No./LEDs: 12  
RH/LH: RH/LH  
Tightness norm: IP 67  
E-approval: Yes

**171927 LED Multifunction Lamp** Std pkg 1

Multi-plug: HC-CARGO 171788, 172066. Left: HC-CARGO 171928.

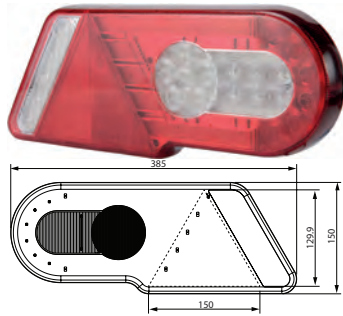

Voltage: 12-24

Dim.: 385x150x34.1 mm  
Dist. mount. holes: 152.3 mm

Type: LED  
Shape: Rectangular  
Reflector: w/  
Flasher light: w/  
Rear/fog lamp: w/  
Reverse light: w/  
Sidemarker lamp: w/o  
Tail light: w/  
Stop light: w/  
RH/LH: RH  
Tightness norm: IP 67  
Approvals: CE  
E-approval: Yes

**171928 LED Multifunction Lamp** Std pkg 1

Multi-plug: HC-CARGO 171788, 172066. Right: HC-CARGO 171927.

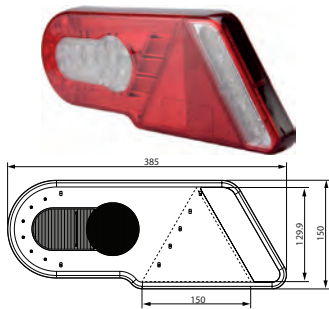

Voltage: 12-24

Dim.: 385x150x34.1 mm  
Dist. mount. holes: 152 mm

Type: LED  
Shape: Rectangular  
Reflector: w/  
Flasher light: w/  
Rear/fog lamp: w/  
Reverse light: w/  
Sidemarker lamp: w/o  
Tail light: w/  
Stop light: w/  
RH/LH: LH  
Tightness norm: IP 67  
Approvals: CE  
E-approval: Yes

**171929 LED Multifunction Lamp** Std pkg 1

Multi-plug: HC-CARGO 171788, 172066. Left: HC-CARGO 171930.



Voltage: 12-24

Dim.: 240.3x140x31 mm  
Dist. mount. holes: 152 mm

Type: LED  
Shape: Rectangular  
Reflector: w/  
Flasher light: w/  
Rear/fog lamp: w/  
Reverse light: w/  
Sidemarker lamp: w/o  
Tail light: w/  
Stop light: w/  
RH/LH: RH  
Tightness norm: IP 67  
Approvals: CE  
E-approval: Yes

**171930 LED Multifunction Lamp** Std pkg 1

Multi-plug: HC-CARGO 171788, 172066. Right: HC-CARGO 171929.

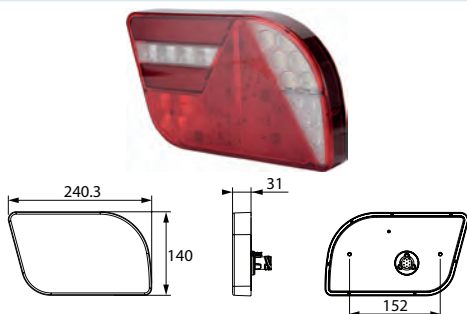

Voltage: 12-24

Dim.: 240.3x140x31 mm  
Dist. mount. holes: 152 mm

Type: LED  
Shape: Rectangular  
Reflector: w/  
Flasher light: w/  
Rear/fog lamp: w/  
Reverse light: w/  
Sidemarker lamp: w/o  
Tail light: w/  
Stop light: w/  
RH/LH: LH  
Tightness norm: IP 67  
E-approval: Yes

**171952 LED Multifunction Lamp** Std pkg 1

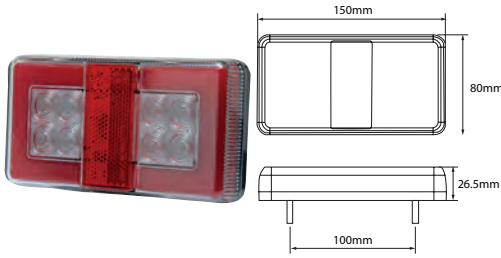

Voltage: 12-24

Dim.: 150x80x26.5 mm  
Cable length: 300 mm  
Dist. mount. holes: 100 mm

Type: LED  
Shape: Rectangular  
Mount.: 2 screws  
Reflector: w/  
No./reflectors: 1  
Flasher light: w/  
Tail light: w/  
Stop light: w/  
Tightness norm: IP 67  
E-approval: Yes

**172061 LED Multifunction Lamp** Std pkg 1

Lens: HC-CARGO 172065. Plug: HC-CARGO 171788, 172066. Left: HC-CARGO 172062.



Voltage: 12-24

Dim.: 426.3x155.2x111.6 mm  
Dist. mount. holes: 152 mm

Type: LED  
Material: PP  
Material/dome: Polycarbonate  
Shape: Rectangular  
Reflector: w/  
Flasher light: w/  
Rear/fog lamp: w/  
Reverse light: w/  
Sidemarker lamp: w/  
Tail light: w/  
Stop light: w/  
RH/LH: RH  
E-approval: Yes

**172062 LED Multifunction Lamp** Std pkg 1

Lens: HC-CARGO 172065. Plug: HC-CARGO 171788, 172066. Right: HC-CARGO 172061.

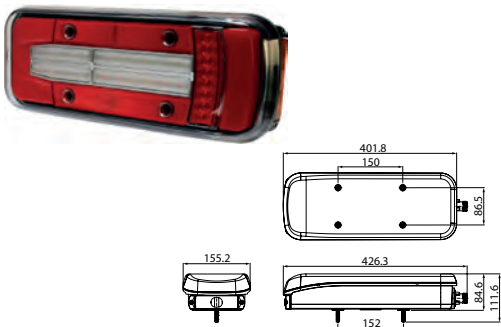

Voltage: 12-24

Dim.: 426.3x155.2x111.6 mm  
Dist. mount. holes: 152 mm

Type: LED  
Material: PP  
Material/dome: Polycarbonate  
Shape: Rectangular  
Reflector: w/  
Flasher light: w/  
Rear/fog lamp: w/  
Reverse light: w/  
Sidemarker lamp: w/  
Tail light: w/  
Stop light: w/  
RH/LH: LH  
E-approval: Yes

**172063 LED Multifunction Lamp** Std pkg 1

Lens: HC-CARGO 172067. Plug: HC-CARGO 171788, 172066. Left: HC-CARGO 172064.

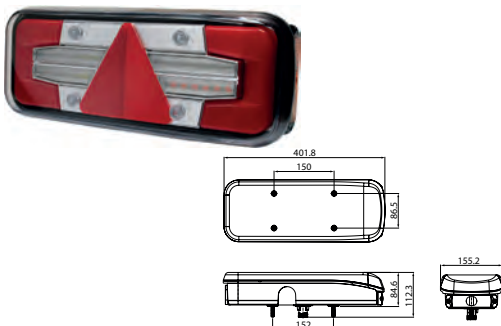

Voltage: 12-24

Dim.: 401.8x155.2x112.3 mm  
Dist. mount. holes: 152 mm

Type: LED  
Material: PP  
Material/dome: Polycarbonate  
Shape: Rectangular  
Reflector: w/  
Flasher light: w/  
Rear/fog lamp: w/  
Reverse light: w/  
Sidemarker lamp: w/  
Tail light: w/  
Stop light: w/  
RH/LH: RH  
E-approval: Yes

**172064 LED Multifunction Lamp** Std pkg 1

Lens: HC-CARGO 172067. Plug: HC-CARGO 171788, 172066. Right: HC-CARGO 172063.

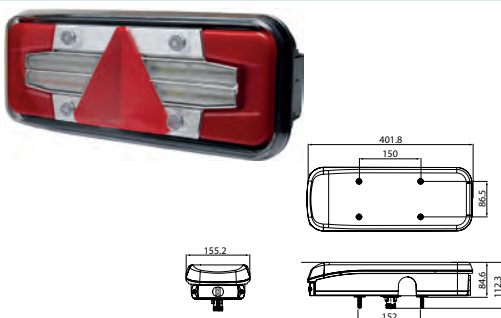

Voltage: 12-24

Dim.: 401.8x155.2x112.3 mm  
Dist. mount. holes: 152 mm

Type: LED  
Material: PP  
Material/dome: Polycarbonate  
Shape: Rectangular  
Reflector: w/  
Flasher light: w/  
Rear/fog lamp: w/  
Reverse light: w/  
Sidemarker lamp: w/  
Tail light: w/  
Stop light: w/  
RH/LH: LH  
E-approval: Yes

**SPARE PARTS**
**172065** Lens, Rear Lamp

Std pkg 1 Servicing: HC-CARGO 172061, 172062



Dim.: 401.8x155.2 mm

 Material/dome: Polycarbonate  
RH/LH: RH/LH

**172067** Lens, Rear Lamp

Std pkg 1 Servicing: HC-CARGO 172063, 172064



Dim.: 401.8x155.2 mm

 Material/dome: Polycarbonate  
RH/LH: RH/LH

**ACCESSORIES**
**160970** Load Resistor 12 V

Std pkg 1

Contains: 2 pcs.

 Voltage: 12  
Amp: 2  
Watt: 50

 Length: 50 mm  
Width: 15 mm

**160971** Load Resistor 24 V

Std pkg 1

Contains: 2 pcs.



 Voltage: 24  
Amp: 1  
Watt: 50

 Length: 50 mm  
Width: 15 mm

**TRAILER LAMPS CONVENTIONAL (TRUCKS)**
**170602** Multi Function Lamp

 Std pkg 1 Servicing: RVI Renault, Pegaso - Visit [www.hc-cargo.com](http://www.hc-cargo.com) for further information.

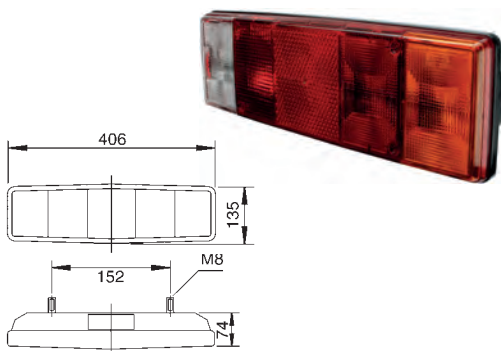
Lens: HC-CARGO 170665. Right: HC-CARGO 170603. Vibration Damper: HC-CARGO 170604.

 Bulb incl.: No  
Watt: 21  
Watt 2: 5  
Watt 3: 10

 Dim.: 406x135x74 mm  
Dist. mount. holes:  
152 mm

 Socket type: BA15S  
Socket type 2: BA15S  
Socket type 3: BA15S  
Material: Shockproof plastic  
Shape: Rectangular  
Reflector: w/  
Flasher light: w/  
Numberplate light: w/  
Rear/fog lamp: w/  
Reverse light: w/  
Sidemarker lamp: w/o  
Tail light: w/  
Stop light: w/  
RH/LH: LH  
E-approval: Yes

**170603** Multi Function Lamp

 Std pkg 1 Servicing: RVI Renault, Pegaso - Visit [www.hc-cargo.com](http://www.hc-cargo.com) for further information.

Lens: HC-CARGO 170665. Left: HC-CARGO 170602. Vibration Damper: HC-CARGO 170604.

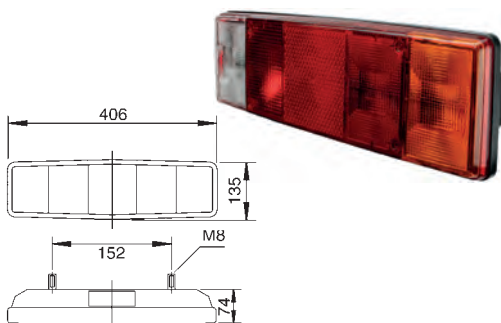
 Bulb incl.: No  
Watt: 21  
Watt 2: 5  
Watt 3: 10

 Dim.: 406x135x74 mm  
Dist. mount. holes:  
152 mm

 Socket type: BA15S  
Socket type 2: BA15S  
Socket type 3: BA15S  
Material: Shockproof plastic  
Shape: Rectangular  
Reflector: w/  
Flasher light: w/  
Rear/fog lamp: w/  
Reverse light: w/  
Sidemarker lamp: w/o  
Tail light: w/  
Stop light: w/  
RH/LH: RH  
E-approval: Yes

**ACCESSORIES - Lighting**

O.E.M. names and numbers are used for reference purposes only.

**170893 Multi Function Lamp** Std pkg 1

Lens: HC-CARGO 171062. Left: HC-CARGO 170895. 2 bulb holders for tail light.

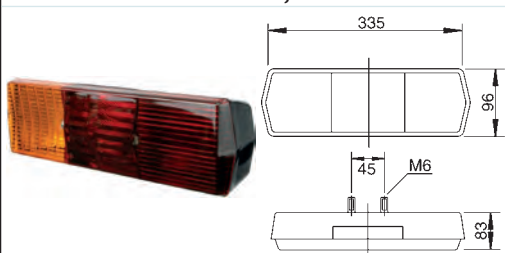

Bulb incl.: No  
Watt: 21

Dim.: 335x96x83 mm  
Dist. mount. holes:  
45 mm

Socket type: BA15S  
Material: Shockproof plastic  
Shape: Rectangular  
Flasher light: w/  
Rear/fog lamp: w/o  
Reverse light: w/o  
Sidemarker lamp: w/o  
Tail light: w/  
Stop light: w/  
RH/LH: RH

**170895 Multi Function Lamp** Std pkg 1

Lens: HC-CARGO 171062. Right: HC-CARGO 170893. 2 bulb holders for tail light.

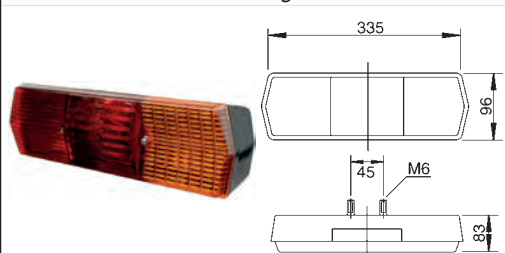

Bulb incl.: No  
Watt: 21

Dim.: 335x96x83 mm  
Dist. mount. holes:  
45 mm

Socket type: BA15S  
Material: Shockproof plastic  
Shape: Rectangular  
Flasher light: w/  
Rear/fog lamp: w/o  
Reverse light: w/o  
Sidemarker lamp: w/o  
Tail light: w/  
Stop light: w/  
RH/LH: LH

**170916 Multi Function Lamp** Std pkg 1 Servicing: Scania, Universal - Visit [www.hc-cargo.com](http://www.hc-cargo.com) for further information.

Lens: HC-CARGO 170968. Right: HC-CARGO 170917. 2 bulb holders for tail light.

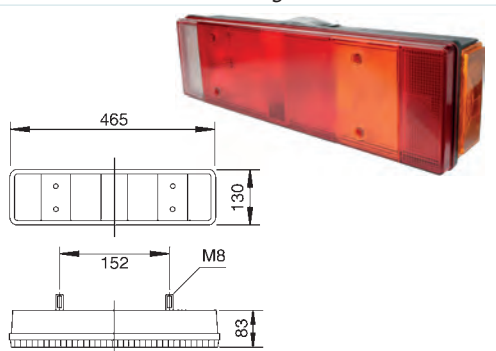

Bulb incl.: No  
Watt: 21  
Watt 2: 5  
Watt 3: 10

Dim.: 465x130x83 mm  
Dist. mount. holes:  
152 mm

Socket type: BA15S  
Socket type 2: BA15S  
Socket type 3: BA15S  
Material: Shockproof plastic  
Shape: Rectangular  
Reflector: w/  
Flasher light: w/  
Numberplate light: w/  
Rear/fog lamp: w/  
Reverse light: w/  
Sidemarker lamp: w/  
Tail light: w/  
Stop light: w/  
RH/LH: LH

**170917 Multi Function Lamp** Std pkg 1 Servicing: Scania, Universal - Visit [www.hc-cargo.com](http://www.hc-cargo.com) for further information.

Lens: HC-CARGO 170968. 2 bulb holders for tail light. Left: HC-CARGO 170916

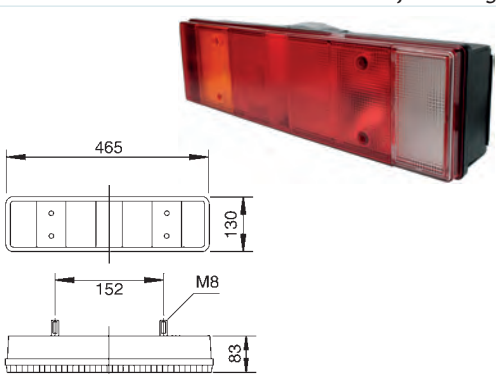

Bulb incl.: No  
Watt: 21  
Watt 2: 5  
Watt 3: 10

Dim.: 465x130x83 mm  
Dist. mount. holes:  
152 mm

Socket type: BA15S  
Socket type 2: BA15S  
Socket type 3: BA15S  
Material: Shockproof plastic  
Shape: Rectangular  
Reflector: w/  
Flasher light: w/  
Numberplate light: w/  
Rear/fog lamp: w/  
Reverse light: w/  
Sidemarker lamp: w/  
Tail light: w/  
Stop light: w/  
RH/LH: RH  
E-approval: Yes

**170922 Multi Function Lamp** Std pkg 1 Servicing: MAN, Universal - Visit [www.hc-cargo.com](http://www.hc-cargo.com) for further information.

Lens: HC-CARGO 170968. Right: HC-CARGO 170923.

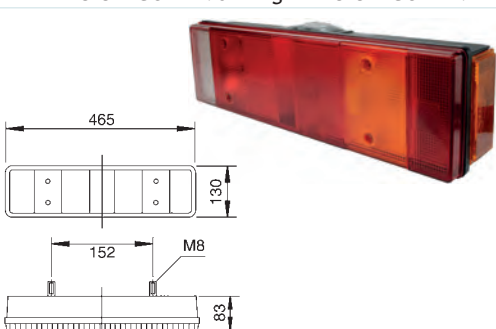

Bulb incl.: No  
Watt: 21  
Watt 2: 5  
Watt 3: 10

Dim.: 465x130x83 mm  
Dist. mount. holes:  
152 mm

Socket type: BA15S  
Socket type 2: BA15S  
Socket type 3: BA15S  
Material: Shockproof plastic  
Shape: Rectangular  
Reflector: w/  
Flasher light: w/  
Numberplate light: w/  
Rear/fog lamp: w/  
Reverse light: w/o  
Sidemarker lamp: w/  
Tail light: w/  
Stop light: w/  
RH/LH: LH  
E-approval: Yes

**170923 Multi Function Lamp** Std pkg 1 Servicing: MAN, Universal - Visit [www.hc-cargo.com](http://www.hc-cargo.com) for further information.

Lens: HC-CARGO 170968. 2 bulb holders for tail light. Left: HC-CARGO 170922.

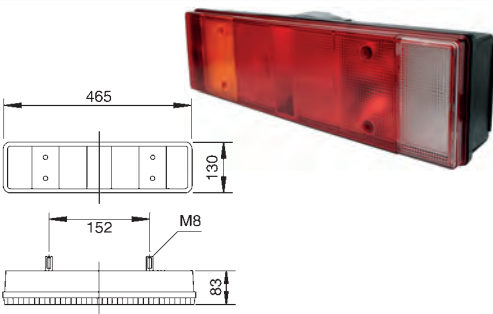

Bulb incl.: No  
Watt: 21  
Watt 2: 5  
Watt 3: 10

Dim.: 465x130x83 mm  
Dist. mount. holes:  
152 mm

Socket type: BA15S  
Socket type 2: BA15S  
Socket type 3: BA15S  
Material: Shockproof plastic  
Shape: Rectangular  
Reflector: w/  
Flasher light: w/  
Numberplate light: w/  
Rear/fog lamp: w/  
Reverse light: w/  
Sidemarker lamp: w/  
Tail light: w/  
Stop light: w/  
RH/LH: RH  
E-approval: Yes

**170990 Multi Function Lamp** Std pkg 1 Servicing: Commercial trailers - Visit [www.hc-cargo.com](http://www.hc-cargo.com) for further information.

Left: HC-CARGO 170991.

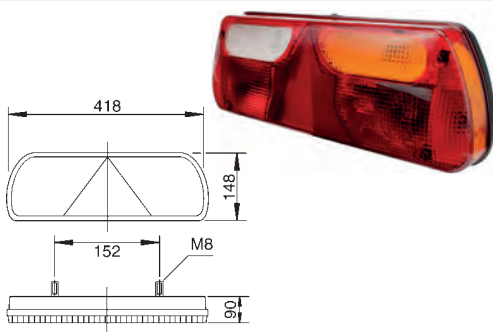

Bulb incl.: No  
Watt: 21  
Watt 2: 20/5  
Watt 3: 5  
Watt 4: 10

Dim.: 418x148x90 mm  
Dist. mount. holes:  
152 mm

Socket type: BA15S  
Socket type 2: BAY15d  
Socket type 3: BA15S  
Socket type 4: BA10s  
Material: Shockproof plastic  
Shape: Rectangular  
Reflector: w/  
Flasher light: w/  
Numberplate light: w/  
Rear/fog lamp: w/  
Reverse light: w/o  
Sidemarker lamp: w/  
Tail light: w/  
Stop light: w/  
RH/LH: RH  
E-approval: Yes

**170991 Multi Function Lamp** Std pkg 1 Servicing: Commercial trailers - Visit [www.hc-cargo.com](http://www.hc-cargo.com) for further information.

Right: HC-CARGO 170990.

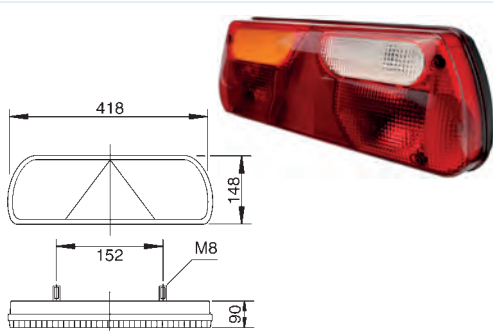

Bulb incl.: No  
Watt: 21  
Watt 2: 21/5  
Watt 3: 5  
Watt 4: 10

Dim.: 418x148x90 mm  
Dist. mount. holes:  
152 mm

Socket type: BA15S  
Socket type 2: BAY15d  
Socket type 3: BA15S  
Socket type 4: BA10s  
Material: Shockproof plastic  
Shape: Rectangular  
Reflector: w/  
Flasher light: w/  
Numberplate light: w/  
Rear/fog lamp: w/  
Reverse light: w/o  
Sidemarker lamp: w/  
Tail light: w/  
Stop light: w/  
RH/LH: LH  
E-approval: Yes

**170998 Multi Function Lamp** Std pkg 1 Servicing: Iveco - Visit [www.hc-cargo.com](http://www.hc-cargo.com) for further information.

Multi function lamp: HC-CARGO 170999. 2 bulb holders for tail light. Lens: HC-CARGO 171000.

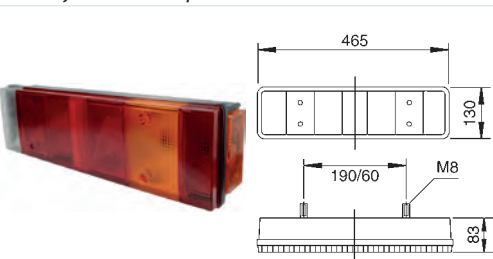

Bulb incl.: No  
Watt: 21  
Watt 2: 5

Dim.: 465x130x83 mm  
Dist. mount. holes:  
190/60 mm

Socket type: BA15S  
Socket type 2: BA15S  
Material: Shockproof plastic  
Shape: Rectangular  
Reflector: w/  
Flasher light: w/  
Rear/fog lamp: w/  
Reverse light: w/o  
Sidemarker lamp: w/  
Tail light: w/  
Stop light: w/  
RH/LH: RH/LH  
E-approval: Yes

**170999 Multi Function Lamp** Std pkg 1 Servicing: Iveco - Visit [www.hc-cargo.com](http://www.hc-cargo.com) for further information.

Multi function lamp: HC-CARGO 170998. 2 bulb holders for tail light. Lens: HC-CARGO 171000.

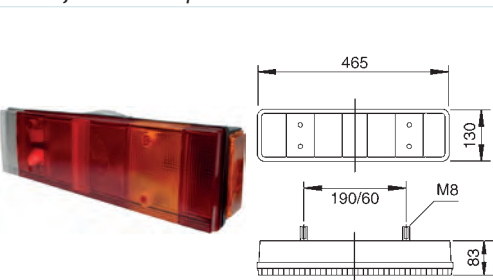

Bulb incl.: No  
Watt: 21  
Watt 2: 5  
Watt 3: 10

Dim.: 465x130x83 mm  
Dist. mount. holes:  
190/60 mm

Socket type: BA15S  
Socket type 2: BA15S  
Socket type 3: BA15S  
Material: Shockproof plastic  
Shape: Rectangular  
Reflector: w/  
Flasher light: w/  
Numberplate light: w/  
Rear/fog lamp: w/  
Reverse light: w/o  
Sidemarker lamp: w/  
Tail light: w/  
Stop light: w/  
RH/LH: RH/LH  
E-approval: Yes

**171192 Multi Function Lamp** Std pkg 1

Mounting kit: HC-CARGO 171266. Lens: HC-CARGO 171237.

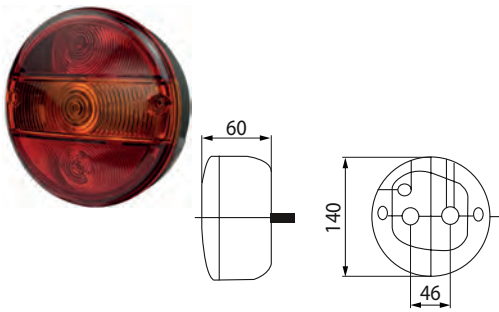

Bulb incl.: No  
Watt: 21  
Watt 2: 5

Dim.: 140x60 mm  
OD: 140 mm  
Dist. mount. holes:  
46 mm

Socket type: BA15S  
Socket type 2: BA15S  
Material: Shockproof plastic  
Shape: Round  
Fixing screw: 2  
Flasher light: w/  
Numberplate light: w/  
Tail light: w/  
Stop light: w/  
E-approval: Yes

**171193 Multi Function Lamp** Std pkg 1

Mounting kit: HC-CARGO 171266. Lens: HC-CARGO 171237.

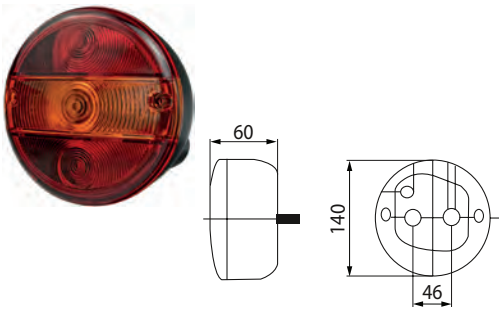

Bulb incl.: No  
Watt: 21  
Watt 2: 5

Dim.: 140x60 mm  
OD: 140 mm  
Dist. mount. holes:  
46 mm

Socket type: BA15S  
Socket type 2: BA15S  
Material: Shockproof plastic  
Shape: Round  
Fixing screw: 2  
Flasher light: w/  
Tail light: w/  
Stop light: w/  
E-approval: Yes

**171195 Multi Function Lamp** Std pkg 1

Mounting kit: HC-CARGO 171266. Lens: HC-CARGO 171237.

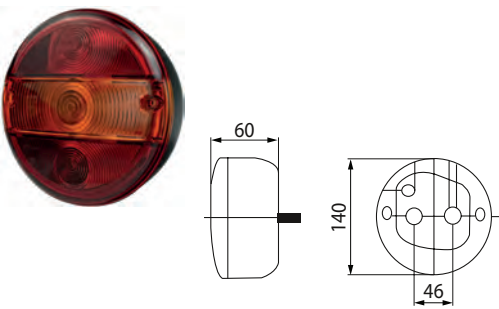

Bulb incl.: No  
Watt: 21  
Watt 2: 5

Dim.: 140x60 mm  
OD: 140 mm  
Dist. mount. holes:  
46 mm

Socket type: BA15S  
Socket type 2: BA15S  
Material: Shockproof plastic  
Shape: Round  
Fixing screw: 2  
Flasher light: w/  
Tail light: w/  
Stop light: w/  
E-approval: Yes

**171206 Multi Function Lamp** Std pkg 1 Servicing: MAN, VW, Mercedes - Visit [www.hc-cargo.com](http://www.hc-cargo.com) for further information.

Lens: HC-CARGO 171263. Right: HC-CARGO 171205. 2 bulb holders for tail light.

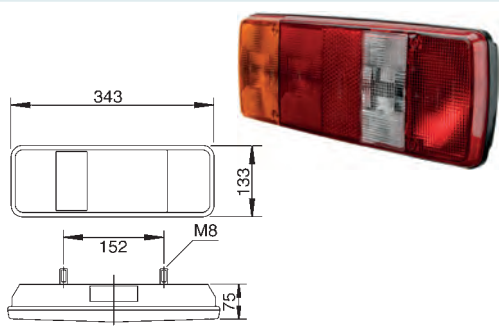

Bulb incl.: No  
Watt: 21  
Watt 2: 5

Dim.: 343x133x75 mm  
Dist. mount. holes:  
152 mm

Socket type: BA15S  
Socket type 2: BA15S  
Material: Shockproof plastic  
Shape: Rectangular  
Reflector: w/  
Flasher light: w/  
Numberplate light: w/  
Rear/fog lamp: w/  
Reverse light: w/  
Sidemarker lamp: w/o  
Tail light: w/  
Stop light: w/  
RH/LH: LH

**171299 Multi Function Lamp** Std pkg 1 Servicing: Mercedes Atego - Visit [www.hc-cargo.com](http://www.hc-cargo.com) for further information.

Lens: HC-CARGO 171307. 2 bulb holders for tail light. Left: HC-CARGO 171302.

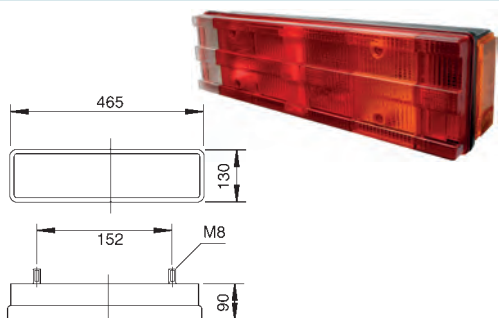

Bulb incl.: No  
Watt: 21  
Watt 2: 5  
Watt 3: 10

Dim.: 465x130x90 mm  
Dist. mount. holes:  
152 mm

Socket type: BA15S  
Socket type 2: BA15S  
Socket type 3: BA15S  
Material: Shockproof plastic  
Shape: Rectangular  
Reflector: w/  
Flasher light: w/  
Numberplate light: w/  
Rear/fog lamp: w/  
Reverse light: w/o  
Sidemarker lamp: w/  
Tail light: w/  
Stop light: w/  
RH/LH: RH  
E-approval: Yes



**171302 Multi Function Lamp** Std pkg 1 Servicing: Mercedes Atego - Visit [www.hc-cargo.com](http://www.hc-cargo.com) for further information.

Lens: HC-CARGO 171307. Right: HC-CARGO 171299. 2 bulb holders for tail light.

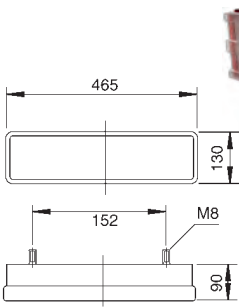

Bulb incl.: No  
Watt: 21  
Watt 2: 5  
Watt 3: 10

Dim.: 465x130x90 mm  
Dist. mount. holes:  
152 mm

Socket type: BA15S  
Socket type 2: BA15S  
Socket type 3: BA15S  
Material: Shockproof plastic  
Shape: Rectangular  
Reflector: w/  
Flasher light: w/  
Numberplate light: w/  
Rear/fog lamp: w/  
Reverse light: w/o  
Sidemarker lamp: w/  
Tail light: w/  
Stop light: w/  
RH/LH: LH  
E-approval: Yes

**171303 Multi Function Lamp** Std pkg 1 Servicing: Mercedes Sprinter - Visit [www.hc-cargo.com](http://www.hc-cargo.com) for further information.

Lens: HC-CARGO 171307. 2 bulb holders for tail light. Left: HC-CARGO 171306.

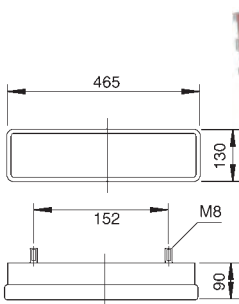

Bulb incl.: No  
Watt: 21  
Watt 2: 5  
Watt 3: 10

Dim.: 465x130x90 mm  
Dist. mount. holes:  
152 mm

Socket type: BA15S  
Socket type 2: BA15S  
Socket type 3: BA15S  
Material: Shockproof plastic  
Shape: Rectangular  
Reflector: w/  
Flasher light: w/  
Numberplate light: w/  
Rear/fog lamp: w/  
Reverse light: w/o  
Sidemarker lamp: w/  
Tail light: w/  
Stop light: w/  
RH/LH: RH  
E-approval: Yes

**171306 Multi Function Lamp** Std pkg 1 Servicing: Mercedes Sprinter - Visit [www.hc-cargo.com](http://www.hc-cargo.com) for further information.

Lens: HC-CARGO 171307. Right: HC-CARGO 171303. 2 bulb holders for tail light.

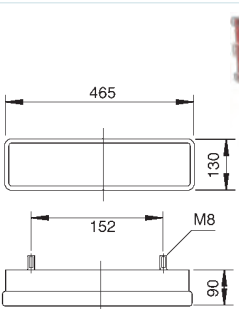

Bulb incl.: No  
Watt: 21  
Watt 2: 5  
Watt 3: 10

Dim.: 465x130x90 mm  
Dist. mount. holes:  
152 mm

Socket type: BA15S  
Socket type 2: BA15S  
Socket type 3: BA15S  
Material: Shockproof plastic  
Shape: Rectangular  
Reflector: w/  
Flasher light: w/  
Numberplate light: w/  
Rear/fog lamp: w/  
Reverse light: w/o  
Sidemarker lamp: w/  
Tail light: w/  
Stop light: w/  
RH/LH: LH  
E-approval: Yes

**171308 Multi Function Lamp** Std pkg 1 Servicing: Mercedes Actros - Visit [www.hc-cargo.com](http://www.hc-cargo.com) for further information.

Lens: HC-CARGO 171312. Left: HC-CARGO 171311.

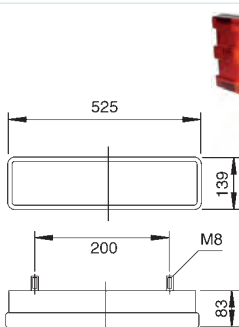

Bulb incl.: No  
Watt: 21  
Watt 2: 5  
Watt 3: 10

Dim.: 525x139x83 mm  
Dist. mount. holes:  
200 mm

Socket type: BA15S  
Socket type 2: BA15S  
Socket type 3: BA15S  
Material: Shockproof plastic  
Shape: Rectangular  
Reflector: w/  
Fixing screw: 12  
Flasher light: w/  
Numberplate light: w/  
Rear/fog lamp: w/  
Reverse light: w/  
Sidemarker lamp: w/  
Tail light: w/  
Stop light: w/  
RH/LH: RH  
E-approval: Yes

**171311 Multi Function Lamp** Std pkg 1 Servicing: Mercedes Actros - Visit [www.hc-cargo.com](http://www.hc-cargo.com) for further information.

Lens: HC-CARGO 171521. Right: HC-CARGO 171308.

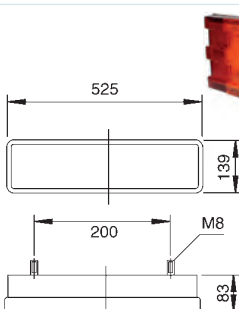

Bulb incl.: No  
Watt: 21  
Watt 2: 5  
Watt 3: 10

Dim.: 525x139x83 mm  
Dist. mount. holes:  
200 mm

Socket type: BA15S  
Socket type 2: BA15S  
Socket type 3: BA15S  
Material: Shockproof plastic  
Shape: Rectangular  
Reflector: w/  
Flasher light: w/  
Numberplate light: w/  
Rear/fog lamp: w/  
Reverse light: w/  
Sidemarker lamp: w/  
Tail light: w/  
Stop light: w/  
RH/LH: LH  
E-approval: Yes

**171328 Multi Function Lamp** Std pkg 1

Lens: HC-CARGO 171330.

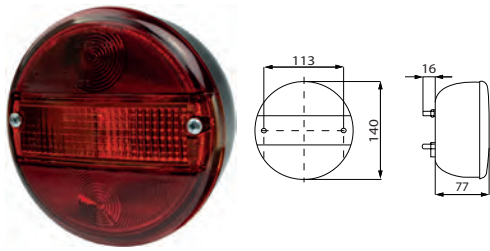

Bulb incl.: No  
Watt: 21  
Watt 2: 5

Dim.: 140x77 mm  
OD: 140 mm  
Dist. mount. holes:  
45 mm

Socket type: BA15S  
Socket type 2: BA15S  
Material: Shockproof plastic  
Shape: Round  
Fixing screw: 2  
Flasher light: w/  
Numberplate light: w/  
Tail light: w/  
Stop light: w/  
E-approval: Yes

**171329 Multi Function Lamp** Std pkg 1

Mounting kit: HC-CARGO 171266. Lens: HC-CARGO 171330.

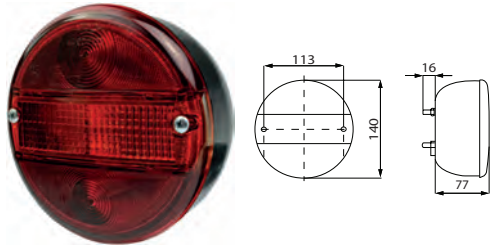

Bulb incl.: No

Dim.: 140x77 mm  
OD: 140 mm  
Dist. mount. holes:  
45 mm

Socket type: BA15S  
Material: Shockproof plastic  
Shape: Round  
Fixing screw: 2  
Flasher light: w/  
Tail light: w/  
Stop light: w/  
E-approval: Yes

**171441 Multi Function Lamp** Std pkg 1

Servicing: Commercial trailers - Visit [www.hc-cargo.com](http://www.hc-cargo.com) for further information.

Lens: HC-CARGO 171446. Right: HC-CARGO 171442.

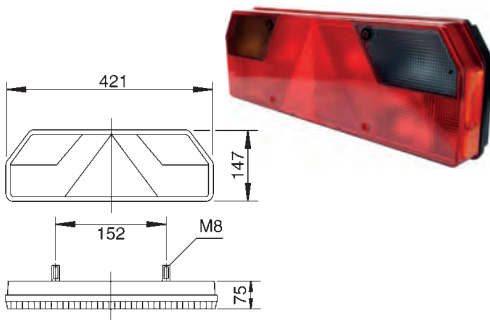

Bulb incl.: No  
Watt: 21  
Watt 2: 20/5  
Watt 3: 10

Dim.: 421x147x75 mm  
Dist. mount. holes:  
152 mm

Socket type: BA15S  
Socket type 2: BAY15d  
Socket type 3: BA10s  
Material: Shockproof plastic  
Shape: Rectangular  
Reflector: w/  
Flasher light: w/  
Numberplate light: w/  
Rear/fog lamp: w/o  
Reverse light: w/o  
Sidemarker lamp: w/o  
Tail light: w/  
Stop light: w/  
RH/LH: LH  
E-approval: Yes

**171442 Multi Function Lamp** Std pkg 1

Servicing: Commercial trailers - Visit [www.hc-cargo.com](http://www.hc-cargo.com) for further information.

Lens: HC-CARGO 171446. Left: HC-CARGO 171441.

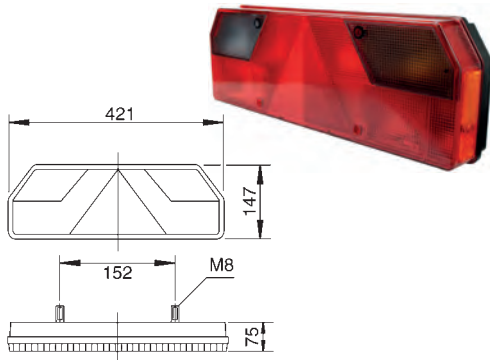

Bulb incl.: No  
Watt: 21  
Watt 2: 21/5  
Watt 3: 5  
Watt 4: 10

Dim.: 421x147x75 mm  
Dist. mount. holes:  
152 mm

Socket type: BA15S  
Socket type 2: BAY15d  
Socket type 3: BA15S  
Socket type 4: BA10s  
Material: Shockproof plastic  
Shape: Rectangular  
Reflector: w/  
Flasher light: w/  
Numberplate light: w/  
Rear/fog lamp: w/  
Reverse light: w/o  
Sidemarker lamp: w/  
Tail light: w/  
Stop light: w/  
RH/LH: RH  
E-approval: Yes

**171443 Multi Function Lamp** Std pkg 1

Servicing: Schwarzmüller - Visit [www.hc-cargo.com](http://www.hc-cargo.com) for further information.

Lens: HC-CARGO 171446. Right: HC-CARGO 171444.

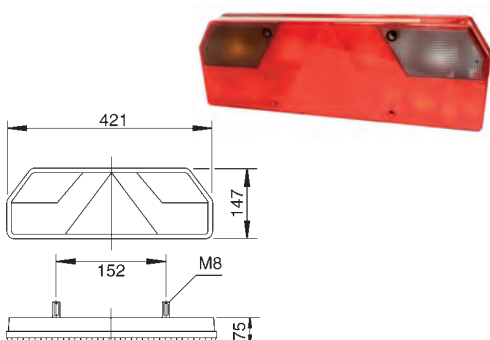

Bulb incl.: No  
Watt: 21  
Watt 2: 21/5  
Watt 3: 5  
Watt 4: 10

Dim.: 421x147x75 mm  
Dist. mount. holes:  
152 mm

Socket type: BA15S  
Socket type 2: BAY15d  
Socket type 3: BA15S  
Socket type 4: BA10s  
Material: Shockproof plastic  
Shape: Rectangular  
Reflector: w/  
Flasher light: w/  
Numberplate light: w/  
Rear/fog lamp: w/  
Reverse light: w/o  
Sidemarker lamp: w/  
Tail light: w/  
Stop light: w/  
RH/LH: LH  
E-approval: Yes

**171444 Multi Function Lamp** Std pkg 1 Servicing: Schwarzmüller - Visit [www.hc-cargo.com](http://www.hc-cargo.com) for further information.

Lens: HC-CARGO 171446. Left: HC-CARGO 171443.

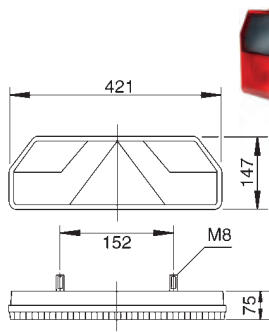

Bulb incl.: No  
Watt: 21  
Watt 2: 21/5  
Watt 3: 5  
Watt 4: 10

Dim.: 421x147x75 mm  
Dist. mount. holes:  
152 mm

Socket type: BA15S  
Socket type 2: BAY15d  
Socket type 3: BA15S  
Socket type 4: BA10s  
Material: Shockproof plastic  
Shape: Rectangular  
Reflector: w/  
Flasher light: w/  
Numberplate light: w/  
Rear/fog lamp: w/  
Reverse light: w/o  
Sidemarker lamp: w/  
Tail light: w/  
Stop light: w/  
RH/LH: RH  
E-approval: Yes

**171447 Multi Function Lamp** Std pkg 1 Servicing: Mercedes Actros SK - Visit [www.hc-cargo.com](http://www.hc-cargo.com) for further information.

Lens: HC-CARGO 171521. Right: HC-CARGO 171448.

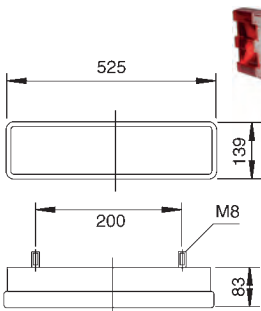

Bulb incl.: No  
Watt: 21  
Watt 2: 5  
Watt 3: 10

Dim.: 525x139x83 mm  
Dist. mount. holes:  
200 mm

Socket type: BA15S  
Socket type 2: BA15S  
Socket type 3: BA15S  
Material: Shockproof plastic  
Shape: Rectangular  
Reflector: w/  
Flasher light: w/  
Numberplate light: w/  
Rear/fog lamp: w/  
Reverse light: w/  
Sidemarker lamp: w/  
Tail light: w/  
Stop light: w/  
RH/LH: LH  
E-approval: Yes

**171448 Multi Function Lamp** Std pkg 1 Servicing: Mercedes Actros SK - Visit [www.hc-cargo.com](http://www.hc-cargo.com) for further information.

Lens: HC-CARGO 171312. Left: HC-CARGO 171447.

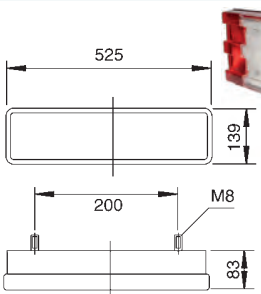

Bulb incl.: No  
Watt: 21  
Watt 2: 5  
Watt 3: 10

Dim.: 525x139x83 mm  
Dist. mount. holes:  
200 mm

Socket type: BA15S  
Socket type 2: BA15S  
Socket type 3: BA15S  
Material: Shockproof plastic  
Shape: Rectangular  
Reflector: w/  
Flasher light: w/  
Rear/fog lamp: w/  
Reverse light: w/  
Sidemarker lamp: w/  
Tail light: w/  
Stop light: w/  
RH/LH: RH  
E-approval: Yes

**171506 Multi Function Lamp** Std pkg 1 Servicing: DAF, Nissan, Renault - Visit [www.hc-cargo.com](http://www.hc-cargo.com) for further information.

2 bulb holders for tail light. Lens: HC-CARGO 171507. Multi Connector: HC-CARGO 171788, 172066.

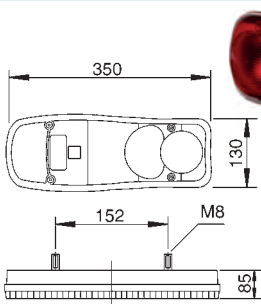

Bulb incl.: No  
Watt: 21  
Watt 2: 5  
Watt 3: 10

Dim.: 350x130x85 mm  
Dist. mount. holes:  
152 mm

Socket type: BA15S  
Socket type 2: BA15S  
Socket type 3: BA15S  
Material: Shockproof plastic  
Shape: Rectangular  
Reflector: w/  
Flasher light: w/  
Numberplate light: w/  
Rear/fog lamp: w/  
Reverse light: w/  
Sidemarker lamp: w/o  
Tail light: w/  
Stop light: w/  
RH/LH: RH/LH  
E-approval: Yes

**171508 Multi Function Lamp** Std pkg 1 Servicing: Commercial trailers - Visit [www.hc-cargo.com](http://www.hc-cargo.com) for further information.

Optional use. 2 bulb holders for tail light. Lens: HC-CARGO 171507.

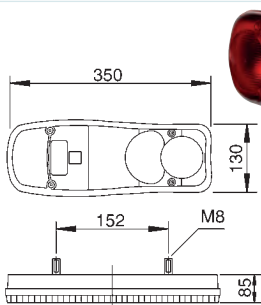

Bulb incl.: No  
Watt: 21  
Watt 2: 5  
Watt 3: 10

Dim.: 350x130x85 mm  
Dist. mount. holes:  
152 mm

Socket type: BA15S  
Socket type 2: BA15S  
Socket type 3: BA15S  
Material: Shockproof plastic  
Shape: Rectangular  
Flasher light: w/  
Numberplate light: w/  
Rear/fog lamp: w/  
Reverse light: w/  
Sidemarker lamp: w/o  
Tail light: w/  
Stop light: w/  
RH/LH: RH/LH  
Approvals: CE  
E-approval: Yes

**171700 Multi Function Lamp** Std pkg 1

Lens: HC-CARGO 171702. Left: HC-CARGO 171701.

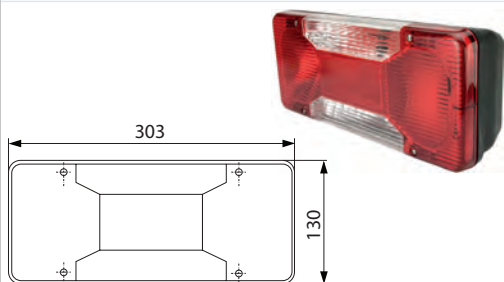

Bulb incl.: No  
Voltage: 12/24

Dim.: 303x130x81 mm  
Dist. mount. holes:  
190 mm

Material: Shockproof plastic  
Shape: Rectangular  
Reflector: w/  
Flasher light: w/  
Numberplate light: w/o  
Rear/fog lamp: w/  
Reverse light: w/  
Sidemarker lamp: w/o  
Tail light: w/  
Stop light: w/  
RH/LH: RH  
E-approval: Yes

**171701 Multi Function Lamp** Std pkg 1

Lens: HC-CARGO 171702. Lens, Rear Lamp: HC-CARGO 171703. Right: HC-CARGO 171700.

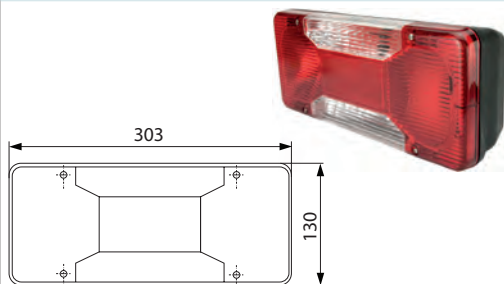

Bulb incl.: No  
Voltage: 12/24

Dim.: 303x130x81 mm  
Dist. mount. holes:  
190 mm

Material: Shockproof plastic  
Shape: Rectangular  
Reflector: w/  
Flasher light: w/  
Numberplate light: w/o  
Rear/fog lamp: w/  
Reverse light: w/  
Sidemarker lamp: w/o  
Tail light: w/  
Stop light: w/  
RH/LH: LH  
E-approval: Yes

**171802 Multi Function Lamp** Std pkg 1 Servicing: Scania - Visit [www.hc-cargo.com](http://www.hc-cargo.com) for further information.

Lens: HC-CARGO 171322. Multi plug: HC-CARGO 171788, 172066. Left: HC-CARGO 171803.

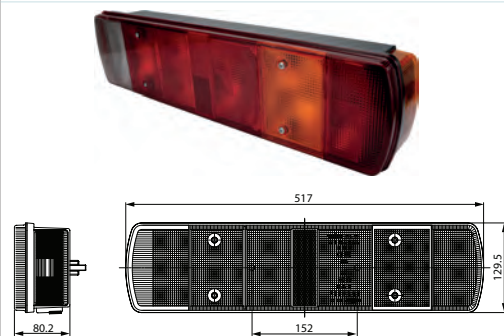

Bulb incl.: No  
Watt: 21  
Watt 2: 5

Dim.:  
517x129.5x80.2 mm  
Dist. mount. holes:  
152 mm

Socket type: BA15S  
Socket type 2: BA15S  
Material: Shockproof plastic  
Shape: Rectangular  
Reflector: w/  
Flasher light: w/  
Numberplate light: w/  
Rear/fog lamp: w/  
Reverse light: w/  
Sidemarker lamp: w/  
Tail light: w/  
Stop light: w/  
RH/LH: RH  
E-approval: Yes

**171803 Multi Function Lamp** Std pkg 1 Servicing: Scania, Opel - Visit [www.hc-cargo.com](http://www.hc-cargo.com) for further information.

Lens: HC-CARGO 171322. Multi plug: HC-CARGO 171788, 172066. Right: HC-CARGO 171802.

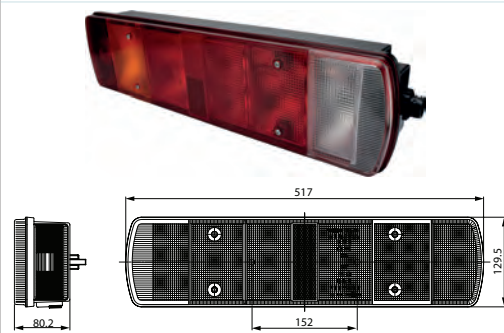

Bulb incl.: No  
Watt: 21  
Watt 2: 5

Dim.:  
517x129.5x80.2 mm  
Dist. mount. holes:  
152 mm

Socket type: BA15S  
Socket type 2: BA15S  
Material: Shockproof plastic  
Shape: Rectangular  
Reflector: w/  
Flasher light: w/  
Numberplate light: w/  
Rear/fog lamp: w/  
Reverse light: w/  
Sidemarker lamp: w/  
Tail light: w/  
Stop light: w/  
RH/LH: LH  
E-approval: Yes

**171806 Multi Function Lamp** Std pkg 1 Servicing: Trucks, Universal - Visit [www.hc-cargo.com](http://www.hc-cargo.com) for further information.

Lens: HC-CARGO 171810. Right: HC-CARGO 171807.

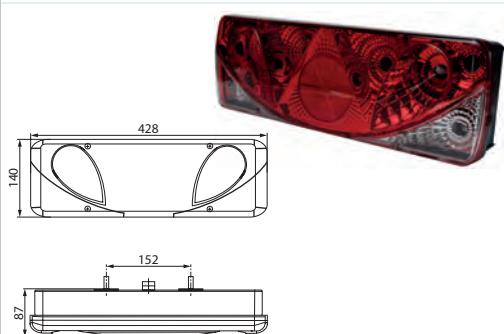

Bulb incl.: No  
Watt: 21/5  
Watt 2: 21  
Watt 3: 21  
Watt 4: 5

Dim.: 428x140x87 mm  
Dist. mount. holes:  
152 mm

Socket type: BAY15d  
Socket type 2: BA15S  
Socket type 3: BAU15s  
Socket type 4: BA15S  
Material: Shockproof plastic  
Shape: Rectangular  
Flasher light: w/  
Rear/fog lamp: w/  
Reverse light: w/  
Sidemarker lamp: w/  
Tail light: w/  
Stop light: w/  
RH/LH: LH  
E-approval: Yes

**171807 Multi Function Lamp** Std pkg 1 Servicing: Trucks, Universal - Visit [www.hc-cargo.com](http://www.hc-cargo.com) for further information.

Lens: HC-CARGO 171810. Left: HC-CARGO 171806.

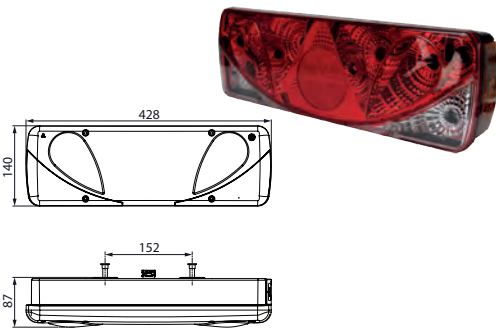

Bulb incl.: No  
Watt: 21/5  
Watt 2: 21  
Watt 3: 21  
Watt 4: 5

Dim.: 428x140x87 mm  
Dist. mount. holes:  
152 mm

Socket type: BAY15d  
Socket type 2: BA15S  
Socket type 3: BAU15s  
Socket type 4: BA15S  
Material: Shockproof plastic  
Shape: Rectangular  
Flasher light: w/  
Rear/fog lamp: w/  
Reverse light: w/  
Sidemarker lamp: w/  
Tail light: w/  
Stop light: w/  
RH/LH: RH  
E-approval: Yes

**171808 Multi Function Lamp** Std pkg 1 Servicing: Commercial trailers - Visit [www.hc-cargo.com](http://www.hc-cargo.com) for further information.

Lens: HC-CARGO 171810. Right: HC-CARGO 171809.

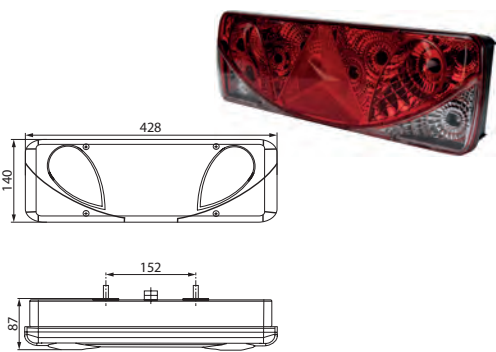

Bulb incl.: No  
Watt: 21/5  
Watt 2: 21  
Watt 3: 21  
Watt 4: 5

Dim.: 428x140x87 mm  
Dist. mount. holes:  
152 mm

Socket type: BAY15d  
Socket type 2: BA15S  
Socket type 3: BAU15s  
Socket type 4: BA15S  
Material: Shockproof plastic  
Shape: Rectangular  
Reflector: w/  
Flasher light: w/  
Rear/fog lamp: w/  
Reverse light: w/  
Sidemarker lamp: w/  
Tail light: w/  
Stop light: w/  
RH/LH: LH  
E-approval: Yes

**171809 Multi Function Lamp** Std pkg 1 Servicing: Commercial trailers - Visit [www.hc-cargo.com](http://www.hc-cargo.com) for further information.

Lens: HC-CARGO 171810. Left: HC-CARGO 171808.

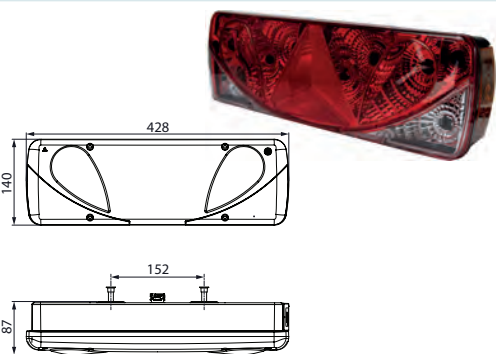

Bulb incl.: No  
Watt: 21/5  
Watt 2: 21  
Watt 3: 21  
Watt 4: 5

Dim.: 428x140x87 mm  
Dist. mount. holes:  
152 mm

Socket type: BAY15d  
Socket type 2: BA15S  
Socket type 3: BAU15s  
Socket type 4: BA15S  
Material: Shockproof plastic  
Shape: Rectangular  
Reflector: w/  
Flasher light: w/  
Rear/fog lamp: w/  
Reverse light: w/  
Sidemarker lamp: w/  
Tail light: w/  
Stop light: w/  
RH/LH: RH  
E-approval: Yes

**171870 Multi Function Lamp** Std pkg 1 Servicing: HC-CARGO 171818, 171872

Lens: HC-CARGO 171834. Multi connector: HC-CARGO 171537, 171538. Right: HC-CARGO 171871.

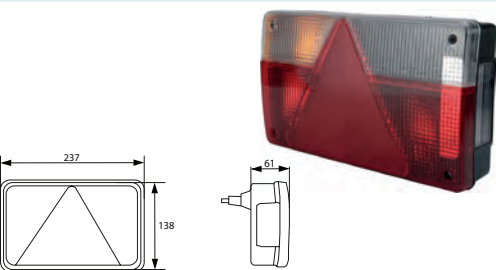

Bulb incl.: Yes  
Voltage: 12

Dim.: 237x138x61 mm

Shape: Rectangular  
Flasher light: w/  
Numberplate light: w/  
Rear/fog lamp: w/  
Reverse light: w/o  
Sidemarker lamp: w/o  
Sidemarker: w/  
Stop light: w/  
RH/LH: LH  
E-approval: Yes

**171871 Multi Function Lamp** Std pkg 1 Servicing: HC-CARGO 171818, 171872



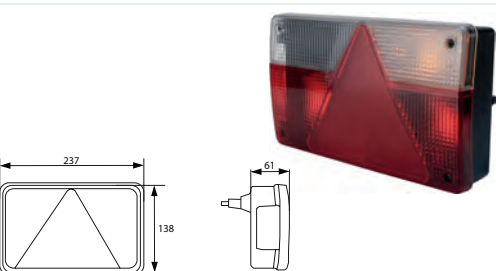



Lens: HC-CARGO 171833. Multi connector: HC-CARGO 171537, 171538. Left: HC-CARGO 171870.



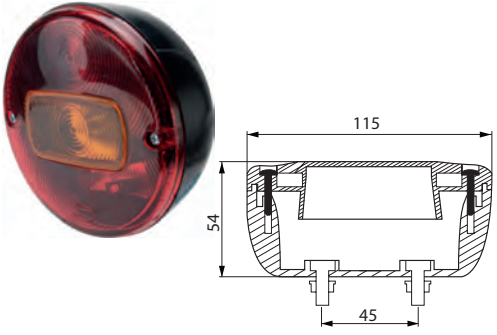



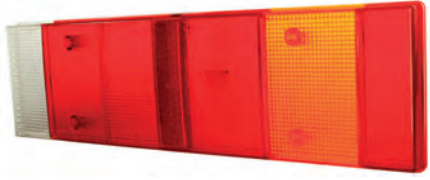



Bulb incl.: Yes  
Voltage: 12

Dim.: 237x138x61 mm

Shape: Rectangular  
Flasher light: w/  
Numberplate light: w/  
Rear/fog lamp: w/  
Reverse light: w/o  
Sidemarker lamp: w/o  
Sidemarker: w/  
Stop light: w/  
RH/LH: RH  
E-approval: Yes

		EL. SPECIFICATIONS	DIMENSIONS	ADDITIONAL SPECIFICATIONS
<b>171917</b> Multi Function Lamp <span style="float: right;">Std pkg 1</span> 		Bulb incl.: No Watt: 5 Watt 2: 18 Watt 3: 18	Dim.: 115x54 mm OD: 115 mm Dist. mount. holes: 45 mm	Bulb type: 10.5x36 mm Bulb type 2: 15x41 mm Bulb type 3: 15x41 mm Socket type: S8.5 Socket type 2: S8.5 Socket type 3: S8.5 Colour/glass: Red/yellow Material/dome: PMMA Shape: Round Fixing screw: 2 Flasher light: w/ Tail light: w/ Stop light: w/ RH/LH: RH/LH
<b>SPARE PARTS</b>				
<b>170665</b> Lens, Rear Lamp <span style="float: right;">Std pkg 1 Servicing: HC-CARGO 170602, 160603</span> 				Shape: Rectangular
<b>170910</b> Lens, Rear Lamp <span style="float: right;">Std pkg 1 Servicing: HC-CARGO 170909</span> 			Dim.: 140x26.8 mm Dist. mount. holes: 111 mm	Colour: White Shape: Round
<b>170968</b> Lens, Rear Lamp <span style="float: right;">Std pkg 1 Servicing: HC-CARGO 170916, 170917, 170922, 170923</span> 			Dim.: 465x130 mm	Shape: Rectangular
<b>171000</b> Lens, Rear Lamp <span style="float: right;">Std pkg 2 Servicing: HC-CARGO 170998, 170999</span> 			Dim.: 465x130x83 mm	Shape: Rectangular
<b>171062</b> Lens, Rear Lamp <span style="float: right;">Std pkg 1 Servicing: HC-CARGO 170895, 170893</span> 			Dim.: 335x96 mm	Material: Shockproof plastic Shape: Rectangular Numberplate light: w/
<b>171263</b> Lens, Rear Lamp <span style="float: right;">Std pkg 1 Servicing: HC-CARGO 171206, 171205</span> 			Dim.: 343x133 mm	Material: Shockproof plastic Shape: Rectangular Reflector: w/ Numberplate light: w/



EL. SPECIFICATIONS		DIMENSIONS	ADDITIONAL SPECIFICATIONS
171307 Lens, Rear Lamp	Std pkg 1 Servicing: HC-CARGO	171299, 171302, 171303, 171306	
		Dim.: 465x130 mm	Shape: Rectangular
171312 Lens, Rear Lamp	Std pkg 1 Servicing: HC-CARGO	171308, 171448	
		Dim.: 525x139 mm	Shape: Rectangular Reflector: w/
171322 Lens, Rear Lamp	Std pkg 1 Servicing: HC-CARGO	171802, 171803	
		Dim.: 516x130 mm Dist. mount. holes: 152 mm	Shape: Rectangular
171330 Lens, Rear Lamp	Std pkg 1 Servicing: HC-CARGO	171328, 171329	
		OD: 140 mm	Shape: Round RH/LH: RH/LH
171446 Lens, Rear Lamp	Std pkg 1 Servicing: HC-CARGO	171441, 171442, 171443, 171444	
		Dim.: 421x147 mm	Shape: Rectangular Reflector: w/ Numberplate light: w/
171507 Lens, Rear Lamp	Std pkg 2 Servicing: HC-CARGO	171506, 171508	
		Dim.: 350x130 mm	Material: Shockproof plastic Shape: Rectangular Reflector: w/ Numberplate light: w/ RH/LH: RH/LH
171521 Lens, Rear Lamp	Std pkg 1 Servicing: HC-CARGO	171311, 171447	
		Dim.: 525x139 mm	Shape: Rectangular Reflector: w/
171702 Lens, Rear Lamp	Std pkg 1 Servicing: HC-CARGO	171700, 171701	
		Dim.: 303x130 mm	Material: Shockproof plastic Shape: Rectangular Reflector: w/ RH/LH: RH

## ACCESSORIES - Lighting

O.E.M. names and numbers are used for reference purposes only.

EL. SPECIFICATIONS		DIMENSIONS	ADDITIONAL SPECIFICATIONS
<b>171703</b> Lens, Rear Lamp	Std pkg 1 Servicing: HC-CARGO 171701	Dim.: 303x130 mm	Material: Shockproof plastic Shape: Rectangular Reflector: w/ RH/LH: LH
			
<b>171810</b> Lens, Rear Lamp	Std pkg 1 Servicing: HC-CARGO 171806, 171807, 171808, 171809	Dim.: 428x140 mm	Shape: Rectangular RH/LH: RH/LH
			

## ACCESSORIES

<b>171788</b> Multiconnector 7 pin	Std pkg 1 Servicing: HC-CARGO 171506, 171756, 171757, 171802, 171803, 171927, 171928, 171929, 171930, 172061, 172062, 172063, 172064	Gasket: HC-CARGO 192178. Terminal: HC-CARGO 193250.	
			
			Type/terminal: Round Colour: Black No./poles: 7 Plug: Female
<b>172066</b> Multiconnector 7 pin	Std pkg 1 Servicing: HC-CARGO 171506, 171756, 171757, 171802, 171803, 171927, 171928, 171929, 171930, 172061, 172062, 172063, 172064	Gasket: HC-CARGO 192178. Terminal: HC-CARGO 193250.	
			
			Type/terminal: Round Colour: Black No./poles: 7 Plug: Female

<b>181627</b> Bayonet connector	Std pkg 1 Servicing: HC-CARGO 181617	Voltage: 12	Mount.: Terminal No./poles: 8
			

## TRAILER LAMPS LED (TRUCKS)

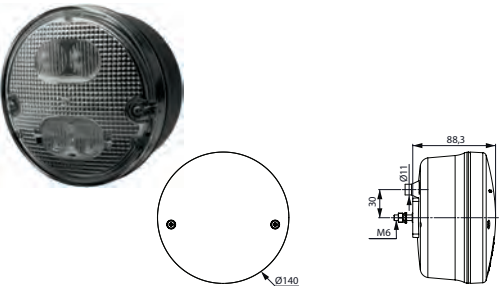
<b>170909</b> LED Fog/Reverse Lamp	Std pkg 1	Voltage: 12/24	Dim.: 140x88.3 mm OD: 140 mm Dist. mount. holes: 45 mm	Type: LED Colour/glass: White Material: Shockproof plastic Shape: Round Fixing screw: 2 Rear/fog lamp: w/ Tail light: w/ LEDs: w/ No./LEDs: 4 E-approval: Yes
<i>Lens and o-ring: HC-CARGO 170910.</i>				
				



<b>171549 LED Multifunction Lamp</b> Std pkg 1 <i>Mounting kit: HC-CARGO 171266.</i>		<b>Voltage:</b> 9-33 <b>Dim.:</b> 140x60 mm <b>Dist. mount. holes:</b> 45 mm	<b>Type:</b> LED <b>Colour:</b> Black <b>Material:</b> Shockproof plastic <b>Shape:</b> Round <b>Fixing screw:</b> 2 <b>Flasher light:</b> w/ <b>Tail light:</b> w/ <b>Stop light:</b> w/ <b>No./LEDs:</b> 63 <b>E-approval:</b> Yes
<b>171550 LED Multifunction Lamp</b> Std pkg 1 <i>w/ transparent lens when light is off. Mounting kit: HC-CARGO 171266.</i>		<b>Voltage:</b> 9-33 <b>Dim.:</b> 140x52.5 mm <b>Dist. mount. holes:</b> 45 mm	<b>Type:</b> LED <b>Material:</b> Shockproof plastic <b>Shape:</b> Round <b>Fixing screw:</b> 2 <b>Flasher light:</b> w/ <b>Tail light:</b> w/ <b>Stop light:</b> w/ <b>No./LEDs:</b> 63 <b>E-approval:</b> Yes
<b>171665 LED Multifunction Lamp</b> Std pkg 1 <i>Right: HC-CARGO 171666.</i>		<b>Voltage:</b> 12/24 <b>Dim.:</b> 336x151x67 mm <b>Dist. mount. holes:</b> 152 mm	<b>Type:</b> LED <b>Material:</b> Shockproof plastic <b>Shape:</b> Rectangular <b>Reflector:</b> w/ <b>Flasher light:</b> w/ <b>Reverse light:</b> w/ <b>Tail light:</b> w/ <b>Stop light:</b> w/ <b>RH/LH:</b> LH <b>E-approval:</b> Yes
<b>171666 LED Multifunction Lamp</b> Std pkg 1 <i>Left: HC-CARGO 171665.</i>		<b>Voltage:</b> 12/24 <b>Dim.:</b> 336x151x67 mm <b>Dist. mount. holes:</b> 152 mm	<b>Type:</b> LED <b>Material:</b> Shockproof plastic <b>Shape:</b> Rectangular <b>Reflector:</b> w/ <b>Flasher light:</b> w/ <b>Reverse light:</b> w/ <b>Tail light:</b> w/ <b>Stop light:</b> w/ <b>RH/LH:</b> RH <b>E-approval:</b> Yes
<b>171725 LED Multifunction Lamp</b> Std pkg 1 <i>Ring: amber, center: red.</i>		<b>Voltage:</b> 12/24 <b>Dim.:</b> 122x84.5 mm <b>OD:</b> 122 mm <b>Cable length:</b> 150 mm <b>Dist. mount. holes:</b> 44 mm	<b>Type:</b> LED <b>Material:</b> Shockproof plastic <b>Material/dome:</b> Shockproof plastic <b>Shape:</b> Round <b>Fixing screw:</b> 6 <b>Flasher light:</b> w/ <b>Tail light:</b> w/ <b>Stop light:</b> w/ <b>No./LEDs:</b> 44 <b>E-approval:</b> Yes
<b>171726 LED Fog/Reverse Lamp</b> Std pkg 1 <i>Ring: clear, center: red.</i>		<b>Voltage:</b> 12/24 <b>Dim.:</b> 122x84.5 mm <b>OD:</b> 122 mm <b>Cable length:</b> 150 mm <b>Dist. mount. holes:</b> 44 mm	<b>Type:</b> LED <b>Material:</b> Shockproof plastic <b>Material/dome:</b> Shockproof plastic <b>Shape:</b> Round <b>Rear/fog lamp:</b> w/ <b>Reverse light:</b> w/ <b>No./LEDs:</b> 38 <b>E-approval:</b> Yes

**171927 LED Multifunction Lamp** Std pkg 1

Multi-plug: HC-CARGO 171788, 172066. Left: HC-CARGO 171928.

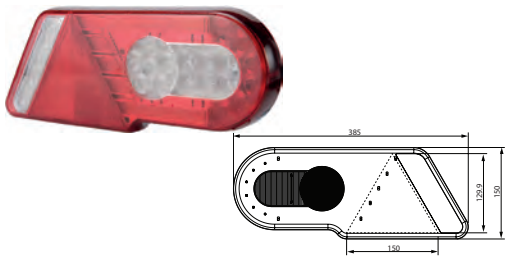

Voltage: 12-24

 Dim.: 385x150x34.1 mm  
 Dist. mount. holes:  
 152.3 mm

 Type: LED  
 Shape: Rectangular  
 Reflector: w/  
 Flasher light: w/  
 Rear/fog lamp: w/  
 Reverse light: w/  
 Tail light: w/  
 Stop light: w/  
 RH/LH: RH  
 Tightness norm: IP 67  
 Approvals: CE  
 E-approval: Yes

**171928 LED Multifunction Lamp** Std pkg 1

Multi-plug: HC-CARGO 171788, 172066. Right: HC-CARGO 171927.

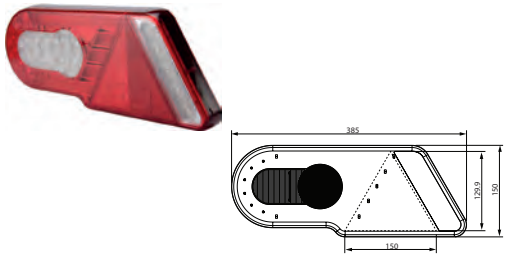

Voltage: 12-24

 Dim.: 385x150x34.1 mm  
 Dist. mount. holes:  
 152 mm

 Type: LED  
 Shape: Rectangular  
 Reflector: w/  
 Flasher light: w/  
 Rear/fog lamp: w/  
 Reverse light: w/  
 Tail light: w/  
 Stop light: w/  
 RH/LH: LH  
 Tightness norm: IP 67  
 Approvals: CE  
 E-approval: Yes

**171929 LED Multifunction Lamp** Std pkg 1

Multi-plug: HC-CARGO 171788, 172066. Left: HC-CARGO 171930.

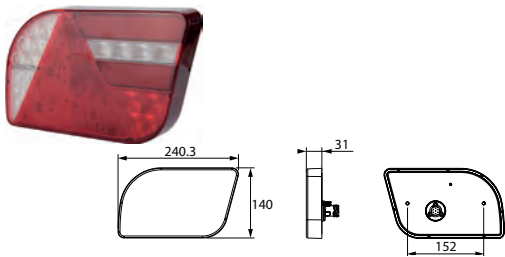

Voltage: 12-24

 Dim.: 240.3x140x31 mm  
 Dist. mount. holes:  
 152 mm

 Type: LED  
 Shape: Rectangular  
 Reflector: w/  
 Flasher light: w/  
 Rear/fog lamp: w/  
 Reverse light: w/  
 Tail light: w/  
 Stop light: w/  
 RH/LH: RH  
 Tightness norm: IP 67  
 Approvals: CE  
 E-approval: Yes

**171930 LED Multifunction Lamp** Std pkg 1

Multi-plug: HC-CARGO 171788, 172066. Right: HC-CARGO 171929.

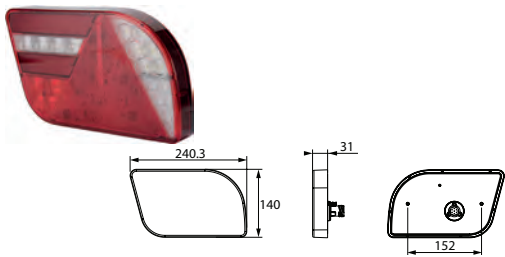

Voltage: 12-24

 Dim.: 240.3x140x31 mm  
 Dist. mount. holes:  
 152 mm

 Type: LED  
 Shape: Rectangular  
 Reflector: w/  
 Flasher light: w/  
 Rear/fog lamp: w/  
 Reverse light: w/  
 Tail light: w/  
 Stop light: w/  
 RH/LH: LH  
 Tightness norm: IP 67  
 Approvals: CE  
 E-approval: Yes

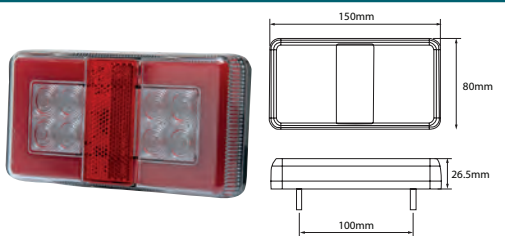
**171952 LED Multifunction Lamp** Std pkg 1

Voltage: 12-24

 Dim.: 150x80x26.5 mm  
 Cable length: 300 mm  
 Dist. mount. holes:  
 100 mm

 Type: LED  
 Shape: Rectangular  
 Mount.: 2 screws  
 Reflector: w/  
 No./reflectors: 1  
 Flasher light: w/  
 Tail light: w/  
 Stop light: w/  
 Tightness norm: IP 67  
 Approvals: CE  
 E-approval: Yes

**172061 LED Multifunction Lamp** Std pkg 1

Lens: HC-CARGO 172065. Plug: HC-CARGO 171788, 172066. Left: HC-CARGO 172062.

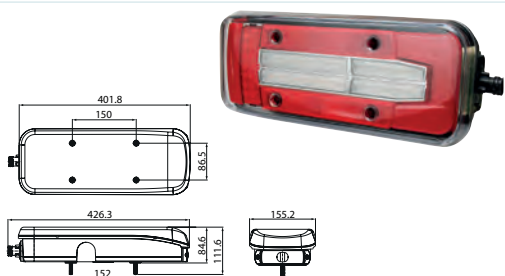

Voltage: 12-24

 Dim.:  
 426.3x155.2x111.6 mm  
 Dist. mount. holes:  
 152 mm

 Type: LED  
 Material: PP  
 Material/dome: Polycarbonate  
 Shape: Rectangular  
 Reflector: w/  
 Flasher light: w/  
 Rear/fog lamp: w/  
 Reverse light: w/  
 Sidemarker lamp: w/  
 Tail light: w/  
 Stop light: w/  
 RH/LH: RH  
 E-approval: Yes

**172062 LED Multifunction Lamp** Std pkg 1

Lens: HC-CARGO 172065. Plug: HC-CARGO 171788, 172066. Right: HC-CARGO 172061.

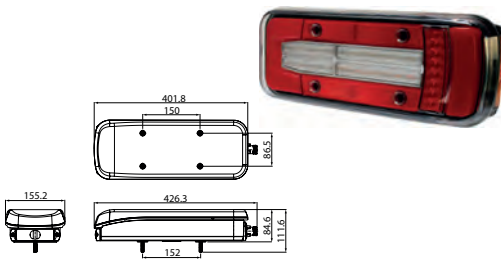

Voltage: 12-24

Dim.: 426.3x155.2x111.6 mm  
Dist. mount. holes: 152 mm

Type: LED  
Material: PP  
Material/dome: Polycarbonate  
Shape: Rectangular  
Reflector: w/  
Flasher light: w/  
Rear/fog lamp: w/  
Reverse light: w/  
Sidemarker lamp: w/  
Tail light: w/  
Stop light: w/  
RH/LH: LH  
E-approval: Yes

**172063 LED Multifunction Lamp** Std pkg 1

Lens: HC-CARGO 172067. Plug: HC-CARGO 171788, 172066. Left: HC-CARGO 172064.

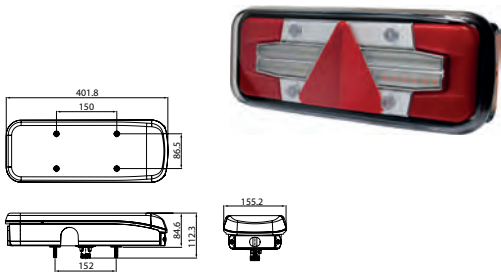

Voltage: 12-24

Dim.: 401.8x155.2x112.3 mm  
Dist. mount. holes: 152 mm

Type: LED  
Material: PP  
Material/dome: Polycarbonate  
Shape: Rectangular  
Reflector: w/  
Flasher light: w/  
Rear/fog lamp: w/  
Reverse light: w/  
Sidemarker lamp: w/  
Tail light: w/  
Stop light: w/  
RH/LH: RH  
E-approval: Yes

**172064 LED Multifunction Lamp** Std pkg 1

Lens: HC-CARGO 172067. Plug: HC-CARGO 171788, 172066. Right: HC-CARGO 172063.

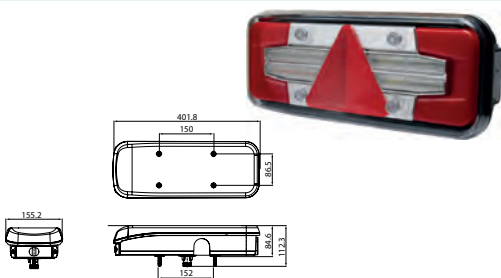

Voltage: 12-24

Dim.: 401.8x155.2x112.3 mm  
Dist. mount. holes: 152 mm

Type: LED  
Material: PP  
Material/dome: Polycarbonate  
Shape: Rectangular  
Reflector: w/  
Flasher light: w/  
Rear/fog lamp: w/  
Reverse light: w/  
Sidemarker lamp: w/  
Tail light: w/  
Stop light: w/  
RH/LH: LH  
E-approval: Yes

**SPARE PARTS**

**172065 Lens, Rear Lamp** Std pkg 1 Servicing: HC-CARGO 172061, 172062



Dim.: 401.8x155.2 mm

Material/dome: Polycarbonate  
RH/LH: RH/LH

**172067 Lens, Rear Lamp** Std pkg 1 Servicing: HC-CARGO 172063, 172064



Dim.: 401.8x155.2 mm

Material/dome: Polycarbonate  
RH/LH: RH/LH

**ACCESSORIES**

**160970 Load Resistor 12 V** Std pkg 1

Contains: 2 pcs.



Voltage: 12  
Amp: 2  
Watt: 50

Length: 50 mm  
Width: 15 mm

**160971 Load Resistor 24 V** Std pkg 1

Contains: 2 pcs.

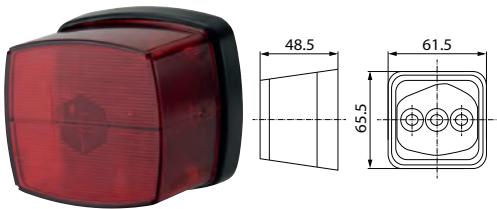

 Voltage: 24  
 Amp: 1  
 Watt: 50

 Length: 50 mm  
 Width: 15 mm

**TAIL LAMPS CONVENTIONAL**
**171173 Tail Lamp** Std pkg 1

 Bulb incl.: No  
 Watt: 5

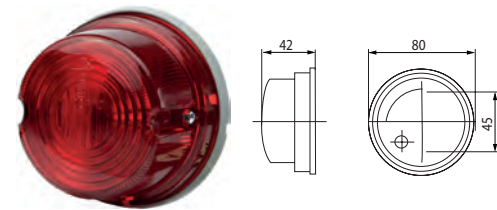
 Dim.: 62x62x45 mm  
 Dist. mount. holes:  
 30 mm

 Socket type: S8.5  
 Connection: Terminal  
 Colour/glass: Red  
 Material: Shockproof plastic  
 Shape: Rectangular  
 Fixing screw: 2  
 Sidemarker: w/  
 E-approval: Yes

**171181 Tail Lamp** Std pkg 1

 Bulb incl.: No  
 Watt: 5

 Dim.: 80x42 mm  
 Dist. mount. holes:  
 45 mm

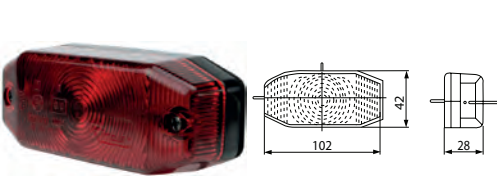
 Socket type: S8.5  
 Colour/glass: Red  
 Material: Shockproof plastic  
 Shape: Round  
 Fixing screw: 2  
 E-approval: Yes

**171331 Tail Lamp** Std pkg 1

 Bulb incl.: No  
 Watt: 5

 Dim.: 102x42x28 mm  
 Dist. mount. holes:  
 65 mm

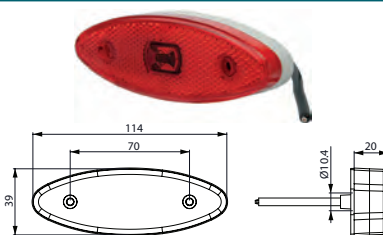
 Socket type: S8.5  
 Colour/glass: Red  
 Material: Plastic  
 Shape: Hexagon  
 Fixing screw: 2  
 E-approval: Yes

**TAIL LAMPS LED**
**171605 LED Tail Lamp** Std pkg 1

Voltage: 24

 Dim.: 114x39x20 mm  
 Cable length: 500 mm  
 Dist. mount. holes:  
 70 mm

 Type: LED  
 Colour/glass: Red  
 Material: Shockproof plastic  
 Shape: Oval  
 Reflector: w/  
 Fixing screw: 2  
 Tail light: w/  
 No./LEDs: 3  
 Approvals: ADR  
 E-approval: Yes  
 Alternativ no. 172040

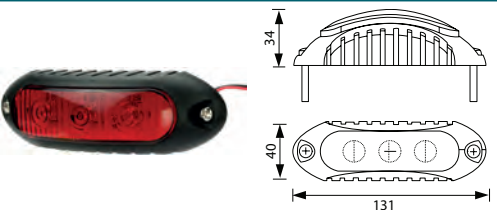
**171635 LED Tail Lamp** Std pkg 1

Voltage: 9-36

 Dim.: 131x40x34 mm  
 Dist. mount. holes:  
 115 mm

 Type: LED  
 Colour/glass: Red  
 Material: PP/PMMA  
 Shape: Oval  
 Tail light: w/  
 No./LEDs: 3  
 E-approval: Yes

**171637 LED Tail Lamp** Std pkg 1

Angle Bracket: HC-CARGO 171639.

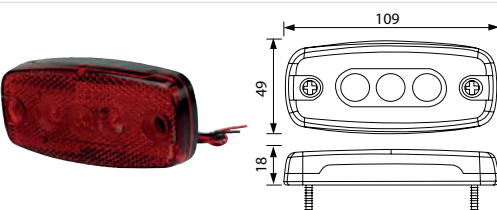
 Voltage: 9-36  
 Watt: 0.9

 Dim.: 109x49x18 mm  
 Dist. mount. holes:  
 83 mm

 Type: LED  
 Colour/glass: Red  
 Shape: Rectangular  
 Reflector: w/  
 Tail light: w/  
 No./LEDs: 3  
 E-approval: Yes

		EL. SPECIFICATIONS	DIMENSIONS	ADDITIONAL SPECIFICATIONS
<b>171719 LED Tail Lamp</b> Std pkg 1				
		<b>Voltage:</b> 12/24	<b>Dim.:</b> 130x57x42.5 mm <b>Dist. mount. holes:</b> 50 mm	<b>Type:</b> LED <b>Colour/glass:</b> Red <b>Material:</b> Shockproof plastic <b>Shape:</b> Rectangular <b>Bracket:</b> Angled <b>Reflector:</b> w/ <b>Tail light:</b> w/ <b>No./LEDs:</b> 1 <b>E-approval:</b> Yes
<b>171720 LED Tail Lamp</b> Std pkg 1				
		<b>Voltage:</b> 12/24	<b>Dim.:</b> 130x32x20.5 mm <b>Dist. mount. holes:</b> 50 mm	<b>Type:</b> LED <b>Colour/glass:</b> Red <b>Material:</b> Shockproof plastic <b>Shape:</b> Rectangular <b>Reflector:</b> w/ <b>Tail light:</b> w/ <b>No./LEDs:</b> 1 <b>E-approval:</b> Yes
<b>171743 LED Tail Lamp</b> Std pkg 1				
		<b>Voltage:</b> 9-36	<b>Dim.:</b> 63x31 mm <b>Cable length:</b> 300 mm <b>Dist. mount. holes:</b> 30 mm	<b>Type:</b> LED <b>Colour:</b> Black <b>Colour/glass:</b> Red <b>Material:</b> PVC <b>Material/dome:</b> PMMA <b>Shape:</b> Round <b>Mount.:</b> 2 screws <b>Tail light:</b> w/ <b>No./LEDs:</b> 3 <b>Approvals:</b> ADR/SAE <b>E-approval:</b> Yes
<b>171771 LED Tail Lamp</b> Std pkg 1				
		<b>Voltage:</b> 24 <b>Watt:</b> 2.5	<b>Dim.:</b> 162x113x50 mm	<b>Type:</b> Tail lamp <b>Colour/glass:</b> Red <b>Material:</b> ABS plastic <b>Material/dome:</b> PMMA <b>Shape:</b> Rectangular <b>Mount.:</b> Plan installation <b>Tail light:</b> w/ <b>Stop light:</b> w/ <b>No./LEDs:</b> 16 <b>RH/LH:</b> RH/LH <b>E-approval:</b> Yes
<b>171840 LED Tail Lamp</b> Std pkg 1				
		<b>Voltage:</b> 12/24 <b>Watt:</b> 0.45-1.6	<b>Dim.:</b> 115x44x9.5 mm <b>Cable length:</b> 5000 mm <b>Dist. mount. holes:</b> 102 mm	<b>Type:</b> LED <b>Colour:</b> White <b>Colour/glass:</b> Red <b>Material:</b> Polycarbonate <b>Material/dome:</b> Polycarbonate <b>Shape:</b> Rectangular <b>Mount.:</b> 2 screws <b>Reflector:</b> w/ <b>Tail light:</b> w/ <b>No./LEDs:</b> 3 <b>Tightness norm:</b> IP 67 <b>Approvals:</b> SAE <b>E-approval:</b> Yes
<b>171843 LED Tail Lamp</b> Std pkg 1				
		<b>Voltage:</b> 12/24	<b>Dim.:</b> 57x35x21 mm <b>Cable length:</b> 400 mm <b>Dist. mount. holes:</b> 28 mm	<b>Type:</b> LED <b>Colour:</b> Black <b>Colour/glass:</b> Red <b>Shape:</b> Rectangular <b>Fixing screw:</b> 2 <b>Tail light:</b> w/ <b>No./LEDs:</b> 2 <b>Tightness norm:</b> IP 67 <b>E-approval:</b> Yes

		EL. SPECIFICATIONS	DIMENSIONS	ADDITIONAL SPECIFICATIONS
<b>171861 LED Tail Lamp</b> Std pkg 1		Voltage: 12/24 Watt: 0.3-0.6	Dim.: 72x26x24 mm Cable length: 5000 mm	Type: LED Colour: Black Colour/glass: Red Material: PP Material/dome: PMMA Shape: Rectangular Fixing screw: 2 Tail light: w/ No./LEDs: 3 Approvals: CE E-approval: Yes
<b>171867 LED Tail Lamp</b> Std pkg 1		Voltage: 12/24 Watt: 0.3-0.6	Dim.: 72x26x24 mm Cable length: 5000 mm	Type: LED Colour: Black Colour/glass: Red Material: PP Material/dome: PMMA Shape: Rectangular Bracket: Adjustable Fixing screw: 2 Tail light: w/ No./LEDs: 3 Approvals: CE E-approval: Yes
<b>172034 LED Tail Lamp</b> Std pkg 1		Voltage: 12/24	Dim.: 104x36x20 mm Cable length: 500 mm Dist. mount. holes: 70 mm	Type: LED Colour/glass: Red Material: Shockproof plastic Shape: Rectangular Reflector: w/ Fixing screw: 2 Tail light: w/ No./LEDs: 3 E-approval: Yes
<b>172035 LED Tail Lamp</b> Std pkg 1		Voltage: 12/24	Dim.: 104x36x20 mm Cable length: 500 mm Dist. mount. holes: 70 mm	Type: LED Colour/glass: Red Material: Shockproof plastic Shape: Rectangular Bracket: Angled Reflector: w/ Fixing screw: 2 Tail light: w/ No./LEDs: 3 E-approval: Yes
<b>172040 LED Tail Lamp</b> Std pkg 1		Voltage: 12/24	Dim.: 114x39x20 mm Cable length: 500 mm Dist. mount. holes: 70 mm	Type: LED Colour/glass: Red Material: Shockproof plastic Shape: Oval Reflector: w/ Fixing screw: 2 Tail light: w/ No./LEDs: 3 Approvals: ADR E-approval: Yes
<b>TAIL POSITION LAMPS CONVENTIONAL</b>				
<b>170552 Tail/Position Lamp</b> Std pkg 1		Bulb incl.: No Watt: 5	Dim.: 58.5x43x39 mm Dist. mount. holes: 25 mm	Socket type: S8.5 Colour/glass: Red/white Material: Shockproof plastic Shape: Rectangular Fixing screw: 2 Sidemarker: w/ Tail light: w/ RH/LH: RH/LH E-approval: Yes

170632 Tail/Position Lamp		Std pkg 1	
<p>Lens: HC-CARGO 170635, 170636.</p>			
<p>Bulb incl.: No Watt: 10</p>		<p>Dim.: 162x69.5 mm Dist. mount. holes: 76 mm</p>	
<p>Socket type: BA15S Colour/glass: Red/white Shape: Round Sidemarker: w/ Tail light: w/ E-approval: Yes</p>			
170633 Tail/Position Lamp		Std pkg 1	
<p>Lens: HC-CARGO 170635, 170636.</p>			
<p>Bulb incl.: No Watt: 10</p>		<p>Dim.: 154.2x69.5 mm Dist. mount. holes: 75 mm</p>	
<p>Socket type: BA15S Colour/glass: Red/white Shape: Round Sidemarker: w/ Tail light: w/ E-approval: Yes</p>			
170640 Tail/Position Lamp		Std pkg 1	
<p>Lens: HC-CARGO 170642, 170641. Bulb holder: HC-CARGO 170671.</p>			
<p>Bulb incl.: No Watt: 5</p>		<p>Dim.: 110x78x93 mm OD: 60 mm Dist. mount. holes: 75 mm</p>	
<p>Socket type: BA15S Colour/glass: Red/white Shape: Round Sidemarker: w/ Tail light: w/ E-approval: Yes</p>			
170668 Tail/Position Lamp		Std pkg 1	
<p>Lens: HC-CARGO 170642, 170641. Bulb holder: HC-CARGO 170671. Bulbs: HC-CARGO 170773.</p>			
<p>Bulb incl.: No Watt: 5</p>		<p>Dim.: 152.5x83 mm OD: 60 mm Dist. mount. holes: 74 mm</p>	
<p>Socket type: BA15S Colour/glass: Red/white Shape: Round Sidemarker: w/ Tail light: w/ E-approval: Yes</p>			
171196 Tail/Position Lamp		Std pkg 1	
<p>Bulb incl.: No Watt: 5</p>		<p>Dim.: 62x62x45 mm Dist. mount. holes: 30 mm</p>	
<p>Socket type: S8.5 Colour/glass: Red/white Material: Shockproof plastic Shape: Square Fixing screw: 2 Sidemarker: w/ Tail light: w/ RH/LH: RH/LH E-approval: Yes</p>			
171627 Tail/Position Lamp		Std pkg 1	
<p>Tail/Position Lamp: HC-CARGO 171706.</p>			
<p>Bulb incl.: No Voltage: 12/24 Watt: 5</p>		<p>Dim.: 143x40x35 mm Dist. mount. holes: 30 mm</p>	
<p>Socket type: S8.5 Material: Plastic Shape: Rectangular Sidemarker: w/ Tail light: w/ Approvals: ADR E-approval: Yes</p>			
171706 Tail/Position Lamp		Std pkg 1 Servicing: HC-CARGO 171627	
<p>Bulb incl.: No Voltage: 12/24 Watt: 5</p>		<p>Dim.: 74x40x37 mm Dist. mount. holes: 45 mm</p>	
<p>Socket type: S8.5 Shape: Rectangular Sidemarker: w/ Tail light: w/ Approvals: ADR E-approval: Yes</p>			

**SPARE PARTS**
**170635** Lens

Std pkg 1 Servicing: HC-CARGO 170632, 170633

 Colour/glass: White  
 Material: Glass  
 Shape: Round

**170636** Lens

Std pkg 1 Servicing: HC-CARGO 170632, 170633

 Colour/glass: Red  
 Material: Glass  
 Shape: Round

**170641** Lens

Std pkg 1 Servicing: HC-CARGO 170640, 170668

 Colour/glass: Red  
 Material: Glass  
 Shape: Round

**170642** Lens

Std pkg 1 Servicing: HC-CARGO 170640, 170668

 Colour/glass: White  
 Material: Glass  
 Shape: Round

**170671** Bulb Holder

Std pkg 1 Servicing: HC-CARGO 170640, 170668, 170713

**TAIL POSITION LAMPS LED**
**171528** LED Tail-Position Lamp

Std pkg 1

Flange 100x41 mm.

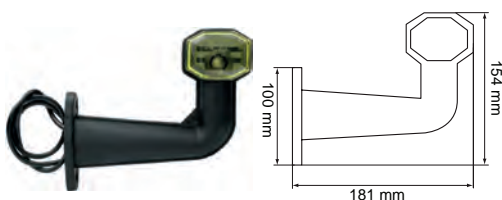

Voltage: 24

 Dim.: 181x154x48 mm  
 Cable length: 700 mm  
 Dist. mount. holes:  
 73 mm

 Type: LED  
 Colour/glass: Red/white  
 Material: Rubber  
 Material/dome: Shockproof plastic  
 Shape: Hexagon  
 Fixing screw: 2  
 Sidemarker: w/  
 Tail light: w/  
 No./LEDs: 2x1  
 RH/LH: RH/LH  
 E-approval: Yes

**171529** LED Tail-Position Lamp

Std pkg 1

Flange 100x41 mm.

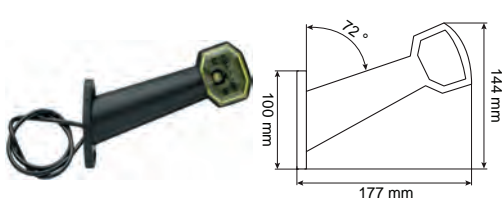









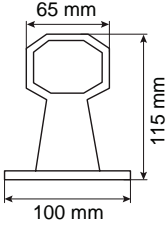

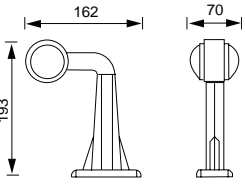

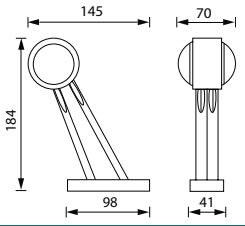
Voltage: 24

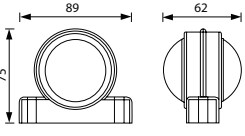
 Dim.: 177x144x48 mm  
 Cable length: 700 mm  
 Dist. mount. holes:  
 73 mm

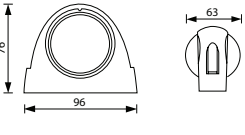
 Type: LED  
 Colour/glass: Red/white  
 Material: Rubber  
 Material/dome: Shockproof plastic  
 Shape: Hexagon  
 Fixing screw: 2  
 Sidemarker: w/  
 Tail light: w/  
 No./LEDs: 2x1  
 RH/LH: RH/LH  
 E-approval: Yes

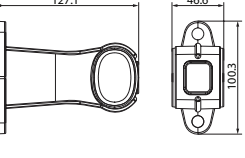

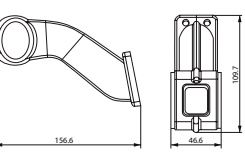
EL. SPECIFICATIONS		DIMENSIONS	ADDITIONAL SPECIFICATIONS
<b>171530 LED Tail-Position Lamp</b> Std pkg 1  		Voltage: 24 Dim.: 115x65x48 mm Cable length: 700 mm Dist. mount. holes: 73 mm	Type: LED Colour/glass: Red/white Material: Rubber Material/dome: Shockproof plastic Shape: Hexagon Fixing screw: 2 Sidemarker: w/ Tail light: w/ No./LEDs: 2x1 RH/LH: RH/LH E-approval: Yes
<b>171591 LED Tail-Position Lamp</b> Std pkg 1  		Voltage: 9-36 Dim.: 193x162x70 mm Dist. mount. holes: 78 mm	Type: LED Colour/glass: Red/white Shape: Round Sidemarker: w/ Tail light: w/ No./LEDs: 2x3 RH/LH: RH/LH Approvals: ADR/SAE E-approval: Yes
<b>171592 LED Tail-Position Lamp</b> Std pkg 1  		Voltage: 9-36 Dim.: 184x145x70 mm Dist. mount. holes: 78 mm	Type: LED Colour/glass: Red/white Shape: Round Sidemarker: w/ Tail light: w/ No./LEDs: 2x3 RH/LH: RH/LH Approvals: SAE E-approval: Yes
<b>171593 LED Tail-Position Lamp</b> Std pkg 1  		Voltage: 9-36 Dim.: 75x89x62 mm OD: 45 mm Dist. mount. holes: 78 mm	Type: LED Colour/glass: Red/white Material: Rubber Shape: Round Sidemarker: w/ Tail light: w/ No./LEDs: 2x3 RH/LH: RH/LH Approvals: ADR/SAE E-approval: Yes
<b>171617 LED Tail-Position Lamp</b> Std pkg 1  		Voltage: 9-36 Dim.: 96x76x63 mm OD: 76 mm Dist. mount. holes: 78 mm	Type: LED Colour/glass: Red/white Material: Synthetic rubber Shape: Round Sidemarker: w/ Tail light: w/ No./LEDs: 2x3 RH/LH: RH/LH Approvals: ADR/SAE E-approval: Yes
<b>171730 LED Tail/Position/Side Marker</b> Std pkg 1 <i>w/ 128 mm rubber arm. Cover of click-in connector HC-CARGO 172016.</i>  		Voltage: 12/24 Dim.: 127.1x100.3 mm Cable length: 500 mm Dist. mount. holes: 78 mm	Type: LED Shape: Oval Mount.: 2 screws Sidemarker: w/ Sidemarker lamp: w/ Tail light: w/ No./LEDs: 7 RH/LH: RH/LH Tightness norm: IP 67 E-approval: Yes
<b>171731 LED Tail/Position/Side Marker</b> Std pkg 1 <i>w/ 145 mm rubber arm. Cover of click-in connector HC-CARGO 172016.</i>  		Voltage: 12/24 Dim.: 142.2x130.5x40.5 mm Cable length: 450 mm Dist. mount. holes: 52 mm	Type: LED Colour: Black Material: Rubber Shape: Oval Mount.: 4 holes Sidemarker: w/ Sidemarker lamp: w/ Tail light: w/ No./LEDs: 9 RH/LH: RH E-approval: Yes

**171732 LED Tail/Position/Side Marker Std pkg 1**

Cover of click-in connector HC-CARGO 172016.

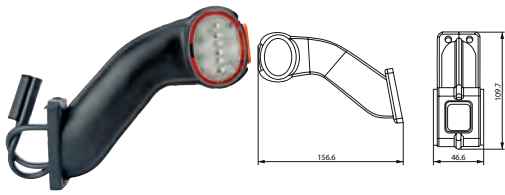

Voltage: 12/24

Dim.:  
142.2x130.5x40.5 mm  
Cable length: 450 mm  
Dist. mount. holes:  
52 mm

Type: LED  
Colour: Black  
Material: Rubber  
Shape: Oval  
Mount.: 4 holes  
Sidemarker: w/  
Sidemarker lamp: w/  
Tail light: w/  
No./LEDs: 9  
RH/LH: LH  
E-approval: Yes

**171733 LED Tail/Position/Side Marker Std pkg 1**

Cover of click-in connector HC-CARGO 172016.

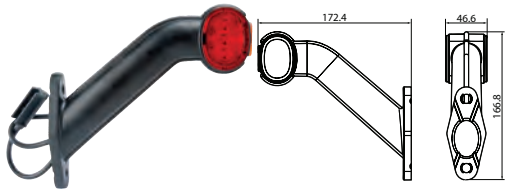

Voltage: 12/24

Dim.:  
172.4x166.8x46.6 mm  
Cable length: 500 mm  
Dist. mount. holes:  
78 mm

Type: LED  
Shape: Oval  
Mount.: 2 screws  
Sidemarker: w/  
Sidemarker lamp: w/  
Tail light: w/  
No./LEDs: 7  
RH/LH: RH

**171734 LED Tail/Position/Side Marker Std pkg 1**

Cover of click-in connector HC-CARGO 172016.



Voltage: 12/24

Dim.:  
172.4x166.8x46.6 mm  
Cable length: 500 mm  
Dist. mount. holes:  
78 mm

Type: LED  
Shape: Oval  
Mount.: 2 screws  
Sidemarker: w/  
Sidemarker lamp: w/  
Tail light: w/  
No./LEDs: 7  
RH/LH: LH

**171958 LED Tail-Position Lamp Std pkg 1**



Voltage: 12-24

Dim.:  
148.5x125.5x89 mm  
Cable length: 300 mm  
Dist. mount. holes:  
63.5/75/29 mm

Type: LED  
Colour: Black  
Colour/glass: Red/white  
Material: Rubber  
Material/dome: Shockproof plastic  
Shape: Round  
Mount.: 6 screws  
Sidemarker: w/  
Tail light: w/  
RH/LH: RH  
Tightness norm: IP 68  
E-approval: Yes

**171959 LED Tail-Position Lamp Std pkg 1**

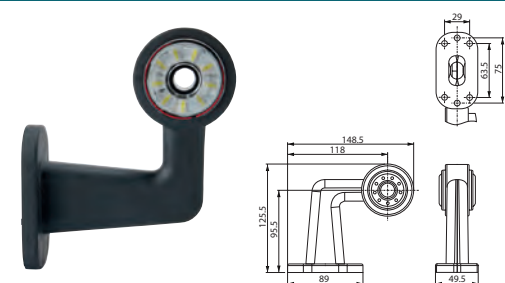

Voltage: 12-24

Dim.:  
148.5x125.5x89 mm  
Cable length: 300 mm  
Dist. mount. holes:  
63.5/75/29 mm

Type: LED  
Colour: Black  
Colour/glass: Red/white  
Material: Rubber  
Material/dome: Shockproof plastic  
Shape: Round  
Mount.: 6 screws  
Sidemarker: w/  
Tail light: w/  
RH/LH: LH  
Tightness norm: IP 68  
E-approval: Yes

**171960 LED Tail-Position Lamp Std pkg 1**

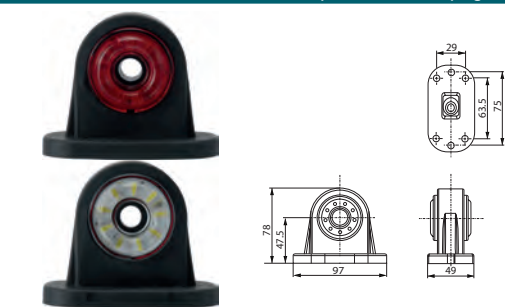

Voltage: 12-24

Dim.: 97x78x49 mm  
Cable length: 300 mm  
Dist. mount. holes:  
75/63.5/29 mm

Type: LED  
Colour: Black  
Colour/glass: Red/white  
Material: Rubber  
Material/dome: Shockproof plastic  
Shape: Round  
Mount.: 6 screws  
Sidemarker: w/  
Tail light: w/  
RH/LH: RH/LH  
Tightness norm: IP 68  
E-approval: Yes

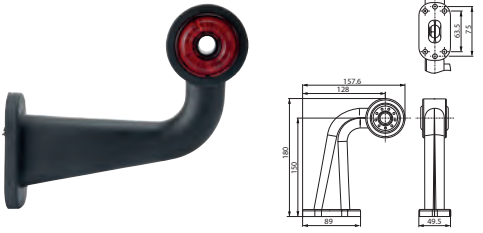
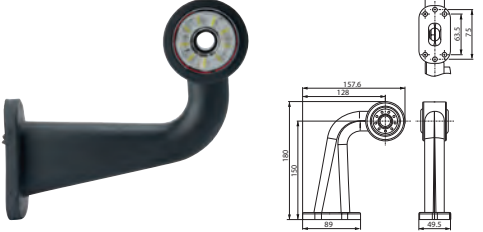
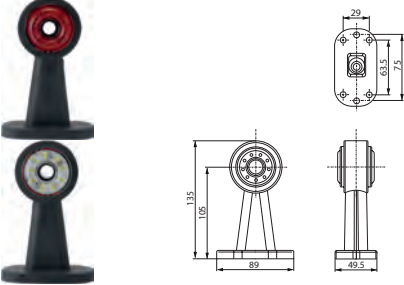
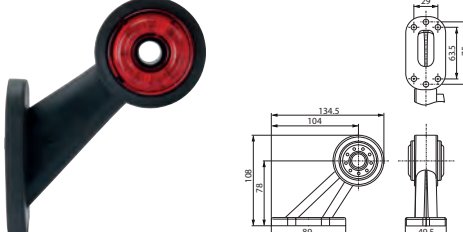
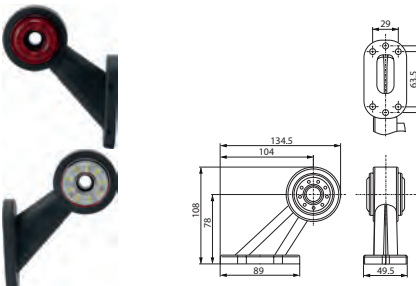
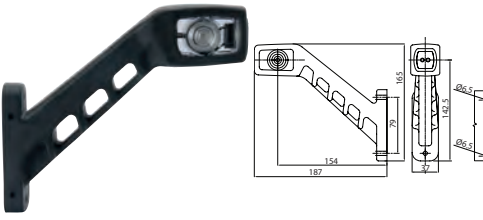
EL. SPECIFICATIONS		DIMENSIONS	ADDITIONAL SPECIFICATIONS
<b>171961 LED Tail-Position Lamp</b> Std pkg 1 		<b>Voltage:</b> 12-24 <b>Dim.:</b> 180x157.6x89 mm <b>Cable length:</b> 300 mm <b>Dist. mount. holes:</b> 75/63.5/29 mm	<b>Type:</b> LED <b>Colour:</b> Black <b>Colour/glass:</b> Red/white <b>Material:</b> Rubber <b>Material/dome:</b> Shockproof plastic <b>Shape:</b> Round <b>Mount.:</b> 6 screws <b>Sidemarkers:</b> w/ <b>Tail light:</b> w/ <b>RH/LH:</b> RH <b>Tightness norm:</b> IP 68 <b>E-approval:</b> Yes
<b>171962 LED Tail-Position Lamp</b> Std pkg 1 		<b>Voltage:</b> 12-24 <b>Dim.:</b> 180x157.6x89 mm <b>Cable length:</b> 300 mm <b>Dist. mount. holes:</b> 75/63.5/29 mm	<b>Type:</b> LED <b>Colour:</b> Black <b>Colour/glass:</b> Red/white <b>Material:</b> Rubber <b>Material/dome:</b> Shockproof plastic <b>Shape:</b> Round <b>Mount.:</b> 6 screws <b>Sidemarkers:</b> w/ <b>Tail light:</b> w/ <b>RH/LH:</b> LH <b>Tightness norm:</b> IP 68 <b>E-approval:</b> Yes
<b>171963 LED Tail-Position Lamp</b> Std pkg 1 		<b>Voltage:</b> 12-24 <b>Dim.:</b> 135x89x49.5 mm <b>Cable length:</b> 300 mm <b>Dist. mount. holes:</b> 75/63.5/29 mm	<b>Type:</b> LED <b>Colour:</b> Black <b>Colour/glass:</b> Red/white <b>Material:</b> Rubber <b>Material/dome:</b> Shockproof plastic <b>Shape:</b> Round <b>Mount.:</b> 6 screws <b>Sidemarkers:</b> w/ <b>Tail light:</b> w/ <b>RH/LH:</b> RH/LH <b>Tightness norm:</b> IP 68 <b>E-approval:</b> Yes
<b>171964 LED Tail-Position Lamp</b> Std pkg 1 		<b>Voltage:</b> 12-24 <b>Dim.:</b> 134.5x108x89 mm <b>Cable length:</b> 300 mm <b>Dist. mount. holes:</b> 75/63.5/29 mm	<b>Type:</b> LED <b>Colour:</b> Black <b>Colour/glass:</b> Red/white <b>Material:</b> Rubber <b>Material/dome:</b> Shockproof plastic <b>Shape:</b> Round <b>Mount.:</b> 6 screws <b>Sidemarkers:</b> w/ <b>Tail light:</b> w/ <b>RH/LH:</b> RH <b>Tightness norm:</b> IP 68 <b>E-approval:</b> Yes
<b>171965 LED Tail-Position Lamp</b> Std pkg 1 		<b>Voltage:</b> 12-24 <b>Dim.:</b> 134.5x108x89 mm <b>Cable length:</b> 300 mm <b>Dist. mount. holes:</b> 75/63.5/29 mm	<b>Type:</b> LED <b>Colour:</b> Black <b>Colour/glass:</b> Red/white <b>Material:</b> Rubber <b>Material/dome:</b> Shockproof plastic <b>Shape:</b> Round <b>Mount.:</b> 6 screws <b>Sidemarkers:</b> w/ <b>Tail light:</b> w/ <b>RH/LH:</b> LH <b>Tightness norm:</b> IP 68 <b>E-approval:</b> Yes
<b>171966 LED Tail/Position/Side Marker</b> Std pkg 1 		<b>Voltage:</b> 12-24 <b>Dim.:</b> 187x165x37 mm <b>Cable length:</b> 300 mm <b>Dist. mount. holes:</b> 79 mm	<b>Type:</b> LED <b>Colour:</b> Black <b>Colour/glass:</b> Transparent <b>Material:</b> Rubber <b>Material/dome:</b> Shockproof plastic <b>Shape:</b> Rectangular <b>Mount.:</b> 2 screws <b>Sidemarkers:</b> w/ <b>Sidemarkers lamp:</b> w/ <b>Tail light:</b> w/ <b>RH/LH:</b> RH <b>Tightness norm:</b> IP 68 <b>E-approval:</b> Yes

**171967** LED Tail/Position/Side Marker Std pkg 1

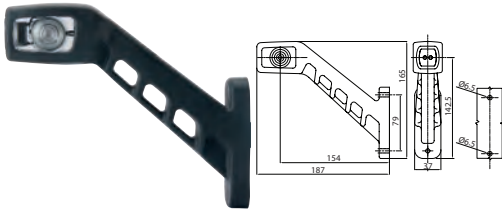

Voltage: 12-24

Dim.: 187x165x37 mm  
Cable length: 300 mm  
Dist. mount. holes:  
79 mm

Type: LED  
Colour: Black  
Colour/glass: Transparent  
Material: Rubber  
Material/dome: Shockproof plastic  
Shape: Rectangular  
Mount.: 2 screws  
Sidemarker: w/  
Sidemarker lamp: w/  
Tail light: w/  
RH/LH: LH  
Tightness norm: IP 68  
E-approval: Yes

**171968** LED Tail/Position/Side Marker Std pkg 1

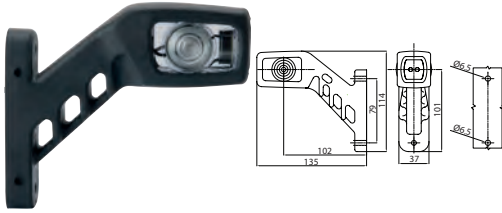

Voltage: 12-24

Dim.: 135x114x37 mm  
Cable length: 300 mm  
Dist. mount. holes:  
79 mm

Type: LED  
Colour: Black  
Colour/glass: Transparent  
Material: Rubber  
Material/dome: Shockproof plastic  
Shape: Rectangular  
Mount.: 2 screws  
Sidemarker: w/  
Sidemarker lamp: w/  
Tail light: w/  
RH/LH: RH  
Tightness norm: IP 68  
E-approval: Yes

**171969** LED Tail/Position/Side Marker Std pkg 1

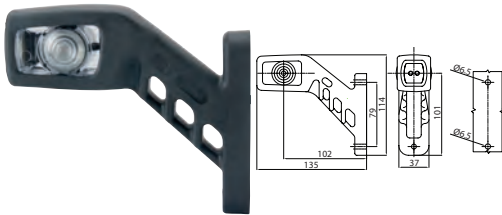

Voltage: 12-24

Dim.: 135x114x37 mm  
Cable length: 300 mm  
Dist. mount. holes:  
79 mm

Type: LED  
Colour: Black  
Colour/glass: Transparent  
Material: Rubber  
Material/dome: Shockproof plastic  
Shape: Rectangular  
Mount.: 2 screws  
Sidemarker: w/  
Sidemarker lamp: w/  
Tail light: w/  
RH/LH: LH  
Tightness norm: IP 68  
E-approval: Yes

**171970** LED Tail/Position/Side Marker Std pkg 1

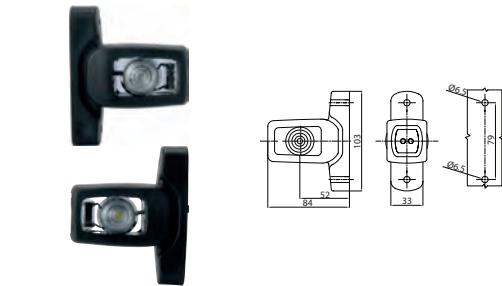

Voltage: 12-24

Dim.: 103x84x33 mm  
Cable length: 300 mm  
Dist. mount. holes:  
79 mm

Type: LED  
Colour: Black  
Colour/glass: Transparent  
Material: Rubber  
Material/dome: Shockproof plastic  
Shape: Rectangular  
Mount.: 2 screws  
Sidemarker: w/  
Sidemarker lamp: w/  
Tail light: w/  
RH/LH: RH/LH  
Tightness norm: IP 68  
E-approval: Yes

**NUMBERPLATE LAMPS CONVENTIONAL**

**170002** Numberplate Lamp Std pkg 1

Servicing: Universal - Visit [www.hc-cargo.com](http://www.hc-cargo.com) for further information.

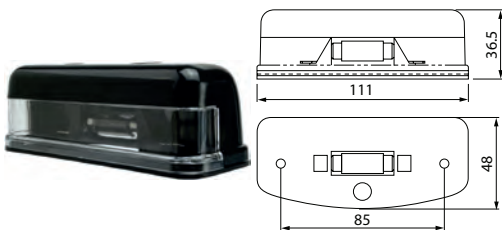

Bulb incl.: Yes  
Voltage: 12/24  
Watt: 5

Dim.: 111x36.5x48 mm

Socket type: S8.5  
Colour: Black  
Shape: Rectangular  
Approvals: CE



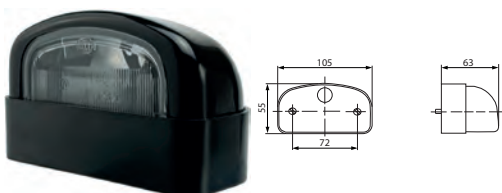





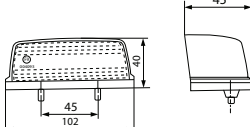

**170936** Numberplate Lamp Std pkg 1

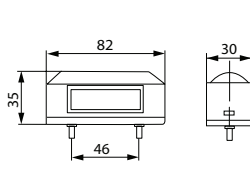

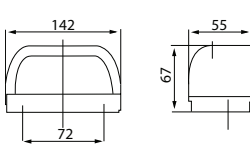

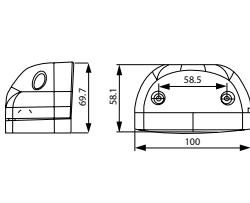

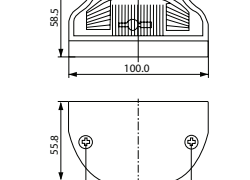

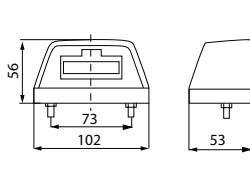

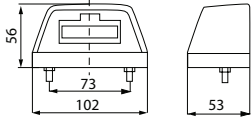

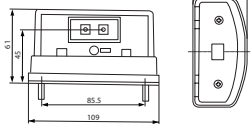

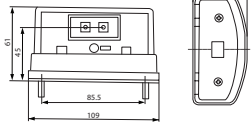

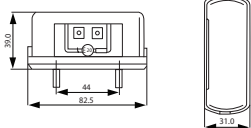

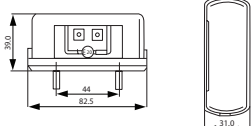

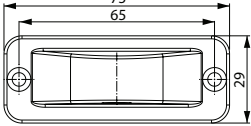

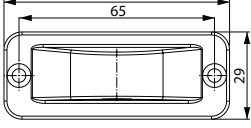

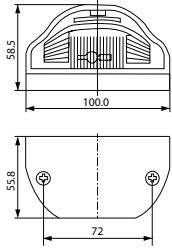

Bulb incl.: No  
Voltage: 12  
Watt: 5

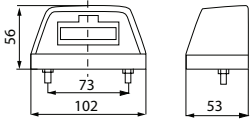
Dim.: 105x55x63 mm  
Dist. mount. holes:  
72 mm

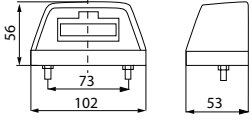
Type: Illumination of numberplate  
Socket type: S8.5  
Colour: Black  
Material: Shockproof plastic  
Shape: Rectangular  
Fixing screw: 2  
Numberplate light: w/  
E-approval: Yes

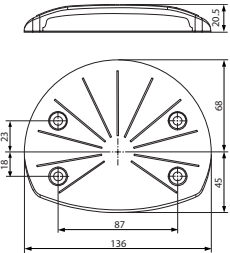
		EL. SPECIFICATIONS	DIMENSIONS	ADDITIONAL SPECIFICATIONS
<b>171045</b> Numberplate Lamp		Std pkg 1		
		Bulb incl.: No Voltage: 12/24 Watt: 5	Dim.: 102x40x45 mm Dist. mount. holes: 45 mm	Type: Illumination of numberplate Socket type: S8.5 Colour: Black Material: Shockproof plastic Shape: Rectangular Fixing screw: 2 E-approval: Yes
<b>171164</b> Numberplate Lamp		Std pkg 1	Servicing: Ford, Universal - Visit <a href="http://www.hc-cargo.com">www.hc-cargo.com</a> for further information.	
		Bulb incl.: No Voltage: 12 Watt: 5		Type: Illumination of numberplate Socket type: T10 Shape: Rectangular E-approval: Yes
<b>171166</b> Numberplate Lamp		Std pkg 1		
<i>Universal.</i>				
		Bulb incl.: No Voltage: 12/24 Watt: 5	Dim.: 82x35x30 mm Dist. mount. holes: 46 mm	Type: Illumination of numberplate Socket type: S8.5 Shape: Rectangular Colour: Black Fixing screw: 2 Numberplate light: w/ E-approval: Yes Alternativ no. 171224
<b>171225</b> Numberplate Lamp		Std pkg 1		
		Bulb incl.: No Voltage: 12/24 Watt: 10	Dim.: 142x67x55 mm Dist. mount. holes: 72 mm	Type: Illumination of numberplate Socket type: BA15S Material: Shockproof plastic Shape: Rectangular Fixing screw: 2 E-approval: Yes
<b>171345</b> Numberplate Lamp		Std pkg 1		
		Bulb incl.: No Watt: 5	Dim.: 100x58.1x69.7 mm Dist. mount. holes: 58.5 mm	Type: Illumination of numberplate Socket type: S8.5 Shape: Rectangular Colour: Black Material: Plastic Fixing screw: 2 E-approval: Yes
<b>171823</b> Numberplate Lamp		Std pkg 1		
		Bulb incl.: No Watt: 5	Dim.: 100x58.5x55.8 mm Dist. mount. holes: 72 mm	Type: Illumination of numberplate Socket type: S8.5 Shape: Rectangular Colour: Black Colour/glass: Red Material: Plastic Fixing screw: 2 Numberplate light: w/ E-approval: Yes
<b>NUMBERPLATE LAMPS LED</b>				
<b>171622</b> LED Numberplate Lamp		Std pkg 1		
		Voltage: 24	Dim.: 102x56x53 mm Dist. mount. holes: 72 mm	Type: LED Shape: Rectangular Colour: Black Colour/glass: Transparent Numberplate light: w/ No./LEDs: 4 E-approval: Yes

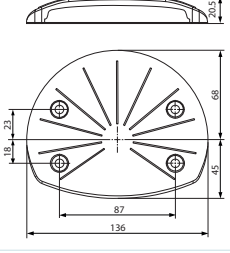
		EL. SPECIFICATIONS	DIMENSIONS	ADDITIONAL SPECIFICATIONS
<b>171624</b>	LED Numberplate Lamp	Std pkg 1		
		Voltage: 24	Dim.: 102x56x53 mm Dist. mount. holes: 73 mm	Type: LED Shape: Rectangular Colour: Black Colour/glass: Red Shape: Rectangular Numberplate light: w/ LEDs: w/ E-approval: Yes
<b>171709</b>	LED Numberplate Lamp	Std pkg 1		
		Voltage: 12/24	Dim.: 109x61x55.5 mm Dist. mount. holes: 85.5 mm	Type: LED Socket type: LED Shape: Rectangular Colour: Red Material: Shockproof plastic Fixing screw: 2 Numberplate light: w/ E-approval: Yes
<b>171714</b>	LED Numberplate Lamp	Std pkg 1		
		Voltage: 12/24	Dim.: 109x61x55.5 mm Dist. mount. holes: 85.5 mm	Type: LED Socket type: LED Shape: Rectangular Colour: Black Material: Shockproof plastic Numberplate light: w/
<b>171715</b>	LED Numberplate Lamp	Std pkg 1		
		Voltage: 12/24	Dim.: 82.5x39x31 mm Dist. mount. holes: 44 mm	Type: LED Socket type: LED Shape: Rectangular Colour/glass: Red Material: Shockproof plastic Fixing screw: 2 Numberplate light: w/ Tightness norm: IP 68 E-approval: Yes
<b>171716</b>	LED Numberplate Lamp	Std pkg 1		
		Voltage: 12/24	Dim.: 82.5x39x31 mm Dist. mount. holes: 44 mm	Type: LED Socket type: LED Shape: Rectangular Colour: Black Fixing screw: 2 Numberplate light: w/ E-approval: Yes
<b>171737</b>	LED Numberplate Lamp	Std pkg 1		
		Voltage: 12	Dim.: 75x29x34 mm Cable length: 300 mm Dist. mount. holes: 65 mm	Type: LED Shape: Rectangular Mount.: 2 screws Numberplate light: w/ No./LEDs: 3 E-approval: Yes
<b>171738</b>	LED Numberplate Lamp	Std pkg 1		
		Voltage: 24	Dim.: 75x29x34 mm Cable length: 300 mm Dist. mount. holes: 65 mm	Type: LED Shape: Rectangular Mount.: 2 screws Numberplate light: w/ No./LEDs: 3

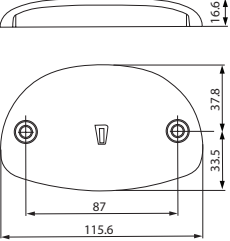
		EL. SPECIFICATIONS	DIMENSIONS	ADDITIONAL SPECIFICATIONS
<b>171824 LED Numberplate Lamp</b> Std pkg 1				
		Voltage: 12/24 Watt: 0.5-1.1	Dim.: 100x58.5x55.8 mm Cable length: 1000 mm Dist. mount. holes: 72 mm	Type: LED Shape: Rectangular Colour: Black Colour/glass: White Material: Plastic Fixing screw: 2 Numberplate light: w/ No./LEDs: 2 E-approval: Yes
<b>172002 LED Numberplate Lamp</b> Std pkg 1				
		Voltage: 12	Dim.: 102x56x53 mm Dist. mount. holes: 73 mm	Type: LED Colour: Black Colour/glass: Transparent Material: Plastic Shape: Rectangular Numberplate light: w/ No./LEDs: 4 E-approval: Yes
<b>172009 LED Numberplate Lamp</b> Std pkg 1				
		Voltage: 12	Dim.: 102x56x53 mm Dist. mount. holes: 73 mm	Type: LED Colour: Black Colour/glass: Red Shape: Rectangular Numberplate light: w/ LEDs: w/ E-approval: Yes
<b>TAIL-LIFT LAMPS CONVENTIONAL</b>				
<b>170746 Tail Lift Lamp Set</b> Std pkg 1				
<i>Set of cables, connectors and mounting screws. Incl. 12/24 V relay.</i>				
		Bulb incl.: Yes Voltage: 24	Dim.: 136x113x20.5 mm Dist. mount. holes: 87 mm	Material: Cast aluminum Approvals: GGVS/ADR
<b>170748 Tail Lift Lamp</b> Std pkg 1				
		Bulb incl.: Yes Voltage: 24	Dim.: 136x113x20.5 mm Dist. mount. holes: 87 mm	Material: Cast aluminum Approvals: GGVS/ADR E-approval: Yes
<b>TAIL-LIFT LAMPS LED</b>				
<b>171621 LED Tail Lift Lamp</b> Std pkg 1				
<i>Dust and waterproof.</i>				
		Voltage: 24	Dim.: 115x71.3x16.6 mm Dist. mount. holes: 87 mm	Type: LED Colour: Orange Material: Alu/zinc No./LEDs: 12 Approvals: GGVS/ADR

## TRAILER LIGHTING SETS

### 170809 Trailer Lighting Set Std pkg 1

Light construction. 7-pole plug. Multi Function Lamp: HC-CARGO 170939.

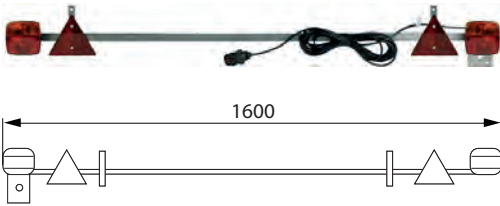

Bulb incl.: Yes  
Voltage: 12

Dim.: 1600 mm  
Cable length: 7500 mm

Material: Galvanized steel  
No./lamps: 2  
No./reflectors: 2  
Flasher light: w/  
Numberplate holder: w/  
Stop light: w/

### 170828 Front/rear lighting set Std pkg 1

7-pole plug. Tail-stop-flash lamp: HC-CARGO 170939. Flash-position lamp: HC-CARGO 170941. Magnet w/ metal bracket: HC-CARGO 170942.



Bulb incl.: Yes  
Voltage: 12

Dim.: 107x100 mm  
Cable length: 4500/7500 mm

Shape: Square  
Mount.: Magnetic  
No./lamps: 2  
Flasher light: w/  
Sidemarker: w/  
Tail light: w/  
Stop light: w/

### 170829 Number Plate Holder Std pkg 1

7-pole plug. Multi Function Lamp: HC-CARGO 170939, 170940.

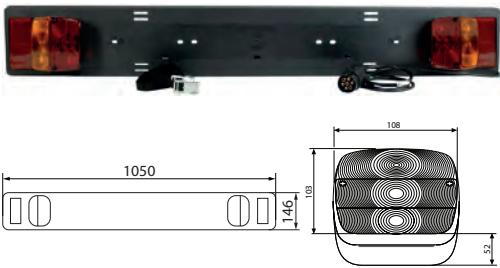

Bulb incl.: Yes  
Voltage: 12

Dim.: 1050x146 mm  
Cable length: 1500 mm

Reflector: w/  
Numberplate holder: w/  
Straps incl.: Yes

### 170835 Trailer Lighting Set Std pkg 1

Light construction. 7-pole plug. Multi Function Lamp: HC-CARGO 170939.

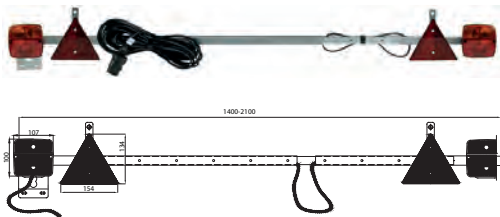

Bulb incl.: Yes  
Voltage: 12

Dim.: 1400-2100 mm  
Cable length: 12000 mm

Material: Galvanized steel  
No./lamps: 2  
No./reflectors: 2  
Flasher light: w/  
Numberplate holder: w/  
Tail light: w/  
Stop light: w/  
Width/adjustable: w/

### 171049 Trailer Lighting Set Std pkg 1

Extensible light construction. 7-pole plug. Multi Function Lamp: HC-CARGO 170939.

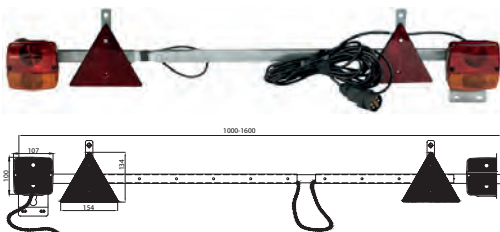

Bulb incl.: Yes  
Voltage: 12

Dim.: 1000-1600 mm  
Cable length: 7500 mm

Material: Galvanized steel  
No./lamps: 2  
No./reflectors: 2  
Flasher light: w/  
Numberplate holder: w/  
Tail light: w/  
Stop light: w/  
Width/adjustable: w/

### 171818 Trailer lighting set Std pkg 1

Lens: HC-CARGO 171833, 171834. Lamp: HC-CARGO 171870, 171871. Multi Connector: HC-CARGO 171372, 171373.

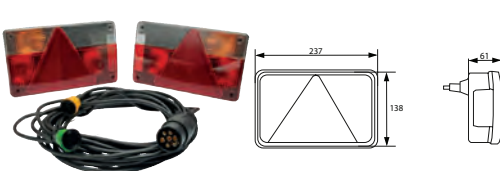









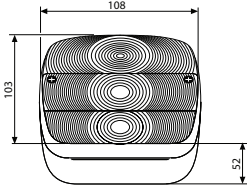

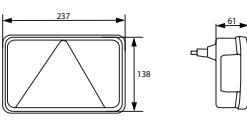
Bulb incl.: Yes  
Voltage: 12

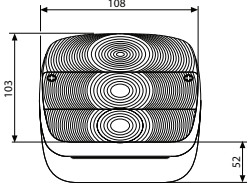
Dim.: 237x138x61 mm  
Cable length: 2x5000 mm

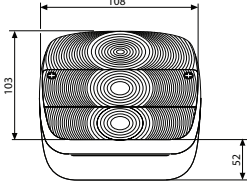
Shape: Rectangular  
No./lamps: 2  
Flasher light: w/  
Numberplate light: w/  
Rear/fog lamp: w/  
Tail light: w/  
Stop light: w/  
E-approval: Yes

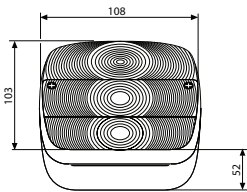

EL. SPECIFICATIONS		DIMENSIONS	ADDITIONAL SPECIFICATIONS
<b>171821 Trailer lighting set</b> Std pkg 1 Multi connector: HC-CARGO 171372, 171373. Lens: HC-CARGO 170833. Light: HC-CARGO 171822.			
 	Bulb incl.: Yes Voltage: 12	Dim.: 108x103x52 mm Cable length: 2x5000 mm	Shape: Square Flasher light: w/ Numberplate light: w/ Tail light: w/ Stop light: w/ E-approval: Yes
<b>171872 Trailer lighting set</b> Std pkg 1 Lens: HC-CARGO 171833, 171834. Lamp: HC-CARGO 171870, 171871.			
 	Bulb incl.: Yes Voltage: 12	Dim.: 237x138x61 mm Cable length: 2x7500 mm	Shape: Rectangular No./lamps: 2 Flasher light: w/ Numberplate light: w/ Rear/fog lamp: w/ Tail light: w/ Stop light: w/ E-approval: Yes
<b>171873 Trailer lighting set</b> Std pkg 1 Multi connector: HC-CARGO 171372, 171373. Lens: HC-CARGO 170833.			
 	Bulb incl.: Yes Voltage: 12	Dim.: 108x103x52 mm Cable length: 2x7500 mm	Shape: Square Flasher light: w/ Numberplate light: w/ Tail light: w/ Stop light: w/ E-approval: Yes
<b>171935 Trailer Lighting Set</b> Std pkg 1 7-pole plug. Magnet w/ metalbracket: HC-CARGO 170942. Multi Function Lamp: HC-CARGO 170939.			
 	Bulb incl.: Yes Voltage: 12	Dim.: 108x103x52 mm Cable length: 4000/13000 mm	Mount.: Magnetic No./lamps: 2 Flasher light: w/ Tail light: w/ Stop light: w/
<b>SPARE PARTS</b>			
<b>170833 Lens, Rear Lamp</b> Std pkg 1 Servicing: HC-CARGO 170939, 170940, 171821, 171822, 171873			
		Dim.: 108x103x52 mm	Material: Shockproof plastic Flasher light: w/ Tail light: w/ Stop light: w/ RH/LH: RH/LH
<b>170834 Lens, Rear Lamp</b> Std pkg 1 Servicing: HC-CARGO 170941			
		Dim.: 108x103x52 mm	Fixing screw: 2 Flasher light: w/ Sidemarker: w/
<b>170939 Multi Function Lamp</b> Std pkg 1 Servicing: HC-CARGO 170809, 170828, 170829, 170835, 171049, 171935 Lens: HC-CARGO 170833.			
 	Bulb incl.: No Watt: 21 Watt 2: 21/5	Dim.: 108x103x52 mm Dist. mount. holes: 45/55 mm	Socket type: BA15S Socket type 2: BAY15d Material: Shockproof plastic Fixing screw: 2 Flasher light: w/ Tail light: w/ Stop light: w/ RH/LH: RH/LH E-approval: Yes

**170940 Multi Function Lamp** Std pkg 1 Servicing: HC-CARGO 170829

Lens: HC-CARGO 170833.

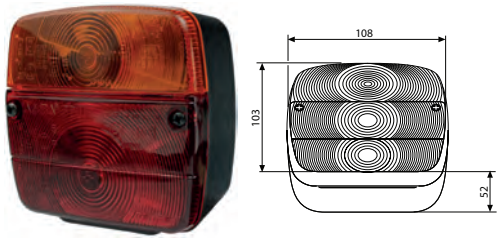

Bulb incl.: No  
Watt: 21  
Watt 2: 21/5

Dim.: 108x103x52 mm  
Dist. mount. holes:  
45/55 mm

Socket type: BA15S  
Socket type 2: BAY15d  
Material: Shockproof plastic  
Fixing screw: 2  
Flasher light: w/  
Numberplate light: w/  
Tail light: w/  
Stop light: w/  
RH/LH: RH/LH  
E-approval: Yes

**170941 Flasher/Position Lamp** Std pkg 1 Servicing: HC-CARGO 170828

Lens: HC-CARGO 170834.

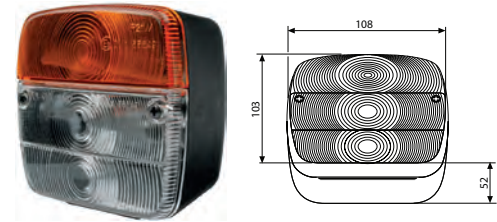

Bulb incl.: No  
Watt: 21  
Watt 2: 5

Dim.: 108x103x52 mm  
Dist. mount. holes:  
55 mm

Socket type: BA15S  
Socket type 2: S8.5  
Material: Shockproof plastic  
Fixing screw: 2  
Flasher light: w/  
Sidemarker: w/  
RH/LH: RH/LH  
E-approval: Yes

**170942 Magnet** Std pkg 2 Servicing: HC-CARGO 170828, 171935

For camera. Rubber Protection: HC-CARGO 171795.



OD: 76 mm

**171795 Rubber Protection** Std pkg 1 Servicing: HC-CARGO 170942

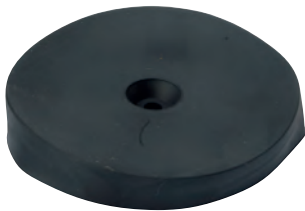

ID: 76 mm

Rubber: w/

**171822 Multi Function Lamp** Std pkg 1 Servicing: HC-CARGO 171821

Multi connector: HC-CARGO 171372, 171373. Lens: HC-CARGO 170833.

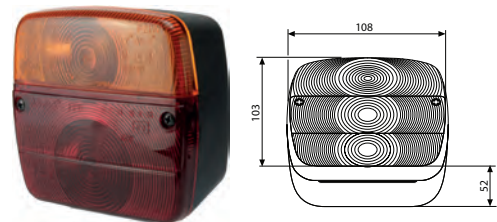

Bulb incl.: Yes  
Watt: 21  
Watt 2: 21/5

Dim.: 108x103x52 mm  
Dist. mount. holes:  
45/55 mm

Socket type: BA15S  
Socket type 2: BAY15d  
Flasher light: w/  
Sidemarker: w/  
Stop light: w/  
E-approval: Yes

**171833 Lens, Rear Lamp** Std pkg 1 Servicing: HC-CARGO 171818, 171871, 171872



Dim.: 237x138x19 mm

Material: Shockproof plastic  
Flasher light: w/  
Numberplate light: w/  
Rear/fog lamp: w/  
Sidemarker: w/  
Stop light: w/  
RH/LH: RH  
E-approval: Yes

**171834 Lens, Rear Lamp** Std pkg 1 Servicing: HC-CARGO 171818, 171870, 171872

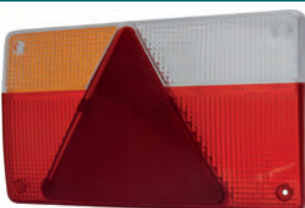

Dim.: 237x138x19 mm

Material: Shockproof plastic  
Flasher light: w/  
Numberplate light: w/  
Rear/fog lamp: w/  
Sidemarker: w/  
Stop light: w/  
RH/LH: LH  
E-approval: Yes

<b>171870 Multi Function Lamp</b> Std pkg 1 Servicing: HC-CARGO 171818, 171872 <i>Lens: HC-CARGO 171834. Multi connector: HC-CARGO 171537, 171538. Right: HC-CARGO 171871.</i>			
	<b>Bulb incl.:</b> Yes <b>Voltage:</b> 12	<b>Dim.:</b> 237x138x61 mm	<b>Flasher light:</b> w/ <b>Numberplate light:</b> w/ <b>Rear/fog lamp:</b> w/ <b>Sidemarkers:</b> w/ <b>Stop light:</b> w/ <b>RH/LH:</b> LH <b>E-approval:</b> Yes

<b>171871 Multi Function Lamp</b> Std pkg 1 Servicing: HC-CARGO 171818, 171872 <i>Lens: HC-CARGO 171833. Multi connector: HC-CARGO 171537, 171538. Left: HC-CARGO 171870.</i>			
	<b>Bulb incl.:</b> Yes <b>Voltage:</b> 12	<b>Dim.:</b> 237x138x61 mm	<b>Flasher light:</b> w/ <b>Numberplate light:</b> w/ <b>Rear/fog lamp:</b> w/ <b>Sidemarkers:</b> w/ <b>Stop light:</b> w/ <b>RH/LH:</b> RH <b>E-approval:</b> Yes

## INTERIOR LAMPS CONVENTIONAL

<b>171356 Interior Lamp</b> Std pkg 1			
	<b>Bulb incl.:</b> No <b>Watt:</b> 25	<b>Dim.:</b> 184.5x38.5 mm <b>Dist. mount. holes:</b> 138 mm	<b>Socket type:</b> BA15S <b>Material:</b> Plastic <b>Shape:</b> Circular

<b>171428 Interior Lamp</b> Std pkg 1 <i>For build-in. Depth: 35 mm.</i>			
	<b>Bulb incl.:</b> No <b>Watt:</b> 25	<b>Dim.:</b> 218.5x39.7 mm <b>Dist. mount. holes:</b> 180 mm	<b>Socket type:</b> BA15S <b>Material:</b> Plastic <b>Shape:</b> Circular

## INTERIOR LAMPS LED

<b>171676 LED Interior Lamp</b> Std pkg 1			
	<b>Voltage:</b> 12/24 <b>Watt:</b> 0.7	<b>Dim.:</b> 125x78.6x28.4 mm <b>Cable length:</b> 120 mm <b>Dist. mount. holes:</b> 100 mm	<b>Type:</b> LED <b>Colour:</b> White <b>Colour/glass:</b> Frosted <b>Material:</b> Shockproof plastic <b>Material/dome:</b> PMMA <b>Shape:</b> Oval <b>Switch:</b> w/ <b>No./LEDs:</b> 6 <b>Approvals:</b> CE/UL

<b>171677 LED Interior Lamp</b> Std pkg 1			
	<b>Voltage:</b> 12/24 <b>Watt:</b> 1.5	<b>Dim.:</b> 139.5x35 mm <b>Cable length:</b> 210 mm <b>Dist. mount. holes:</b> 75 mm	<b>Type:</b> LED <b>Colour:</b> Black <b>Colour/glass:</b> Frosted <b>Material:</b> Shockproof plastic <b>Material/dome:</b> PMMA <b>Shape:</b> Round <b>Mount.:</b> Plan installation <b>Switch:</b> w/ <b>No./LEDs:</b> 20 <b>Approvals:</b> CE

**171679 LED Interior Lamp** Std pkg 1

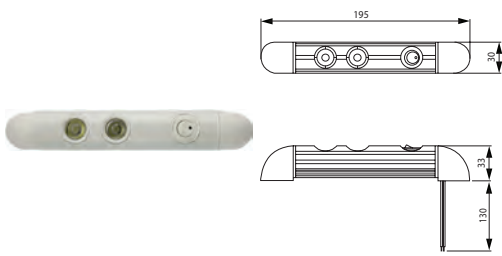
*180° adjustable.*

**Voltage:** 9-30  
**Watt:** 3

**Dim.:** 195x30x33 mm  
**Cable length:** 130 mm  
**Dist. mount. holes:** 164 mm

**Type:** LED  
**Colour:** White  
**Colour/glass:** Transparent  
**Material:** Alu/plastic  
**Material/dome:** PMMA  
**Shape:** Oblong  
**Switch:** w/  
**No./LEDs:** 2  
**Approvals:** CE

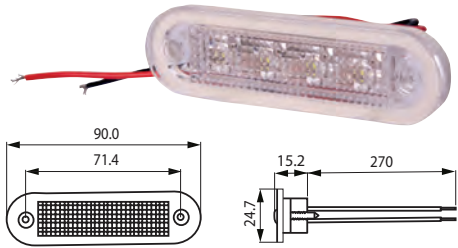
**171695 LED Interior Lamp** Std pkg 1

*For flush mounting.*

**Voltage:** 12/24

**Dim.:** 90x24.7 mm  
**Cable length:** 270 mm  
**Dist. mount. holes:** 71.4 mm

**Type:** LED  
**Colour:** White  
**Colour/glass:** Frosted  
**Material:** Shockproof plastic  
**Material/dome:** PMMA  
**Shape:** Oval  
**Mount.:** Plan installation  
**No./LEDs:** 4  
**Tightness norm:** IP 66  
**Approvals:** CE

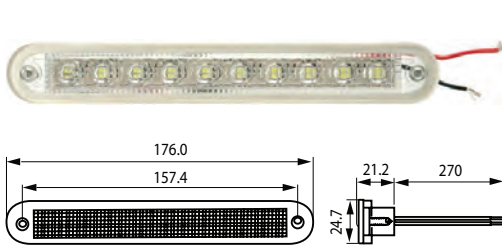
**171696 LED Interior Lamp** Std pkg 1

*For flush mounting.*

**Voltage:** 12/24  
**Watt:** 0.8

**Dim.:** 176x24.7x21.2 mm  
**Cable length:** 270 mm  
**Dist. mount. holes:** 157.4 mm

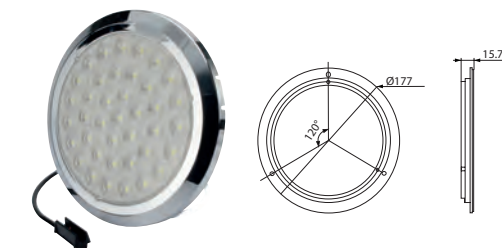
**Type:** LED  
**Colour:** White  
**Colour/glass:** Frosted  
**Material:** Shockproof plastic  
**Material/dome:** PMMA  
**Shape:** Oval  
**Mount.:** Plan installation  
**No./LEDs:** 10  
**Tightness norm:** IP 66  
**Approvals:** CE

**171750 LED Interior Lamp** Std pkg 1

**Voltage:** 12/24

**Dim.:** 177x15.7 mm  
**Cable length:** 500 mm  
**Dist. mount. holes:** 140 mm

**Type:** LED  
**Colour:** Chrome  
**Colour/glass:** Frosted  
**Material:** Shockproof plastic  
**Material/dome:** PMMA  
**Shape:** Round  
**Mount.:** Plan installation  
**No./LEDs:** 39  
**Tightness norm:** IP 56

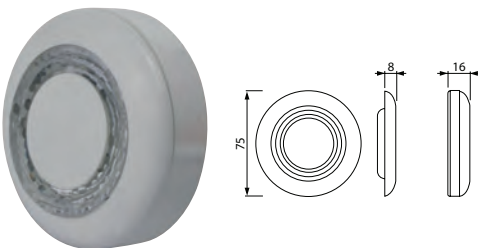
**171767 LED Interior Lamp** Std pkg 1

*Suited for flush mounting.*

**Voltage:** 9-30  
**Watt:** 0.8

**Dim.:** 75x16 mm  
**Cable length:** 120 mm  
**Dist. mount. holes:** 53 mm



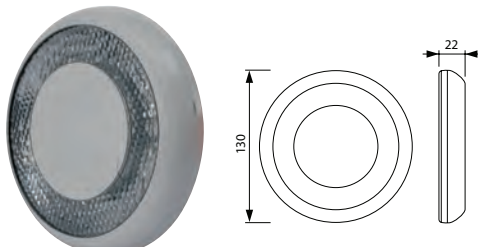

**Type:** Interior lamp  
**Colour:** White  
**Colour/glass:** Transparent  
**Material:** Shockproof plastic  
**Material/dome:** PMMA  
**Shape:** Round  
**Mount.:** 3 screws  
**Switch:** w/  
**No./LEDs:** 1  
**Approvals:** CE





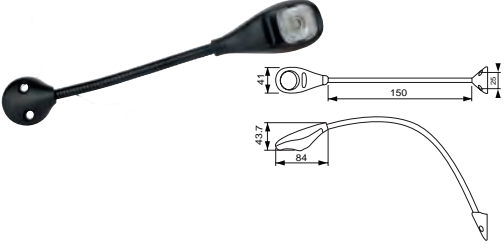
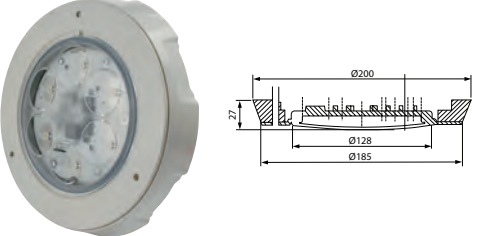
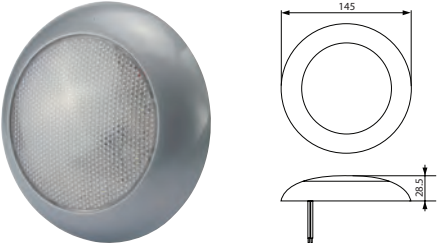

**171768 LED Interior Lamp** Std pkg 1





*Suited for flush mounting.*

**Voltage:** 9-30  
**Watt:** 2.8

**Dim.:** 130x22 mm  
**Cable length:** 120 mm  
**Dist. mount. holes:** 100 mm

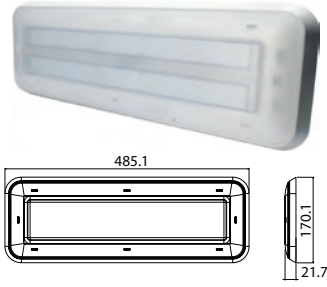
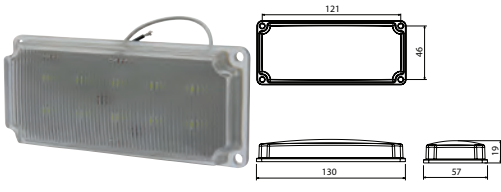
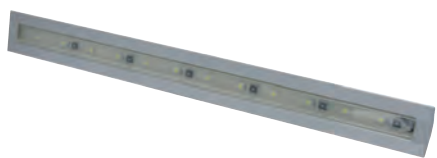
**Type:** Interior lamp  
**Colour:** White  
**Colour/glass:** Frosted  
**Material:** Shockproof plastic  
**Material/dome:** PMMA  
**Shape:** Round  
**Mount.:** 3 screws  
**Switch:** w/  
**No./LEDs:** 1  
**Approvals:** CE

EL. SPECIFICATIONS		DIMENSIONS	ADDITIONAL SPECIFICATIONS
<b>171769</b> LED Reading Lamp 	Std pkg 1 Voltage: 9-30 Watt: 1.8	Dim.: 150 mm Cable length: 120 mm Dist. mount. holes: 25 mm	Type: Interior lamp Colour: Black Colour/glass: Frosted Material: ABS plastic/aluminium Material/dome: Polycarbonate Shape: w/ adjustable metal arm Mount.: 2 screws Switch: w/ No./LEDs: 1 Approvals: CE
<b>171773</b> LED Interior Lamp HD Std pkg 1 <i>Suited for flush mounting.</i> Servicing: Suitable for use in refrigeration vehicles - Visit <a href="http://www.hc-cargo.com">www.hc-cargo.com</a> for further information.			
	Voltage: 10-32 Watt: 8/9	Dim.: 200x27 mm Dist. mount. holes: 137 mm	Type: Interior lamp Colour: White Colour/glass: Transparent Material: Cast aluminum Material/dome: Polycarbonate Shape: Round No./LEDs: 6 Tightness norm: IP 67 Approvals: EMC/ADR/GGVS
<b>171776</b> LED Interior Lamp 	Std pkg 1 Voltage: 12/24	Dim.: 145x28.5 mm Cable length: 220 mm Dist. mount. holes: 123 mm	Type: LED Colour: Silver Colour/glass: Frosted Material: Shockproof plastic Material/dome: Shockproof plastic Shape: Round Mount.: Plan installation No./LEDs: 42 Tightness norm: IP 66 Approvals: CE
<b>171825</b> LED Interior Lamp 	Std pkg 1 Voltage: 24 Watt: 2.2 Kelvin: 6500 Lumen: 80	Dim.: 300x15.2x6 mm Cable length: 400 mm	Type: LED Colour: Grey Colour/glass: Transparent Material: Aluminium Material/dome: Polycarbonate Shape: Flat Mount.: Plan installation Bracket: Snap-on Fixing screw: w/ No./LEDs: 12 Tightness norm: IP 65 Approvals: CE
<b>171826</b> LED Interior Lamp 	Std pkg 1 Voltage: 24 Watt: 4.3 Kelvin: 6500 Lumen: 160	Dim.: 600x15.2x6 mm Cable length: 400 mm	Type: LED Colour: Grey Colour/glass: Transparent Material: Aluminium Material/dome: Polycarbonate Shape: Flat Mount.: Plan installation Bracket: Snap-on Fixing screw: w/ No./LEDs: 24 Tightness norm: IP 65 Approvals: CE
<b>171827</b> LED Interior Lamp 	Std pkg 1 Voltage: 24 Watt: 7.5 Kelvin: 6500 Lumen: 281	Dim.: 1000x15.2x6 mm Cable length: 400 mm	Type: LED Colour: Grey Colour/glass: Transparent Material: Aluminium Material/dome: Polycarbonate Shape: Flat Mount.: Plan installation Bracket: Snap-on Fixing screw: w/ No./LEDs: 42 Tightness norm: IP 65 Approvals: CE

		EL. SPECIFICATIONS	DIMENSIONS	ADDITIONAL SPECIFICATIONS
<b>171828</b> LED Interior Lamp	Std pkg 1	Voltage: 24 Watt: 10.8 Kelvin: 6500 Lumen: 394	Dim.: 1400x15.2x6 mm Cable length: 400 mm	Type: LED Colour: Grey Colour/glass: Transparent Material: Aluminium Material/dome: Polycarbonate Shape: Flat Mount.: Plan installation Bracket: Snap-on Fixing screw: w/ No./LEDs: 60 Tightness norm: IP 65 Approvals: CE
				
<b>171829</b> LED Interior Lamp	Std pkg 1	Voltage: 12 Watt: 2.2 Kelvin: 6500 Lumen: 80	Dim.: 300x15.2x6 mm Cable length: 400 mm	Type: LED Colour: Grey Colour/glass: Transparent Material: Aluminium Material/dome: Polycarbonate Shape: Flat Mount.: Plan installation Bracket: Snap-on Fixing screw: w/ No./LEDs: 12 Tightness norm: IP 65 Approvals: CE
				
<b>171830</b> LED Interior Lamp	Std pkg 1	Voltage: 12 Watt: 4.3 Kelvin: 6500 Lumen: 160	Dim.: 600x15.2x6 mm Cable length: 400 mm	Type: LED Colour: Grey Colour/glass: Transparent Material: Aluminium Material/dome: Polycarbonate Shape: Flat Mount.: Plan installation Bracket: Snap-on Fixing screw: w/ No./LEDs: 24 Tightness norm: IP 65 Approvals: CE
				
<b>171831</b> LED Interior Lamp	Std pkg 1	Voltage: 12 Watt: 7.5 Kelvin: 6500 Lumen: 281	Dim.: 1000x15.2x6 mm Cable length: 400 mm	Type: LED Colour: Grey Colour/glass: Transparent Material: Aluminium Material/dome: Polycarbonate Shape: Flat Mount.: Plan installation Bracket: Snap-on Fixing screw: w/ No./LEDs: 42 Tightness norm: IP 65 Approvals: CE
				
<b>171832</b> LED Interior Lamp	Std pkg 1	Voltage: 12 Watt: 10.8 Kelvin: 6500 Lumen: 394	Dim.: 1400x15.2x6 mm Cable length: 400 mm	Type: LED Colour: Grey Colour/glass: Transparent Material: Aluminium Material/dome: Polycarbonate Shape: Flat Mount.: Plan installation Bracket: Snap-on Fixing screw: w/ No./LEDs: 60 Tightness norm: IP 65 Approvals: CE
				
<b>171863</b> LED Interior Lamp	Std pkg 1	Voltage: 12/24 Watt: 22 Lumen: 1100	Dim.: 465x150x21.7 mm Cable length: 420 mm	Type: LED Colour: White Colour/glass: Frosted Material: Shockproof plastic Material/dome: PMMA Shape: Rectangular Mount.: Built-in No./LEDs: 12 Tightness norm: IP 67 Approvals: CE
 				

		EL. SPECIFICATIONS	DIMENSIONS	ADDITIONAL SPECIFICATIONS
<b>171864</b> LED Interior Lamp	Std pkg 1	Voltage: 12/24 Watt: 22 Lumen: 1100	Dim.: 485.1x170.1x21.7 mm Cable length: 420 mm	Type: LED Colour: White Colour/glass: Frosted Material: Shockproof plastic Material/dome: PMMA Shape: Rectangular Mount.: Plan installation No./LEDs: 12 Tightness norm: IP 67 Approvals: CE
				
<b>171866</b> LED Interior Lamp	Std pkg 1	Voltage: 12/24 Lumen: 210	Dim.: 130x57x19 mm Cable length: 150 mm Dist. mount. holes: 46x121 mm	Type: LED Colour: Transparent Colour/glass: Frosted Material: Shockproof plastic Material/dome: PMMA Shape: Rectangular Mount.: Plan installation Fixing screw: 4 No./LEDs: 10 Tightness norm: IP 67 Approvals: CE
				
<b>171874</b> LED Interior Lamp	Std pkg 1	Voltage: 10-33 Watt: 1.6-3.4 Lumen: 82	Dim.: 300x19x19 mm Cable length: 400 mm	Type: LED Colour: Grey Colour/glass: Transparent Material: Aluminium Material/dome: Polycarbonate Shape: Angled Mount.: Plan installation Bracket: Snap-on No./LEDs: 12 Tightness norm: IP 65 Approvals: CE
				
<b>171875</b> LED Interior Lamp	Std pkg 1	Voltage: 10-30 Watt: 3.2-6.8 Lumen: 166	Dim.: 600x19x19 mm Cable length: 400 mm	Type: LED Colour: Grey Colour/glass: Transparent Material: Aluminium Material/dome: Polycarbonate Shape: Angled Mount.: Plan installation Bracket: Snap-on No./LEDs: 24 Tightness norm: IP 65 Approvals: CE
				
<b>171876</b> LED Interior Lamp	Std pkg 1	Voltage: 10-30 Watt: 5.7-11.8 Lumen: 273	Dim.: 1000x19x19 mm Cable length: 400 mm	Type: LED Colour: Grey Colour/glass: Transparent Material: Aluminium Material/dome: Polycarbonate Shape: Angled Mount.: Plan installation Bracket: Snap-on No./LEDs: 42 Tightness norm: IP 65 Approvals: CE
				
<b>171877</b> LED Interior Lamp	Std pkg 1	Voltage: 10-30 Watt: 8.1-16.8 Lumen: 383	Dim.: 1400x19x19 mm Cable length: 400 mm	Type: LED Colour: Grey Colour/glass: Transparent Material: Aluminium Material/dome: Polycarbonate Shape: Angled Mount.: Plan installation Bracket: Snap-on No./LEDs: 60 Tightness norm: IP 65 Approvals: CE
				

## INTERIOR LAMPS FLOURESCENT

**170032 Interior Lamp** Std pkg 1

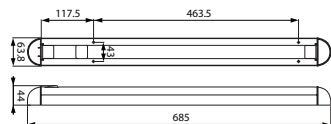
*Tube fluorescent: HC-CARGO 171397.*

 Voltage: 12  
Watt: 13

 Dim.: 685x63.8x44 mm  
Dist. mount. holes:  
463.5 mm

 Colour: White  
Material: Aluminium  
Shape: Oblong  
Switch: w/  
Fixing screw: 2  
Tightness norm: IP 40  
Approvals: CE

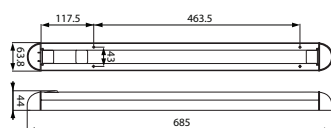
**170033 Interior Lamp** Std pkg 1

*Tube fluorescent: HC-CARGO 171397.*

 Voltage: 24  
Watt: 13

 Dim.: 685x63.8x44 mm  
Dist. mount. holes:  
590 mm

 Colour: White  
Material: ABS plastic/aluminium  
Shape: Oblong  
Switch: w/  
Fixing screw: 2  
Tightness norm: IP 40  
Approvals: CE

**170035 Interior Lamp** Std pkg 1

*Tube fluorescent: HC-CARGO 170664.*

 Voltage: 12  
Watt: 8

 Dim.: 394x60x36 mm  
Dist. mount. holes:  
350 mm

 Colour: White  
Material: ABS plastic  
Shape: Oblong  
Switch: w/  
Fixing screw: 2  
Tightness norm: IP 40  
Approvals: CE

**170036 Interior Lamp** Std pkg 1

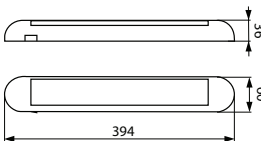
*Tube fluorescent: HC-CARGO 170664.*

 Voltage: 24  
Watt: 8

 Dim.: 394x60x36 mm  
Dist. mount. holes:  
350 mm

 Colour: White  
Material: ABS plastic  
Shape: Oblong  
Switch: w/  
Fixing screw: 2  
Tightness norm: IP 40  
Approvals: CE

**171392 Interior Lamp** Std pkg 1

*w/ switch 0-1-2. Tube: HC-CARGO 170664.*

 Voltage: 12  
Watt: 2x8

 Dim.: 360x62x37 mm  
Dist. mount. holes:  
200 mm

 Colour: White  
Material: Plastic  
Shape: Rectangular  
Switch: w/  
Fixing screw: 2

**171396 Interior Lamp** Std pkg 1

*Tube fluorescent: HC-CARGO 171397.*

 Voltage: 24  
Watt: 13

 Dim.: 580x50x26 mm  
Dist. mount. holes:  
465 mm

 Colour: White  
Material: Plastic  
Shape: Rectangular  
Switch: w/  
Fixing screw: 2



**SPARE PARTS**
**170664** Neon tube

Std pkg 1 Servicing: HC-CARGO 170035, 170036, 171392, 200181

 Voltage: 12-24  
Watt: 8

Length: 300 mm

E-approval: No

**REFLECTORS**
**170142** Reflector

Std pkg 10

w/ 5 mm bolt.



OD: 60 mm

 Colour: Red  
Material: Plastic  
Shape: Round  
Approvals: I A approval  
E-approval: Yes

**170143** Reflector

Std pkg 10

w/ 5 mm bolt.



OD: 83 mm

 Colour: Red  
Material: Plastic  
Shape: Round  
Approvals: I A approval  
E-approval: Yes

**170144** Reflector

Std pkg 10

 Dim.: 160x160x160 mm  
Dist. mount. holes:  
85 mm

 Colour: Red  
Material: Plastic  
Shape: Triangle  
Mount.: 2 screws  
Approvals: III A approval  
E-approval: Yes

**170163** Reflector

Std pkg 10

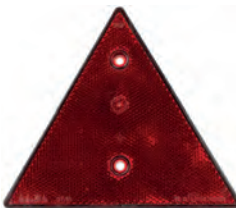
 Dim.: 155x135 mm  
Dist. mount. holes:  
70 mm

 Colour: Red  
Material: Plastic  
Shape: Triangle  
Mount.: 2 holes  
Approvals: III A approval  
E-approval: Yes

**170165** Reflector

Std pkg 10

 OD: 60 mm  
Hole size: 4 mm

 Colour: Red  
Material: Plastic  
Shape: Round  
Approvals: I A approval  
E-approval: Yes

**170169** Reflector



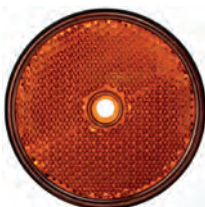

Std pkg 10





 OD: 60 mm  
Hole size: 4 mm



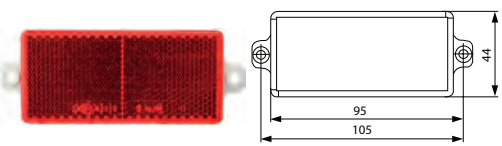
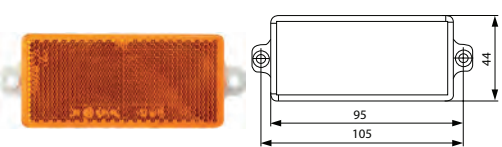
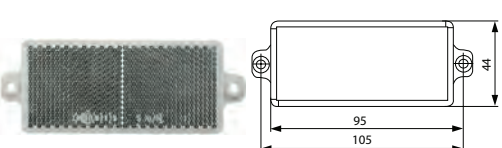

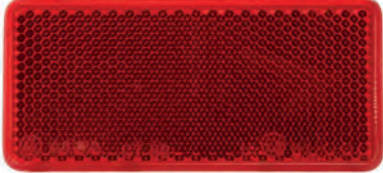
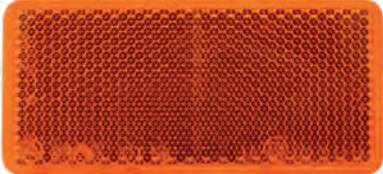
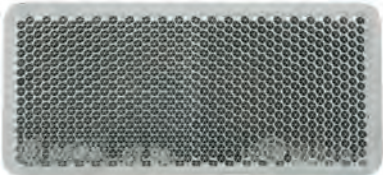
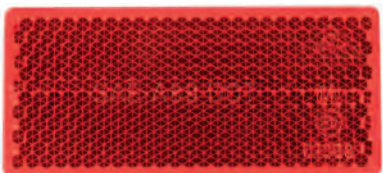
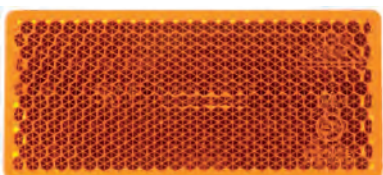
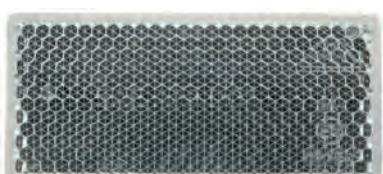

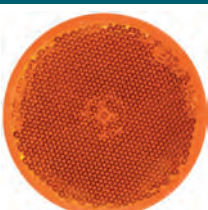
 Colour: Orange  
Material: Plastic  
Shape: Round  
Approvals: I A approval  
E-approval: Yes

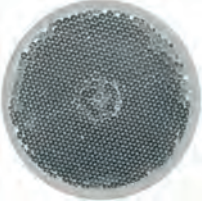

**ACCESSORIES - Lighting**

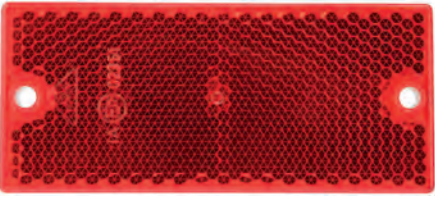
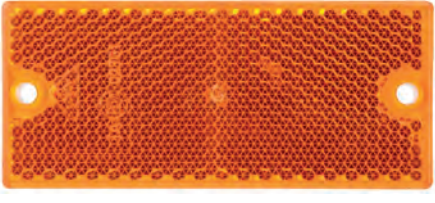
O.E.M. names and numbers are used for reference purposes only.

EL. SPECIFICATIONS		DIMENSIONS	ADDITIONAL SPECIFICATIONS
170170 Reflector	Std pkg 10		
		OD: 60 mm Hole size: 4 mm	Colour: White Material: Plastic Shape: Round Approvals: I A approval E-approval: Yes
170208 Reflector	Std pkg 10		
<i>Only approved in DK.</i>			
		Dim.: 50x200 mm	Colour: Red Shape: Rectangular Mount.: Self adhesive Approvals: JRU E-approval: No
170212 Reflector	Std pkg 10		
<i>Only approved in DK.</i>			
		Dim.: 50x200 mm	Colour: White Shape: Rectangular Mount.: Self adhesive E-approval: No
170213 Reflector	Std pkg 10		
<i>Only approved in DK.</i>			
		Dim.: 50x200 mm	Colour: Yellow Shape: Rectangular Mount.: Self adhesive Approvals: JRU E-approval: No
170623 Reflector	Std pkg 10		
		Dim.: 95x44 mm Dist. mount. holes: 105 mm	Colour: Red Material: Plastic Shape: Rectangular Mount.: 2 holes Approvals: I A approval E-approval: Yes
170624 Reflector	Std pkg 10		
		Dim.: 95x44 mm Dist. mount. holes: 105 mm	Colour: Orange Material: Plastic Shape: Rectangular Mount.: 2 holes Approvals: I A approval E-approval: Yes
170625 Reflector	Std pkg 10		
		Dim.: 95x44 mm Dist. mount. holes: 105 mm	Colour: White Material: Plastic Shape: Rectangular Mount.: 2 holes Approvals: I A approval E-approval: Yes



EL. SPECIFICATIONS		DIMENSIONS	ADDITIONAL SPECIFICATIONS
170626 Reflector	Std pkg 10	Dim.: 95x44 mm	Colour: Red Material: Plastic Shape: Rectangular Mount.: Self adhesive Approvals: 1 A approval E-approval: Yes
			
170627 Reflector	Std pkg 10	Dim.: 95x44 mm	Colour: Orange Material: Plastic Shape: Rectangular Mount.: Self adhesive Approvals: 1 A approval E-approval: Yes
			
170628 Reflector	Std pkg 10	Dim.: 95x44 mm	Colour: White Material: Plastic Shape: Rectangular Mount.: Self adhesive Approvals: 1 A approval E-approval: Yes
			
170629 Reflector	Std pkg 10	Dim.: 71x35 mm	Colour: Red Material: Plastic Shape: Rectangular Mount.: Self adhesive Approvals: 1 A approval E-approval: Yes
			
170630 Reflector	Std pkg 10	Dim.: 71x35 mm	Colour: Orange Material: Plastic Shape: Rectangular Mount.: Self adhesive Approvals: 1 A approval E-approval: Yes
			
170631 Reflector	Std pkg 10	Dim.: 71x35 mm	Colour: White Material: Plastic Shape: Rectangular Mount.: Self adhesive Approvals: 1 A approval E-approval: Yes
			
170675 Reflector	Std pkg 10	OD: 60 mm	Colour: Red Material: Plastic Shape: Round Mount.: Self adhesive Approvals: 1 A approval E-approval: Yes
			
170676 Reflector	Std pkg 10	OD: 60 mm	Colour: Orange Material: Plastic Shape: Round Mount.: Self adhesive Approvals: 1 A approval E-approval: Yes
			







EL. SPECIFICATIONS		DIMENSIONS	ADDITIONAL SPECIFICATIONS
170677 Reflector	Std pkg 10		
		OD: 60 mm	Colour: White Material: Plastic Shape: Round Mount.: Self adhesive Approvals: I A approval E-approval: Yes
170729 Reflector	Std pkg 10		
		OD: 83 mm Hole size: 4 mm	Colour: Red Material: Plastic Shape: Round Mount.: 1 hole Approvals: I A approval E-approval: Yes
171228 Reflector	Std pkg 10		
		Dim.: 90x40 mm Dist. mount. holes: 79 mm	Colour: Red Material: Plastic Shape: Rectangular Mount.: 2 holes Approvals: I A approval E-approval: Yes
171230 Reflector	Std pkg 10		
		Dim.: 90x40 mm Dist. mount. holes: 79 mm	Colour: Orange Material: Plastic Shape: Rectangular Mount.: 2 holes Approvals: I A approval E-approval: Yes
<b>ACCESSORIES</b>			
171536 Bracket	Std pkg 10		
		ID: 60 mm	No./mounting holes: 1 (0)
<b>MISCELLANEOUS REAR MARKING</b>			
171883 Green Identifying Marker	Std pkg 1		
<i>Silenced</i>			
		OD: 200 mm	Colour: White/green Material: PVC Film Shape: Round Mount.: Self-adhesive
171884 Green Identifying Marker	Std pkg 1		
<i>Silenced</i>			
		OD: 200 mm	Colour: White/green Material: PVC Film Shape: Round Mount.: Self-adhesive







<b>171885</b> Green Identifying Marker Std pkg 5 <i>Reduced emissions.</i>			
		OD: 200 mm	Colour: White/green Material: PVC Film Shape: Round Mount.: Self-adhesive
<b>171886</b> Green Identifying Marker Std pkg 1 <i>Silenced. Reduced emissions.</i>			
		OD: 200 mm	Colour: White/green Material: PVC Film Shape: Round Mount.: Self-adhesive
<b>171887</b> Green Identifying Marker Std pkg 1 <b>EURO 3</b>			
		OD: 200 mm	Colour: White/green Material: PVC Film Shape: Round Mount.: Self-adhesive
<b>171888</b> Green Identifying Marker Std pkg 1 <b>EURO 4</b>			
		OD: 200 mm	Colour: White/green Material: PVC Film Shape: Round Mount.: Self-adhesive
<b>171889</b> Green Identifying Marker Std pkg 1 <b>EURO 5</b>			
		OD: 200 mm	Colour: White/green Material: PVC Film Shape: Round Mount.: Self-adhesive
<b>SPEED LIMIT</b>			
<b>171898</b> Max Speedsign 15 km Std pkg 1 <i>Self-adhesive. Class 2.</i>			
		OD: 200 mm	Material: Film Shape: Round
<b>171899</b> Max Speedsign 40 km Std pkg 1 <i>Self-adhesive. Class 2.</i>			
		OD: 200 mm	Material: Film Shape: Round

<b>171900</b> Max Speedsign 60 km      Std pkg 1 Self-adhesive. Class 2.			
		OD: 200 mm	Material: Film Shape: Round
<b>171901</b> Max Speedsign 70 km      Std pkg 1 Self-adhesive. Class 2.			
		OD: 200 mm	Material: Film Shape: Round
<b>171902</b> Max Speedsign 80 km      Std pkg 1 Self-adhesive. Class 2.			
		OD: 200 mm	Material: Film Shape: Round
<b>171903</b> Max Speedsign 100 km      Std pkg 1 Self-adhesive. Class 2.			
		OD: 200 mm	Material: Film Shape: Round

## REAR MARKING TRAILERS

<b>170397</b> Reflector Board      Std pkg 1 Yellow: high intensive reflex. Class - A. Red: fluorescent.			
		Dim.: 1132x200 mm	Colour: Red/yellow Material: Aluminium Shape: Rectangular Approvals: ECE70 E-approval: Yes
<b>170398</b> Reflector Board Set      Std pkg 1 Yellow: high intensive reflex. Class - A. Red: fluorescent. 2 pcs.			
		Dim.: 566x200 mm	Colour: Red/yellow Material: Aluminium Shape: Rectangular Approvals: ECE70 E-approval: Yes
<b>170403</b> Reflector Foil Set      Std pkg 1 Yellow: high intensive reflex. Class - A. Red: fluorescent. 2 pcs.			
		Dim.: 566x200 mm	Colour: Red/yellow Shape: Rectangular Mount.: Self adhesive Approvals: ECE70 E-approval: Yes

EL. SPECIFICATIONS		DIMENSIONS	ADDITIONAL SPECIFICATIONS
<b>171554 Reflector Tape 50 m</b> Std pkg 1 <i>Safety marking for heavy vehicles and trailers. Mounting on rigid surface.</i>		Width: 50 mm Length: 50 m	Colour: Yellow Mount.: Self adhesive Approvals: ECE104 E-approval: Yes
			
<b>171555 Reflector Tape 50 m</b> Std pkg 1 <i>Safety marking for heavy vehicles and trailers. Mounting on rigid surface.</i>		Width: 50 mm Length: 50 m	Colour: White Mount.: Self adhesive Approvals: ECE104 E-approval: Yes
			
<b>171556 Reflector Tape 50 m</b> Std pkg 1 <i>Safety marking for heavy vehicles and trailers. Mounting on rigid surface.</i>		Width: 50 mm Length: 50 m	Colour: Red Mount.: Self adhesive Approvals: ECE104 E-approval: Yes
			
<b>171570 Reflector Board Set</b> Std pkg 1 <i>Yellow: high intensive reflex. Class 3. Red: fluorescent. 2 pcs.</i>		Dim.: 566x197x0.8 mm	Colour: Red/yellow Material: Aluminium Shape: Rectangular Approvals: ECE70-01 E-approval: Yes
			
<b>171572 Reflector Foil Set</b> Std pkg 1 <i>Yellow: high intensive reflex. Class 3. Red: fluorescent. 2 pcs.</i>		Dim.: 566x197 mm	Colour: Red/yellow Shape: Rectangular Mount.: Self adhesive Approvals: ECE70-01 E-approval: Yes
			
<b>171575 Reflector Board Set</b> Std pkg 1 <i>Yellow: high intensive reflex. Class 3. Red: fluorescent. 4 pcs.</i>		Dim.: 283x197x0.8 mm	Colour: Red/yellow Material: Aluminium Shape: Rectangular Approvals: ECE70-01 E-approval: Yes
			
<b>REAR MARKING TRUCKS</b>			
<b>170394 Reflector Board</b> Std pkg 1 <i>Yellow: high intensive reflex. Class II. Red: fluorescent. 1 pcs.</i>		Dim.: 1132x140x1.2 mm	Colour: Red/yellow Material: Aluminium Shape: Rectangular Approvals: ECE70 E-approval: Yes
			

EL. SPECIFICATIONS		DIMENSIONS	ADDITIONAL SPECIFICATIONS
<b>170395 Reflector Board Set</b> Std pkg 1 Yellow: high intensive reflex. Class II. Red: fluorescent. 2 pcs.		Dim.: 565x132x0.8 mm	Colour: Red/yellow Material: Aluminium Shape: Rectangular Approvals: ECE70 E-approval: Yes
			
<b>170396 Reflector Board Set</b> Std pkg 1 Yellow: high intensive reflex. Class II. Red: fluorescent. 4 pcs.		Dim.: 283x140x0.8 mm	Colour: Red/yellow Material: Aluminium Shape: Rectangular Approvals: ECE70 E-approval: Yes
			
<b>170401 Reflector Foil Set</b> Std pkg 1 Yellow: high intensive reflex. Class II. Red: fluorescent. 2 pcs.		Dim.: 566x140 mm	Colour: Red/yellow Shape: Rectangular Mount.: Self adhesive Approvals: ECE70 E-approval: Yes
			
<b>170402 Reflector Foil Set</b> Std pkg 1 Yellow: high intensive reflex. Class II. Red: fluorescent. 4 pcs.		Dim.: 283x140 mm	Colour: Red/yellow Shape: Rectangular Mount.: Self adhesive Approvals: ECE70 E-approval: Yes
			
<b>171568 Reflector Board Set</b> Std pkg 1 Yellow: high intensive reflex. Class 3. Red: fluorescent. 2 pcs.		Dim.: 565x132x0.8 mm	Colour: Red/yellow Material: Aluminium Shape: Rectangular Approvals: ECE70-01 E-approval: Yes
			
<b>171571 Reflector Foil Set</b> Std pkg 1 Yellow: high intensive reflex. Class 3. Red: fluorescent. 2 pcs.		Dim.: 566x132 mm	Colour: Red/yellow Shape: Rectangular Mount.: Self adhesive Approvals: ECE70-01 E-approval: Yes
			
<b>171878 Warning Liftflag Right</b> Std pkg 1 Right. Class 1.		Dim.: 410x250 mm	Colour: Red/white Material: Canvas + film Shape: Rectangular
			



EL. SPECIFICATIONS	DIMENSIONS	ADDITIONAL SPECIFICATIONS
<p><b>171879</b> Warning Liftflag Std pkg 1 w/ alu support. Left. Class 1.</p> 	<p>Dim.: 410x250 mm</p>	<p>Colour: Red/white Material: Canvas + film Shape: Rectangular</p>
<p><b>171880</b> Warning Liftflag w/ alu Std pkg 1 Servicing: HC-CARGO 171882 w/ alu support. Right. Class 1.</p> 	<p>Dim.: 410x250 mm</p>	<p>Colour: Red/white Material: Canvas + film Shape: Rectangular</p>
<p><b>171881</b> Warning Liftflag w/ alu Std pkg 1 Servicing: HC-CARGO 171882 w/ alu support. Left. Class 1.</p> 	<p>Dim.: 410x250 mm</p>	<p>Colour: Red/white Material: Canvas + film Shape: Rectangular</p>
<p><b>171882</b> Warning Liftflag w/ alu Kit Std pkg 1 w/ alu support. Kit. Class 1. Warning Liftflag: HC-CARGO 171880, 171881.</p> 	<p>Dim.: 410x250 mm</p>	<p>Colour: Red/white Material: Canvas + film Shape: Rectangular</p>
<p><b>171891</b> Wide Load Marking Std pkg 1 For Agriculture. Class 1. DIN 11030.</p> 	<p>Dim.: 423x423x0.8 mm</p>	<p>Colour: Red/white Material: Zinc + film Shape: Square</p>
<p><b>171892</b> Wide Load Marking Kit Std pkg 1 For Agriculture. Kit. Class 1. DIN 11030.</p> 	<p>Dim.: 564x282x0.8 mm</p>	<p>Colour: Red/white Material: Zinc + film Shape: Rectangular</p>
<p><b>171893</b> Wide Load Marking Std pkg 1 Class 1.</p> 	<p>Dim.: 900x300x2 mm</p>	<p>Colour: Black/yellow/red Material: Aluminium + film Shape: Rectangular</p>

**171894 Wide Load Marking** Std pkg 1

Class 1.



Dim.: 565x200x2 mm

 Colour: Black/yellow/red  
 Material: Aluminium + film  
 Shape: Rectangular

**CONTAINER MARKING**
**171895 Skipmarking** Std pkg 1

Self-adhesive. Left. Class 2.

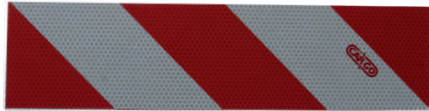

Dim.: 100x400 mm

 Colour: White/red  
 Material: Film  
 Shape: Rectangular

**171896 Skipmarking** Std pkg 1

Self-adhesive. Right. Class 2.



Dim.: 100x400 mm

 Colour: White/red  
 Material: Film  
 Shape: Rectangular

**171897 Skipmarking** Std pkg 1

Self-adhesive kit. Class 2.



Dim.: 200x400 mm

 Colour: White/red  
 Material: Film  
 Shape: Rectangular

**WARNING TRIANGLES**
**170171 Warning Triangle** Std pkg 1

Break down warning triangle. Supplied in plastic carrying box.



Dim.: 440x440x440 mm

 Shape: Triangle  
 E-approval: Yes

**TRIANGLES**
**170390 Reflector Triangle** Std pkg 5

Red: high intensive foil. Class A. Red: fluorescent foil. w/o bracket. Mounting Bracket: HC-CARGO 170391, 170392, 170797. Mounting Bracket Kit: HC-CARGO 170393

 Dim.: 350-365 mm  
 Dist. mount. holes:  
 153 mm

 Colour: Red  
 Material: Aluminium  
 Shape: Triangle  
 E-approval: Yes

**170407 Reflector Foil** Std pkg 5

Red: high intensive reflex. Class A. Red: fluorescent.



Dim.: 409x358x308 mm

 Colour: Red  
 Shape: Triangle  
 Mount.: Self adhesive  
 E-approval: Yes

**170759 Reflector Triangle** Std pkg 5

Red: high intensive foil. Class A. Red: fluorenscent foil. w/o bracket. Mounting Bracket: HC-CARGO 170391, 170392, 170797. Mounting Bracket Kit: HC-CARGO 170393



Dim.: 428x375x310 mm  
Dist. mount. holes: 153 mm  
Hole size: 6 mm

Colour: Red  
Material: Shock thermo plastic  
Shape: Triangle  
E-approval: Yes

**ACCESSORIES**

**170391 Mounting Bracket** Std pkg 1 Servicing: HC-CARGO 170390, 170759, 170393

Male.



**170392 Mounting Bracket** Std pkg 1 Servicing: HC-CARGO 170390, 170759, 170393

Female.



**170393 Mounting Bracket Kit** Std pkg 1 Servicing: HC-CARGO 170390, 170759

w/ male and female brackets, bolts and nuts. Contains: 2 pcs: HC-Cargo 170780. 2 pcs: HC-Cargo 190590. 2 pcs: HC-CARGO 190477. 1 pcs: HC-CARGO 170391. 1 pcs: HC-CARGO 170392.



**170797 Mounting Bracket** Std pkg 1 Servicing: HC-CARGO 170390, 170759

Angled.



**HAZARD WARNING LIGHTS**

**170683 Hazard Warning Lamp** Std pkg 1 Servicing: Approved for vehicles carrying dangerous goods - Visit [www.hc-cargo.com](http://www.hc-cargo.com) for further information.

Battery: HC-CARGO 200741, 200768.

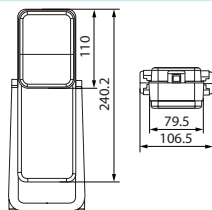

Dim.: 240.2x106.5 mm

Battery type: D  
No./batteries: 5  
Hazard flasher: w/  
Approval: GGVS/ADR  
E-approval: Yes

**LED**

**171797** LED Hazard Warning Lamp Std pkg 1

Servicing: Approved for vehicles carrying dangerous goods - Visit [www.hc-cargo.com](http://www.hc-cargo.com) for further information.

Battery: HC-CARGO 200739.



Dim.: 215x75x63 mm

Type: LED  
 Battery type: AA  
 Material: ABS plastic  
 No./batteries: 4  
 Hazard flasher: w/  
 Drop proof: Yes  
 Approval: GGVS/ADR

**PEN-/TORCH LIGHTS**

**TORCH LIGHT CONVENTIONAL**

**170353** High Powered Torch Std pkg 1

Bulb: HC-CARGO 171280. Batteries: HC-CARGO 200741, 200768.



Dim.: 182x111 mm

Bulb type: Krypton  
 Battery type: D  
 No./batteries: 4  
 Approval: CE

**TORCH LIGHT LED**

**171749** LED Torch Light Std pkg 1

Battery: HC-CARGO 200738.



Watt: 1  
 Lumen: 65

Dim.: 37x120 mm

Bulb type: LED  
 Battery type: AAA  
 Material: Aluminium  
 No./batteries: 3  
 Clips: w/  
 Waterproof: Yes

**171787** LED Torch Light Std pkg 1

Battery: HC-CARGO 200740.



Watt: 2.2

Dim.: 217x52x52 mm

Bulb type: LED  
 Battery type: LR14  
 Material: Shockproof plastic  
 No./batteries: 3  
 Shoulder strap: w/  
 Drop proof: Yes  
 Waterproof: Yes

**TORCH LIGHT LED/UV**

**171805** UV LED Torch light Std pkg 1

Battery: HC-CARGO 200738.



Dim.: 126 mm

Bulb type: UV LED  
 Battery type: AAA  
 Material: Aluminium  
 No./batteries: 3  
 Waterproof: Yes  
 Approval: CE

**253489** UV Inspection Lamp Std pkg 1

3 pcs. Batteries and mirror included. Batteries: HC-CARGO 200858.



Bulb incl.: Yes

Type: LED  
 Colour: Blue  
 Model: UV

## PEN-/TORCH LIGHTS LED

**171704** LED Penlight Std pkg 1

*Button w/ easy touch for either signal or constant light. Optical lense intensive the light. At least 8 hours of burn time. Battery: HC-CARGO 200738.*

Dim.: 14.5x109 mm

 Bulb type: LED  
 Battery type: AAA  
 Material: Aluminium  
 No./batteries: 1  
 Drop proof: Yes  
 Waterproof: Yes  
 Approval: CE

**172103** LED Penlight - 1 pcs Std pkg 1

Battery: HC-CARGO 200738.



Dim.: 200x28x20 mm

 Bulb type: LED  
 Battery type: AAA  
 Material: Rubber  
 No./batteries: 4  
 Shoulder strap: w/  
 Magnet holder: w/  
 Approval: CE  
 Alternativ no. 172104

**172104** LED Penlight - 12 pcs Std pkg 1

Battery: HC-CARGO 200738.



Dim.: 200x28x20 mm

 Bulb type: LED  
 Battery type: AAA  
 Material: Rubber  
 No./batteries: 4  
 Shoulder strap: w/  
 Magnet holder: w/  
 Approval: CE  
 Alternativ no. 172103

## HAND LAMPS CONVENTIONAL

**200181** Hand Lamp Std pkg 1

*Works at temperature below zero. All parts are replaceable. Neon tube HC-CARGO 170664.*

 Voltage: 230  
 Watt: 8  
 Lumen: 400

 Length: 510 mm  
 Cable length: 5 mm

 Plug: w/  
 Hi impact: Yes  
 Tightness norm: IP 67  
 Approvals: CE

**200635** Hand Lamp Std pkg 1

*Four times as powerful as regular hand-lamps. Operating at temperatures below zero degrees. All parts can be replaced. Resistant to oil, gasoline and chemicals. Fluorescent: HC-CARGO 171573. Electronics Part: HC-CARGO 200659.*

 Voltage: 230  
 Watt: 11  
 Lumen: 900

 Length: 455 mm  
 Cable length: 5 mm

 Plug: w/  
 Hi impact: Yes  
 Tightness norm: IP 64  
 Approvals: CE



**200728** Hand Lamp Std pkg 1







*Works at temperature below zero. All parts are replaceable. Electronic Part: HC-CARGO 200659.*

 Voltage: 230  
 Watt: 9  
 Lumen: 400

 Length: 390 mm  
 Cable length: 5 mm

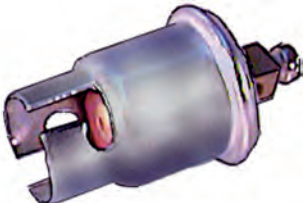
 Plug: w/  
 Hi impact: Yes  
 Tightness norm: IP 65  
 Approvals: CE

		EL. SPECIFICATIONS	DIMENSIONS	ADDITIONAL SPECIFICATIONS
<b>200733 Hand Lamp</b> Std pkg 1		Voltage: 230 Watt: 8 Lumen: 300	Length: 450 mm Cable length: 5 mm	Plug: w/ Tightness norm: IP 20 Approvals: CE
				
<b>200837 Hand Lamp</b> Std pkg 1		Voltage: 230 Watt: 11 Lumen: 900	Length: 450 mm Cable length: 5 mm	Hi impact: Yes Tightness norm: IP 65 Approvals: CE
				
<b>SPARE PARTS/ACCESSORIES</b>				
<b>170960 Fluorescent Tube</b> Std pkg 1				
<i>Socket PL-S 2P (G23).</i>		Watt: 11/830 Lumen: 900	Length: 214 mm	Approvals: CE
				
<b>171573 Neon tube</b> Std pkg 1				
<i>Socket PL-S 4P (2G7).</i>		Watt: 11/830 Lumen: 900	Length: 214 mm	Approvals: CE
				
<b>200659 Electronic Part</b> Std pkg 1				
<i>Socket PL-S 4P (2G7).</i>		Watt: 230		Tightness norm: IP 65 Approvals: CE
				
<b>200684 Lamp Holder</b> Std pkg 1				
<i>For hand lamps.</i>				Tightness norm: IP 67
				
<b>HAND LAMPS LED</b>				
<b>171999 LED Hand Lamp</b> Std pkg 1		Lumen: 300	Dim.: 270x42x51 mm	Bulb type: LED Battery type: Li-ion Magnet holder: w/ Lamp head: Yes Wall charger 230 V: Yes Rechargeable: Yes Approval: CE
				

		EL. SPECIFICATIONS	DIMENSIONS	ADDITIONAL SPECIFICATIONS
<b>172000 LED Hand Lamp UK</b> Std pkg 1		Lumen: 300	Dim.: 270x42x51 mm	Bulb type: LED Battery type: Li-ion Magnet holder: w/ Lamp head: Yes Wall charger 230 V: Yes Rechargeable: Yes Approval: CE
				
<b>BULB HOLDERS</b>				
<b>170135 Bulb Holder</b> Std pkg 10				Socket type: BAY15d Connection: Screw M5
				
<b>170136 Bulb Holder</b> Std pkg 10				Socket type: BA9s Connection: Screw M5
				
<b>170137 Bulb Holder</b> Std pkg 10				Socket type: BA7s Connection: Screw M5
				
<b>170138 Bulb Holder</b> Std pkg 10				Socket type: BA15S Connection: Screw M5
				
<b>170139 Bulb Holder</b> Std pkg 10 <i>33-36 mm. Festoon type.</i>				Socket type: S8.5 Connection: Screw M5
				
<b>170433 Bulb Holder</b> Std pkg 1    Servicing: H4 <i>Also for bulbs that fit socket P45t. Used w/ sealed beams.</i>				Socket type: P43t Connection: Terminal
				

**170596** Bulb Holder Std pkg 10

 Socket type: BA15d  
 Connection: Screw M5

**170619** Bulb Holder Std pkg 10 Servicing: H4, HC-CARGO 171281

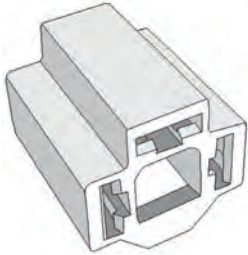
*Also for bulbs that fit socket P43t. Used w/ sealed beams. Terminal: HC-CARGO 191200.*

 Socket type: P45t  
 Connection: Plug

**170763** Bulb Holder Std pkg 10

 Servicing: VW Golf, Vento, Polo, Passat, Seat Ibiza, Toledo - Visit [www.hc-cargo.com](http://www.hc-cargo.com) for further information.

 Socket type: T10  
 Connection: Multiplug

**170790** Bulb Holder Std pkg 10

*2x terminal connection.*

 Socket type: BA9s  
 Connection: Terminal

**170791** Bulb Holder Std pkg 10





*2x screw connection.*

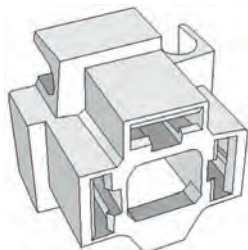

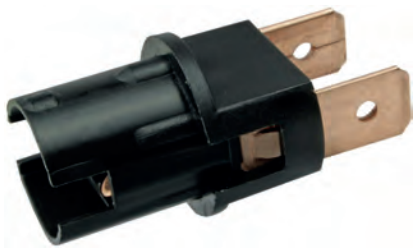

 Socket type: BA15S  
 Connection: Screw M5

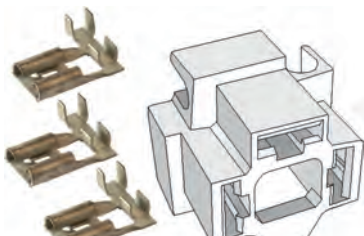
**170799** Bulb Holder Std pkg 10 Servicing: HC-CARGO 171282

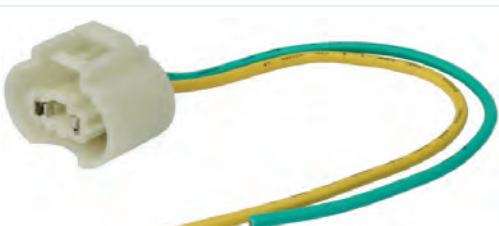
*Also for bulbs that fit socket P45t. Used w/ sealed beams. Angled type. Terminal: HC-CARGO 191938.*

 Socket type: P43t  
 Connection: Plug

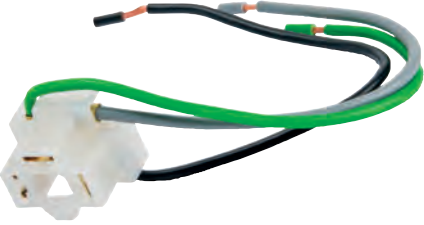
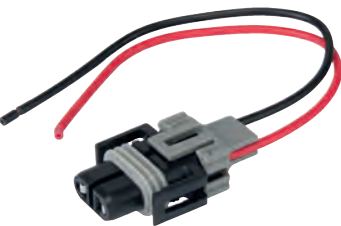

<p><b>170827</b> Bulb Holder Std pkg 10  <i>2x terminal connection.</i></p> 			<p>Socket type: T10          Connection: Terminal</p>
<p><b>170964</b> Bulb Holder Std pkg 10 Servicing: H4  <i>Also for bulbs that fit socket P45. Used w/ sealed beams. w/ snap-lock action for cable connection.</i></p> 			<p>Socket type: P43t+P45t          Connection: Kabel</p>
<p><b>171281</b> Bulb Holder Set Std pkg 1 Servicing: H4  <i>Contains: 1x HC-CARGO 170619. 3x HC-CARGO 191200.</i></p> 			<p>Socket type: P43t          Connection: Plug</p>
<p><b>171282</b> Bulb Holder Set Std pkg 1 Servicing: H4  <i>Contains: 1x HC-CARGO 170799. 3x HC-CARGO 191938.</i></p> 			<p>Socket type: P43t          Connection: Plug</p>
<p><b>171426</b> Bulb Holder Std pkg 1  <i>w/ wire.</i></p> 			<p>Socket type: HB3, H10, H12          Connection: Cable</p>
<p><b>171427</b> Bulb Holder Std pkg 1  <i>w/ wire.</i></p> 			<p>Socket type: HB4          Connection: Cable</p>

EL. SPECIFICATIONS		DIMENSIONS	ADDITIONAL SPECIFICATIONS
171453 Bulb Holder	Std pkg 10 Servicing: H7		Socket type: PX26d Connection: Cable
			
171783 Bulb Holder	Std pkg 1		Socket type: HB1, HB5 Connection: Cable
			
171784 Bulb Holder	Std pkg 1		Socket type: H8, H9, H11 Connection: Cable
			
171924 Bulb Holder	Std pkg 1 Servicing: H1/H3		Socket type: P14.5s, PK22s, PKY22s Connection: Cable
2 way.			
			
171925 Bulb Holder	Std pkg 1 Servicing: H1/H3		Socket type: P14.5s, PK22s, PKY22s Connection: Cable
1 way.			
			
171954 Bulb Holder	Std pkg 1 Servicing: H4		Socket type: P43t Connection: Cable
			
172072 Bulb Holder	Std pkg 1 Servicing: HC-CARGO 171010, 170951, 171953, 170726		Socket type: PGJ13 Connection: Cable
			



# Multi Function Lamps

Edition 2016/2017

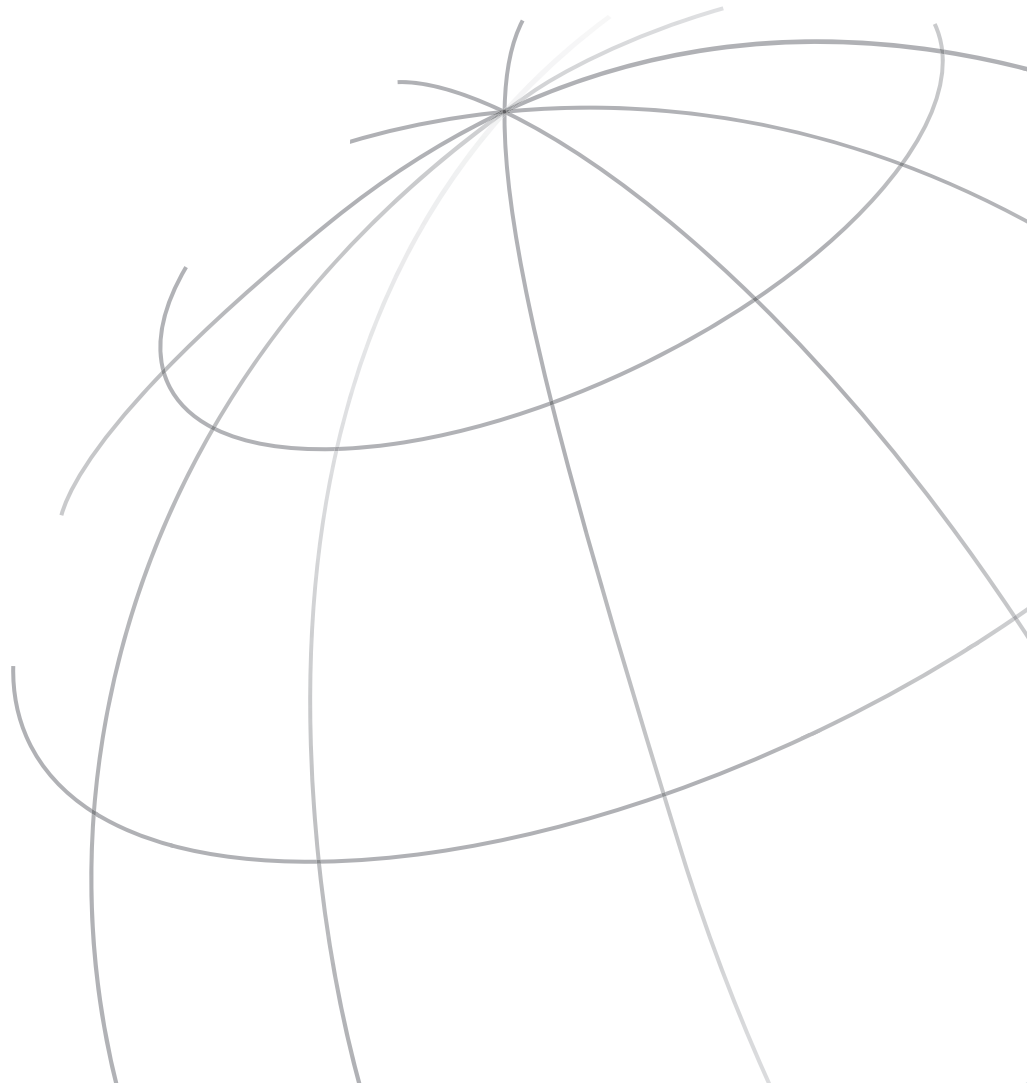

HC-CARGO	Dimension	Servicing	Right / Left	Flasher light	Number Plates light	Rear fog lamp	Reflector	Reverse light	Side marker lamp	Stop light	Tail light	Connection	E-Approval	Replacing	Lens
171308	525 x 139 x 83	Mercedes Actros	RH	✓	✓	✓	✓	✓	✓	✓	✓	M	✓	42940000, 42939000, 0015406370	HC-CARGO 171312
171311	525 x 139 x 83	Mercedes Actros	LH	✓	✓	✓	✓	✓	✓	✓	✓	M	✓	42942000, 42941000, 0015406270	HC-CARGO 171521
171447	525 x 139 x 83	Mercedes Actros, SK	LH	✓	✓	✓	✓	✓	✓	✓	✓	G	✓	2VD007500-091	HC-CARGO 171521
171448	525 x 139 x 83	Mercedes Actros, SK	RH	✓	✓	✓	✓	✓	✓	✓	✓	B	✓		HC-CARGO 171312
171802	517 x 129.5 x 80.2	Scania	RH	✓	✓	✓	✓	✓	✓	✓	✓		✓		HC-CARGO 171322
171803	517 x 129.5 x 80.2	Scania	LH	✓	✓	✓	✓	✓	✓	✓	✓		✓		HC-CARGO 171322
170916	465 x 130 x 83	Scania, Universal.	LH	✓	✓	✓	✓	✓	✓	✓	✓	A	✓	2vd007323-031, 21.197-021, 21.197-001, 170914, 168350, 168340, 1365963	HC-CARGO 170968
170917	465 x 130 x 83	Scania, Universal	RH	✓	✓	✓	✓	✓	✓	✓	✓	A	✓	2vp007323-021, 2vd007323-041, 21.197-031, 21.197-011, 170915, 168360, 168270, 167600, 1365965, 1365964	HC-CARGO 170968
170922	465 x 130 x 83	MAN, Universal	LH	✓	✓	✓	✓	✓	✓	✓	✓	C	✓	2vd007323-131, 21.197-121, 168100	HC-CARGO 170968
170923	465 x 130 x 83	MAN, Universal	RH	✓	✓	✓	✓	✓	✓	✓	✓	C	✓	2vp007323-121, 2vd007323-141, 21.197-131, 21.197-111, 170921, 167700	HC-CARGO 170968
170998	465 x 130 x 83	Iveco	RH/LH	✓	✓	✓	✓	✓	✓	✓	✓	D	✓	99463242, 44847000, 171298	HC-CARGO 171000
170999	465 x 130 x 83	Iveco	RH/LH	✓	✓	✓	✓	✓	✓	✓	✓	D	✓	99463244, 44848000	HC-CARGO 171000
171299	465 x 130 x 90	Mercedes Atego	RH	✓	✓	✓	✓	✓	✓	✓	✓	P	✓	42931000, 42632000, 0035445503, 0035445203	HC-CARGO 171307
171302	465 x 130 x 90	Mercedes Atego	LH	✓	✓	✓	✓	✓	✓	✓	✓	P	✓	42934000, 0035445603, 0035445303	HC-CARGO 171307
171303	465 x 130 x 90	Mercedes Sprinter	RH	✓	✓	✓	✓	✓	✓	✓	✓	K	✓	42935000, 42936000, 0035445403	HC-CARGO 171307
171306	465 x 130 x 90	Mercedes Sprinter	LH	✓	✓	✓	✓	✓	✓	✓	✓	K	✓	42938000, 42937000, 0025445503	HC-CARGO 171307
171806	428 x 140 x 87	Trucks, Universal	LH	✓	✓	✓	✓	✓	✓	✓	✓	M	✓		HC-CARGO 171810
171807	428 x 140 x 87	Trucks, Universal	RH	✓	✓	✓	✓	✓	✓	✓	✓	M	✓		HC-CARGO 171810
171808	428 x 140 x 87	Commercial trailers	LH	✓	✓	✓	✓	✓	✓	✓	✓	M	✓		HC-CARGO 171810
171809	428 x 140 x 87	Commercial trailers	RH	✓	✓	✓	✓	✓	✓	✓	✓	M	✓		HC-CARGO 171810
171441	421 x 147 x 75	Commercial Trailers	LH	✓	✓	✓	✓	✓	✓	✓	✓	K	✓		HC-CARGO 171446
171442	421 x 147 x 75	Commercial Trailers	RH	✓	✓	✓	✓	✓	✓	✓	✓	K	✓		HC-CARGO 171446
171443	421 x 147 x 75	Schwarz Müller	LH	✓	✓	✓	✓	✓	✓	✓	✓	I	✓		HC-CARGO 171446
171444	421 x 147 x 75	Schwarz Müller	RH	✓	✓	✓	✓	✓	✓	✓	✓	I	✓		HC-CARGO 171446
170990	418 x 148 x 90	Commercial Trailers	RH	✓	✓	✓	✓	✓	✓	✓	✓	A	✓		HC-CARGO 170994
170991	418 x 148 x 90	Commercial Trailers	LH	✓	✓	✓	✓	✓	✓	✓	✓	A	✓		HC-CARGO 170995
170602	406 x 135 x 74	RVI Renault, Pegaso	LH	✓	✓	✓	✓	✓	✓	✓	✓	A	✓	141500	HC-CARGO 170665
170603	406 x 135 x 74	RVI Renault, Pegaso	RH	✓	✓	✓	✓	✓	✓	✓	✓	A	✓		HC-CARGO 170665
171506	350 x 130 x 85	DAF, Nissan, Renault	RH/LH	✓	✓	✓	✓	✓	✓	✓	✓	J	✓		HC-CARGO 171507
171508	350 x 130 x 85	Commercial Trailers	RH/LH	✓	✓	✓	✓	✓	✓	✓	✓	K	✓		HC-CARGO 171509
171206	343 x 133 x 75	MAN, VW, Mercedes	LH	✓	✓	✓	✓	✓	✓	✓	✓	A	✓	2sI003567-691, 21.147-081	HC-CARGO 171263
170893	335 x 96 x 83		RH	✓	✓	✓	✓	✓	✓	✓	✓	A	✓	2sd001688-141, 21.002-031, 21.002-031, 21.002-021, 21.002-021, 170892	HC-CARGO 171062
170895	335 x 96 x 83		LH	✓	✓	✓	✓	✓	✓	✓	✓	A	✓	2sd001688-171, 21.002-071, 21.002-071	HC-CARGO 171062

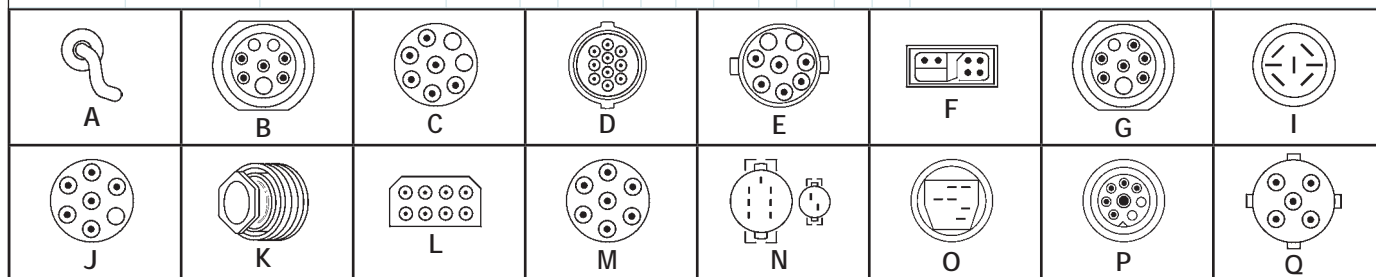



# Bulbs

Edition 2016/2017

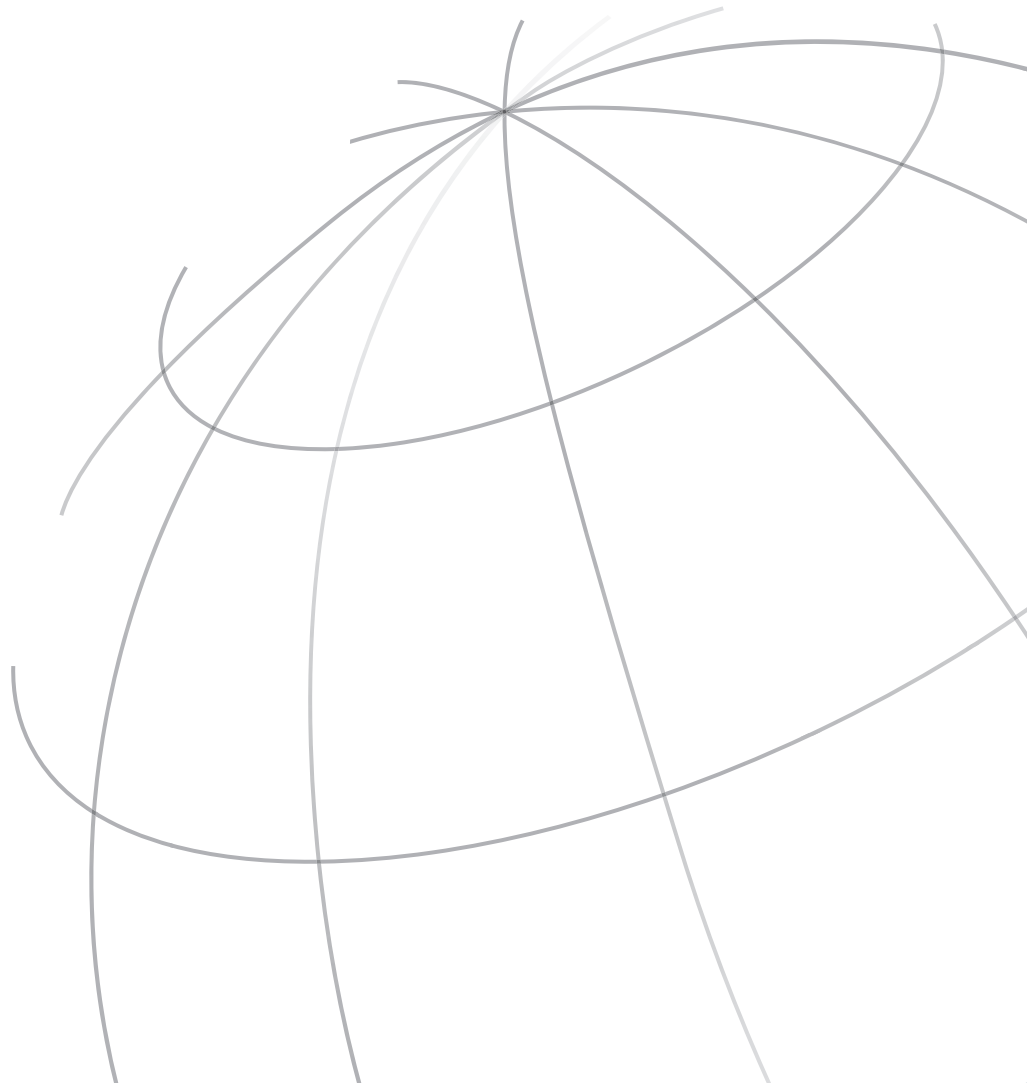

## H1 Halogen

	HC-CARGO	Std. pkg.	Voltage	Watt	Length	OD	Colour	Type	Comment
 P14.5s	170069	Pkg. 1	12	55	62.5 mm	8.5 mm		Single filament	
	171136	Pkg. 1	12	55	62.5 mm	8.5 mm		Single filament	<i>Gives up to 50% more light.</i>
	171071	Pkg. 1	12	55	62.5 mm	8.5 mm	Xenon blue	Single filament	
	171070	Pkg. 1	12	55	62.5 mm	8.5 mm		Single filament	<i>Gives up to 30% more light.</i>
	171068	Pkg. 1	12	100	62.5 mm	8.5 mm		Single filament	<i>Not E-approved.</i>
	171404	Pkg. 1	12	130	59.8 mm	9.7 mm		Single filament	<i>Not E-approved.</i>
	171072	Pkg. 1	24	70	62.5 mm	8.5 mm		Single filament, Heavy duty	
<b>Jahn</b>	HC-CARGO	Std. pkg.	Voltage	Watt	Length	OD	Colour	Type	Comment
 P14.5s	170965	Pkg. 1	12	55	62.5 mm	8.5 mm		Single filament, Megalight	<i>Gives up to 30% more light.</i>
	170332	Pkg. 1	12	55	62.5 mm	8.5 mm		Single filament	
	170493	Pkg. 1	12	100	62.5 mm	8.5 mm		Single filament	<i>Not E-approved.</i>
	170449	Pkg. 1	24	70	62.5 mm	8.5 mm		Single filament, Heavy duty	
	170494	Pkg. 1	24	100	62.5 mm	8.5 mm		Single filament, Heavy duty	<i>Not E-approved.</i>
<b>OSRAM</b>	HC-CARGO	Std. pkg.	Voltage	Watt	Length	OD	Colour	Type	Comment
 P14.5s	171686	Pkg. 1	12	55	58.9 mm	9 mm		Nightbreaker	<i>Up to 90% more light. Up to 35 m longer beam. Up to 10% whiter light.</i>

## H2 Halogen

	HC-CARGO	Std. pkg.	Voltage	Watt	Length	OD	Colour	Type	Comment
 X511	171073	Pkg. 1	12	55	30 mm	9 mm		Single filament	
	170512	Pkg. 1	24	100	30 mm	9 mm		Single filament, Heavy duty	<i>Not E-approved.</i>

## H3 Halogen

	HC-CARGO	Std. pkg.	Voltage	Watt	Length	OD	Colour	Type	Comment
 PK22s	171469	Pkg. 1	6	55	42 mm	11.5 mm		Single filament	
	170070	Pkg. 1	12	55	42 mm	11.5 mm		Single filament	
	171405	Pkg. 1	12	130	39 mm	11.5 mm		Single filament	<i>Not E-approved.</i>
	170836	Pkg. 1	24	70	42 mm	11.5 mm		Single filament, Heavy duty	
	171407	Pkg. 1	48	45	42 mm	11.5 mm			
	171378	Pkg. 1	80	55	42 mm	11.5 mm			
	<b>Jahn</b>	HC-CARGO	Std. pkg.	Voltage	Watt	Length	OD	Colour	Type
 PK22s	170696	Pkg. 1	12	35	42 mm	11.5 mm		Single filament	
	170333	Pkg. 1	12	55	42 mm	11.5 mm		Single filament	
	170412	Pkg. 1	24	70	42 mm	11.5 mm		Single filament, Heavy duty	
	170362	Pkg. 1	24	100	42 mm	11.5 mm		Single filament, Heavy duty	<i>Not E-approved.</i>
 PKY22s	170496	Pkg. 1	12	100	42 mm	11.5 mm		Single filament	<i>Not E-approved.</i>
<b>OSRAM</b>	HC-CARGO	Std. pkg.	Voltage	Watt	Length	OD	Colour	Type	Comment
 PK22s	171687	Pkg. 1	12	55	42 mm	10.8 mm		Nightbreaker	<i>Up to 90% more light. Up to 35 m longer beam. Up to 10% whiter light.</i>

## H4 Halogen

	HC-CARGO	Std. pkg.	Voltage	Watt	Length	OD	Colour	Type	Comment
 P43t	171474	Pkg. 1	6	60/55	78 mm	16 mm			
	171134	Pkg. 1	12	60/55	78 mm	16 mm		Double filament	<i>Gives up to 50% more light.</i>
	171114	Pkg. 1	12	60/55	78 mm	16 mm	Gold	Double filament	<i>Gives better visibility in poor weather. Not approved in Germany.</i>
	171113	Pkg. 1	12	60/55	78 mm	16 mm		Double filament, Longlife	
	171067	Pkg. 1	12	60/55	78 mm	16 mm	Xenon blue	Double filament	<i>Brighter light as standard.</i>
	171066	Pkg. 1	12	60/55	78 mm	16 mm		Double filament	<i>Gives up to 30% more light.</i>
	170768	Pkg. 1	12	60/55	78 mm	16 mm		Double filament	
	171065	Pkg. 1	12	100/80	78 mm	16 mm		Double filament	<i>Not E-approved.</i>
	170803	Pkg. 1	12	100/80	78 mm	16 mm	Xenon blue	Double filament	<i>Brighter light as standard. Not E-approved.</i>
	170513	Pkg. 1	12	130/90	76.4 mm	14.6 mm		Double filament	<i>Not E-approved.</i>
	170514	Pkg. 1	12	165/120	78 mm	16 mm		Double filament	<i>Not E-approved.</i>
	171125	Pkg. 1	24	75/70	78 mm	16 mm		Double filament, Heavy Duty, Heavy duty	
	170792	Pkg. 1	24	75/70	78 mm	16 mm		Double filament, Heavy duty	
170515	Pkg. 1	24	130/90	78 mm	16 mm		Double filament, Heavy duty	<i>Not E-approved.</i>	
 P45t	170071	Pkg. 1	12	60/55	78 mm	16 mm		Double filament	<i>Not E-approved.</i>
 PX43t	171473	Pkg. 1	6	35/35	78 mm	16 mm		HS1	
<b>Jahn</b>	HC-CARGO	Std. pkg.	Voltage	Watt	Length	OD	Colour	Type	Comment
 P43t	170718	Pkg. 1	12	35/35	78 mm	16 mm		Double filament	
	170334	Pkg. 1	12	60/55	78 mm	16 mm		Double filament	
	171064	Pkg. 1	12	60/55	78 mm	16 mm		Double filament, Megalight plus	<i>Gives up to 60% more light.</i>
	170804	Pkg. 1	12	60/55	78 mm	16 mm		Double filament, Megalight	<i>Gives up to 30% more light.</i>
	170802	Pkg. 1	12	60/55	78 mm	16 mm	Xenon blue	Double filament	<i>Brighter light as standard.</i>
	170657	Pkg. 1	12	60/55	78 mm	16 mm		Double filament, Longlife	
	170009	Pkg. 1	12	100/90	78 mm	16 mm		Double filament	<i>Not E-approved.</i>
	170348	Pkg. 1	24	75/70	78 mm	16 mm		Heavy duty	
	170450	Pkg. 1	24	75/70	78 mm	16 mm		Heavy Duty, Heavy duty	
	170360	Pkg. 1	24	100/70	78 mm	16 mm		Heavy duty	<i>Not E-approved.</i>
 P45t	170681	Pkg. 1	12	45/40	78 mm	16 mm			
	170359	Pkg. 1	12	100/80	78 mm	16 mm			<i>Not E-approved.</i>
	170006	Pkg. 1	24	75/70	78 mm	16 mm		Heavy duty	<i>Not E-approved.</i>
<b>OSRAM</b>	HC-CARGO	Std. pkg.	Voltage	Watt	Length	OD	Colour	Type	Comment
 P43t	171688	Pkg. 1	12	60/55	82 mm	13 mm		Double filament, Nightbreaker	<i>Up to 90% more light. Up to 35 m longer beam. Up to 10% whiter light.</i>
MH6 Halogen									
	HC-CARGO	Std. pkg.	Voltage	Watt	Length	OD	Colour	Type	Comment
 PX15d	170811	Pkg. 10	12	30/30	47 mm	20 mm		Bilux, MH6	
	170812	Pkg. 10	12	30/30	55 mm	15 mm		Double filament	

H7 Halogen										
	HC-CARGO	Std. pkg.	Voltage	Watt	Length	OD	Colour	Type	Comment	
 PX26d	172111	Pkg. 1	24	100	58 mm	34 mm		Heavy duty	<i>Not E-approved.</i>	
 PX26d	171077	Pkg. 1	12	55	58 mm	11.6 mm		Single filament		
	171079	Pkg. 1	12	55	58 mm	11.6 mm	Xenon blue	Single filament	<i>Brighter light as standard.</i>	
	171081	Pkg. 1	12	55	58 mm	11.6 mm		Single filament	<i>Gives up to 30% more light.</i>	
	171137	Pkg. 1	12	55	58 mm	11.6 mm		Single filament	<i>Gives up to 50% more light.</i>	
	171117	Pkg. 1	12	55	58 mm	11.6 mm		Single filament, Longlife		
	170837	Pkg. 1	12	100	58 mm	11.6 mm		Single filament	<i>Not E-approved.</i>	
	171532	Pkg. 1	24	70	58 mm	11.6 mm		Longlife, Heavy duty		
	171080	Pkg. 1	24	70	58 mm	11.6 mm		Single filament, Heavy duty		
<b>Jahn</b>	HC-CARGO	Std. pkg.	Voltage	Watt	Length	OD	Colour	Type	Comment	
 PX26d	170720	Pkg. 1	12	55	58 mm	11.6 mm		Single filament		
	170825	Pkg. 1	12	55	58 mm	11.6 mm	Xenon blue	Single filament	<i>Brighter light as standard.</i>	
	170800	Pkg. 1	24	70	58 mm	11.6 mm		Single filament, Heavy duty		
<b>OSRAM</b>	HC-CARGO	Std. pkg.	Voltage	Watt	Length	OD	Colour	Type	Comment	
 PX26d	171689	Pkg. 1	12	55	59 mm	11.4 mm		Nightbreaker	<i>Up to 90% more light. Up to 35 m longer beam. Up to 10% whiter light.</i>	
H13 Halogen										
<b>Jahn</b>	HC-CARGO	Std. pkg.	Voltage	Watt	Length	OD	Colour	Type	Comment	
 P26.4t	171796	Pkg. 1	12	60/55	86 mm	16.1 mm				
H15 Halogen										
<b>OSRAM</b>	HC-CARGO	Std. pkg.	Voltage	Watt	Length	OD	Colour	Type	Comment	
 PGJ23T-1	171691	Pkg. 1	12	15/55	79 mm	13 mm		Double filament		
H6W Halogen										
	HC-CARGO	Std. pkg.	Voltage	Watt	Length	OD	Colour	Type	Comment	
 BAX9s	171082	Pkg. 10	12	6	35 mm	9 mm				
<b>Jahn</b>	HC-CARGO	Std. pkg.	Voltage	Watt	Length	OD	Colour	Type	Comment	
 BAX9s	170741	Pkg. 10	12	6	33 mm	9 mm				



H21W Halogen										
	HC-CARGO	Std. pkg.	Voltage	Watt	Length	OD	Colour	Type	Comment	
 BAY9s	171083	Pkg. 10	12	21	40 mm	10 mm				
	171084	Pkg. 10	24	21	40 mm	10 mm		Heavy duty		
 P26s	171135	Pkg. 10	12	15	36 mm	10 mm		Single filament		
<i>John</i>										
	HC-CARGO	Std. pkg.	Voltage	Watt	Length	OD	Colour	Type	Comment	
 BAY9s	170742	Pkg. 10	12	21	40 mm	10 mm				
HB1 American Types										
<i>John</i>	HC-CARGO	Std. pkg.	Voltage	Watt	Length	OD	Colour	Type	Comment	
 P29t	170692	Pkg. 1	12	65/45	95 mm	16.5 mm		Halogen		
HB3 American Types										
<i>John</i>	HC-CARGO	Std. pkg.	Voltage	Watt	Length	OD	Colour	Type	Comment	
 P20d	170693	Pkg. 1	12	65	78 mm	16 mm		Halogen		
HB3 A American Types										
<i>John</i>	HC-CARGO	Std. pkg.	Voltage	Watt	Length	OD	Colour	Type	Comment	
 P20d	171804	Pkg. 1	12	60	70.9 mm	11.9 mm		Halogen		
HB4 American Types										
<i>John</i>	HC-CARGO	Std. pkg.	Voltage	Watt	Length	OD	Colour	Type	Comment	
 P22d	170694	Pkg. 1	12	55	78 mm	16 mm		Halogen		
HB4 A American Types										
<i>John</i>	HC-CARGO	Std. pkg.	Voltage	Watt	Length	OD	Colour	Type	Comment	
 P22d	171794	Pkg. 1	12	51	80.3 mm	10.7 mm		Halogen		
HB5 American Types										
<i>John</i>	HC-CARGO	Std. pkg.	Voltage	Watt	Length	OD	Colour	Type	Comment	
 PX29t	171039	Pkg. 1	12	65/55	102 mm	17 mm		Halogen		

H8 American Types										
<b>Jahn</b>	HC-CARGO	Std. pkg.	Voltage	Watt	Length	OD	Colour	Type	Comment	
 PGJ19-1	171034	Pkg. 1	12	35	41 mm	11.7 mm		Halogen		
H9 American Types										
<b>Jahn</b>	HC-CARGO	Std. pkg.	Voltage	Watt	Length	OD	Colour	Type	Comment	
 PGJ19-5	171035	Pkg. 1	12	65	41 mm	11.7 mm		Halogen		
H10 American Types										
<b>Jahn</b>	HC-CARGO	Std. pkg.	Voltage	Watt	Length	OD	Colour	Type	Comment	
 PY20d	171036	Pkg. 1	12	42	31.5 mm	12.4 mm		Halogen		
H11 American Types										
<b>CARGO</b>	HC-CARGO	Std. pkg.	Voltage	Watt	Length	OD	Colour	Type	Comment	
 PGJ19-2	172073	Pkg. 1	24	70	44 mm	31.5 mm		Halogen, Heavy duty		
<b>Jahn</b>	HC-CARGO	Std. pkg.	Voltage	Watt	Length	OD	Colour	Type	Comment	
 PGJ19-2	171037	Pkg. 1	12	55	41 mm	11.7 mm		Halogen		
<b>OSRAM</b>	HC-CARGO	Std. pkg.	Voltage	Watt	Length	OD	Colour	Type	Comment	
 PGJ19-2	171690	Pkg. 1	12	55	44 mm	11.4 mm		Halogen, Nightbreaker	<i>Up to 90% more light. Up to 35 m longer beam. Up to 10% whiter light.</i>	
H27W/1 American Types										
<b>Jahn</b>	HC-CARGO	Std. pkg.	Voltage	Watt	Length	OD	Colour	Type	Comment	
 PG13	171009	Pkg. 1	12	27	44.5 mm	10.3 mm		Halogen		
 W2.5x16q	170710	Pkg. 10	12	27/7	53 mm	26.5 mm		3157		
	170711	Pkg. 10	12	27/7	53 mm	26.5 mm	Orange	3157NA		
H27W/2 American Types										
<b>CARGO</b>	HC-CARGO	Std. pkg.	Voltage	Watt	Length	OD	Colour	Type	Comment	
 PGJ13	171953	Pkg. 1	12	50	62.7 mm	12.5 mm		Halogen	<i>Bulb Holder: HC-CARGO 172072.</i>	

<b>John</b>	HC-CARGO	Std. pkg.	Voltage	Watt	Length	OD	Colour	Type	Comment
 PGJ13	171010	Pkg. 1	12	27	44.5 mm	10.3 mm		Halogen	Bulb Holder: HC-CARGO 172072.
	170951	Pkg. 1	12	50	62.7 mm	12.5 mm		Halogen	Bulb Holder: HC-CARGO 172072.
	170726	Pkg. 1	12	37.5	62.7 mm	12.5 mm		Halogen	Bulb Holder: HC-CARGO 172072.
<b>High Intensity Discharge</b>									
<b>OSRAM</b>	HC-CARGO	Std. pkg.	Voltage	Watt	Length	OD	Colour	Type	Comment
 P32d-2	171133	Pkg. 1	85	35	77 mm	13.7 mm	4150K	Xenon, D2S	
	171132	Pkg. 1	85	35	79.7 mm	13.7 mm	4150K	Xenon, D2R	
 P32d-3	171713	Pkg. 1	42	35	77 mm	13.7 mm	4150K	Xenon, D4S	
	171711	Pkg. 1	42	35	79.7 mm	12.4 mm	4150K	Xenon, D4R	
 P32d-5	171710	Pkg. 1	42	35	80 mm	9 mm	4150K	Xenon, D3R	
	171613	Pkg. 1	85	35	82 mm	41x41 mm	4150K	Xenon, D1S	
 PK32d-6	171683	Pkg. 1	85	35	80 mm	13 mm	4150K	Xenon, D1R	
	171712	Pkg. 1	42	35	80 mm	13 mm	4150K	Xenon, D3S	
 PK32d-2	171683	Pkg. 1	85	35	80 mm	13 mm	4150K	Xenon, D1R	
	171712	Pkg. 1	42	35	80 mm	13 mm	4150K	Xenon, D3S	
 PK32d-3	171712	Pkg. 1	42	35	80 mm	13 mm	4150K	Xenon, D3S	
	171712	Pkg. 1	42	35	80 mm	13 mm	4150K	Xenon, D3S	
 PK32d-5	171712	Pkg. 1	42	35	80 mm	13 mm	4150K	Xenon, D3S	
	171712	Pkg. 1	42	35	80 mm	13 mm	4150K	Xenon, D3S	
<b>Stop and Tail Lamps</b>									
<b>CAR GO</b>	HC-CARGO	Std. pkg.	Voltage	Watt	Length	OD	Colour	Type	Comment
 BAY15d	170770	Pkg. 10	12	21/5	52.5 mm	26.5 mm		P21/5W	
	171092	Pkg. 10	24	21/5	50 mm	25 mm		Heavy duty	
 BAZ15d	171093	Pkg. 10	12	21/4	50 mm	25 mm			
	171093	Pkg. 10	12	21/4	50 mm	25 mm			

<b>Jahn</b>	HC-CARGO	Std. pkg.	Voltage	Watt	Length	OD	Colour	Type	Comment
 BAY15d	171476	Pkg. 10	6	21/5	52.5 mm	26.5 mm			
	170336	Pkg. 10	12	21/5	52.5 mm	26.5 mm		P21/5W	
	170659	Pkg. 10	12	21/5	52.5 mm	26.5 mm		P21/5W, Longlife	
 BAZ15d	170452	Pkg. 10	24	21/5	52.5 mm	26.5 mm		Heavy duty	
	170644	Pkg. 10	12	21/4	52.5 mm	26.5 mm			
 BAZ15d	170850	Pkg. 10	24	21/4	52.5 mm	26.5 mm		Heavy duty	
	170776	Pkg. 10	12	21/5	44 mm	20 mm			
 T20									

**Stop and Flasher - Position**

<b>CAR GO</b>	HC-CARGO	Std. pkg.	Voltage	Watt	Length	OD	Colour	Type	Comment
 BA15d	171998	Pkg. 10	6	15	45 mm	26.5 mm			
	171989	Pkg. 10	12	20	45 mm	26.5 mm			
	172033	Pkg. 10	12	20/5	52.5 mm	22.5 mm			
	171994	Pkg. 10	12	20/5	52.2 mm	22.5 mm			
	171088	Pkg. 10	24	15	43 mm	23 mm		Heavy duty	
	171982	Pkg. 10	24	20	45 mm	26.5 mm		Heavy duty	
 BA15S	171995	Pkg. 10	6	20	45 mm	26.5 mm			
	171984	Pkg. 10	6	21	52.5 mm	26.5 mm			
	171992	Pkg. 10	12	10	35 mm	19 mm		Longlife	
	170772	Pkg. 10	12	10	35 mm	18 mm			
	171990	Pkg. 10	12	15	35 mm	19 mm			
	171988	Pkg. 10	12	18	45 mm	26.5 mm			
	171979	Pkg. 10	12	21	52.5 mm	26.5 mm		P21W, Longlife	
	171091	Pkg. 10	12	21	50 mm	25 mm	Orange		Not E-approved.
	170769	Pkg. 10	12	21	52.5 mm	26.5 mm		P21W	
	171076	Pkg. 10	24	10	35 mm	18 mm		Heavy duty	
	170793	Pkg. 10	24	10	35 mm	18 mm		Heavy duty	
	171997	Pkg. 10	24	15	35 mm	19 mm		Heavy duty	
	171086	Pkg. 1	24	15	43 mm	23 mm		Heavy duty	
	171996	Pkg. 10	24	18	45 mm	26.5 mm		Heavy duty	
	171078	Pkg. 10	24	21	52.5 mm	26.5 mm		Heavy duty	
170826	Pkg. 10	24	21	52.5 mm	26.5 mm		Heavy duty		
171986	Pkg. 10	24	25	45 mm	26.5 mm		Heavy duty		
 BAU15s	171371	Pkg. 1	12	21	50 mm	25 mm	Silver/ amber		
	171089	Pkg. 10	12	21	50 mm	25 mm	Orange		
	171090	Pkg. 10	24	21	50 mm	25 mm	Orange	Heavy duty	
 T13	171390	Pkg. 10	12	10	30 mm	13 mm			
 T15	171402	Pkg. 10	12	10	36 mm	15 mm			
	171403	Pkg. 10	12	21	36 mm	15 mm			
<b>Jahn</b>	HC-CARGO	Std. pkg.	Voltage	Watt	Length	OD	Colour	Type	Comment
 BA15d	170583	Pkg. 10	12	15	45 mm	26.5 mm			

<b>John</b>	HC-CARGO	Std. pkg.	Voltage	Watt	Length	OD	Colour	Type	Comment
 BA15S	170335	Pkg. 10	12	21	52.5 mm	26.5 mm		P21W	
	170658	Pkg. 10	12	21	52.5 mm	26.5 mm		P21W, Longlife	
	170454	Pkg. 10	24	10	35 mm	15 mm		Heavy duty	
	170351	Pkg. 10	24	10	35 mm	19 mm		R10W, Heavy duty	
	170349	Pkg. 10	24	21	52.5 mm	26.5 mm		P21W, Heavy duty	
	170451	Pkg. 10	24	21	52.5 mm	26.5 mm		Heavy duty	
	170614	Pkg. 10	24	25	45 mm	26.5 mm		Heavy duty	
 BAU15s	170648	Pkg. 10	12	21	52.5 mm	26.5 mm	Orange	PY21W	
	170849	Pkg. 10	24	21	52.5 mm	26.5 mm	Orange	Heavy duty	
 T16	170813	Pkg. 10	12	16	37 mm	15 mm			
 T20	171398	Pkg. 10	12	21	44 mm	20 mm	Orange		
	170777	Pkg. 10	12	21	44 mm	20 mm			

### Parking and Flasher - Position

<b>CAR GO</b>	HC-CARGO	Std. pkg.	Voltage	Watt	Length	OD	Colour	Type	Comment
 BA15d	171102	Pkg. 10	24	5	35 mm	18.5 mm		Heavy duty	
	171981	Pkg. 10	6	5	35 mm	18.5 mm			
 BA15S	171993	Pkg. 10	6	10	35 mm	18.5 mm			
	171983	Pkg. 10	6	18	45 mm	26.5 mm			
	171980	Pkg. 10	12	5	35 mm	18.5 mm		Longlife	
	170773	Pkg. 10	12	5	35 mm	18.5 mm			
	171118	Pkg. 10	24	5	35 mm	18.5 mm		Heavy duty	
	170794	Pkg. 10	24	5	35 mm	18.5 mm		Heavy duty	
 BA7s	171119	Pkg. 10	12	2	19 mm	6.8 mm			
 BA9s	171490	Pkg. 10	6	3	27.4 mm	8.6 mm			
	171103	Pkg. 10	12	2	23 mm	8.6 mm			
	170822	Pkg. 10	12	4	27.4 mm	8.6 mm	Xenon blue		<i>Brighter light as standard.</i>
	170774	Pkg. 10	12	4	27.4 mm	8.6 mm			
	170796	Pkg. 10	24	2	23 mm	8.6 mm		Heavy duty	
	170795	Pkg. 10	24	4	27.4 mm	8.6 mm		Heavy duty	
 T15	171401	Pkg. 10	12	5	36 mm	15 mm			





<b>John</b>	HC-CARGO	Std. pkg.	Voltage	Watt	Length	OD	Colour	Type	Comment
 BA15d	170593	Pkg. 10	12	5	35 mm	18.5 mm			

<b>Jahn</b>	HC-CARGO	Std. pkg.	Voltage	Watt	Length	OD	Colour	Type	Comment
 BA15S	171480	Pkg. 10	6	10	35 mm	18.5 mm			
	171472	Pkg. 10	6	18	45 mm	26.5 mm			
	170340	Pkg. 10	12	5	35 mm	18.5 mm		R5W	
	170339	Pkg. 10	12	10	35 mm	19 mm			
	170455	Pkg. 10	24	5	35 mm	18.5 mm		Heavy duty	
	170413	Pkg. 10	24	5	35 mm	18.5 mm		R5W, Heavy duty	
 BA7s	170448	Pkg. 10	12	2	20.7 mm	6.8 mm			
	170456	Pkg. 10	24	3	20.7 mm	6.8 mm		Heavy duty	
 BA9s	171491	Pkg. 10	6	2	27.4 mm	8.6 mm			
	171492	Pkg. 10	6	4	27.4 mm	8.6 mm			
	170345	Pkg. 10	12	2	23 mm	8.6 mm			
	170594	Pkg. 10	12	3	23 mm	8.6 mm			
	170346	Pkg. 10	12	4	27.4 mm	8.6 mm		T4W	
	170416	Pkg. 10	24	2	23 mm	8.6 mm		T2W, Heavy duty	
	170417	Pkg. 10	24	4	27.4 mm	8.6 mm		T4W, Heavy duty	

**Wedge Base**

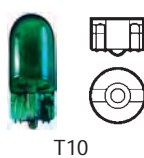
<b>HC-CAR GO</b>	HC-CARGO	Std. pkg.	Voltage	Watt	Length	OD	Colour	Type	Comment
 T10	171121	Pkg. 10	12	2	26 mm	10 mm			
	171104	Pkg. 10	12	3	26 mm	10 mm			
	171123	Pkg. 10	12	5	26 mm	10 mm	Orange		
	171122	Pkg. 10	12	5	26 mm	10 mm	Blue		
	171105	Pkg. 10	12	5	26 mm	10 mm			
	170948	Pkg. 10	12	5	26 mm	10.3 mm	Xenon blue		Brighter light as standard.
	170810	Pkg. 10	12	8	26 mm	10 mm			
	171106	Pkg. 10	24	3	26 mm	10 mm		Heavy duty	
 T5	171107	Pkg. 10	24	5	26 mm	10 mm		Heavy duty	
	170775	Pkg. 10	12	1.2	20 mm	5 mm			
	171108	Pkg. 10	24	1.2	20 mm	5 mm		Heavy duty	
 T7	171391	Pkg. 10	12	3	20 mm	7 mm			

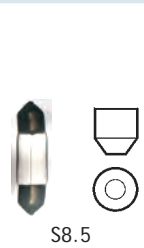
<b>Jahn</b>	HC-CARGO	Std. pkg.	Voltage	Watt	Length	OD	Colour	Type	Comment
 T10	170725	Pkg. 10	12	2	26.7 mm	10.3 mm			
	170779	Pkg. 10	12	3	26.7 mm	10.3 mm	Green	W3W	
	170778	Pkg. 10	12	3	26.7 mm	10.3 mm	Orange	W3W	
	170781	Pkg. 10	12	3	26.7 mm	10.3 mm	Red	W3W	
	170780	Pkg. 10	12	3	26.7 mm	10.3 mm	Blue	W3W	
	170331	Pkg. 10	12	3	26.7 mm	10.3 mm		W3W	
	170754	Pkg. 10	12	5	26.7 mm	10.3 mm	Orange	WY5W	
	170347	Pkg. 10	12	5	26.7 mm	10.3 mm		W5W	
	170662	Pkg. 10	12	5	26.7 mm	10.3 mm		W5W, Longlife	
	171027	Pkg. 10	24	2	26.7 mm	10.3 mm		Heavy duty	
	170808	Pkg. 10	24	3	26.7 mm	10.3 mm	Red	W3W, Heavy duty	
	170807	Pkg. 10	24	3	26.7 mm	10.3 mm	Blue	W3W, Heavy duty	
	170806	Pkg. 10	24	3	26.7 mm	10.3 mm	Green	W3W, Heavy duty	

<b>Jahn</b>	HC-CARGO	Std. pkg.	Voltage	Watt	Length	OD	Colour	Type	Comment
 T10	170805	Pkg. 10	24	3	26.7 mm	10.3 mm	Orange	W3W, Heavy duty	
	170476	Pkg. 10	24	3	26.7 mm	10.3 mm		W3W, Heavy duty	
	170542	Pkg. 10	24	5	26.7 mm	10.3 mm		W5W, Heavy duty	
 T5	171283	Pkg. 10	12	2	20 mm	5 mm			
	170617	Pkg. 10	12	1.2	20 mm	5 mm	Frosted		
	170410	Pkg. 10	12	1.2	20 mm	5 mm			
	170684	Pkg. 10	24	0.7	20 mm	5 mm			
	170477	Pkg. 10	24	1.2	20 mm	5 mm		Heavy duty	
<b>Wedge Base - Covers</b>									
<b>Jahn</b>	HC-CARGO	Std. pkg.	Voltage	Watt	Length	OD	Colour	Type	Comment
	170732	Pkg. 25			13.1 mm	9.6 mm	Green		
	171129	Pkg. 10			10.5 mm	7 mm	Green		Not E-approved.
	170731				13.1 mm	9.6 mm	Blue		
	171128				11 mm	6.5 mm	Blue		Not E-approved.
<b>Festoon</b>									
<b>CARGO</b>	HC-CARGO	Std. pkg.	Voltage	Watt	Length	OD	Colour	Type	Comment
 S8.5	171487	Pkg. 10	6	10	36 mm	10.5 mm			
	171097	Pkg. 10	12	5	41 mm	10.5 mm			
	171094	Pkg. 10	12	5	36 mm	10.5 mm			
	171098	Pkg. 10	12	10	41 mm	10.5 mm			
	171095	Pkg. 10	12	10	36 mm	10.5 mm			
	171120	Pkg. 10	12	21	41 mm	15 mm			
	171099	Pkg. 10	24	5	41 mm	10.5 mm		Heavy duty	
	171096	Pkg. 10	24	5	36 mm	10.5 mm		Heavy duty	
	171100	Pkg. 10	24	10	41 mm	10.5 mm		Heavy duty	
<b>Jahn</b>	HC-CARGO	Std. pkg.	Voltage	Watt	Length	OD	Colour	Type	Comment
 S6	170591	Pkg. 10	12	3	33 mm	8.5 mm			
	170590	Pkg. 10	12	3	28 mm	8 mm			
 S8.5	171484	Pkg. 10	6	5	36 mm	10.5 mm			
	171479	Pkg. 10	6	18	41 mm	15 mm			
	170343	Pkg. 10	12	5	41 mm	10.5 mm			
	170341	Pkg. 10	12	5	36 mm	10.5 mm		C5W	
	170411	Pkg. 10	12	10	36 mm	10.5 mm			





<b>Jahn</b>		HC-CARGO	Std. pkg.	Voltage	Watt	Length	OD	Colour	Type	Comment
 S8.5	170344	Pkg. 10	12	10	41 mm	10.5 mm				
	170005	Pkg. 10	12	10	28 mm	10 mm				
	170342	Pkg. 10	12	15	41 mm	15 mm				
	170588	Pkg. 10	12	18	41 mm	15 mm				
	171139	Pkg. 10	12	21	41 mm	15 mm				
	170414	Pkg. 10	24	5	36 mm	10.5 mm			C5W, Heavy duty	
	170592	Pkg. 10	24	15	41 mm	15 mm			Heavy duty	
	170589	Pkg. 10	24	18	41 mm	15 mm			Heavy duty	

**Conventional**

<b>CAR GO</b>		HC-CARGO	Std. pkg.	Voltage	Watt	Length	OD	Colour	Type	Comment
 BA15S	171991	Pkg. 10	12	45	53 mm	36 mm				<i>For US and UK systems.</i>
	171978	Pkg. 1	24	45	53 mm	36 mm			Heavy duty	<i>For US and UK systems.</i>
 BA20d	171977	Pkg. 1	6	35/35	70 mm	36 mm				
	171985	Pkg. 1	12	25/25	70 mm	36 mm				
	171975	Pkg. 1	12	35/35	70 mm	36 mm				
	171974	Pkg. 1	12	45/40	70 mm	36 mm				
	171976	Pkg. 1	24	45/40	70 mm	36 mm			Heavy duty	
 P45t	170771	Pkg. 1	12	45/40	77 mm	41 mm			Bilux	
 PG20/4	171869	Pkg. 1	12	24	47.75 mm	18.5 mm	Orange			<i>300 lm.</i>
 PGU20/4	172074	Pkg. 1	12	24	46.55 mm	18.5 mm	Orange			

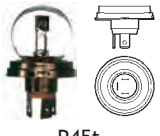
<b>Jahn</b>		HC-CARGO	Std. pkg.	Voltage	Watt	Length	OD	Colour	Type	Comment
 BA15S	170577	Pkg. 10	12	45	53 mm	36 mm				<i>For US and UK systems.</i>
	171531	Pkg. 1	6	35/35	70 mm	36 mm				
 BA20d	170575	Pkg. 1	12	35	66 mm	36 mm				
	170579	Pkg. 1	12	50	66 mm	36 mm				<i>For German and Italian systems.</i>
 BA20s	170816	Pkg. 10	12	15	46 mm	25.5 mm				
	170816	Pkg. 10	12	15	46 mm	25.5 mm				
 P26s	170816	Pkg. 10	12	15	46 mm	25.5 mm				

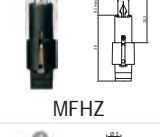
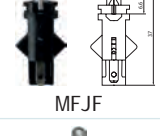

<b>Jahn</b>	HC-CARGO	Std. pkg.	Voltage	Watt	Length	OD	Colour	Type	Comment
 P45t	171477	Pkg. 1	6	45/40	77 mm	41 mm		Bilux	
	170338	Pkg. 1	12	45/40	77 mm	41 mm		Bilux	
	170350	Pkg. 1	24	55/50	77 mm	41 mm		Bilux, Heavy duty	
<b>Instrument Panel</b>									
	HC-CARGO	Std. pkg.	Voltage	Watt	Length	OD	Colour	Socket colour	Comment
 B8.4d	171110	Pkg. 10	12	2	17.5 mm	5 mm		Light green	
	171381	Pkg. 10	12	1.2	17.5 mm	5 mm		Blue	
	171109	Pkg. 10	12	1.2	17.5 mm	5 mm		Black	
	171023	Pkg. 10	12	1.5	17.5 mm	5 mm		Beige	
 B8.5d	171379	Pkg. 10	12	1	21 mm	5 mm		Orange	
	171024	Pkg. 10	12	1.2	21 mm	5 mm		Blue	
	171383	Pkg. 10	12	1.5	21 mm	5 mm		Beige	
	171380	Pkg. 10	12	0.36	21 mm	5 mm		Purple	
	171028	Pkg. 10	24	1.2	21 mm	5 mm		Brown	Heavy duty.
 B8.7d	171455	Pkg. 10	12	2	16.5 mm	5 mm		Green	
 BX2d	171284	Pkg. 10	12	1.2	21.5 mm	5 mm		Black	
 EBSN10	171377	Pkg. 10	24	1.2	20 mm	6 mm		Beige	Alba- type, Heavy duty.
 EBSR11	171031	Pkg. 10	12	1.2	20 mm	5 mm		Green	Alba- type.
	170698	Pkg. 10	12	1.8	20 mm	5 mm		Blue	Alba- type.
	171026	Pkg. 10	24	1.2	21 mm	5 mm		Brown	Alba- type.
	171025	Pkg. 10	24	1.2	21 mm	5 mm		Yellow	Alba- type.
	171032	Pkg. 10	24	1.4	21 mm	5 mm		Green	Alba- type.
 F4.8	171112	Pkg. 10	14	1.2	13 mm	4.8 mm		Black	
 MFHZ	171382	Pkg. 10	12	1.2	38 mm	5 mm		Black	
 MFJF	171837	Pkg. 10	12	2	35 mm	5 mm		Black	
	171384	Pkg. 10	12	1.2	35 mm	5 mm		Black	
 T-1/4	170364	Pkg. 10	14	1.12	10.5 mm	4 mm			
 T-1/4NW	170762	Pkg. 10	14	0.8	9 mm	3.4 mm		Dark grey	
	171389	Pkg. 10	14	1.4	11 mm	3.5 mm		Black	

	HC-CARGO	Std. pkg.	Voltage	Watt	Length	OD	Colour	Socket colour	Comment
T-3/4	170972	Pkg. 10	12	0.6	6.5 mm	2.5 mm			Used as locating light bulbs in switches on Japanese vehicles.
T5	171388	Pkg. 10	12	0.4	20 mm	5 mm	Frosted	Grey	
	171029	Pkg. 10	24	1.2	20 mm	5 mm		White	
T7	171111	Pkg. 10	14	2	23 mm	7 mm		Pink	
<b>Jahn</b>	HC-CARGO	Std. pkg.	Voltage	Watt	Length	OD	Colour	Socket colour	Comment
B8.3d	170611	Pkg. 10	12	2	23.5 mm	5 mm		White	
	170612	Pkg. 10	12	1.2	23.5 mm	5 mm		Black	
	170613	Pkg. 10	24	1.2	23.5 mm	5 mm		Grey	Heavy duty.
B8.4d	170756	Pkg. 10	12	2	17.5 mm	5 mm		Light green	
	170727	Pkg. 10	12	1.2	17.5 mm	5 mm		Black	
	171033	Pkg. 10	12	1.12	17.5 mm	5 mm		Orange	
B8.5d	170610	Pkg. 10	12	2	23.5 mm	5 mm		Green	
	170357	Pkg. 10	12	1.2	23.5 mm	5 mm		Black	
	170358		24	1.2	23.5 mm	5 mm		Grey	Not E-approved. Heavy duty.
B8.7d	170545	Pkg. 10	12	1.2	23.5 mm	5 mm		Grey	
F4.8	170753	Pkg. 10	14	1.4	12 mm	5 mm		Black	
T5	170755	Pkg. 10	12	0.5	19.5 mm	5 mm		Grey	
	170785	Pkg. 10	12	1.2	20 mm	5 mm		Red	
	170784	Pkg. 10	12	1.2	20 mm	5 mm		Blue	
	170783	Pkg. 10	12	1.2	20 mm	5 mm		Green	
	170782	Pkg. 10	12	1.2	20 mm	5 mm		Orange	
	170758	Pkg. 10	12	1.2	20 mm	5 mm		White	
T7	170757	Pkg. 10	14	2	23.5 mm	5 mm		White	
<b>Halogen</b>									
	HC-CARGO	Std. pkg.	Voltage	Watt	Length	OD	Colour	Type	Comment
BA15S	171987	Pkg. 10	12	10	37.5 mm	10 mm			

	HC-CARGO	Std. pkg.	Voltage	Watt	Length	OD	Colour	Type	Comment
 BA9s	170470	Pkg. 10	12	5	33 mm	9 mm			
	170502	Pkg. 1	12	12	33 mm	9 mm			
	170380	Pkg. 10	12	20	35 mm	9 mm			
 G4	171425	Pkg. 10	12	5	30 mm	8 mm			
	170712	Pkg. 10	12	10	30 mm	8 mm			
	170749	Pkg. 10	12	20	30 mm	8 mm			
	170848	Pkg. 10	24	10	30 mm	8 mm			
	170750	Pkg. 10	24	20	30 mm	8 mm			
 T10	171124	Pkg. 10	12	5	33 mm	9 mm			
	HC-CARGO	Std. pkg.	Voltage	Watt	Length	OD	Colour	Type	Comment
 B10d	170751	Pkg. 10	12	3	27.8 mm	8.8 mm	Brown		
	170752	Pkg. 10	12	5	27.8 mm	8.8 mm	Black		
 BA15S	170839	Pkg. 10	12	10	37.5 mm	10 mm			
Electric Vehicles and Forklifts									
	HC-CARGO	Std. pkg.	Voltage	Watt	Length	OD	Colour	Type	Comment
 BA15S	171410	Pkg. 10	48	10	35 mm	16 mm			
	171408	Pkg. 10	48	25	50 mm	25 mm			
 BAY15d	171411	Pkg. 10	48	25/10	50 mm	25 mm			
 PK22s	171407	Pkg. 1	48	45	42 mm	11.5 mm		Halogen, H3	
	171378	Pkg. 1	80	55	42 mm	11.5 mm		Halogen, H3	
Flash and Penlight									
	HC-CARGO	Std. pkg.	Voltage	Watt	Length	OD	Colour	Type	Comment
 E10	170509	Pkg. 10	12	3	24 mm	11.5 mm			
 P13.5s	171280	Pkg. 10	48	3.6	30 mm	11 mm		Krypton	

## Spare Lamp Kits

### For Cars

**Jahn**



171040



171042



171043

Dimensions: 90 x 90 x 57 mm.

Contains:

HC-CARGO	TYPE	Jahn Ref. No.	Description	H4 171040	H7 171042	H1/H7 171043
170804	H4	1134	12 V. 60/55 W. P43t.	1		
170332	H1	1111	12 V. 55 W. P14.5s.		1	
170720	H7	1117	12 V. 55 W. PX 26d.		1	1
170335	P12W	1321	12 V. 21 W. BAY15s.	1	1	1
170336	P21/5W	1341	12 V. 21/5W. BAY15d.	1	1	1
170648	PY21W	1383	12 V. 21W. BAU15s.		1	1
170347	W5W	1621	12 V. 5 W. W2.1 x 9.5d.		1	1
170340	R5W	1401	12 V. 5 W. BA15s.	1	1	
170341	C5W	1711	12 V. 5 W. SV8.5.		1	1
170346	T4W	1501	12 V. 5 W. SV8.5.	1		
190057	ATO blade fuse		10 Amp. Red.	1	1	1
190058	ATO blade fuse		15 Amp. Blue.	1	1	1
190059	ATO blade fuse		20 Amp. Yellow.	1	1	1

### For Trucks and Buses

**Jahn**

Contains:

HC-CARGO	TYPE	Jahn Ref. No.	Description	H4 171044
170348	H4	1102	24 V. 75/70W P43t.	2
170417	T4W	1502	24 V. 4 W. BA9s.	2
170413	R5W	1402	24 V. 5 W. BA15s.	1
170351	R10W	1412	24 V. 10 W. BA15s.	1
170349	P21W	1322	24 V. 21 W. BA15s.	4
170416	T2W	1512	24 V. 2 W. BA9s.	2
170475	Fest. T10.5	1732	24 V. 10 W. SV8.5.	1
170414	C5W	1712	24 V. 5 W. SV8.5.	1
190057	ATO blade fuse		10 Amp. Red.	1
190058	ATO blade fuse		15 Amp. Blue.	1
190059	ATO blade fuse		20 Amp. Yellow.	1
190060	ATO blade fuse		25 Amp. Natural.	1



171044

Dimensions: 210 x 95 x 60 mm.



# Assortments

Edition 2016/2017

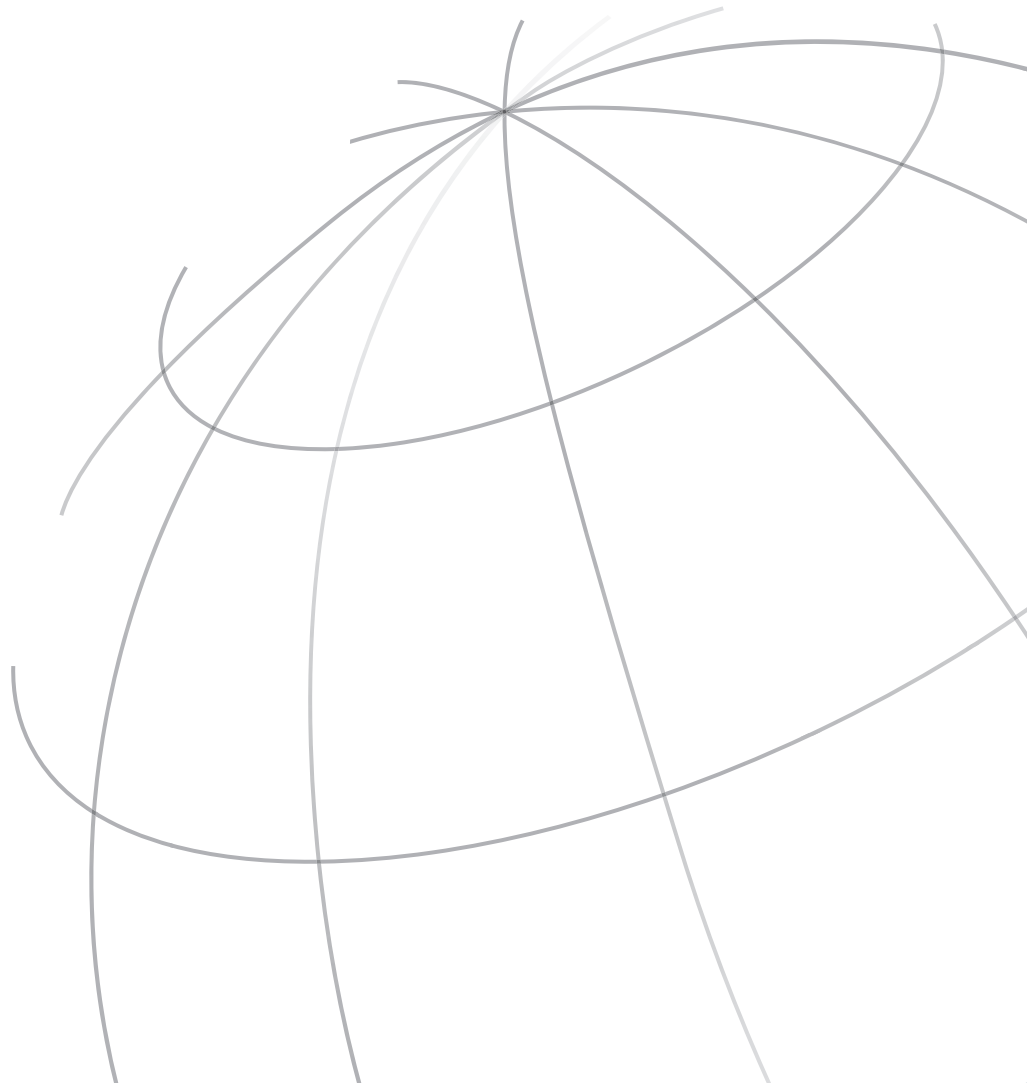

### Festoon Bulbs 12 V

809002

	Qty.
170005 .....	20
170344 .....	20
170343 .....	20
170341 .....	20
170411 .....	20
170588 .....	20
170590 .....	20
170591 .....	20



### Wedge-Base Bulbs 12 V - I

809003

	Qty.
170331 .....	20
170347 .....	20
170357 .....	20
170410 .....	20
170545 .....	20
170610 .....	10
170612 .....	10
170611 .....	10
170617 .....	10
170698 .....	10
170364 .....	20



### Wedge-Base Bulbs 12 V - II

809005

	Qty.		Qty.
170410 .....	10	170698 .....	5
170727 .....	5	170757 .....	5
170617 .....	10	170762 .....	5
170611 .....	10	170732 .....	10
170758 .....	5	170755 .....	5
170756 .....	5	170347 .....	10
170357 .....	10	170331 .....	10
170545 .....	10	170364 .....	10
170610 .....	10	170731 .....	10
170753 .....	5	170751 .....	5
170612 .....	10		
170752 .....	5		
170754 .....	5		
170972 .....	10		



### Wedge-base Bulbs 12 V - III

809009

	Qty.		Qty.
171379 .....	10	171033 .....	10
171380 .....	10	171391 .....	10
171381 .....	10	170545 .....	10
171382 .....	10		
171383 .....	10		
171384 .....	10		
171455 .....	10		
171024 .....	10		
171388 .....	10		
171023 .....	10		
171389 .....	10		
171284 .....	10		
171031 .....	10		



## Wedge-Base Bulbs 24 V

809004

	Qty.
170358 ..... Bulb .....	10
170476 ..... Bulb .....	10
170477 ..... Bulb .....	10
170542 ..... Bulb .....	10
170613 ..... Bulb .....	10
170684 ..... Bulb .....	10
170805 ..... Bulb .....	10
171026 ..... Bulb .....	10
170806 ..... Bulb .....	10
170807 ..... Bulb .....	10
170808 ..... Bulb .....	10
171025 ..... Bulb .....	20
171027 ..... Bulb .....	10
171028 ..... Bulb .....	10

	Qty.
171029 ..... Bulb .....	10
171032 ..... Bulb .....	10









# Electrical Components

Edition 2016/2017



## CAMERA & PARKING SENSORS

### CCTV REAR OBSERVATION SYSTEM

#### 160775 Rear Observation Kit Std pkg 1

Kit consisting of 1x7" monitor w/ quad: HC-CARGO 160776. 1x colour camera w/ audio: HC-CARGO 161038. 1x20 m extension cable: HC-CARGO 160611. Accessories: HC-CARGO 160610, 160612, 160613, 160672, 160880, 160993.



Voltage: 12/24

Extension cable: 20 m  
Height: 140 mm  
Depth: 50.8 mm  
Display size: 7"  
Width: 191 mm  
Wide angle: 60°

Monitor: LED  
Type: Camera kit  
Camera type: Colour  
Accessories: DVD  
No./cameras: 4+1  
Audio: Yes  
Extra camera: w/  
Infrared: w/  
Split screen: Yes  
Language: English

#### 160783 Rear Observation Kit Std pkg 1

Kit consisting of 1x7" monitor: HC-CARGO 160784. 1x colour camera: HC-CARGO 161038. 1x20 m extension cable: HC-CARGO 160611. Accessories: HC-CARGO 160610, 160612, 160613, 160672, 160880.



Voltage: 12/24

Extension cable: 20 m  
Height: 140 mm  
Depth: 50.8 mm  
Display size: 7"  
Width: 191 mm  
Wide angle: 60°

Monitor: LED  
Type: Camera kit  
Camera type: Colour  
Accessories: DVD  
No./cameras: 3+1  
Remote control: w/o  
Audio: Yes  
Extra camera: w/  
Infrared: w/  
Split screen: Yes  
Language: English

#### 160793 Rear View Mirror Monitor kit Std pkg 1

w/o camera and extension cable. Camera: HC-CARGO 160610, 160880, 161038. Extension cables use: HC-CARGO 160611, 160612, 160613, 160672.



Voltage: 12/24

Display size: 4.3"

Camera type: Colour  
Accessories: DVD  
Audio: Yes

#### 160994 Rear Observation Kit Std pkg 1

Consists: 1x7" monitor w/ remote control: HC-CARGO 160995. 1x colour camera: HC-CARGO 161043. 1x20 m extension cable: HC-CARGO 160888. Accessories: HC-CARGO 160889, 160916, 160972, 161006, 161028, 161029, 161030, 161040, 161041, 161047, 161056, 161057.



Voltage: 12-24

Extension cable: 20 m  
Display size: 7"  
Wide angle: 120°

Monitor: TFT-LCD  
Type: Camera kit  
Camera type: Colour  
No./cameras: max. 2  
Remote control: w/  
Audio: Yes  
Infrared: w/  
Language: Chinese, German, English, French, Dutch, Italian, Japanese, Portuguese, Spanish  
Alternativ no.: 161046

#### 160996 Rear Observation Kit Std pkg 1

Consists: 1x5" monitor w/ remote control: HC-CARGO 161040. 1x colour camera: HC-CARGO 161043. 1x20 m extension cable: HC-CARGO 160888. Accessories: HC-CARGO 160889, 160916, 160972, 161028, 160997.



Voltage: 12-24

Extension cable: 20 m  
Display size: 5"  
Wide angle: 120°

Monitor: TFT-LCD  
Type: Camera kit  
Camera type: Colour  
No./cameras: max. 2  
Remote control: w/  
Audio: Yes  
Infrared: w/  
Language: Chinese, German, English, French, Dutch, Italian, Japanese, Portuguese, Spanish  
Alternativ no.: 161039

#### 161005 Rear Observation Kit Std pkg 1

Colour Camera: HC-CARGO 161028.



Voltage: 12

Display size: 3.5"  
Wide angle: 170°

Monitor: TFT-LCD  
Type: Camera kit  
Camera type: Colour - Wireless  
No./cameras: 1  
Audio: No  
Infrared: w/o  
Language: Chinese, German, English, French, Dutch, Italian, Japanese, Portuguese, Spanish

**161007** Rear Observation Kit, Waterproof Std pkg 1

Side Camera: HC-CARGO 161030, 161056, 161057. Colour camera: HC-CARGO 161041, 161029, 161006, 161043, 161028.



Voltage: 12-24

Display size: 7"  
Wide angle: 120°

Monitor: TFT-LCD  
Type: Camera kit  
Camera type: Colour  
No./cameras: Max. 2  
Remote control: w/  
Audio: Yes  
Infrared: w/  
Tightness norm: IP 67  
Language: Chinese, German, English, French, Dutch, Italian, Japanese, Portuguese, Spanish

**161027** Rear Observation Kit Std pkg 1

Consists: 1x7" monitor: HC-CARGO 161034. 1x colour camera: HC-CARGO 161028. 1x10 m extension cable: HC-CARGO 160889.

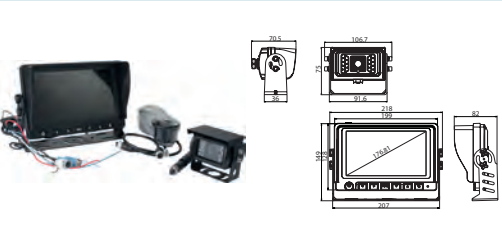

Voltage: 12-24

Extension cable: 10 m  
Display size: 7"  
Wide angle: 130°

Monitor: TFT-LCD  
Type: Camera kit  
Camera type: Colour  
No./cameras: max. 2  
Audio: No  
Infrared: w/  
Language: Chinese, German, English, French, Dutch, Italian, Portuguese, Spanish, Danish, Russian, Polish  
Alternativ no.: 161046

**161039** Rear Observation Kit Std pkg 1

Monitor Mounting, w/suction Cup: HC-CARGO 161044. Consists: 1x5" monitor: HC-CARGO 161040. 1x colour camera: HC-CARGO 161043. 1x20 m extension cable: HC-CARGO 160888. Accessories: HC-CARGO 160889, 160995, 161006, 161029, 161030, 161041, 161047, 161056, 161057.



Voltage: 12-24

Extension cable: 20 m  
Display size: 5"  
Wide angle: 130°

Monitor: TFT-LCD  
Type: Camera kit  
Camera type: Colour  
No./cameras: max. 2  
Remote control: w/  
Audio: Yes  
Infrared: w/  
Split screen: No  
Language: Chinese, German, English, French, Dutch, Italian, Portuguese, Spanish, Danish, Russian, Polish

**161046** Rear Observation Kit Std pkg 1

Monitor Mounting, w/suction Cup: HC-CARGO 161044. Consists: 1x7" monitor: HC-CARGO 161047. 1x colour camera: HC-CARGO 161043. 1x15 m extension cable. Accessories: HC-CARGO 160888, 160889, 160995, 161006, 161029, 161030, 161040, 161041, 161056, 161057.

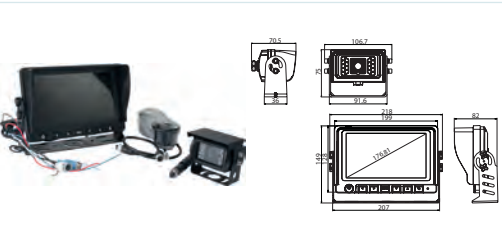

Voltage: 12-24

Extension cable: 15 m  
Display size: 7"  
Wide angle: 130°

Monitor: TFT-LCD  
Type: Camera kit  
Camera type: Colour  
No./cameras: max. 2  
Audio: Yes  
Infrared: w/  
Language: Chinese, German, English, French, Dutch, Italian, Portuguese, Spanish, Danish, Russian, Polish

**161048** Rear Observation Kit Std pkg 1

Monitor Mounting, w/suction Cup: HC-CARGO 161044. Consists: 1x7" monitor: HC-CARGO 161049. 2x colour camera: HC-CARGO 161050. Accessories: HC-CARGO 161036.

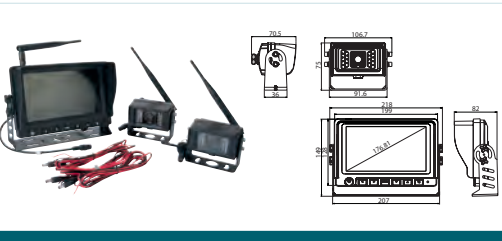

Voltage: 12-24

Display size: 7"  
Wide angle: 130°

Monitor: TFT-LCD  
Type: Camera kit  
Camera type: Colour - Wireless  
No./cameras: 2  
Audio: Yes  
Infrared: w/  
Split screen: Yes  
Language: English

**161051** Rear Observation Kit Std pkg 1

Monitor Mounting, w/suction Cup: HC-CARGO 161044. Consists: 1x7" monitor: HC-CARGO 161052. 1x colour camera: HC-CARGO 161043. 1x20 m extension cable: HC-CARGO 160888. Accessories: HC-CARGO 160889, 161006, 161029, 161030, 161041, 161053, 161056, 161057.



Voltage: 12-24

Extension cable: 20 m  
Display size: 7"  
Wide angle: 120°

Monitor: TFT-LCD  
Type: Camera kit  
Camera type: Colour  
No./cameras: max. 4  
Remote control: w/  
Audio: Yes  
Infrared: w/  
Split screen: Yes  
Tightness norm: IP 69K (Camera)  
Language: Chinese, German, English, French, Dutch, Italian, Spanish, Danish, Russian, Polish

**161054 Rear Observation Kit** Std pkg 1

Monitor Mounting, w/suction Cup: HC-CARGO 161044. Aerial: HC-CARGO 161036. Consists: 1x5" monitor: HC-CARGO 161055. 2x colour camera: HC-CARGO 161058.

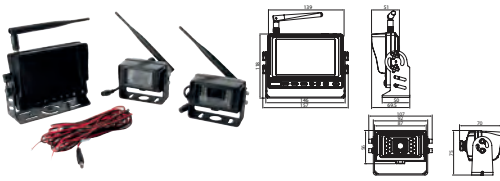

Voltage: 12-24

 Height: 118 mm  
 Depth: 69.5 mm  
 Display size: 5"  
 Width: 139 mm  
 Wide angle: 120°

 Monitor: TFT-LCD  
 Type: Camera kit  
 Camera type: Colour - Wireless  
 No./cameras: 2  
 Audio: Yes  
 Infrared: w/  
 Split screen: Yes  
 Tightness norm: IP 69K (Camera)  
 Language: English

**CAMERAS**
**160610 CCTV Camera** Std pkg 1 Servicing: HC-CARGO 160775, 160783, 160793

w/ original anoised finish and anti-fog glas. Lens: HC-CARGO 160965, 161037.

 Voltage: 12  
 Light sensitivity: 0.2 lux

 OD: 30 mm  
 Length: 70 mm  
 Connection cable: 6 pin mini DIN  
 Weight: 0.200 kg  
 Resolution: >330 TV lines  
 Shutter rate: 1/50-1/10000 sec.  
 Wide angle: 110°

 Signal system: PAL  
 Type: Colour  
 Colour: Black  
 Material: Aluminium  
 Picture sensor: 1/3" CCD  
 Microphone: w/o  
 Mirror function: w/  
 Protection degree: IP 68

**160880 Side Camera** Std pkg 1 Servicing: HC-CARGO 160775, 160783

 Voltage: 12  
 Light sensitivity: 0 lux/ IR LED on lux

 Connection cable: Mini DIN 6 pin - 2m  
 Height: 60.7 mm  
 Depth: 82.6 mm  
 Width: 61.12 mm  
 Resolution: 380 TV lines  
 Shutter rate: 1/60-1/10000 sec.  
 Wide angle: 73°

 Signal system: PAL  
 Type: Colour  
 Colour: Black  
 Material: Aluminium  
 Picture sensor: 1/4" CCD  
 Microphone: w/o  
 Infrared: w/  
 Mirror function: w/  
 Protection degree: IP 67

**160972 Colour Camera** Std pkg 1 Servicing: HC-CARGO 160994, 160996

 Voltage: 12/24  
 Light sensitivity: 0 lux

 Connection cable: 0.3 m 4 pin  
 Height: 43 mm  
 Depth: 57 mm  
 Width: 75 mm  
 Resolution: 480 TV lines  
 Wide angle: 95°

 Signal system: PAL/NTSC  
 Type: Colour  
 Colour: Black  
 Material: Aluminium  
 Picture sensor: 1/3" CCD  
 Microphone: w/  
 Infrared: w/  
 Mirror function: w/  
 Protection degree: IP 68  
 Alternativ no.: 161043

**161006 Colour Camera w/ auto close** Std pkg 1 Servicing: HC-CARGO 160994, 161007, 161039, 161046, 161051

 Voltage: 12/24  
 Light sensitivity: 0 lux

 Connection cable: 0.5 m 4 pin  
 Resolution: 420 TV lines  
 Wide angle: 140°

 Signal system: PAL/NTSC  
 Type: Colour  
 Colour: Black  
 Material: Aluminium  
 Picture sensor: 1/3" CCD  
 Microphone: w/o  
 Infrared: w/  
 Protection degree: IP 68

**161028 Colour Camera** Std pkg 1 Servicing: HC-CARGO 161027, 160994, 160996, 161005, 161007

 Voltage: 12  
 Light sensitivity: 0 lux

 Connection cable: 4 pin  
 Height: 77.2 mm  
 Depth: 66 mm  
 Width: 77.2 mm  
 Resolution: 420 TV lines  
 Wide angle: 130°

 Signal system: PAL  
 Type: Colour  
 Colour: Black  
 Material: Aluminium  
 Picture sensor: 1/3" CCD  
 Microphone: w/o  
 Infrared: w/  
 Protection degree: IP 69K  
 Alternativ no.: 161043







**161029 Colour Camera w/ Heat.** Std pkg 1 Servicing: HC-CARGO 160994, 161007, 161039, 161046, 161051

w/ heat.

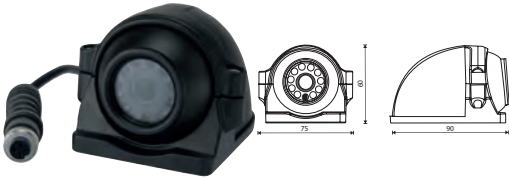
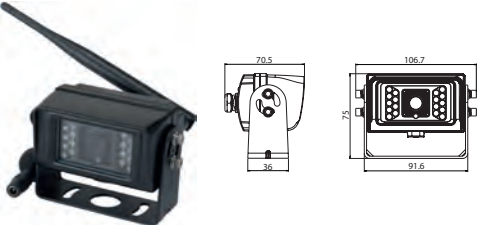

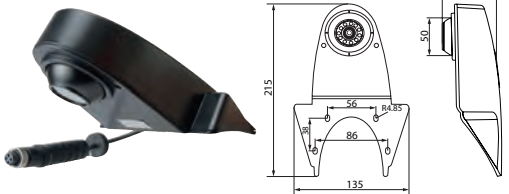

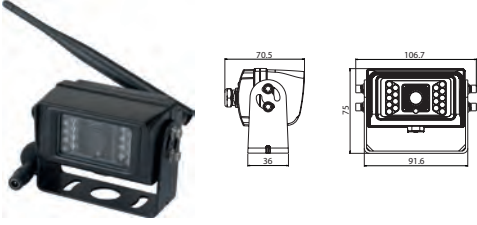





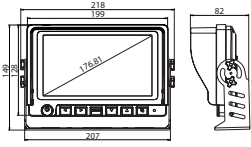

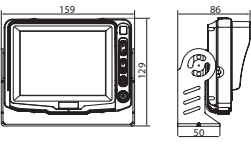
 Voltage: 12-24  
 Light sensitivity: 0 lux

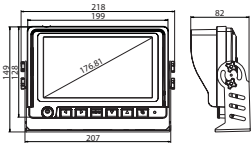
 Connection cable: 4 pin  
 Height: 77.2 mm  
 Depth: 66 mm  
 Width: 77.2 mm  
 Resolution: 420 TV lines  
 Wide angle: 120°

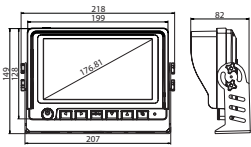
 Signal system: PAL  
 Type: Colour  
 Colour: Black  
 Material: Aluminium  
 Picture sensor: 1/3" CCD  
 Microphone: w/o  
 Infrared: w/  
 Mirror function: w/  
 Protection degree: IP 69K

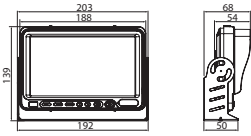
		EL. SPECIFICATIONS	DIMENSIONS	ADDITIONAL SPECIFICATIONS
<b>161030</b> Side Camera	Std pkg 1	Servicing: HC-CARGO 160994, 161007, 161039, 161046, 161051		
		<b>Voltage:</b> 12 <b>Light sensitivity:</b> 0 lux	<b>Connection cable:</b> 4 pin <b>Height:</b> 60 mm <b>Depth:</b> 90 mm <b>Width:</b> 75 mm <b>Resolution:</b> 420 TV lines <b>Wide angle:</b> 120°	<b>Signal system:</b> PAL <b>Type:</b> Colour <b>Colour:</b> Black <b>Material:</b> Aluminium <b>Picture sensor:</b> 1/3" CCD <b>Microphone:</b> w/o <b>Infrared:</b> w/ <b>Mirror function:</b> w/o <b>Protection degree:</b> IP 69K
<b>161033</b> Colour Camera	Std pkg 1	Servicing: HC-CARGO 161048		
<i>Aerial: HC-CARGO 161036.</i>				
		<b>Voltage:</b> 12-24 <b>Light sensitivity:</b> 0 lux	<b>Connection cable:</b> 4 pin <b>Height:</b> 75 mm <b>Depth:</b> 70.5 mm <b>Width:</b> 106.7 mm <b>Resolution:</b> 420 TV lines <b>Wide angle:</b> 120°	<b>Signal system:</b> PAL/NTSC <b>Type:</b> Colour - Wireless <b>Colour:</b> Black <b>Material:</b> Aluminium <b>Picture sensor:</b> 1/4" CMOS <b>Infrared:</b> w/ <b>Mirror function:</b> w/ <b>Protection degree:</b> IP 69K <b>Alternativ no.:</b> 161050
<b>161038</b> Colour Camera w/ Audio	Std pkg 1	Servicing: HC-CARGO 160775, 160783, 160793		
		<b>Voltage:</b> 12 <b>Light sensitivity:</b> 0 lux	<b>Connection cable:</b> 1.3 m w/ 6 pin Mini DIN <b>Height:</b> 75 mm <b>Depth:</b> 60 mm <b>Width:</b> 90 mm <b>Resolution:</b> 420 TV lines <b>Shutter rate:</b> 1/50-1/10000 sec. <b>Wide angle:</b> 122°	<b>Signal system:</b> PAL/NTSC <b>Type:</b> Colour <b>Colour:</b> White <b>Material:</b> Aluminium <b>Picture sensor:</b> 1/3" CCD <b>Microphone:</b> w/ <b>Audio:</b> Yes <b>Infrared:</b> w/ <b>Mirror function:</b> w/ <b>Protection degree:</b> IP 68
<b>161041</b> Colour camera for roof mounting	Std pkg 1	Servicing: HC-CARGO 160994, 161007, 161039, 161046, 161051		
		<b>Voltage:</b> 12 <b>Light sensitivity:</b> 0 lux	<b>Connection cable:</b> 0.35 m 4 pin <b>Height:</b> 80 mm <b>Depth:</b> 215 mm <b>Width:</b> 135 mm <b>Weight:</b> 0.36 kg <b>Resolution:</b> 420 TV lines <b>Wide angle:</b> 120°	<b>Signal system:</b> PAL/NTSC <b>Type:</b> Colour <b>Colour:</b> Black <b>Picture sensor:</b> 1/3" CCD <b>Microphone:</b> w/o <b>Infrared:</b> w/ <b>Protection degree:</b> IP 66
<b>161043</b> Colour Camera	Std pkg 1	Servicing: HC-CARGO 160994, 161007, 161039, 161046, 161051, 160996		
		<b>Voltage:</b> 12 <b>Light sensitivity:</b> 0 lux	<b>Connection cable:</b> 4 pin <b>Height:</b> 70 mm <b>Depth:</b> 84 mm <b>Width:</b> 76 mm <b>Weight:</b> 0.4 kg <b>Resolution:</b> 420 TV lines <b>Wide angle:</b> 120°	<b>Signal system:</b> PAL <b>Type:</b> Colour <b>Colour:</b> Black <b>Material:</b> Aluminium <b>Picture sensor:</b> 1/3" CCD <b>Microphone:</b> w/ <b>Audio:</b> Yes <b>Infrared:</b> w/ <b>Protection degree:</b> IP 69K
<b>161050</b> Colour Camera	Std pkg 1	Servicing: HC-CARGO 161048		
<i>Aerial: HC-CARGO 161036.</i>				
		<b>Voltage:</b> 12-24 <b>Light sensitivity:</b> 0 lux	<b>Connection cable:</b> 4 pin <b>Height:</b> 75 mm <b>Depth:</b> 70.5 mm <b>Width:</b> 106.7 mm <b>Resolution:</b> 420 TV lines <b>Wide angle:</b> 120°	<b>Signal system:</b> PAL/NTSC <b>Type:</b> Colour - Wireless <b>Colour:</b> Black <b>Material:</b> Aluminium <b>Picture sensor:</b> 1/4" CMOS <b>Audio:</b> Yes <b>Infrared:</b> w/ <b>Mirror function:</b> w/ <b>Protection degree:</b> IP 69K
<b>161056</b> Side Camera	Std pkg 1	Servicing: HC-CARGO 160994, 161007, 161039, 161046, 161051		
		<b>Voltage:</b> 12 <b>Light sensitivity:</b> 0 lux	<b>Connection cable:</b> 4 pin <b>Height:</b> 60 mm <b>Depth:</b> 90 mm <b>Width:</b> 75 mm <b>Resolution:</b> 330 TV lines <b>Wide angle:</b> 130°	<b>Signal system:</b> PAL <b>Type:</b> Colour <b>Colour:</b> Black <b>Picture sensor:</b> 1/3" CMOS <b>Microphone:</b> w/o <b>Infrared:</b> w/ <b>Mirror function:</b> w/o <b>Protection degree:</b> IP 69K

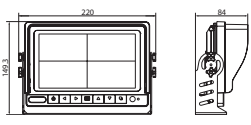
		EL. SPECIFICATIONS	DIMENSIONS	ADDITIONAL SPECIFICATIONS
<b>161057</b> Side Camera		Std pkg 1	Servicing: HC-CARGO 160994, 161007, 161039, 161046, 161051	
		Voltage: 12 Light sensitivity: 0 lux	Connection cable: 4 pin Height: 63.5 mm Depth: 55.5 mm Width: 74 mm Resolution: 330 TV lines Wide angle: 130°	Signal system: PAL Type: Colour Colour: Black Picture sensor: 1/3" CMOS Microphone: w/o Infrared: w/ Mirror function: w/o Protection degree: IP 69K
<b>161058</b> Colour Camera		Std pkg 1	Servicing: HC-CARGO 161054	
<i>Aerial: HC-CARGO 161036.</i> 		Voltage: 12-24 Light sensitivity: 0 lux	Connection cable: 4 pin Height: 75 mm Depth: 70 mm Width: 107 mm Resolution: 500 TV lines Wide angle: 120°	Signal system: PAL/NTSC Type: Colour - Wireless Colour: Black Material: Aluminium Picture sensor: 1/3" CMOS Audio: No Infrared: w/ Mirror function: w/ Protection degree: IP 69K
<b>MONITORS</b>				
<b>160776</b> Monitor		Std pkg 1	Servicing: HC-CARGO 160775	
		Voltage: 12/24	Display size: 7" Resolution: 1440x234 pixels	Signal system: PAL/NTSC Type: LED Mount. bracket: w/ Loudspeaker: Yes Mirror function: w/ Language: English
<b>160784</b> Monitor		Std pkg 1	Servicing: HC-CARGO 160783	
		Voltage: 12/24	Display size: 7" Resolution: 1440 (W) x234 (H) pixels	Signal system: PAL/NTSC Type: TFT-LCD Mount. bracket: w/ Remote control: w/o Loudspeaker: Yes Mirror function: w/ Language: English Alternativ no.: 160776
<b>160995</b> Monitor		Std pkg 1	Servicing: HC-CARGO 160994, 161039, 161046	
		Voltage: 12-24	Display size: 7" Resolution: 400x234 pixels	Signal system: PAL/NTSC Type: TFT-LCD Mount. bracket: w/ Remote control: w/ Loudspeaker: Yes Mirror function: w/o Language: Chinese, German, English, French, Dutch, Italian, Japanese, Portuguese, Spanish Alternativ no.: 161034
<b>160997</b> Monitor		Std pkg 1	Servicing: HC-CARGO 160996	
		Voltage: 12-24	Display size: 5" Resolution: 400x234 pixels	Signal system: PAL/NTSC Type: TFT-LCD Mount. bracket: w/ Remote control: w/ Loudspeaker: Yes Mirror function: w/o Language: Chinese, German, English, French, Dutch, Italian, Japanese, Portuguese, Spanish Alternativ no.: 161040
<b>161032</b> Monitor		Std pkg 1	Servicing: HC-CARGO 161048	
<i>Aerial: HC-CARGO 161036.</i> 		Voltage: 12-24	Display size: 7" Resolution: 800x480 pixels	Type: TFT-LCD Camera type: Colour - Wireless Mount. bracket: w/ Mirror function: w/ Language: English Alternativ no.: 161049

		EL. SPECIFICATIONS	DIMENSIONS	ADDITIONAL SPECIFICATIONS
<b>161034 Monitor</b> Std pkg 1 Servicing: HC-CARGO 161027				
 	Voltage: 12-24		Display size: 7" Resolution: 800x480 pixels	Type: TFT-LCD Camera type: Colour Mount. bracket: w/ Loudspeaker: Yes Mirror function: w/ Language: Chinese, German, English, French, Dutch, Italian, Portuguese, Spanish, Danish, Russian, Polish Alternativ no.: 161047
<b>161040 Monitor</b> Std pkg 1 Servicing: HC-CARGO 161039, 161046, 160994, 160996				
 	Voltage: 12-24		Display size: 5" Resolution: 640x480 pixels	Type: TFT-LCD Mount. bracket: w/ Remote control: w/ Loudspeaker: Yes Mirror function: w/ Language: Chinese, German, English, French, Dutch, Italian, Portuguese, Spanish, Danish, Russian, Polish
<b>161047 Monitor</b> Std pkg 1 Servicing: HC-CARGO 161046				
<i>Monitor Mounting, w/suction Cup: HC-CARGO 161044.</i>				
 	Voltage: 12-24		Display size: 7" Resolution: 800x480 pixels	Type: TFT-LCD Camera type: Colour Mount. bracket: w/ Loudspeaker: Yes Audio: Yes Mirror function: w/ Language: Chinese, German, English, French, Dutch, Italian, Portuguese, Spanish, Danish, Russian, Polish
<b>161049 Monitor</b> Std pkg 1 Servicing: HC-CARGO 161048				
<i>Monitor Mounting, w/suction Cup: HC-CARGO 161044. Aerial: HC-CARGO 161036.</i>				
 	Voltage: 12-24		Display size: 7" Resolution: 800x400 pixels	Type: TFT-LCD Camera type: Colour - Wireless Mount. bracket: w/ Loudspeaker: Yes Audio: Yes Mirror function: w/ Language: English
<b>161052 Monitor</b> Std pkg 1 Servicing: HC-CARGO 161051				
<i>Monitor Mounting, w/suction Cup: HC-CARGO 161044.</i>				
 	Voltage: 12-24		Display size: 7" Resolution: 800x480 pixels	Type: TFT-LCD Camera type: Colour Mount. bracket: w/ Loudspeaker: Yes Audio: Yes Mirror function: w/ Language: Chinese, German, English, French, Dutch, Italian, Spanish, Danish, Russian, Polish
<b>161053 Monitor</b> Std pkg 1 Servicing: HC-CARGO 161051				
<i>Monitor Mounting, w/suction Cup: HC-CARGO 161044.</i>				
 	Voltage: 12-24		Display size: 7" Resolution: 800x480 pixels	Type: TFT-LCD Camera type: Colour Audio: No Mirror function: w/ Protection degree: IP 69 Language: English

**161055** Monitor Std pkg 1 Servicing: HC-CARGO 161054

Monitor Mounting, w/suction Cup: HC-CARGO 161044. Aerial: HC-CARGO 161036.

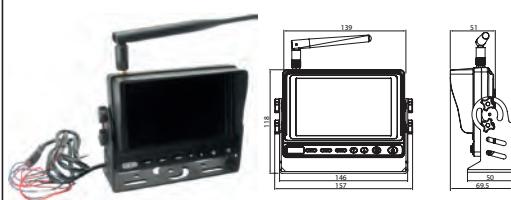

Voltage: 12-24

Display size: 5"  
Resolution:  
800x480 pixels

Type: TFT-LCD  
Camera type: Colour - Wireless  
Mount. bracket: w/  
Audio: No  
Mirror function: w/  
Language: English

**ACCESSORIES**

**160611** CCTV Extension Cable Std pkg 1 Servicing: HC-CARGO 160775, 160783, 160793



Length: 20 m

Plug: Mini DIN 6 pin

**160612** CCTV Extension Cable Std pkg 1 Servicing: HC-CARGO 160775, 160783, 160793



Length: 15 m

Plug: Mini DIN 6 pin

**160613** CCTV Extension Cable Std pkg 1 Servicing: HC-CARGO 160775, 160783, 160793



Length: 10 m

Plug: Mini DIN 6 pin

**160672** CCTV Extension Cable Std pkg 1 Servicing: HC-CARGO 160775, 160783, 160793



Length: 6 m

Plug: Mini DIN 6 pin

**160888** CCTV Extension Cable Std pkg 1 Servicing: HC-CARGO 160994, 160996, 161039, 161051



Length: 20 m

Plug: 4 pin

**160889** CCTV Extension Cable Std pkg 1 Servicing: HC-CARGO 160994, 160996, 161027



Length: 10 m

Plug: 4 pin



		EL. SPECIFICATIONS	DIMENSIONS	ADDITIONAL SPECIFICATIONS
<b>160916</b> Trailer Cable Kit		Std pkg 1	Servicing: HC-CARGO 160994, 160996	
			Cable from socket to camera: 2 m Cable from socket to monitor: 5 m Coil length: 3 m	Plug: 4 pin
<b>160965</b> Lens		Std pkg 1	Servicing: HC-CARGO 160610	
				Material: Glass
<b>160993</b> Trailer Cable Kit		Std pkg 1	Servicing: HC-CARGO 160775	
			Cable from socket to camera: 20 m Cable from socket to monitor: 5 m Coil length: 2 m	Plug: Mini DIN 6 pin
<b>161036</b> Aerial		Std pkg 1	Servicing: HC-CARGO 161032, 161033, 161048, 161049, 161050, 161054, 161055, 161058	
				Colour: Black Material: Rubber
<b>161037</b> Lens		Std pkg 1	Servicing: HC-CARGO 160610	
				Material: Glass
<b>161044</b> Monitor Mounting, W/suction Cup		Std pkg 1	Servicing: HC-CARGO 161039, 161046, 161047, 161048, 161049, 161051, 161052, 161053, 161054, 161055	
<i>Suction.</i>			Length: 220 mm	Colour: Black
				
<b>PARKING SENSORS</b>				
<b>160884</b> Parking Sensor		Std pkg 1		
<i>4 sensors. Wireless.</i>				
		Voltage: 9-14	Dim. display: 128x27x22 mm Sensor dia.: 20 mm	

**160930** Parking Sensor Std pkg 1

8 sensors. Wireless.



Voltage: 9-14

 Dim. display:  
128x27x22 mm  
Sensor dia.: 20 mm

 Connection: Wireless  
Colour: Black

## ACOUSTIC WARNING REVERSING ALARMS

**160346** Reversing Alarm Std pkg 1

w/ "beep-beep" warning sound.

 Voltage: 12  
Watt: 10  
Decibel: 90

 Bulb type: Halogen  
Socket type: BA15S  
ADR-approved: No

**160410** Reversing Alarm Std pkg 1

w/ "beep-beep" warning sound.

 Voltage: 24  
Watt: 20  
Decibel: 90

 Bulb type: Halogen  
Socket type: BA15S  
ADR-approved: No

**160481** Reversing Alarm Std pkg 1

 Voltage: 12/24  
Amp: 0.25  
Decibel: 96  
Hertz: 2500

 Overvoltage: Yes  
Waterproof: Yes  
ADR-approved: No

**160482** Reversing Alarm Std pkg 1

Night attenuation, excluding when fog lights are on. RED LEAD- To reverse lamp, BLACK LEAD- To earth, ORANGE LEAD- To side lamp (night silent mode), GREEN LEAD- To fog lamp (night silent override).

 Voltage: 12/24  
Amp: 0.25  
Decibel: 100  
Hertz: 980

 Overvoltage: Yes  
Waterproof: Yes  
ADR-approved: Yes

**160689** Reversing Alarm Std pkg 1

 Voltage: 12/80  
Miliamp: 30  
Decibel: 85  
Hertz: 3200

Weight: 035 kg







 Type: Buzzer  
Waterproof: Yes  
ADR-approved: No

## BUZZERS

**160533** Warning Buzzer Std pkg 1

 Voltage: 24  
Miliamp: 30  
Decibel: 85  
Hertz: 400±100

<b>160534</b> Warning Buzzer <span style="float: right;">Std pkg 1</span>					
		Voltage: 12 Milliamp: 30 Decibel: 85 Hertz: 400±100			
<b>HORNS</b>					
<b>ELECTRICAL</b>					
<b>160036</b> Twin Fanfare Horn <span style="float: right;">Std pkg 1</span> <i>Red w/ chromium grill.</i>					
		Voltage: 12 Decibel: 112 Hertz: 410-490		Relay: w/ Marine: No E-approval: Yes	
<b>160393</b> Horn <span style="float: right;">Std pkg 1</span> <i>2 terminals. w/ bracket.</i>					
		Voltage: 36-48 Amp: 1 Decibel: 112 Hertz: 420		OD: 100 mm  Type: Single tone Material: Steel Marine: No E-approval: Yes	
<b>160414</b> Horn <span style="float: right;">Std pkg 1</span> <i>Model EM2.</i>					
		Voltage: 24 Amp: 4 Decibel: 118 Hertz: 370		Length: 400 mm  Type: Single tone Material: Chromed brass Relay: w/o Marine: Yes	
<b>160415</b> Horn <span style="float: right;">Std pkg 1</span> <i>Model EM2.</i>					
		Voltage: 12 Amp: 5 Decibel: 118 Hertz: 370		Length: 400 mm  Type: Single tone Material: Chromed brass Relay: w/o Marine: Yes	
<b>160658</b> Horn <span style="float: right;">Std pkg 1</span> <i>Servicing: VW - Visit <a href="http://www.hc-cargo.com">www.hc-cargo.com</a> for further information.</i> <i>w/ K- Jetronic connection. w/ bracket.</i>					
		Voltage: 12 Amp: <1 Hertz: 335		OD: 100 mm  Type: Single tone Material: Steel Marine: No E-approval: Yes	

		EL. SPECIFICATIONS	DIMENSIONS	ADDITIONAL SPECIFICATIONS
<b>160712</b> Horn		Std pkg 1	Servicing: VW - Visit <a href="http://www.hc-cargo.com">www.hc-cargo.com</a> for further information.	
2 poles.				
		Voltage: 12	OD: 82 mm Length: 117 mm	Type: Dual tone Relay: w/o Marine: No E-approval: Yes
<b>160746</b> Horn		Std pkg 1	Servicing: Scooters and motor cycles - Visit <a href="http://www.hc-cargo.com">www.hc-cargo.com</a> for further information.	
2 terminals. w/ bracket.				
		Voltage: 12 Amp: 1-1.4 Decibel: 109 Hertz: 410-550	OD: 70 mm	Type: Single tone Material: Steel Marine: No E-approval: Yes
<b>160986</b> Horn		Std pkg 1		
2 terminals. w/ bracket.				
		Voltage: 12 Amp: 3.5 Decibel: 112 Hertz: 420	OD: 90 mm	Type: Single tone Material: Steel Marine: No E-approval: Yes
<b>160987</b> Horn		Std pkg 1		
2 terminals. w/ bracket.				
		Voltage: 24 Amp: 2.5 Decibel: 112 Hertz: 420	OD: 90 mm	Type: Single tone Material: Steel Marine: No E-approval: Yes
<b>160988</b> Horn		Std pkg 1		
2 terminals. w/ bracket.				
		Voltage: 12 Amp: 3.5 Decibel: 112 Hertz: 335	OD: 90 mm	Type: Single tone Material: Steel Marine: No E-approval: Yes
<b>160989</b> Horn		Std pkg 1		
2 terminals. w/ bracket.				
		Voltage: 24 Amp: 2.5 Decibel: 112 Hertz: 335	OD: 90 mm	Type: Single tone Material: Steel Marine: No E-approval: Yes
<b>AIR HORNS</b>				
<b>160002</b> Compressor Horn		Std pkg 1		
w/ parts. Y-Connector: HC-CARGO 160042.				
		Voltage: 12 Amp: 16 Decibel: 117 Hertz: 630-795		Type: Dual tone Material: Shockproof plastic Relay: w/ E-approval: Yes

EL. SPECIFICATIONS		DIMENSIONS	ADDITIONAL SPECIFICATIONS
<b>160038 Pneumatic Horn</b> Std pkg 1 <i>Operating pressure 500-1200 kPa. For trucks equipped w/ on-board air. Compressor: HC-CARGO 160333, 160334.</i>			
	Decibel: 118 Hertz: 330/370	OD: 80 mm Length: 390 mm	Type: Dual tone Material: Chromed Metal E-approval: Yes
<b>160048 Marine Horn</b> Std pkg 1 <i>To be powered by electric air compressor: HC-CARGO 160213. Audibility at least 1600 mtr. over open water.</i>			
	Decibel: 120 Hertz: 380	Length: 385 mm Capacity: 72 l/min	Material: Stainless steel Marine: Yes
<b>160355 Pneumatic Horn</b> Std pkg 1 <i>Servicing: Trucks - Visit <a href="http://www.hc-cargo.com">www.hc-cargo.com</a> for further information.</i> <i>Operating pressure 30-1200 kPa. Equipped w/ on-board air.</i>			
	Decibel: 118 Hertz: 210	OD: 160 mm Length: 600 mm	Type: Single tone Material: Chromed Metal E-approval: Yes
<b>160356 Pneumatic Horn</b> Std pkg 1 <i>Servicing: Trucks - Visit <a href="http://www.hc-cargo.com">www.hc-cargo.com</a> for further information.</i> <i>Operating pressure 30-1200 kPa. Equipped w/ on-board air.</i>			
	Decibel: 118 Hertz: 190	OD: 160 mm Length: 680 mm	Type: Single tone Material: Chromed Metal
<b>160508 Compressor Horn</b> Std pkg 1 <i>Y-Connector: HC-CARGO 160042.</i>			
	Voltage: 24 Amp: 8 Decibel: 118 Hertz: 692-756		Type: Dual tone Material: Shockproof plastic Relay: w/ E-approval: Yes
<b>160632 Marine Air Horn</b> Std pkg 1			
	Voltage: 24 Decibel: 117 Hertz: 228	Length: 500 mm	Material: Stainless steel Marine: Yes
<b>160744 Compressor Horn</b> Std pkg 1 <i>Servicing: Boats until 12 m - Visit <a href="http://www.hc-cargo.com">www.hc-cargo.com</a> for further information.</i> <i>Electro pneumatic horn w/ integrated compressor.</i>			
	Voltage: 24 Decibel: 120 Hertz: 300	Length: 120x190x120 mm	Type: Single tone Material: ASA plastic Relay: w/ Marine: Yes

**160756 Marine Air Horn** Std pkg 1

Approvals: Rina ELE/35398/2. Lloyds register MSA 9800031.

 Voltage: 24  
 Decibel: 123  
 Hertz: 630

 OD: 200 mm  
 Length: 460 mm

 Type: Single tone  
 Material: Enameled Brass  
 Marine: Yes

**SPARE PARTS**
**160039 Electric Valve** Std pkg 1

For Compressor horn.



Voltage: 24

**160042 Y-Connector** Std pkg 10

Servicing: HC-CARGO 160002, 160508

**160213 Compressor** Std pkg 1

Servicing: HC-CARGO 160048



Voltage: 24

 OD: 90 mm  
 Length: 165 mm  
 Pressure: 2 bar

 Material: Aluminium  
 Relay: w/  
 Marine: Yes

**160333 Compressor** Std pkg 1

Servicing: HC-CARGO 160038

Approved for boats until 12 mtr.



Voltage: 12

 OD: 70 mm  
 Length: 112 mm  
 Pressure: 1.5 bar

 Type: 1, 2 and 3 tones  
 Material: Aluminium  
 Relay: w/  
 Marine: Yes

**160334 Compressor** Std pkg 1

Servicing: HC-CARGO 160038



Voltage: 24

 OD: 70 mm  
 Length: 112 mm  
 Pressure: 1.5 bar

 Type: 1, 2 and 3 tones  
 Material: Aluminium  
 Relay: w/  
 Marine: Yes

**190097 PA Hose** Std pkg 50

 ID: 8 mm  
 OD: 11.6 mm  
 Length: 50 m

## POWER MANAGEMENT COMPONENTS

### VOLTAGE CONVERTERS

**160899** Adaptor Std pkg 1

*Max. output 220 W. 7-13 pole.*

 Voltage/in: 24  
 Voltage/out: 12  
 Watt/out: 6x70

Type: Switch mode

**160900** Trailer Light Converter Adapter Std pkg 1

*Max. output 220 W. 7-7 pole.*

 Voltage/in: 24  
 Voltage/out: 12  
 Watt/out: 6x70

Type: Switch mode

**160901** Trailer Light Converter Std pkg 1

*Output: 2x21 W + 4x60 W. To be used when HC-CARGO 160899 and 160900 are not suited.*

 Voltage/in: 24  
 Voltage/out: 12

### NON INSULATED

**160306** Voltage Converter Std pkg 1

 Voltage/in: 24  
 Voltage/out: 12  
 Amp/5 min.: 18  
 Amp/cont.: 12

Dim.: 127X87X50 mm

 Type: Switch mode/uninsulated  
 Over current: Yes  
 Protection against over heating: Yes  
 Protection against overvoltage: Yes  
 Protection against reverse connection: Yes  
 Protection against transients: Yes  
 Approvals: CE

**160387** Voltage Converter Std pkg 1

 Voltage/in: 24  
 Voltage/out: 12  
 Amp/5 min.: 6  
 Amp/cont.: 3

Dim.: 67x87x50 mm

 Type: Switch mode/uninsulated  
 Over current: Yes  
 Protection against over heating: Yes  
 Protection against overvoltage: Yes  
 Protection against reverse connection: Yes  
 Protection against transients: Yes  
 Approvals: CE

**160388** Voltage Converter Std pkg 1

 Voltage/in: 24  
 Voltage/out: 12  
 Amp/5 min.: 10  
 Amp/cont.: 6

Dim.: 89x87x50 mm

 Type: Switch mode/uninsulated  
 Over current: Yes  
 Protection against over heating: Yes  
 Protection against overvoltage: Yes  
 Protection against reverse connection: Yes  
 Protection against transients: Yes  
 Approvals: CE

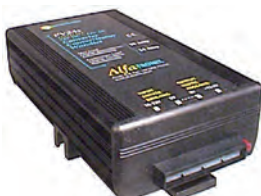
**160389** Voltage Converter Std pkg 1

 Voltage/in: 24  
 Voltage/out: 12  
 Amp/5 min.: 30  
 Amp/cont.: 24

Dim.: 167x87x50 mm

 Type: Switch mode/uninsulated  
 Over current: Yes  
 Protection against over heating: Yes  
 Protection against overvoltage: Yes  
 Protection against reverse connection: Yes  
 Protection against transients: Yes  
 Approvals: CE







		EL. SPECIFICATIONS	DIMENSIONS	ADDITIONAL SPECIFICATIONS
<b>160640</b> Converter	Std pkg 1	 <p>Voltage/in: 24 Voltage/out: 12 Amp/5 min.: 60 Amp/cont.: 50</p>	Dim.: 283x125x74 mm	Type: Switch mode/uninsulated Over current: Yes Protection against over heating: Yes Protection against overvoltage: Yes Protection against reverse connection: Yes Protection against transients: Yes Approvals: CE
<b>160642</b> Converter	Std pkg 1	 <p>Voltage/in: 12 Voltage/out: 24 Amp/cont.: 3 Watt/out: 72</p>	Dim.: 89x87x50 mm	Type: Switch mode/uninsulated Over current: Yes Protection against over heating: Yes Protection against overvoltage: Yes Protection against reverse connection: Yes Protection against transients: Yes Approvals: CE
<b>160646</b> Converter	Std pkg 1	 <p>Voltage/in: 12 Voltage/out: 24 Amp/cont.: 10 Watt/out: 240</p>	Dim.: 217x87x50 mm	Type: Switch mode/uninsulated Over current: Yes Protection against over heating: Yes Protection against overvoltage: Yes Protection against reverse connection: Yes Protection against transients: Yes Approvals: CE
<b>161072</b> Voltage Converter	Std pkg 1	 <p>Voltage/in: 12 Voltage/out: 24 Amp/cont.: 16 Watt/out: 400</p>	Dim.: 233x125x74 mm	Type: Switch mode/uninsulated Over current: Yes Protection against over heating: Yes Protection against overvoltage: Yes Protection against reverse connection: Yes Protection against transients: Yes Approvals: CE
<b>161073</b> Voltage Converter	Std pkg 1	 <p>Voltage/in: 12 Voltage/out: 24 Amp/cont.: 25 Watt/out: 600</p>	Dim.: 283x125x74 mm	Type: Switch mode/uninsulated Over current: Yes Protection against over heating: Yes Protection against overvoltage: Yes Protection against reverse connection: Yes Protection against transients: Yes Approvals: CE
<b>161080</b> Voltage Converter	Std pkg 1	 <p>Voltage/in: 24 Voltage/out: 12 Amp/5 min.: 22 Amp/cont.: 18</p>	Dim.: 167x87x50 mm	Type: Switch mode/uninsulated Over current: Yes Protection against over heating: Yes Protection against overvoltage: Yes Protection against reverse connection: Yes Protection against transients: Yes Approvals: CE
<b>INSULATED</b>				
<b>160390</b> Voltage Converter	Std pkg 1	 <p>Voltage/in: 24 Voltage/out: 12 Amp/5 min.: 6 Amp/cont.: 3</p>	Dim.: 89x87x50 mm	Type: Switch mode/isolated Over current: Yes Protection against over heating: Yes Protection against overvoltage: Yes Protection against reverse connection: Yes Protection against transients: Yes Approvals: CE

*The converter is supplied w/ a unique clip mounting bracket. The converter is intended for use w/ the same equipment as HC-CARGO 160387, but for systems where full isolation is required e.g. marine electrical systems and vehicles for petroche. Instruction included.*



EL. SPECIFICATIONS		DIMENSIONS	ADDITIONAL SPECIFICATIONS
<b>160391 Voltage Converter</b> Std pkg 1			
<i>The converter is supplied w/ a unique clip mounting bracket. The converter is intended for use w/ the same equipment as HC-CARGO 160388, but for systems where full isolation is required e.g. marine electrical systems and vehicles for petroche. Instruction included.</i>			
	Voltage/in: 24 Voltage/out: 12 Amp/5 min.: 10 Amp/cont.: 6	Dim.: 127X87X50 mm	Type: Switch mode/isolated Over current: Yes Protection against over heating: Yes Protection against overvoltage: Yes Protection against reverse connection: Yes Protection against transients: Yes Approvals: CE
<b>160392 Voltage Converter</b> Std pkg 1			
<i>The converter is supplied w/ a unique clip mounting bracket. The converter is intended for use w/ the same equipment as HC-CARGO 160306, but for systems where full isolation is required e.g. marine electrical systems and vehicles for petroche. Instruction included.</i>			
	Voltage/in: 24 Voltage/out: 12 Amp/5 min.: 18 Amp/cont.: 12	Dim.: 167x87x50 mm	Type: Switch mode/isolated Over current: Yes Protection against over heating: Yes Protection against overvoltage: Yes Protection against reverse connection: Yes Protection against transients: Yes Approvals: CE
<b>160644 Converter</b> Std pkg 1			
	Voltage/in: 12 Voltage/out: 24 Amp/cont.: 7 Watt/out: 168	Dim.: 167x87x50 mm	Type: Switch mode/isolated Over current: Yes Protection against over heating: Yes Protection against overvoltage: Yes Protection against reverse connection: Yes Protection against transients: Yes Approvals: CE
<b>160960 Power Converter</b> Std pkg 1 <b>Servicing: Used for mounting computers in trollies</b>			
<i>Modified to stabilize the output voltage.</i>			
	Voltage/in: 12 Voltage/out: 12 Amp/cont.: 6 Watt/out: 72	Dim.: 167x87x50 mm	Type: Switch mode/isolated Over current: Yes Protection against over heating: Yes Protection against overvoltage: Yes Protection against reverse connection: Yes Protection against transients: Yes Approvals: CE
<b>161074 Voltage Converter</b> Std pkg 1			
	Voltage/in: 24 Voltage/out: 24 Amp/cont.: 3 Watt/out: 72	Dim.: 127X87X50 mm	Type: Switch mode/isolated Over current: Yes Protection against over heating: Yes Protection against overvoltage: Yes Protection against reverse connection: Yes Protection against transients: Yes Approvals: CE
<b>161075 Voltage Converter</b> Std pkg 1			
	Voltage/in: 24 Voltage/out: 24 Amp/cont.: 4.5 Watt/out: 108	Dim.: 167x87x50 mm	Type: Switch mode/isolated Over current: Yes Protection against over heating: Yes Protection against overvoltage: Yes Protection against reverse connection: Yes Protection against transients: Yes Approvals: CE
<b>161077 Voltage Converter</b> Std pkg 1			
	Voltage/in: 24 Voltage/out: 24 Amp/cont.: 10 Watt/out: 240	Dim.: 217x87x62 mm	Type: Switch mode/isolated Over current: Yes Protection against over heating: Yes Protection against overvoltage: Yes Protection against reverse connection: Yes Protection against transients: Yes Approvals: CE

		EL. SPECIFICATIONS	DIMENSIONS	ADDITIONAL SPECIFICATIONS
<b>161079</b> Voltage Converter	Std pkg 1	 Voltage/in: 24 Voltage/out: 12 Amp/5 min.: 22 Amp/cont.: 18	Dim.: 217x87x50 mm	Type: Switch mode/isolated Over current: Yes Protection against over heating: Yes Protection against overvoltage: Yes Protection against reverse connection: Yes Protection against transients: Yes Approvals: CE
<b>161081</b> Voltage Converter	Std pkg 1	 Voltage/in: 24 Voltage/out: 12 Amp/cont.: 24	Dim.: 217x87x50 mm	Type: Switch mode/isolated Over current: Yes Protection against over heating: Yes Protection against overvoltage: Yes Protection against reverse connection: Yes Protection against transients: Yes Approvals: CE
<b>MULTI POWER</b>				
<b>160579</b> Voltage Converter	Std pkg 1	 Voltage/in: 36-90 Voltage/out: 12 Amp/cont.: 6 Watt/out: 75	Dim.: 134x94x18 mm	Protection degree: IP 68
<b>160580</b> Voltage Converter	Std pkg 1	 Voltage/in: 36-90 Voltage/out: 12 Amp/cont.: 15	Dim.: 134x94x48 mm	Protection degree: IP 68
<b>RELAY BOXES</b>				
<b>160167</b> Relay Box	Std pkg 1	Servicing: For 12 V trailer pulled by a 24 V vehicle - Visit <a href="http://www.hc-cargo.com">www.hc-cargo.com</a> for further information. <i>Switches the voltage from 24 V to 12 V by 5 relays. Run at 24 V and leading 12 V from one of the batteries or converter to the lamps of the trailer. For continuous use it has to be connected via a converter. For internal mounting.</i>		
		Voltage: 12/24 Amp: 10 Watt: 250	Dim.: 100x100x58 mm	No./poles: 7 Relay switch: Yes
<b>160502</b> Trailer Connecting Unit	Std pkg 1	Servicing: For 12 V trailer pulled by a 24 V vehicle - Visit <a href="http://www.hc-cargo.com">www.hc-cargo.com</a> for further information. <i>Mounted w/o use of converter.</i>		
		Voltage: 12/24	Dim.: 110x103x43 mm	C2 control lamp: w/ No./poles: 7 Relay switch: No Transistor switch: Yes Waterproof: Yes IP rating: IP 65
<b>160797</b> Relay Box	Std pkg 1	<i>To reduce voltage drop, if you use vehicles w/ trailer. Fitted w/ 5x12 V relays the 12 V function will not be affected.</i>		
		Voltage: 12-12 Amp: 5x8 Watt: 5x250	Dim.: 100x100x58 mm	

VOLTAGE INVERTERS					
160541 Voltage Inverter	Std pkg 1		Voltage/in: 12 Voltage/out: 230 Alarm/Voltage: 10.5±0.5 Shut down/Voltage: 10±0.5 Amp/max/cont.: <20 Amp/standby: <0.3 Watt/cont.: 150 Watt/max.: 450	Dim.: 165x91x58 mm Weight: 0.850 kg Regulation: ±10 Efficiency: Over 90 %	Type: Modified sine Over heating: Yes Overloading: Yes Short circuit: Yes Approvals: CE Alternativ no.: 161078
160542 Voltage Inverter	Std pkg 1		Voltage/in: 24 Voltage/out: 230 Alarm/Voltage: 21±1 Shut down/Voltage: 20±1 Amp/max/cont.: <10 Amp/standby: <0.3 Watt/cont.: 150 Watt/max.: 450	Dim.: 165x91x58 mm Weight: 0.850 kg Regulation: ±10 Efficiency: Over 90 %	Type: Modified sine Over heating: Yes Overloading: Yes Short circuit: Yes Approvals: CE Alternativ no.: 161082
160543 Voltage Inverter	Std pkg 1		Voltage/in: 10-15 Voltage/out: 230 Alarm/Voltage: 10.5±0.5 Shut down/Voltage: 10±0.5 Amp/max/cont.: <35 Amp/standby: <0.3 Watt/cont.: 300 Watt/max.: 1000	Dim.: 190x91x58 mm Weight: 1.1 kg Regulation: ±10 Efficiency: Over 90 %	Type: Modified sine Over heating: Yes Overloading: Yes Short circuit: Yes Approvals: CE Alternativ no.: 161085
160544 Voltage Inverter	Std pkg 1		Voltage/in: 24 Voltage/out: 230 Alarm/Voltage: 21±1 Shut down/Voltage: 20±1 Amp/max/cont.: <20 Amp/standby: <0.3 Watt/cont.: 300 Watt/max.: 1000	Dim.: 190x91x58 mm Weight: 1.1 kg Regulation: ±10	Type: Modified sine Over heating: Yes Overloading: Yes Short circuit: Yes Approvals: CE Alternativ no.: 161086
160545 Voltage Inverter	Std pkg 1		Voltage/in: 10-15 Voltage/out: 230 Alarm/Voltage: 10.5±0.5 Shut down/Voltage: 10±0.5 Amp/standby: <0.3 Watt/cont.: 600 Watt/max.: 1500	Dim.: 242x91x58 mm Weight: 1.7 kg Regulation: ±10	Type: Modified sine Over heating: Yes Overloading: Yes Short circuit: Yes Approvals: CE Alternativ no.: 161089
160546 Voltage Inverter	Std pkg 1		Voltage/in: 24 Voltage/out: 230 Alarm/Voltage: 21±1 Shut down/Voltage: 20±1 Amp/standby: <0.3 Watt/cont.: 600 Watt/max.: 1500	Dim.: 242x91x58 mm Weight: 1.7 kg Regulation: ±10	Type: Modified sine Over heating: Yes Overloading: Yes Short circuit: Yes Approvals: CE Alternativ no.: 161090
160569 Voltage Inverter	Std pkg 1		Voltage/in: 12 Voltage/out: 230 Alarm/Voltage: 10.5±0.5 Shut down/Voltage: 10±0.5 Amp/standby: <2 Watt/cont.: 1500 Watt/max.: 3500	Dim.: 395x240x90 mm Weight: 5.5 kg	Type: Modified sine Cooling fan: Yes Over heating: Yes Overloading: Yes Short circuit: Yes Approvals: CE Alternativ no.: 161097

Remote Control: HC-CARGO 161045.

<b>160581 Voltage Inverter</b> Std pkg 1 <i>Remote Control: HC-CARGO 161045.</i>			
	Voltage/in: 24 Voltage/out: 230 Alarm/Voltage: 21±1 Shut down/Voltage: 20±1 Amp/standby: <1 Watt/cont.: 1500 Watt/max.: 3500	Dim.: 395x240x90 mm Weight: 5.5 kg	Type: Modified sine Over heating: Yes Overloading: Yes Short circuit: Yes Approvals: CE Alternativ no.: 161098
<b>160660 Voltage Inverter</b> Std pkg 1 <i>Remote Control: HC-CARGO 161045.</i>			
	Voltage/in: 10-15 Voltage/out: 230 Alarm/Voltage: 10.5±0.5 Shut down/Voltage: 10±0.5 Amp/standby: <0.8 Watt/cont.: 1000 Watt/max.: 2500	Dim.: 310x205x75 mm Weight: 5 kg Regulation: ±10	Type: Modified sine Over heating: Yes Overloading: Yes Short circuit: Yes Approvals: CE Alternativ no.: 161093
<b>160676 Voltage Inverter</b> Std pkg 1 <i>Remote Control: HC-CARGO 161045.</i>			
	Voltage/in: 24 Voltage/out: 230 Alarm/Voltage: 21±1 Shut down/Voltage: 20±1 Amp/standby: <0.8 Watt/cont.: 1000 Watt/max.: 2500	Dim.: 310x205x75 mm Weight: 5 kg Regulation: ±10	Type: Modified sine Over heating: Yes Overloading: Yes Short circuit: Yes Approvals: CE Alternativ no.: 161094
<b>160991 Voltage Inverter AC-DC</b> Std pkg 1			
	Voltage/in: 230 Voltage/out: 12V DC Amp/max/cont.: 25	Dim.: 226.5x115x49.7 mm	Type: AC-DC Over heating: Yes Overloading: Yes Short circuit: Yes Approvals: CE
<b>161078 Voltage Inverter</b> Std pkg 1			
 <p>NEW PRODUCT www.hc-cargo.com</p>	Voltage/in: 12 Voltage/out: 220-240 Alarm/Voltage: 11±0.5 Shut down/Voltage: 10±0.5 Amp/max/cont.: 15 Amp/standby: <0.28 Watt/cont.: 150 Watt/max.: 450	Dim.: 120x73x73 mm Weight: 0.560 kg Efficiency: 90 %	Type: Modified sine Over heating: Yes Overloading: Yes Short circuit: Yes Approvals: CE Alternativ no.: 160541
<b>161082 Voltage Inverter</b> Std pkg 1			
 <p>NEW PRODUCT www.hc-cargo.com</p>	Voltage/in: 24 Voltage/out: 220-240 Alarm/Voltage: 22±1 Shut down/Voltage: 20±1 Amp/max/cont.: 8 Amp/standby: <0.18 Watt/cont.: 150 Watt/max.: 450	Dim.: 120x73x73 mm Weight: 0.560 kg Efficiency: 90 %	Type: Modified sine Over heating: Yes Overloading: Yes Short circuit: Yes Approvals: CE Alternativ no.: 160542
<b>161083 Voltage Inverter UK</b> Std pkg 1			
 <p>NEW PRODUCT www.hc-cargo.com</p>	Voltage/in: 12 Voltage/out: 220-240 Alarm/Voltage: 11±0.5 Shut down/Voltage: 10±0.5 Amp/max/cont.: 15 Amp/standby: <0.28 Watt/cont.: 150 Watt/max.: 450	Dim.: 120x73x73 mm Weight: 0.560 kg Efficiency: 90 %	Type: Modified sine Over heating: Yes Overloading: Yes Short circuit: Yes Approvals: CE

	EL. SPECIFICATIONS	MEASUREMENTS	ADDITIONAL SPECIFICATIONS
<b>161084</b> Voltage Inverter - UK Std pkg 1 	Voltage/in: 24 Voltage/out: 220-240 Alarm/Voltage: 22±1 Shut down/Voltage: 20±1 Amp/max/cont.: 8 Amp/standby: <0.18 Watt/cont.: 150 Watt/max.: 450	Dim.: 120x73x73 mm Weight: 0.560 kg Efficiency: 90 %	Type: Modified sine Over heating: Yes Overloading: Yes Short circuit: Yes Approvals: CE
<b>161085</b> Voltage Inverter Std pkg 1 	Voltage/in: 12 Voltage/out: 220-240 Alarm/Voltage: 10.5±0.5 Shut down/Voltage: 10±0.5 Amp/max/cont.: 30 Amp/standby: <0.5 Watt/cont.: 300 Watt/max.: 900	Dim.: 155x73x73 mm Weight: 0.900 kg Efficiency: 90 %	Type: Modified sine Over heating: Yes Overloading: Yes Short circuit: Yes Approvals: CE Alternativ no.: 160543
<b>161086</b> Voltage Inverter Std pkg 1 	Voltage/in: 24 Voltage/out: 220-240 Alarm/Voltage: 21±1 Shut down/Voltage: 20±1 Amp/max/cont.: 15 Amp/standby: <0.5 Watt/cont.: 300 Watt/max.: 900	Dim.: 155x73x73 mm Weight: 0.900 kg Efficiency: 90 %	Type: Modified sine Over heating: Yes Overloading: Yes Short circuit: Yes Approvals: CE Alternativ no.: 160544
<b>161087</b> Voltage Inverter UK Std pkg 1 	Voltage/in: 12 Voltage/out: 220-240 Alarm/Voltage: 10.5±0.5 Shut down/Voltage: 10±0.5 Amp/max/cont.: 30 Amp/standby: <0.5 Watt/cont.: 300 Watt/max.: 900	Dim.: 155x73x73 mm Weight: 0.900 kg Efficiency: 90 %	Type: Modified sine Over heating: Yes Overloading: Yes Short circuit: Yes Approvals: CE
<b>161088</b> Voltage Inverter UK Std pkg 1 	Voltage/in: 24 Voltage/out: 220-240 Alarm/Voltage: 21±1 Shut down/Voltage: 20±1 Amp/max/cont.: 15 Amp/standby: <0.5 Watt/cont.: 300 Watt/max.: 900	Dim.: 155x73x73 mm Weight: 0.900 kg Efficiency: 90 %	Type: Modified sine Over heating: Yes Overloading: Yes Short circuit: Yes Approvals: CE
<b>161089</b> Voltage Inverter Std pkg 1 	Voltage/in: 12 Voltage/out: 220-240 Alarm/Voltage: 10.5±0.5 Shut down/Voltage: 10±0.5 Amp/max/cont.: 60 Amp/standby: <0.6 Watt/cont.: 600 Watt/max.: 1500	Dim.: 190x113x62 mm Weight: 1.5 kg Efficiency: 85-90 %	Type: Modified sine Over heating: Yes Overloading: Yes Short circuit: Yes Approvals: CE Alternativ no.: 160545
<b>161090</b> Voltage Inverter Std pkg 1 	Voltage/in: 24 Voltage/out: 220-240 Alarm/Voltage: 21±1 Shut down/Voltage: 20±1 Amp/max/cont.: 30 Amp/standby: <0.4 Watt/cont.: 600 Watt/max.: 1500	Dim.: 190x113x62 mm Weight: 1.5 kg Efficiency: 85-90 %	Type: Modified sine Over heating: Yes Overloading: Yes Short circuit: Yes Approvals: CE Alternativ no.: 160546

		EL. SPECIFICATIONS	DIMENSIONS	ADI ADDITIONAL SPECIFICATIONS
161091	Voltage Inverter UK Std pkg 1	Voltage/in: 12 Voltage/out: 220-240 Alarm/Voltage: 10.5±0.5 Shut down/Voltage: 10±0.5 Amp/max/cont.: 60 Amp/standby: <0.6 Watt/cont.: 600 Watt/max.: 1500	Dim.: 190x113x62 mm Weight: 1.5 kg Efficiency: 85-90 %	Type: Modified sine Over heating: Yes Overloading: Yes Short circuit: Yes Approvals: CE Alternativ no.: 161704
NEW PRODUCT <a href="http://www.hc-cargo.com">www.hc-cargo.com</a>				
161092	Voltage Inverter UK Std pkg 1	Voltage/in: 24 Voltage/out: 220-240 Alarm/Voltage: 21±1 Shut down/Voltage: 20±1 Amp/max/cont.: 30 Amp/standby: <0.4 Watt/cont.: 600 Watt/max.: 1500	Dim.: 190x113x62 mm Weight: 1.5 kg Efficiency: 85-90 %	Type: Modified sine Over heating: Yes Overloading: Yes Short circuit: Yes Approvals: CE
NEW PRODUCT <a href="http://www.hc-cargo.com">www.hc-cargo.com</a>				
161093	Voltage Inverter Std pkg 1	Voltage/in: 12 Voltage/out: 220-240 Alarm/Voltage: 10.5±0.5 Shut down/Voltage: 10±0.5 Amp/max/cont.: 100 Amp/standby: <0.6 Watt/cont.: 1000 Watt/max.: 2400	Dim.: 340x135x79 mm Weight: 2.5 kg Efficiency: 85-90 %	Type: Modified sine Over heating: Yes Overloading: Yes Short circuit: Yes Approvals: CE Alternativ no.: 160660
NEW PRODUCT <a href="http://www.hc-cargo.com">www.hc-cargo.com</a>				
161094	Voltage Inverter Std pkg 1	Voltage/in: 24 Voltage/out: 220-240 Alarm/Voltage: 21±1 Shut down/Voltage: 20±1 Amp/max/cont.: 50 Amp/standby: <0.5 Watt/cont.: 1000 Watt/max.: 2400	Dim.: 340x135x79 mm Weight: 2.5 kg Efficiency: 85-90 %	Type: Modified sine Over heating: Yes Overloading: Yes Short circuit: Yes Approvals: CE Alternativ no.: 160676
NEW PRODUCT <a href="http://www.hc-cargo.com">www.hc-cargo.com</a>				
161095	Voltage Inverter UK Std pkg 1	Voltage/in: 12 Voltage/out: 220-240 Alarm/Voltage: 10.5±0.5 Shut down/Voltage: 10±0.5 Amp/max/cont.: 100 Amp/standby: <0.6 Watt/cont.: 1000 Watt/max.: 2400	Dim.: 340x135x79 mm Weight: 2.5 kg Efficiency: 85-90 %	Type: Modified sine Over heating: Yes Overloading: Yes Short circuit: Yes Approvals: CE Alternativ no.: 160660UK
NEW PRODUCT <a href="http://www.hc-cargo.com">www.hc-cargo.com</a>				
161096	Voltage Inverter UK Std pkg 1	Voltage/in: 24 Voltage/out: 220-240 Alarm/Voltage: 21±1 Shut down/Voltage: 20±1 Amp/max/cont.: 50 Amp/standby: <0.5 Watt/cont.: 1000 Watt/max.: 2400	Dim.: 340x135x79 mm Weight: 2.5 kg Efficiency: 85-90 %	Type: Modified sine Over heating: Yes Overloading: Yes Short circuit: Yes Approvals: CE Alternativ no.: 160676UK
NEW PRODUCT <a href="http://www.hc-cargo.com">www.hc-cargo.com</a>				
161097	Voltage Inverter Std pkg 1	Voltage/in: 12 Voltage/out: 220-240 Alarm/Voltage: 10.5±0.5 Shut down/Voltage: 10±0.5 Amp/max/cont.: 150 Amp/standby: <0.7 Watt/cont.: 1500 Watt/max.: 3000	Dim.: 400x135x79 mm Weight: 3.3 kg Efficiency: 85-90 %	Type: Modified sine Over heating: Yes Overloading: Yes Short circuit: Yes Approvals: CE Alternativ no.: 160569
NEW PRODUCT <a href="http://www.hc-cargo.com">www.hc-cargo.com</a>				

		EL. SPECIFICATIONS	DIMENSIONS	ADI ADDITIONAL SPECIFICATIONS
<b>161098</b>	Voltage Inverter Std pkg 1	Voltage/in: 24 Voltage/out: 220-240 Alarm/Voltage: 21±1 Shut down/Voltage: 20±1 Amp/max/cont.: 75 Amp/standby: <0.6 Watt/cont.: 1500 Watt/max.: 3000	Dim.: 400x135x79 mm Weight: 3.3 kg Efficiency: 85-90 %	Type: Modified sine Over heating: Yes Overloading: Yes Short circuit: Yes Approvals: CE Alternativ no.: 160581
NEW PRODUCT <a href="http://www.hc-cargo.com">www.hc-cargo.com</a>				
<b>161099</b>	Voltage Inverter UK Version Std pkg 1	Voltage/in: 12 Voltage/out: 220-240 Alarm/Voltage: 10.5±0.5 Shut down/Voltage: 10±0.5 Amp/max/cont.: 150 Amp/standby: <0.7 Watt/cont.: 1500 Watt/max.: 3000	Dim.: 400x135x79 mm Weight: 3.3 kg Efficiency: 85-90 %	Type: Modified sine Over heating: Yes Overloading: Yes Short circuit: Yes Approvals: CE Alternativ no.: 161705
NEW PRODUCT <a href="http://www.hc-cargo.com">www.hc-cargo.com</a>				
<b>161100</b>	Voltage Inverter UK Version Std pkg 1	Voltage/in: 24 Voltage/out: 220-240 Alarm/Voltage: 21±1 Shut down/Voltage: 20±1 Amp/max/cont.: 75 Amp/standby: <0.6 Watt/cont.: 1500 Watt/max.: 3000	Dim.: 400x135x79 mm Weight: 3.3 kg Efficiency: 85-90 %	Type: Modified sine Over heating: Yes Overloading: Yes Short circuit: Yes Approvals: CE Alternativ no.: 161706
NEW PRODUCT <a href="http://www.hc-cargo.com">www.hc-cargo.com</a>				
<b>161101</b>	Voltage Inverter Std pkg 1	Voltage/in: 12 Voltage/out: 220-240 Alarm/Voltage: 10.5±0.5 Shut down/Voltage: 10±0.5 Amp/max/cont.: 70 Amp/standby: <0.9 Watt/cont.: 700 Watt/max.: 1400	Dim.: 340x135x79 mm Weight: 2.1 kg Efficiency: >85 %	Type: Sinus Over heating: Yes Overloading: Yes Short circuit: Yes Approvals: CE
NEW PRODUCT <a href="http://www.hc-cargo.com">www.hc-cargo.com</a>				
<b>161102</b>	Voltage Inverter Std pkg 1	Voltage/in: 24 Voltage/out: 220-240 Alarm/Voltage: 21±1 Shut down/Voltage: 20±1 Amp/max/cont.: 35 Amp/standby: <0.6 Watt/cont.: 700 Watt/max.: 1400	Dim.: 340x135x79 mm Weight: 2.1 kg Efficiency: >85 %	Type: Sinus Over heating: Yes Overloading: Yes Short circuit: Yes Approvals: CE
NEW PRODUCT <a href="http://www.hc-cargo.com">www.hc-cargo.com</a>				
<b>161103</b>	Voltage Inverter UK Std pkg 1	Voltage/in: 12 Voltage/out: 220-240 Alarm/Voltage: 10.5±0.5 Shut down/Voltage: 10±0.5 Amp/max/cont.: 70 Amp/standby: <0.9 Watt/cont.: 700 Watt/max.: 1400	Dim.: 340x135x79 mm Weight: 2.1 kg Efficiency: >85 %	Type: Sinus Over heating: Yes Overloading: Yes Short circuit: Yes Approvals: CE
NEW PRODUCT <a href="http://www.hc-cargo.com">www.hc-cargo.com</a>				
<b>161104</b>	Voltage Inverter UK Std pkg 1	Voltage/in: 24 Voltage/out: 220-240 Alarm/Voltage: 21±1 Shut down/Voltage: 20±1 Amp/max/cont.: 35 Amp/standby: <0.6 Watt/cont.: 700 Watt/max.: 1400	Dim.: 340x135x79 mm Weight: 2.1 kg Efficiency: >85 %	Type: Sinus Over heating: Yes Overloading: Yes Short circuit: Yes Approvals: CE
NEW PRODUCT <a href="http://www.hc-cargo.com">www.hc-cargo.com</a>				

161105 Voltage Inverter		Std pkg 1	
<p><b>NEW PRODUCT</b> www.hc-cargo.com</p>	Voltage/in: 12 Voltage/out: 220-240 Alarm/Voltage: 10.5±0.5 Shut down/Voltage: 10±0.5 Amp/max/cont.: 110 Amp/standby: <1.3 Watt/cont.: 1000 Watt/max.: 2000	Dim.: 360x195x80 mm Weight: 4.1 kg Efficiency: >85 %	Type: Sinus Over heating: Yes Overloading: Yes Short circuit: Yes Approvals: CE
161106 Voltage Inverter		Std pkg 1	
<p><b>NEW PRODUCT</b> www.hc-cargo.com</p>	Voltage/in: 24 Voltage/out: 220-240 Alarm/Voltage: 21±1 Shut down/Voltage: 20±1 Amp/max/cont.: 55 Amp/standby: <1 Watt/cont.: 1000 Watt/max.: 2000	Dim.: 360x195x80 mm Weight: 4.1 kg Efficiency: >85 %	Type: Sinus Over heating: Yes Overloading: Yes Short circuit: Yes Approvals: CE
161107 Voltage Inverter UK		Std pkg 1	
<p><b>NEW PRODUCT</b> www.hc-cargo.com</p>	Voltage/in: 12 Voltage/out: 220-240 Alarm/Voltage: 10.5±0.5 Shut down/Voltage: 10±0.5 Amp/max/cont.: 110 Amp/standby: <1.3 Watt/cont.: 1000 Watt/max.: 2000	Dim.: 360x195x80 mm Weight: 4.1 kg Efficiency: >85 %	Type: Sinus Over heating: Yes Overloading: Yes Short circuit: Yes Approvals: CE
161108 Voltage Inverter UK		Std pkg 1	
<p><b>NEW PRODUCT</b> www.hc-cargo.com</p>	Voltage/in: 24 Voltage/out: 220-240 Alarm/Voltage: 21±1 Shut down/Voltage: 20±1 Amp/max/cont.: 55 Amp/standby: <1 Watt/cont.: 1000 Watt/max.: 2000	Dim.: 360x195x80 mm Weight: 4.1 kg Efficiency: >85 %	Type: Sinus Over heating: Yes Overloading: Yes Short circuit: Yes Approvals: CE
161109 Voltage Inverter		Std pkg 1	
<p><b>NEW PRODUCT</b> www.hc-cargo.com</p>	Voltage/in: 12 Voltage/out: 220-240 Alarm/Voltage: 10.5±0.5 Shut down/Voltage: 10±0.5 Amp/max/cont.: 160 Amp/standby: <1.3 Watt/cont.: 1500 Watt/max.: 3000	Dim.: 430x245x85 mm Weight: 5.2 kg Efficiency: >85 %	Type: Sinus Over heating: Yes Overloading: Yes Short circuit: Yes Approvals: CE
161110 Voltage Inverter		Std pkg 1	
<p><b>NEW PRODUCT</b> www.hc-cargo.com</p>	Voltage/in: 24 Voltage/out: 220-240 Alarm/Voltage: 21±1 Shut down/Voltage: 20±1 Amp/max/cont.: 80 Amp/standby: <1 Watt/cont.: 1500 Watt/max.: 3000	Dim.: 430x245x85 mm Weight: 5.2 kg Efficiency: >85 %	Type: Sinus Over heating: Yes Overloading: Yes Short circuit: Yes Approvals: CE
161111 Voltage Inverter UK		Std pkg 1	
<p><b>NEW PRODUCT</b> www.hc-cargo.com</p>	Voltage/in: 12 Voltage/out: 220-240 Alarm/Voltage: 10.5±0.5 Shut down/Voltage: 10±0.5 Amp/max/cont.: 160 Amp/standby: <1.3 Watt/cont.: 1500 Watt/max.: 3000	Dim.: 430x245x85 mm Weight: 5.2 kg Efficiency: >85 %	Type: Sinus Over heating: Yes Overloading: Yes Short circuit: Yes Approvals: CE



		EL. SPECIFICATIONS	DIMENSIONS	ADI ADDITIONAL SPECIFICATIONS
161112	Voltage Inverter UK Std pkg 1	<p><b>NEW PRODUCT</b> <a href="http://www.hc-cargo.com">www.hc-cargo.com</a></p> Voltage/in: 24 Voltage/out: 220-240 Alarm/Voltage: 21±1 Shut down/Voltage: 20±1 Amp/max/cont.: 80 Amp/standby: <1 Watt/cont.: 1500 Watt/max.: 3000	Dim.: 430x245x85 mm Weight: 5.2 kg Efficiency: >85 %	Type: Sinus Over heating: Yes Overloading: Yes Short circuit: Yes Approvals: CE
161113	Voltage Inverter Std pkg 1	<p><b>NEW PRODUCT</b> <a href="http://www.hc-cargo.com">www.hc-cargo.com</a></p> Voltage/in: 12 Voltage/out: 220-240 Alarm/Voltage: 10.5±0.5 Shut down/Voltage: 10±0.5 Amp/max/cont.: 250 Amp/standby: <0.8 Watt/cont.: 2500 Watt/max.: 5000	Dim.: 340x135x148 mm Weight: 4.5 kg Efficiency: 85-90 %	Type: Modified sine Over heating: Yes Overloading: Yes Short circuit: Yes Approvals: CE
161114	Voltage Inverter Std pkg 1	<p><b>NEW PRODUCT</b> <a href="http://www.hc-cargo.com">www.hc-cargo.com</a></p> Voltage/in: 24 Voltage/out: 220-240 Alarm/Voltage: 21±1 Shut down/Voltage: 20±1 Amp/max/cont.: 125 Amp/standby: <0.7 Watt/cont.: 2500 Watt/max.: 5000	Dim.: 340x135x148 mm Weight: 4.5 kg Efficiency: 85-90 %	Type: Modified sine Over heating: Yes Overloading: Yes Short circuit: Yes Approvals: CE
161115	Voltage Inverter UK Std pkg 1	<p><b>NEW PRODUCT</b> <a href="http://www.hc-cargo.com">www.hc-cargo.com</a></p> Voltage/in: 12 Voltage/out: 220-240 Alarm/Voltage: 10.5±0.5 Shut down/Voltage: 10±0.5 Amp/max/cont.: 250 Amp/standby: <0.8 Watt/cont.: 2500 Watt/max.: 5000	Dim.: 340x135x148 mm Weight: 4.5 kg Efficiency: 85-90 %	Type: Modified sine Over heating: Yes Overloading: Yes Short circuit: Yes Approvals: CE
161116	Voltage Inverter UK Std pkg 1	<p><b>NEW PRODUCT</b> <a href="http://www.hc-cargo.com">www.hc-cargo.com</a></p> Voltage/in: 24 Voltage/out: 220-240 Alarm/Voltage: 21±1 Shut down/Voltage: 20±1 Amp/max/cont.: 125 Amp/standby: <0.7 Watt/cont.: 2500 Watt/max.: 5000	Dim.: 340x135x148 mm Weight: 4.5 kg Efficiency: 85-90 %	Type: Modified sine Over heating: Yes Overloading: Yes Short circuit: Yes Approvals: CE
161704	Voltage Inverter UK Std pkg 1	 Voltage/in: 12 Voltage/out: 230 Alarm/Voltage: 10.5±0.5 Shut down/Voltage: 10±0.5 Amp/standby: <1.35 Watt/cont.: 600 Watt/max.: 1500	Dim.: 242x91x58 mm Weight: 1.7 kg Regulation: ±10	Type: Modified sine Over heating: Yes Overloading: Yes Short circuit: Yes Approvals: CE Alternativ no.: 161091
161705	Voltage Inverter UK Std pkg 1	 Voltage/in: 10-15 Voltage/out: 230 Alarm/Voltage: 10.5±0.5 Shut down/Voltage: 10±0.5 Amp/standby: 1 Watt/cont.: 1500 Watt/max.: 3500	Dim.: 395x240x90 mm Weight: 5.5 kg	Type: Modified sine Over heating: Yes Overloading: Yes Short circuit: Yes Approvals: CE Alternativ no.: 161099

<b>161706</b> Voltage Inverter UK Std pkg 1		Voltage/in: 20-30 Voltage/out: 230 Alarm/Voltage: 21±1 Shut down/Voltage: 20±1 Amp/standby: <1 Watt/cont.: 1500 Watt/max.: 3500	Dim.: 395x240x90 mm Weight: 5.5 kg	Type: Modified sine Over heating: Yes Overloading: Yes Short circuit: Yes Approvals: CE Alternativ no.: 161100
<b>161707</b> Voltage Inverter UK Std pkg 1		Voltage/in: 12 Voltage/out: 230 Alarm/Voltage: 10.5±0.5 Shut down/Voltage: 10±0.5 Amp/standby: <0.3 Watt/cont.: 1000 Watt/max.: 2500	Dim.: 310x205x75 mm Weight: 5 kg Regulation: ±10	Type: Modified sine Over heating: Yes Overloading: Yes Short circuit: Yes Approvals: CE
<b>161710</b> Voltage Inverter Std pkg 1		Voltage/in: 24 Voltage/out: 230 Alarm/Voltage: 21±1 Shut down/Voltage: 20±1 Amp/standby: <0.8 Watt/cont.: 1000 Watt/max.: 2500	Dim.: 310x205x75 mm Weight: 5 kg Regulation: ±10	Type: Modified sine Over heating: Yes Overloading: Yes Short circuit: Yes Approvals: CE

## ACCESSORIES

<b>161045</b> Remote Control Std pkg 1		Servicing: HC-CARGO 160569, 160569UK, 160660, 160660UK, 160581, 160581UK, 160676, 160676UK		
--	--	--	--	--

## VOLTAGE REDUCER

<b>160627</b> Voltage Reducer Std pkg 1	Set w/ 2 resistors. Reduces the voltage w/ 0.75 V. Secures the lifetime of the headlight bulbs in cars w/ high voltage. 12/24 V.			

<b>161042</b> Voltage Reducer Std pkg 1	Protects electronics against voltage peaks.			
	Voltage: 12-14	Length: 27 mm Width: 33 mm ID/mount. hole: 8 mm		

## LOAD RESISTORS

<b>160970</b> Load Resistor 12 V Std pkg 1	Contains: 2 pcs.			
	Voltage: 12 Amp: 2 Watt: 50 Ohm: 6	Length: 50 mm Width: 15 mm		

<b>160971</b> Load Resistor 24 V Std pkg 1 Contains: 2 pcs.		Voltage: 24 Amp: 1 Watt: 50 Ohm: 24	Length: 50 mm Width: 15 mm	
--	--	--	-------------------------------	--

## CHARGERS

<b>160874</b> Charger Std pkg 1		Voltage: 23/24 Amp: 12	Weight: 1.660 kg Working temp.: -30 - +55 °C	Warning lamp: w/ Auto stop: Yes Protection degree: IP 67 Approvals: CE
---------------------------------	--	---------------------------	--	---

<b>160875</b> Charger Std pkg 1		Voltage: 230/12 Amp: 17	Weight: 1.660 kg Working temp.: -30 - +55 °C	Warning lamp: w/ Auto stop: Yes Protection degree: IP 67 Approvals: CE
---------------------------------	--	----------------------------	--	---

<b>161026</b> Charger Std pkg 1 Charger cable: HC-CARGO 160990.		Voltage: 230/12 Amp: 5 Hertz: 50	Dim.: 170x73x48 mm Working temp.: -20 - +50 °C	Warning lamp: w/ Protection degree: IP 65 Approvals: CE Alternativ no.: 160969
--	--	--	--	---

<b>161701</b> UK Charger Std pkg 1 Charger cable: HC-CARGO 160990.		Voltage: 230/12 Amp: 5 Hertz: 50	Working temp.: -20 - +50 °C	Warning lamp: w/ Protection degree: IP 65 Approvals: CE Alternativ no.: 161026UK
---	--	--	--------------------------------	---

## ACCESSORIES

<b>160990</b> Charger cable Std pkg 1 Servicing: HC-CARGO 161026, 161701		Voltage: 300	Rolls size: 0.3 m Temp. area: 60 °C	Lead type: Dual Cap colour: Black Cap material: PVC
--	--	--------------	--	---

## POWER GUARD

**161014** Power Guard Std pkg 1

Voltage/in: 9-32  
 Alarm/Voltage: Yes  
 Shut down/Voltage: Yes  
 Shut down/12 V: 11.5  
 Shut down/24 V: 23  
 Amp/max/cont.: 10

Dim.: 155x30x15 mm  
 Weight: 045 kg  
 Regulation: Yes

Connection: Connection  
 Over heating: Yes  
 Overloading: Yes  
 Short circuit: Yes

**161015** Power Guard Std pkg 1

Voltage/in: 9-32  
 Alarm/Voltage: Yes  
 Shut down/Voltage: Yes  
 Shut down/12 V: 11.5  
 Shut down/24 V: 23  
 Amp/max/cont.: 20

Dim.: 155x30x15 mm  
 Weight: 045 kg  
 Regulation: Yes

Connection: Connection  
 Over heating: Yes  
 Overloading: Yes  
 Short circuit: Yes

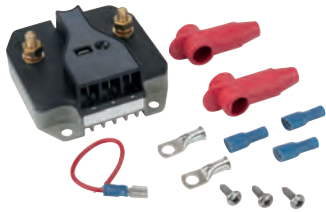
**161016** Power Guard Std pkg 1

Voltage/in: 9-32  
 Alarm/Voltage: Yes  
 Shut down/Voltage: Yes  
 Shut down/12 V: 11.5  
 Shut down/24 V: 23  
 Amp/max/cont.: 40

Dim.: 76x78x33 mm  
 Weight: 0.155 kg  
 Regulation: Yes

Connection: M6  
 Over heating: Yes  
 Overloading: Yes  
 Short circuit: Yes

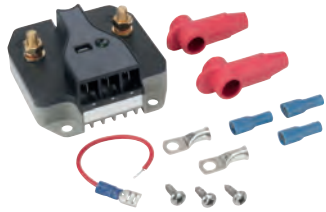
**161017** Power Guard Std pkg 1

Voltage/in: 9-32  
 Alarm/Voltage: Yes  
 Shut down/Voltage: Yes  
 Shut down/12 V: 11.5  
 Shut down/24 V: 23  
 Amp/max/cont.: 60

Dim.: 76x78x33 mm  
 Weight: 0.155 kg  
 Regulation: Yes

Connection: M6  
 Over heating: Yes  
 Overloading: Yes  
 Short circuit: Yes

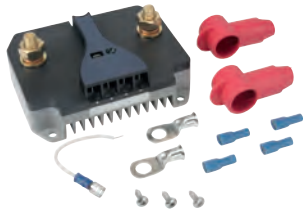
**161018** Power Guard Std pkg 1

Voltage/in: 9-32  
 Alarm/Voltage: Yes  
 Shut down/Voltage: Yes  
 Shut down/12 V: 11.5  
 Shut down/24 V: 23  
 Amp/max/cont.: 100

Dim.: 124x97x51 mm  
 Weight: 0.530 kg  
 Regulation: Yes

Connection: M10  
 Over heating: Yes  
 Overloading: Yes  
 Short circuit: Yes

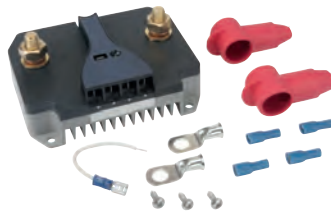
**161019** Power Guard Std pkg 1

Voltage/in: 9-32  
 Alarm/Voltage: Yes  
 Shut down/Voltage: Yes  
 Shut down/12 V: 11.5  
 Shut down/24 V: 23  
 Amp/max/cont.: 200

Dim.: 124x97x51 mm  
 Weight: 0.530 kg  
 Regulation: Yes

Connection: M10  
 Over heating: Yes  
 Overloading: Yes  
 Short circuit: Yes

## BATTERY ISOLATORS

**160342** Battery Isolator Std pkg 1

Servicing: Boats, autocampers, industrial vehicles - Visit [www.hc-cargo.com](http://www.hc-cargo.com) for further information.

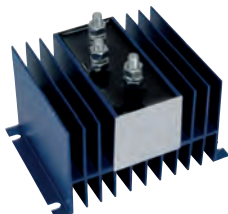

*Eliminates the multi battery drain when 2 or more batteries are in a charging system.*







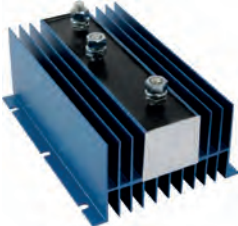

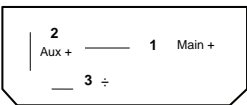

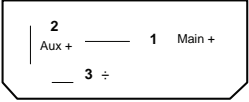

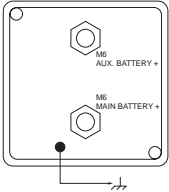

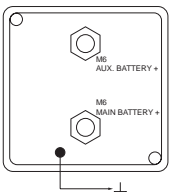



Voltage: 6-36  
 Current/max Amp: 70

Dim.: 85x115x95 mm

No./batteries: 2  
 Comp. diode: No

		EL. SPECIFICATIONS	DIMENSIONS	ADDITIONAL SPECIFICATIONS
<b>160343</b> Battery Isolator	Std pkg 1	Servicing: Boats, autocampers, industrial vehicles - Visit <a href="http://www.hc-cargo.com">www.hc-cargo.com</a> for further information.		
<i>Eliminates the multi battery drain when 2 or more batteries are in a charging system. w/ compensationsdiode which allows a higher charging current.</i>				
		Voltage: 6-36 Current/max Amp: 70	Dim.: 85x115x95 mm	No./batteries: 2 Comp. diode: Yes
<b>160398</b> Battery Isolator	Std pkg 1	Servicing: Boats, autocampers, industrial vehicles - Visit <a href="http://www.hc-cargo.com">www.hc-cargo.com</a> for further information.		
<i>Eliminates the multi battery drain when 2 or more batteries are in a charging system.</i>				
		Voltage: 6-36 Current/max Amp: 120	Dim.: 170x115x95 mm	No./batteries: 2 Comp. diode: No
<b>160399</b> Battery Isolator	Std pkg 1	Servicing: Boats, autocampers, industrial vehicles - Visit <a href="http://www.hc-cargo.com">www.hc-cargo.com</a> for further information.		
<i>Eliminates the multi battery drain when 2 or more batteries are in a charging system. w/ compensationsdiode which allows a higher charging current.</i>				
		Voltage: 6-36 Current/max Amp: 120	Dim.: 170x115x95 mm	No./batteries: 2 Comp. diode: Yes
<b>160740</b> Split Charge Relay 12V	Std pkg 1	Servicing: Boats, autocampers, industrial vehicles - Visit <a href="http://www.hc-cargo.com">www.hc-cargo.com</a> for further information.		
<i>Microprocessor controlled relay. Allows charging on the auxiliary battery at 13.4 V charging voltage.</i>				
		Voltage: 12 Current/max Amp: 180	Dim.: 120x80x55 mm	No./batteries: 2 Comp. diode: No
<b>160742</b> Split Charge Relay	Std pkg 1	Servicing: Boats, autocampers, industrial vehicles - Visit <a href="http://www.hc-cargo.com">www.hc-cargo.com</a> for further information.		
<i>Microprocessor controlled relay. Allows charging on the auxiliary battery at 27 V charging voltage.</i>				
		Voltage: 24 Current/max Amp: 100	Dim.: 120x80x70 mm	No./batteries: 2 Comp. diode: No
<b>160876</b> Split Charge Relay	Std pkg 1	Servicing: Boats, autocampers, industrial vehicles - Visit <a href="http://www.hc-cargo.com">www.hc-cargo.com</a> for further information.		
<i>13.4 V-12.6 V.</i>				
		Voltage: 12 Current/max Amp: 70	Dim.: 60x34x70 mm	No./batteries: 2 Comp. diode: No

		EL. SPECIFICATIONS	DIMENSIONS	ADDITIONAL SPECIFICATIONS
<b>160877</b> Split Charge Relay Std pkg 1				
		Voltage: 24 Current/max Amp: 50	Dim.: 60x34x70 mm	No./batteries: 2 Comp. diode: No
<b>161059</b> Split Charge Relay 12V Std pkg 1				
12.8 V-13.3 V				
		Voltage: 12 Current/max Amp: 140	Dim.: 67x67x50 mm	No./batteries: 2 Comp. diode: No
<b>161060</b> Split Charge Relay Std pkg 1				
25.6 V-26.6 V				
		Voltage: 24 Current/max Amp: 140	Dim.: 67x67x50 mm	No./batteries: 2 Comp. diode: No
<b>SWITCHES</b>				
<b>BATTERY SWITCHES</b>				
<b>180028</b> Battery Main Switch Std pkg 1				
Spare key: HC-CARGO 180028, 180143, 180619, 181270. Pole: dia. 10 mm.				
		Voltage: 24 Amp/5 sec.: 500 Amp/cont.: 100	Dist. mount. holes: 38 mm	Type: Battery Material: Plastic No./mounting holes: 2 Key: w/ Protection degree: IP 65
<b>180087</b> Battery Main Switch Std pkg 1				
Spare key: HC-CARGO 180202.				
		Voltage: 24 Amp/5 sec.: 2500 Amp/cont.: 250	Dist. mount. holes: 100 mm	Type: Battery Material: Metal No./mounting holes: 2 Key: w/ Protection degree: IP 66
<b>180203</b> Battery Main Switch Std pkg 1				
Spare key: HC-CARGO 180029, 180619.				
		Voltage: 24 Amp/5 sec.: 2500 Amp/cont.: 250	Dist. mount. holes: 100 mm	Type: Battery Material: Plastic No./mounting holes: 2 No./poles: 2 Key: w/ Protection degree: IP 66
<b>180211</b> Battery Main Switch Std pkg 1				
Spare key: HC-CARGO 180288, 180333. Rubber boot: HC-CARGO 180375.				
		Voltage: 24 Amp/5 sec.: 2500 Amp/cont.: 250	Dist. mount. holes: 100 mm	Type: Battery Material: Metal No./mounting holes: 2 Key: w/ Protection degree: IP 65 Alternativ no.: 181475

<b>180216 Battery Main Switch</b> Std pkg 1 <i>Spare key: HC-CARGO 180029, 180143, 180619, 181270. Rubber protection cap: HC-CARGO 180374.</i>			
	Voltage: 24 Amp/5 sec.: 500 Amp/cont.: 100	Dist. mount. holes: 39.5 mm	Type: Battery Material: Plastic No./mounting holes: 2 No./poles: M8 Key: w/ Protection degree: IP 40
<b>180229 Battery Main Switch</b> Std pkg 1 <i>Spare key: HC-CARGO 180029, 180619, 181270. On/Off under load.</i>			
	Voltage: 24 Amp/5 sec.: 2500 Amp/cont.: 250	Dist. mount. holes: 100 mm	Type: Battery Material: Plastic No./mounting holes: 2 Key: w/ Protection degree: IP 66
<b>180289 Battery Main Switch</b> Std pkg 1 <i>Rubber boot: HC-CARGO 180375.</i>			
	Voltage: 24 Amp/5 sec.: 2500 Amp/cont.: 250	Dist. mount. holes: 30 mm	Type: Battery Material: Metal No./mounting holes: 2 Key: w/ Protection degree: IP 65
<b>180313 Battery Main Switch</b> Std pkg 1 <i>Spare key: HC-CARGO 180029, 180143, 181270. Rubber protection cap: HC-CARGO 180374.</i>			
	Voltage: 24 Amp/5 sec.: 500 Amp/cont.: 100	Dist. mount. holes: 45 mm	Type: Battery No./mounting holes: 2 Key: w/o Protection degree: IP 40
<b>180326 Battery Main Switch</b> Std pkg 1 <i>Rubber boot: HC-CARGO 180375. w/ rotation/press handle.</i>			
	Voltage: 24 Amp/5 sec.: 2500 Amp/cont.: 250	Dist. mount. holes: 100 mm	Type: Battery No./mounting holes: 2 Protection degree: IP 65
<b>180596 Battery Main Switch</b> Std pkg 1 <i>Spare key: HC-CARGO 180029, 180619.</i>			
	Voltage: 24 Amp/5 sec.: 500 Amp/cont.: 100	Dist. mount. holes: 38 mm	Type: Battery Material: Plastic No./mounting holes: 2 Key: w/ Resistor: 3 Ohm, 11 W Sec. circuit: w/ Protection degree: IP 43
<b>180614 Battery Main Switch</b> Std pkg 1 <i>Spare key: HC-CARGO 181578.</i>			
	Voltage: 24 Amp/5 sec.: 1000 Amp/cont.: 75	Dist. mount. holes: 38 mm	Type: Battery Material: Metal No./mounting holes: 2 Key: w/ Protection degree: IP 41

**181475 Battery Main Switch** Std pkg 1

*Spare key: HC-CARGO 180288, w/o chain and rubber cap. Rubber boot: HC-CARGO 180375.*

 Voltage: 24  
 Amp/5 sec.: 2500  
 Amp/cont.: 250

 Dist. mount. holes:  
 100 mm

 Material: Metal  
 No./mounting holes: 2  
 Key: w/  
 Protection degree: IP 65

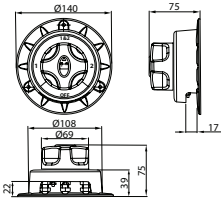
**181613 Battery Main Switch** Std pkg 1

 Voltage: 12-50  
 Amp/5 sec.: 1000  
 Amp/cont.: 200

 Dist. mount. holes:  
 104 mm

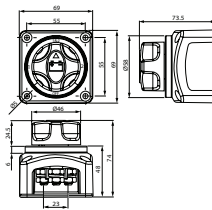
 Type: Battery  
 Material: PBT  
 No./mounting holes: 3  
 No./poles: 3  
 Key: w/o  
 Protection degree: IP 54  
 Approval: CE

**181614 Battery Main Switch** Std pkg 1

 Voltage: 12-50  
 Amp/5 sec.: 1000  
 Amp/cont.: 200

 Dist. mount. holes:  
 55 mm

 Type: Battery  
 Material: PBT  
 No./mounting holes: 4  
 No./poles: 2  
 Key: w/  
 Protection degree: IP 54  
 Approval: CE

**WATERPROOF**
**180271 Battery Main Switch** Std pkg 1

*Rubber boot: HC-CARGO 180375. Working temp. -30°C/+65°C.*

 Voltage: 12/24  
 Amp/5 sec.: 1000  
 Amp/cont.: 300

 Dist. mount. holes:  
 45 mm

 Type: Battery  
 Material: Plastic  
 Explosion proof 1: Yes  
 No./mounting holes: 2  
 No./poles: M10  
 Key: w/  
 Waterproof: Yes  
 Protection degree: IP 65  
 Approval: SAE J1171

**180272 Battery Main Switch** Std pkg 1 Servicing: Marine - Visit [www.hc-cargo.com](http://www.hc-cargo.com) for further information.

*Spare key: HC-CARGO 180273. Rubber boot: HC-CARGO 180375.*

 Voltage: 24  
 Amp/5 sec.: 1000  
 Amp/cont.: 150

 Dist. mount. holes:  
 45 mm

 Type: Battery  
 Material: Metal  
 Explosion proof 1: Yes  
 No./mounting holes: 2  
 Key: w/  
 Waterproof: Yes  
 Protection degree: IP 68

**180274 Battery Main Switch** Std pkg 1

*Rubber boot: HC-CARGO 180375. For alternator w/ separate regulator.*

 Voltage: 24  
 Amp/5 sec.: 2500  
 Amp/cont.: 250

 Dist. mount. holes:  
 65 mm

 Type: Battery  
 Material: Metal  
 Explosion proof 1: Yes  
 No./mounting holes: 2  
 Key: w/  
 Waterproof: Yes  
 Protection degree: IP 67

**180275 Battery Main Switch** Std pkg 1





*Rubber boot: HC-CARGO 180375. For alternator w/ intergral regulator. w/ D+ contact.*

 Voltage: 24  
 Amp/5 sec.: 2500  
 Amp/cont.: 250

 Dist. mount. holes:  
 65 mm

 Type: Battery  
 Material: Metal  
 Explosion proof 1: Yes  
 No./mounting holes: 2  
 Key: w/  
 Waterproof: Yes  
 Protection degree: IP 67

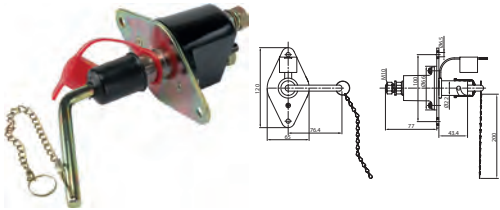
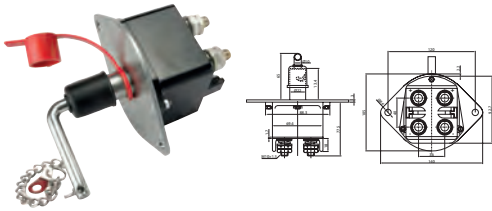

	EL. SPECIFICATIONS	DIMENSIONS	ADDITIONAL SPECIFICATIONS
<b>180276 Battery Main Switch</b> Std pkg 1 <i>Rubber boot: HC-CARGO 180375. For alternator w/ intergral regulator. w/ D+ contact.</i>			
	Voltage: 24 Amp/5 sec.: 2500 Amp/cont.: 250	Dist. mount. holes: 110 mm	Type: Battery Material: Metal Explosion proof 1: Yes Explosion proof 2: Yes No./mounting holes: 2 No./poles: 2 Key: w/ Waterproof: Yes Protection degree: IP 67 Approval: ADR
<b>180277 Battery Main Switch</b> Std pkg 1 <i>Rubber boot: HC-CARGO 180375 . For alternator w/ separate regulator.</i>			
	Voltage: 24 Amp/5 sec.: 2500 Amp/cont.: 250	Dist. mount. holes: 110 mm	Type: Battery Material: Metal Explosion proof 1: Yes Explosion proof 2: Yes No./mounting holes: 2 No./poles: 2 Key: w/ Waterproof: Yes Protection degree: IP 67
<b>180278 Battery Main Switch</b> Std pkg 1 <i>Spare key: HC-CARGO 181477. Rubber boot: HC-CARGO 180375.</i>			
	Voltage: 24 Amp/5 sec.: 3000 Amp/cont.: 300	Dist. mount. holes: 100 mm	Type: Battery Material: Metal Explosion proof 1: Yes No./mounting holes: 2 Key: w/ Waterproof: Yes Protection degree: IP 68
<b>180338 Battery Main Switch</b> Std pkg 1 <i>For alternator w/ separate regulator. w/ secondary circuit 24 V. Rubber boot: HC-CARGO 180375.</i>			
	Voltage: 24 Amp/5 sec.: 2500 Amp/cont.: 20	Dist. mount. holes: 65 mm	Type: Battery Material: Plastic Explosion proof 1: Yes No./mounting holes: 2 Key: w/ Sec. circuit: w/ Waterproof: Yes Protection degree: IP 67
<b>181238 Battery Main Switch</b> Std pkg 1 <i>Spare key: HC-CARGO 180333. Rubber boot: HC-CARGO 180375.</i>			
	Voltage: 24 Amp/5 sec.: 2500 Amp/cont.: 250	Dist. mount. holes: 100 mm	Type: Battery Material: Metal No./mounting holes: 2 Key: w/ Waterproof: Yes Protection degree: IP 66
<b>181599 Battery Main Switch</b> Std pkg 1 <i>Rubber boot: HC-CARGO 180375. Spare key: HC-CARGO 181603.</i>			
	Voltage: 12-24 Amp/5 sec.: 2500 Amp/cont.: 250	Dist. mount. holes: 120 mm	Type: Battery Material: Metal No./mounting holes: 2 No./poles: 4 Key: w/ Waterproof: Yes Protection degree: IP 66

**RUBBER BOOTS**
**180374** Terminal Boot      Std pkg 10      Servicing: HC-CARGO 180216, 180313

Material: Rubber

**180375** Terminal Boot set      Std pkg 1      Servicing: HC-CARGO 180211, 180271, 180272, 180274, 180275, 180276, 180277, 180278, 180289, 180326, 180338, 180238, 181475, 181599

*Supplied in kit of 2 pcs.*

Material: Rubber

**SPARE KEYS**
**180029** Key      Std pkg 10      Servicing: HC-CARGO 180028, 180203, 180216, 180229, 180313, 180596

Shaft length: 11 mm

No./pins: 2

**180143** Key      Std pkg 10      Servicing: HC-CARGO 180028, 180216, 180313









Shaft length: 9 mm

**180202** Key      Std pkg 1      Servicing: HC-CARGO 180087

**180273** Key      Std pkg 1      Servicing: HC-CARGO 180272

**180288** Key      Std pkg 5      Servicing: HC-CARGO 180211, 181475

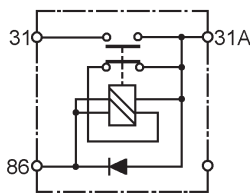

No./pins: 2

		EL. SPECIFICATIONS	DIMENSIONS	ADDITIONAL SPECIFICATIONS
<b>180333</b> Key	Std pkg 5	Servicing: HC-CARGO 180211, 181238		No./pins: 1
				
<b>180619</b> Key	Std pkg 10	Servicing: HC-CARGO 180028, 180203, 180216, 180229, 180596		No./pins: 1 Alternativ no.: 181270
			Shaft length: 11 mm	
<b>181270</b> Key	Std pkg 10	Servicing: HC-CARGO 180028, 180216, 180229, 180313		No./pins: 1 Alternativ no.: 180619
			Shaft length: 11 mm	
<b>181477</b> Key	Std pkg 1	Servicing: HC-CARGO 180278		
				
<b>181578</b> Key	Std pkg 1	Servicing: HC-CARGO 180614		
<i>For battery main switch.</i>				
				
<b>181603</b> Key	Std pkg 1	Servicing: HC-CARGO 181599		
<i>For battery main switch.</i>				
				
<b>ELECTROMAGNETIC</b>				
<b>180232</b> Battery Switch	Std pkg 1	Servicing: Industrial vehicles, buses, tractors, lift trucks and boats - Visit <a href="http://www.hc-cargo.com">www.hc-cargo.com</a> for further information.		
<i>These devices are designed to disconnect and protect the batteries and all the vehicle's electrical circuits. Depending on the model, the isolation switches are able to disconnect either the negative, the positive or both sides of the battery. The models with separate coil power supply can also be used to disconnect any other type of electrical circuit (e.g. marine applications). For serial or parallel connected batteries 250 Amp. Continued, 2500 Amp. For 5 sec. negative disconnection.</i>				
		Voltage: 12 Amp/5 sec.: 2500 Amp/cont.: 250		Type: Electromagnetic Switch: Negative Protection degree: IP 65

**180233 Battery Switch** Std pkg 1

Servicing: Industrial vehicles, buses, tractors, lift trucks and boats - Visit [www.hc-cargo.com](http://www.hc-cargo.com) for further information.

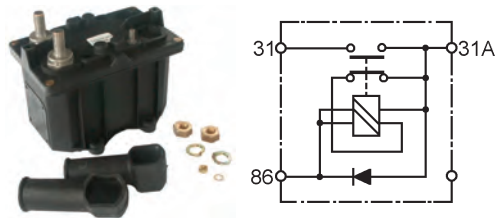
*These devices are designed to disconnect and protect the batteries and all the vehicle's electrical circuits. Depending on the model, the isolation switches are able to disconnect either the negative, the positive or both sides of the battery. The models with separate coil power supply can also be used to disconnect any other type of electrical circuit (e.g. marine applications). For serial or parallel connected batteries 250 Amp. Continued, 2500 Amp. For 5 sec. negative disconnection.*



Voltage: 24  
Amp/5 sec.: 2500  
Amp/cont.: 250

Type: Electromagnetic  
Switch: Negative  
Protection degree: IP 65

**180290 Battery Switch Relay** Std pkg 1

For serial and parallel connection of two 12 V batteries in 12 V systems w/ 24 V starter.



Voltage: 12/24  
Amp/5 sec.: 1500  
(1 sec)  
Amp/cont.: 75

**180556 Battery Switch** Std pkg 1

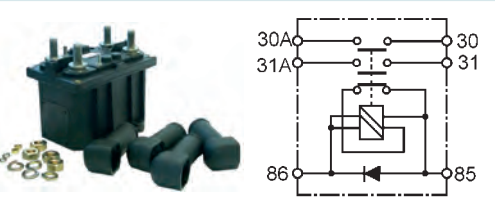

Voltage: 24  
Amp/5 sec.: 2500  
Amp/cont.: 250

Type: Electromagnetic  
Switch: Positive/Negative  
Protection degree: IP 65

**180602 Battery Switch** Std pkg 1

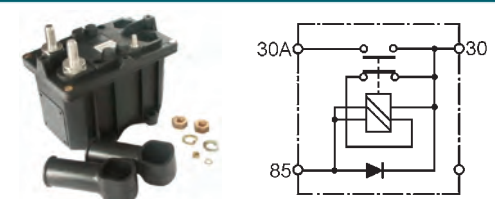

Voltage: 12  
Amp/5 sec.: 2500  
Amp/cont.: 250

Type: Electromagnetic  
Switch: Positive  
Protection degree: IP 65

**180603 Battery Switch** Std pkg 1

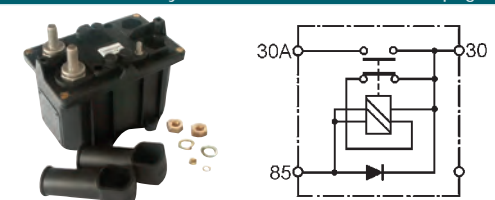

Voltage: 24  
Amp/5 sec.: 2500  
Amp/cont.: 200

Type: Electromagnetic  
Switch: Positive  
Protection degree: IP 65

**180604 Battery Switch** Std pkg 1

w/ separate power supply.



Voltage: 12  
Amp/5 sec.: 2500  
Amp/cont.: 250

Type: Electromagnetic  
Switch: Positive/Negative  
Protection degree: IP 65

**180605 Battery Switch** Std pkg 1

w/ separate power supply.



Voltage: 24  
Amp/5 sec.: 2500  
Amp/cont.: 200

Type: Electromagnetic  
Switch: Positive/Negative  
No./mounting holes: 4  
Protection degree: IP 65

**181476 Battery Switch** Std pkg 1

Plug: HC-CARGO 181545.

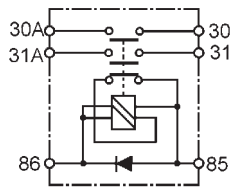

Voltage: 24  
Amp/5 sec.: 2500  
Amp/cont.: 250

Type: Electromagnetic  
Explosion proof 1: Yes  
Explosion proof 2: Yes  
Switch: Positive/Negative  
No./mounting holes: 4  
No./poles: 4  
Protection degree: IP 65  
Approval: Ex

**181562 Battery Switch** Std pkg 1

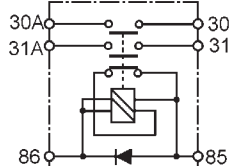

Voltage: 12  
Amp/5 sec.: 2500  
Amp/cont.: 250

Switch: Positive/Negative  
Comp. diode: Yes  
Protection degree: IP 65

**EMERGENCY STOP SWITCHES**

**181247 Emergency Stop Button** Std pkg 1

Emergency stop button operable w/ push button, turn for reset.



Protection degree: IP 65

**181271 Emergency Stop Button** Std pkg 1

Emergency stop button operable w/ push button, turn for reset.



Voltage: 48  
Amp: 150

Mount. hole size:  
37 mm

Type/terminal: Screw  
Protection degree: IP 66

**CONTROL BOXES**

**181244 Control Box** Std pkg 1



Voltage/AC 1: 220  
Voltage/DC 1: 24  
Voltage/AC 2: 380  
Voltage/DC 2: 48  
Voltage/AC 3: 500  
Voltage/DC 3: 100  
Amp/max: 5  
Amp/max 2: 4.5  
Amp/max 3: 4  
Amp/max 4: 3  
Amp/max 5: 2

No./buttons: 2  
Protection degree: IP 65

**181245 Control Box** Std pkg 1



Voltage/AC 1: 220  
Voltage/DC 1: 24  
Voltage/AC 2: 380  
Voltage/DC 2: 48  
Voltage/AC 3: 500  
Voltage/DC 3: 100  
Amp/max: 5  
Amp/max 2: 4.5  
Amp/max 3: 4  
Amp/max 4: 3  
Amp/max 5: 2

No./buttons: 3  
Protection degree: IP 65







		EL. SPECIFICATIONS	DIMENSIONS	ADDITIONAL SPECIFICATIONS
<b>181246</b> Control Box Std pkg 1				
		Voltage/AC 1: 220 Voltage/DC 1: 24 Voltage/AC 2: 380 Voltage/DC 2: 48 Voltage/AC 3: 500 Voltage/DC 3: 100 Amp/max: 5 Amp/max 2: 4.5 Amp/max 3: 4 Amp/max 4: 3 Amp/max 5: 2		No./buttons: 2 Protection degree: IP 65
<b>181540</b> Remote Lift Control Set Std pkg 1		Servicing: Lift, doors, ports, winches, hoists etc - Visit <a href="http://www.hc-cargo.com">www.hc-cargo.com</a> for further information.		
<i>Set of hand transmitter, receiver and antenna. Individual coding. Coverage 50-125 m. w/o emergency stop.</i>				
		Voltage/AC 1: 12 Voltage/DC 1: 12 Voltage/AC 2: 24 Voltage/DC 2: 24		No./buttons: 3 Protection degree: IP 65
<b>181577</b> Control Box Std pkg 1				
<i>For tail lift.</i>				
		Voltage/DC 1: 12-24		No./buttons: 3 Protection degree: IP 65
<b>IGNITION/LIGHT</b>				
<b>180045</b> Ignition/Light Switch Std pkg 1				
<i>Spare key: HC-CARGO 180341.</i>				
			Mount. hole size: 26.5 mm	Switch combination: Parkinglight-off-ignition-sidelight-DRL No./keys: 2 No./terminals: 6
<b>180324</b> Ignition/Light Switch Std pkg 1				
<i>Spare key: HC-CARGO 180341.</i>				
			Mount. hole size: 26.5 mm	Switch combination: Parkinglight-off-ignition-sidelight-DRL No./keys: 2 No./terminals: 7
<b>IGNITION STARTER</b>				
<b>180025</b> Ignition Starter Switch Std pkg 1				
<i>Spare key: HC-CARGO 180339.</i>				
			Mount. hole size: 18.5 mm	Switch combination: Off-ignition No./keys: 2 No./terminals: 3

<b>180027 Ignition Starter Switch</b> Std pkg 1 <i>Spare key: HC-CARGO 180339. Multiplug: HC-CARGO 181597.</i>			
		Mount. hole size: 18.5 mm	Switch combination: Off-ignition-start No./keys: 2 No./terminals: 5
<b>180041 Ignition Starter Switch</b> Std pkg 1 <i>Spare key: HC-CARGO 180340.</i>			
		Mount. hole size: 26.5 mm	Switch combination: Parking light-off-start No./keys: 2 No./terminals: 7 Protection degree: IP 63 DIN norm: 40050
<b>180043 Ignition Starter Switch</b> Std pkg 1 <i>Spare key: HC-CARGO 180339.</i>			
		Mount. hole size: 18.5 mm	Switch combination: Off-aux-ignition-start No./keys: 2 No./terminals: 4
<b>181518 Ignition Starter Switch</b> Std pkg 1 <i>Spare key: HC-CARGO 180339.</i>			
		Mount. hole size: 22.5 mm	Switch combination: Off-ignition-start No./keys: 2 No./terminals: 5 Positions: 1
<h2>DIESEL STARTER</h2>			
<b>180044 Ignition Switch</b> Std pkg 1 <i>Servicing: Deutz, IH - Visit <a href="http://www.hc-cargo.com">www.hc-cargo.com</a> for further information.</i> <i>Supplied w/ 2 keys. Spare key: HC-CARGO 180340. Multiplug: HC-CARGO 181595, 181596. Rubber Boot: HC-CARGO 181598.</i>			
		Mount. hole size: 26.5 mm	Switch combination: Parking light-off-ignition-glow-start No./terminals: 10 Protection degree: IP 63 DIN norm: 40050
<b>181235 Ignition Switch</b> Std pkg 1 <i>Servicing: Massey Ferguson - Visit <a href="http://www.hc-cargo.com">www.hc-cargo.com</a> for further information.</i> <i>Spare Key: HC-CARGO 181465. 1=30. 2=15. 3=19.</i>			
		Mount. hole size: 16 mm	Switch combination: Off-ignition-glow-start No./keys: 2 No./terminals: 6 Positions: 4

<b>181236</b> Ignition Switch		Std pkg 1	Servicing: Massey Ferguson - Visit <a href="http://www.hc-cargo.com">www.hc-cargo.com</a> for further information.	
<i>Spare key: HC-CARGO 181465.</i>				
			Mount. hole size: 16 mm	Switch combination: Start-Off-Glow-Start No./keys: 2 No./terminals: 4 Positions: 4
<b>181237</b> Ignition Switch		Std pkg 1	Servicing: Massey Ferguson - Visit <a href="http://www.hc-cargo.com">www.hc-cargo.com</a> for further information.	
<i>Spare key: HC-CARGO 181465.</i>				
			Mount. hole size: 16 mm	Switch combination: Off-aux-ignition-glow-start No./keys: 2 No./terminals: 7 Positions: 5
<b>RUBBER BOOTS</b>				
<b>181598</b> Rubber Boot		Std pkg 1	Servicing: HC-CARGO 180044	
				
<b>SPARE PARTS</b>				
<b>180339</b> Spare Key		Std pkg 10	Servicing: HC-CARGO 180025, 180027, 180043, 181518	
				
<b>180340</b> Spare Key		Std pkg 10	Servicing: HC-CARGO 180041, 180044	
				
<b>180341</b> Spare Key		Std pkg 10	Servicing: HC-CARGO 180045, 180324	
				
<b>181465</b> Spare Key		Std pkg 10	Servicing: HC-CARGO 181235, 181236, 181237	
				Material: Metal



EL. SPECIFICATIONS		DIMENSIONS	ADDITIONAL SPECIFICATIONS
<b>181595</b> Central Plug Connector    Std pkg 5    Servicing: HC-CARGO 180044 <i>DIN 46340. Used w/ HC-CARGO 181596.</i>			
			Type: Socket Type/terminal: 9.5x1.2 Colour: Black No./poles: 4 Plug: Female
<b>181596</b> Central Plug Connector    Std pkg 5    Servicing: HC-CARGO 180044 <i>DIN 46340. Used w/ HC-CARGO 181595.</i>			
			Type: Socket Type/terminal: 6.3x0.8 Colour: Black No./poles: 6 Plug: Female
<b>181597</b> Central Plug Connector    Std pkg 5    Servicing: HC-CARGO 180027			
			Type: Socket Colour: Black No./poles: 6 Plug: Female
<h2>SOLENOIDS</h2> <h3>SOLENOID SHUTDOWN-KITS</h3> <h4>EXTERNALLY SWITCHED</h4>			
<b>090095</b> Solenoid Shutdown Kit    Std pkg 1 <i>This solenoid can't switch off by itself, it will have to be controlled externally.</i>			
		Voltage: 12 Amp/hold: 1.1 Amp/pull: 46	Pull rating: 89N at 25.4 mm Mount. side: Left Hold rating: 178N
			Elect. connection: Cable Function: Pull Mount. type: Flange/bracket Switch: External
<b>090096</b> Solenoid Shutdown Kit    Std pkg 1 <i>This solenoid can't switch off by itself, it will have to be controlled externally.</i>			
		Voltage: 12 Amp/hold: 1.1 Amp/pull: 46	Pull rating: 89N at 25.4 mm Mount. side: Right Hold rating: 178N
			Elect. connection: Cable Function: Pull Mount. type: Flange/bracket Switch: External
<b>090099</b> Solenoid Shutdown Kit    Std pkg 1 <i>This solenoid can't switch off by itself, it will have to be controlled externally.</i>			
		Voltage: 24 Amp/hold: 0.5 Amp/pull: 25	Pull rating: 89N at 25.4 mm Mount. side: Left Hold rating: 178N
			Elect. connection: Cable Function: Pull Mount. type: Flange/bracket Switch: External
<b>090100</b> Solenoid Shutdown Kit    Std pkg 1 <i>This solenoid can't switch off by itself, it will have to be controlled externally.</i>			
		Voltage: 24 Amp/hold: 0.5 Amp/pull: 25	Pull rating: 89N at 25.4 mm Mount. side: Right Hold rating: 178N
			Elect. connection: Cable Function: Pull Mount. type: Flange/bracket Switch: External

		EL. SPECIFICATIONS	DIMENSIONS	ADDITIONAL SPECIFICATIONS
<b>090103 Solenoid Shutdown Kit</b> Std pkg 1 Servicing: Nippodenso, Zexel - Visit <a href="http://www.hc-cargo.com">www.hc-cargo.com</a> for further information.				
<i>This solenoid can't switch off by itself, it will have to be controlled externally.</i>				
	Voltage: 12 Amp/hold: 1.1 Amp/pull: 55	Pull rating: 89N at 25.4 mm Mount. side: Left Hold rating: 178N	Elect. connection: Cable Function: Pull Mount. type: Flange/bracket Switch: External	
<b>090104 Solenoid Shutdown Kit</b> Std pkg 1 Servicing: Nippodenso, Zexel - Visit <a href="http://www.hc-cargo.com">www.hc-cargo.com</a> for further information.				
<i>This solenoid can't switch off by itself, it will have to be controlled externally.</i>				
	Voltage: 12 Amp/hold: 1.1 Amp/pull: 55	Pull rating: 89N at 25.4 mm Mount. side: Right Hold rating: 178N	Elect. connection: Cable Function: Pull Switch: External	
<b>090105 Solenoid Shutdown Kit</b> Std pkg 1 Servicing: Nippodenso, Zexel - Visit <a href="http://www.hc-cargo.com">www.hc-cargo.com</a> for further information.				
<i>This solenoid can't switch off by itself, it will have to be controlled externally.</i>				
	Voltage: 24 Amp/hold: 0.63 Amp/pull: 29	Pull rating: 89N at 25.4 mm Mount. side: Left Hold rating: 178N	Elect. connection: Cable Function: Pull Switch: External	
<b>090106 Solenoid Shutdown Kit</b> Std pkg 1 Servicing: Nippodenso, Zexel - Visit <a href="http://www.hc-cargo.com">www.hc-cargo.com</a> for further information.				
<i>This solenoid can't switch off by itself, it will have to be controlled externally.</i>				
	Voltage: 24 Amp/hold: 0.63 Amp/pull: 29	Pull rating: 89N at 25.4 mm Mount. side: Right Hold rating: 178N	Elect. connection: Cable Function: Pull Switch: External	
<b>090107 Solenoid Shutdown Kit</b> Std pkg 1				
<i>This solenoid can't switch off by itself, it will have to be controlled externally.</i>				
	Voltage: 12 Amp/hold: 1.1 Amp/pull: 55	Pull rating: 89N at 25.4 mm Mount. side: Left Hold rating: 178N	Elect. connection: Multiplug Function: Pull Switch: External	
<b>090108 Solenoid Shutdown Kit</b> Std pkg 1				
<i>This solenoid can't switch off by itself, it will have to be controlled externally.</i>				
	Voltage: 24 Amp/hold: 0.63 Amp/pull: 29	Pull rating: 89N at 25.4 mm Mount. side: Left Hold rating: 178N	Elect. connection: Multiplug Function: Pull Switch: External	
<b>INTERNALLY SWITCHED</b>				
<b>090097 Solenoid Shutdown Kit</b> Std pkg 1				
<i>This solenoid can switch off the pull coil, and no external 'control' is necessary.</i>				
	Voltage: 12 Amp/hold: 1.1 Amp/pull: 46	Pull rating: 89N at 25.4 mm Mount. side: Left Hold rating: 178N	Elect. connection: Plug Function: Pull Mount. type: Flange/bracket Switch: Internal	

**090098 Solenoid Shutdown Kit** Std pkg 1

*This solenoid can switch off the pull coil, and no external 'control' is necessary.*



Voltage: 12  
Amp/hold: 1.1  
Amp/pull: 46

Pull rating:  
89N at 25.4 mm  
Mount. side: Right  
Hold rating: 178N

Elect. connection: Plug  
Function: Pull  
Switch: Internal

**090101 Solenoid Shutdown Kit** Std pkg 1

*This solenoid can switch off the pull coil, and no external 'control' is necessary.*



Voltage: 24  
Amp/hold: 0.5  
Amp/pull: 25

Pull rating:  
89N at 25.4 mm  
Mount. side: Left  
Hold rating: 178N

Elect. connection: Plug  
Function: Pull  
Switch: Internal

**090102 Solenoid Shutdown Kit** Std pkg 1

*This solenoid can switch off the pull coil, and no external 'control' is necessary.*



Voltage: 24  
Amp/hold: 0.5  
Amp/pull: 25

Pull rating:  
89N at 25.4 mm  
Hold rating: 178N

Elect. connection: Plug  
Function: Pull  
Switch: Internal

## SOLENOID SHUTDOWN EXTERNALLY SWITCHED

**090109 Shutdown Solenoid** Std pkg 1

*This solenoid can't switch off by itself, it will have to be controlled externally.*



Voltage: 12  
Amp/hold: 0.7  
Amp/pull: 30

Thread size: 6  
Thread type: mm  
Pull rating:  
40N at 25.4 mm  
Return spring: 9N  
Hold rating: 89N

Plunger: External  
Elect. connection: Plug  
Function: Pull  
Mount. type: Flange/bracket  
Switch: External

**090110 Shutdown Solenoid** Std pkg 1

*This solenoid can't switch off by itself, it will have to be controlled externally.*



Voltage: 24  
Amp/hold: 0.25  
Amp/pull: 17

Thread size: 6  
Thread type: mm  
Pull rating:  
40N at 25.4 mm  
Return spring: 9N  
Hold rating: 89N

Plunger: External  
Elect. connection: Plug  
Function: Pull  
Mount. type: Flange/bracket  
Switch: External

**090111 Shutdown Solenoid** Std pkg 1

*This solenoid can't switch off by itself, it will have to be controlled externally.*



Voltage: 12  
Amp/hold: 0.6  
Amp/pull: 44

Thread size: 1/4"  
Thread type: Inches  
Pull rating:  
75N at 25.4 mm  
Return spring: 35N  
Hold rating: 178N

Plunger: External  
Elect. connection: Plug  
Function: Pull  
Mount. type: Flange/bracket  
Switch: External

**090113 Shutdown Solenoid** Std pkg 1

*This solenoid can't switch off by itself, it will have to be controlled externally.*



Voltage: 24  
Amp/hold: 0.3  
Amp/pull: 23

Thread size: 6  
Thread type: mm  
Pull rating:  
75N at 25.4 mm  
Return spring: 35N  
Hold rating: 178N

Plunger: External  
Elect. connection: Plug  
Function: Pull  
Mount. type: Flange/bracket  
Switch: External  
Aux terminal: Yes

**090199 Shutdown Solenoid** Std pkg 1

*This solenoid can't switch off by itself, it will have to be controlled externally.*



Voltage: 12  
Amp/hold: 1.1  
Amp/pull: 46

Thread size: 6  
Thread type: mm  
Pull rating:  
89N at 25.4 mm  
Return spring: 17N  
Hold rating: 178N

Plunger: External  
Elect. connection: Cable  
Function: Pull/Push  
Mount. type: Flat w/ 2 fixing holes  
Switch: External

**090200 Shutdown Solenoid** Std pkg 1

*This solenoid can't switch off by itself, it will have to be controlled externally.*



Voltage: 24  
Amp/hold: 4  
Amp/pull: 18

Thread size: 6  
Thread type: mm  
Pull rating:  
67N at 25.4 mm  
Return spring: 17N  
Hold rating: 178N

Plunger: External  
Elect. connection: Cable  
Function: Pull/Push  
Switch: External

**090206 Shutdown Solenoid** Std pkg 1 Servicing: Yanmar Diesel - Visit [www.hc-cargo.com](http://www.hc-cargo.com) for further information.

*This solenoid can't switch off by itself, it will have to be controlled externally.*



Voltage: 12  
Amp/hold: 0.49  
Amp/pull: 36.5

Thread size: 0.158  
Thread type: Inches

Plunger: Internal  
Switch: External

**090216 Shutdown Solenoid** Std pkg 1 Servicing: Kubota - Visit [www.hc-cargo.com](http://www.hc-cargo.com) for further information.

*This solenoid can't switch off by itself, it will have to be controlled externally.*



Voltage: 12  
Amp/hold: 0.7  
Amp/pull: 30

Pull rating:  
44N at 25.4 mm  
Return spring: 17N  
Hold rating: 85N

Plunger: External  
Elect. connection: Multiplug  
Mount. type: Flange  
Switch: External

**090225 Shutdown Solenoid** Std pkg 1 Servicing: Perkins - Visit [www.hc-cargo.com](http://www.hc-cargo.com) for further information.

*This solenoid can't switch off by itself, it will have to be controlled externally.*



Voltage: 12  
Amp/hold: 0.49  
Amp/pull: 36.5

Thread size: 0.25  
Thread type: Inches

Plunger: Internal  
Switch: External

**090226 Shutdown Solenoid** Std pkg 1

*This solenoid can't switch off by itself, it will have to be controlled externally.*



Voltage: 24  
Voltage 2: 24  
Amp/hold: 0.5  
Amp/pull: 25

Thread size: 6  
Thread type: mm  
Pull rating:  
111N at 25.4 mm  
Return spring: 7N  
Hold rating: 182N

Plunger: External  
Elect. connection: Multiplug  
Function: Pull  
Switch: External

**090228 Shutdown Solenoid** Std pkg 1 Servicing: Yanmar Motors - Visit [www.hc-cargo.com](http://www.hc-cargo.com) for further information.







*This solenoid can't switch off by itself, it will have to be controlled externally.*



Voltage: 12  
Amp/hold: 0.49  
Amp/pull: 36.5

Thread size: 0.158  
Thread type: Inches

Plunger: Internal  
Switch: External

		EL. SPECIFICATIONS	DIMENSIONS	ADDITIONAL SPECIFICATIONS
<b>090267</b> Shutdown Solenoid Std pkg 1 Servicing: Volvo wheel loader - Visit <a href="http://www.hc-cargo.com">www.hc-cargo.com</a> for further information.				
<i>Synco start/Woodward.</i>				
	Voltage: 24 Amp/hold: 0.86 Amp/pull: 39	Pull rating: 129N at 25.4 mm Hold rating: 182N	Plunger: Cable Elect. connection: Multiplug Function: Pull Switch: External	
<b>090281</b> Shutdown Solenoid Std pkg 1 Servicing: Volvo - Visit <a href="http://www.hc-cargo.com">www.hc-cargo.com</a> for further information.				
<i>This solenoid can't switch off by itself, it will have to be controlled externally.</i>				
	Voltage: 24 Amp/hold: 0.5 Amp/pull: 25	Thread size: 6 Thread type: mm Pull rating: 89N at 25.4 mm Hold rating: 236N	Plunger: External Elect. connection: Multiplug Function: Pull/Push Mount. type: Bracket Switch: External	
<b>090348</b> Shutdown Solenoid Std pkg 1				
<i>This solenoid can't switch off by itself, it will have to be controlled externally.</i>				
	Voltage: 12 Amp/hold: 1.1 Amp/pull: 46	Thread size: 6 Thread type: mm Pull rating: 111N at 25.4 mm Return spring: 4-8N Hold rating: 182N	Plunger: External Elect. connection: Cable Function: Pull Mount. type: Flat w/ 2 fixing holes Switch: External	
<b>090370</b> Shutdown Solenoid Std pkg 1 Servicing: Kubota D722, Z482 - Visit <a href="http://www.hc-cargo.com">www.hc-cargo.com</a> for further information.				
<i>This solenoid can't switch off by itself, it will have to be controlled externally.</i>				
	Voltage: 12 Amp/hold: 1.1 Amp/pull: 46	Thread size: 1/4 - 28 UNF-2A Pull rating: 111N Hold rating: 182N	Plunger: External Elect. connection: Cable Mount. type: Flat w/ 2 fixing holes Switch: External	
<b>090371</b> Shutdown Solenoid Std pkg 1 Servicing: Kubota D722, Z482 - Visit <a href="http://www.hc-cargo.com">www.hc-cargo.com</a> for further information.				
<i>This solenoid can't switch off by itself, it will have to be controlled externally.</i>				
	Voltage: 24 Amp/hold: 0.5 Amp/pull: 25	Thread size: 1/4 - 28 UNF-2A Pull rating: 111N Hold rating: 182N	Plunger: External Elect. connection: Cable Switch: External	
<b>090373</b> Shutdown Solenoid Std pkg 1				
<i>This solenoid can't switch off by itself, it will have to be controlled externally.</i>				
	Voltage: 12 Amp/hold: 0.972 Amp/pull: 365	Thread size: 0.154 Thread type: Inches	Plunger: External Switch: External	
<b>090431</b> Shutdown Solenoid Std pkg 1				
<i>This solenoid can't switch off by itself, it will have to be controlled externally.</i>				
	Voltage: 24 Voltage 2: 24 Amp/hold: 0.57 Amp/pull: 30	Thread size: 5/16" Thread type: Inches Pull rating: 165N Return spring: 80-115N Hold rating: 391N	Plunger: External Function: Pull Mount. type: Flange/bracket Switch: External Insulated return: Yes	

**090439 Shutdown Solenoid** Std pkg 1

*This solenoid can switch off the pull coil, and no external 'control' is necessary.*



Voltage: 12  
Amp/hold: 0.76  
Amp/pull: 41.4

Thread size: 6  
Thread type: mm  
Pull rating: 49N ved  
25.4 mm  
Hold rating: 89N

Plunger: Internal  
Switch: Internal

**SPARE PARTS**
**090218 Plunger** Std pkg 1

Thread size: M6  
Thread type: Ordinary

Plunger: External

**INTERNALLY SWITCHED**
**090160 Shutdown Solenoid** Std pkg 1

*This solenoid can switch off the pull coil, and no external 'control' is necessary.*



Voltage: 12  
Amp/hold: 0.7  
Amp/pull: 30

Thread size: 6  
Thread type: mm  
Pull rating: 40N at  
25.4 mm  
Return spring: 17N  
Hold rating: 89N

Plunger: External  
Elect. connection: Plug  
Mount. type: Flange/bracket  
Switch: Internal

**090161 Shutdown Solenoid** Std pkg 1

*This solenoid can switch off the pull coil, and no external 'control' is necessary.*



Voltage: 24  
Amp/hold: 0.25  
Amp/pull: 17

Thread size: 6  
Thread type: mm  
Pull rating: 40N at  
25.4 mm  
Return spring: 17N  
Hold rating: 89N

Plunger: Internal  
Elect. connection: Plug  
Function: Pull  
Mount. type: Flange/bracket  
Switch: Internal

**090168 Shutdown Solenoid** Std pkg 1

*This solenoid can switch off the pull coil, and no external 'control' is necessary.*



Voltage: 12  
Amp/hold: 0.6  
Amp/pull: 44

Thread size: 6  
Thread type: mm  
Pull rating: 75N at 25.4  
mm  
Return spring: 35N  
Hold rating: 178N

Plunger: External  
Elect. connection: Plug  
Mount. type: Flange/bracket  
Switch: Internal

**090169 Shutdown Solenoid** Std pkg 1

*This solenoid can switch off the pull coil, and no external 'control' is necessary.*



Voltage: 24  
Amp/hold: 0.3  
Amp/pull: 23

Thread size: 6  
Thread type: mm  
Pull rating: 75N at  
25.4 mm  
Return spring: 35N  
Hold rating: 178N

Plunger: External  
Elect. connection: Plug  
Function: Pull  
Mount. type: Flange/bracket  
Switch: Internal  
Aux terminal: Yes

**090210 Shutdown Solenoid** Std pkg 1







*This solenoid can switch off the pull coil, and no external 'control' is necessary.*



Voltage: 12  
Amp/hold: 1.1  
Amp/pull: 46

Thread size: 1/4"-28  
stud.  
Thread type: Inches  
Pull rating: 89N at  
25.4 mm  
Return spring: 9N  
Hold rating: 178N

Plunger: Internal  
Elect. connection: Plug  
Function: Pull  
Mount. type: Flange/bracket  
Switch: Internal  
Aux terminal: Yes

		EL. SPECIFICATIONS	DIMENSIONS	ADDITIONAL SPECIFICATIONS
<b>090224 Shutdown Solenoid</b> Std pkg 1				
<i>This solenoid can switch off the pull coil, and no external 'control' is necessary.</i>				
	Voltage: 12 Amp/hold: 0.25 Amp/pull: 17	Thread size: 6 Thread type: mm Pull rating: 40N at 25.4 mm Return spring: 17N Hold rating: 89N	Plunger: Internal Switch: Internal	
<b>090268 Shutdown Solenoid</b> Std pkg 1 Servicing: Kubota 5 series - Visit <a href="http://www.hc-cargo.com">www.hc-cargo.com</a> for further information.				
<i>This solenoid can switch off the pull coil, and no external 'control' is necessary.</i>				
	Voltage: 12 Amp/hold: 0.49 Amp/pull: 36.5	Thread size: 0.155 Thread type: Inches	Plunger: Internal Switch: Internal	
<b>090297 Shutdown Solenoid</b> Std pkg 1				
<i>This solenoid can switch off the pull coil, and no external 'control' is necessary.</i>				
	Voltage: 24 Amp/hold: 1.1 Amp/pull: 46	Thread size: 6 Thread type: mm Pull rating: 107N at 25.4 mm Return spring: 7-11N Hold rating: 169N	Plunger: External Switch: Internal Aux terminal: No	
<b>090317 Shutdown Solenoid</b> Std pkg 1				
<i>This solenoid can switch off the pull coil, and no external 'control' is necessary.</i>				
	Voltage: 24 Amp/hold: 0.3 Amp/pull: 20	Pull rating: 98N at 320 mm Return spring: 45N Hold rating: 245N	Plunger: Internal Switch: Internal Coil commander: w/	
<b>090318 Shutdown Solenoid</b> Std pkg 1				
<i>This solenoid can switch off the pull coil, and no external 'control' is necessary.</i>				
	Voltage: 12 Amp/hold: 0.65 Amp/pull: 37	Pull rating: 98N at 320 mm Return spring: 45N Hold rating: 245N	Plunger: Internal Switch: Internal	
<b>090334 Shutdown Solenoid</b> Std pkg 1 Servicing: Sisu Diesel 8366 40253 - Visit <a href="http://www.hc-cargo.com">www.hc-cargo.com</a> for further information.				
<i>This solenoid can switch off the pull coil, and no external 'control' is necessary.</i>				
	Voltage: 12 Amp/hold: 1.1 Amp/pull: 46.5	Pull rating: 89N Hold rating: 178N	Plunger: Internal Switch: Internal	
<b>090402 Shutdown Solenoid</b> Std pkg 1 Servicing: Kubota super 5 series - Visit <a href="http://www.hc-cargo.com">www.hc-cargo.com</a> for further information.				
<i>This solenoid can switch off the pull coil, and no external 'control' is necessary.</i>				
	Voltage: 24 Amp/hold: 0.59 Amp/pull: 19.6	Thread size: 0.154 Thread type: Inches	Plunger: Internal Switch: Internal	

**090430** Shutdown Solenoid Std pkg 1 Servicing: Kubota - Visit [www.hc-cargo.com](http://www.hc-cargo.com) for further information.

*This solenoid can switch off the pull coil, and no external 'control' is necessary.*



Voltage: 12  
Amp/hold: 0.49  
Amp/pull: 36.5

Thread size: 0.158  
Thread type: Inches

Plunger: Internal  
Switch: Internal

## PULL COIL TIMER MODULES

**090115** Pull Coil Timer Std pkg 1



Voltage: 12

No./wires: 3

**090116** Pull Coil Timer Std pkg 1



Voltage: 24

No./wires: 3

## ADVANCE SOLENOIDS

**080940** Actuator Std pkg 1 Servicing: Fiat, Renault - Visit [www.hc-cargo.com](http://www.hc-cargo.com) for further information.



Voltage: 12

**080941** Actuator Std pkg 1 Servicing: Ford - Visit [www.hc-cargo.com](http://www.hc-cargo.com) for further information.



Voltage: 12

**080942** Actuator Std pkg 1 Servicing: Renault - Visit [www.hc-cargo.com](http://www.hc-cargo.com) for further information.





Voltage: 12

**081117** Actuator Std pkg 1



Voltage: 12



SOLENOID STOP			
080177 Solenoid Stop	Std pkg 1	Voltage: 12 Voltage 2: 12	Filter: w/o Insulated return: No
			
080178 Solenoid Stop	Std pkg 1	Voltage: 24 Voltage 2: 24	Filter: w/o Insulated return: No
			
080207 Solenoid Stop	Std pkg 1	Voltage: 12 Voltage 2: 12	Filter: w/o Insulated return: No
			
080208 Solenoid Stop	Std pkg 1	Voltage: 24 Voltage 2: 24	Filter: w/o Insulated return: No
			
080209 Solenoid Stop	1Std pkg 1	Voltage: 12 Voltage 2: 12	Filter: w/o Insulated return: No
			
080210 Solenoid Stop	Std pkg 1	Voltage: 24 Voltage 2: 24	Elect. connection: Plug Filter: w/o Insulated return: Yes
			
080211 Solenoid Stop	Std pkg 1	Voltage: 24 Voltage 2: 24	Filter: w/o Insulated return: No
			

		EL. SPECIFICATIONS	DIMENSIONS	ADDITIONAL SPECIFICATIONS
080212 Solenoid Stop	Std pkg 1	Voltage: 12 Voltage 2: 12		Elect. connection: Plug Filter: w/o Insulated return: Yes
				
080595 Solenoid Stop	Std pkg 1	Voltage: 12 Voltage 2: 12		Filter: w/o Insulated return: No
				
080680 Solenoid Stop	Std pkg 1	Voltage: 12 Voltage 2: 12		Filter: w/
				
080873 Solenoid Stop	Std pkg 1	Voltage: 12 Voltage 2: 12		Filter: w/o
				
080926 Solenoid Stop	Std pkg 1	Voltage: 24 Voltage 2: 24		Filter: w/o
				
080929 Solenoid Stop	Std pkg 1	Voltage: 12 Voltage 2: 12		Elect. connection: Cable Filter: w/o Insulated return: Yes
				
080995 Solenoid Stop	Std pkg 1	Voltage: 12 Voltage 2: 12		Elect. connection: Multiplug Filter: w/o Insulated return: Yes
				

		EL. SPECIFICATIONS	DIMENSIONS	ADDITIONAL SPECIFICATIONS
<b>080996</b> Solenoid Stop	Std pkg 1	Voltage: 24 Voltage 2: 24		Elect. connection: Multiplug Filter: w/o Insulated return: Yes
				
<b>080998</b> Solenoid Stop	Std pkg 1	Voltage: 12 Voltage 2: 12		Filter: w/o Insulated return: No
				
<b>081000</b> Solenoid Stop	Std pkg 1	Voltage: 12 Voltage 2: 12		Function: Push Type: Coil Filter: w/o Insulated return: No
				
<b>081002</b> Solenoid Stop	Std pkg 1	Voltage: 24 Voltage 2: 24		Elect. connection: Cable Function: Push Filter: w/o Insulated return: Yes
				
<b>081166</b> Solenoid Stop	Std pkg 1	Voltage: 12 Voltage 2: 12		Filter: w/o Insulated return: No
				

## PUMPS & PUMP PARTS

### ELECTRICAL BILGE PUMPS

**070154** Bilge Pump Std pkg 1  
*Model UP500. Completely submersible bilge pump. Compact design w/ ABS material housing, corrosion resistant. Shaft seal made of ceramic and graphite which ensures lubrication and leak resistance. Water inlet strainer slots will screen particles present in the bilge allowing easy running. Pump body can be dismantled by a simple snap-off movement for easy inspection and cleaning.*

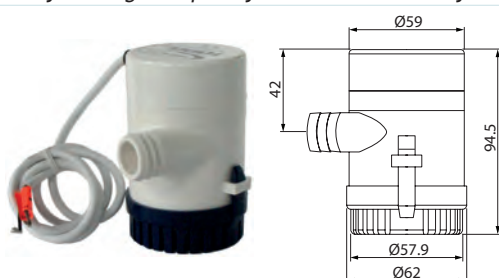

Voltage: 12  
Amp: 5

Dim.: 94.5x59 mm  
 Hose connection: 19 mm  
 Lift height: 4 m  
 Weight: 0.4 kg  
 Capacity: 32 l/min  
 Pressure: 0.45 bar  
 Pressure: 6.5 PSI

Gasket: Ceramic  
 Type: Bilge  
 Pump housing: ABS plastic  
 Pump shaft: Stainless steel  
 ISO norm: 8849/8846

**070155 Bilge Pump** Std pkg 1

Model UP1000. Completely submersible bilge pump. Compact design w/ ABS material housing, corrosion resistant. Shaft seal made of ceramic and graphite which ensures lubrication and leak resistance. Water inlet strainer slots will screen particles present in the bilge allowing easy running. Pump body can be dismantled by a simple snap-off movement for easy inspection and cleaning.



Voltage: 12  
Amp: 10

Dim.: 124.7x78 mm  
Hose connection:  
28.6 mm  
Lift height: 4 m  
Weight: 0.8 kg  
Capacity: 63 l/min  
Pressure: 0.45 bar  
Pressure: 6.5 PSI

Gasket: Ceramic  
Type: Bilge  
Pump housing: ABS plastic  
Pump shaft: Stainless steel  
ISO norm: 8849/8846

**070156 Bilge Pump** Std pkg 1

Model UP1500. Completely submersible bilge pump. Compact design w/ ABS material housing, corrosion resistant. Shaft seal made of ceramic and graphite which ensures lubrication and leak resistance. Water inlet strainer slots will screen particles present in the bilge allowing easy running. Pump body can be dismantled by a simple snap-off movement for easy inspection and cleaning.

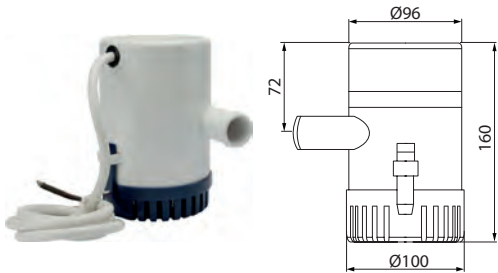

Voltage: 12  
Amp: 20

Dim.: 160x96 mm  
Hose connection:  
26.5 mm  
Lift height: 4 m  
Weight: 1.3 kg  
Capacity: 95 l/min  
Pressure: 0.45 bar  
Pressure: 6.5 PSI

Gasket: Ceramic  
Type: Bilge  
Pump housing: ABS plastic  
Pump shaft: Stainless steel  
ISO norm: 8849/8846

**070157 Bilge Pump** Std pkg 1

Model UP2000. Completely submersible bilge pump. Compact design w/ ABS material housing, corrosion resistant. Shaft seal made of ceramic and graphite which ensures lubrication and leak resistance. Water inlet strainer slots will screen particles present in the bilge allowing easy running. Pump body can be dismantled by a simple snap-off movement for easy inspection and cleaning.

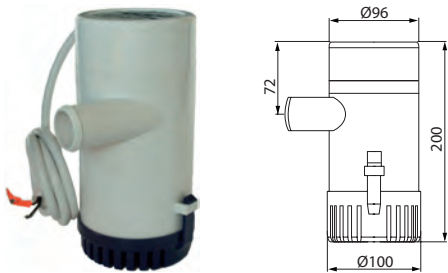

Voltage: 12  
Amp: 25

Dim.: 200x96 mm  
Hose connection:  
31.8 mm  
Lift height: 4 m  
Weight: 1.8 kg  
Capacity: 126 l/min  
Pressure: 0.45 bar  
Pressure: 6.5 PSI

Gasket: Ceramic  
Type: Bilge  
Pump housing: ABS plastic  
Pump shaft: Stainless steel  
ISO norm: 8849/8846

## ACCESSORIES

**070160 Automatic Float Switch** Std pkg 1

Made of corrosion resistant materials.



Voltage: 12/24  
Amp: 10

Dim.: 113x83x62 mm  
Height/closed: 22  
Height/open: 57

Floating switch: w/

## ELECTRICAL WATER PUMPS

**070144 Water Pump** Std pkg 1 Servicing: Renault - Visit [www.hc-cargo.com](http://www.hc-cargo.com) for further information.

Model UP1-N. Self priming (1.5 m) electric water pump w/ self-lubricating flexible impeller for prolonged service life and better performance. Pump body made of brass w/ stainless steel shaft and a rubber lip seal. 1/2" BSP inner thread and ID 25 mm bore hose connections. Main application: as a bilge pump.

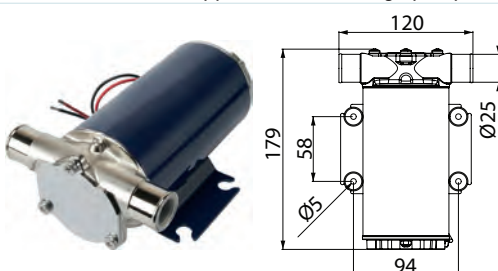

Voltage: 12  
Amp: 20

Dim.: 176x120x94 mm  
Hose connection:  
25 mm  
Capacity: 35 l/min  
Pressure: 0.8 bar  
Pressure: 11.6 PSI

Type: Impeller  
Pump housing: Brass  
Pump shaft: Stainless steel  
Impeller: Rubber  
Non return valve: Yes  
ISO norm: 8849/8846

<b>070145 Water Pump</b> Std pkg 1		Voltage: 24 Amp: 15		Dim.: 176x120x94 mm Hose connection: 25 mm Capacity: 35 l/min Pressure: 0.8 bar Pressure: 11.6 PSI		Type: Water Type 2: Impeller Pump housing: Brass Pump shaft: Stainless steel Impeller: Rubber Non return valve: Yes ISO norm: 8849/8846	
Model UP1-N. Self priming (1.5 m) electric water pump w/ self-lubricating flexible impeller for prolonged service life and better performance. Pump body made of brass w/ stainless steel shaft and a rubber lip seal. 1/2" BSP inner thread and ID 25 mm bore hose connections. Main application: as a bilge pump.							

<b>070153 Water Pump</b> Std pkg 1		Voltage: 12 Amp: 10		Dim.: 163x249x118 mm Hose connection: 13 mm Weight: 2.2 kg Capacity: 14 l/min Pressure: 2 bar Pressure: 29 PSI		Type: Gear Pump housing: Brass Pump shaft: Stainless steel Pinion: PTFE Filter: w/ Non return valve: Yes	
Model UP3/A. Self priming electric gear pump equipped w/ pressure switch, non-return valve to be used as automatic pump for water pressure system on boats, mobile homes etc. Bronze gears and rubber lip seal.							

<b>070172 Water Pump</b> Std pkg 1		Voltage: 24 Amp: 5		Dim.: 163x249x118 mm Hose connection: 14 mm Weight: 2.2 kg Capacity: 14 l/min Pressure: 2 bar Pressure: 29 PSI		Type: Water Type 2: Gear Pump housing: Brass Pump shaft: Stainless steel Pinion: PTFE Filter: w/ Non return valve: Yes	
Model UP4/A. Self priming electric gear pump equipped w/ pressure switch, non-return valve to be used as automatic pump for water pressure system on boats, mobile homes etc. Bronze gears and rubber lip seal.							

## CIRCULATION TYPE

<b>070192 Circulation Pump</b> Std pkg 1		Servicing: Ford, Seat, VW - Visit <a href="http://www.hc-cargo.com">www.hc-cargo.com</a> for further information.		Voltage: 12 Hose connection: 20 mm Capacity: 14 l/min		Type: Water Type 2: Impeller	

<b>070203 Circulation Pump</b> Std pkg 1		Servicing: Saab, Scania, Ferrari, Maserati, Opel, Vauxhall - Visit <a href="http://www.hc-cargo.com">www.hc-cargo.com</a> for further information.		Voltage: 12 Hose connection: 19 mm Capacity: 18 l/min		Type: Water Type 2: Impeller Filter: w/	
Junior Timer Connector: HC-CARGO 192146. (see Workshop Cons. & Tools).							

<b>070206 Circulation Pump</b> Std pkg 1		Servicing: Mercedes-Benz - Visit <a href="http://www.hc-cargo.com">www.hc-cargo.com</a> for further information.		Voltage: 12 Hose connection: 19 mm Capacity: 18 l/min		Type: Water Type 2: Impeller Filter: w/o	

**ELECTRICAL FLUID PUMPS**
**070147 Fluid Pump**

Std pkg 1

Servicing: Main application: transfer of diesel fuel, water antifreeze etc.

Model UP/3. self-priming 1.5 m. Electric pump w/ bronze gears for transfer of various liquids, complete w/ inline filter. Pump body made of brass w/ stainless steel shaft and a rubber lip seal. 3/8" BSP w/ brass connection for I.D. 14 mm inner tubing.

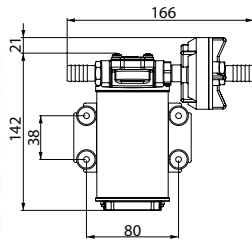
 Voltage: 12  
Amp: 10

 Dim.: 163x166x95 mm  
Hose connection:  
14 mm  
Weight: 1.4 kg  
Capacity: 14 l/min  
Pressure: 2 bar  
Pressure: 29 PSI

 Type: Gear  
Pump housing: Brass  
Pump shaft: Stainless steel  
Pinion: Brass  
Filter: w/

**070148 Fluid Pump**

Std pkg 1

Servicing: Main application: transfer of diesel fuel, water antifreeze etc.

Model UP/3. self-priming 1.5 m. Electric pump w/ bronze gears for transfer of various liquids, complete w/ inline filter. Pump body made of brass w/ stainless steel shaft and a rubber lip seal. 3/8" BSP w/ brass connection for I.D. 14 mm inner tubing.

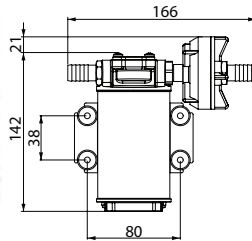
 Voltage: 24  
Amp: 5

 Dim.: 163x166x95 mm  
Hose connection:  
14 mm  
Weight: 1.4 kg  
Capacity: 14 l/min  
Pressure: 2 bar  
Pressure: 29 PSI

 Type: Gear  
Pump housing: Brass  
Pump shaft: Stainless steel  
Pinion: Brass  
Filter: w/

**070149 Fluid Pump**

Std pkg 1

Servicing: Main application: transfer of diesel fuel, water antifreeze etc.

Self-priming electric pump w/ helical bronze gears, complete with in-line filter. Nickel plated brass body w/ stainless steel shaft. Ports: 1/2" BSP w/ brass connection for Ø 16 mm inner tubing.

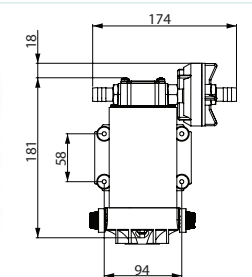
 Voltage: 12  
Amp: 15

 Dim.: 199x174x108 mm  
Hose connection:  
16 mm  
Weight: 3.1 kg  
Capacity: 26 l/min  
Pressure: 2 bar  
Pressure: 29 PSI

 Type: Fluid  
Type 2: Gear  
Pump housing: Brass  
Pump shaft: Stainless steel  
Pinion: Brass  
Filter: w/

**070150 Fluid Pump**

Std pkg 1

Servicing: Main application: transfer of diesel fuel, water antifreeze etc.

Self-priming electric pump w/ helical bronze gears, complete with in-line filter. Nickel plated brass body w/ stainless steel shaft. Ports: 1/2" BSP w/ brass connection for Ø 16 mm inner tubing.

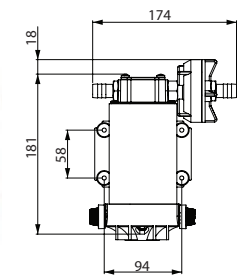
 Voltage: 24  
Amp: 7.5

 Dim.: 199x174x108 mm  
Hose connection:  
16 mm  
Weight: 3.1 kg  
Capacity: 26 l/min  
Pressure: 2 bar  
Pressure: 29 PSI

 Type: Gear  
Pump housing: Brass  
Pump shaft: Stainless steel  
Pinion: Brass  
Filter: w/

**070151 Fluid Pump**

Std pkg 1

Model UP3/ oil. Self-priming 1 m. Electrical gear pump particularly suitable for the transfer of lubricating oils or viscous liquids. Complete w/ two brass connections for 14 mm inner tube and one additional quick-fit for 8 mm external tubing. The pump can be used for extracting lubricating oil out of oil sumps of engines. Pump body made of brass w/ bronze gears, stainless steel shaft and a rubber lip seal.

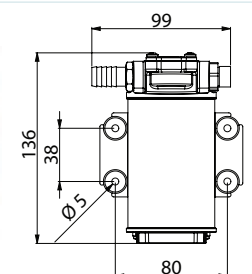

 Voltage: 12  
Amp: 7.5

 Dim.: 139x108x86 mm  
Hose connection:  
14 mm  
Weight: 1.4 kg  
Capacity: 5.5 l/min  
Pressure: 29 PSI

 Gasket: Rubber  
Type: Fluid  
Type 2: Gear  
Pump housing: Brass  
Pump shaft: Stainless steel  
Pinion: Bronze  
Non return valve: Yes

**070152 Fluid Pump** Std pkg 1

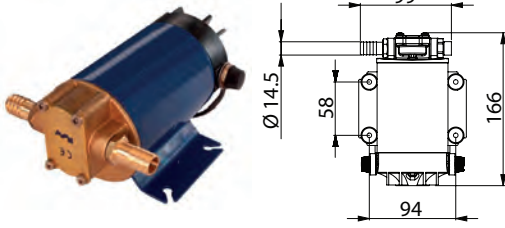
Model UP6/ oil. Self-priming 1.5 m. Electrical gear pump particularly suitable for the transfer of lubricating oils or viscous liquids. Professional model complete w/ two brass connections for 14 mm inner tube and one additional quick-fit for 8 mm external tubing. The pump can be used for extracting lubricating oil out of oil sumps of engines. Pump body made of brass w/ bronze gears, stainless steel shaft and a rubber lip seal.



Voltage: 12  
Amp: 10

Dim.: 166x117x94 mm  
Hose connection: 14 mm  
Weight: 2.5 kg  
Capacity: 8 l/min  
Pressure: 2 bar  
Pressure: 29 PSI

Type: Fluid  
Type 2: Gear  
Pump housing: Brass  
Pump shaft: Stainless steel  
Pinion: Bronze

**070173 Fluid Pump** Std pkg 1

Model UP6 w/ oil. Self-priming 1.5 m. Electrical gear pump particularly suitable for the transfer of lubricating oils or viscous liquids. Professional model complete w/ two brass connections for 14 mm inner tube and one additional quick-fit for 8 mm external tubing. The pump can be used for extracting lubricating oil out of oil sumps of engines.

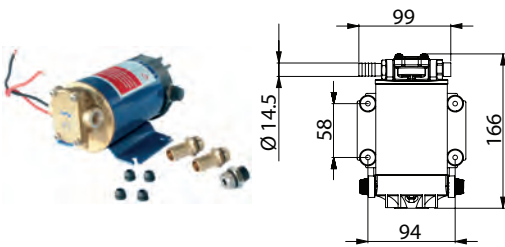

Voltage: 24  
Amp: 7.5

Dim.: 166x117x94 mm  
Hose connection: 14 mm  
Weight: 2.5 kg  
Capacity: 8 l/min  
Pressure: 2 bar  
Pressure: 29 PSI

Type: Fluid  
Type 2: Gear  
Pump housing: Brass  
Pump shaft: Stainless steel  
Impeller: Rubber  
Pinion: Bronze

**070208 Electrical Fluid Pump HD** Std pkg 1

Model UP12. Self-priming 4 m.

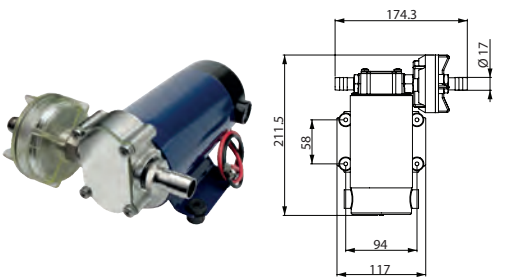

Voltage: 12  
Amp: 30

Dim.: 212x174x109 mm  
Hose connection: 16 mm  
Weight: 4.3 kg  
Capacity: 40 l/min  
Pressure: 2.5 bar  
Pressure: 36 PSI

Type: Fluid  
Type 2: Gear  
Pump housing: Brass  
Pump shaft: Stainless steel  
Pinion: Bronze  
Filter: w/  
Non return valve: Yes

**070209 Electrical Fluid Pump HD** Std pkg 1

Model UP12. Self-priming 4 m.

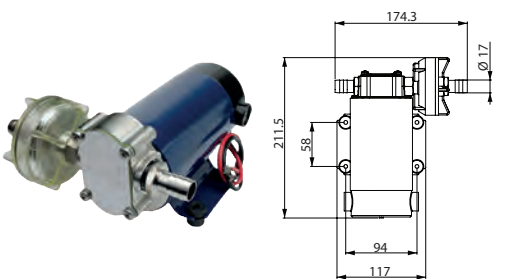

Voltage: 24  
Amp: 15

Dim.: 212x174x109 mm  
Hose connection: 16 mm  
Weight: 4.3 kg  
Capacity: 40 l/min  
Pressure: 2.5 bar  
Pressure: 36 PSI

Type: Fluid  
Type 2: Gear  
Pump housing: Brass  
Pump shaft: Stainless steel  
Pinion: Bronze  
Filter: w/  
Non return valve: Yes

**SPARE PARTS**

**070182 Brush Set** Std pkg 1 Servicing: HC-CARGO 070144, -145, -149, -150, -152



Length: 18.1 mm  
Height: 8.6 mm  
Thickness: 5.6 mm

## ELECTRICAL FUEL PUMPS

### DIESEL PUMP KITS

#### 070162 Diesel Transfer/Filter Kit Std pkg 1

Includes: 2.5 m suction hose. 2.5 m pressure hose w/ gun. Wired connection w/ alligator clips. Switch on the pump. Bypass valve on the pump ensures that it is not overloaded by closed gun. Not to gasoline.



Voltage: 12  
Amp: 15

Dim.: 210x161x120 mm  
Hose connection:  
25 mm  
Capacity: 45 l/min  
Pressure: 1.2 bar  
Pressure: 17.4 PSI

Type: Fluid  
Type 2: Gear  
Impeller: Steel  
Filter: w/

#### 070175 Diesel Transfer/Filter Kit Std pkg 1

2.5 m suction hose w/ filter. 2.5 m pressure hose w/ gun. 2 m cable w/ alligator clips. Switch on the pump. Bypass valve on the pump ensure against overloading. Not for gasoline.



Voltage: 24  
Amp: 7.5

Dim.: 210x161x120 mm  
Hose connection:  
25 mm  
Capacity: 45.1 l/min  
Pressure: 1.2 bar  
Pressure: 17.4 PSI

Type: Fluid  
Filter: w/

### INTERRUPTER PUMPS

#### 070003 Fuel Pump Std pkg 1

Built in Pressure Relief: assures an immediate return to zero pressure when the ignition is turned off. Prevents flooding and assures satisfactory restarting on the hottest days. Vertical mounting near tank is preferred. To 1.1 mtr. Fuel lift. Inlet/outlet 1/8"-27 thread. Fitting instruction. Fuel delivery capacity: 113.5 litre/h. Tested at: +60°C. Incl. 2 pcs. 6 mm hose nipples. 8 mm: HC-CARGO 080955. 8 mm angle: HC-CARGO 070181. 10 mm: HC-CARGO 081154. Filter: HC-CARGO 070177.



Voltage: 12

Capacity: 113.5 l/h  
Pressure: 4-5 PSI

Type: Universal

#### 070004 Fuel Pump Std pkg 1

Built in Pressure Relief: assures an immediate return to zero pressure when the ignition is turned off. Prevents flooding and assures satisfactory restarting on the hottest days. Vertical mounting near tank is preferred. To 1.1 mtr. Fuel lift. Inlet/outlet 1/8"-27 thread. Fitting instruction. Fuel delivery capacity: 113.5 litre/h. Tested at: +60°C. Incl. 2 pcs. 6 mm hose nipples. 8 mm: HC-CARGO 080955. 8 mm angle: HC-CARGO 070181. Filter: HC-CARGO 070177.



Voltage: 24

Capacity: 113.5 l/h  
Pressure: 4-5 PSI

Type: Universal

#### 070058 Fuel Pump Std pkg 1 Servicing: Thermo King, Carrier - Visit [www.hc-cargo.com](http://www.hc-cargo.com) for further information.

Built in Pressure Relief: assures an immediate return to zero pressure when the ignition is turned off. Prevents flooding and assures satisfactory restarting on the hottest days. Vertical mounting near tank is preferred. To 1.1 mtr. Fuel lift. Inlet/outlet 1/8"-27 thread. Fitting instruction. Fuel delivery capacity: 113.5 litre/h. Tested at: +60°C. Incl. 2 pcs. 6 mm hose nipples. 8 mm: HC-CARGO 080955. 8 mm angle: HC-CARGO 070181. Filter: HC-CARGO 070177.



Voltage: 12

Capacity: 87 l/h  
Pressure: 7-9.5 PSI

Type: Universal



**070076 Fuel Pump** Std pkg 1  
w/ integral filter.



Voltage: 12

Thread: 1/8-27 INT  
Capacity: 150-227 l/h  
Pressure: 9-11.5 PSI

Fuel: Gasoline, diesel, ethanol, methanol  
Type: Universal  
Alternativ no.: 070214

**070134 Fuel Pump** Std pkg 1 Servicing: New-Holland, Same - Visit [www.hc-cargo.com](http://www.hc-cargo.com) for further information.

*Built in Pressure Relief: assures an immediate return to zero pressure when the ignition is turned off. Prevents flooding and assures satisfactory restarting on the hottest days. Vertical mounting near tank is preferred. to 1.1 mtr. Fuel lift. Inlet/outlet 1/8"-27 thread. Fitting instruction. Fuel delivery capacity: 113.5 litre/h. Tested at: +60°C. Filter: HC-CARGO 070177.*



Voltage: 12

Thread: In 1/4-18"  
Capacity: 136 l/h  
Pressure: 4-5 PSI

Type: Universal

**070214 Fuel Pump** Std pkg 1  
w/ integral filter.



Voltage: 12

Thread: 1/8-27 INT  
Capacity: 150-227 l/h  
Pressure: 9-11.5 PSI

Fuel: Gasoline, diesel, ethanol, methanol  
Type: Universal

**ACCESSORIES**

**070177 Filter** Std pkg 1 Servicing: HC-CARGO 070003, 070004, 070058, 070134



**PRESSURE PUMPS**

**070032 Fuel Pump** Std pkg 1

*Hose nipple 8 mm. Suction 1 mtr. Connectors can be rotated. Fitting instruction included.*



Voltage: 12

Capacity: 120 l/h  
Pressure: 0.2 bar

Fuel: Gasoline, diesel, ethanol, methanol  
Type: Universal

**070078 Fuel Pump** Std pkg 1

*Hose nipple 8 mm. Suction 1.5 mtr. Connectors can be rotated. Fitting instruction included.*



Voltage: 12

Capacity: 125 l/h  
Pressure: 0.35 bar

Type: Universal

**070107 Fuel Pump** Std pkg 1

Hose nipple 8 mm. Suction 1.5 mtr. Connectors can be rotated. Fitting instruction included.



Voltage: 24

 Capacity: 130 l/h  
 Pressure: 0.35 bar

 Fuel: Gasoline, diesel, ethanol, methanol  
 Type: Universal

**070161 Fuel Pump** Std pkg 1

Hose nipple 8 mm.



Voltage: 12

 Capacity: 80-150 l/h  
 Pressure: 0.1-0.4 kg  
 Pressure: 1.4-5.7 PSI

Type: Universal

## HIGH PERFORMANCE FUEL PUMPS

**070187 Fuel Pump** Std pkg 1

(Solid state pumps). Universal. Built in Pressure Relief: assures an immediate return to zero pressure when the ignition is turned off. Prevents flooding and assures satisfactory restarting on the hottest days. For cars w/ fuel-pressure. Not injection. To be mounted near the tank. The solid state pump is self priming to 30 cm. fuel lift. W/ electronic contacts. Fitting instruction included. Supplied w/ 2 pcs. 6 mm hose connection.



Voltage: 12

 Thread: In 1/8"-27  
 NPTF  
 Capacity: 95 l/h  
 Pressure: 0.1-0.28 bar  
 Pressure: 0.1-0.3 kg  
 Pressure: 1.5-4 PSI

 Fuel: Gasoline, diesel, ethanol, methanol  
 Type: Universal

**070188 Fuel Pump** Std pkg 1

(Solid state pumps). Universal. Built in Pressure Relief: assures an immediate return to zero pressure when the ignition is turned off. Prevents flooding and assures satisfactory restarting on the hottest days. For cars w/ fuel-pressure. Not injection. To be mounted near the tank. The solid state pump is self priming to 30 cm. fuel lift. W/ electronic contacts. Fitting instruction included. Replaceable hose nipple. Supplied w/ 2 pcs. 6 mm hose connection.



Voltage: 12

 Thread: In 1/8"-27  
 NPTF  
 Capacity: 132 l/h  
 Pressure: 0.3-0.5 kg  
 Pressure: 4-7 PSI

 Fuel: Gasoline, diesel, ethanol, methanol  
 Type: Universal

**070191 Fuel Pump** Std pkg 1

(Solid state pumps). Universal. Built in Pressure Relief: assures an immediate return to zero pressure when the ignition is turned off. Prevents flooding and assures satisfactory restarting on the hottest days. For cars w/ fuel-pressure. Not injection. To be mounted near the tank. The solid state pump is self priming to 30 cm. fuel lift. W/ electronic contacts. Fitting instruction included. Standard 6 mm hose nipples.



Voltage: 12

 Thread: In M8  
 Capacity: 130 l/h  
 Pressure: 0.5-0.7 kg  
 Pressure: 7-10 PSI

 Fuel: Gasoline, diesel, ethanol, methanol  
 Type: Universal

## SOLID STATE PUMPS

**070056 Fuel Pump** Std pkg 1 Servicing: Caterpillar, IH/Case - Visit [www.hc-cargo.com](http://www.hc-cargo.com) for further information.

*Built in Pressure Relief: assures an immediate return to zero pressure when the ignition is turned off. Prevents flooding and assures satisfactory restarting on the hottest days. Vertical mounting near tank is preferred. to 1.1 mtr. Fuel lift. Inlet/outlet 1/8"-27 thread. Fitting instruction. Fuel delivery capacity: 113.5 litre/h. Tested at: +60°C. Filter: HC-CARGO 070177.*

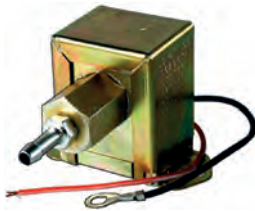

Voltage: 24

Capacity: 121 l/h  
Pressure: 0.3-0.45 kg  
Pressure: 4.5-6 PSI

Type: Universal

**070057 Fuel Pump** Std pkg 1 Servicing: Thermo King etc - Visit [www.hc-cargo.com](http://www.hc-cargo.com) for further information.

*Built in Pressure Relief: assures an immediate return to zero pressure when the ignition is turned off. Prevents flooding and assures satisfactory restarting on the hottest days. Vertical mounting near tank is preferred. to 1.1 mtr. Fuel lift. Inlet/outlet 1/8"-27 thread. Fitting instruction. Fuel delivery capacity: 113.5 litre/h. Tested at: +60°C. Filter: HC-CARGO 070177.*



Voltage: 12

Capacity: 121 l/h  
Pressure: 0.7 kg  
Pressure: 10 PSI

Fuel: Gasoline, diesel, ethanol, methanol  
Type: Universal

## SUCTION PUMPS

**070019 Fuel Pump** Std pkg 1 Servicing: Bobcat - Visit [www.hc-cargo.com](http://www.hc-cargo.com) for further information.

*Suction 0.2 bar = 2.7 mtr. Fitting instruction included.*



Voltage: 12

Thread: Out R-1/4"  
Capacity: 120 l/h  
Pressure: 0.2 bar

Fuel: Gasoline  
Type: Universal

**070021 Fuel Pump** Std pkg 1 Servicing: VW - Visit [www.hc-cargo.com](http://www.hc-cargo.com) for further information.

*Hose nipple 8 mm. Suction 1 mtr. Connectors can be rotated. Fitting instruction included.*



Voltage: 12

Capacity: 120 l/h  
Pressure: 0.15 bar

Fuel: Gasoline/diesel  
Type: Universal

**070184 Fuel Pump** Std pkg 1 Servicing: VW marine - Visit [www.hc-cargo.com](http://www.hc-cargo.com) for further information.

*Hose nipple 8 mm. Waterproof. Suction 1 mtr. Connectors can be rotated.*



Voltage: 12

Capacity: 120 l/h  
Pressure: 0.15 bar

Fuel: Gasoline, diesel, ethanol, methanol  
Type: Universal

## UNIVERSAL

### HOSE NIPPLES

**070067 Hose Nipple** Std pkg 2









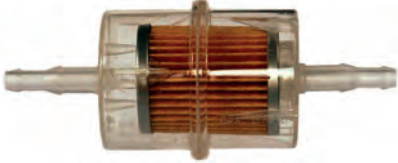

Hose ID: 10 mm  
Thread: R1/4

		EL. SPECIFICATIONS	DIMENSIONS	ADDITIONAL SPECIFICATIONS
<b>070070</b> Hose Nipple	Std pkg 2		Hose ID: 10 mm Thread: M16-1.5	
				
<b>070077</b> Hose Nipple	Std pkg 2		Hose ID: 6 mm Thread: 1/8-27 NPTF	
				
<b>070181</b> Hose Nipple	Std pkg 2	Servicing: HC-CARGO 070003, 070004, 070058		
90°.			Hose ID: 8 mm Thread: R1/8	
				
<b>080854</b> Hose Nipple	Std pkg 5		Hose ID: 8 mm Thread: M14-1.5	
				
<b>080855</b> Hose Nipple	Std pkg 5		Hose ID: 10 mm Thread: R1/2	
				
<b>080857</b> Hose Nipple	Std pkg 5		Hose ID: 8 mm Thread: 1/2-20 UNF	
				
<b>080858</b> Hose Nipple	Std pkg 5		Hose ID: 8 mm Thread: M16-1.5	
				
<b>080875</b> Hose Nipple	Std pkg 5		Hose ID: 11 mm Thread: M16-1.5	
				
<b>080954</b> Hose Nipple	Std pkg 2		Hose ID: 6 mm Thread: M14-1.5	
				

		EL. SPECIFICATIONS	DIMENSIONS	ADDITIONAL SPECIFICATIONS
<b>080955</b> Hose Nipple	Std pkg 2	Servicing: HC-CARGO 070003, 070004, 070058		
			Hose ID: 8 mm Thread: 1/8-27 NPTF	
<b>080958</b> Hose Nipple	Std pkg 5			
			Hose ID: 10 mm Thread: M18-1.5	
<b>080959</b> Hose Nipple	Std pkg 5			
			Hose ID: 10 mm Thread: M14-1.5	
<b>080960</b> Hose Nipple	Std pkg 5			
			Hose ID: 10 mm Thread: 1/2-20 UNF	
<b>081039</b> Nipple	Std pkg 10	Servicing: Bosch - Visit <a href="http://www.hc-cargo.com">www.hc-cargo.com</a> for further information.		
<i>90°.</i>				
				
<b>081040</b> Nipple	Std pkg 10	Servicing: Bosch - Visit <a href="http://www.hc-cargo.com">www.hc-cargo.com</a> for further information.		
<i>T- nippel.</i>				
				
<b>FUEL INJECTION PUMPS</b>				
<b>070053</b> Fuel Injection Pump	Std pkg 1	Servicing: Alfa Romeo, Austin, BMW, Citroen, Fiat, Jaguar, Lancia, Land Rover, Mercedes-Benz, Opel, Peugeot, Porsche, Renault - Visit <a href="http://www.hc-cargo.com">www.hc-cargo.com</a> for further information.		
		Voltage: 12	Pressure: 2-3.5 bar	
<b>070054</b> Fuel Injection Pump	Std pkg 1	Servicing: Alfa Romeo, Citroen, Fiat, Jaguar, Mercedes-Benz, Peugeot, Porsche, Renault, Saab, Volvo - Visit <a href="http://www.hc-cargo.com">www.hc-cargo.com</a> for further information.		
		Voltage: 12	Pressure: 4 bar	

		EL. SPECIFICATIONS	DIMENSIONS	ADDITIONAL SPECIFICATIONS
<b>070055 Fuel Injection Pump</b> Std pkg 1		Servicing: Ford, Mercedes-Benz - Visit <a href="http://www.hc-cargo.com">www.hc-cargo.com</a> for further information.		
		Voltage: 12	Pressure: 3 bar	
<b>FILTERS &amp; FILTER PARTS</b>				
<b>FUEL FILTERS</b>				
<b>090193 Filter House</b> Std pkg 1		90 l/hour. Glass Bowl: HC-CARGO 090073. Filter Cup: HC-CARGO 090127.		
			Thread: M14-1.5	Water separator: Yes
<b>090194 Filter House</b> Std pkg 1				
			Thread: 1/2"-20 UNF	Water separator: Yes
<b>090203 Filter House</b> Std pkg 1		Servicing: Ford Fiesta, Mondeo, Transit - Visit <a href="http://www.hc-cargo.com">www.hc-cargo.com</a> for further information.		
150 l/hour.				
			Hose nipple: 8 mm Thread: M14-1.5	Hand pump: Yes Water separator: Yes
<b>090213 Filter House</b> Std pkg 1		Flow 150 l/h. Glass Bowl: HC-CARGO 090074.		
			Thread: M14-1.5	Fuel: Diesel Water separator: Yes
<b>090345 Filter Kit</b> Std pkg 1				
Filter Top: HC-CARGO 090319.				
			Thread: M14-1.15	
<b>090346 Filter Kit</b> Std pkg 1				
Filter Top: HC-CARGO 090320.				
			Thread: 1/2"-20	

EL. SPECIFICATIONS		DIMENSIONS	ADDITIONAL SPECIFICATIONS
<b>090404</b> Filter House <span style="float: right;">Std pkg 1</span> <i>Glass Bowl: HC-CARGO 090074.</i>			
		Thread: 1/2"-20 UNF	Water separator: Yes
<b>AS301</b> Fuel Filter <span style="float: right;">Std pkg 1</span> Servicing: Alfa Romeo, Audi, Citroen, Fiat, Ford, Land Rover, Peugeot, Renault, Seat, Volvo - Visit <a href="http://www.hc-cargo.com">www.hc-cargo.com</a> for further information.			Fuel: Diesel
			
<b>RT1000</b> Fuel Filter <span style="float: right;">Std pkg 12</span>			
		ID/hose: 6 mm ID/hose 2: 8 mm	Fuel: Gasoline Universal: Yes Transparent: Yes
<b>RT1003</b> Fuel Filter <span style="float: right;">Std pkg 24</span>			
		ID/hose: 6 mm ID/hose 2: 8 mm	Fuel: Gasoline Universal: Yes Transparent: Yes
<b>RT1005</b> Fuel Filter <span style="float: right;">Std pkg 12</span>			
		ID/hose: 6 mm ID/hose 2: 6 mm	Fuel: Gasoline Universal: Yes Transparent: Yes
<b>RT2002</b> Fuel Filter <span style="float: right;">Std pkg 24</span> <i>Only for diesel fuel.</i>			
		ID/hose: 6 mm ID/hose 2: 8 mm	Fuel: Diesel Universal: Yes Transparent: Yes
<b>RT2006</b> Fuel Filter <span style="float: right;">Std pkg 6</span> <i>281 micron.</i>			
		ID/hose: 6 mm ID/hose 2: 8 mm	Fuel: Diesel Universal: Yes Transparent: Yes
<b>RT2016</b> Fuel Filter <span style="float: right;">Std pkg 12</span> Servicing: Seat, Peugeot, VW, Volvo, Vauxhall, Peugeot, Seat, Vauxhall, Volvo, VW - Visit <a href="http://www.hc-cargo.com">www.hc-cargo.com</a> for further information.			
		ID/hose: 6 mm ID/hose 2: 8 mm	Fuel: Diesel Universal: Yes Transparent: Yes

**FUEL HEATERS**
**080944** Heat Exchanger

Std pkg 1



Thread: M16-1.5

 Type: Water  
 Sandwich type: Yes

**081176** Fuel Heater

Std pkg 1

 Voltage: 12  
 Watt: 150

 Demister tube  
 connection: 8/10 mm

 Type: Electric  
 Sandwich type: No

**WATER SEPARATOR**
**090145** Water Separator

Std pkg 1



Thread: M14-1.5

Universal: Yes

**090146** Water Separator

Std pkg 1



Thread: 1/2"-20 UNF

Universal: Yes

**SPARE PARTS**
**080465** Gasket

Std pkg 10

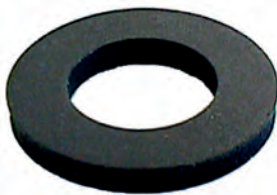
 Servicing: CAV - Visit [www.hc-cargo.com](http://www.hc-cargo.com) for further information.

 ID: 15 mm  
 OD: 28 mm  
 Thickness: 3 mm

**080701** Gasket

Std pkg 10

 Servicing: CAV - Visit [www.hc-cargo.com](http://www.hc-cargo.com) for further information.

*For filter glass.*

 ID: 80 mm  
 OD: 88 mm  
 Thickness: 3 mm

**080702** Gasket

Std pkg 10

 Servicing: CAV - Visit [www.hc-cargo.com](http://www.hc-cargo.com) for further information.

*For filter glass.*

 ID: 77 mm  
 OD: 84 mm  
 Thickness: 3 mm



	EL. SPECIFICATIONS	DIMENSIONS	ADDITIONAL SPECIFICATIONS
<b>080805</b> Gasket <i>For filter glass.</i>	Std pkg 10	Servicing: CAV - Visit <a href="http://www.hc-cargo.com">www.hc-cargo.com</a> for further information.	
		ID: 41.5 mm OD: 54 mm Thickness: 3 mm	
<b>081007</b> Gasket Kit	Std pkg 1	Servicing: CAV - Visit <a href="http://www.hc-cargo.com">www.hc-cargo.com</a> for further information.	
			
<b>090071</b> Single Cover	Std pkg 1	Thread: M14-1.5	Universal: Yes
			
<b>090072</b> Single Cover	Std pkg 1	Thread: 1/2"-20 UNF	Universal: Yes
			
<b>090073</b> Glass Bowl	Std pkg 1	Servicing: HC-CARGO 090193	
			
<b>090127</b> Filter Cup	Std pkg 1	Servicing: HC-CARGO 090193	
			
<b>090166</b> Filter Cover <i>Filter thread 16x1.5 mm.</i>	Std pkg 1	Thread: M14-1.5	Hand pump: Yes
			

EL. SPECIFICATIONS		DIMENSIONS	ADDITIONAL SPECIFICATIONS
<b>090167</b> Filter Cover      Std pkg 1      Servicing: Bosch, VW, GM - Visit <a href="http://www.hc-cargo.com">www.hc-cargo.com</a> for further information. Filter thread 16x1.5 mm.			
		Thread: M14-1.5	Hand pump: Yes Universal: Yes
<b>090172</b> Glass      Std pkg 1 For water separator.			
			
<b>090316</b> Filter Top      Std pkg 1			
		Thread: M14-1.5	Hand pump: Yes Universal: Yes
<b>090319</b> Filter Top      Std pkg 1      Servicing: HC-CARGO 090345			
		Thread: M14-1.5	
<b>090320</b> Filter Top      Std pkg 1      Servicing: HC-CARGO 090346			
		Thread: 1/2"-20 UNF	
<b>090347</b> Filter Top      Std pkg 1      Servicing: Japanese appl - Visit <a href="http://www.hc-cargo.com">www.hc-cargo.com</a> for further information. 8 mm hose I.D.			
		Thread: 20x1.5	Hand pump: Yes Universal: Yes
<b>090381</b> Filter Top      Std pkg 1 Filter thread 16x1.5 mm.			
		Thread: 14x1.5	Universal: Yes

**DIESEL PARTS**

**BEARINGS**

090061 Repair Kit Std pkg 1



**DIESEL PUMP PARTS**

080038 Air Screw Std pkg 1 Servicing: DPA

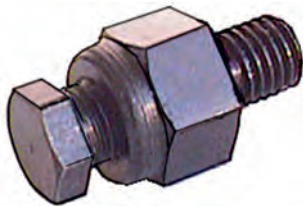

080114 Hollow Screw Std pkg 1



Thread: M12-1.5  
Hole size: 5.5 mm

Calibrated: Yes

080614 Rotor Vane Set Std pkg 1 Servicing: CAV DPA/DPC - Visit [www.hc-cargo.com](http://www.hc-cargo.com) for further information.

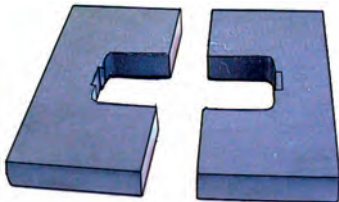

080752 Diaphragm Std pkg 1 Servicing: DPC



080757 Diaphragm Std pkg 5 Servicing: DPS - Visit [www.hc-cargo.com](http://www.hc-cargo.com) for further information.



080773 Rotor Vane Set Std pkg 1 Servicing: DPA



080815 Liner

Std pkg 1

Servicing: CAV DPA - Visit [www.hc-cargo.com](http://www.hc-cargo.com) for further information.

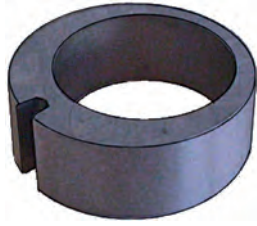

080824 Rotor Vane Set

Std pkg 1

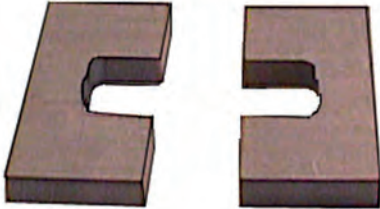

080969 Diaphragm

Std pkg 1

Servicing: DPC

*Diaphragm set for boost controller.*



081004 Injector Nut

Std pkg 1

Servicing: Volvo Penta - Visit [www.hc-cargo.com](http://www.hc-cargo.com) for further information.



090027 Repair Kit

Std pkg 1

Servicing: Bosch PE6P

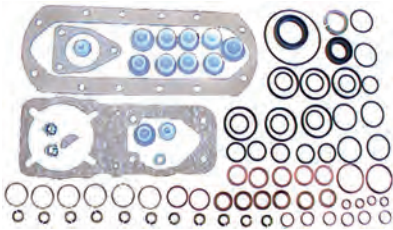

090047 Repair Kit

Std pkg 1

Servicing: CAV DPA pumps - Visit [www.hc-cargo.com](http://www.hc-cargo.com) for further information.



090055 Gasket Kit

Std pkg 1

Servicing: CAV DPS



090062 Damper Std pkg 1 Servicing: Bosch - Visit [www.hc-cargo.com](http://www.hc-cargo.com) for further information.



090136 Gasket Kit Std pkg 1 Servicing: CAV DPC "Turbo" - Visit [www.hc-cargo.com](http://www.hc-cargo.com) for further information.

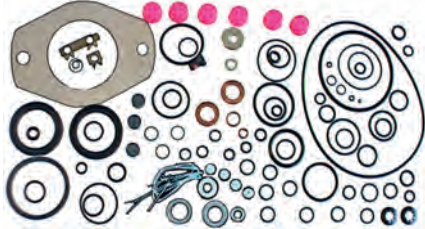

090150 End Plate Std pkg 1



090222 Gasket Kit Std pkg 1 Servicing: Simms Minimec 4 cyl, CAV - Visit [www.hc-cargo.com](http://www.hc-cargo.com) for further information.

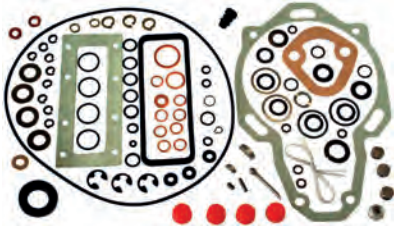

090223 Gasket Kit Std pkg 1

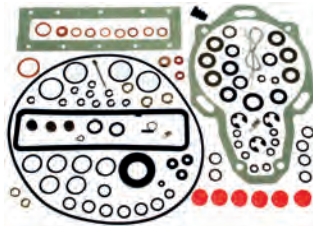















090233 Cover Std pkg 1



090242 Gasket Kit Std pkg 1 Servicing: Stanadyne DB2 - Visit [www.hc-cargo.com](http://www.hc-cargo.com) for further information.









	EL. SPECIFICATIONS	DIMENSIONS	ADDITIONAL SPECIFICATIONS
<b>090244</b> Governor Kit 	Std pkg 1	Servicing: CAV Minimec - Visit <a href="http://www.hc-cargo.com">www.hc-cargo.com</a> for further information.	
<b>090277</b> Start Advance 	Std pkg 1	Servicing: Talbot - Visit <a href="http://www.hc-cargo.com">www.hc-cargo.com</a> for further information.	
<b>090278</b> Start Advance 	Std pkg 1	Servicing: Citroen, Peugeot - Visit <a href="http://www.hc-cargo.com">www.hc-cargo.com</a> for further information.	
<b>090294</b> Gasket Kit 	Std pkg 1	Servicing: CAV Epic, Lucas Epic - Visit <a href="http://www.hc-cargo.com">www.hc-cargo.com</a> for further information.	
<b>090344</b> Gasket Kit 	Std pkg 1	Servicing: Stanadyne DB4 - Visit <a href="http://www.hc-cargo.com">www.hc-cargo.com</a> for further information.	
<b>090441</b> Gasket Kit <i>Repair kit for VW injector pumps. Incl. Parts for 1 injectors.</i> 	Std pkg 1	Servicing: VW. - Visit <a href="http://www.hc-cargo.com">www.hc-cargo.com</a> for further information.	
<b>FEED PUMPS</b>			
<b>090015</b> Feed Pump 	Std pkg 1	Type: Plunger Valves: 2	

		EL. SPECIFICATIONS	DIMENSIONS	ADDITIONAL SPECIFICATIONS
<b>090016</b>	Feed Pump	Std pkg 1		Type: Plunger No./mounting holes: 2 Valves: 2
				
<b>090020</b>	Feed Pump	Std pkg 1		Type: Plunger Valves: 2
				
<b>090151</b>	Feed Pump	Std pkg 1	Servicing: Hatz - Visit <a href="http://www.hc-cargo.com">www.hc-cargo.com</a> for further information.	
				Type: Diaphragm
<b>090156</b>	Feed Pump	Std pkg 1	Servicing: Cummins, DAF, I.H - Visit <a href="http://www.hc-cargo.com">www.hc-cargo.com</a> for further information.	
				Type: Diaphragm
<b>090187</b>	Feed Pump	Std pkg 1	Servicing: Fiat, Iveco, New Holland - Visit <a href="http://www.hc-cargo.com">www.hc-cargo.com</a> for further information.	
				Type: Diaphragm
<b>090197</b>	Feed Pump	Std pkg 1	Servicing: Ford Transit 2.5 L - Visit <a href="http://www.hc-cargo.com">www.hc-cargo.com</a> for further information.	
				Type: Diaphragm
<b>090198</b>	Feed Pump	Std pkg 1		Type: Plunger
				

		EL. SPECIFICATIONS	DIMENSIONS	ADDITIONAL SPECIFICATIONS
090202	Feed Pump	Std pkg 1		Type: Plunger
				
090235	Feed Pump	Std pkg 1	Servicing: Vetus, Volvo Penta - Visit <a href="http://www.hc-cargo.com">www.hc-cargo.com</a> for further information.	Type: Diaphragm
				
090250	Feed Pump	Std pkg 1	Servicing: Cummins - Visit <a href="http://www.hc-cargo.com">www.hc-cargo.com</a> for further information.	Type: Diaphragm
				
090251	Feed Pump	Std pkg 1	Servicing: Cummins - Visit <a href="http://www.hc-cargo.com">www.hc-cargo.com</a> for further information.	Type: Plunger
				
090253	Feed Pump	Std pkg 1	Servicing: Kubota Industry - Visit <a href="http://www.hc-cargo.com">www.hc-cargo.com</a> for further information.	Type: Diaphragm
				
090254	Feed Pump	Std pkg 1		Type: Diaphragm
				
090314	Feed Pump	Std pkg 1		Type: Diaphragm
				

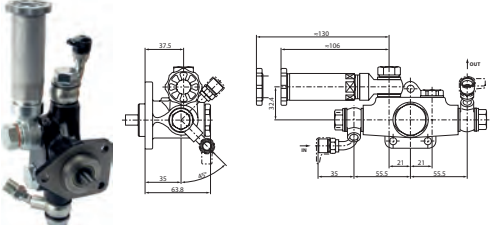

		EL. SPECIFICATIONS	DIMENSIONS	ADDITIONAL SPECIFICATIONS
<b>090315</b> Feed Pump	Std pkg 1			Type: Plunger
				
<b>090333</b> Feed Pump	Std pkg 1			Type: Diaphragm
				
<b>090337</b> Feed Pump	Std pkg 1			Type: Diaphragm
				
<b>090391</b> Feed Pump	Std pkg 1	Servicing: Cummins - Visit <a href="http://www.hc-cargo.com">www.hc-cargo.com</a> for further information.		
				
<b>090440</b> Feed Pump	Std pkg 1	Servicing: Thermo King and Carrier - Visit <a href="http://www.hc-cargo.com">www.hc-cargo.com</a> for further information.		
				
<b>SPARE PARTS</b>				
<b>080059</b> Valve Repair Kit	Std pkg 1			
				
<b>080064</b> Valve Repair Kit	Std pkg 1			
				

EL. SPECIFICATIONS		DIMENSIONS	ADDITIONAL SPECIFICATIONS
<b>080071</b> Hand Pump <span style="float: right;">Std pkg 1</span>			
		Thread: M14-1.5 Inlet size: 14	Type: Universal
<b>080097</b> Oil Seal <span style="float: right;">Std pkg 10 Servicing: VE pumps</span>			
		ID: 20 mm OD: 31.1 mm Height: 6.9 mm	
<b>080099</b> Gasket <span style="float: right;">Std pkg 10 Servicing: HC-CARGO 080730, Bosch VE</span>			
			Type: Diesel Material: Viton
<b>080168</b> Repair Kit <span style="float: right;">Std pkg 1</span> <i>Bushing length: 40.5 mm.</i>			
			
<b>080170</b> Repair Kit <span style="float: right;">Std pkg 1 Servicing: HC-CARGO 080730, 0460494251</span> <i>Bushing length: 30.5 mm.</i>			
			
<b>080205</b> Gasket <span style="float: right;">Std pkg 10 Servicing: CAV - Visit <a href="http://www.hc-cargo.com">www.hc-cargo.com</a> for further information.</span>			
			
<b>080292</b> Glass Bowl <span style="float: right;">Std pkg 5 Servicing: Bosch - Visit <a href="http://www.hc-cargo.com">www.hc-cargo.com</a> for further information.</span> <i>For filter glass.</i>			
			

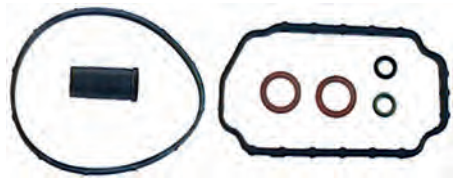
EL. SPECIFICATIONS		DIMENSIONS	ADDITIONAL SPECIFICATIONS
<p><b>080294 Repair Kit</b> Std pkg 1</p> 			
<p><b>080295 Hand Pump</b> Std pkg 1</p> 		Thread: M16-1.5	
<p><b>080695 Hand Pump</b> Std pkg 1 Union: HC-CARGO 081003.</p> 		Thread: M22-1	
<p><b>080703 Hand Pump</b> Std pkg 1 For hose I.D. 8 mm.</p> 			Type: Universal
<p><b>080730 Repair Kit</b> Std pkg 1 Contains: 1x HC-CARGO 080170. 1x HC-CARGO 080099.</p> 			
<p><b>080738 Gasket</b> Std pkg 10</p> 			
<p><b>080742 Hand Pump</b> Std pkg 1</p> 		Thread: M16-1.5	

	EL. SPECIFICATIONS	DIMENSIONS	ADDITIONAL SPECIFICATIONS
<b>080783</b> Repair Kit 	Std pkg 1	Servicing: CAV - Visit <a href="http://www.hc-cargo.com">www.hc-cargo.com</a> for further information.	
<b>080793</b> Hand Pump 	Std pkg 1	Thread: M14-1.5	Type: Universal
<b>080811</b> Repair Kit 	Std pkg 1	Servicing: Bosch - Visit <a href="http://www.hc-cargo.com">www.hc-cargo.com</a> for further information.	
<b>080840</b> Hand Pump 	Std pkg 1	Thread: M16-1.5	Material: Steel
<b>080852</b> Repair Kit 	Std pkg 1	Servicing: Bosch - Visit <a href="http://www.hc-cargo.com">www.hc-cargo.com</a> for further information.	
<b>080933</b> Gasket 	Std pkg 5	Servicing: CAV DPA - Visit <a href="http://www.hc-cargo.com">www.hc-cargo.com</a> for further information. Material: Cardboard	
<b>081003</b> Union 	Std pkg 10	Servicing: HC-CARGO 080695 Thread: M16-1.5-M22-1	

		EL. SPECIFICATIONS	DIMENSIONS	ADDITIONAL SPECIFICATIONS
<b>081058</b>	Hot Starting Device	Std pkg 1	Servicing: VE-EDC pumps for Audi, BMW, Seat, Skoda, VW - Visit <a href="http://www.hc-cargo.com">www.hc-cargo.com</a> for further information.	
				
<b>081169</b>	Repair Kit Injectors	Std pkg 1	Servicing: Common Rail injectors - Visit <a href="http://www.hc-cargo.com">www.hc-cargo.com</a> for further information.	
				
<b>090076</b>	Prefilter	Std pkg 1	Thread: M14-1.5	Fuel: Diesel Filter type: Prefilter
				
<b>090159</b>	Hand Pump	Std pkg 1	Thread: 1/2"-20 UNF Inlet size: 14	Type: Universal
				
<b>FILTER PARTS</b>				
<b>080721</b>	Plug	Std pkg 10		
				
<b>080809</b>	Plug	Std pkg 5	Servicing: CAV - Visit <a href="http://www.hc-cargo.com">www.hc-cargo.com</a> for further information.	
				
<b>090074</b>	Glass Bowl	Std pkg 1	Servicing: HC-CARGO 090213, 090404, CAV	
				

**GOVERNOR PARTS**
**090147** Diesel Injection Pump      Std pkg 1      Servicing: Bosch RSV Turbo - Visit [www.hc-cargo.com](http://www.hc-cargo.com) for further information.

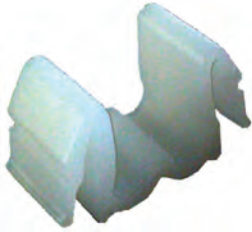
**INJECTION PIPE HOLDERS**
**080046** Injection Pipe Holder      Std pkg 5

 Material: Plastic  
 No./pipes: 2

**080047** Injection Pipe Holder      Std pkg 10

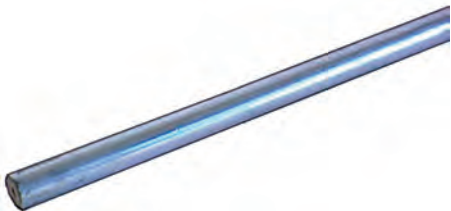
 Material: Plastic  
 No./pipes: 3

**INJECTION PIPES**
**090086** Injection Pipe      Std pkg 1

 ID: 1.5 mm  
 OD: 6 mm  
 Length: 3000 mm

Universal: Yes

**090087** Injection Pipe      Std pkg 1

 ID: 2 mm  
 OD: 6 mm  
 Length: 3000 mm

Universal: Yes

**NOZZLES**
**100342** Nozzle      Std pkg 1      Servicing: Audi, Fiat, Ford, Mazda, Nissan, Renault, Volvo, VW - Visit [www.hc-cargo.com](http://www.hc-cargo.com) for further information.

 Code type: DN0SD193  
 Nozzle type: Diesel

		EL. SPECIFICATIONS	DIMENSIONS	ADDITIONAL SPECIFICATIONS
100344	Nozzle	Std pkg 1	Servicing: BMW, Mercedes-Benz, Peugeot, Toyota - Visit <a href="http://www.hc-cargo.com">www.hc-cargo.com</a> for further information.	Code type: DN0SD220 Nozzle type: Diesel
				
100348	Nozzle	Std pkg 1	Servicing: Audi, Volvo, VW - Visit <a href="http://www.hc-cargo.com">www.hc-cargo.com</a> for further information.	Code type: DN0SD293 Nozzle type: Diesel
				
100352	Nozzle	Std pkg 1	Servicing: Mercedes-Benz - Visit <a href="http://www.hc-cargo.com">www.hc-cargo.com</a> for further information.	Code type: DN0SD265 Nozzle type: Diesel
				
100353	Nozzle	Std pkg 1	Servicing: Alfa Romeo - Visit <a href="http://www.hc-cargo.com">www.hc-cargo.com</a> for further information.	Code type: DN12SD12 Nozzle type: Diesel
				
100471	Nozzle	Std pkg 1	Servicing: Audi, Seat, Skoda, VW - Visit <a href="http://www.hc-cargo.com">www.hc-cargo.com</a> for further information.	Code type: DN0SD297 Nozzle type: Diesel
				
100525	Nozzle	Std pkg 1		Code type: DLLA150S720 Nozzle type: Diesel
				
100573	Nozzle	Std pkg 1		Code type: DN10PDN130 Nozzle type: Diesel
				

**NOZZLE HOLDER PARTS**
**080055** Inj. Pipe Nut Set Std pkg 10

 OD: 6 mm  
 Thread size: M14-1.5

**080340** Injector Spacer Std pkg 1 Servicing: Bosch, kbal, kdal

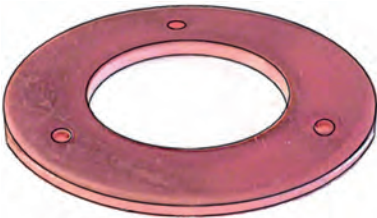
**080389** Injector Washer Std pkg 10

 ID: 12.1 mm  
 OD: 23 mm  
 Thickness: 1 mm

**Overflow washers:** Copper

**080457** Injector Washer Std pkg 10

 Servicing: Mitsubishi, Nissan, Toyota, mm - Visit [www.hc-cargo.com](http://www.hc-cargo.com) for further information.

 ID: 12 mm  
 OD: 18.5 mm  
 Thickness: 1 mm

**Overflow washers:** Aluminium

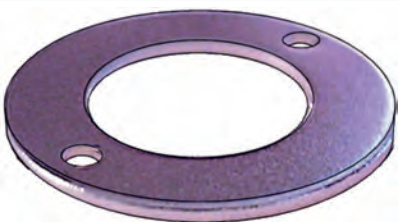
**080458** Injector Washer Std pkg 10

 ID: 12.5 mm  
 OD: 22.5 mm  
 Thickness: 1 mm

**Overflow washers:** Aluminium

**080459** Injector Washer Std pkg 10

 ID: 12 mm  
 OD: 19.1 mm  
 Thickness: 1 mm

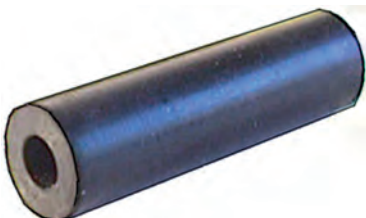
**Overflow washers:** Copper

**080467** Plug Std pkg 50 Servicing: Bosch - Mercedes - Visit [www.hc-cargo.com](http://www.hc-cargo.com) for further information.



**080582** Eye Union Overflow Std pkg 5

Spanner size 24 mm.

 Overflow washers: Brass  
 No./nipples: 1

**080879** Adjustment Shims Std pkg 20

 Servicing: Bosch - Visit [www.hc-cargo.com](http://www.hc-cargo.com) for further information.

 ID: 3 mm  
 OD: 8.5 mm  
 Thickness: 0.95 mm

Shims type: Nozzles

**081041** Overflow Kit Std pkg 1

Hose 100 cm.



No./nipples: 4

**081129** Injector Seal Kit Std pkg 4

 Servicing: Opel - Visit [www.hc-cargo.com](http://www.hc-cargo.com) for further information.

## SEALING RINGS

**080865** Sealing Ring Std pkg 50

 ID: 8 mm  
 OD: 16 mm  
 Thickness: 1 mm

Material: Steel/rubber

**080866** Sealing Ring Std pkg 50

 ID: 10 mm  
 OD: 18 mm  
 Thickness: 1.5 mm

Material: Steel/rubber

**080868** Sealing Ring Std pkg 50

 ID: 14.7 mm  
 OD: 21 mm  
 Thickness: 1.5 mm

Material: Steel/rubber

## THROTTLE SHAFTS

**080188** Throttle Shaft Std pkg 1 Servicing: CAV DPA - Visit [www.hc-cargo.com](http://www.hc-cargo.com) for further information.

Type/throttle shaft: Short

## VE PUMP PARTS

**090092** Repair Kit Std pkg 1 Servicing: Bosch VE - Visit [www.hc-cargo.com](http://www.hc-cargo.com) for further information.

*Turbo.*

**090165** Gasket Kit Std pkg 1 Servicing: Bosch VE - Visit [www.hc-cargo.com](http://www.hc-cargo.com) for further information.

**090212** Gasket Kit Std pkg 1 Servicing: Bosch VE - Visit [www.hc-cargo.com](http://www.hc-cargo.com) for further information.

## VE THROTTLE SHAFTS

**080828** Throttle Shaft Std pkg 1 Servicing: Opel, Ford, VW - Visit [www.hc-cargo.com](http://www.hc-cargo.com) for further information.

 Total length: 59.5 mm  
 Total height: 47.2 mm  
 Bottom o-ring:  
 26.7 mm  
 Top o-ring: 3 mm

## GLOW PLUGS

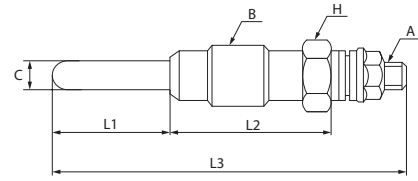

HC-CARGO	Std pkg	Voltage/ glow plug	Voltage/ battery	Ampere	Thread	L1	L2	L3	Glow duration
100079	Pkg. 1	0.9	12	6.3	M18-1.50	32.5 mm	27.5 mm	90 mm	SHP sec.
100086	Pkg. 1	11	12	10	M14-1.25	34 mm	28 mm	77.4 mm	8 sec.
100177	Pkg. 1	11.5	12	13	UNF 7/8-14	62 mm	32 mm		SHP sec.
100245	Pkg. 1	5	12	11	M10-1.25	47 mm	24 mm	89 mm	20 sec.
100246	Pkg. 1	12	12	8.5	M10-1.25	52 mm	22 mm	95 mm	20 sec.
100247	Pkg. 1	11	12	9	M10-1.25	33.5 mm	19 mm	70 mm	20 sec.
100251	Pkg. 1	11	12	8	M10-1.25	33.5 mm	19 mm	70 mm	20 sec.
100252	Pkg. 1	23	24	7.5	M10-1.25	33.5 mm	19 mm	70 mm	20 sec.
100254	Pkg. 1	6.5	12	6.5	M10-1.25	33.5 mm	19 mm	70 mm	20 sec.
100256	Pkg. 1	8.5	12	9	M10-1.25	53 mm	28 mm	101 mm	20 sec.
100257	Pkg. 1	7	12	8.5	M10-1.25	53 mm	28 mm	101 mm	20 sec.
100258	Pkg. 1	7	12	8	M10-1.25	43 mm	31.5 mm	95 mm	20 sec.
100259	Pkg. 1	14	24	4.8	M10-1.25	53 mm	28 mm	101 mm	15 sec.
100260	Pkg. 1	11	12	11	M10-1.25	43.5 mm	31.5 mm	96 mm	20 sec.
100261	Pkg. 1	11	12	16.5	M10-1.25	45 mm	22 mm	86 mm	15 sec.
100262	Pkg. 1	10.5	12	10	M18-1.5	47.5 mm	25 mm	87.9 mm	20 sec.
100263	Pkg. 1	11	12	10	M10-1	53.3 mm	28.5 mm	98.5 mm	15 sec.
100271	Pkg. 1	11	12	10	M10-1.25	33.5 mm	17 mm	67 mm	10 sec.
100275	Pkg. 1	11	12	6.5	M10-1.25	47 mm	24 mm	89 mm	25 sec.
100276	Pkg. 1	23	24	4.8	M10-1.25	33.5 mm	17 mm	67 mm	10 sec.
100277	Pkg. 1	6	12	8	M10-1.25	43.5 mm	31.5 mm	95 mm	12 sec.
100280	Pkg. 1	21	24	5	M10-1.25	53 mm	28 mm	101 mm	20 sec.
100282	Pkg. 1	23	24	4.6	M10-1.25	53 mm	28 mm	101 mm	20 sec.
100283	Pkg. 1	11	12	10	M10-1.25	53 mm	28 mm	101 mm	10 sec.
100284	Pkg. 1	11	12	10	M12-1.25	32 mm	29 mm	76.4 mm	8 sec.
100286	Pkg. 1	8.5	12	9	M10-1.25	45 mm	22 mm	86 mm	20 sec.
100287	Pkg. 1	11	12	10	M10-1.25	50 mm	22 mm	88 mm	10 sec.
100291	Pkg. 1	11	12	6	M10-1.25	43.5 mm	32 mm	95 mm	10 sec.
100292	Pkg. 1	11	12	6	M10-1.25	47 mm	24 mm	89 mm	10 sec.
100295	Pkg. 1	9	12	10	M18-1.50	35 mm	28 mm	78.4 mm	20 sec.
100302	Pkg. 1	11	12	7	M10-1.25	47 mm	18.5 mm	83 mm	7 sec.
100303	Pkg. 1	11	12	8	M12-1.25	32 mm	20 mm	66.9 mm	8 sec.
100306	Pkg. 1	11	12	10	M10-1.25	50 mm	19 mm	84.4 mm	8 sec.
100307	Pkg. 1	11.5	12	10	M10-1	83 mm	26.5 mm	124.9 mm	8 sec.
100310	Pkg. 1	11	12	14	M10-1.25	54 mm	20 mm	94 mm	5 sec.
100320	Pkg. 1	11	12	10	M10-1	38 mm	24.5 mm	77.9 mm	8 sec.
100323	Pkg. 1	11	12	10	M10-1	46 mm	24 mm	85.4 mm	8 sec.
100324	Pkg. 1	6.5	12	5.5	M10-1.25	47 mm	21.5 mm	84 mm	15 sec.
100325	Pkg. 1	6.5	12	5.5	M10-1.25	90 mm	21.5 mm		20 sec.
100326	Pkg. 1	11	12	10	M10-1.25	62 mm	18.5 mm	95 mm	9 sec.
100327	Pkg. 1	12.5	12	10	M12-1.25	67.5 mm	27.5 mm	120.4 mm	8 sec.
100331	Pkg. 1	11.5	12	10	M12-1.25	32 mm	22 mm	69.4 mm	8 sec.
100335	Pkg. 1	11	12	10	M10-1	46 mm	29 mm	90.4 mm	8 sec.
100336	Pkg. 1	11	12	10	M10-1.25	52 mm	15.5 mm	81.5 mm	10 sec.
100337	Pkg. 1	11.5	12	10	M12-1.25	37 mm	27 mm	87 mm	8 sec.
100339	Pkg. 1	11.5	12	10	M12-1.25	67.5 mm	27 mm	115.9 mm	8 sec.
100426	Pkg. 1	11	12	7.2	M10-1.25	47 mm	17 mm	84 mm	15 sec.
100429	Pkg. 1	11	12	8-10	M10-1.25	58.5 mm	25 mm	104 mm	10 sec.
100432	Pkg. 1	11	12	10	M12-1.25	27 mm	25 mm	67.4 mm	8 sec.
100433	Pkg. 1	11	12	7.5	M10-1.25	33.5 mm	17 mm	70 mm	20 sec.
100434	Pkg. 1	11	12	8	M10-1.25	39 mm	16 mm	75 mm	20 sec.
100435	Pkg. 1	11	12	6.5	M10-1.25	37.5 mm	16 mm	75 mm	25 sec.
100436	Pkg. 1	11	12	10	M10-1	46 mm	24 mm	92 mm	8 sec.
100510	Pkg. 1	11	12	7	M10-1.25	47 mm	17.5 mm	85 mm	7 sec.
100511	Pkg. 1	11	12	22	M12-1.25	57 mm	25 mm	72.5 mm	5 sec.
100512	Pkg. 1	11	12	10	M12-1.25	26 mm	20 mm	61.4 mm	8 sec.

HC-CARGO	Std pkg	Voltage/ glow plug	Voltage/ battery	Ampere	Thread	L1	L2	L3	Glow duration
100513	Pkg. 1	11	12	7	M10-1.25	53 mm	17.5 mm	89 mm	7 sec.
100514	Pkg. 1	11	12	6	M10-1.25	53 mm	28 mm	101 mm	10 sec.
100515	Pkg. 1	11	12	6	M10-1.25	45 mm	22 mm	84 mm	8.5 sec.
100516	Pkg. 1	11	12	5	M10-1.25	43.5 mm	32 mm	97 mm	8 sec.
100518	Pkg. 1	11	12	7.3	M8-1	34 mm	19.5 mm	69 mm	7 sec.
100520	Pkg. 1	11	12	6.5	M10-1.25	47 mm	22.5 mm	85 mm	5 sec.
100521	Pkg. 1	11	12	9.7	M10-1.25	45 mm	22 mm	83.5 mm	9 sec.
100522	Pkg. 1	10	12	10	M10-1.25	34.5 mm	17 mm	68 mm	6 sec.
100523	Pkg. 1	11	12	6	M10-1.25	33.5 mm	24.5 mm	80 mm	8.5 sec.
100524	Pkg. 1	11	12	6	M10-1.25	85 mm	30 mm		8.5 sec.
100527	Pkg. 1	11	12	10	M10-1	46 mm	29 mm	97 mm	8 sec.
100529	Pkg. 1	11	12	10	M10-1	46 mm	24 mm	85.4 mm	8 sec.
100531	Pkg. 1	11	12	10	M12-1.25	30 mm	17.5 mm	62.9 mm	8 sec.
100532	Pkg. 1	11	12	10	M10-1	53 mm	24.5 mm	92.9 mm	8 sec.
100533	Pkg. 1	11	12	6-11	M10-1	107 mm	27.5 mm		6 sec.
100534	Pkg. 1	11	12	10	M10-1	57 mm	24 mm	96.4 mm	8 sec.
100536	Pkg. 1	11	12	10	M10-1	46 mm	32 mm	106 mm	8 sec.
100537	Pkg. 1	11.5	12	10	M10-1	80.5 mm	27 mm	130.5 mm	8 sec.
100538	Pkg. 1	12	12	10	M10-1	70 mm	34.5 mm	126.5 mm	8 sec.
100540	Pkg. 1	10.5	12	10	M10-1	53 mm	27.5 mm	95.9 mm	8 sec.
100541	Pkg. 1	11	12	10	M12-1.25	29 mm	25 mm	69.4 mm	8 sec.
100544	Pkg. 1	11	12	10	M10-1	76 mm	28.5 mm	132.5 mm	8 sec.
100545	Pkg. 1	11	12	10	M12-1.25	32 mm	25 mm	72.4 mm	8 sec.
100548	Pkg. 1	10.5	12	10	M10-1	27.3 mm	28.5 mm	77.3 mm	sec.
100555	Pkg. 1	11	12	10	M10-1.25	93 mm	23.5 mm	143 mm	10 sec.
100556	Pkg. 1	11	12	10	M10-1.25	111.5 mm	37 mm	170 mm	7 sec.
100557	Pkg. 1	11	12	10	M10-1.25	47 mm	17.5 mm	85 mm	7 sec.
100559	Pkg. 1	11	12	10	M10-1.25	47 mm	20.5 mm	88 mm	5 sec.
100560	Pkg. 1	11	12	10	M10-1.25	140.5 mm	21 mm	180 mm	5 sec.
100561	Pkg. 1	12	12	12	M10-1	95 mm	35 mm	104.7 mm	10 sec.
100563	Pkg. 1	11	12	12	M10-1.25	47 mm	21.5 mm	89 mm	7 sec.
100565	Pkg. 1	10	12	10	M10-1	54.5 mm	24.5 mm	96 mm	10 sec.
100566	Pkg. 1	9.5	12	10	M14-2	52.5 mm	30 mm	97.9 mm	20 sec.
100578	Pkg. 1	11	12	10	M10-1.25	175.5 mm	23 mm	213 mm	7 sec.
100580	Pkg. 1	8	12	16	M22-1.5	64.5 mm	33 mm		SHP sec.
100581	Pkg. 1	10.5	12	10	M10-1.25	45 mm	23 mm	83.4 mm	8 sec.
100583	Pkg. 1	10.5	12	14	M18-1.5	87.9 mm	25 mm		20 sec.
100590	Pkg. 1	11	12	4.5	M10-1.25	103 mm	36 mm	159 mm	7 sec.
100592	Pkg. 1	11	12	8.6	M10-1	53 mm	24 mm	98.5 mm	10 sec.
100593	Pkg. 1	11	12	4.6	M8-1	75 mm	27.5 mm	119 mm	9 sec.
100594	Pkg. 1	11	12	6	M10-1	77 mm	30.5 mm	134 mm	10 sec.
100595	Pkg. 1	11	12	6	10-1	60 mm	29.5 mm	111.5 mm	10 sec.
100614	Pkg. 1	10.5	12	10	M10-1	33.5 mm	27 mm	81.5 mm	2-8 sec.
100616	Pkg. 1	11	12	10	M10-1	77 mm	31 mm	129.5 mm	8 sec.
100619	Pkg. 1	11	12	10	M10-1.25	45.5 mm	22 mm	82.9 mm	8 sec.
100622	Pkg. 1	11	12	10	M8-1	80 mm	24.5 mm	125.9 mm	4.5 sec.
100624	Pkg. 1	5	12	8.5	M10-1	46 mm	29 mm	97 mm	4 sec.
100625	Pkg. 1	4.4	12	8.5	M8-1	70 mm	29.5 mm	116.5 mm	4 sec.
100627	Pkg. 1	11	12	10	M8-1	70 mm	27.5 mm	118.9 mm	4.5 sec.
100634	Pkg. 1	11	12	7	M10-1.25	45 mm	22 mm	85 mm	20 sec.
100636	Pkg. 1	10.5	12	9.7	M10-1.25	76.5 mm	24.3 mm		9 sec.
100639	Pkg. 1	11	12	10	M12-1.25	30 mm	20 mm	79.5 mm	8 sec.
100640	Pkg. 1	24	24	5	M12-1.25	26 mm	20 mm	61.4 mm	8 sec.
100641	Pkg. 1	5	12	8.5	M10-1	46 mm	32 mm	106 mm	4 sec.
100642	Pkg. 1	11	12	10	M9-1	100 mm	29.5 mm	150.9 mm	4.5 sec.
100644	Pkg. 1	11	12	10	M10-1.25	33.5 mm	24 mm	72.9 mm	8 sec.
100645	Pkg. 1	11	12	10	M10-1	57 mm	24 mm	103 mm	8 sec.
100646	Pkg. 1	11	12	10	M10-1	105 mm	24 mm	151 mm	8 sec.
100650	Pkg. 1	11	12	10	M12-1.25	32 mm	24.5 mm	71.9 mm	8 sec.
100651	Pkg. 1	11	12	10	M10-1.25	100.5 mm	31 mm	148.9 mm	8 sec.
100652	Pkg. 1	4.4	12	8.5	M8-1	100 mm	26.5 mm	147.9 mm	4 sec.
100653	Pkg. 1	11	12	10	M10-1.25	181.5 mm	145 mm	21 mm	8 sec.
100656	Pkg. 1	18	24	10	M12-1.25	32 mm	24 mm	71.4 mm	40 sec.
100657	Pkg. 1	11	12	10	M12-1.25	96 mm	24 mm	135.4 mm	8 sec.

HC-CARGO	Std pkg	Voltage/ glow plug	Voltage/ battery	Ampere	Thread	L1	L2	L3	Glow duration
100658	Pkg. 1	20.5	24	5	M12-1.25	96 mm	24 mm	135.4 mm	10 sec.
100659	Pkg. 1	23	24	5	M10-1	46 mm	29 mm	97 mm	10 sec.
100660	Pkg. 1	4.4	12	8.5	M8-1	42 mm	29 mm	93.9 mm	4 sec.
100661	Pkg. 1	11	12	10	M10-1.25	83 mm	30 mm	134.5 mm	8 sec.
100662	Pkg. 1	11	12	10	M10-1.25	93 mm	24 mm	132.4 mm	8 sec.
100663	Pkg. 1	11	12	10	M8-1	75 mm	27.5 mm	124.1 mm	4.5 sec.
100664	Pkg. 1	11	12	10	M8-1	47.5 mm	27.5 mm	98.4 mm	<4.5 sec.
100665	Pkg. 1	7	12	10	M8-1	85 mm	27.5 mm	135 mm	4 sec.
100666	Pkg. 1	11	12	10	M10-1.25	50 mm	19 mm	84.4 mm	8 sec.
100667	Pkg. 1	11.5	12	10	M10-1	83 mm	26 mm	131 mm	8 sec.
100668	Pkg. 1	11	12	10	M10-1.25	50 mm	17 mm	82.4 mm	8 sec.
100669	Pkg. 1	11	12	10	M12-1.25	26 mm	29 mm	70 mm	8 sec.
100670	Pkg. 1	11	12	10	M10-1.25	47.5 mm	18.5 mm	81.4 mm	8 sec.
100671	Pkg. 1	12	12	10	M12-1.25	26 mm	28.5 mm	84 mm	8 sec.
100673	Pkg. 1	4.4	12	8.5	M10-1	81 mm	27 mm	129.4 mm	4 sec.
100674	Pkg. 1	11	12	10	M10-1	75 mm	27 mm	117.4 mm	8 sec.
100675	Pkg. 1	11	12	10	M10-1	83 mm	25 mm	130 mm	8 sec.
100676	Pkg. 1	7	12	10	M10-1	115.5 mm	25.5 mm	163.4 mm	4 sec.
100678	Pkg. 1	7	12	10	M10-1	81 mm	27 mm	131 mm	4 sec.
100679	Pkg. 1	7	12	10	M10-1	78 mm	28 mm	134 mm	4 sec.
100680	Pkg. 1	7	12	10	M8-1	100. mm	26 mm	147.4 mm	4 sec.
100681	Pkg. 1	7	12	10	M10-1	46 mm	28 mm	95.9 mm	4 sec.
100682	Pkg. 1	7	12	10	M8-1	70 mm	29.5 mm	116.5 mm	4 sec.
100683	Pkg. 1	7	12	10	M8-1	78 mm	25.5 mm	125.9 mm	4 sec.
100684	Pkg. 1	11		10	M10-1	44.5 mm	24 mm	90.5 mm	8 sec.

## GLOW PLUG RELAYS











ITEM ID	Pre-heating time in sec. at +20 °C	Post heating		Temp. Measurement		Characteristic	ITEM ID	Pre-heating time in sec. at +20 °C	Post heating		Temp. Measurement		Characteristic
		W/	W/o	Int.	Ext.				W/	W/o	Int.	Ext.	
160416	< 8		✓	✓			160443	< 9		✓	✓		w/ "defect" warning.
160417	< 13		✓	✓			160445	< 9	✓			✓	w/ "defect" warning.
160418	< 8	✓		✓			160446	< 9	✓			✓	w/ "defect" warning.
160419	< 6	✓		✓			160447	< 9	✓			✓	w/ "defect" warning.
160420	< 8	✓			✓		160448	< 9	✓			✓	w/ "defect" warning.
160421	< 4	✓			✓		160449	< 7	✓		✓		Can replace HC-CARGO 160441 and 160443 in connection w/ change to post heating glow plug.
160422	< 18		✓		✓								
160423	< 14		✓	✓			160451	< 7	✓			✓	
160424	< 8		✓	✓			160453			✓			
160425	< 9		✓	✓			160458	< 12	✓			✓	
160426	< 7	✓		✓			160459			✓			Model UWD.
160431	< 10		✓	✓			160460						For engines w/ electronic diesel control.
160432	< 7	✓		✓			160461			✓			
160434	< 8	✓			✓		160469	< 5	✓		✓		
160436	< 8	✓			✓		160718			✓			
160438	< 10	✓		✓			160719			✓			
160441	< 9		✓	✓		w/ "defect" warning.	160795			✓			
160442	< 9		✓	✓		w/ "defect" warning.							

## FANS & BLOWERS



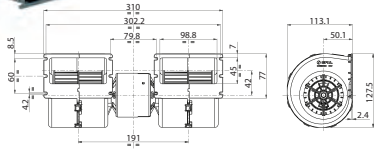

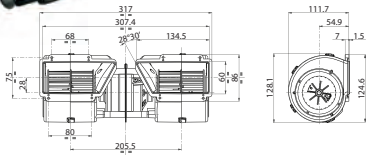



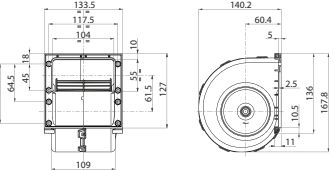

### BLOWERS

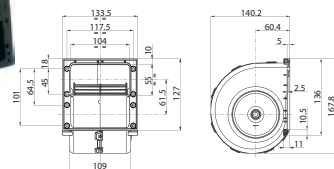
160513 Blower	Std pkg 1	Servicing: Audi, Seat, VW - Visit <a href="http://www.hc-cargo.com">www.hc-cargo.com</a> for further information.		
	Voltage: 12	Dim.: 225x199x162 mm	No./shafts: 1 Fan mounted: Yes	
160515 Blower	Std pkg 1	Servicing: Audi, Seat, Skoda, VW - Visit <a href="http://www.hc-cargo.com">www.hc-cargo.com</a> for further information.		
	Voltage: 12	Dim.: 189x178x155 mm	No./shafts: 1 Fan mounted: Yes	
160518 Blower	Std pkg 1	Servicing: Citroen, Peugeot - Visit <a href="http://www.hc-cargo.com">www.hc-cargo.com</a> for further information.		
	Voltage: 12	Dim.: 230x190x230 mm	No./shafts: 1 Fan mounted: Yes	
160520 Blower	Std pkg 1	Servicing: Audi, VW - Visit <a href="http://www.hc-cargo.com">www.hc-cargo.com</a> for further information.		
	Voltage: 12	Dim.: 210x175x170 mm	No./shafts: 1 Fan mounted: Yes	
160550 Blower	Std pkg 1	Servicing: Ford - Visit <a href="http://www.hc-cargo.com">www.hc-cargo.com</a> for further information.		
	Voltage: 12	Dim.: 171x156x146 mm	No./shafts: 1 Fan mounted: Yes	
160591 Blower	Std pkg 1	Servicing: VW - Visit <a href="http://www.hc-cargo.com">www.hc-cargo.com</a> for further information.		
	Voltage: 12	Dim.: 170x170x148 mm	No./shafts: 1 Fan mounted: Yes	
160620 Blower	Std pkg 1	Servicing: Audi, VW - Visit <a href="http://www.hc-cargo.com">www.hc-cargo.com</a> for further information.		
<i>RHD.</i> 	Voltage: 12		No./shafts: 1 Fan mounted: Yes	

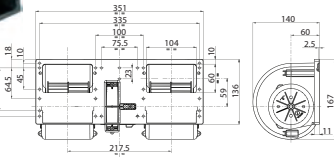
EL. SPECIFICATIONS		DIMENSIONS		ADDITIONAL SPECIFICATIONS
<b>160621</b> Blower	Std pkg 1	Servicing: Audi, VW - Visit <a href="http://www.hc-cargo.com">www.hc-cargo.com</a> for further information.		
		Voltage: 12		No./shafts: 1 Fan mounted: Yes
<b>160631</b> Blower	Std pkg 1	Servicing: Mercedes - Visit <a href="http://www.hc-cargo.com">www.hc-cargo.com</a> for further information.		
		Voltage: 12	Dim.: 200x190x150 mm	No./shafts: 1 Fan mounted: Yes
<b>160710</b> Blower	Std pkg 1	Servicing: Audi, Audi - Visit <a href="http://www.hc-cargo.com">www.hc-cargo.com</a> for further information.		
		Voltage: 12	Dim.: 193x147.5x147.5 mm	No./shafts: 1 Fan mounted: Yes
<b>160767</b> Blower	Std pkg 1	Servicing: Toyota Carina E, Avensis - Visit <a href="http://www.hc-cargo.com">www.hc-cargo.com</a> for further information.		
		Voltage: 12		Type: Blower No./shafts: 1 Fan mounted: No
<b>160879</b> Blower	Std pkg 1	Servicing: GM, Opel, Saab - Visit <a href="http://www.hc-cargo.com">www.hc-cargo.com</a> for further information.		
		Voltage: 12		No./shafts: 1 Fan mounted: Yes
<b>CENTRIFUGAL TYPE</b>				
<b>160483</b> Centrifugal Blower	Std pkg 1	Servicing: HC-CARGO 060216		
		Voltage: 12 Amp: 15	Dim.: 113.1x127.5 mm Shaft dia.: 50.1 mm Length: 310 mm Capacity: 750 m <sup>3</sup> Pressure: 0 PSI Speed: 3-speed	No./shafts: 2 Fan mounted: Yes
				
<b>160510</b> Centrifugal Blower	Std pkg 1	Servicing: New Holland tractors - Visit <a href="http://www.hc-cargo.com">www.hc-cargo.com</a> for further information.		
		Voltage: 12 Amp: 14	Dim.: 111.7x124.6 mm Shaft dia.: 54.9 mm Length: 317 mm Capacity: 650 m <sup>3</sup> Pressure: 0 PSI Speed: 3-speed	No./shafts: 2 Fan mounted: Yes
				

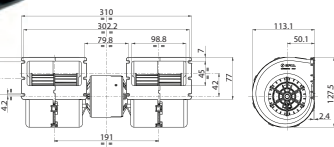
160511 Centrifugal Blower		Std pkg 1	Servicing: Deutz, New Holland - Visit <a href="http://www.hc-cargo.com">www.hc-cargo.com</a> for further information.	
<i>This model have to be used w/ a static pressure that is higher than 0.1 psi. (pressure cabins).</i>				
	<p>Voltage: 12 Amp: 34</p>	<p>Dim.: 139.8x167.5 mm Shaft dia.: 60 mm Length: 351 mm Capacity: 840 m<sup>3</sup> Pressure: 0 PSI Speed: 1-speed</p>	<p>No./shafts: 2 Fan mounted: Yes</p>	
160512 Centrifugal Blower		Std pkg 1		
	<p>Voltage: 24 Amp: 15.9</p>	<p>Dim.: 139.8x167.5 mm Shaft dia.: 60 mm Length: 351 mm Capacity: 1160 m<sup>3</sup> Pressure: 0 PSI Speed: 3-speed</p>	<p>No./shafts: 2 Fan mounted: Yes</p>	
160556 Centrifugal Blower		Std pkg 1		
	<p>Voltage: 24 Amp: 8.1</p>	<p>Dim.: 139.8x167.5 mm Shaft dia.: 60 mm Length: 351 mm Capacity: 850 m<sup>3</sup> Pressure: 0 PSI Speed: 3-speed</p>	<p>No./shafts: 2 Fan mounted: Yes</p>	
160557 Centrifugal Blower		Std pkg 1		
	<p>Voltage: 24 Amp: 12</p>	<p>Dim.: 139.8x167.5 mm Shaft dia.: 60 mm Length: 351 mm Capacity: 1050 m<sup>3</sup> Pressure: 0 PSI Speed: 3-speed</p>	<p>No./shafts: 2 Fan mounted: Yes</p>	
160592 Centrifugal Blower		Std pkg 1		
	<p>Voltage: 12 Amp: 19.6</p>	<p>Dim.: 146x163.9 mm Shaft dia.: 65 mm Length: 139 mm Capacity: 540 m<sup>3</sup> Pressure: 0 PSI Speed: 3-speed</p>	<p>No./shafts: 1 Fan mounted: Yes</p>	
160593 Centrifugal Blower		Std pkg 1		
	<p>Voltage: 12 Amp: 5</p>	<p>Dim.: 113.5x127.5 mm Shaft dia.: 50.1 mm Length: 119 mm Capacity: 260 m<sup>3</sup> Pressure: 0 PSI Speed: 3-speed</p>	<p>No./shafts: 1 Fan mounted: Yes</p>	
160594 Centrifugal Blower		Std pkg 1		
	<p>Voltage: 24 Amp: 11</p>	<p>Dim.: 146x163.9 mm Shaft dia.: 65 mm Length: 335 mm Capacity: 1050 m<sup>3</sup> Pressure: 0 PSI Speed: 3-speed</p>	<p>No./shafts: 2 Fan mounted: Yes</p>	

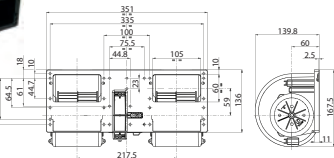

		EL. SPECIFICATIONS	DIMENSIONS	ADDITIONAL SPECIFICATIONS
<b>160596</b> Centrifugal Blower	Std pkg 1	Voltage: 24 Amp: 11.1	Dim.: 140.2x167.8 mm Shaft dia.: 60.4 mm Length: 133.5 mm Capacity: 530 m <sup>3</sup> Pressure: 0 PSI Speed: 3-speed	No./shafts: 2 Fan mounted: Yes
				
<b>160639</b> Centrifugal Blower	Std pkg 1	Voltage: 12 Amp: 19.9	Dim.: 140.2x167.8 mm Shaft dia.: 60.4 mm Length: 133.5 mm Capacity: 510 m <sup>3</sup> Pressure: 0 PSI Speed: 3-speed	No./shafts: 1 Fan mounted: Yes
				
<b>160647</b> Centrifugal Blower	Std pkg 1	Voltage: 12 Amp: 17.2	Dim.: 140x167 mm Shaft dia.: 60 mm Length: 351 mm Capacity: 910 m <sup>3</sup> Speed: 3-speed	No./shafts: 2 Fan mounted: Yes
				
<b>160649</b> Centrifugal Blower	Std pkg 1	Servicing: HC-CARGO 060220 Voltage: 24 Amp: 8.2	Dim.: 113.1x127.5 mm Shaft dia.: 50.1 mm Length: 310 mm Capacity: 750 m <sup>3</sup> Pressure: 0 PSI Speed: 3-speed	No./shafts: 2 Fan mounted: Yes
				
<b>160878</b> Centrifugal Blower	Std pkg 1	Servicing: Volvo - Visit <a href="http://www.hc-cargo.com">www.hc-cargo.com</a> for further information. Voltage: 24 Amp: 12	Dim.: 139.8x167.5 mm Shaft dia.: 60 mm Length: 351 mm Capacity: 1050 m <sup>3</sup> Pressure: 0 PSI Speed: 4-speed	No./shafts: 2 Fan mounted: Yes
				
<b>BLOWER RESISTORS</b>				
<b>160549</b> Resistor	Std pkg 1	Servicing: Opel, Vauxhall - Visit <a href="http://www.hc-cargo.com">www.hc-cargo.com</a> for further information.		Connection: 5+2 Type: 4-speed
				
<b>160565</b> Resistor	Std pkg 1	Servicing: Citroën, Peugeot - Visit <a href="http://www.hc-cargo.com">www.hc-cargo.com</a> for further information.		Connection: 4+1+1
				

		EL. SPECIFICATIONS	DIMENSIONS	ADDITIONAL SPECIFICATIONS
<b>160762</b> Resistor		Std pkg 1	Servicing: VW - Visit <a href="http://www.hc-cargo.com">www.hc-cargo.com</a> for further information.	
				Connection: 4
<b>160765</b> Resistor		Std pkg 1	Servicing: BMW - Visit <a href="http://www.hc-cargo.com">www.hc-cargo.com</a> for further information.	
				Connection: 5
<b>160794</b> Blower Resistor		Std pkg 1	Servicing: Mercedes-Benz - Visit <a href="http://www.hc-cargo.com">www.hc-cargo.com</a> for further information.	
				Connection: 4
<b>FAN/HEATER MOTORS</b>				
<b>SINGLE SHAFTS</b>				
<b>160005</b> Universal Motor		Std pkg 1		
		Voltage: 12 Watt: 40	Dia.: 60 mm Shaft dia.: 8x22 mm Length: 121 mm Revolutions/min.: 2000 Speed: 1-speed	No./shafts: 1 Fan mounted: No
<b>160006</b> Universal Motor		Std pkg 1		
		Voltage: 24 Watt: 40	Dia.: 60 mm Shaft dia.: 8x22 mm Length: 121 mm Revolutions/min.: 2000 Speed: 1-speed	No./shafts: 1 Fan mounted: No
<b>160674</b> Universal Motor		Std pkg 1		
		Voltage: 12	Dim.: 58x107 mm Dia.: 51 mm Shaft dia.: 6 mm Length: 107 mm	No./shafts: 1 Fan mounted: No
<b>160734</b> Universal motor		Std pkg 1	Servicing: Volvo - Visit <a href="http://www.hc-cargo.com">www.hc-cargo.com</a> for further information.	
		Voltage: 12	Dia.: 73 mm Shaft dia.: 8 mm Length: 144 mm	No./shafts: 1 Fan mounted: No

**DOUBLE SHAFTS**
**160250 Universal Motor** Std pkg 1

*Universal.*

Voltage: 12

 Dia.: 90 mm  
 Shaft dia.: 10x110 mm  
 Length: 105 mm  
 Revolutions/min.: 3200  
 Speed: 3-speed

 No./shafts: 2  
 Fan mounted: No

**160251 Universal Motor** Std pkg 1

*Universal.*

Voltage: 24

 Dia.: 90 mm  
 Shaft dia.: 7.95x79 mm  
 Length: 107 mm  
 Revolutions/min.: 2600  
 Speed: 3-speed

 No./shafts: 2  
 Fan mounted: No

**160252 Universal Motor** Std pkg 1

*Universal.*

Voltage: 24

 Dia.: 82 mm  
 Shaft dia.: 7.2x58 mm  
 Length: 248 mm  
 Revolutions/min.: 2500  
 Speed: 1-speed

 No./shafts: 2  
 Fan mounted: No

**160253 Universal Motor** Std pkg 1

*Universal.*

Voltage: 12

 Dia.: 77.5 mm  
 Shaft dia.: 7x68.5 mm  
 Length: 254 mm  
 Revolutions/min.: 3300  
 Speed: 3-speed

 No./shafts: 2  
 Fan mounted: No

**160622 DC Motor** Std pkg 1 Servicing: Massey Ferguson 3070 - Visit [www.hc-cargo.com](http://www.hc-cargo.com) for further information.

*Universal.*

Voltage: 12

 Dia.: 73 mm  
 Shaft dia.: 8x51 mm  
 Length: 223 mm  
 Revolutions/min.: 3100

 Type: Blower  
 No./shafts: 2  
 Fan mounted: No

**160626 DC Motor** Std pkg 1 Servicing: Fiat tractors - Visit [www.hc-cargo.com](http://www.hc-cargo.com) for further information.

*Universal.*

Voltage: 12

 Dia.: 59.5 mm  
 Shaft dia.: 8 mm  
 Length: 198 mm  
 Revolutions/min.: 4000

 No./shafts: 2  
 Fan mounted: No

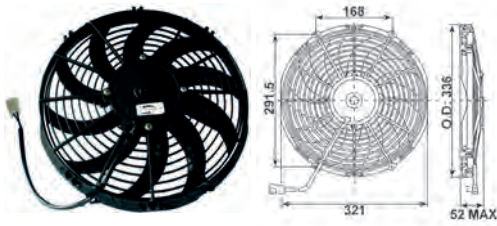
**AXIAL FANS**
**12 V**
**160536 Axial Fan** Std pkg 1

 Voltage: 12  
Amp: 6.2

 OD: 336 mm  
Capacity: 1590 m<sup>3</sup>

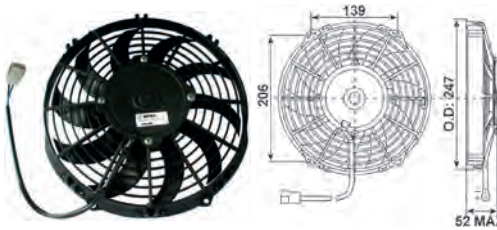
 Type: Blower  
Fan mounted: Yes  
Tightness norm: IP 68  
Alternativ no.: 161003

**160537 Axial Fan** Std pkg 1

 Voltage: 12  
Amp: 6.7

 OD: 247 mm  
Capacity: 1060 m<sup>3</sup>

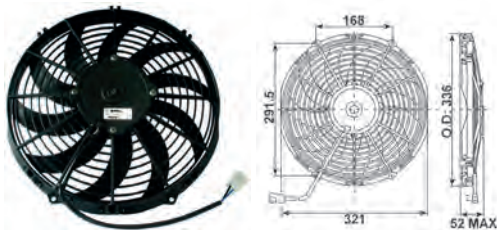
 Type: Suction  
Fan mounted: Yes  
Tightness norm: IP 68

**160538 Axial Fan** Std pkg 1

 Voltage: 12  
Amp: 6.7

 OD: 336 mm  
Capacity: 1540 m<sup>3</sup>

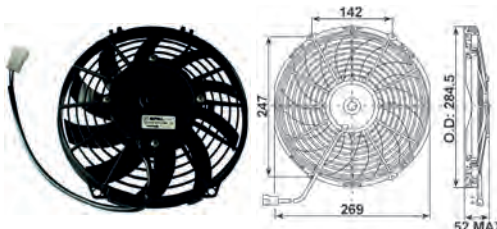
 Type: Suction  
Fan mounted: Yes  
Tightness norm: IP 68  
Alternativ no.: 161002

**160539 Axial Fan** Std pkg 1

 Voltage: 12  
Amp: 8.7

 OD: 284.5 mm  
Capacity: 1360 m<sup>3</sup>

 Type: Suction  
Fan mounted: Yes  
Tightness norm: IP 68  
Alternativ no.: 161000

**160598 Axial Fan** Std pkg 1

 Voltage: 12  
Amp: 7.8

 OD: 310 mm  
Capacity: 1390 m<sup>3</sup>









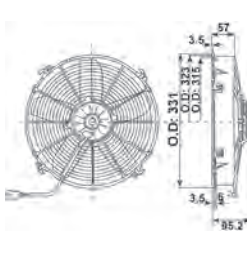

 Type: Suction  
Fan mounted: Yes  
Tightness norm: IP 68

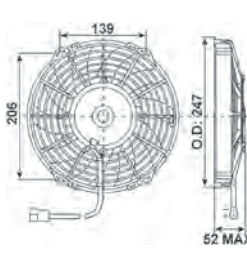
**160601 Axial Fan** Std pkg 1

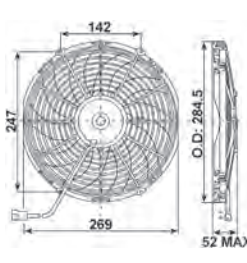

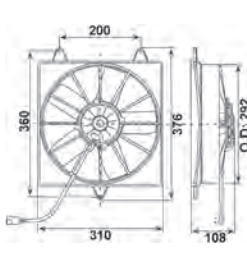

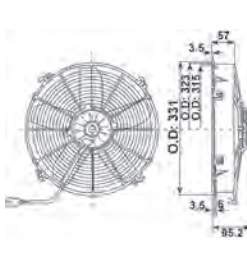

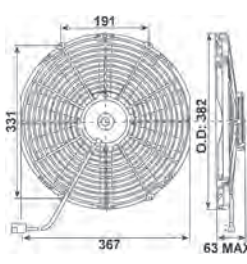

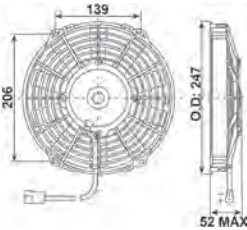

 Voltage: 12  
Amp: 7.7

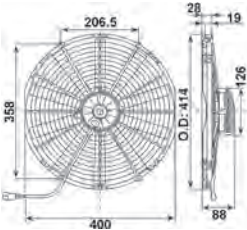
 OD: 310 mm  
Capacity: 1400 m<sup>3</sup>

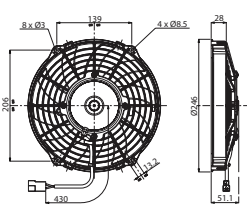
 Type: Blower  
Fan mounted: Yes  
Tightness norm: IP 68

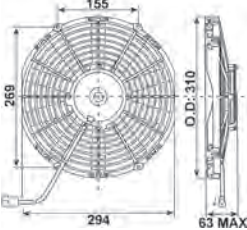
		EL. SPECIFICATIONS	DIMENSIONS	ADDITIONAL SPECIFICATIONS
<b>160739 Axial Fan</b> Std pkg 1		Voltage: 12 Amp: 15.6	OD: 331 mm Capacity: 2430 m <sup>3</sup>	Type: Suction Fan mounted: Yes Tightness norm: IP 68
				
<b>160910 Axial Fan</b> Std pkg 1		Voltage: 12 Amp: 7.2	OD: 247 mm Capacity: 1080 m <sup>3</sup>	Type: Blower Fan mounted: Yes Tightness norm: IP 68
				
<b>160911 Axial Fan</b> Std pkg 1		Voltage: 12 Amp: 7.6	OD: 284.5 mm Capacity: 1430 m <sup>3</sup>	Type: Blower Fan mounted: Yes Tightness norm: IP 68
				
<b>160912 Axial Fan</b> Std pkg 1		Voltage: 12 Amp: 11.4	Dim.: 376x310x108 mm OD: 292 mm Capacity: 2280 m <sup>3</sup>	Type: Blower Fan mounted: Yes Tightness norm: IP 68
				
<b>160913 Axial Fan</b> Std pkg 1		Voltage: 12 Amp: 15.3	OD: 331 mm Capacity: 2340 m <sup>3</sup>	Type: Blower Fan mounted: Yes Tightness norm: IP 68
				
<b>160914 Axial Fan</b> Std pkg 1		Voltage: 12 Amp: 9.5	OD: 382 mm Capacity: 2220 m <sup>3</sup>	Type: Suction Fan mounted: Yes Tightness norm: IP 68
				

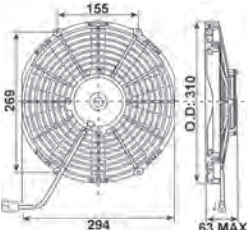
		EL. SPECIFICATIONS	DIMENSIONS	ADDITIONAL SPECIFICATIONS
<b>160915 Axial Fan</b> Std pkg 1		Voltage: 12 Amp: 8.7	OD: 382 mm Capacity: 2140 m <sup>3</sup>	Type: Blower Fan mounted: Yes Tightness norm: IP 68
<b>161000 HC-CARGO Axial Fan</b> Std pkg 1		Voltage: 12 Amp: 9	OD: 284.6 mm Capacity: 1506 m <sup>3</sup>	Type: Suction Tightness norm: IP 68 Alternativ no.: 160539
<b>161002 HC-CARGO Axial Fan</b> Std pkg 1		Voltage: 12 Amp: 7.5	OD: 335.6 mm Capacity: 1733 m <sup>3</sup>	Type: Suction Tightness norm: IP 68 Alternativ no.: 160538
<b>161003 HC-CARGO Axial Fan</b> Std pkg 1		Voltage: 12 Amp: 7.5	OD: 335.6 mm Capacity: 1733 m <sup>3</sup>	Type: Blower Tightness norm: IP 68 Alternativ no.: 160536
<b>24 V</b>				
<b>160584 Axial Fan</b> Std pkg 1		Voltage: 24 Amp: 7.4	OD: 331 mm Capacity: 2900 m <sup>3</sup>	Type: Suction Fan mounted: Yes Tightness norm: IP 68 Alternativ no.: 161004
<b>160587 Axial Fan</b> Std pkg 1		Voltage: 24 Amp: 3.9	OD: 384.5 mm Capacity: 1300 m <sup>3</sup>	Type: Suction Tightness norm: IP 68 Alternativ no.: 161001

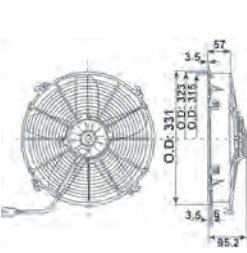
		EL. SPECIFICATIONS	DIMENSIONS	ADDITIONAL SPECIFICATIONS
160588 Axial Fan		Std pkg 1		
		Voltage: 24 Amp: 4.1	OD: 247 mm Capacity: 1080 m <sup>3</sup>	Type: Blower Fan mounted: Yes Tightness norm: IP 68
160595 Axial Fan		Std pkg 1		
		Voltage: 24 Amp: 8.7	OD: 414 mm Capacity: 3540 m <sup>3</sup>	Type: Blower Tightness norm: IP 68
160597 Axial Fan		Std pkg 1		
		Voltage: 24 Amp: 3.9	OD: 247 mm Capacity: 1180 m <sup>3</sup>	Type: Blower Fan mounted: Yes Tightness norm: IP 68
160599 Axial Fan		Std pkg 1		
		Voltage: 24 Amp: 4.4	OD: 310 mm Capacity: 1690 m <sup>3</sup>	Type: Suction Fan mounted: Yes Tightness norm: IP 68
160600 Axial Fan		Std pkg 1		
		Voltage: 24 Amp: 4.1	OD: 310 mm Capacity: 1570 m <sup>3</sup>	Type: Blower Tightness norm: IP 68
160619 Axial Fan		Std pkg 1		
		Voltage: 24 Amp: 7.8	OD: 310 mm Capacity: 2440 m <sup>3</sup>	Type: Blower Fan mounted: Yes Tightness norm: IP 68

		EL. SPECIFICATIONS	DIMENSIONS	ADDITIONAL SPECIFICATIONS
<b>160714 Axial Fan</b> Std pkg 1		Voltage: 24 Amp: 3.7	OD: 284.5 mm Capacity: 1400 m <sup>3</sup>	Type: Blower Tightness norm: IP 68
<b>160737 Axial Fan</b> Std pkg 1		Voltage: 24 Amp: 6	OD: 336 mm Capacity: 2240 m <sup>3</sup>	Type: Blower Fan mounted: Yes Tightness norm: IP 68
<b>160777 Axial Fan</b> Std pkg 1		Voltage: 24 Amp: 8.4	OD: 414 mm Capacity: 3315 m <sup>3</sup>	Type: Suction Tightness norm: IP 68
<b>160799 Axial Fan</b> Std pkg 1		Voltage: 24 Amp: 4	OD: 347 mm Capacity: 1170 m <sup>3</sup>	Type: Suction Fan mounted: Yes Tightness norm: IP 68
<b>160906 Axial Fan</b> Std pkg 1		Voltage: 24 Amp: 3.7	OD: 247 mm Capacity: 1070 m <sup>3</sup>	Type: Suction Fan mounted: Yes Tightness norm: IP 68
<b>160907 Axial Fan</b> Std pkg 1		Voltage: 24 Amp: 5.7	OD: 278 mm Capacity: 1990 m <sup>3</sup>	Type: Suction Fan mounted: Yes Tightness norm: IP 68



		EL. SPECIFICATIONS	DIMENSIONS	ADDITIONAL SPECIFICATIONS
<b>160908 Axial Fan</b> Std pkg 1		Voltage: 24 Amp: 7.1	OD: 331 mm Capacity: 2760 m <sup>3</sup>	Type: Blower Fan mounted: Yes Tightness norm: IP 68
<b>160909 Axial Fan</b> Std pkg 1		Voltage: 24 Amp: 4.9	OD: 382 mm Capacity: 2170 m <sup>3</sup>	Type: Suction Fan mounted: Yes Tightness norm: IP 68
<b>160998 HC-CARGO Axial Fan</b> Std pkg 1		Voltage: 24 Amp: 2.5	OD: 210.8 mm Capacity: 645 m <sup>3</sup>	Type: Suction Tightness norm: IP 68
<b>160999 HC-CARGO Axial Fan</b> Std pkg 1		Voltage: 24 Amp: 2.5	OD: 210.8 mm Capacity: 645 m <sup>3</sup>	Type: Blower Tightness norm: IP 68
<b>161001 HC-CARGO Axial Fan</b> Std pkg 1		Voltage: 24 Amp: 4	OD: 284.6 mm Capacity: 1437 m <sup>3</sup>	Type: Suction Tightness norm: IP 68 Alternativ no.: 160587
<b>161004 HC-CARGO Axial Fan</b> Std pkg 1		Voltage: 24 Amp: 9	OD: 330.6 mm Capacity: 2976 m <sup>3</sup>	Type: Suction Tightness norm: IP 68 Alternativ no.: 160584 æ

**ACCESSORIES**
**160966** Mounting kit Std pkg 1

Total length: 180 mm

Washer: w/

**CABIN HEATERS**
**060216** Cabin Heater Std pkg 1

The heater has three 75 mm tube connections on the air inlet side. There are also three 75 mm tube connections on the outlet side. The water connections can be placed on either side of the heater and also be turned towards either the inlet or the outlet side. C

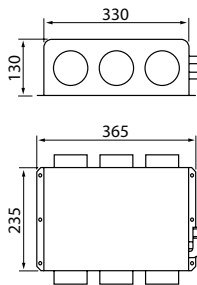

 Voltage: 12  
 Watt/speed 1: 60  
 Watt/speed 2: 77  
 Watt/speed 3: 114

 Dim.: 330x230x130 mm  
 Water connection OD: 16 mm  
 Weight: 6.3 kg  
 Capacity kW/speed 1: 7.2  
 Airflow speed 1: 264 m<sup>3</sup>/h  
 Capacity kW/speed 2: 9.3  
 Airflow speed 2: 357 m<sup>3</sup>/h  
 Capacity kW/speed 3: 12.2  
 Airflow speed 3: 504 m<sup>3</sup>/h  
 Regulation: Yes

 Type: Complete kit  
 Cabinet: Stainless steel

**060220** Cabin Heater Std pkg 1

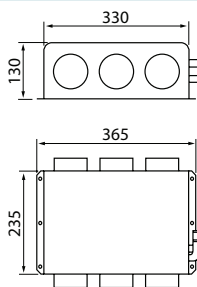
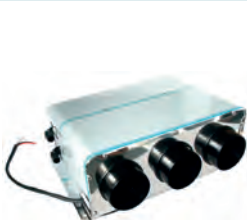
The heater has three 75 mm tube connections on the air inlet side. There are also three 75 mm tube connections on the outlet side. The water connections can be placed on either side of the heater and also be turned towards either the inlet or the outlet side. Centrifugal Blower: HC-CARGO 160649.



 Voltage: 24  
 Watt/speed 1: 60  
 Watt/speed 2: 77  
 Watt/speed 3: 114

 Dim.: 330x230x130 mm  
 Water connection OD: 16 mm  
 Weight: 6.3 kg  
 Capacity kW/speed 1: 7.2  
 Airflow speed 1: 264 m<sup>3</sup>/h  
 Capacity kW/speed 2: 9.2  
 Airflow speed 2: 357 m<sup>3</sup>/h  
 Capacity kW/speed 3: 12.2  
 Airflow speed 3: 504 m<sup>3</sup>/h  
 Regulation: Yes

 Type: Complete kit  
 Cabinet: Stainless steel

**060222** Cabin Heater Std pkg 1

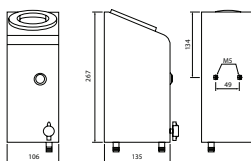
This Cabin heater is easily installed in small off road vehicles or as auxiliary heater in buses and delivery vans. The heating cycle is controlled by means of the built-in 1/4-turn water valve and the built-in switch. Heat-On 1331-12.



 Voltage: 12  
 Watt/speed 1: 24

 Dim.: 267x106x135 mm  
 Water connection OD: 12 mm  
 Weight: 3 kg  
 Capacity kW/speed 1: 1.9  
 Airflow speed 1: 76 m<sup>3</sup>/h  
 Regulation: No

 Type: Complete kit  
 Cabinet: Metal

**060223** Cabin Heater Std pkg 1

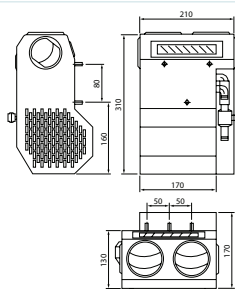
This very powerful cabin heater is used for airrecirculation and has all connections behind a cover allowing hoses and cables to be led in any direction. It has a powerful fan (230 W), controlled by means of a built-in 1/4-turn water valve. Efficient distribution of the air through the adjustable air vents provides for demisting of the cabin screens w/o the use of extra tubes and nozzles.



 Voltage: 12  
 Watt/speed 3: 230

 Dim.: 310x210x130 mm  
 Water connection OD: 16 mm  
 Weight: 5.8 kg  
 Capacity kW/speed 1: 4.3  
 Airflow speed 1: 180 m<sup>3</sup>/h  
 Capacity kW/speed 2: 6.3  
 Airflow speed 2: 288 m<sup>3</sup>/h  
 Capacity kW/speed 3: 9.2  
 Airflow speed 3: 468 m<sup>3</sup>/h  
 Regulation: Yes

 Type: Complete kit  
 Cabinet: Galvanized steel w/  
 black polyester

**060233 Cabin Heater**

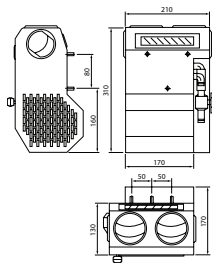
Std pkg 1



Voltage: 24  
Watt/speed 3: 230

Dim.: 310x210x130 mm  
Water connection OD: 16 mm  
Weight: 5.8 kg  
Capacity kW/speed 1: 4.3  
Airflow speed 1: 180 m<sup>3</sup>/h  
Capacity kW/speed 2: 6.3  
Airflow speed 2: 288 m<sup>3</sup>/h  
Capacity kW/speed 3: 9.2  
Airflow speed 3: 468 m<sup>3</sup>/h  
Regulation: Yes

Type: Complete kit  
Cabinet: Galvanized steel w/  
black polyester

**060235 Cabin Heater**

Std pkg 1

*Especially suitable for heating the passenger room in for instance buses.*

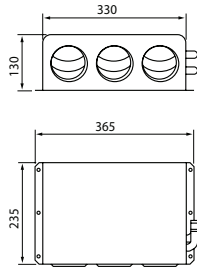

Voltage: 24  
Watt/speed 1: 60  
Watt/speed 2: 77  
Watt/speed 3: 114

Dim.: 365x235x130 mm  
Water connection OD: 16 mm  
Weight: 6.3 kg  
Capacity kW/speed 1: 7.2  
Airflow speed 1: 264 m<sup>3</sup>/h  
Capacity kW/speed 2: 9.3  
Airflow speed 2: 357 m<sup>3</sup>/h  
Capacity kW/speed 3: 12.2  
Airflow speed 3: 504 m<sup>3</sup>/h  
Regulation: Yes

Type: Complete kit  
Cabinet: Metal

**060241 Cabin Heater**

Std pkg 1

Service: Delivery vans, excavators, park tractors - Visit [www.hc-cargo.com](http://www.hc-cargo.com) for further information.

*Radiator: copper/aluminium.*

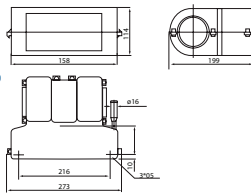

Voltage: 12  
Watt/speed 2: 75

Dim.: 273x199x114 mm  
Water connection OD: 16 mm  
Weight: 1.7 kg  
Capacity kW/speed 2: 4.3  
Airflow speed 2: 230 m<sup>3</sup>/h  
Regulation: Yes

Type: Complete kit  
Cabinet: Shockproof plastic

**HEATER MOTORS**

**060213 Cabin Heater Motor**

Std pkg 1

*Heat-on 1531 M-5012.*



Voltage: 12  
Watt: 50

Dia.: 70 mm  
Shaft dia.: 6.35x16 mm  
Length: 63 mm  
Speed: 2-speed

Mount.: 3 holes  
No./shafts: 1

**060214 Cabin Heater Motor**

Std pkg 1

*Heat-on 1531 M-5024.*



Voltage: 24  
Watt: 50

Dia.: 70 mm  
Shaft dia.: 6.35x16 mm  
Length: 63 mm  
Speed: 1-speed

Mount.: 3 holes  
No./shafts: 1

**CONNECTORS**

**060229 Round Air Vent**

Std pkg 1

*Heat-on 66231.*



ID: 70/76 mm  
OD: 101 mm

**ACCESSORIES**
**060058** Defroster Set Std pkg 1
*Heat-on 1518.*

 ID/demister tube connection: 45 mm  
 ID/demister tube: 40 mm  
 Demister tube length: 160 cm

 Rubber elbows: 2  
 Demister nozzles: 2

**060215** Fan Std pkg 1
*Heat-on 1531-10.*

OD: 120 mm

**060219** Air Distribution Kit Std pkg 1 Servicing: HC-CARGO 060216, 060220
*Heat-on 3050-30.*

 ID/demister tube: 75 mm  
 Demister tube length: 620 cm

Demister nozzles: 3

**060227** Water Valve Std pkg 1
*Heat-on 2100.*

 ID/demister tube connection: 16 mm  
 Demister tube length: 11.2 cm

**060237** Demister Tube Std pkg 1

ID/demister tube: 50 mm

**WIPER SYSTEMS**
**WIPER BLADES**
**FOR PASSENGER CARS**
**FLEXFIT**

	HC-CARGO	Std pkg	Length		Type
	161061	Pkg. 1	350 mm	14"	For curved glass
	HC-CARGO	Std pkg	Length		Type
	161062	Pkg. 1	380 mm	15"	For curved glass

	HC-CARGO	Std pkg	Length		Type
	161063	Pkg. 1	400 mm	16"	For curved glass
	161064	Pkg. 1	450 mm	18"	For curved glass
	161065	Pkg. 1	470 mm	19"	For curved glass
	161066	Pkg. 1	500 mm	20"	For curved glass
	161067	Pkg. 1	530 mm	21"	For curved glass
	161068	Pkg. 1	550 mm	22"	For curved glass
	161069	Pkg. 1	600 mm	24"	For curved glass
	161070	Pkg. 1	650 mm	26"	For curved glass
	161071	Pkg. 1	700 mm	28"	For curved glass

### STANDARD TYPE

160586 Wiper Blade Display w/o CARGO SIGN Pkg. 1 Passenger cars

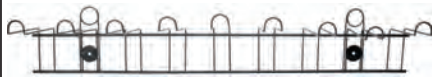

	HC-CARGO	Std pkg	Length		Type
	160628	Pkg. 1	280 mm	11"	
	160633	Pkg. 1	330 mm	13"	
	160635	Pkg. 1	350 mm	14"	
	160638	Pkg. 1	380 mm	15"	
	160641	Pkg. 1	410 mm	16"	
	160643	Pkg. 1	430 mm	17"	
	160645	Pkg. 1	450 mm	18"	
	160648	Pkg. 1	480 mm	19"	
	160650	Pkg. 1	500 mm	20"	
	160653	Pkg. 1	530 mm	21"	
	160655	Pkg. 1	550 mm	22"	
	161580	Pkg. 15	580 mm	23"	For curved glass
	160661	Pkg. 1	610 mm	24"	

### SPOILER

	HC-CARGO	Std pkg	Length		Type
	160741	Pkg. 1	400 mm	16"	
	160745	Pkg. 1	450 mm	18"	
	160748	Pkg. 1	480 mm	19"	
	160750	Pkg. 1	510 mm	20"	
	160753	Pkg. 1	530 mm	22"	
	160755	Pkg. 1	550 mm	22"	
	160761	Pkg. 1	610 mm	24"	
	160766	Pkg. 1	660 mm	26"	
	160771	Pkg. 1	710 mm	28"	

### FOR TRUCKS

	HC-CARGO	Std pkg	Length		Type
	160321	Pkg. 1	400 mm	16"	
	160322	Pkg. 1	450 mm	18"	
	160323	Pkg. 1	500 mm	20"	
	160325	Pkg. 1	600 mm	24"	
	160326	Pkg. 1	600 mm	24"	
	160327	Pkg. 1	650 mm	26"	For curved glass
	160370	Pkg. 1	650 mm	26"	
	160328	Pkg. 1	700 mm	28"	
	160411	Pkg. 1	700 mm	28"	
	160329	Pkg. 1	800 mm	32"	
	160757	Pkg. 1	900 mm	36"	
	161013	Pkg. 1	900 mm	36"	
	160330	Pkg. 1	1000 mm	40"	

### INDUSTRIAL

	HC-CARGO	Std pkg	Length		Type
	160019	Pkg. 1	300 mm	12"	For flat glass
	160028	Pkg. 1	330 mm	13"	For flat glass
	160035	Pkg. 1	350 mm	14"	For flat glass
	160025	Pkg. 1	360 mm	14"	For flat glass
	160026	Pkg. 1	400 mm	16"	For flat glass

**MOUNTING PARTS**
**160758** Adapter Kit Std pkg 1 Servicing: HC-CARGO 160325

Used on: Trucks

**WIPER ARMS**
**160022** Wiper Arm Std pkg 1

**Dim./wiper arm:**  
8x2 mm  
**Length:** 390 mm  
**Mount./wiper shaft:**  
6 mm

**Type:** Single

**160023** Wiper Arm Std pkg 1 Servicing: Opel - Visit [www.hc-cargo.com](http://www.hc-cargo.com) for further information.

**Dim./wiper arm:**  
8x2 mm  
**Length:** 420 mm  
**Mount./wiper shaft:**  
6 mm

**Type:** Single

**160024** Wiper Arm Std pkg 1 Servicing: Opel - Visit [www.hc-cargo.com](http://www.hc-cargo.com) for further information.

**Dim./wiper arm:**  
8x2.5 mm  
**Length:** 450 mm  
**Mount./wiper shaft:**  
6 mm

**Type:** Single

**160256** Wiper Arm Std pkg 1 Servicing: HC-CARGO 160323, 160326, 160321, 160322, 161023

*Wiper motor: HC-CARGO 160258, 160290, 160291, 160357, 160408.*

**Length:** 450 mm  
**Dist./wiper arms:**  
57 mm  
**Mount./wiper shaft:** M6  
cone + M8 shaft mm

**Type:** Parallel  
**Length/adjustable:** No

**160257** Wiper Arm Std pkg 1 Servicing: HC-CARGO 160321, 160322, 161023

*Wiper motor: HC-CARGO 160258, 160290, 160291, 160357, 160408.*







**Length:** 400 mm  
**Dist./wiper arms:**  
57 mm  
**Mount./wiper shaft:** M6  
cone + M8 shaft mm

**Type:** Parallel  
**Length/adjustable:** No

**160338** Wiper Arm Std pkg 1 Servicing: HC-CARGO 160727, 160321, 160322, 160345

**Length:** 700 mm  
**Dist./wiper arms:**  
55 mm  
**Mount./wiper shaft:**  
2x8 cone mm

**Type:** Parallel  
**Length/adjustable:** No

EL. SPECIFICATIONS		DIMENSIONS	ADDITIONAL SPECIFICATIONS
<b>160339 Wiper Arm</b> Std pkg 1 <i>Wiper motor: HC-CARGO 160292, 160293.</i>			
		<b>Length:</b> 400 mm <b>Dist./wiper arms:</b> 57 mm <b>Mount./wiper shaft:</b> 6+M8 shaft mm	<b>Type:</b> Parallel <b>Length/adjustable:</b> No
<b>160358 Wiper Arm</b> Std pkg 1 <b>Servicing:</b> HC-CARGO 160321, 160322, 161023 <i>Wiper motor: HC-CARGO 160258, 160290, 160291, 160357, 160408.</i>			
		<b>Length:</b> 500 mm <b>Dist./wiper arms:</b> 57 mm <b>Mount./wiper shaft:</b> M6 cone + M8 shaft mm	<b>Type:</b> Parallel <b>Length/adjustable:</b> No
<b>160359 Wiper Arm</b> Std pkg 1 <b>Servicing:</b> HC-CARGO 160321, 160322, 161023 <i>Wiper motor: HC-CARGO 160258, 160290, 160291, 160357, 160408.</i>			
		<b>Length:</b> 550 mm <b>Dist./wiper arms:</b> 57 mm <b>Mount./wiper shaft:</b> M6 cone + M8 shaft mm	<b>Type:</b> Parallel <b>Length/adjustable:</b> No
<b>160484 Wiper Arm</b> Std pkg 1 <b>Servicing:</b> HC-CARGO 161023, 160659			
		<b>Length:</b> 340-420 mm <b>Dist./wiper arms:</b> 57 mm <b>Mount./wiper blade:</b> 9x2.5 mm hook <b>Mount./wiper shaft:</b> M8 cone + M8 shaft mm	<b>Type:</b> Parallel <b>Length/adjustable:</b> Yes
<b>160485 Wiper Arm</b> Std pkg 1 <b>Servicing:</b> HC-CARGO 161023, 160659			
		<b>Length:</b> 430-500 mm <b>Dist./wiper arms:</b> 57 mm <b>Mount./wiper blade:</b> 9x2.5 mm hook <b>Mount./wiper shaft:</b> M8 cone + M8 shaft mm	<b>Type:</b> Parallel <b>Length/adjustable:</b> Yes
<b>160486 Wiper Arm</b> Std pkg 1			
		<b>Length:</b> 340-420 mm <b>Mount./wiper blade:</b> 9x3 mm hook <b>Mount./wiper shaft:</b> M8 cone mm	<b>Type:</b> Single <b>Length/adjustable:</b> Yes
<b>160487 Wiper Arm</b> Std pkg 1			
		<b>Length:</b> 430-500 mm <b>Mount./wiper blade:</b> 9x3 mm hook <b>Mount./wiper shaft:</b> M8 cone mm	<b>Type:</b> Single <b>Length/adjustable:</b> Yes

**160571** Wiper Arm

Std pkg 1 Servicing: HC-CARGO 161025

**Length:** 680 mm  
**Dist./wiper arms:**  
 60 mm  
**Mount./wiper shaft:**  
 2x8 cone mm

**Type:** Parallel  
**Length/adjustable:** No

**161021** Wiper Arm

Std pkg 1



## MOUNTING PARTS

**160727** K-Connector

Std pkg 1 Servicing: HC-CARGO 160338

**Used on:** Trucks

## WIPER MOTORS

**160150** Wiper Motor

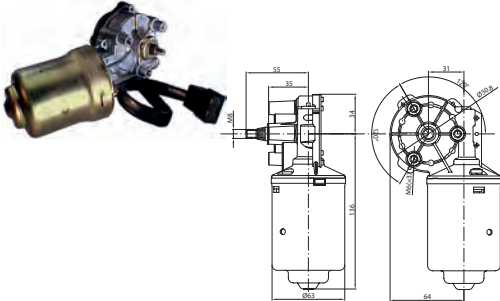
 Std pkg 1 Servicing: Fiat 127, Lada 2101 - Visit [www.hc-cargo.com](http://www.hc-cargo.com) for further information.

**Voltage:** 12

**Type:** OE

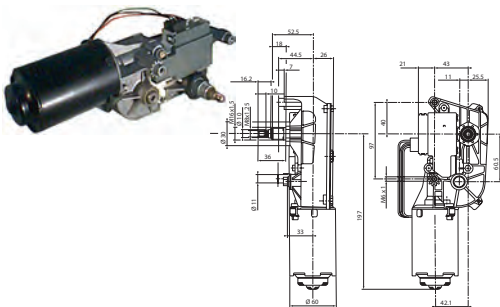
**160376** Wiper Motor

 Std pkg 1 Servicing: Fiat Uno - Visit [www.hc-cargo.com](http://www.hc-cargo.com) for further information.

**Voltage:** 12

**Shaft length:** 10 mm  
**Wiper angle:** 138°

**Type:** OE  
**Position:** Front windscreen  
**Wiper shaft:** w/ 1 Shaft  
**Built in switch:** Yes  
**Auto stop:** Yes

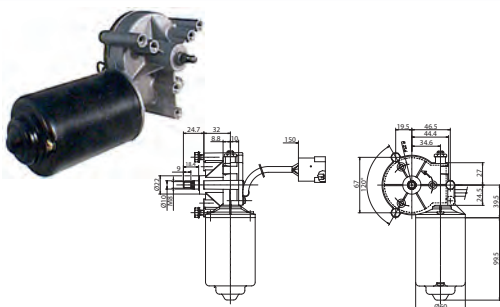
**160395** Wiper Motor

 Std pkg 1 Servicing: Nissan Patrol 86-93 - Visit [www.hc-cargo.com](http://www.hc-cargo.com) for further information.

**Voltage:** 12

**Type:** OE  
**Position:** Rear windscreen  
**Wiper shaft:** w/ 1 M8 Shaft  
**Auto stop:** No



EL. SPECIFICATIONS		DIMENSIONS	ADDITIONAL SPECIFICATIONS
<b>160396 Wiper Motor</b> Std pkg 1 Servicing: Nissan Patrol 86-93 - Visit <a href="http://www.hc-cargo.com">www.hc-cargo.com</a> for further information.		Voltage: 24	Type: OE Position: Rear windscreen Wiper shaft: w/ 1 M6 Shaft Auto stop: No
<b>160671 Wiper Motor</b> Std pkg 1 Servicing: Citroen, Fiat, Peugeot - Visit <a href="http://www.hc-cargo.com">www.hc-cargo.com</a> for further information.		Voltage: 12	Type: OE Position: Front windscreen
<b>160881 Wiper Motor</b> Std pkg 1 Servicing: TEREX/SCHAEFF - Visit <a href="http://www.hc-cargo.com">www.hc-cargo.com</a> for further information.		Voltage: 12	Shaft length: 38 mm
		Type: OE Wiper shaft: w/ 1 Shaft Built in switch: No Auto stop: Yes Auto stop/placement: Left side	
<b>UNIVERSAL</b>			
<b>160031 Wiper Motor</b> Std pkg 1 <i>Fitted w/ an interchangeable bearing allowing the shaft to be cut in any size.</i>		Voltage: 12	Wiper angle: 85°
		Type: Universal Built in switch: Yes Auto stop: No	
<b>160032 Wiper Motor</b> Std pkg 1 <i>Fitted w/ an interchangeable bearing allowing the shaft to be cut in any size.</i>		Voltage: 24	Wiper angle: 85°
		Type: Universal Built in switch: Yes Auto stop: No	
<b>160033 Wiper Motor</b> Std pkg 1 <i>Fitted w/ an interchangeable bearing allowing the shaft to be cut in any size.</i>		Voltage: 12	Wiper angle: 110°
		Type: Universal Built in switch: Yes Auto stop: No	

**160034 Wiper Motor** Std pkg 1

Fitted w/ an interchangeable bearing allowing the shaft to be cut in any size.

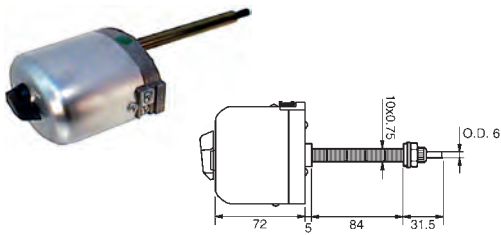

Voltage: 24

Wiper angle: 110°

Type: Universal  
 Built in switch: Yes  
 Auto stop: Yes

**160258 Wiper Motor** Std pkg 1 Servicing: HC-CARGO 160256, 160257, 160358, 160359, 160484

w/ reciprocating shaft.

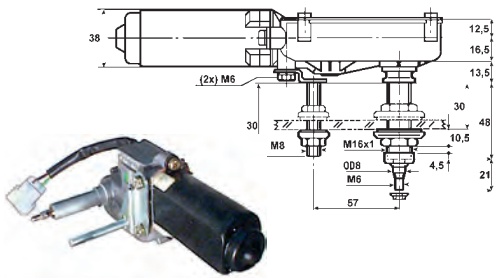

Voltage: 12

Dist./shafts: 57 mm  
 Wiper angle: 95°

Type: Universal  
 Wiper shaft: w/ 2 shafts for parallelogram  
 Built in switch: No  
 Auto stop: Yes

**160290 Wiper Motor** Std pkg 1 Servicing: HC-CARGO 160256, 160257, 160358, 160359

w/ reciprocating shaft.

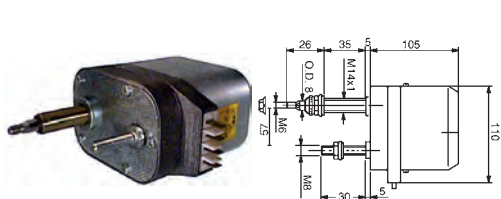

Voltage: 12

Dist./shafts: 57 mm  
 Wiper angle: 95°

Type: Universal  
 Wiper shaft: w/ 2 shafts for parallelogram  
 Built in switch: No  
 Auto stop: Yes  
 Auto stop/placement: Left side

**160291 Wiper Motor** Std pkg 1 Servicing: HC-CARGO 160256, 160257, 160358, 160359

w/ reciprocating shaft.

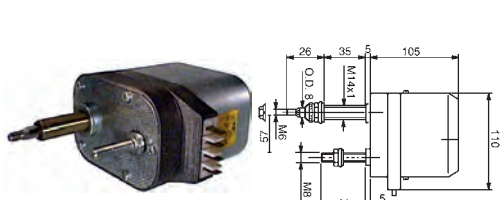

Voltage: 24

Dist./shafts: 57 mm  
 Wiper angle: 95°

Type: Universal  
 Wiper shaft: w/ 2 shafts for parallelogram  
 Auto stop: Yes  
 Auto stop/placement: Left side

**160292 Wiper Motor** Std pkg 1 Servicing: HC-CARGO 160339

w/ reciprocating shaft.

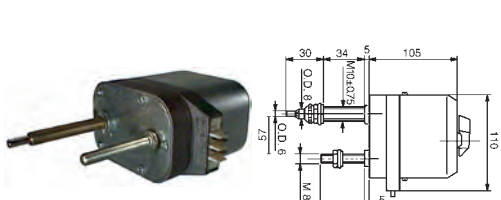

Voltage: 12

Dist./shafts: 57 mm  
 Wiper angle: 110°

Type: Universal  
 Wiper shaft: w/ 2 shafts for parallelogram  
 Built in switch: Yes  
 Auto stop: No

**160293 Wiper Motor** Std pkg 1 Servicing: HC-CARGO 160339

w/ reciprocating shaft.

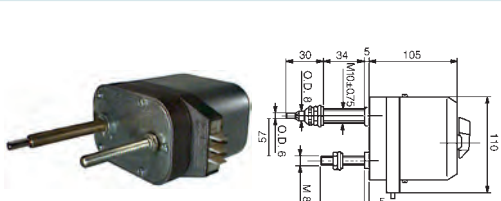

Voltage: 24

Dist./shafts: 57 mm  
 Wiper angle: 110°

Type: Universal  
 Wiper shaft: w/ 2 shafts for parallelogram  
 Built in switch: Yes  
 Auto stop: No

<b>160357 Wiper Motor</b> Std pkg 1 Servicing: HC-CARGO 160256, 160257, 160358, 160359 <i>w/ reciprocating shaft.</i>			<b>Voltage:</b> 12	<b>Dist./shafts:</b> 57 mm <b>Wiper angle:</b> 90°	<b>Type:</b> Universal <b>Wiper shaft:</b> w/ 2 shafts for parallelogram <b>Built in switch:</b> Yes <b>Auto stop:</b> No
<b>160408 Wiper Motor</b> Std pkg 1 Servicing: HC-CARGO 160256, 160257, 160358, 160359, 160484 <i>w/ reciprocating shaft.</i>			<b>Voltage:</b> 24	<b>Dist./shafts:</b> 57 mm <b>Wiper angle:</b> 95°	<b>Type:</b> Universal <b>Wiper shaft:</b> w/ 2 shafts for parallelogram <b>Auto stop/placement:</b> Right side
<b>160503 Wiper Motor</b> Std pkg 1			<b>Voltage:</b> 12		<b>Type:</b> Universal <b>Built in switch:</b> No <b>Auto stop:</b> Yes
<b>160504 Wiper Motor</b> Std pkg 1			<b>Voltage:</b> 24		<b>Type:</b> Universal <b>Auto stop:</b> Yes
<b>160506 Wiper Motor</b> Std pkg 1 <b>Moment: 0.8 NM.</b>			<b>Voltage:</b> 12	<b>Wiper angle:</b> 110°	<b>Type:</b> Universal <b>Wiper shaft:</b> w/ 1 Shaft <b>Built in switch:</b> Yes
<b>160558 Wiper Motor</b> Std pkg 1 <b>Black motor.</b>			<b>Voltage:</b> 12	<b>Wiper angle:</b> 85°	<b>Type:</b> Universal <b>Position:</b> Rear windscreen <b>Wiper shaft:</b> w/ 1 Shaft <b>Built in switch:</b> Yes

**160659 Wiper Motor** Std pkg 1

1 speed. Wiper Arm: HC-CARGO 160484, 160485.



Voltage: 12

Dist./shafts: 57 mm  
Wiper angle: 85°

Type: Universal  
Wiper shaft: w/ 1 M6 Shaft  
Built in switch: No  
Auto stop: Yes

**160725 Wiper Motor** Std pkg 1

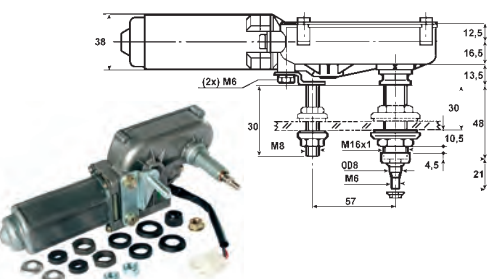

Voltage: 12

Dist./shafts: 57 mm  
Wiper angle: 90°

Type: Universal  
Wiper shaft: w/ 2 M8 shafts for parallelogram  
Built in switch: Yes  
Auto stop: Yes  
Auto stop/placement: Right side

**161022 Wiper Motor** Std pkg 1

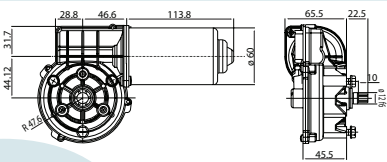

**NEW PRODUCT**  
[www.hc-cargo.com](http://www.hc-cargo.com)

Voltage: 24

Wiper angle: 90°

Type: Universal  
Built in switch: No

**161023 Wiper Motor** Std pkg 1

Wiper Arm: HC-CARGO 160256, 160257, 160358, 160359, 160484, 160485.

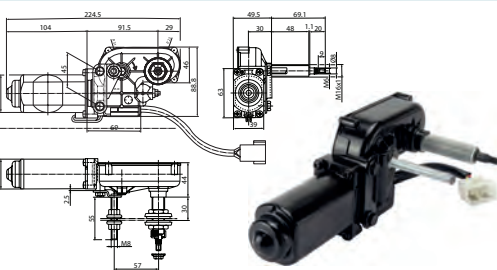

Voltage: 24

Dist./shafts: 57 mm  
Wiper angle: 85°

Type: Universal  
Built in switch: No

**161024 Wiper Motor** Std pkg 1

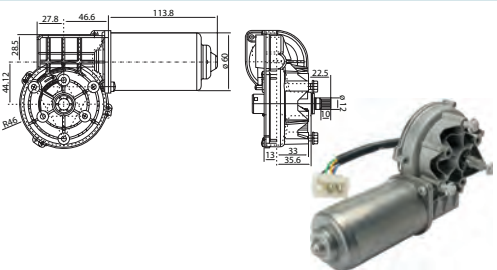

Voltage: 24

Wiper angle: 90°

Type: Universal  
Built in switch: No

**161025 Wiper Motor** Std pkg 1

Wiper Arm: HC-CARGO 160571.

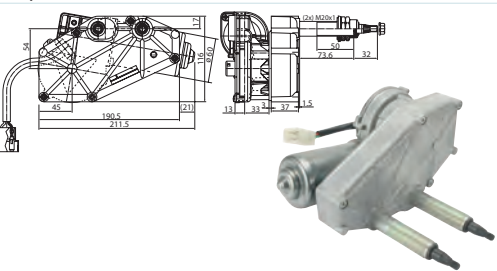

Voltage: 24

Wiper angle: 65°

Type: Universal  
Built in switch: No

## WINDSCREEN WASHERS

### KITS

**160186** Washer Kit Std pkg 1

*Pump: HC-CARGO 160386.*

Voltage: 12

 Dim.: 190x130x100 mm  
 Can capacity: 1.2 l  
 Capacity: 140 ml/min

 Type: Complete kit  
 Can: w/

**160273** Washer Kit Std pkg 1

*Pump: HC-CARGO 160630.*

Voltage: 24

 Dim.: 190x130x100 mm  
 Can capacity: 1.2 l

 Type: Complete kit  
 Can: w/

### TANKS

#### 12 V

**160187** Washer Tank Std pkg 1

*Washer pump: HC-CARGO 160360.*

Voltage: 12

 Dim.: 207x200x100 mm  
 Can capacity: 3 l

 Type: Can  
 Motor: w/

**160973** Washer Tank 12 V Std pkg 1

*Washer pump: HC-CARGO 160386.*

Voltage: 12

 Dim.: 190x130x100 mm  
 Can capacity: 1.2 l

 Type: Can  
 Motor: w/  
 Alternativ no.: 160186

#### 24 V

**160188** Washer Tank Std pkg 1

*Washer pump: HC-CARGO 160360.*

Voltage: 24

 Dim.: 207x200x100 mm  
 Can capacity: 3 l

 Type: Can  
 Motor: w/

**160967** Washer Tank Std pkg 1

*Doga ref. 232.2001.30.00.*











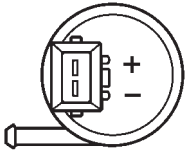

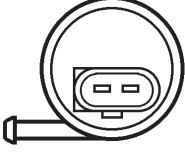

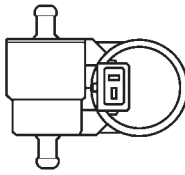
Voltage: 24

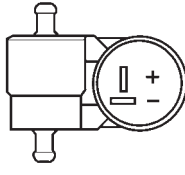

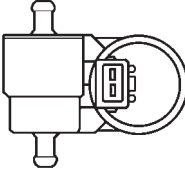

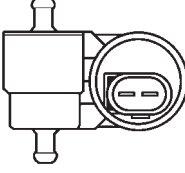

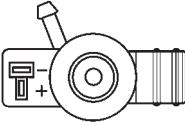



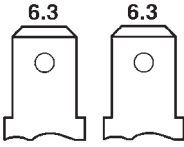

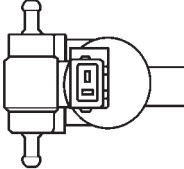
 Dim.: 220x151.5x100 mm  
 Can capacity: 2.1 l

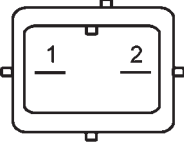
 Type: Can  
 Motor: w/

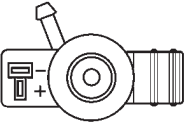
**PUMPS**

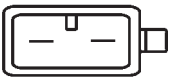
<b>160197 Washer Pump</b> Std pkg 1		Servicing: Porsche, Volvo, Volkswagen, Alfa Romeo, Audi, BMW, Fiat, Ford, Lancia, Mercedes-Benz, Opel, Porsche, Saab, Seat - Visit <a href="http://www.hc-cargo.com">www.hc-cargo.com</a> for further information.		
		Voltage: 12	Capacity: 2400 ml/min	Type: Standard Pump type: Single
<b>160198 Washer Pump</b> Std pkg 1		Servicing: Scania, Mercedes-Benz - Visit <a href="http://www.hc-cargo.com">www.hc-cargo.com</a> for further information.		
		Voltage: 24	Capacity: 2400 ml/min	Type: Universal Pump type: Single
<b>160223 Washer Pump</b> Std pkg 1		Servicing: Peugeot 104, 504 - Visit <a href="http://www.hc-cargo.com">www.hc-cargo.com</a> for further information.		
<i>For independent mounting in engine compartment.</i>				
		Voltage: 12	Capacity: 1500 ml/min	Type: Universal Pump type: Single
<b>160289 Washer Pump</b> Std pkg 1		Servicing: Peugeot, Citroen, Renault - Visit <a href="http://www.hc-cargo.com">www.hc-cargo.com</a> for further information.		
		Voltage: 24	Capacity: 1500 ml/min	Pump type: Single
<b>160332 Washer Pump</b> Std pkg 1		Servicing: Peugeot, Citroen, Renault - Visit <a href="http://www.hc-cargo.com">www.hc-cargo.com</a> for further information.		
		Voltage: 12	Capacity: 1500 ml/min	Pump type: Single
<b>160360 Washer Pump</b> Std pkg 1		Servicing: HC-CARGO 160187, 160188 Rover Group, Honda		
		Voltage: 12	Capacity: 1400 ml/min	Type: Universal Pump type: Single
<b>160361 Washer Pump</b> Std pkg 1		Servicing: Skoda Favorit - Visit <a href="http://www.hc-cargo.com">www.hc-cargo.com</a> for further information.		
<i>Replacing original pump 115930290 on Skoda Favorit.</i>				
		Voltage: 12	Capacity: 1200 ml/min	Type: Standard Pump type: Single

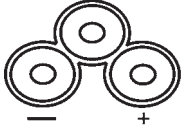
		EL. SPECIFICATIONS	DIMENSIONS	ADDITIONAL SPECIFICATIONS
<b>160378</b> Washer Pump	Std pkg 1	Servicing: Ford, Opel, Seat, VW - Visit <a href="http://www.hc-cargo.com">www.hc-cargo.com</a> for further information.		
		Voltage: 12	Capacity: 2200 ml/min	Pump type: Single
<b>160379</b> Washer Pump	Std pkg 1	Servicing: Mercedes-Benz - Visit <a href="http://www.hc-cargo.com">www.hc-cargo.com</a> for further information.		
		Voltage: 12	Capacity: 2200 ml/min	Type: Standard Pump type: Single
<b>160380</b> Washer Pump	Std pkg 1	Servicing: VW, Opel, Seat, Ford - Visit <a href="http://www.hc-cargo.com">www.hc-cargo.com</a> for further information.		
		Voltage: 12	Capacity: 2400 ml/min	Type: Universal Pump type: Dual
<b>160381</b> Washer Pump	Std pkg 1	Servicing: Fiat, Vauxhall, Audi, Ford, Opel, VW, Wartburg - Visit <a href="http://www.hc-cargo.com">www.hc-cargo.com</a> for further information.		
		Voltage: 12	Capacity: 2000 ml/min	Type: Universal Pump type: Dual
<b>160382</b> Washer Pump	Std pkg 1	Servicing: Opel, Seat, VW - Visit <a href="http://www.hc-cargo.com">www.hc-cargo.com</a> for further information.		
		Voltage: 12	Capacity: 2400 ml/min	Type: Universal Pump type: Dual
<b>160383</b> Washer Pump	Std pkg 1	Servicing: VW, Smart, Seat, Audi, BMW - Visit <a href="http://www.hc-cargo.com">www.hc-cargo.com</a> for further information.		
		Voltage: 12	Capacity: 2200 ml/min	Type: Universal Pump type: Dual
<b>160386</b> Washer Pump	Std pkg 1	Servicing: HC-CARGO 160186, 160973, Honda Accort, Peugeot (UK), Ford		
		Voltage: 12	Capacity: 1800 ml/min	Type: Universal Pump type: Single

		EL. SPECIFICATIONS	DIMENSIONS	ADDITIONAL SPECIFICATIONS
<b>160507</b> Washer Pump	Std pkg 1	Voltage: 24	Capacity: 1500 ml/min	Type: Universal Pump type: Single
				
<b>160535</b> Washer Pump	Std pkg 1	Servicing: Daihatsu, Ford, Mazda - Visit <a href="http://www.hc-cargo.com">www.hc-cargo.com</a> for further information.		
		Voltage: 12	Capacity: 1800 ml/min	Type: Standard Pump type: Dual
<b>160629</b> Washer Pump	Std pkg 1	Servicing: Citroen, Fiat, Peugeot - Visit <a href="http://www.hc-cargo.com">www.hc-cargo.com</a> for further information.		
		Voltage: 12	Capacity: 1700 ml/min	Type: Standard Pump type: Dual
<b>160630</b> Washer Pump	Std pkg 1	Servicing: HC-CARGO 160273		
		Voltage: 24	Capacity: 1800 ml/min	Type: Universal Pump type: Single
<b>160677</b> Washer Pump	Std pkg 1	Servicing: Daewoo, Hyundai, Kia, Mazda, Mitsubishi, Toyota - Visit <a href="http://www.hc-cargo.com">www.hc-cargo.com</a> for further information.		
		Voltage: 12	Capacity: 2000 ml/min	Type: Standard Pump type: Single
<b>160679</b> Washer Pump	Std pkg 1	Servicing: Mercedes-Benz - Visit <a href="http://www.hc-cargo.com">www.hc-cargo.com</a> for further information.		
		Voltage: 12	Capacity: 2100 ml/min	Type: Standard Pump type: Single
<b>160680</b> Washer Pump	Std pkg 1	Servicing: BMW - Visit <a href="http://www.hc-cargo.com">www.hc-cargo.com</a> for further information.		
		Voltage: 12	Capacity: 2300 ml/min	Type: Standard Pump type: Single

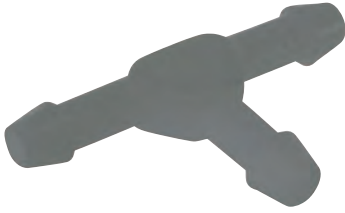

		EL. SPECIFICATIONS	DIMENSIONS	ADDITIONAL SPECIFICATIONS
<b>160681</b> Washer Pump	Std pkg 1	Servicing: Audi - Visit <a href="http://www.hc-cargo.com">www.hc-cargo.com</a> for further information.		
		Voltage: 12	Capacity: 2400 ml/min	Type: Standard Pump type: Single
<b>160682</b> Washer Pump	Std pkg 1	Servicing: Audi - Visit <a href="http://www.hc-cargo.com">www.hc-cargo.com</a> for further information.		
		Voltage: 12	Capacity: 2400 ml/min	Type: Standard Pump type: Dual
<b>160683</b> Washer Pump	Std pkg 1	Servicing: Audi, BMW, Mercedes-Benz, Seat, Skoda, VW - Visit <a href="http://www.hc-cargo.com">www.hc-cargo.com</a> for further information.		
		Voltage: 12	Capacity: 2200 ml/min	Type: Standard Pump type: Dual
<b>JETS</b>				
<b>160192</b> Washer Jet	Std pkg 10			
			OD: 6.2 mm Length: 38 mm Thread: 9.5 mm	Jet: Dual
<b>160686</b> Washer Jet	Std pkg 10			
			OD: 15 mm Length: 9 mm	Jet: Single
<b>160688</b> Washer Jet	Std pkg 10			
<i>Universal.</i>			OD: 5.8 mm Length: 30 mm Thread: 9.5 mm	Jet: Dual
				
<b>160917</b> Washer Jet	Std pkg 2	Servicing: Installation of wiper arms		
				Jet: Dual

**CONNECTIONS**
**160195** T-Connection Std pkg 10
*For hose I.D. 4 mm.*

OD: 4 mm

Valve: w/o

**160413** Pipe Connector Std pkg 10
*For hose I.D. 4 mm.*

 OD: 8 mm  
Length: 32 mm

Valve: w/

**RADIO ACCESSORIES**
**AERIALS**
**040077** Aerial Std pkg 1
*Removable mast.*



Ohm: 150

 Length: 400 mm  
Cable length: 1200 mm  
Hole size: 8 mm  
Mount. angle: 0-180

 Colour: Black  
Material: Rubber

**040094** Aerial Extension Lead Std pkg 1

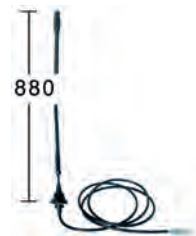

Cable length: 3500 mm

**040181** Aerial Std pkg 1
*Removable mast.*

Ohm: 150

 Length: 880 mm  
Cable length: 1600 mm  
Hole size: 18 mm  
Mount. angle: 0-45

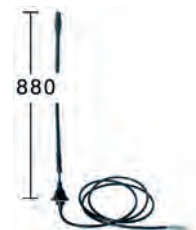



 Colour: Black  
Material: Fiber glass

**040182** Aerial Std pkg 1
*Removable mast.*

Ohm: 75

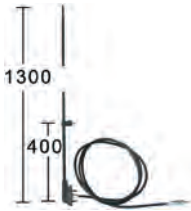
 Length: 880 mm  
Cable length: 1600 mm  
Hole size: 18 mm  
Mount. angle: 0-45

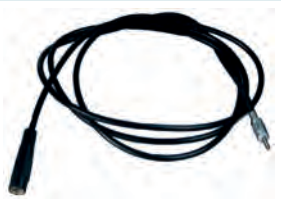
 Colour: Black  
Material: Fiber glass

EL. SPECIFICATIONS		DIMENSIONS	ADDITIONAL SPECIFICATIONS
<b>040190</b> Aerial Std pkg 1			
<i>Removable mast.</i>			
	Ohm: 150	Length: 570 mm Cable length: 1300 mm Hole size: 18 mm Mount. angle: 0-45	Colour: Black Material: Fiber glass
<b>040191</b> Aerial Std pkg 1			
<i>Extended.</i>			
	Ohm: 150	Length: 1300 mm Length 2: 400 mm Cable length: 1500 mm Hole size: 12 mm	Mount.: Pillar Type: 3 sections Colour: Black Material: Stainless steel Alternativ no.: 040215
<b>040215</b> Aerial Std pkg 1			
<i>Extended.</i>			
	Ohm: 150	Length: 1000 mm Cable length: 1500 mm Hole size: 12 mm	Mount.: Pillar Type: 3 sections Colour: Black Material: Stainless steel
<b>RALLONGES</b>			
<b>040019</b> Aerial Extension Lead Std pkg 1			
		Cable length: 1000 mm	
<b>040192</b> Aerial Extension Lead Std pkg 1			
		Cable length: 2000 mm	
<b>PLUGS &amp; SOCKETS</b>			
<b>040096</b> Aerial Plug Std pkg 10			
			Male/female: Male
<b>040199</b> Aerial Plug Std pkg 1			
<i>New standard (ISO).</i>			
			

**040200** Aerial Adaptor Std pkg 10

*New to old male plug ISO>DIN.*

**040201** Aerial Adaptor Std pkg 5

*Old to new male plug DIN>ISO.*

## CAPACITORS FOR CAR RADIOS

**150100** Capacitor Std pkg 10

*For car radios.*

 El. capacitance:  
2.2  $\mu\text{F}$ 

Length: 100 mm

 Type: Universal  
Mount. bracket: Straight  
Plug: Straight  
Cable: w/

**150101** Capacitor Std pkg 10

*For car radios.*

 El. capacitance:  
2.2  $\mu\text{F}$ 

Length: 80 mm

 Type: Universal  
Mount. bracket: Angled  
Plug: Angled  
Cable: w/

**150408** Capacitor Std pkg 10

*For car radios.*

 El. capacitance:  
2.2  $\mu\text{F}$ 

Length: 100 mm

 Type: Universal  
Mount. bracket: Angled  
Plug: Ring  
Cable: w/

## LOUDSPEAKER IN CABINET

**040197** Speakers Std pkg 1

 Watt: 20/40  
Ohm: 4

 Length: 97 mm  
Depth: 95 mm  
Width: 95 mm

 Cabinet: Yes  
Mount. bracket: w/  
Unit: Set

## LOUDSPEAKER BUILT-IN

**040193** Speakers Std pkg 1

70-23000 Hz.



Watt: 150  
Ohm: 4

ID/hole: 95 mm  
Depth: 50 mm  
Dist./mount. holes 1:  
80 mm  
Dist./mount. holes 2:  
115 mm  
Width: 100 mm

Type: Built-in  
System: 2 way  
Grill: w/  
Unit: Set

## RADIO MOUNTING KITS

**040149** Radio Box Std pkg 1



Colour: Black  
Material: Acrylic  
Mount. bracket: Pendant  
Integral front: Yes

**040170** Radio Mounting Kit Std pkg 1

Galvanized. w/ gasket.



Integral front: Yes

## DASHBOARD GAUGES

### AMMETER

**160697** Ammeter Std pkg 1

White figures.



Voltage: 12-24

OD: 52 mm

Mount. type: Hook fastening  
Colour: Black  
Measuring range: 30-0-30  
Measuring unit: A

**160698** Ammeter Std pkg 1

White figures.



Voltage: 12-24

OD: 52 mm

Mount. type: Hook fastening  
Colour: Black  
Measuring range: 60-0-60  
Measuring unit: A

### VOLTMETER

**160695** Voltmeter Std pkg 1

White figures.



Voltage: 8-16

OD: 52 mm

Mount. type: Hook fastening  
Colour: Black  
Measuring range: 8-16  
Measuring unit: V

**160696 Voltmeter** Std pkg 1

*White figures.*

Voltage: 16-32

OD: 52 mm

 Mount. type: Hook fastening  
 Colour: Black  
 Measuring range: 16-32  
 Measuring unit: V

**HOUR METER**
**160702 Hour Meter** Std pkg 1

*w/o illumination. IP65.*

Voltage: 12-28

OD: 52 mm

 Type: Mechanical  
 Mount. type: Hook fastening  
 Colour: Black  
 Measuring unit: Hours

**160747 Hour Meter** Std pkg 1

*w/o illumination.*

Voltage: 10-28

OD: 36.5x25 mm

 Type: Electrical operated  
 Colour: Black  
 Measuring unit: Hours

**160897 Hour Meter** Std pkg 1

*Digital.*

Voltage: 10-28

OD: 52 mm

 Type: Electrical operated  
 Mount. type: Hook fastening  
 Colour: Black  
 Measuring unit: Hours  
 Digital: Yes

**FUEL GAUGES**
**160701 Fuel Gauge** Std pkg 1

*10-180 Ohm. Fuel Gauge: HC-CARGO 160873.*

Voltage: 12

OD: 52 mm

 Mount. type: Hook fastening  
 Colour: Black  
 Measuring unit: L  
 Sender: w/

**160872 Fuel Gauge** Std pkg 1

*Fuel Gauge: HC-CARGO 160873.*



Voltage: 24

OD: 52 mm

 Mount. type: Hook fastening  
 Colour: Black  
 Measuring unit: L  
 Sender: w/

<p><b>160873</b> Fuel Gauge      Std pkg 1</p> 	<p>Servicing: HC-CARGO 160701, 160872</p>	<p>Voltage: 12/24</p>	<p>OD: 52 mm</p>	
--	---	-----------------------	------------------	--

**WATER TEMP. GAUGES**

<p><b>160699</b> Water Temp. Gauge      Std pkg 1</p> <p>Transmitter 1/8" NPTF: HC-CARGO 160786.</p> 		<p>Voltage: 12</p>	<p>OD: 52 mm</p>	<p>Type: Electrical operated Mount. type: Hook fastening Colour: Black Measuring range: 40-120 Measuring unit: °C Sender: w/</p>
--	--	--------------------	------------------	--

<p><b>160778</b> Water Temp. Gauge      Std pkg 1</p> <p>Transmitter 1/8" NPTF: HC-CARGO 160786.</p> 		<p>Voltage: 24</p>	<p>OD: 52 mm</p>	<p>Type: Electrical operated Mount. type: Hook fastening Colour: Black Measuring range: 40-120 Measuring unit: °C Sender: w/</p>
---	--	--------------------	------------------	--

**OIL PRESSURE GAUGES**

<p><b>160700</b> Electrical Oil Pressure Gauge      Std pkg 1</p> <p>Transmitter 1/8" NPTF: HC-CARGO 160787.</p> 		<p>Voltage: 12</p>	<p>OD: 52 mm</p>	<p>Type: Electrical operated Mount. type: Hook fastening Colour: Black Measuring range: 0-10 Measuring unit: Bar Sender: w/</p>
--	--	--------------------	------------------	---

<p><b>160779</b> Oil Pressure Gauge      Std pkg 1</p> <p>Transmitter 1/8" NPTF: HC-CARGO 160787.</p> 		<p>Voltage: 24</p>	<p>OD: 52 mm</p>	<p>Type: Electrical operated Mount. type: Hook fastening Colour: Black Measuring range: 0-10 Measuring unit: Bar Sender: w/</p>
---	--	--------------------	------------------	---

**IGNITION COMPONENTS**

**IGNITION COILS**

<p><b>150246</b> Electronic Ignition Coil      Std pkg 1</p> <p>2 units on each vehicle.</p> 	<p>Servicing: Alfa Romeo, Fiat, Lancia - Visit <a href="http://www.hc-cargo.com">www.hc-cargo.com</a> for further information.</p>	<p>Voltage: 12</p>		<p>Type: Electronic, Dry No./terminals: 2</p>
--	--	--------------------	--	---

EL. SPECIFICATIONS		DIMENSIONS	ADDITIONAL SPECIFICATIONS
150252 Electronic Ignition Coil	Std pkg 1	Servicing: Alfa Romeo, Citroen, Fiat, Honda, Kia, Lancia, Land Rover, Peugeot - Visit <a href="http://www.hc-cargo.com">www.hc-cargo.com</a> for further information.	
<i>2 units on each vehicle.</i>			
		Voltage: 12	Type: Electronic, Dry No./terminals: 3
150259 Electronic Ignition Coil	Std pkg 1	Servicing: Citroen, Fiat, Innocenti, Lancia, Peugeot - Visit <a href="http://www.hc-cargo.com">www.hc-cargo.com</a> for further information.	
		Voltage: 12	Type: Electronic, Dry No./terminals: 4
150266 Electronic Ignition Coil	Std pkg 1	Servicing: Toyota - Visit <a href="http://www.hc-cargo.com">www.hc-cargo.com</a> for further information.	
		Voltage: 12	Type: Electronic, Dry No./terminals: 2
150270 Electronic Ignition Coil	Std pkg 1	Servicing: Honda, Rover - Visit <a href="http://www.hc-cargo.com">www.hc-cargo.com</a> for further information.	
		Voltage: 12	Type: Electronic, Dry No./terminals: 2
150416 Electronic Ignition Coil	Std pkg 1	Servicing: Mazda, Ford - Visit <a href="http://www.hc-cargo.com">www.hc-cargo.com</a> for further information.	
		Voltage: 12	Type: Electronic, Dry No./terminals: 3
150424 Electronic Ignition Coil	Std pkg 1	Servicing: Daewoo, Mercedes-Benz, Puch (Steyr-Daimler), Ssangyong, VW - Visit <a href="http://www.hc-cargo.com">www.hc-cargo.com</a> for further information.	
		Voltage: 12	Type: Electronic, Dry
150428 Electronic Ignition Coil	Std pkg 1	Servicing: Audi, Seat, Skoda, VW - Visit <a href="http://www.hc-cargo.com">www.hc-cargo.com</a> for further information.	
		Voltage: 12	Type: Electronic, Dry





		EL. SPECIFICATIONS	DIMENSIONS	ADDITIONAL SPECIFICATIONS
<b>150433</b>	Electronic Ignition Coil	Std pkg 1	<b>Servicing:</b> Nissan, Renault - Visit <a href="http://www.hc-cargo.com">www.hc-cargo.com</a> for further information. <b>Voltage:</b> 12	<b>Type:</b> Electronic, Dry
				
<b>150434</b>	Electronic Ignition Coil	Std pkg 1	<b>Servicing:</b> Renault - Visit <a href="http://www.hc-cargo.com">www.hc-cargo.com</a> for further information. <b>Voltage:</b> 12	<b>Type:</b> Electronic, Dry
				
<b>150441</b>	Electronic Ignition Coil	Std pkg 1	<b>Servicing:</b> Nissan, Renault - Visit <a href="http://www.hc-cargo.com">www.hc-cargo.com</a> for further information. <b>Voltage:</b> 12	<b>Type:</b> Electronic, Dry
				
<b>150505</b>	Electronic Ignition Coil	Std pkg 1	<b>Servicing:</b> Nissan, Opel, Renault, Vauxhall - Visit <a href="http://www.hc-cargo.com">www.hc-cargo.com</a> for further information. <b>Voltage:</b> 12	<b>Type:</b> Electronic, Dry, Pencil
				
<b>150508</b>	Electronic Ignition Coil	Std pkg 1	<b>Servicing:</b> Audi, Seat, Skoda, VW - Visit <a href="http://www.hc-cargo.com">www.hc-cargo.com</a> for further information. <b>Voltage:</b> 12	<b>Type:</b> Electronic, Dry, Pencil
				
<b>150509</b>	Electronic Ignition Coil	Std pkg 1	<b>Servicing:</b> Audi, Seat, Skoda, VW - Visit <a href="http://www.hc-cargo.com">www.hc-cargo.com</a> for further information. <b>Voltage:</b> 12	<b>Type:</b> Electronic, Dry, Pencil
				
<b>150513</b>	Electronic Ignition Coil	Std pkg 1	<b>Servicing:</b> Skoda, VW - Visit <a href="http://www.hc-cargo.com">www.hc-cargo.com</a> for further information. <b>Voltage:</b> 12	<b>Type:</b> Electronic, Dry, Pencil <b>No./terminals:</b> 4
				

		EL. SPECIFICATIONS	DIMENSIONS	ADDITIONAL SPECIFICATIONS
<b>150514</b>	Electronic Ignition Coil	Std pkg 1	Servicing: Volvo - Visit <a href="http://www.hc-cargo.com">www.hc-cargo.com</a> for further information.	
		Voltage: 12		Type: Electronic, Dry, Pencil
<b>150520</b>	Electronic Ignition Coil	Std pkg 1	Servicing: Citroen, Peugeot - Visit <a href="http://www.hc-cargo.com">www.hc-cargo.com</a> for further information.	
		Voltage: 12		Type: Electronic, Dry
<b>150521</b>	Electronic Ignition Coil	Std pkg 1	Servicing: Opel, Vauxhall - Visit <a href="http://www.hc-cargo.com">www.hc-cargo.com</a> for further information.	
		Voltage: 12		Type: Electronic, Dry
<b>150522</b>	Electronic Ignition Coil	Std pkg 1	Servicing: Citroen, Peugeot - Visit <a href="http://www.hc-cargo.com">www.hc-cargo.com</a> for further information.	
		Voltage: 12		Type: Electronic, Dry
<b>150525</b>	Electronic Ignition Coil	Std pkg 1	Servicing: Opel - Visit <a href="http://www.hc-cargo.com">www.hc-cargo.com</a> for further information.	
		Voltage: 12		Type: Electronic, Dry
<b>UNIVERSAL</b>				
<b>150037</b>	Electronic Ignition Coil	Std pkg 1	Servicing: Opel - Visit <a href="http://www.hc-cargo.com">www.hc-cargo.com</a> for further information.	
		Voltage: 12	OD: 55 mm	Type: Universal, Oil cooled, Ordinary No./terminals: 2
<b>150169</b>	Electronic Ignition Coil	Std pkg 1	Servicing: Opel - Visit <a href="http://www.hc-cargo.com">www.hc-cargo.com</a> for further information.	
		Voltage: 12	OD: 60 mm	Type: Universal, Oil cooled, Super No./terminals: 2

<p><b>150395</b> Electronic Ignition Coil w/ external resistor.</p> 	<p>Std pkg 1</p>	<p>Servicing: Hitachi, BMW - Visit <a href="http://www.hc-cargo.com">www.hc-cargo.com</a> for further information.</p> <p>Voltage: 12</p> <p>Type: Universal, High Power, Dry No./terminals: 2 Terminals w/thread: Yes</p>
---	------------------	--

**MODULES**



<p><b>150055</b> Ignition Module</p>  <p>Also repl. ignition modules w/ 6 terminals.</p>	<p>Std pkg 1</p>	<p>Servicing: Alfa Romeo, BMW, Citroen, Fiat, Mercedes-Benz, Opel, Peugeot, Talbot, Vauxhall, Zastava - Visit <a href="http://www.hc-cargo.com">www.hc-cargo.com</a> for further information.</p> <p>Type: Pick up No./terminals: 7 1: K11 2: K131/Ground 3: K131/Ground 4: K115 5: G+ 6: G- 7: TACH/rpm</p>
---	------------------	--



<p><b>150056</b> Ignition Module</p>  <p>Also repl. ignition modules w/ 6 terminals.</p>	<p>Std pkg 1</p>	<p>Servicing: Alfa, BMW, GM, KHD, Renault, Audi, Opel, Porsche, Saab, Seat, Vauxhall, Volvo, VW - Visit <a href="http://www.hc-cargo.com">www.hc-cargo.com</a> for further information.</p> <p>Type: Hall No./terminals: 7 1: K11 2: K131/Ground 3: K131/Ground 4: K115 5: G+ 6: G° 7: TACH/rpm</p>
---	------------------	---

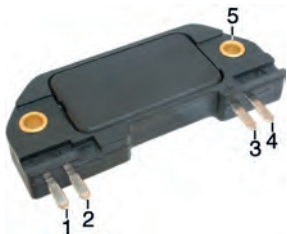

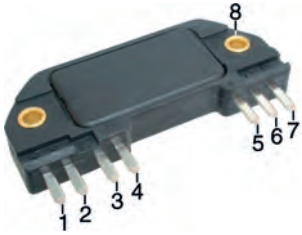
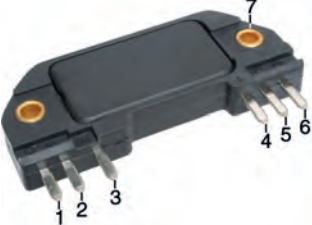
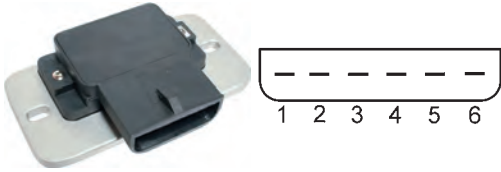
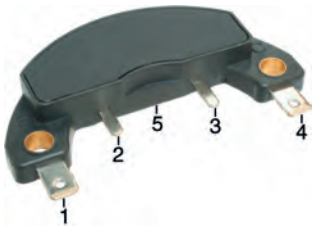

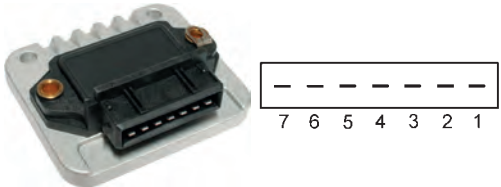
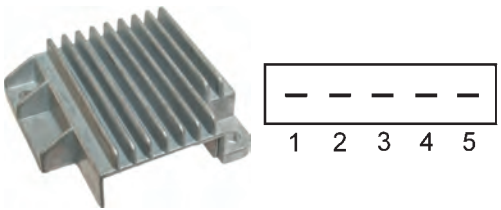

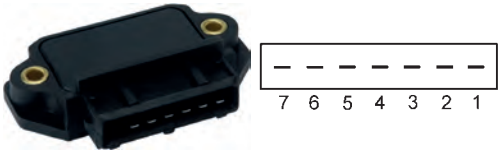
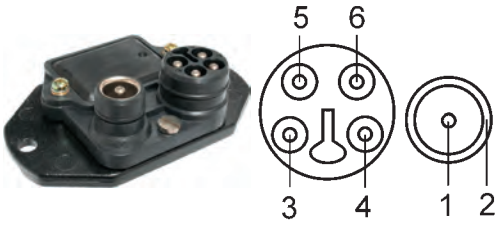
<p><b>150057</b> Ignition Module</p> 	<p>Std pkg 1</p>	<p>Servicing: Alfa Romeo, Citroen, Ford, Peugeot - Visit <a href="http://www.hc-cargo.com">www.hc-cargo.com</a> for further information.</p> <p>Type: Pick up No./terminals: 5 1: K11 2: K131/Ground 3: K115 4: G+ 5: G-</p>
--	------------------	--

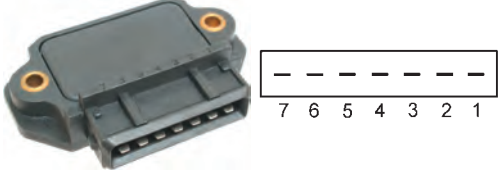
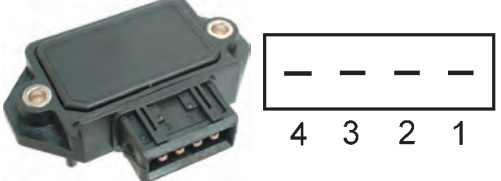

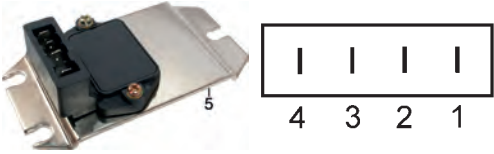

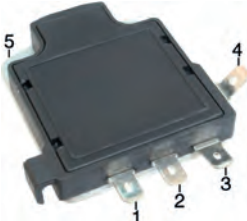

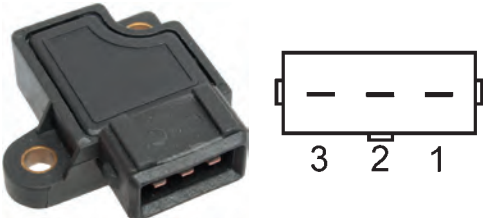
<p><b>150058</b> Ignition Module</p> 	<p>Std pkg 1</p>	<p>Servicing: AMC, GM, Opel, Peugeot, Vauxhall, Alfa Romeo, Autobianchi, Fiat, Lancia, Polski-Fiat, Renault - Visit <a href="http://www.hc-cargo.com">www.hc-cargo.com</a> for further information.</p> <p>Type: Pick up No./terminals: 5 1: G-/W 2: G+/G 3: K115/B 4: K11/C 5: K131/Ground</p>
--	------------------	---

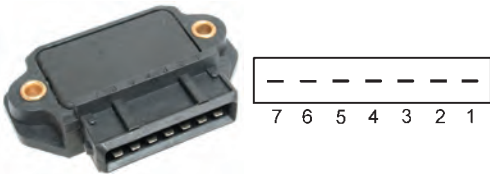
<p><b>150062</b> Ignition Module</p> 	<p>Std pkg 1</p>	<p>Servicing: AMC, Buick, Cadillac, Chevrolet, GM, Jeep, Oldsmobile, Pontiac, Opel, Vauxhall - Visit <a href="http://www.hc-cargo.com">www.hc-cargo.com</a> for further information.</p> <p>Type: Pick up No./terminals: 5 1: G- 2: G+ 3: K115 4: K11 5: K131/Ground</p>
--	------------------	--

		EL. SPECIFICATIONS	DIMENSIONS	ADDITIONAL SPECIFICATIONS
<b>150063</b> Ignition Module	Std pkg 1	Servicing: GM, Honda, Opel, Vauxhall - Visit <a href="http://www.hc-cargo.com">www.hc-cargo.com</a> for further information.		<b>Type:</b> Pick up <b>No./terminals:</b> 8 1: G+/P 2: G-/N 3: Input/E 4: Output/R 5: KI15/+ 6: KI1/C 7: Output/B 8: KI31/Ground
				
<b>150064</b> Ignition Module	Std pkg 1	Servicing: Opel, Vauxhall - Visit <a href="http://www.hc-cargo.com">www.hc-cargo.com</a> for further information.		<b>Type:</b> Pick up <b>No./terminals:</b> 7 1: G+/P 2: G-/N 3: Input/T 4: KI15/+ 5: KI1/C 6: Output/0 7: KI31/Ground
				
<b>150067</b> Ignition Module	Std pkg 1	Servicing: Ford, Renault V.I. - Visit <a href="http://www.hc-cargo.com">www.hc-cargo.com</a> for further information.		<b>Type:</b> Pick up <b>No./terminals:</b> 6 1: KI1 2: KI15 3: NC 4: G+ 5: G- 6: KI31/Ground
				
<b>150068</b> Ignition Module	Std pkg 1	Servicing: Chrysler, Mazda, Mitsubishi - Visit <a href="http://www.hc-cargo.com">www.hc-cargo.com</a> for further information.		<b>Type:</b> Pick up <b>No./terminals:</b> 5 1: KI15/B 2: G- 3: G+ 4: KI1/C 5: KI31/Ground
				
<b>150072</b> Ignition Module	Std pkg 1	Servicing: Ford - Visit <a href="http://www.hc-cargo.com">www.hc-cargo.com</a> for further information.		<b>Type:</b> Pick up <b>No./terminals:</b> 5 1: G+ 2: G- 3: KI15 4: KI31/Ground 5: KI1
				
<b>150075</b> Ignition Module	Std pkg 1	Servicing: Audi, Saab, Seat, Volvo, VW, Wartburg - Visit <a href="http://www.hc-cargo.com">www.hc-cargo.com</a> for further information.		<b>Type:</b> Hall <b>No./terminals:</b> 7 1: KI1 2: KI31/Ground 3: KI31/Ground 4: KI15 5: G+ 6: G° 7: TACH/rpm
				
<b>150088</b> Ignition Module	Std pkg 1	Servicing: Fiat, Innocenti, Lancia - Visit <a href="http://www.hc-cargo.com">www.hc-cargo.com</a> for further information.		<b>Type:</b> Pick up <b>No./terminals:</b> 5 1: G- 2: G+ 3: KI15 4: KI1 5: KI31/Ground
				

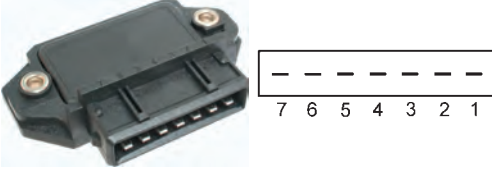
EL. SPECIFICATIONS		DIMENSIONS	ADDITIONAL SPECIFICATIONS
150096 Ignition Module	Std pkg 1	Servicing: Chrysler, Hyundai, Mazda, Mitsubishi - Visit <a href="http://www.hc-cargo.com">www.hc-cargo.com</a> for further information.	Type: Pick up No./terminals: 3 1: KI31/Ground 2: KI15/B 3: KI1/C
			
150098 Ignition Module	Std pkg 1	Servicing: Volvo, 0001512001, Citroen, Opel, Peugeot, Porsche, Renault V.I., Saab, Seat, Vauxhall - Visit <a href="http://www.hc-cargo.com">www.hc-cargo.com</a> for further information.	Type: Amplifier No./terminals: 6 1: KI1 2: KI31/Ground 3: KI31/Ground 4: KI15 5: Input 6: NC 7: NC
			
150154 Ignition Module	Std pkg 1	Servicing: Mercedes-Benz, Puch (Steyr-Daimler) - Visit <a href="http://www.hc-cargo.com">www.hc-cargo.com</a> for further information.	Type: Pick up Type/terminal: Bullet No./terminals: 6 1: G+ 2: G- 3: KI1/16 4: KI15 5: KI31/Ground 6: TACH/rpm
			
150157 Ignition Module	Std pkg 1	Servicing: Toyota - Visit <a href="http://www.hc-cargo.com">www.hc-cargo.com</a> for further information.	Type: Pick up No./terminals: 6 1: KI15/B (Red) 2: KI1/C (Yellow) 3: KI31/Ground 4: TACH/rpm 5: + 6: -
			
150160 Ignition Module	Std pkg 1	Servicing: Ford, Nissan, Suzuki, Mazda - Visit <a href="http://www.hc-cargo.com">www.hc-cargo.com</a> for further information.	Type: Pick up No./terminals: 5 1: KI15/B 2: KI1/C 3: G+ 4: G- 5: KI31/Ground
			
150165 Ignition Module	Std pkg 1	Servicing: Alfa Romeo, Ferrari, Fiat, Lancia - Visit <a href="http://www.hc-cargo.com">www.hc-cargo.com</a> for further information.	Type: Amplifier No./terminals: 7 1: KI1 2: KI31/Ground 3: KI31/Ground 4: KI15 5: NC 6: Input 7: NC
			
150175 Ignition Module	Std pkg 1	Servicing: Opel, Vauxhall - Visit <a href="http://www.hc-cargo.com">www.hc-cargo.com</a> for further information.	Type: Amplifier No./terminals: 4 1: KI1 2: KI31/Ground 3: KI15 4: Input Alternativ no.: 150380
			

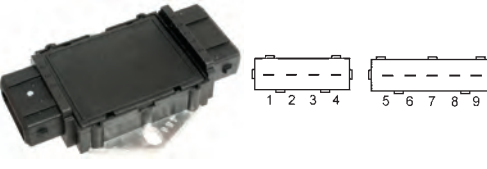
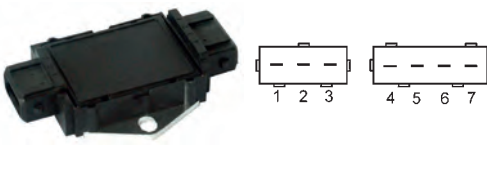
		EL. SPECIFICATIONS	DIMENSIONS	ADDITIONAL SPECIFICATIONS
150215 Ignition Module	Std pkg 1	Servicing: Skoda - Visit <a href="http://www.hc-cargo.com">www.hc-cargo.com</a> for further information.		Type: Pick up No./terminals: 5 1: KI15 2: G- 3: G+ 4: KI1 5: KI31/Ground
				
150234 Ignition Module	Std pkg 1	Servicing: Mazda - Visit <a href="http://www.hc-cargo.com">www.hc-cargo.com</a> for further information.		Type: Pick up Type/terminal: Internal thread No./terminals: 5 1: KI1/C 2: KI15/B 3: KI31/Ground 4: G+/+ 5: G-/SG
				
150236 Ignition Module	Std pkg 1	Servicing: Acura, Honda - Visit <a href="http://www.hc-cargo.com">www.hc-cargo.com</a> for further information.		Type: Amplifier No./terminals: 5 1: Input 2: KI15 3: KI1 4: TACH/rpm 5: KI31/Ground
				
150239 Ignition Module	Std pkg 1	Servicing: GM USA, Daewoo - Visit <a href="http://www.hc-cargo.com">www.hc-cargo.com</a> for further information.		Type: Amplifier No./terminals: 8 1: KI15 2: KI1/C 3: KI31/Ground 4: B(ECU) 5: B(ECU) 6: E(ECU) 7: G+ 8: W-
				
150377 Ignition Module	Std pkg 1	Servicing: Suzuki, Audi, Hyundai, Mitsubishi, Seat, Skoda, VW - Visit <a href="http://www.hc-cargo.com">www.hc-cargo.com</a> for further information.		Type: Amplifier No./terminals: 3 1: Input 2: KI31/Ground 3: KI1
				
150378 Ignition Module	Std pkg 1	Servicing: Mitsubishi - Visit <a href="http://www.hc-cargo.com">www.hc-cargo.com</a> for further information.		Type: Amplifier No./terminals: 5 1: KI1/C 2: KI15/B 3: KI31/Ground 4: G+/+ 5: G-/SG
				
150379 Ignition Module	Std pkg 1	Servicing: BMW, Opel, Alfa Romeo, Citroen, Lancia, Peugeot, Porsche - Visit <a href="http://www.hc-cargo.com">www.hc-cargo.com</a> for further information.		Type: Amplifier No./terminals: 7 1: KI1 2: Input 3: NC 4: KI31/Ground 5: NC 6: KI1 7: Input
				

<p><b>150380</b> Ignition Module w/ bracket.</p> 	<p>Std pkg 1 Servicing: Opel, Vauxhall - Visit <a href="http://www.hc-cargo.com">www.hc-cargo.com</a> for further information.</p>	<p>Type: Amplifier No./terminals: 4 1: K11 2: KI31/Ground 3: KI15 4: Input Alternativ no.: 150175</p>
<p><b>150384</b> Ignition Module</p> 	<p>Std pkg 1 Servicing: Honda - Visit <a href="http://www.hc-cargo.com">www.hc-cargo.com</a> for further information.</p>	<p>Type: Amplifier No./terminals: 5 1: KI31/Ground 2: Input 3: KI15 4: KI1 5: RPM out/TD</p>
<p><b>150387</b> Ignition Module</p> 	<p>Std pkg 1 Servicing: Alfa Romeo, Ferrari, Opel, Volvo - Visit <a href="http://www.hc-cargo.com">www.hc-cargo.com</a> for further information.</p>	<p>Type: Amplifier No./terminals: 7 1: KI1 2: Input 3: KI1 4: KI31/Ground 5: Input 6: KI1 7: Input</p>
<p><b>150398</b> Ignition Module</p> 	<p>Std pkg 1 Servicing: Hitachi, Honda - Visit <a href="http://www.hc-cargo.com">www.hc-cargo.com</a> for further information.</p>	<p>Type: Pick up No./terminals: 5 1: Ground 2: C+/B 3: B+/B2 4: TACH/rpm 5: C-/C</p>
<p><b>150406</b> Ignition Module</p> 	<p>Std pkg 1 Servicing: Skoda, Audi, Seat, VW - Visit <a href="http://www.hc-cargo.com">www.hc-cargo.com</a> for further information.</p>	<p>Type: Amplifier No./terminals: 9 1: KI1.4 2: LI1.3 3: KI1.2 4: KI1.1 5: Input4 6: Input3 7: KI31 8: Input2 9: Input1</p>
<p><b>150409</b> Ignition Module</p> 	<p>Std pkg 1 Servicing: VW, Passat, Audi - Visit <a href="http://www.hc-cargo.com">www.hc-cargo.com</a> for further information.</p>	<p>Type: Amplifier No./terminals: 7 1: KI1.1 2: KI1.2 3: KI1.3 4: Input1 5: Input2 6: KI31 7: Input3</p>
<p><b>150417</b> Ignition Module</p> 	<p>Std pkg 1 Servicing: Mazda - Visit <a href="http://www.hc-cargo.com">www.hc-cargo.com</a> for further information.</p>	<p>Type: Pick up No./terminals: 6 1: KI1/G 2: KI15/B 3: G+ 4: KI31/Ground 5: W- 6: A</p>

**150512** Ignition Module Std pkg 1 Servicing: Mitsubishi - Visit [www.hc-cargo.com](http://www.hc-cargo.com) for further information.

*Hall.*

 Type: Hall  
 No./terminals: 6

## ELECTRONIC KITS

**150227** Electronic Ignition Kit Std pkg 1 Servicing: Audi, Seat, Skoda, VW - Visit [www.hc-cargo.com](http://www.hc-cargo.com) for further information.

*Does not fit VW w/ Telefunken plant.*

Voltage: 12

 Type: Dry  
 Terminals/ignition coil: 2  
 Terminals/module: 3  
 Terminals w/thread: Yes

**150403** Electronic Ignition Kit Std pkg 1 Servicing: Opel, Vauxhall - Visit [www.hc-cargo.com](http://www.hc-cargo.com) for further information.

Voltage: 12

 Type: Dry  
 Terminals/module: 4

**150435** Electronic Ignition Kit Std pkg 1 Servicing: Audi, Seat, Skoda, VW - Visit [www.hc-cargo.com](http://www.hc-cargo.com) for further information.

Voltage: 12

 Type: Dry  
 Terminals/module: 4  
 Terminals w/thread: Yes

**150516** Electronic Ignition Kit Std pkg 1 Servicing: Ford, Mercedes-Benz, VW - Visit [www.hc-cargo.com](http://www.hc-cargo.com) for further information.



Voltage: 12

 Type: Dry  
 Terminals/module: 5

## SWITCHES & SENSORS - ENGINE MANAGEMENT



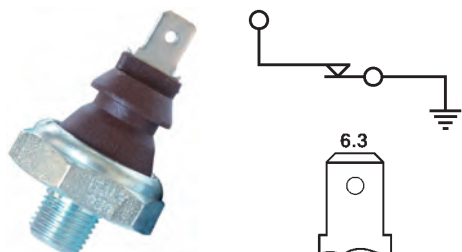







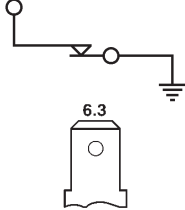

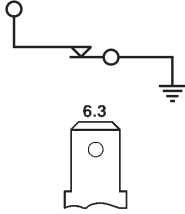
### SWITCHES

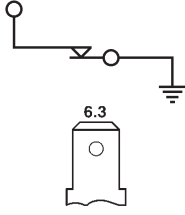
#### OIL PRESSURE SWITCHES

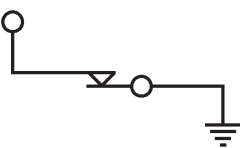
**180626** Oil Pressure Switch Std pkg 1

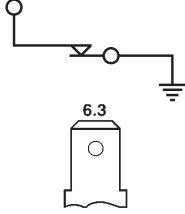
 Thread type: M10-1  
 cone  
 Pressure: 0.3 bar

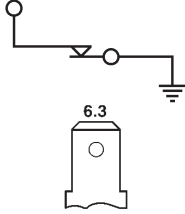
Alternativ no.: 180634

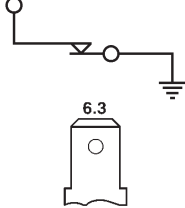

EL. SPECIFICATIONS		DIMENSIONS	ADDITIONAL SPECIFICATIONS
<b>180631</b> 7.0001 Oil Pressure Switch	Std pkg 1	Servicing: Fiat, Lancia, Seat - Visit <a href="http://www.hc-cargo.com">www.hc-cargo.com</a> for further information.	
			Thread type: M12-1.5 Pressure: 0.3 bar
<b>180634</b> 7.0007 Oil Pressure Switch	Std pkg 1	Servicing: Alfa Romeo, Audi, BMW, Rover - Visit <a href="http://www.hc-cargo.com">www.hc-cargo.com</a> for further information.	
			Thread type: M10-1 cone Pressure: 0.3 bar Alternativ no.: 180626
<b>180635</b> 7.0008 Oil Pressure Switch	Std pkg 1	Servicing: Alfa Romeo, Audi, Lancia, Seat, Volvo, VW - Visit <a href="http://www.hc-cargo.com">www.hc-cargo.com</a> for further information.	
<i>Replacing original brown switch.</i>			
			Thread type: M10-1 Pressure: 0.3 bar
<b>180636</b> 7.0011 Oil Pressure Switch	Std pkg 1	Servicing: Ford, Mazda - Visit <a href="http://www.hc-cargo.com">www.hc-cargo.com</a> for further information.	
			Thread type: 1/4-18 NPT cone Pressure: 0.3 bar
<b>180641</b> 7.0017 Oil Pressure Switch	Std pkg 1	Servicing: Acura, Chevrolet, Daewoo, Daihatsu, Ford, Hyundai, Kia, Mazda, Mitsubishi, Suzuki, Toyota, VW - Visit <a href="http://www.hc-cargo.com">www.hc-cargo.com</a> for further information.	
			Thread type: 1/8 GAS cone Pressure: 0.4 bar
<b>180648</b> 7.0026 Oil Pressure Switch	Std pkg 1	Servicing: BMW, Mercedes-Benz, Puch (Steyr-Daimler), Smart (MCC), VW - Visit <a href="http://www.hc-cargo.com">www.hc-cargo.com</a> for further information.	
<i>Replacing original brown switch.</i>			
			Thread type: M12-1.5 Pressure: 0.35 bar
<b>180649</b> 7.0027 Oil Pressure Switch	Std pkg 1	Servicing: Austin, Rover - Visit <a href="http://www.hc-cargo.com">www.hc-cargo.com</a> for further information.	
			Thread type: 1/8-27 NPT cone Pressure: 0.5 bar

**180658** 7.0045 Oil Pressure Switch Std pkg 1 Servicing: Audi, Seat, VW - Visit [www.hc-cargo.com](http://www.hc-cargo.com) for further information.

Replacing original white switch.

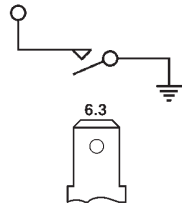
 Thread type: M10-1  
 Pressure: 1.8 bar

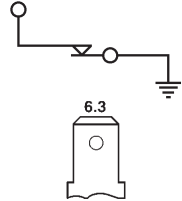
**180660** 7.0047 Oil Pressure Switch Std pkg 1 Servicing: Volvo - Visit [www.hc-cargo.com](http://www.hc-cargo.com) for further information.

 Thread type: 1/8-27  
 NPT cone  
 Pressure: 0.5 bar

**180688** 7.0095 Oil Pressure Switch Std pkg 1 Servicing: Audi, Ford, Seat, Skoda, VW - Visit [www.hc-cargo.com](http://www.hc-cargo.com) for further information.

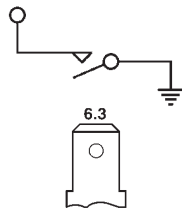
Replacing original brown and grey switch.



 Thread type: M10-1  
 Pressure: 0.9 bar

**180694** 7.0108 Oil Pressure Switch Std pkg 1 Servicing: Audi, Ford, Mercedes-Benz, Renault, Seat, Skoda, Volvo, VW - Visit [www.hc-cargo.com](http://www.hc-cargo.com) for further information.

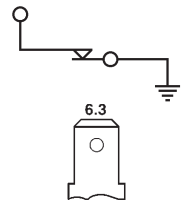
Replacing original light blue switch.



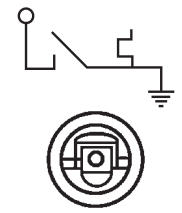



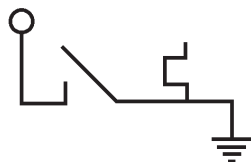

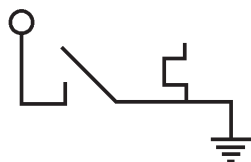

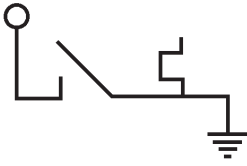

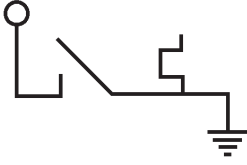

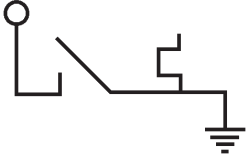
 Thread type: M10-1  
 Pressure: 0.3 bar

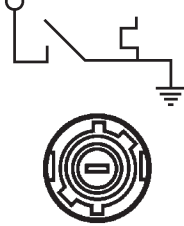

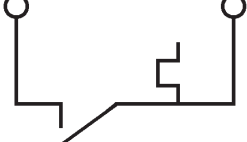

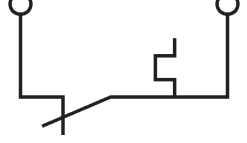

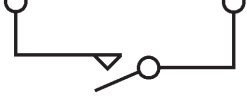



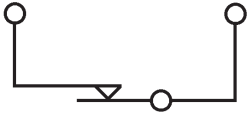

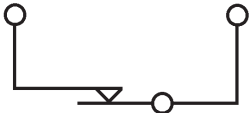
## TEMPERATURE SWITCHES

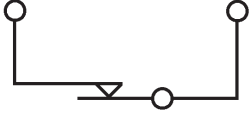



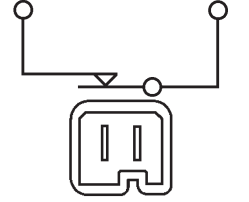

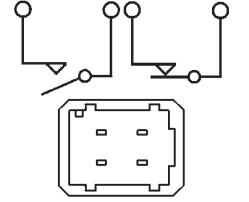

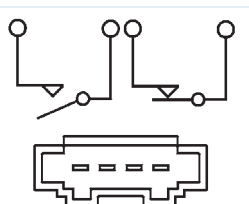
**180945** 7.4000 Temperature Switch Std pkg 1 Servicing: Fiat, Lancia, Seat - Visit [www.hc-cargo.com](http://www.hc-cargo.com) for further information.

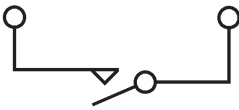
 Thread type: M16-1.5  
 cone  
 Working temp.: 115 °C

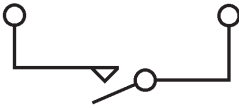
**180949** 7.4007 Temperature Switch Std pkg 1 Servicing: Audi - Visit [www.hc-cargo.com](http://www.hc-cargo.com) for further information.

 Thread type: M10-1  
 Working temp.: 120 °C









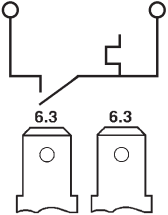

**180950** 7.4014 Temperature Switch Std pkg 1 Servicing: Citroen, Fiat, Ford, Peugeot - Visit [www.hc-cargo.com](http://www.hc-cargo.com) for further information.

 Thread type: M18-1.5  
 Working temp.: 105 °C

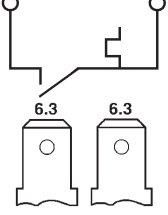

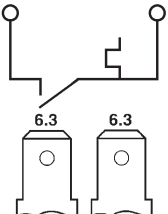

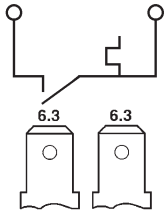

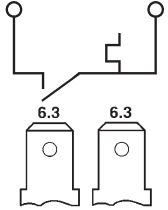



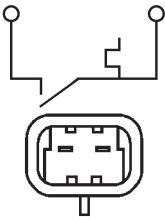

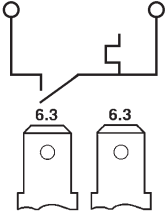
EL. SPECIFICATIONS		DIMENSIONS	ADDITIONAL SPECIFICATIONS
<b>180953</b> 7.4029 Temperature Switch	Std pkg 1	Servicing: Citroen, Ford, Peugeot - Visit <a href="http://www.hc-cargo.com">www.hc-cargo.com</a> for further information.	
			Thread type: M14-1.25 Working temp.: 105 °C
<b>180954</b> 7.4030 Temperature Switch	Std pkg 1	Servicing: Citroen, Ford, Peugeot - Visit <a href="http://www.hc-cargo.com">www.hc-cargo.com</a> for further information.	
			Thread type: M14-1.25 Working temp.: 110 °C
<b>180959</b> 7.4042 Temperature Switch	Std pkg 1	Servicing: Mercedes-Benz - Visit <a href="http://www.hc-cargo.com">www.hc-cargo.com</a> for further information.	
			Thread type: M14-1.5 Working temp.: 110 °C
<b>180963</b> 7.4048 Temperature Switch	Std pkg 1	Servicing: Renault - Visit <a href="http://www.hc-cargo.com">www.hc-cargo.com</a> for further information.	
			Thread type: M14-1.25 Working temp.: 120 °C
<b>180985</b> 7.4079 Temperature Switch	Std pkg 1	Servicing: Alfa Romeo - Visit <a href="http://www.hc-cargo.com">www.hc-cargo.com</a> for further information.	
			Thread type: M14-1.5 Working temp.: 45 °C
<b>180986</b> 7.4080 Temperature Switch	Std pkg 1	Servicing: Seat, VW - Visit <a href="http://www.hc-cargo.com">www.hc-cargo.com</a> for further information.	
			Thread type: M10-1 Working temp.: 120 °C
<b>BRAKE LIGHT SWITCHES</b>			
<b>MECHANICAL</b>			
<b>180008</b> Brake Light Switch	Std pkg 1		
			Type: Mechanical

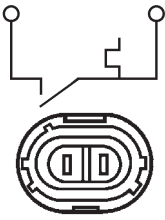
		EL. SPECIFICATIONS	DIMENSIONS	ADDITIONAL SPECIFICATIONS
<b>180009</b>	Brake Light Switch	Std pkg 1		Type: Mechanical
				
<b>180726</b>	7.1000 Brake Light Switch	Std pkg 1	Thread type: M12-1.5	Type: Mechanical
		Servicing: Alfa Romeo, Fiat, Iveco, Lada, Lancia, Polski-Fiat, Seat, Skoda, Zastava - Visit <a href="http://www.hc-cargo.com">www.hc-cargo.com</a> for further information.		
<b>180731</b>	7.1007 Brake Light Switch	Std pkg 1	Thread type: M10-1	Type: Mechanical
		Servicing: Citroen, Peugeot, Talbot - Visit <a href="http://www.hc-cargo.com">www.hc-cargo.com</a> for further information.		
<b>180734</b>	7.1014 Brake Light Switch	Std pkg 1	Thread type: M12-1	Type: Mechanical
		Servicing: BMW, Lada, Mercedes-Benz, Opel, Saab, Volvo - Visit <a href="http://www.hc-cargo.com">www.hc-cargo.com</a> for further information.		
<b>180785</b>	7.1091 Brake Light Switch	Std pkg 1		Type: Mechanical
		Servicing: Citroen, Fiat, Lancia, Peugeot - Visit <a href="http://www.hc-cargo.com">www.hc-cargo.com</a> for further information.		
<b>181367</b>	7.1149 Brake Light Switch	Std pkg 1		Type: Mechanical
		Self-adjustable plunger. Servicing: Nissan, Renault - Visit <a href="http://www.hc-cargo.com">www.hc-cargo.com</a> for further information.		
<b>181369</b>	7.1151 Brake Light Switch	Std pkg 1		Type: Mechanical
		Self-adjustable plunger. Servicing: Audi, Ford, Seat, Skoda, VW - Visit <a href="http://www.hc-cargo.com">www.hc-cargo.com</a> for further information.		

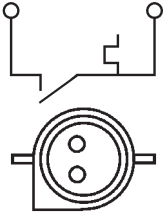

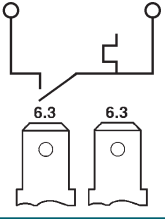

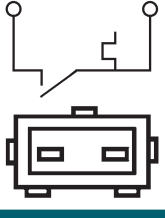

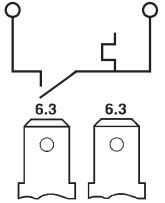

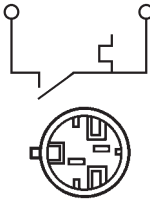

HYDRAULIC			
180790	7.1101 Brake Light Switch	Std pkg 1	Servicing: Austin, Fiat, Ford, Jaguar, MAN, MG - Visit <a href="http://www.hc-cargo.com">www.hc-cargo.com</a> for further information.
			Thread type: 1/8-27 NPT cone Type: Hydraulic
180791	7.1102 Brake Light Switch	Std pkg 1	Servicing: Audi, Porsche, Skoda, VW - Visit <a href="http://www.hc-cargo.com">www.hc-cargo.com</a> for further information.
			Thread type: M10-1 cone Type: Hydraulic
REVERSE LIGHT SWITCHES			
181147	7.6007 Reverse Light Switch	Std pkg 1	Servicing: Ford, VW - Visit <a href="http://www.hc-cargo.com">www.hc-cargo.com</a> for further information.
			Thread type: M14-1.5
181148	7.6009 Reverse Light Switch	Std pkg 1	Servicing: Austin, Rover, Seat, VW - Visit <a href="http://www.hc-cargo.com">www.hc-cargo.com</a> for further information.
			Thread type: M12-1.5
181150	7.6011 Reverse Light Switch	Std pkg 1	Servicing: Opel - Visit <a href="http://www.hc-cargo.com">www.hc-cargo.com</a> for further information.
			Thread type: M12-1.5
181152	7.6015 Reverse Light Switch	Std pkg 1	Servicing: Citroen, Fiat, Peugeot, Renault, Talbot - Visit <a href="http://www.hc-cargo.com">www.hc-cargo.com</a> for further information.
			Thread type: M14-1.5
181156	7.6019 Reverse Light Switch	Std pkg 1	Servicing: Citroen, Fiat, Talbot - Visit <a href="http://www.hc-cargo.com">www.hc-cargo.com</a> for further information.
			Thread type: M12-1

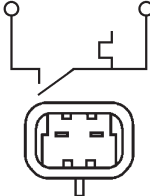
		EL. SPECIFICATIONS	DIMENSIONS	ADDITIONAL SPECIFICATIONS
<b>181158</b>	7.6021 Reverse Light Switch	Std pkg 1	<p>Servicing: Skoda - Visit <a href="http://www.hc-cargo.com">www.hc-cargo.com</a> for further information.</p> <p>Thread type: M14-1</p>	
				
<b>181179</b>	7.6067 Reverse Light Switch	Std pkg 1	<p>Servicing: Alfa Romeo, Fiat, Innocenti, Lancia - Visit <a href="http://www.hc-cargo.com">www.hc-cargo.com</a> for further information.</p> <p>Thread type: M14-1.5</p>	
				
<b>181182</b>	7.6073 Reverse Light Switch	Std pkg 1	<p>Servicing: Alfa Romeo, Chevrolet, Daewoo, Fiat, Lancia, Mercedes-Benz, MG, Mini, Opel, Rover, Saab, Suzuki - Visit <a href="http://www.hc-cargo.com">www.hc-cargo.com</a> for further information.</p> <p>Thread type: M12-1.5</p>	
				
<b>181183</b>	7.6075 Reverse Light Switch	Std pkg 1	<p>Servicing: M45G - Visit <a href="http://www.hc-cargo.com">www.hc-cargo.com</a> for further information.</p> <p>Thread type: M16-2</p>	
				
<b>181191</b>	7.6096 Reverse Light Switch	Std pkg 1	<p>Servicing: DAF, Mercedes-Benz, Mitsubishi, Nissan, Opel, Renault, Volvo - Visit <a href="http://www.hc-cargo.com">www.hc-cargo.com</a> for further information.</p> <p>Thread type: M14-1.5</p>	
				
<b>181194</b>	7.6099 Reverse Light Switch	Std pkg 1	<p>Servicing: Audi, Citroen, Fiat, Lancia, Land Rover, Mini, Nissan, Peugeot, Rover, Skoda, VW - Visit <a href="http://www.hc-cargo.com">www.hc-cargo.com</a> for further information.</p> <p>Thread type: M14-1.5</p>	
				
<b>181197</b>	7.6102 Reverse Light Switch	Std pkg 1	<p>Servicing: Iveco - Visit <a href="http://www.hc-cargo.com">www.hc-cargo.com</a> for further information.</p> <p>Thread type: M27-1 Thread type 2: M18-1.5</p>	
				
<b>181201</b>	7.6108 Reverse Light Switch	Std pkg 1	<p>Servicing: Citroen, Fiat, Peugeot - Visit <a href="http://www.hc-cargo.com">www.hc-cargo.com</a> for further information.</p> <p>Thread type: M14-1.5</p>	
				

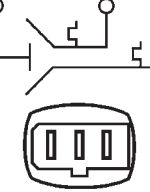
EL. SPECIFICATIONS		DIMENSIONS	ADDITIONAL SPECIFICATIONS
<b>181212</b> 7.6125 Reverse Light Switch	Std pkg 1	Servicing: Rover, Seat, Skoda, VW - Visit <a href="http://www.hc-cargo.com">www.hc-cargo.com</a> for further information.	Thread type: M12-1.5
			
<b>181456</b> 7.6215 Reverse Light Switch	Std pkg 1	Servicing: Audi, Ford, Seat, Skoda, VW - Visit <a href="http://www.hc-cargo.com">www.hc-cargo.com</a> for further information.	Thread type: M12-1.5
			
<b>THERMO SENSOR SWITCHES</b>			
<b>181001</b> 7.5000 Thermo Sensor Switch	Std pkg 1	Servicing: Alfa Romeo, Fiat, Lada, Saab, Seat, Talbot, Zastava - Visit <a href="http://www.hc-cargo.com">www.hc-cargo.com</a> for further information.	Thread type: M22-1.5 Working temp.: 92 °C Working temp. 2: 87 °C
			
<b>181005</b> 7.5004 Thermo Sensor Switch	Std pkg 1	Servicing: Peugeot - Visit <a href="http://www.hc-cargo.com">www.hc-cargo.com</a> for further information.	Thread type: M22-1.5 Working temp.: 82 °C Working temp. 2: 67 °C
			
<b>181008</b> 7.5007 Thermo Sensor Switch	Std pkg 1	Servicing: Citroen, Ford, Peugeot, Renault, Talbot - Visit <a href="http://www.hc-cargo.com">www.hc-cargo.com</a> for further information.	Thread type: M22-1.5 Working temp.: 87 °C Working temp. 2: 77 °C
			
<b>181009</b> 7.5008 Thermo Sensor Switch	Std pkg 1	Servicing: Alfa Romeo, Peugeot, Renault - Visit <a href="http://www.hc-cargo.com">www.hc-cargo.com</a> for further information.	Thread type: M22-1.5 Working temp.: 85 °C Working temp. 2: 75 °C
			
<b>181015</b> 7.5018 Thermo Sensor Switch	Std pkg 1	Servicing: Citroen - Visit <a href="http://www.hc-cargo.com">www.hc-cargo.com</a> for further information.	Thread type: M22-1.5 Working temp.: 86 °C Working temp. 2: 81 °C
			

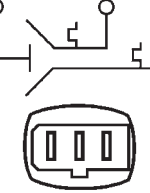
EL. SPECIFICATIONS		DIMENSIONS	ADDITIONAL SPECIFICATIONS
<b>181021</b> 7.5031 Thermo Sensor Switch Std pkg 1 Servicing: Alfa Romeo, Fiat, Innocenti, Iveco, Lancia - Visit <a href="http://www.hc-cargo.com">www.hc-cargo.com</a> for further information.			
			Thread type: M22-1.5 Working temp.: 92 °C Working temp. 2: 87 °C
<b>181034</b> 7.5063 Thermo Sensor Switch Std pkg 1 Servicing: BMW, Opel, Volvo - Visit <a href="http://www.hc-cargo.com">www.hc-cargo.com</a> for further information.			
			Thread type: M14-1.5 Working temp.: 95 °C Working temp. 2: 90 °C
<b>181064</b> 7.5128 Thermo Sensor Switch Std pkg 1 Servicing: Ford, Mercedes-Benz, Opel, Renault - Visit <a href="http://www.hc-cargo.com">www.hc-cargo.com</a> for further information.			
			Thread type: M22-1.5 Working temp.: 92 °C Working temp. 2: 82 °C
<b>181065</b> 7.5129 Thermo Sensor Switch Std pkg 1 Servicing: Ford, Renault - Visit <a href="http://www.hc-cargo.com">www.hc-cargo.com</a> for further information. <i>Replacing original grey switch.</i>			
			Thread type: M22-1.5 Working temp.: 92 °C Working temp. 2: 87 °C
<b>181073</b> 7.5142 Thermo Sensor Switch Std pkg 1 Servicing: Volvo - Visit <a href="http://www.hc-cargo.com">www.hc-cargo.com</a> for further information.			
			Thread type: M14-1.5 Working temp.: 72 °C Working temp. 2: 67 °C
<b>181076</b> 7.5145 Thermo Sensor Switch Std pkg 1 Servicing: Citroen, Fiat, Lancia, Opel, Peugeot - Visit <a href="http://www.hc-cargo.com">www.hc-cargo.com</a> for further information. <i>Replacing original switch w/ yellow ring.</i>			
			Thread type: M22-1.5 Working temp.: 97 °C Working temp. 2: 92 °C
<b>181077</b> 7.5146 Thermo Sensor Switch Std pkg 1 Servicing: Volvo - Visit <a href="http://www.hc-cargo.com">www.hc-cargo.com</a> for further information.			
			Thread type: M14-1.5 Working temp.: 87 °C Working temp. 2: 82 °C



EL. SPECIFICATIONS		DIMENSIONS	ADDITIONAL SPECIFICATIONS
<b>181088</b> 7.5182 Thermo Sensor Switch Std pkg 1 Servicing: Mercedes-Benz, Opel, Vauxhall - Visit <a href="http://www.hc-cargo.com">www.hc-cargo.com</a> for further information.			
			Thread type: M22-1.5 Working temp.: 100 °C Working temp. 2: 95 °C
<b>181089</b> 7.5187 Thermo Sensor Switch Std pkg 1 Servicing: Citroen, Fiat, Iveco, Lancia, Peugeot - Visit <a href="http://www.hc-cargo.com">www.hc-cargo.com</a> for further information.			
			Thread type: M22-1.5 Working temp.: 92 °C Working temp. 2: 87 °C
<b>DOUBLE FAN OR TWO SPEED MOTORS</b>			
<b>181121</b> 7.5626 Thermo Sensor Switch Std pkg 1 Servicing: Audi, VW - Visit <a href="http://www.hc-cargo.com">www.hc-cargo.com</a> for further information.			
			Thread type: M22-1.5 Working temp.: 87-77 °C Working temp. 2: 92-82 °C Double fan: Yes 2 speed: Yes
<b>181126</b> 7.5635 Thermo Sensor Switch Std pkg 1 Servicing: Audi, Opel, Seat, Skoda, VW - Visit <a href="http://www.hc-cargo.com">www.hc-cargo.com</a> for further information.			
			Thread type: M22-1.5 Working temp.: 95-85 °C Working temp. 2: 102-92 °C Double fan: Yes 2 speed: Yes
<b>SENSORS</b>			
<b>TEMPERATURE SENSORS</b>			
<b>WATER</b>			
<b>160786</b> Temp. Transmitter Std pkg 1 Servicing: HC-CARGO 160699, 160778			
		Voltage: 12-24	Thread type: 1/8 NPTF
<b>180804</b> 7.3000 Temperature Sensor Std pkg 1			
<i>For water.</i>			
			Thread type: M16-1.5 cone
<b>180808</b> 7.3005 Temperature Sensor Std pkg 1			
<i>For water.</i>			
			Thread type: 1/8-27 NPT cone

**180820** 7.3028 Temperature Sensor Std pkg 1

Replace original yellow sensor. For water.

 Thread type: 1/8-27  
NPT cone

**180839** 7.3073 Temperature Sensor Std pkg 1

For water.



Thread type: M10-1

**180848** 7.3086 Temperature Sensor Std pkg 1

Replacing original black sensor. For water.

**180883** 7.3146 Temperature Sensor Std pkg 1

Replacing original black and yellow sensor. For water.

**180893** 7.3165 Temperature Sensor Std pkg 1

Replacing original black sensor. For water.

 Thread type: 1/8-27  
NPT

**181400** 7.3258 Temperature Sensor Std pkg 1

Replace original green sensor. For water.

**ENGINE**
**180861** 7.3101 Temperature Sensor Std pkg 1

Replacing original blue sensor. For engine.



Thread type: M16-1

**180875** 7.3128 Temperature Sensor Std pkg 1

*Replacing original blue sensor. For engine.*



Thread type: M12-1.5

**180905** 7.3191 Temperature Sensor Std pkg 1

*Replacing original white sensor. For engine.*



Thread type: M12-1.5

**181373** 7.3308 Temperature Sensor Std pkg 1

*For motor.*



Thread type: M14-1.25

**181395** 7.3239 Temperature Sensor Std pkg 1

*For motor.*



Thread type: M12-1.5

**OIL PRESSURE SENSORS**

**160787** Oil Pressure Sensor Std pkg 1

Servicing: HC-CARGO 160700, 160779



Voltage: 12-24

Thread type: 1/8 NPTF

**TIMING SENSORS**

**CRANKSHAFTS**

**150340** Crankshaft Position Sensor Std pkg 1



Ohm: 240

**150354** Crankshaft Position Sensor Std pkg 1



Ohm: 530

		EL. SPECIFICATIONS	DIMENSIONS	ADDITIONAL SPECIFICATIONS
<b>150404</b>	Crankshaft Position Sensor Std pkg 1	Ohm: 250		
				
<b>150414</b>	Crankshaft Position Sensor Std pkg 1	Ohm: 250		
				
<b>150451</b>	Crankshaft Position Sensor Std pkg 1	Ohm: 900		
				
<b>150468</b>	Crankshaft Position Sensor Std pkg 1	Ohm: 900	Sensor dia.: 20.2 mm	Plug: w/
				
<b>150470</b>	Crankshaft Position Sensor Std pkg 1	Ohm: 900		
				
<b>CAMSHAFTS</b>				
<b>150496</b>	Camshaft Position Sensor Std pkg 1	Servicing: Volvo, Renault - Visit <a href="http://www.hc-cargo.com">www.hc-cargo.com</a> for further information.		
<i>Hall effect.</i>				
				
<b>LAMBDA SENSORS</b>				
<b>UNIVERSAL</b>				
<b>181584</b>	Universal Lambda Sensor Std pkg 1	Servicing: Audi, BMW, Daewoo, Daihatsu, DeLorean, Fiat, Honda, Hyundai, Jaguar, Kia, Lancia, Lotus, Mazda, Mercedes-Benz - Visit <a href="http://www.hc-cargo.com">www.hc-cargo.com</a> for further information.		
		Sensor dia.: 21 mm Thread type: M18-1.5	Connection: Signal + Type: Universal, Zirconia Colour: Black No./wires: 1 Plug: w/o	

		EL. SPECIFICATIONS	DIMENSIONS	ADDITIONAL SPECIFICATIONS
<b>181585</b>	Universal Lambda Sensor Std pkg 1	<p>Servicing: Alfa Romeo, Audi, Autobianchi, BMW, Chevrolet, Daimler, Ferrari, Fiat, Ford, Hyundai, Isuzu, Jaguar, Kia, Lancia, Mazda - Visit <a href="http://www.hc-cargo.com">www.hc-cargo.com</a> for further information.</p> <p>Watt: 12</p>	<p>Sensor dia.: 21.8 mm Thread type: M18-1.5</p>	<p>Connection: Pre heating +, Pre heating -, Signal + Type: Universal, Zirconia Colour: Black - White - White No./wires: 3 Plug: w/o</p>
<b>181586</b>	Universal Lambda Sensor Std pkg 1	<p>Servicing: BMW, Citroen, Fiat, Jeep, Mazda, Mercedes-Benz, Peugeot, Renault, Seat, Skoda, Volvo, VW - Visit <a href="http://www.hc-cargo.com">www.hc-cargo.com</a> for further information.</p> <p>Watt: 18</p>	<p>Sensor dia.: 21.8 mm Thread type: M18-1.5</p>	<p>Connection: Pre heating +, Pre heating -, Signal +, Signal - Type: Universal, Zirconia Colour: Black - White - White - Grey No./wires: 4 Plug: w/o</p>
<b>181587</b>	Universal Lambda Sensor Std pkg 1	<p>Servicing: Audi, Chrysler, Dodge, Fiat, Jeep, Mercedes-Benz, Nissan, Opel, Saab, Seat, Suzuki, Vauxhall, Volvo, VW - Visit <a href="http://www.hc-cargo.com">www.hc-cargo.com</a> for further information.</p> <p>Watt: 18</p>	<p>Sensor dia.: 21.8 mm Thread type: M18-1.5</p>	<p>Connection: Pre heating +, Pre heating -, Signal + Type: Universal, Zirconia Colour: Black - White - White No./wires: 3 Plug: w/o</p>
<b>181588</b>	Universal Lambda Sensor Std pkg 1	<p>Servicing: Alpina, Audi, Bentley, BMW, Citroen, Daewoo, Ferrari, Ford, Lada, Land Rover, Mazda, Mercedes-Benz, Opel, Peugeot - Visit <a href="http://www.hc-cargo.com">www.hc-cargo.com</a> for further information.</p> <p>Watt: 18</p>	<p>Sensor dia.: 21.8 mm Thread type: M18-1.5</p>	<p>Connection: Pre heating +, Pre heating -, Signal +, Signal - Type: Universal, Zirconia Colour: Black - White - White - Grey No./wires: 4 Plug: w/o</p>
<b>181589</b>	Universal Lambda Sensor Std pkg 1	<p>Servicing: Alfa Romeo, Austin, BMW, Chrysler, Citroen, Ferrari, Fiat, Ford, Honda, Lancia, Land Rover, Mazda, Mercedes-Benz, MG - Visit <a href="http://www.hc-cargo.com">www.hc-cargo.com</a> for further information.</p> <p>Watt: 12</p>	<p>Sensor dia.: 21.8 mm Thread type: M18-1.5</p>	<p>Connection: Pre heating +, Pre heating -, Signal +, Signal - Type: Universal, Zirconia Colour: Black - White - White - Grey No./wires: 4 Plug: w/o</p>
<b>181590</b>	Universal Lambda Sensor Std pkg 1	<p>Servicing: Aston Martin, Audi, BMW, Chevrolet, Chrysler, Citroen, Dacia, Daihatsu, Dodge, Ferrari, Fiat, Ford, Honda, Hyundai - Visit <a href="http://www.hc-cargo.com">www.hc-cargo.com</a> for further information.</p> <p>Watt: 12</p>	<p>Sensor dia.: 21.8 mm Thread type: M18-1.5</p>	<p>Connection: Pre heating +, Pre heating -, Signal +, Signal - Type: Universal, Zirconia Colour: Black - White - White - Grey No./wires: 4 Plug: w/o</p>
<b>181591</b>	Universal Lambda Sensor Std pkg 1	<p>Servicing: Alfa Romeo, Audi, Bentley, BMW, Cadillac, Chevrolet, Citroen, Daewoo, Daihatsu, Fiat, Ford, Honda, Hyundai, Jeep, Kia - Visit <a href="http://www.hc-cargo.com">www.hc-cargo.com</a> for further information.</p> <p>Watt: 7</p>	<p>Sensor dia.: 17.6 mm Thread type: M18-1.5</p>	<p>Connection: Pre heating +, Pre heating -, Signal +, Signal - Type: Universal, Titania Colour: Black - White - White - Grey No./wires: 4 Plug: w/o</p>

		EL. SPECIFICATIONS	DIMENSIONS	ADDITIONAL SPECIFICATIONS
<b>181592</b>	Universal Lambda Sensor	Std pkg 1	Servicing: Alfa Romeo, Audi, Cadillac, Chrysler, Citroen, Dacia, Ferrari, Fiat, Ford, Honda, Lancia, Land Rover, Mercedes-Benz, MG - Visit <a href="http://www.hc-cargo.com">www.hc-cargo.com</a> for further information.	
		Watt: 7	Sensor dia.: 17.6 mm Thread type: M18-1.5	Connection: Pre heating +, Pre heating -, Signal +, Signal - Type: Universal, Titania Colour: Black - White - White - Grey No./wires: 4 Plug: w/o

## ACCESSORIES

<b>180526</b>	Gasket/Flange	Std pkg 1	ID/threaded hole: M18	
				

## AIR MASS METERS

<b>181491</b>	Air Mass Sensor	Std pkg 1	Servicing: Audi, Ford, Seat, Skoda, VW - Visit <a href="http://www.hc-cargo.com">www.hc-cargo.com</a> for further information.	
				
<b>181494</b>	Air Mass Sensor	Std pkg 1	Servicing: GM, VW, Alfa Romeo, Fiat, Lancia, Opel, Vauxhall - Visit <a href="http://www.hc-cargo.com">www.hc-cargo.com</a> for further information.	
				
<b>181495</b>	Air Mass Sensor	Std pkg 1	Servicing: Toyota, GM, Alfa Romeo, Ferrari, Fiat, Honda, Lada, Lancia, Opel, Rover, Vauxhall, Volvo - Visit <a href="http://www.hc-cargo.com">www.hc-cargo.com</a> for further information.	
				
<b>181500</b>	Air Mass Sensor	Std pkg 1	Servicing: Landrover, Daewoo, Ssang Yong, BMW, Mercedes-Benz - Visit <a href="http://www.hc-cargo.com">www.hc-cargo.com</a> for further information.	
				



# Assortments

Edition 2016/2017

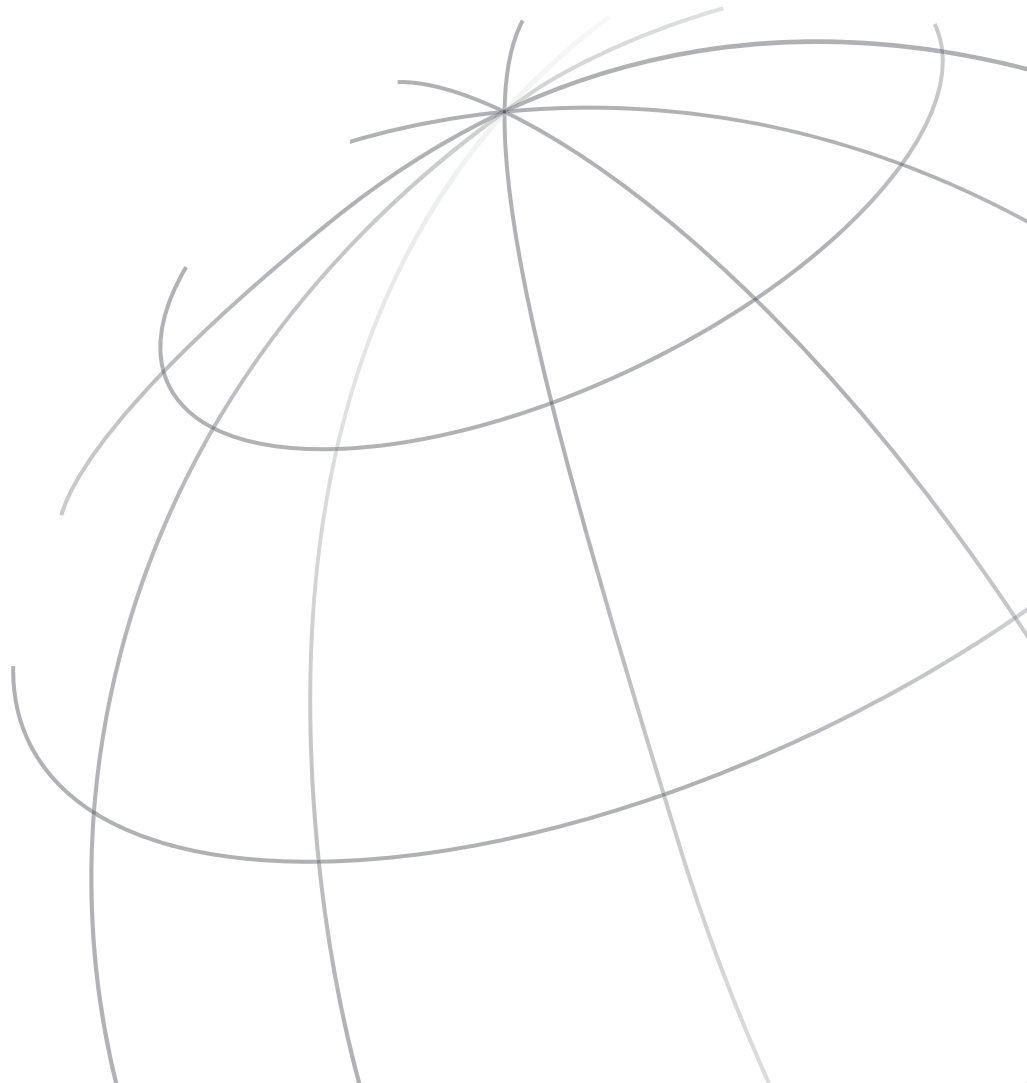

**Thermal Washers**
**806011**

	Qty.		Qty.		
080296	Thermal washers, copper.....	10	080440	Thermal washers, copper.....	10
080424	Thermal washers, copper.....	10	080441	Thermal washers, copper.....	10
080425	Thermal washers, copper.....	10	080442	Thermal washers, copper.....	10
080426	Thermal washers, copper.....	10	080443	Thermal washers, copper.....	10
080427	Thermal washers, copper.....	10	080444	Thermal washers, copper.....	10
080428	Thermal washers, copper.....	10	080446	Thermal washers, copper.....	10
080430	Thermal washers, copper.....	10	080447	Thermal washers, copper.....	10
080431	Thermal washers, copper.....	10	080448	Thermal washers, copper.....	10
080432	Thermal washers, copper.....	10	080449	Thermal washers, steel/asbestos	10
080433	Thermal washers, copper.....	10	080450	Thermal washers, copper.....	10
080434	Thermal washers, copper.....	10	080452	Thermal washers, copper.....	10
080435	Thermal washers, copper.....	10	080453	Thermal washers, copper.....	10
080436	Thermal washers, copper.....	10	080454	Thermal washers, copper.....	10
080437	Thermal washers, aluminium .	10	080456	Thermal washers, copper.....	10
080438	Thermal washers, copper.....	10	080688	Thermal washers, copper.....	10
080439	Thermal washers, copper.....	10	081115	Thermal washers, copper.....	10

**Ring Nipples & Hose Sleeves**
**806015**

	Qty.		Qty.		
080237	Ring nipples.....	5	080263	Hose sleeves.....	10
080238	Ring nipples.....	5	080264	Hose sleeves.....	10
080239	Ring nipples.....	5	080265	Hose sleeves.....	10
080240	Ring nipples.....	5			
080241	Ring nipples.....	5			
080242	Ring nipples.....	5			
080243	Ring nipples.....	5			
080245	Double hose nipples.....	5			
080246	Double hose nipples.....	5			
080247	Double hose nipples.....	5			
080259	Hose sleeves.....	10			
080260	Hose sleeves.....	10			
080261	Hose sleeves.....	10			
080262	Hose sleeves.....	10			

**Hollow Screws & Hose Nipples**
**806020**

	Qty.		Qty.		
080003	Hose nipples.....	3	080255	Hollow screws.....	10
080237	Hose nipples.....	3	080256	Hollow screws.....	10
080238	Hose nipples.....	3	080257	Double hollow screws.....	10
080239	Hose nipples.....	3	080258	Double hollow screws.....	10
080240	Hose nipples.....	3			
080241	Hose nipples.....	3			
080242	Hose nipples.....	3			
080243	Hose nipples.....	3			
080246	Double hose nipples.....	3			
080247	Double hose nipples.....	3			
080251	Hollow screws.....	5			
080252	Hollow screws.....	5			
080253	Hollow screws.....	5			
080254	Hollow screws.....	5			

**Glow Plugs**
**806030**

	Qty.	
100261	Glow plug.....	4
100335	Glow plug.....	4
100515	Glow plug.....	4
100527	Glow plug.....	4
100531	Glow plug.....	4
100532	Glow plug.....	4
100537	Glow plug.....	4
100538	Glow plug.....	4
100545	Glow plug.....	4
100555	Glow plug.....	4
100557	Glow plug.....	4
100563	Glow plug.....	4
100592	Glow plug.....	4
100593	Glow plug.....	4







# Workshop Consumables

Edition 2016/2017



## CRIMP TERMINALS

### INSULATED

**RED**  
0.25-1.6 mm<sup>2</sup>

**BLUE**  
1-2.6 mm<sup>2</sup>

**YELLOW**  
2.6-6.6 mm<sup>2</sup>

### FEMALE SPADE



HC-CARGO	Std pkg	Type	ID	Colour
190049	Pkg. 100	2.8 mm	1.7 mm	Red
192795	Pkg. 100	2.8 mm	2.3 mm	Blue
192825	Pkg. 100	4.5 x 0.5 mm	2.3 mm	Blue
190045	Pkg. 100	4.7 mm	1.7 mm	Red
190024	Pkg. 50	6.3 mm	1.7 mm	Yellow
190022	Pkg. 100	6.3 mm	1.7 mm	Red
190020	Pkg. 100	6.3 mm	2.3 mm	Blue
190041	Pkg. 100	8 mm	2.3 mm	Blue
190048	Pkg. 50	9.5 mm	3.4 mm	Yellow

### FULLY INSULATED



HC-CARGO	Std pkg	Type	ID	Colour
192226	Pkg. 100	4.7 mm	1.7 mm	Red
190985	Pkg. 100	6.3 mm	1.7 mm	Red
190046	Pkg. 100	6.3 mm	2.3 mm	Blue
192036	Pkg. 50	6.3 mm	3.4 mm	Yellow

### FEMALE SPADE & PIGGY BACK SPADE



HC-CARGO	Std pkg	Type	ID	Colour
190025	Pkg. 100	6.3 mm	1.7 mm	Red
190026	Pkg. 100	6.3 mm	2.3 mm	Blue

### SPADE



HC-CARGO	Std pkg	Width	ID	Colour
192449	Pkg. 100	2.8 mm	1.7 mm	Red
190019	Pkg. 100	6.3 mm	1.7 mm	Red
190016	Pkg. 100	6.3 mm	2.3 mm	Blue
191191	Pkg. 50	6.3 mm	3.4 mm	Yellow

### FEMALE BULLET







HC-CARGO	Std pkg	Width	ID	Colour
190017	Pkg. 100	3.9 mm	1.7 mm	Red
190018	Pkg. 100	4.9 mm	2.3 mm	Blue
190050	Pkg. 50	4.9 mm	3.4 mm	Yellow

### MALE BULLET



HC-CARGO	Std pkg	Width	ID	Colour
190021	Pkg. 100	4 mm	1.7 mm	Red
190023	Pkg. 100	5 mm	2.3 mm	Blue
190051	Pkg. 50	5 mm	3.4 mm	Yellow

BUTT CONNECTOR					
	HC-CARGO	Std pkg	Width	ID	Colour
	190028	Pkg. 100	4.1 mm	1.7 mm	Red
	190001	Pkg. 100	4.8 mm	2.3 mm	Blue
	190030	Pkg. 50	6.7 mm	3.4 mm	Yellow
RING					
	HC-CARGO	Std pkg	Bolt size	ID	Colour
	190038	Pkg. 100	3 mm	1.7 mm	Red
	190257	Pkg. 100	3 mm	2.3 mm	Blue
	190027	Pkg. 100	4 mm	1.7 mm	Red
	190029	Pkg. 100	4 mm	2.3 mm	Blue
	190031	Pkg. 100	5 mm	1.7 mm	Red
	190032	Pkg. 100	5 mm	2.3 mm	Blue
	190033	Pkg. 50	5 mm	3.5 mm	Yellow
	190015	Pkg. 100	6 mm	1.7 mm	Red
	190034	Pkg. 100	6 mm	2.3 mm	Blue
	190035	Pkg. 50	6 mm	3.5 mm	Yellow
	192352	Pkg. 100	8 mm	1.7 mm	Red
	190039	Pkg. 100	8 mm	2.3 mm	Blue
	190255	Pkg. 50	8 mm	3.5 mm	Yellow
	192353	Pkg. 100	10 mm	1.7 mm	Red
	192354	Pkg. 100	10 mm	2.3 mm	Blue
190042	Pkg. 50	10 mm	3.5 mm	Yellow	
191515	Pkg. 50	12 mm	3.5 mm	Yellow	
FORK					
	HC-CARGO	Std pkg	Type	ID	Colour
	191501	Pkg. 100	2 mm	3.5 mm	Red
	190973	Pkg. 100	4 mm	3.7 mm	Red
	191067	Pkg. 100	4 mm	4.9 mm	Blue
	190037	Pkg. 100	5.3 mm	2.3 mm	Blue
	192142	Pkg. 50	6.4 mm	3.4 mm	Yellow
	192950	Pkg. 100	8.3 mm	3.5 mm	Yellow
FORK W/ FLANGE					
	HC-CARGO	Std pkg	Width	ID	Colour
	192371	Pkg. 100	5 mm	2.3 mm	Blue
PIN					
	HC-CARGO	Std pkg	Width	ID	Colour
	190974	Pkg. 100	1.9 mm	1.7 mm	Red
	190952	Pkg. 100	1.9 mm	2.3 mm	Blue
	190953	Pkg. 50	2.8 mm	3.4 mm	Yellow

## TERMINATORS HEAT-SHRINKABLE W/SOLDER

### FEMALE SPADE, FULLY INSULATED

	HC-CARGO	Std pkg	Width	Crimp temp.	Temp. area	Colour
	193244	Pkg. 25	3.2 mm	150 °C	10-105 °C	Red
	193245	Pkg. 25	5 mm	150 °C	10-105 °C	Red
	191697	Pkg. 25	6.6 mm	150 °C	10-105 °C	Red
	191698	Pkg. 25	6.6 mm	150 °C	10-105 °C	Blue

### MALE SPADE

	HC-CARGO	Std pkg	Width	Crimp temp.	Temp. area	Colour
	191700	Pkg. 25	6.3 mm	150 °C	10-105 °C	Blue
	191699	Pkg. 25	6.3 mm	150 °C	10-105 °C	Red

### BUTT CONNECTOR

	HC-CARGO	Std pkg	Width	Crimp temp.	Temp. area	Colour
	192929	Pkg. 100	5.4 mm	min. +85 °C	-55 - +125 °C	Red
	192930	Pkg. 100	6.7 mm	min. +85 °C	-55 - +125 °C	Blue
	191010	Pkg. 100	6.9 mm	min. +85 °C	-55 - +125 °C	Blue
	191009	Pkg. 100	6 mm	min. +85 °C	-55 - +125 °C	Red
	192931	Pkg. 100	7.9 mm	min. +85 °C	-55 - +125 °C	Yellow
	191011	Pkg. 100	8.6 mm	min. +85 °C	-55 - +125 °C	Yellow

### RING

	HC-CARGO	Std pkg	Type	Crimp temp.	Temp. area	Colour
	191682	Pkg. 25	4.2 mm	150 °C	10-105 °C	Red
	191685	Pkg. 25	4.2 mm	150 °C	10-105 °C	Blue
	191683	Pkg. 25	5.2 mm	150 °C	10-105 °C	Red
	191686	Pkg. 25	5.2 mm	150 °C	10-105 °C	Blue
	191689	Pkg. 25	5.2 mm	150 °C	10-105 °C	Yellow
	191690	Pkg. 25	6.3 mm	150 °C	10-105 °C	Yellow
	191684	Pkg. 25	6.4 mm	150 °C	10-105 °C	Red
	191687	Pkg. 25	6.5 mm	150 °C	10-105 °C	Blue
	191688	Pkg. 25	8.5 mm	150 °C	10-105 °C	Blue
	191691	Pkg. 25	8.5 mm	150 °C	10-105 °C	Yellow
	193246	Pkg. 25	10.5 mm	150 °C	10-105 °C	Blue
	191692	Pkg. 25	10.5 mm	150 °C	10-105 °C	Yellow

### FORK

	HC-CARGO	Std pkg	Type	Crimp temp.	Temp. area	Colour
	191694	Pkg. 25	4.2 mm	150 °C	10-105 °C	Blue
	191693	Pkg. 25	4.2 mm	150 °C	10-105 °C	Red
	191696	Pkg. 25	5.2 mm	150 °C	10-105 °C	Yellow
	191695	Pkg. 25	5.2 mm	150 °C	10-105 °C	Blue

### FEMALE BULLET

	HC-CARGO	Std pkg	Width	Crimp temp.	Temp. area	Colour
	193248	Pkg. 25	4 mm	min. +85 °C	-55 - +125 °C	Red
	193247	Pkg. 25	5 mm	min. +85 °C	-55 - +125 °C	Blue

## HEAT-SHRINCABLE W/GLUE

### SOLDER SLEEVE

	HC-CARGO	Std pkg	OD/ cable	Crimp temp.	Temp. area	Colour
<i>Solder sleeve wire to wire splicing w/ fluxed solder and heat shrinkable thermoplastic sleeve.</i>						
	193243	Pkg. 25	4.5/6 mm	min. +85 °C	-55 - +125 °C	Yellow/blue
	193242	Pkg. 25	2.7/4.5 mm	min. +85 °C	-55 - +125 °C	Red/Blue
	191702	Pkg. 25	4.5 mm	min. +85 °C	-55 - +125 °C	Blue
	193237	Pkg. 25	1.7 mm	min. +85 °C	-55 - +125 °C	Transparent
	191703	Pkg. 25	6 mm	min. +85 °C	-55 - +125 °C	Yellow
	191701	Pkg. 25	2.7 mm	min. +85 °C	-55 - +125 °C	Red

### MULTIWIRE SPLICE

	HC-CARGO	Std pkg	Cable multicore	Crimp temp.	Temp. area	Colour
<i>Solder grip multiwire splices up to 10 wires of different sizes and can be combined w/ fluxed solder and heat shrinkable thermoplastic sleeve.</i>						
	191704	Pkg. 5	3.1 mm	min. +85 °C	-55 - +125 °C	Green
	191705	Pkg. 5	3.9 mm	min. +85 °C	-55 - +125 °C	Red
	191708	Pkg. 5	3.6 mm	min. +85 °C	-55 - +125 °C	Green
	191707	Pkg. 5	7.15 mm	min. +85 °C	-55 - +125 °C	Yellow
	191706	Pkg. 5	5.35 mm	min. +85 °C	-55 - +125 °C	Blue
	191709	Pkg. 5	5 mm	min. +85 °C	-55 - +125 °C	Red
	191711	Pkg. 5	9.4 mm	min. +85 °C	-55 - +125 °C	Yellow
	191710	Pkg. 5	7.5 mm	min. +85 °C	-55 - +125 °C	Blue
	191713	Pkg. 5	11 mm	min. +85 °C	-55 - +125 °C	Green

## NON INSULATED

### MALE FLAT SPADE

	HC-CARGO	Std pkg	Width	Cable size	Non return tag	Type
	192174	Pkg. 100	0.4x1.5 mm	0.35 mm <sup>2</sup>	w/	Male, Junior Timer
	192089	Pkg. 100	1.5 mm	1-1.5 mm <sup>2</sup>	w/o	Male, Super Seal Connector
	192410	Pkg. 100	1.8 mm	0.5-1.25 mm <sup>2</sup>	w/o	Male, Type 070 M280
	192645	Pkg. 100	2.3 mm	0.5-1.25 mm <sup>2</sup>	w/	Male, TS sealed-serie, Tin plated
	192528	Pkg. 100	2.3 mm	0.5-1.25 mm <sup>2</sup>	w/	Male, MT- serie 090
	192217	Pkg. 50	2.7 mm	0.5-1 mm <sup>2</sup>	w/	Male, Micro Timer II
	192503	Pkg. 100	2.8x0.8 mm	0.5-1 mm <sup>2</sup>	w/	Male, Junior Power Timer
	191681	Pkg. 50	2.8 mm	0.5-1 mm <sup>2</sup>	w/	<i>Universal. For car radio.</i> Male, M280, 46343
	192240	Pkg. 100	2.8 mm	0.5-1.5 mm <sup>2</sup>	w/o	Male, Mark II

	HC-CARGO	Std pkg	Width	Cable size	Non return tag	Type
	192373	Pkg. 50	2.8 mm	1-2.5 mm <sup>2</sup>	w/o	<i>Single Wire Seal: HC-CARGO 192375.</i> Male, Metripack M280
	191807	Pkg. 100	3 mm	1-3 mm <sup>2</sup>	w/	Male, MIC I
	191129	Pkg. 100	4.7 mm	0.5-1.5 mm <sup>2</sup>	w/	Male, Flat, For insulator For multiplug
	192156	Pkg. 100	5 mm	0.5-1 mm <sup>2</sup>	w/	Male, Junior Power Timer
	192157	Pkg. 100	5 mm	1.5-2.5 mm <sup>2</sup>	w/	Male, Junior Power Timer
	191549	Pkg. 100	6.3 mm	0.5-1 mm <sup>2</sup>	w/	Male, Flat, For insulator For multiplug
	192380	Pkg. 50	6.3 mm	0.5-2 mm <sup>2</sup>	w/	Male, Flat, Tin plated Japanese type For insulator For multiplug
	190270	Pkg. 100	6.3 mm	1-2.5 mm <sup>2</sup>	w/	Male, Flat, For insulator For multiplug
	191415	Pkg. 100	6.3 mm	1-2.5 mm <sup>2</sup>	w/o	Male, Flat, Tin plated For insulator
	191028	Pkg. 100	6.3 mm	4-6 mm <sup>2</sup>	w/	Male, Flat, Tin plated For insulator For multiplug

## FEMALE SPADE



	HC-CARGO	Std pkg	Width	Cable size	Non return tag	Type
	192786	Pkg. 100	1 mm	0.3-0.5 mm <sup>2</sup>	w/o	Female, Type 040, Tin plated
	192090	Pkg. 100	1.5 mm	1-1.5 mm <sup>2</sup>	w/o	Female, Super Seal Connector
	192646	Pkg. 100	2.3 mm	0.5-1.25 mm <sup>2</sup>	w/	<i>090 terminal.</i> Female, TS sealed-serie
	192529	Pkg. 100	2.3 mm	0.5-1.25 mm <sup>2</sup>	w/	Female, MT- serie 090
	191083	Pkg. 100	2.8 mm	0.5-1 mm <sup>2</sup>	w/	Female, Flat, For multiplug
	192411	Pkg. 100	2.8 mm	0.5-1.25 mm <sup>2</sup>	w/o	Female, Type 070 F280
	192239	Pkg. 100	2.8 mm	0.5-1.5 mm <sup>2</sup>	w/o	<i>For tail lamps.</i> Female, Mark II

	HC-CARGO	Std pkg	Width	Cable size	Non return tag	Type
	192374	Pkg. 50	2.8 mm	1-2.5 mm <sup>2</sup>	w/o	Single Wire Seal: HC-CARGO 192375. Female, Metripack F280
	191806	Pkg. 100	3 mm	1-3 mm <sup>2</sup>	w/	Female, MIC I
	192140	Pkg. 50	3.3 mm	0.5-1 mm <sup>2</sup>	w/	Female, Micro Timer II
	191551	Pkg. 100	4 mm	0.5-1.5 mm <sup>2</sup>	w/	Female, Junior Timer
	192175	Pkg. 100	4.3 mm	0.5-1 mm <sup>2</sup>	w/	Female, Junior Power Timer
	192155	Pkg. 100	4.5 mm	1.5-2.5 mm <sup>2</sup>	w/	Female, Junior Timer
	191089	Pkg. 100	4.8 mm	0.5-1 mm <sup>2</sup>	w/	Female, Flat, Tin plated For multiplug
	192573	Pkg. 100	4.8 mm	0.5-1 mm <sup>2</sup>	w/o	Female, Flat, Tin plated For insulator
	192443	Pkg. 100	4.8 mm	0.5-1 mm <sup>2</sup>	w/o	Female, Flat, For insulator
	192998	Pkg. 100	5.3 mm	1.5-2.5 mm <sup>2</sup>	w/	Female, Straight, Tin plated For multiplug
	192986	Pkg. 50	5.5 mm	0.5-1.25 mm <sup>2</sup>	w/	Female, Flat
	192176	Pkg. 100	6 mm	1-2.5 mm <sup>2</sup>	w/	Female, Junior Power Timer
	192772	Pkg. 100	6.3 mm		w/o	PC board
	190868	Pkg. 100	6.3 mm	0.5-1 mm <sup>2</sup>	w/	Female, Flat, For multiplug
	192377	Pkg. 100	6.3 mm	0.5-1 mm <sup>2</sup>	w/	Female, Flat, Tin plated For multiplug
	193238	Pkg. 100	6.3 mm	0.5-1 mm <sup>2</sup>	w/	Female, Flat, For multiplug
	192574	Pkg. 100	6.3 mm	0.5-1 mm <sup>2</sup>	w/o	Female, Flat, Tin plated For insulator
	191246	Pkg. 50	6.3 mm	0.5-1.5 mm <sup>2</sup>	w/o	Female, Positive lock







	HC-CARGO	Std pkg	Width	Cable size	Non return tag	Type
	192381	Pkg. 100	6.3 mm	0.5-2 mm <sup>2</sup>	w/o	Female, Flat, For multiplug, For insulator, Japanese type
	190252	Pkg. 100	6.3 mm	1-2.5 mm <sup>2</sup>	w/	Female, Flat, For multiplug
	191008	Pkg. 100	6.3 mm	1-2.5 mm <sup>2</sup>	w/o	Female, Flat, For insulator
	192376	Pkg. 100	6.3 mm	1-2.5 mm <sup>2</sup>	w/	Female, Flat, Tin plated For multiplug
	191248	Pkg. 50	6.3 mm	1-2.5 mm <sup>2</sup>	w/o	Female, Positive lock
	191064	Pkg. 100	6.3 mm	2.5-6 mm <sup>2</sup>	w/o	Female, Flat, For insulator
	191029	Pkg. 100	6.3 mm	2.5-6 mm <sup>2</sup>	w/	<i>Preformed.</i> Female, Flat, Tin plated For multiplug
	190725	Pkg. 100	6.3 mm	<2.5 mm <sup>2</sup>	w/o	Female, Flat, Tin plated
	191247	Pkg. 50	7.3 mm	2.5-4 mm <sup>2</sup>	w/o	Female, Positive lock
	191260	Pkg. 20	8 mm	1-2.5 mm <sup>2</sup>	w/o	Female, Positive lock, Power connectors
	191200	Pkg. 100	8 mm	1-2.5 mm <sup>2</sup>	w/	Female, Flat, For multiplug
	191261	Pkg. 20	8 mm	4-6 mm <sup>2</sup>	w/o	Female, Positive lock, Power connectors
	191262	Pkg. 20	8 mm	6-10 mm <sup>2</sup>	w/o	Female, Positive lock, Power connectors
	191938	Pkg. 100	9.1 mm	1-2.5 mm <sup>2</sup>	w/	Female, Flat, Tin plated
	191069	Pkg. 100	9.5 mm	2-4 mm <sup>2</sup>	w/o	Female, Flat, For insulator
	191025	Pkg. 100	9.5 mm	2-4 mm <sup>2</sup>	w/	Female, Flat, Tin plated For multiplug
	190726	Pkg. 50	9.5 mm	3-6 mm <sup>2</sup>	w/o	Female, Flat









ADAPTERS						
	HC-CARGO	Std pkg	Width	Cable size	Non return tag	Type
	191082	Pkg. 1		0.5-2.5 mm <sup>2</sup>		Contains: 1x HC-CARGO 191078. 1x HC-CARGO 191079. 1x HC-CARGO 191080. 1x HC-CARGO 191081. Tin plated
	192383	Pkg. 100	7.6 mm	6.3x0.8 mm	w/o	Adaptor, Spade w/piggyback
	192575	Pkg. 50	9.6 mm	6.3x0.8 mm	w/o	Adaptor, Triple, Tin plated
	190256	Pkg. 100	11.4 mm	6.3x0.8 mm	w/o	Adaptor, Spade w/piggyback
LEAF SPRING TERMINALS						
	HC-CARGO	Std pkg	Width	Cable size	Non return tag	Type
	192236	Pkg. 25	6.5 mm	0.5-1 mm <sup>2</sup>	w/	Female, Blade fuse
	192237	Pkg. 25	6.5 mm	1.5-2.5 mm <sup>2</sup>	w/	Female, Blade fuse
TIMER TERMINALS						
	HC-CARGO	Std pkg		Cable size	Non return tag	Type
	191556	Pkg. 100		1-2.5 mm <sup>2</sup>	w/	Female, Standard timer
	192486	Pkg. 10		4-6 mm <sup>2</sup>	w/	Female, Maxi Power Timer
FEMALE BULLET						
	HC-CARGO	Std pkg	Width	Cable size	Non return tag	Type
	191916	Pkg. 100	3.2 mm	0.3-0.9 mm <sup>2</sup>	w/	Mini. Female, Round
	191079	Pkg. 50	3.96 mm	0.5-2 mm <sup>2</sup>		Female, Round, Tin plated
	193250	Pkg. 100	4.1 mm	0.5-2.5 mm <sup>2</sup>	w/	Female, Round
	191075	Pkg. 100	4.2 mm	0.5-1 mm <sup>2</sup>	w/	Female, Round
	191092	Pkg. 100	4.2 mm	0.5-2.1 mm <sup>2</sup>	w/	Female, Round







	HC-CARGO	Std pkg	Width	Cable size	Non return tag	Type
	191544	Pkg. 100	4.2 mm	1-2.5 mm <sup>2</sup>	w/	Female, Round
	191564	Pkg. 100	5.8 mm	0.5-2 mm <sup>2</sup>	w/	Female, Round

### MALE BULLET

	HC-CARGO	Std pkg	Width	Cable size	Non return tag	Type
	191915	Pkg. 100	3.6 mm	0.3-0.9 mm <sup>2</sup>	w/	Male, Round
	191078	Pkg. 50	3.96 mm	0.5-2.5 mm <sup>2</sup>		Male, Round, Tin plated
	191985	Pkg. 50	4 mm	0.7-1.5 mm <sup>2</sup>	w/	Male, Round
	191074	Pkg. 100	4 mm	1-2.5 mm <sup>2</sup>	w/	Male, Round
	191091	Pkg. 100	4.2 mm	0.5-2.1 mm <sup>2</sup>	w/	Male, Round
	191543	Pkg. 100	4.2 mm	1-2.5 mm <sup>2</sup>	w/	Male, Round
	191563	Pkg. 100	6.1 mm	0.5-2 mm <sup>2</sup>	w/	Male, Round

### MALE & FEMALE DEUTSCH





	HC-CARGO	Std pkg	Cable size	Non return tag	Type
	192620	Pkg. 50	0.2-0.5 mm <sup>2</sup>	w/o	Female, Round
	192619	Pkg. 50	0.2-0.5 mm <sup>2</sup>	w/o	Male, Round
	192505	Pkg. 50	0.75-1.25 mm <sup>2</sup>	w/o	DEUTSCH. Male, Round
	192506	Pkg. 50	0.75-1.25 mm <sup>2</sup>	w/o	DEUTSCH. Female, Round
	192477	Pkg. 50	1.25-2 mm <sup>2</sup>	w/o	DEUTSCH. Male, Round
	192478	Pkg. 50	1.25-2 mm <sup>2</sup>	w/o	DEUTSCH. Female, Round

	HC-CARGO	Std pkg	Cable size	Non return tag	Type
	192622	Pkg. 50	2-3 mm <sup>2</sup>	w/o	DEUTSCH. Female, Round
	192621	Pkg. 50	2-3 mm <sup>2</sup>	w/o	DEUTSCH. Male, Round
	193235	Pkg. 1	5-8 mm <sup>2</sup>	w/o	DEUTSCH. Female, Round
	193233	Pkg. 1	5-8 mm <sup>2</sup>	w/o	DEUTSCH. Male, Round
	193234	Pkg. 1	13 mm <sup>2</sup>	w/o	DEUTSCH. Male, Round
	193236	Pkg. 1	13 mm <sup>2</sup>	w/o	DEUTSCH. Female, Round

### WEATHERPROOF CONNECTOR TERMINALS

	HC-CARGO	Std pkg	Cable size	Non return tag	Type
	191168	Pkg. 10	1-2.5 mm <sup>2</sup>	w/o	Female, ABS
	192180	Pkg. 10	1.5-2.5 mm <sup>2</sup>	w/o	Female, ABS, For multiplug
	191171	Pkg. 10	1.5-2.5 mm <sup>2</sup>	w/o	Male, ABS
	191196	Pkg. 10	1.5 mm <sup>2</sup>	w/o	Male, ABS
	191197	Pkg. 10	4 mm <sup>2</sup>	w/o	Male, ABS
	192181	Pkg. 10	4 mm <sup>2</sup>	w/o	Female, ABS, For multiplug
	191172	Pkg. 10	4-6 mm <sup>2</sup>	w/o	Male, ABS
	191169	Pkg. 10	4-6 mm <sup>2</sup>	w/o	Female, ABS



## PINS

	HC-CARGO	Std pkg	Width	Cable size	Non return tag	Type
	191801	Pkg. 100	1.9 mm	1-2.5 mm <sup>2</sup>	w/o	Pin
	191855	Pkg. 100	5.4 mm	2.6-4 mm <sup>2</sup>	w/o	Pin
	192552	Pkg. 100	5.6 mm	2.5-4 mm <sup>2</sup>	w/o	Pin
	193120	Pkg. 100	5.7 mm	4-6 mm <sup>2</sup>	w/o	Pin, Round



## SPRING TERMINALS

	HC-CARGO	Std pkg	Width	Cable size	Non return tag	Type
	191870	Pkg. 100	5.3 mm	1-1.5 mm <sup>2</sup>	w/	<i>Heavy duty. Fuse Holder: HC-CARGO 192759.</i> Female, Blade fuse holder
	191412	Pkg. 100	5.3 mm	1-2.5 mm <sup>2</sup>	w/	<i>Fuse Holder: HC-CARGO 192759.</i> Female, Blade fuse holder
	191871	Pkg. 100	5.3 mm	2.5-4 mm <sup>2</sup>	w/	<i>Heavy duty. Fuse Holder: HC-CARGO 192759.</i> Female, Blade fuse holder
	191411	Pkg. 100	6.3 mm		w/	<i>To be connected w/ 6.3 mm flat tongue terminal. Fuse Holder: HC-CARGO 192759.</i> Female, Blade fuse holder
	191413	Pkg. 100	6.5 mm	2.5-6 mm <sup>2</sup>	w/	<i>Fuse Holder: HC-CARGO 192759.</i> Female, Blade fuse holder
	191872	Pkg. 50	7.5 mm	4-6 mm <sup>2</sup>	w/	<i>Heavy duty. Fuse Holder: HC-CARGO 192759.</i> Female, Blade fuse holder

## FOR POWR-BLOKS

	HC-CARGO	Std pkg	Width	Cable size	Non return tag	Type
	191734	Pkg. 50	8.2 mm	1-2.5 mm <sup>2</sup>	w/o	Female, Powr-bloks
	192758	Pkg. 50	8.2 mm	3.5-5 mm <sup>2</sup>	w/o	<i>Heavy duty.</i> Female, Spring
	191733	Pkg. 50	8.4 mm	1-2.5 mm <sup>2</sup>	w/o	Female, Spring

CRIMP TERMINALS							
	HC-CARGO	Std pkg	Width	Cable size	Non return tag	Type	
	191739	Pkg. 50	2.8 mm	1-2.5 mm <sup>2</sup>	w/o	Female, Powr-bloks	
	191740	Pkg. 50	2.8 mm	2.5-4 mm <sup>2</sup>	w/o	Female, Powr-bloks	
	191737	Pkg. 50	4.7 mm	0.8-1.3 mm <sup>2</sup>	w/o	Female, Powr-bloks	
	191738	Pkg. 50	4.7 mm	2.1-3.3 mm <sup>2</sup>	w/o	Female, Powr-bloks	
	191764	Pkg. 50	6.3 mm	0.5-0.8 mm <sup>2</sup>	w/	Female, Flat	
	191765	Pkg. 50	6.3 mm	1.3-2.1 mm <sup>2</sup>	w/	Female, Flat	
	191766	Pkg. 50	6.3 mm	3.3-5.4 mm <sup>2</sup>	w/	Female, Flat	
	191735	Pkg. 10	9.7 mm	2.1-3.3 mm <sup>2</sup>	w/o	Female, Powr-bloks	

RING TERMINALS							
	HC-CARGO	Std pkg	Width	Cable size	ID	Non return tag	Type
	192003	Pkg. 100	5.3 mm	0.8-2 mm <sup>2</sup>	5.3 mm	w/o	Ring
	191030	Pkg. 100	5.6 mm	0.8-2 mm <sup>2</sup>	4.3 mm	w/o	Ring
	192004	Pkg. 100	6.4 mm	0.8-2.5 mm <sup>2</sup>	6.4 mm	w/o	Ring
	192005	Pkg. 100	7.3 mm	2-4 mm <sup>2</sup>	8.4 mm	w/o	Ring

FLAG RING TERMINALS							
	HC-CARGO	Std pkg	Width	Cable size	ID	Non return tag	Type
	191050	Pkg. 100	10 mm	0.3-1.7 mm <sup>2</sup>	4.3 mm	w/o	Ring, Angled
	191051	Pkg. 100	10 mm	0.3-1.7 mm <sup>2</sup>	5.3 mm	w/o	Ring, Angled
	191856	Pkg. 10	16 mm	10.5-16.8 mm <sup>2</sup>	8.3 mm	w/o	Ring, Angled

## CABLE JOINTS RING

	HC-CARGO	Std pkg	Bolt size	Cable size	Type
	191060	Pkg. 100	M4	0.25-1 mm <sup>2</sup>	Ring, Tin plated
	192134	Pkg. 50	M5	4-6 mm <sup>2</sup>	Ring, Tin plated
	192135	Pkg. 50	M5	10 mm <sup>2</sup>	Ring, Tin plated
	190846	Pkg. 50	M6	4-6 mm <sup>2</sup>	Ring, Tin plated
	190716	Pkg. 10	M6	10 mm <sup>2</sup>	Ring, Tin plated
	190717	Pkg. 10	M6	16 mm <sup>2</sup>	Ring, Tin plated
	191049	Pkg. 10	M8	10 mm <sup>2</sup>	Ring, Tin plated
	190718	Pkg. 10	M8	16 mm <sup>2</sup>	Ring, Tin plated
	190719	Pkg. 10	M8	25 mm <sup>2</sup>	Ring, Tin plated
	191416	Pkg. 10	M8	35 mm <sup>2</sup>	Ring, Tin plated
	192557	Pkg. 10	M10	16 mm <sup>2</sup>	Ring, Tin plated
	190720	Pkg. 10	M10	25 mm <sup>2</sup>	Ring, Tin plated
	190721	Pkg. 10	M10	35 mm <sup>2</sup>	Ring, Tin plated
	190723	Pkg. 10	M10	50 mm <sup>2</sup>	Ring, Tin plated
	190722	Pkg. 10	M8	50 mm <sup>2</sup>	Ring, Tin plated
	192975	Pkg. 100	M3	0.5-1.5 mm <sup>2</sup>	Ring, Tin plated

## CABLE LUGS RING

	HC-CARGO	Std pkg	Bolt size	Cable size	Type
	192905	Pkg. 10	M6	6 mm <sup>2</sup>	Straight, Solder, Tin plated
	192908	Pkg. 10	M6	10 mm <sup>2</sup>	Straight, Single, Tin plated
	192911	Pkg. 10	M6	16 mm <sup>2</sup>	Straight, Solder, Tin plated
	192915	Pkg. 10	M6	25 mm <sup>2</sup>	Straight, Solder, Tin plated
	192919	Pkg. 10	M6	35 mm <sup>2</sup>	Straight, Solder, Tin plated
	192906	Pkg. 10	M8	6 mm <sup>2</sup>	Straight, Solder, Tin plated
	192909	Pkg. 10	M8	10 mm <sup>2</sup>	Straight, Solder, Tin plated
	192912	Pkg. 10	M8	16 mm <sup>2</sup>	Straight, Solder, Tin plated
	192916	Pkg. 10	M8	25 mm <sup>2</sup>	Straight, Solder, Tin plated
	192920	Pkg. 10	M8	35 mm <sup>2</sup>	Straight, Solder, Tin plated
	192923	Pkg. 10	M8	50 mm <sup>2</sup>	Straight, Solder, Tin plated
	192926	Pkg. 10	M8	70 mm <sup>2</sup>	Straight, Solder, Tin plated
	193264	Pkg. 10	M8		Ring, Straight, Tin plated
	192907	Pkg. 10	M10	6 mm <sup>2</sup>	Straight, Solder, Tin plated
	192910	Pkg. 10	M10	10 mm <sup>2</sup>	Straight, Solder, Tin plated
	192913	Pkg. 10	M10	16 mm <sup>2</sup>	Straight, Solder, Tin plated
	192917	Pkg. 10	M10	25 mm <sup>2</sup>	Straight, Solder, Tin plated
	192921	Pkg. 10	M10	35 mm <sup>2</sup>	Straight, Solder, Tin plated
	192924	Pkg. 10	M10	50 mm <sup>2</sup>	Straight, Solder, Tin plated
	192927	Pkg. 10	M10	70 mm <sup>2</sup>	Straight, Solder, Tin plated
	192932	Pkg. 10	M10	95 mm <sup>2</sup>	Ring, Straight, Tin plated
	191884	Pkg. 10	M12	10 mm <sup>2</sup>	Ring, Tin plated
	192914	Pkg. 10	M12	16 mm <sup>2</sup>	Straight, Solder, Tin plated
	192918	Pkg. 10	M12	25 mm <sup>2</sup>	Straight, Solder, Tin plated
	192922	Pkg. 10	M12	35 mm <sup>2</sup>	Straight, Solder, Tin plated
	192925	Pkg. 10	M12	50 mm <sup>2</sup>	Straight, Solder, Tin plated
192928	Pkg. 10	M12	70 mm <sup>2</sup>	Straight, Solder, Tin plated	
192933	Pkg. 10	M12	95 mm <sup>2</sup>	Straight, Single, Tin plated	

## BUTT SPLICES

	HC-CARGO	Std pkg	Cable size	ID	OD	Type
	192007	Pkg. 100	0.5-1.5 mm <sup>2</sup>	1.9 mm	3.3 mm	Tin plated
	192008	Pkg. 100	1.5-2.5 mm <sup>2</sup>	2.3 mm	4 mm	Tin plated
	191885	Pkg. 10	4-6 mm <sup>2</sup>	3.6 mm	5.5 mm	Tin plated
	191886	Pkg. 10	8 mm <sup>2</sup>	5.1 mm	7.1 mm	Tin plated
	191887	Pkg. 10	14 mm <sup>2</sup>	6.4 mm	9 mm	Tin plated
	191888	Pkg. 10	22 mm <sup>2</sup>	8.2 mm	11.4 mm	Tin plated
	191889	Pkg. 10	38 mm <sup>2</sup>	10.1 mm	13.3 mm	Tin plated
	191890	Pkg. 10	60 mm <sup>2</sup>	12 mm	15.4 mm	Tin plated
	191891	Pkg. 10	70 mm <sup>2</sup>	14 mm	17.4 mm	Tin plated
	193168	Pkg. 10	80 mm <sup>2</sup>	14.5 mm	19.5 mm	Tin plated

## CORD END TERMINALS

	HC-CARGO	Std pkg	Cable size	ID	OD	Type
	191962	Pkg. 100	0.5 mm <sup>2</sup>	1 mm	2.1 mm	Tin plated
	191963	Pkg. 100	0.75 mm <sup>2</sup>	1.2 mm	2.3 mm	Tin plated
	191964	Pkg. 100	1 mm <sup>2</sup>	1.4 mm	2.5 mm	Tin plated
	191965	Pkg. 500	1.5 mm <sup>2</sup>	1.7 mm	2.8 mm	Tin plated
	191966	Pkg. 100	2.5 mm <sup>2</sup>	2.2 mm	3.4 mm	Tin plated
	191967	Pkg. 100	4 mm <sup>2</sup>	2.8 mm	4 mm	Tin plated
	191968	Pkg. 100	6 mm <sup>2</sup>	3.5 mm	4.7 mm	Tin plated
	191969	Pkg. 100	10 mm <sup>2</sup>	4.5 mm	5.8 mm	Tin plated
	192047	Pkg. 100	16 mm <sup>2</sup>	5.8 mm	7.5 mm	Tin plated

## IGNITION COIL TERMINALS

	HC-CARGO	Std pkg	OD	Type
	190052	Pkg. 100	7 mm	
	192222	Pkg. 10	7 mm	w/ clip.
	192224	Pkg. 100	7 mm	Angled, 90°
	192225	Pkg. 50	7 mm	Universal.

## FOR POWER CONNECTORS

	HC-CARGO	Std pkg	Width	Cable size	Non return tag	Type
	191263	Pkg. 100	8 mm	2.5x4 mm <sup>2</sup>	w/	Male, Flat, Power connectors
	191983	Pkg. 20	8 mm	4x10 mm <sup>2</sup>	w/	Male, Flat, Power connectors
	191264	Pkg. 20		10x16 mm <sup>2</sup>	w/	Male, Flat, Power connectors

## SCREW TYPE

	HC-CARGO	Std pkg	Width	Cable size	Non return tag	Type
	191016	Pkg. 100	6.3 mm	4.2 mm	w/o	Male, Flat
	192576	Pkg. 100	6.3 mm	4.2 mm	w/o	Male, Flat, Tin plated
	190283	Pkg. 100	6.3 mm	5.2 mm	w/o	Male, Flat
	191047	Pkg. 100	6.3 mm	5.2 mm	w/o	Male, Flat
	191791	Pkg. 100	6.3 mm	6.3 mm	w/o	Male, Flat
	192242	Pkg. 100	6.3 mm	8.4 mm	w/o	Male, Flat
	191044	Pkg. 100	6.3-8 mm	5.2 mm	w/o	Male, Flat, Power connectors
	191048	Pkg. 100	9.5 mm	5.3 mm	w/o	Male, Flat

## TOOLS

### CRIMPING

#### FOR INSULATED TERMINALS

**210121** Crimping Tools Std pkg 1 Servicing: Insulated crimp terminals w/ cable cutter.



Dim.: 0.25-6 mm<sup>2</sup>

**210638** Crimping Tools Std pkg 1 Servicing: Insulated crimp terminals



Dim.: 0.5-6 mm<sup>2</sup>

Type: Insulated

**FOR NON-INSULATED TERMINALS**
**210639** Crimping Tools

Std pkg 1

Servicing: Uninsulated Crimp Terminals

 Dim.: 0.5-6 mm<sup>2</sup>
**210689** Crimping Tools

Std pkg 1

Servicing: Non insulated crimp terminals, suitable for A terminals

 Dim.: 0.25-6 mm<sup>2</sup>
**210696** Crimping Tools

Std pkg 1

Servicing: Uninsulated Crimp Terminals

 Dim.: 1.5-10 mm<sup>2</sup>

Type: ABS

**210760** Crimping Tools

Std pkg 1

Servicing: Suitable for shrink copper tube terminals

 Dim.: 10-95 mm<sup>2</sup>
**210937** Crimping Tools

Std pkg 1

*w/ cable cutter.*

 Dim.: 1.5-6 mm<sup>2</sup>
**210938** Crimping Tools

Std pkg 1

Servicing: For cord end terminals













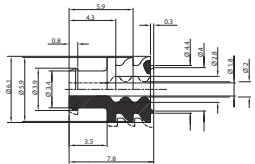

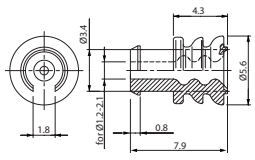
 Dim.: 0.5-6 mm<sup>2</sup>
**210939** Crimping Tools

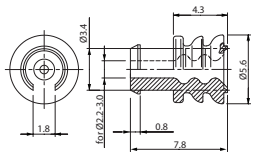
Std pkg 1

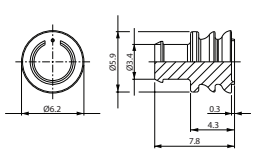
Servicing: For cord end terminals

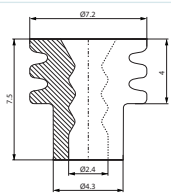

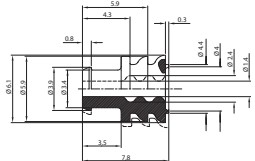
 Dim.: 6-16 mm<sup>2</sup>



		EL. SPECIFICATIONS	DIMENSIONS	ADDITIONAL SPECIFICATIONS
<b>210973</b> Crimping Tools	Std pkg 1	Servicing: Universal crimp tool for solid terminals, DEUTSCH etc		
			Dim.: 0.5-2 mm <sup>2</sup>	
<b>SINGLE WIRE SEAL</b>				
<b>NON INSULATED</b>				
<b>192091</b> Superseal Wire Seal	Std pkg 100	Servicing: HC-CARGO 192077, 192078, 192079, 192080, 192081, 192082, 192083, 192084, 192085, 192086, 192087, 192088, 193266, 193267		
<i>For Super Seal housing.</i>				
			Cable dia.: 1.5-2.5 mm ID: 1.8/2 mm OD: 6.1 mm Length: 7.8 mm	Colour: Red Material: Silicone rubber
<b>192177</b> Wire Seal	Std pkg 100	Servicing: HC-CARGO 192146, 192147, 192148, 192149, 192166, 192167, 1932171, 192172, 192173, 192502, 192884, 192902, 193119		
<i>For Junior-Power-Timer.</i>				
			Cable dia.: 1.2-2.1 mm ID: 1.8 mm OD: 5.6 mm Length: 7.9 mm Height: 5.2 mm	Colour: Light blue Material: Silicone rubber
<b>192178</b> Wire Seal	Std pkg 100	Servicing: HC-CARGO 192146, 192147, 192148, 192149, 192166, 192167, 1932171, 192172, 192173, 192502, 192884, 192902, 193119		
<i>For Junior-Power-Timer.</i>				
			Cable dia.: 1.5-2 mm ID: 1.8 mm OD: 5.6 mm Length: 7.8 mm	Colour: White Material: Silicone rubber
<b>192179</b> JPT Blanking Plug	Std pkg 100	<i>For Junior-Power-Timer housing.</i>		
			Cable dia.: 1.5-2 mm ID: 3.4 mm OD: 6.1 mm Length: 7.8 mm	Colour: Transparent Material: Silicone rubber
<b>192375</b> Single Wire Seal	Std pkg 50	Servicing: HC-CARGO 192374, 192373		
<i>For metripack terminals.</i>				
			Cable dia.: 1-2.5 mm ID: 2.4 mm OD: 7.2 mm Length: 7.5 mm	Colour: Green Material: Silicone rubber
<b>192587</b> Single Wire Seal	Std pkg 100	Servicing: HC-CARGO 192077, 192078, 192079, 192080, 192081, 192082, 192083, 192084, 192085, 192086, 192087, 192088		
<i>For Super Seal housing.</i>				
			Cable dia.: 0.75-1.5 mm ID: 1.4-2.4 mm OD: 6.1 mm Length: 7.8 mm	Colour: Yellow Material: Silicone rubber

**192647** Rubber Silicone Seal Std pkg 100 Servicing: HC-CARGO 192631, 192632, 192633, 192634, 192635, 192636, 192637

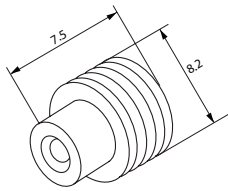
For fuse holder. Hole size: 8.2 mm.

 Cable dia.: 2-3 mm  
 ID: 1.9-3 mm  
 OD: 8.2 mm  
 Length: 7.5 mm

 Colour: White  
 Material: Silicone rubber

**192859** Blanking Plug Std pkg 100

For Super Seal housing.

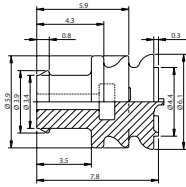
 OD: 6.1 mm  
 Length: 7.8 mm

 Colour: Red  
 Material: Silicone rubber

## TERMINAL COVER

### NON INSULATED

**192808** Terminal Cover Std pkg 10

 Terminal 1: 12 mm  
 Terminal 2: 25.4 mm  
 Cable dia.: 7.62 mm  
 ID: 12.7 mm  
 OD: 14 mm  
 Height: 17.8 mm

 Colour: Black  
 Material: PVC

**192809** Terminal Cover Std pkg 10

 Terminal 1: 14 mm  
 Terminal 2: 25.4 mm  
 Cable dia.: 7.62 mm  
 ID: 12.7 mm  
 OD: 14 mm  
 Height: 19 mm

 Colour: Black  
 Material: PVC

**192810** Terminal Cover Std pkg 10

 Terminal 1: 18 mm  
 Terminal 2: 25.4 mm  
 Cable dia.: 7.62 mm  
 ID: 12.7 mm  
 OD: 18 mm  
 Height: 22.1 mm

 Colour: Black  
 Material: PVC

**192811** Terminal Cover Std pkg 10

 Terminal 1: 20 mm  
 Terminal 2: 33.5 mm  
 Cable dia.: 12.7 mm  
 ID: 17.8 mm  
 OD: 20 mm  
 Height: 24.1 mm

 Colour: Black  
 Material: PVC

**192812** Terminal Cover Std pkg 10

 Terminal 1: 24 mm  
 Terminal 2: 41.2 mm  
 Cable dia.: 12.7 mm  
 ID: 17.8 mm  
 OD: 24 mm  
 Height: 28.7 mm

 Colour: Black  
 Material: PVC

**192813** Terminal Cover Std pkg 10

 Terminal 1: 32 mm  
 Terminal 2: 44.5 mm  
 Cable dia.: 17.8 mm  
 ID: 22.9 mm  
 OD: 32 mm  
 Height: 38.1 mm

 Colour: Black  
 Material: PVC

EL. SPECIFICATIONS		DIMENSIONS	ADDITIONAL SPECIFICATIONS
<b>192828</b> Terminal Cover	Std pkg 10		
		Terminal 1: 12 mm Terminal 2: 25.4 mm Cable dia.: 7.62 mm ID: 12.7 mm OD: 14 mm Height: 17.8 mm	Colour: Red Material: PVC
<b>192829</b> Terminal Cover	Std pkg 10		
		Terminal 1: 14 mm Terminal 2: 25.4 mm Cable dia.: 7.62 mm ID: 12.7 mm OD: 14 mm Height: 19.1 mm	Colour: Red Material: PVC
<b>192830</b> Terminal Cover	Std pkg 10		
		Terminal 1: 18 mm Terminal 2: 25.4 mm Cable dia.: 7.62 mm ID: 12.7 mm OD: 18 mm Height: 22.1 mm	Colour: Red Material: PVC
<b>192831</b> Terminal Cover	Std pkg 10		
		Terminal 1: 20 mm Terminal 2: 33.5 mm Cable dia.: 12.7 mm ID: 17.8 mm OD: 20 mm Height: 24.1 mm	Colour: Red Material: PVC
<b>192832</b> Terminal Cover	Std pkg 10		
		Terminal 1: 24 mm Terminal 2: 41.2 mm Cable dia.: 12.7 mm ID: 17.8 mm OD: 24 mm Height: 28.7 mm	Colour: Red Material: PVC
<b>192833</b> Terminal Cover	Std pkg 10		
		Terminal 1: 32 mm Terminal 2: 44.5 mm Cable dia.: 17.8 mm ID: 22.9 mm OD: 32 mm Height: 38.1 mm	Colour: Red Material: PVC

## MULTIPLE CONNECTORS

### INSULATORS



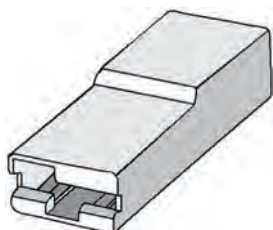

### FEMALE HOLDERS

**191007** Insulator Std pkg 100

Terminal: HC-CARGO 191008, 191064.

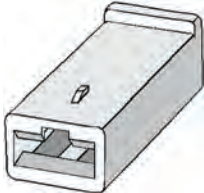
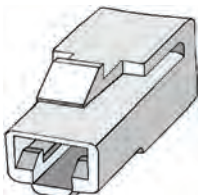

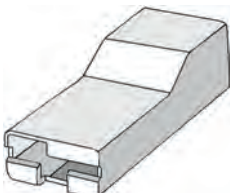
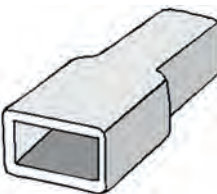
Colour: White  
Male/female: Female

<b>191081</b> Insulator Std pkg 100 Servicing: HC-CARGO 191082 Terminal: HC-CARGO 191079.					Colour: Transparent Male/female: Female
					
<b>191127</b> Insulator Std pkg 100 Terminal: HC-CARGO 190252, 191029.					Colour: White Male/female: Female
					
<b>191227</b> Insulator Std pkg 100 Terminal: HC-CARGO 192381.					Type: Japanese Colour: White Male/female: Female
					
<b>191751</b> Insulator Std pkg 100 Terminal: HC-CARGO 191246, 191247.					Colour: Black Male/female: Female
					
<b>191937</b> Insulator Std pkg 100 Terminal: HC-CARGO 191069.					Colour: White Male/female: Female
					
<b>192442</b> Insulator Std pkg 100 Terminal: HC-CARGO 192443.					Colour: White Male/female: Female
					
<b>MALE HOLDERS</b>					
<b>191080</b> Insulator Std pkg 100 Servicing: HC-CARGO 191082 Terminal: HC-CARGO 191078.					Colour: Transparent Male/female: Male
					

**191126** Insulator Std pkg 100

Terminal: HC-CARGO 190270, 191028.

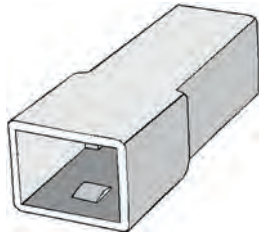

Colour: White  
Male/female: Male

**191226** Insulator Std pkg 10

Terminal: HC-CARGO 192380.

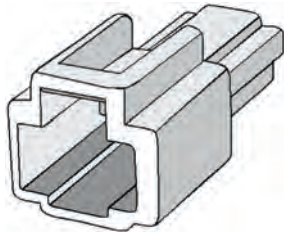

Length: 28.5 mm

Type: Japanese  
Colour: White  
Male/female: Male

**191650** Insulator Std pkg 100

Terminal: HC-CARGO 191415.



Colour: Black  
Male/female: Male

**192002** Insulator Std pkg 100

Terminal: HC-CARGO 192001.

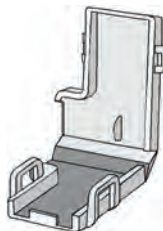

Type: Flag  
Colour: White  
Male/female: Male

**HOLDERS**

**2 POLE**

**190260** Connector Std pkg 10

Terminal: HC-CARGO 190270, 191028.

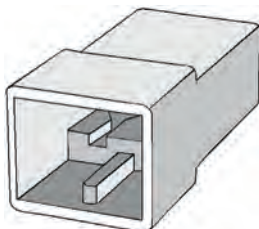

Colour: White  
No./poles: 2  
Plug: Male

**190261** Connector Std pkg 10 Servicing: HC-CARGO 171955

Terminal: HC-CARGO 190252, 191029. Rubber Boot: HC-CARGO 193010.

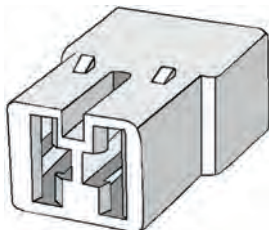

Colour: White  
No./poles: 2  
Plug: Female

**190272** Connector Std pkg 10

Terminal: HC-CARGO 190252, 191029.

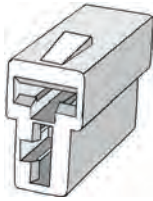
 Type/terminal: T-type  
 Colour: White  
 No./poles: 2  
 Plug: Female

**190843** Connector Std pkg 10

Terminal: HC-CARGO 190270, 191028.

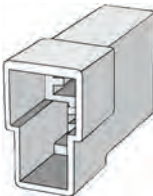
 Type/terminal: T-type  
 Colour: White  
 No./poles: 2  
 Plug: Male

**191158** Connector Std pkg 10

Terminal: HC-CARGO 192380.

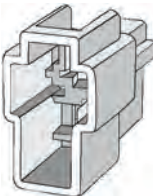
 Type/terminal: Japanese type  
 Colour: White  
 No./poles: 2  
 Plug: Male

**191159** Connector Std pkg 10

Terminal: HC-CARGO 192381.

 Type/terminal: Japanese type  
 Colour: Black  
 No./poles: 2  
 Plug: Female

**191808** Connector Std pkg 10 Servicing: Car Heaters

Terminal: HC-CARGO 191563.

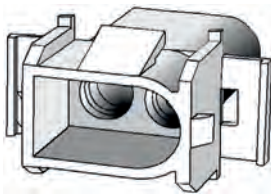
 Colour: White  
 No./poles: 2  
 Plug: Male

**191809** Connector Std pkg 10 Servicing: Car Heaters

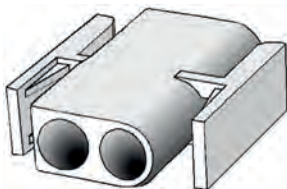

Terminal: HC-CARGO 191564.

 Colour: White  
 No./poles: 2  
 Plug: Female

**3 POLE**
**190262** Connector Std pkg 10

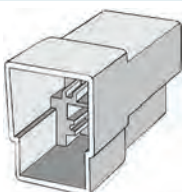
Terminal: HC-CARGO 190270, 191028.

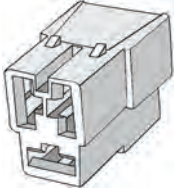
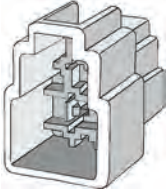
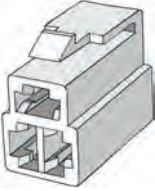
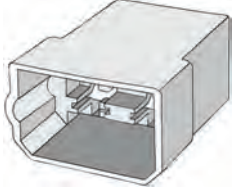
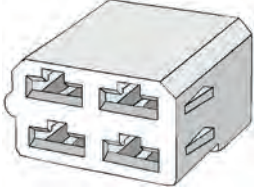
 Colour: White  
 No./poles: 3  
 Plug: Male

<b>190263</b> Connector Std pkg 10 Terminal: HC-CARGO 190252, 191029.			Colour: White No./poles: 3 Plug: Female
			
<b>191224</b> Connector Std pkg 10 Terminal: HC-CARGO 192380.			Type/terminal: Japanese type Colour: White No./poles: 3 Plug: Male
			
<b>191225</b> Connector Std pkg 10 Terminal: HC-CARGO 192376.			Type/terminal: Japanese type Colour: White No./poles: 3 Plug: Female
			
<b>4 POLE</b>			
<b>190264</b> Connector Std pkg 10 Terminal: HC-CARGO 190270, 191028.			Colour: White Material: Nylon 6.6 UL94-V2 No./poles: 4 Plug: Male
			
<b>190265</b> Connector Std pkg 10 Terminal: HC-CARGO 190252, 191029.			Colour: White Material: Nylon 6.6 UL94-V2 No./poles: 4 Plug: Female
			
<b>191070</b> Connector Std pkg 10 Terminal: HC-CARGO 191074.			Colour: White No./poles: 4 Plug: Male
			
<b>191071</b> Connector Std pkg 10 Terminal: HC-CARGO 191075.			Colour: White No./poles: 4 Plug: Female
			

**6 POLE**
**190266** Connector Std pkg 10

Terminal: HC-CARGO 190270, 191028.

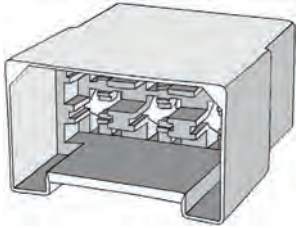
 Colour: White  
 No./poles: 6  
 Plug: Male

**190267** Connector Std pkg 10

Terminal: HC-CARGO 190252, 191029.

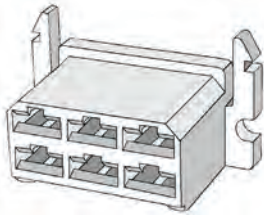
 Colour: White  
 No./poles: 6  
 Plug: Female

**8 POLE**
**190268** Connector Std pkg 10

Terminal: HC-CARGO 190270, 191028.

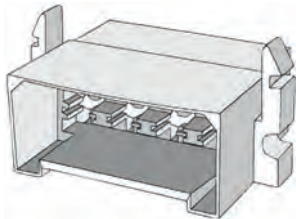
 Colour: White  
 No./poles: 8  
 Plug: Male

**190269** Connector Std pkg 10

Terminal: HC-CARGO 190252, 191029.

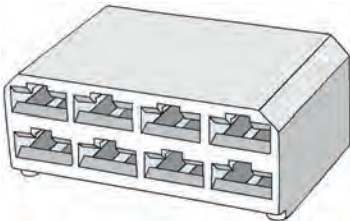
 Colour: White  
 No./poles: 8  
 Plug: Female

**9 POLE**
**191561** Connector Std pkg 10

Terminal: HC-CARGO 191563.

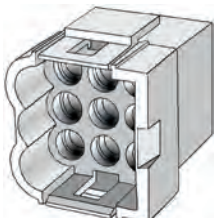
 Colour: White  
 No./poles: 9  
 Plug: Male

**191562** Connector Std pkg 10

Terminal: HC-CARGO 191564.

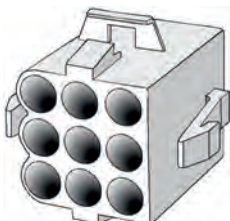

 Colour: White  
 No./poles: 9  
 Plug: Female



## 12 POLE

**192488** Connector Std pkg 10

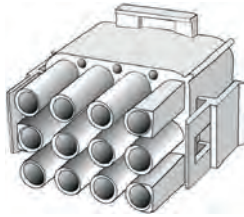
Terminal: HC-CARGO 191092.



Colour: White  
No./poles: 12  
Plug: Male

**192501** Connector Std pkg 10

Terminal: HC-CARGO 191091.

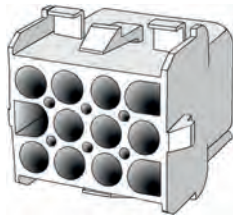

Colour: White  
No./poles: 12  
Plug: Female

## ACCESSORIES

**193010** Rubber Boot Std pkg 10 Servicing: HC-CARGO 190261, 171955



Material: EPDM rubber

## DEUTSCH-CONNECTOR DT

### 2 POLE

**192457** DT Connector Std pkg 5

DT06-2S. Terminal: HC-CARGO 192478. Secondary lock: HC-CARGO 192467. Rubber Boot: HC-CARGO 193092.



Type/terminal: DT  
Colour: Grey  
No./poles: 2  
Plug: Female

**192458** DT Connector Std pkg 5

DT04-2P. Terminal: HC-CARGO 192477. Secondary lock: HC-CARGO 192468. Rubber Boot: HC-CARGO 193091.



Type/terminal: DT  
Colour: Grey  
No./poles: 2  
Plug: Male

## ACCESSORIES



**192467** Secondary Lock Std pkg 10 Servicing: HC-CARGO 192457







W 2S.



Type/terminal: DT  
No./poles: 2  
Plug: Female

<b>192468</b> Secondary Lock      Std pkg 10    Servicing: HC-CARGO 192458 W 2P.				Type/terminal: DT No./poles: 2 Plug: Male
<b>193091</b> Rubber Boot      Std pkg 5    Servicing: HC-CARGO 192458				Type/terminal: DT Colour: Grey No./poles: 2
<b>193092</b> Rubber Boot      Std pkg 5    Servicing: HC-CARGO 192457				Type/terminal: DT Colour: Grey No./poles: 2
<b>3 POLE</b>				
<b>192459</b> DT Connector      Std pkg 5 DT06-3S. Terminal: HC-CARGO 192478. Secondary lock: HC-CARGO 192469. Rubber Boot: HC-CARGO 193094.				Type/terminal: DT Colour: Grey No./poles: 3 Plug: Female
<b>192460</b> DT Connector      Std pkg 5 DT04-3P. Terminal: HC-CARGO 192477. Secondary lock: HC-CARGO 192470. Rubber Boot: HC-CARGO 193093.				Type/terminal: DT Colour: Grey No./poles: 3 Plug: Male
<b>ACCESSORIES</b>				
<b>192469</b> Secondary Lock      Std pkg 10    Servicing: HC-CARGO 192459 W 3S.				Type/terminal: DT No./poles: 3 Plug: Female
<b>192470</b> Secondary Lock      Std pkg 10    Servicing: HC-CARGO 192460 W 3P.				Type/terminal: DT No./poles: 3 Plug: Male

EL. SPECIFICATIONS		DIMENSIONS	ADDITIONAL SPECIFICATIONS
<b>193093</b> Rubber Boot	Std pkg 5	Servicing: HC-CARGO 192460	
			Type/terminal: DT Colour: Grey No./poles: 3
<b>193094</b> Rubber Boot	Std pkg 5	Servicing: HC-CARGO 192459	
			Type/terminal: DT Colour: Grey No./poles: 3
<b>4 POLE</b>			
<b>192461</b> DT Connector	Std pkg 5		
<i>DT06-4S. Terminal: HC-CARGO 192478. Secondary lock: HC-CARGO 192471. Rubber Boot: HC-CARGO 193096.</i>			
			Type/terminal: DT Colour: Grey No./poles: 4 Plug: Female
<b>192462</b> DT Connector	Std pkg 5		
<i>DT04-4P. Terminal: HC-CARGO 192477. Secondary lock: HC-CARGO 192472. Rubber Boot: HC-CARGO 193095.</i>			
			Type/terminal: DT Colour: Grey No./poles: 4 Plug: Male
<b>ACCESSORIES</b>			
<b>192471</b> Secondary Lock	Std pkg 10	Servicing: HC-CARGO 192461	
<i>W 4S.</i>			
			Type/terminal: DT No./poles: 4 Plug: Female
<b>192472</b> Secondary Lock	Std pkg 10	Servicing: HC-CARGO 192462	
<i>W 4P.</i>			
			Type/terminal: DT No./poles: 4 Plug: Male
<b>193095</b> Rubber Boot	Std pkg 5	Servicing: HC-CARGO 192462	
			Type/terminal: DT Colour: Grey No./poles: 4

		EL. SPECIFICATIONS	DIMENSIONS	ADDITIONAL SPECIFICATIONS
<b>193096</b> Rubber Boot	Std pkg 5	Servicing: HC-CARGO 192461		Type/terminal: DT Colour: Grey No./poles: 4
				
<b>6 POLE</b>				
<b>192463</b> DT Connector	Std pkg 5	DT06-6S. Terminal: HC-CARGO 192478. Secondary lock: HC-CARGO 192473. Rubber Boot: HC-CARGO 193098.		Type/terminal: DT Colour: Grey No./poles: 6 Plug: Female
				
<b>192464</b> DT Connector	Std pkg 5	DT04-6P. Terminal: HC-CARGO 192477. Secondary lock: HC-CARGO 192474. Rubber Boot: HC-CARGO 193097.		Type/terminal: DT Colour: Grey No./poles: 6 Plug: Male
				
<b>ACCESSORIES</b>				
<b>192473</b> Secondary Lock	Std pkg 10	Servicing: HC-CARGO 192463		Type/terminal: DT No./poles: 6 Plug: Female
W 6S.				
				
<b>192474</b> Secondary Lock	Std pkg 10	Servicing: HC-CARGO 192464		Type/terminal: DT No./poles: 6 Plug: Male
W 6P.				
				
<b>193097</b> Rubber Boot	Std pkg 5	Servicing: HC-CARGO 192464		Type/terminal: DT Colour: Grey No./poles: 6
				
<b>193098</b> Rubber Boot	Std pkg 5	Servicing: HC-CARGO 192463		Type/terminal: DT Colour: Grey No./poles: 6
				

### 8 POLE

**192465** DT Connector Std pkg 5

*DT06-8S. Terminal: HC-CARGO 192478. Secondary lock: HC-CARGO 192475. Rubber Boot: HC-CARGO 193100.*



Type/terminal: DT  
Colour: Grey  
No./poles: 8  
Plug: Female

**192466** DT Connector Std pkg 5

*DT04-8P. Terminal: HC-CARGO 192477. Secondary lock: HC-CARGO 192476. Rubber Boot: HC-CARGO 193099.*



Type/terminal: DT  
Colour: Grey  
No./poles: 8  
Plug: Male

### ACCESSORIES

**192475** Secondary Lock Std pkg 10 Servicing: HC-CARGO 192465

*W 8S.*



Type/terminal: DT  
No./poles: 8  
Plug: Female

**192476** Secondary Lock Std pkg 10 Servicing: HC-CARGO 192466

*W 8P.*



Type/terminal: DT  
No./poles: 8  
Plug: Male

**193099** Rubber Boot Std pkg 5 Servicing: HC-CARGO 192466



Type/terminal: DT  
Colour: Grey  
No./poles: 8

**193100** Rubber Boot Std pkg 5 Servicing: HC-CARGO 192465



Type/terminal: DT  
Colour: Grey  
No./poles: 8

### 12 POLE

**192450** DT Connector Std pkg 5

*DT06-12S. Terminal: HC-CARGO 192478. Secondary lock: HC-CARGO 192452. Rubber Boot: HC-CARGO 193102.*



Type/terminal: DT  
Colour: Grey  
No./poles: 12  
Plug: Female

**192451** DT Connector Std pkg 5
*DT04-12P. Terminal: HC-CARGO 192477. Secondary lock: HC-CARGO 192453. Rubber Boot: HC-CARGO 193101.*

 Type/terminal: DT  
 Colour: Grey  
 No./poles: 12  
 Plug: Male

**ACCESSORIES**
**192452** Secondary Lock Std pkg 10 Servicing: HC-CARGO 192450
*W 12S.*

 Type/terminal: DT  
 No./poles: 12  
 Plug: Female

**192453** Secondary Lock Std pkg 10 Servicing: HC-CARGO 192451
*W 12P.*

 Type/terminal: DT  
 No./poles: 12  
 Plug: Male

**193101** Rubber Boot Std pkg 5 Servicing: HC-CARGO 192451

 Type/terminal: DT  
 Colour: Grey  
 No./poles: 12

**193102** Rubber Boot Std pkg 5 Servicing: HC-CARGO 192450







 Type/terminal: DT  
 Colour: Grey  
 No./poles: 12



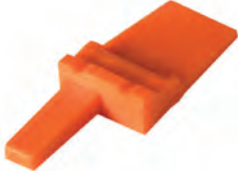



**DEUTSCH-CONNECTOR DTM**
**2 POLE**
**192595** DTM Connector Std pkg 5
*DTM06-2S. Terminal: HC-CARGO 192620. Secondary lock: HC-CARGO 192607. Rubber Boot: HC-CARGO 193104.*

 Type/terminal: DTM  
 Colour: Grey  
 No./poles: 2  
 Plug: Female







**192596** DTM Connector Std pkg 5
*DTM04-2P. Terminal: HC-CARGO 192619. Secondary lock: HC-CARGO 192608. Rubber Boot: HC-CARGO 193103.*







 Type/terminal: DTM  
 Colour: Grey  
 No./poles: 2  
 Plug: Male

ACCESSORIES			
<b>192607</b> Secondary Lock      Std pkg 10    Servicing: HC-CARGO 192595			
WM 2S.			
			Type/terminal: DTM No./poles: 2 Plug: Female
<b>192608</b> Secondary Lock      Std pkg 10    Servicing: HC-CARGO 192596			
WM 2P.			
			Type/terminal: DTM No./poles: 2 Plug: Male
<b>193103</b> Rubber Boot      Std pkg 5    Servicing: HC-CARGO 192596			
			Type/terminal: DTM Colour: Grey No./poles: 2
<b>193104</b> Rubber Boot      Std pkg 5    Servicing: HC-CARGO 192595			
			Type/terminal: DTM Colour: Grey No./poles: 2
<b>3 POLE</b>			
<b>192597</b> DTM Connector      Std pkg 5			
<i>DTM06-3S. Terminal: HC-CARGO 192620. Secondary lock: HC-CARGO 192609. Rubber Boot: HC-CARGO 193106.</i>			
			Type/terminal: DTM Colour: Grey No./poles: 3 Plug: Female
<b>192598</b> DTM Connector      Std pkg 5			
<i>DTM04-3P. Terminal: HC-CARGO 192619. Secondary lock: HC-CARGO 192610. Rubber Boot: HC-CARGO 193105.</i>			
			Type/terminal: DTM Colour: Grey No./poles: 3 Plug: Male
<b>ACCESSORIES</b>			
<b>192609</b> Multiple Connector      Std pkg 10    Servicing: HC-CARGO 192597			
WM 3S.			
			Type/terminal: DTM No./poles: 3 Plug: Female

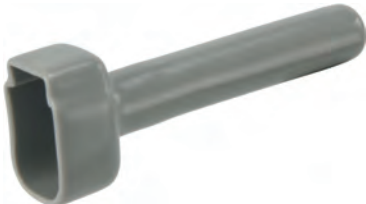
<b>192610</b> Multiple Connector      Std pkg 10      Servicing: HC-CARGO 192598 WM 3P.				Type/terminal: DTM No./poles: 3 Plug: Male
<b>193105</b> Rubber Boot      Std pkg 5      Servicing: HC-CARGO 192598				Type/terminal: DTM Colour: Grey No./poles: 3
<b>193106</b> Rubber Boot      Std pkg 5      Servicing: HC-CARGO 192597				Type/terminal: DTM Colour: Grey No./poles: 3
<b>4 POLE</b>				
<b>192599</b> DTM Connector      Std pkg 5 DTM06-4S. Terminal: HC-CARGO 192620. Secondary lock: HC-CARGO 192611. Rubber Boot: HC-CARGO 193108.				Type/terminal: DTM Colour: Grey No./poles: 4 Plug: Female
<b>192600</b> DTM Connector      Std pkg 5 DTM04-4P. Terminal: HC-CARGO 192619. Secondary lock: HC-CARGO 192612. Rubber Boot: HC-CARGO 193107.				Type/terminal: DTM Colour: Grey No./poles: 4 Plug: Male
<b>ACCESSORIES</b>				
<b>192611</b> Multiple Connector      Std pkg 10      Servicing: HC-CARGO 192599 WM 4S.				Type/terminal: DTM No./poles: 4 Plug: Female
<b>192612</b> Multiple Connector      Std pkg 10      Servicing: HC-CARGO 192600 WM 4P.				Type/terminal: DTM No./poles: 4 Plug: Male



		EL. SPECIFICATIONS	DIMENSIONS	ADDITIONAL SPECIFICATIONS
<b>193107</b>	Rubber Boot	Std pkg 5	Servicing: HC-CARGO 192600	Type/terminal: DTM Colour: Grey No./poles: 4
				
<b>193108</b>	Rubber Boot	Std pkg 5	Servicing: HC-CARGO 192599	Type/terminal: DTM Colour: Grey No./poles: 4
				
<b>6 POLE</b>				
<b>192601</b>	DTM Connector	Std pkg 5		Type/terminal: DTM Colour: Grey No./poles: 6 Plug: Female
<i>DTM06-6S. Terminal: HC-CARGO 192620. Secondary lock: HC-CARGO 192613. Rubber Boot: HC-CARGO 193110.</i>				
				
<b>192602</b>	DTM Connector	Std pkg 5		Type/terminal: DTM Colour: Grey No./poles: 6 Plug: Male
<i>DTM04-6P. Terminal: HC-CARGO 192619. Secondary lock: HC-CARGO 192614. Rubber Boot: HC-CARGO 193109.</i>				
				
<b>ACCESSORIES</b>				
<b>192613</b>	Multiple Connector	Std pkg 10	Servicing: HC-CARGO 192601	Type/terminal: DTM No./poles: 6 Plug: Female
<i>WM 6S.</i>				
				
<b>192614</b>	Multiple Connector	Std pkg 10	Servicing: HC-CARGO 192602	Type/terminal: DTM No./poles: 6 Plug: Male
<i>WM 6P.</i>				
				
<b>193109</b>	Rubber Boot	Std pkg 5	Servicing: HC-CARGO 192602	Type/terminal: DTM Colour: Grey No./poles: 6
				

		EL. SPECIFICATIONS	DIMENSIONS	ADDITIONAL SPECIFICATIONS
<b>193110</b> Rubber Boot		Std pkg 5	Servicing: HC-CARGO 192601	
				Type/terminal: DTM Colour: Grey No./poles: 6
<b>8 POLE</b>				
<b>192603</b> DTM Connector		Std pkg 5		
<i>DTM06-8S. Terminal: HC-CARGO 192620. Secondary lock: HC-CARGO 192615. Rubber Boot: HC-CARGO 193112.</i>				
				Type/terminal: DTM Colour: Grey No./poles: 8 Plug: Female
<b>192604</b> DTM Connector		Std pkg 5		
<i>DTM04-8P. Terminal: HC-CARGO 192619. Secondary lock: HC-CARGO 192616. Rubber Boot: HC-CARGO 193111.</i>				
				Type/terminal: DTM Colour: Grey No./poles: 8 Plug: Male
<b>ACCESSORIES</b>				
<b>192615</b> Multiple Connector		Std pkg 10	Servicing: HC-CARGO 192603	
<i>WM 8S.</i>				
				Type/terminal: DTM No./poles: 8 Plug: Female
<b>192616</b> Multiple Connector		Std pkg 10	Servicing: HC-CARGO 192604	
<i>WM 8P.</i>				
				Type/terminal: DTM No./poles: 8 Plug: Male
<b>193111</b> Rubber Boot		Std pkg 5	Servicing: HC-CARGO 192604	
				Type/terminal: DTM Colour: Grey No./poles: 8
<b>193112</b> Rubber Boot		Std pkg 5	Servicing: HC-CARGO 192603	
				Type/terminal: DTM Colour: Grey No./poles: 8

**12 POLE**
**192605** DTM Connector Std pkg 5

DTM06-12P. Terminal: HC-CARGO 192620. Secondary lock: HC-CARGO 192617. Rubber Boot: HC-CARGO 193114.

 Type/terminal: DTM  
 Colour: Grey  
 No./poles: 12  
 Plug: Female

**192606** DTM Connector Std pkg 5

DTM04-12P. Terminal: HC-CARGO 192619. Secondary lock: HC-CARGO 192618. Rubber Boot: HC-CARGO 193113.

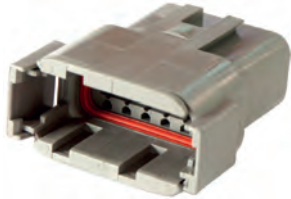
 Type/terminal: DTM  
 Colour: Grey  
 No./poles: 12  
 Plug: Male

**ACCESSORIES**
**192617** Multiple Connector Std pkg 10 Servicing: HC-CARGO 192605

WM 12S.

 Type/terminal: DTM  
 No./poles: 12  
 Plug: Female

**192618** Multiple Connector Std pkg 10 Servicing: HC-CARGO 192606

WM 12P.

 Type/terminal: DTM  
 No./poles: 12  
 Plug: Male

**193113** Rubber Boot Std pkg 5 Servicing: HC-CARGO 192606

 Type/terminal: DTM  
 Colour: Grey  
 No./poles: 12

**193114** Rubber Boot Std pkg 5 Servicing: HC-CARGO 192605

 Type/terminal: DTM  
 Colour: Grey  
 No./poles: 12

**ACCESSORIES**
**192788** Sealing Plug Std pkg 10 Servicing: DTM - Visit [www.hc-cargo.com](http://www.hc-cargo.com) for further information.

## DEUTSCH-CONNECTOR DTP

### 2 POLE

**193017** DTP Connector Std pkg 1

DTP 04-2P. Terminal: HC-CARGO 192621. Secondary lock: HC-CARGO 193021. Rubber Boot: HC-CARGO 193115.



Type/terminal: DTP  
No./poles: 2  
Plug: Male

**193018** DTP Connector Std pkg 1

DTP06-2S. Terminal: HC-CARGO 192622. Secondary lock: HC-CARGO 193022. Rubber Boot: HC-CARGO 193116.



Type/terminal: DTP  
No./poles: 2  
Plug: Female

### ACCESSORIES

**193021** Secondary Lock Std pkg 10 Servicing: HC-CARGO 193017

WP 2P.



Type/terminal: DTP  
No./poles: 2  
Plug: Male

**193022** Secondary Lock Std pkg 10 Servicing: HC-CARGO 193018

WP 2S.



Type/terminal: DTP  
No./poles: 2  
Plug: Female

**193115** Rubber Boot Std pkg 5 Servicing: HC-CARGO 193017



Type/terminal: DTP  
Colour: Grey  
No./poles: 2

**193116** Rubber Boot Std pkg 5 Servicing: HC-CARGO 193018



Type/terminal: DTP  
Colour: Grey  
No./poles: 2

**4 POLE**
**193019** DTP Connector Std pkg 1

*DTP04-4P. Terminal: HC-CARGO 192621. Secondary lock: HC-CARGO 193023. Rubber Boot: HC-CARGO 193117.*

 Type/terminal: DTP  
 No./poles: 4  
 Plug: Male

**193020** DTP Connector Std pkg 1

*DTP06-4S. Terminal: HC-CARGO 192622. Secondary lock: HC-CARGO 193024. Rubber Boot: HC-CARGO 193118.*

 Type/terminal: DTP  
 No./poles: 4  
 Plug: Female

**ACCESSORIES**
**193023** Secondary Lock Std pkg 10 Servicing: HC-CARGO 193019

*WP 4P.*

 Type/terminal: DTP  
 No./poles: 4  
 Plug: Male

**193024** Secondary Lock Std pkg 10 Servicing: HC-CARGO 193020

*WP 4S.*

 Type/terminal: DTP  
 No./poles: 4  
 Plug: Female

**193117** Rubber Boot Std pkg 5 Servicing: HC-CARGO 193019

 Type/terminal: DTP  
 Colour: Grey  
 No./poles: 4

**193118** Rubber Boot Std pkg 5 Servicing: HC-CARGO 193020

 Type/terminal: DTP  
 Colour: Grey  
 No./poles: 4

**DEUTSCH-CONNECTOR ACCESSORIES**
**192987** Mounting Bracket Std pkg 10

*Fits on DT, DTM, DTP and DTHD.*

## DEUTSCH-CONNECTOR HD

### 9 POLE

**193042** HD Connector Std pkg 1 Servicing: HC-CARGO 193043

*HD16-9-1939SE. Terminal: 9x HC-CARGO 192505.*



Type/terminal: HD16-connector  
No./poles: 9  
Plug: Female

**193043** HD Connector Std pkg 1 Servicing: HC-CARGO 193042

*HD10-9-1939PE. Terminal: 9x HC-CARGO 192506.*



Type/terminal: HD10-connector  
No./poles: 9  
Plug: Male

## DEUTSCH-CONNECTOR HDP

### 9 POLE

**193044** HDP Connector Std pkg 1 Servicing: HC-CARGO 193045

*HDP-26-24-95N. Terminal: 6x HC-CARGO 192621, 2x HC-CARGO 193233, 1x HC-CARGO 193234.*



Type/terminal: HDP26-connector  
No./poles: 9  
Plug: Female

**193045** HDP Connector Std pkg 1 Servicing: HC-CARGO 193044

*HDP24-24-9PN. Terminal: 6x HC-CARGO 192622, 2x HC-CARGO 193235, 1x HC-CARGO 193236.*



Type/terminal: HDP24-connector  
No./poles: 9  
Plug: Male

### 23 POLE

**192651** HDP Connector Std pkg 1

*HDP26-24-23-PE. Terminals: 23x HC-CARGO 192505, 192477, 192622. Seal 23x HC-CARGO 192787.*



Amp: 13

Type/terminal: HDP26-connector  
No./poles: 23  
Plug: Male

**192652** HDP Connector Std pkg 1

*HDP24-24-23-SE. Terminals: 23x HC-CARGO 192506, 192478. Seal: 23x HC-CARGO 192787. Panel Nut: HC-Cargo 192683.*



Amp: 13

Type/terminal: HDP26-connector  
No./poles: 23  
Plug: Female

## 31 POLE

**192655** HDP Connector Std pkg 1

HDP26-24-31-PE. Terminals: 31x HC-CARGO 192505, 192477. Seal: 31x HC-CARGO 192787.



Amp: 13

Type/terminal: HDP26-connector  
No./poles: 31  
Plug: Male

**192656** HDP Connector Std pkg 1

HDP24-24-31-SE. Terminals: 31x HC-CARGO 192506, 192478. Seal: 31x HC-CARGO 192787. Panel Nut: HC-Cargo 192683.



Amp: 13

Type/terminal: HDP26-connector  
No./poles: 31  
Plug: Female

## ACCESSORIES

**192683** Panel Nut Std pkg 1 Servicing: HC-CARGO 192652, 192656

HDP26-connectors. ID: UNF 1 11/16".



**192787** Sealing Plug Std pkg 10 Servicing: HC-CARGO 192651, 192652, 192655, 192656



## SUPERSEAL

### 1 POLE

**192077** Superseal Connector Std pkg 10

Terminal: HC-CARGO 192089. Single wire seal: HC-CARGO 192587, 192091.



Cable dia.: 1.5 mm

Type/terminal: Super Seal Connector  
Colour: Black  
No./poles: 1  
Plug: Male

**192078** Superseal Connector Std pkg 10

Terminal: HC-CARGO 192090. Single wire seal: HC-CARGO 192587, 192091.



Cable dia.: 1.5 mm

Type/terminal: Super Seal Connector  
Colour: Black  
No./poles: 1  
Plug: Female

**193266** Superseal Connector Std pkg 5

Terminal: HC-CARGO 192373. Single wire seal: HC-CARGO 192091.



Cable dia.: 2.8 mm

 Type/terminal: Super Seal Connector  
 Colour: Black  
 No./poles: 1  
 Plug: Male

**193267** Superseal Connector Std pkg 5

Terminal: HC-CARGO 192374. Single wire seal: HC-CARGO 192091.



Cable dia.: 2.8 mm

 Type/terminal: Super Seal Connector  
 Colour: Black  
 No./poles: 1  
 Plug: Female

**2 POLE**
**192079** Superseal Connector Std pkg 10

Terminal: HC-CARGO 192089. Single wire seal: HC-CARGO 192587, 192091.



Cable dia.: 1.5 mm

 Type/terminal: Super Seal Connector  
 Colour: Black  
 No./poles: 2  
 Plug: Male

**192080** Superseal Connector Std pkg 10

Terminal: HC-CARGO 192090. Single wire seal: HC-CARGO 192587, 192091.



Cable dia.: 1.5 mm

 Type/terminal: Super Seal Connector  
 Colour: Black  
 No./poles: 2  
 Plug: Female

**193268** Superseal Connector Std pkg 5

Terminal: HC-CARGO 192373. Single wire seal: HC-CARGO 192091.



Cable dia.: 2.8 mm

 Type/terminal: Super Seal Connector  
 Colour: Black  
 No./poles: 2  
 Plug: Male

**193269** Superseal Connector Std pkg 5

Terminal: HC-CARGO 192374. Single wire seal: HC-CARGO 192091.



Cable dia.: 2.8 mm

 Type/terminal: Super Seal Connector  
 Colour: Black  
 No./poles: 2  
 Plug: Female

**193272** Superseal Connector Std pkg 5

Supplied w/ terminals and wire seals.



Cable dia.: 6.3 mm

 Type/terminal: Super Seal Connector  
 Colour: Grey  
 No./poles: 2  
 Plug: Female



### 3 POLE

**192081** Superseal Connector Std pkg 10

Terminal: HC-CARGO 192089. Single wire seal: HC-CARGO 192587, 192091.



Cable dia.: 1.5 mm

Type/terminal: Super Seal Connector  
Colour: Black  
No./poles: 3  
Plug: Male

**192082** Superseal Connector Std pkg 10

Terminal: HC-CARGO 192090. Single wire seal: HC-CARGO 192587, 192091.



Cable dia.: 1.5 mm

Type/terminal: Super Seal Connector  
Colour: Black  
No./poles: 3  
Plug: Female

**193270** Superseal Connector Std pkg 5

Terminal: HC-CARGO 192373. Single wire seal: HC-CARGO 192091.



Cable dia.: 2.8 mm

Type/terminal: Super Seal Connector  
Colour: Black  
No./poles: 3  
Plug: Male

**193271** Superseal Connector Std pkg 5

Terminal: HC-CARGO 192374. Single wire seal: HC-CARGO 192091.



Cable dia.: 2.8 mm

Type/terminal: Super Seal Connector  
Colour: Black  
No./poles: 3  
Plug: Female

### 4 POLE

**192083** Superseal Connector Std pkg 10

Terminal: HC-CARGO 192089. Single wire seal: HC-CARGO 192587, 192091.



Cable dia.: 1.5 mm

Type/terminal: Super Seal Connector  
Colour: Black  
No./poles: 4  
Plug: Male

**192084** Superseal Connector Std pkg 10

Terminal: HC-CARGO 192090. Single wire seal: HC-CARGO 192587, 192091.



Cable dia.: 1.5 mm

Type/terminal: Super Seal Connector  
Colour: Black  
No./poles: 4  
Plug: Female

**5 POLE**
**192085** Superseal Connector Std pkg 10

*Terminal: HC-CARGO 192089. Single wire seal: HC-CARGO 192587, 192091.*

Cable dia.: 1.5 mm

 Type/terminal: Super Seal Connector  
 Colour: Black  
 No./poles: 5  
 Plug: Male

**192086** Superseal Connector Std pkg 10

*Terminal: HC-CARGO 192090. Single wire seal: HC-CARGO 192587, 192091.*

Cable dia.: 1.5 mm

 Type/terminal: Super Seal Connector  
 Colour: Black  
 No./poles: 5  
 Plug: Female

**6 POLE**
**192087** Superseal Connector Std pkg 10

*Terminal: HC-CARGO 192089. Single wire seal: HC-CARGO 192587, 192091.*

Cable dia.: 1.5 mm

 Type/terminal: Super Seal Connector  
 Colour: Black  
 No./poles: 6  
 Plug: Male

**192088** Superseal Connector Std pkg 10

*Terminal: HC-CARGO 192090. Single wire seal: HC-CARGO 192587, 192091.*

Cable dia.: 1.5 mm

 Type/terminal: Super Seal Connector  
 Colour: Black  
 No./poles: 6  
 Plug: Female

**JUNIOR-TIMER CONNECTOR**
**2 POLE**
**192146** Junior Timer Connector Std pkg 10 Servicing: HC-CARGO 070203







*Terminal: HC-CARGO 191551, 192155, 192175, 192176. Rubber boot: HC-CARGO 192150, 192151. Wire seal: HC-CARGO 192177, 192178.*

 Type/terminal: Junior Timer  
 Colour: Black  
 No./poles: 2  
 Plug: Female

**192166** Junior Timer Connector Std pkg 10

*Terminal: HC-CARGO 192156, 192157, 192174, 192503. Wire seal: HC-CARGO 192177, 192178.*

 Type/terminal: Junior Timer  
 Colour: Black  
 No./poles: 2  
 Plug: Male

	EL. SPECIFICATIONS	DIMENSIONS	ADDITIONAL SPECIFICATIONS
<p><b>192884</b> Holder Std pkg 10</p> <p>Terminals: HC-CARGO 191551, 192155, 192175, 192176. Wire seal: HC-CARGO 192177, 192178. Rubber cap: HC-CARGO 192150, 192151.</p> 		<p>Cable dia.: 2.5 mm</p>	<p>Colour: Black No./poles: 2 Plug: Female</p>
<p><b>192902</b> Junior-Timer-Connector Std pkg 10</p> <p>Plug 75. Terminal: HC-CARGO 192156, 192157, 192174, 192503. Wire seal: HC-CARGO 192177, 192178. Terminal: HC-CARGO 192998.</p> 			<p>Type/terminal: Junior Timer Colour: Black No./poles: 2 Plug: Male</p>
<b>7 POLE</b>			
<p><b>192149</b> Junior Timer Connector Std pkg 10</p> <p>Terminal: HC-CARGO 191551, 192155, 192175, 192176. Rubber boot: HC-CARGO 192154. Wire seal: HC-CARGO 192177, 192178.</p> 			<p>Type/terminal: Junior Timer Colour: Black No./poles: 7 Plug: Female</p>
<b>JUNIOR-POWER-TIMER CONNECTOR</b>			
<b>2 POLE</b>			
<p><b>192147</b> Junior Power Timer Connector Std pkg 10</p> <p>Terminal: HC-CARGO 191551, 192155, 192175, 192176. Wire seal: HC-CARGO 192177, 192178. Rubber boot: HC-CARGO 192152.</p> 			<p>Type/terminal: Junior Power Timer Colour: Black No./poles: 2 Plug: Female</p>
<p><b>192167</b> Junior Power Timer Connector Std pkg 10</p> <p>Terminal: HC-CARGO 192156, 192157, 192174, 192503. Wire seal: HC-CARGO 192177, 192178.</p> 			<p>Type/terminal: Junior Power Timer Colour: Black No./poles: 2 Plug: Male</p>
<p><b>192502</b> Junior Power Timer Connector Std pkg 10</p> <p>Terminal: HC-CARGO 192156, 192157, 192174, 192503. Wire seal: HC-CARGO 192177, 192178. Rubber boot: HC-CARGO 192150, 192151.</p> 			<p>Type/terminal: Junior Power Timer Colour: Black No./poles: 2 Plug: Male</p>

**193119** Junior Power Timer Connector Std pkg 10

Terminal: HC-CARGO 191551, 192155, 192175, 192176. Wire seal: HC-CARGO 192177, 192178. LED Adapter: HC-CARGO 171835.

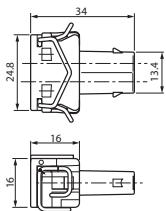

Type/terminal: Junior Power Timer  
 Colour: Black  
 No./poles: 2  
 Plug: Female

**3 POLE**

**192148** Junior Power Timer Connector Std pkg 10 Servicing: HC-CARGO 193241

Terminal: HC-CARGO 191551, 192155, 192175, 192176. Wire seal: HC-CARGO 192177, 192178. Rubber boot: HC-CARGO 192153.



Type/terminal: Junior Power Timer  
 Colour: Black  
 No./poles: 3  
 Plug: Female

**193241** Junior Power Timer Connector Std pkg 10 Servicing: HC-CARGO 192148

Terminal: HC-CARGO 192156, 192157, 192174, 192503. Wire seal: HC-CARGO 192177, 192178.



Type/terminal: Junior Power Timer  
 Colour: Black  
 No./poles: 3  
 Plug: Male

**4 POLE**

**192171** Junior Power Timer Connector Std pkg 10

Terminal: HC-CARGO 191551, 192155, 192175, 192176. Wire seal: HC-CARGO 192177, 192178.



Type/terminal: Junior Power Timer  
 Colour: Black  
 No./poles: 4  
 Plug: Female

**5 POLE**

**192172** Junior Power Timer Connector Std pkg 10

Terminal: HC-CARGO 191551, 192155, 192175, 192176. Wire seal: HC-CARGO 192177, 192178.



Type/terminal: Junior Power Timer  
 Colour: Black  
 No./poles: 5  
 Plug: Female

**6 POLE**

**192173** Junior Power Timer Connector Std pkg 10

Terminal: HC-CARGO 191551, 192155, 192175, 192176. Wire seal: HC-CARGO 192177, 192178.



Type/terminal: Junior Power Timer  
 Colour: Black  
 No./poles: 6  
 Plug: Female

### JUNIOR-POWER-TIMER ACCESSORIES

**192150** Rubber Boot      Std pkg 10      Servicing: HC-CARGO 192502, 192146, 192884

		Length: 57 mm	
---	--	---------------	--

**192151** Rubber Boot      Std pkg 10      Servicing: HC-CARGO 192502, 192146, 192884

*For 2 pole Junior-Timer connector.*

		Length: 37 mm	
---	--	---------------	--

**192152** Rubber Boot      Std pkg 10      Servicing: HC-CARGO 192147

*For 2 pole junior-timer connector. Angled.*

		Length: 48 mm	
---	--	---------------	--

**192153** Rubber Boot      Std pkg 10      Servicing: HC-CARGO 192148

*For 3 pole junior-powertimer connector.*

		Length: 57 mm	
---	--	---------------	--

**192154** Rubber Boot      Std pkg 10      Servicing: HC-CARGO 192149

*For 7 pole junior-timer connector.*

		Length: 57 mm	
---	--	---------------	--

### TOOLS

#### EXTRACTION

**210643** Ejection Tool      Std pkg 1

*For round lug w/ locking tab. For 6.5 mm mounting and dismantability bushing. Dismounting Bushes: HC-CARGO 210644. Contact Insertion Sleeve: HC-CARGO 210645.*

			
---	--	--	--

**210661** Ejection Tool      Std pkg 1

*For round lug w/ locking tab. For 3.3 mm dismantability bushing.*

			
---	--	--	--

**210667** Ejection Tool Std pkg 1 Servicing: HC-CARGO 210675

For flat terminals w/ locking tongues for 3.3 mm receptacle.



**210851** Ejection Tool Std pkg 1 Servicing: Round terminal, Mini universal



**210918** Ejection Tool Std pkg 1

For Micro Timer II terminals.



**210919** Ejection Tool Std pkg 1

To 2.8 mm standard lugs, 6.3 mm standard lugs and Junior Timer lugs.



**210921** Ejection Tool Std pkg 1 Servicing: HC-CARGO 804081

For junior power timer (male and female lugs) and the standard power timer (male and female lugs). Spare Blade: HC-CARGO 211017, 211018.



**211030** Ejection Tool Std pkg 1 Servicing: HC-CARGO 804075

For 1.5 mm Super Seal connector lugs.









**SETS**

**210675** Kabelex Tool Set Std pkg 1

For flat plug connector in the plastic box. Ejection Tool: HC-CARGO 210667.



SPARE BLADES			
<b>211017</b> Spare Blade	Std pkg 2	Servicing: HC-CARGO 210921 old model	
			
<b>211018</b> Spare Blade	Std pkg 2	Servicing: HC-CARGO 210921 old model	
			
FOR DEUTSCH-CONNECTOR TERMINALS			
<b>210973</b> Crimping Tools	Std pkg 1	Servicing: Universal crimp tool for solid terminals, DEUTSCH etc	
		Dim.: 0.5-2 mm <sup>2</sup>	
<b>211051</b> Contact Removal Tool	Std pkg 2	For DEUTSCH 0.2-0.5 mm <sup>2</sup> . DEUTSCH 0411-240-2005.	
			
<b>211052</b> Contact Removal Tool	Std pkg 2	For DEUTSCH 1-2 mm <sup>2</sup> . DEUTSCH 0411-240-1605.	
			
<b>211053</b> Contact Removal Tool	Std pkg 2	Deutsch. (2-3 mm <sup>2</sup> ).	
			
<b>211120</b> Contact Removal Tool	Std pkg 1	Servicing: Deutsch DTM, Deutsch 13760 DT RT1	
			

**211127** Contact Removal Tool Std pkg 1  
For DEUTSCH 13 mm<sup>2</sup>.



### 3 POLE

**132804** Plug Kit Std pkg 1 Servicing: ACR - Visit [www.hc-cargo.com](http://www.hc-cargo.com) for further information.  
HC-CARGO 190725 - 1, HC-CARGO 190726 - 2.



Type/terminal: Flat  
Colour: Black  
No./poles: 3  
Plug: Female

**192871** Connector Std pkg 10  
Terminal: HC-CARGO 192411.



Colour: Black  
No./poles: 3  
Plug: Female

### 4 POLE

**190762** Connector Std pkg 10  
Terminal: HC-CARGO 190252.



Colour: Black  
No./poles: 4  
Plug: Female

### POWER

#### 1 POLE

**191405** Power Connector Std pkg 1  
Terminal: HC-CARGO 191263, -264, -983.



Amp: 150

No./poles: 1  
Plug: Male

**191406** Power Connector Std pkg 1  
Terminal: HC-CARGO 191260, -261, -262.



Amp: 150

No./poles: 1  
Plug: Female



**2 POLE**

**191407** Power Connector Std pkg 1

Terminal: HC-CARGO 191263, -264, -983.

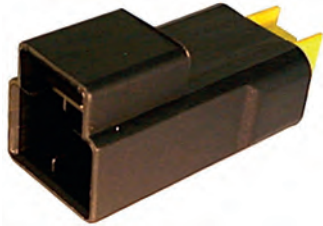

Amp: 150

No./poles: 2  
Plug: Male

**191408** Power Connector Std pkg 1

Terminal: HC-CARGO 191260, -261, -262.



Amp: 150

No./poles: 2  
Plug: Female

**4 POLE**

**181545** Connector Std pkg 1 Servicing: HC-CARGO 181476

DIN 72585.



Amp: 30

Colour: Black  
No./poles: 4  
Plug: Male

**CABLES**

**FLAT TONGUE**

**190043** Butt Splices Std pkg 25

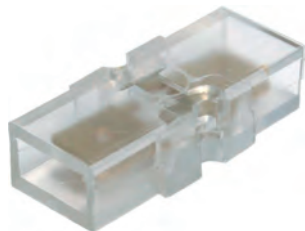

Width: 6.3 mm

Terminal type: Flat  
Out: 1  
Plugs in: 1

**190776** Butt Splices Std pkg 50

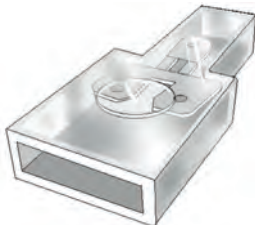

Width: 6.3 mm

Terminal type: Flat  
Out: 2  
Plugs in: 1

**190956** Butt Splices Std pkg 10







Strip of 12.



Width: 6.3 mm

Terminal type: Flat

		EL. SPECIFICATIONS	DIMENSIONS	ADDITIONAL SPECIFICATIONS
<b>192648</b> Butt Splices	Std pkg 25		Width: 6.3 mm	Terminal type: Flat Out: 3 Plugs in: 1
				
<b>WIRE NUTS</b>				
<b>RED</b>				
<b>191076</b> Cable Connector	Std pkg 50		Dim.: 1-2 mm <sup>2</sup> Dim 2: 0.5-1 mm <sup>2</sup>	
				
<b>191077</b> Cable Connector	Std pkg 50		Dim.: 0.5-1 mm <sup>2</sup> Width: 19.4 mm	Material: PP
				
<b>191485</b> Cable Connector	Std pkg 50		Dim.: 0.5-1 mm <sup>2</sup>	
<i>Cable Connector: HC-CARGO 190876, 191498.</i> 				
<b>BLUE</b>				
<b>190875</b> Cable Connector	Std pkg 50		Dim.: 1.5-2.5 mm <sup>2</sup>	Material: Nylon
<i>Cable Connector: HC-CARGO 190876.</i> 				
<b>190971</b> Cable Connector	Std pkg 50		Dim.: 1.5-2.5 mm <sup>2</sup> Width: 20.4 mm	Material: PP
				
<b>BROWN</b>				
<b>191484</b> Cable Connector	Std pkg 50		Dim.: 2.5-4 mm <sup>2</sup> Dim 2: 0.75-1.5 mm <sup>2</sup> Width: 21.1 mm	Material: PP
				

RED TRANSPARENT			
<b>191498</b> Cable Connector      Std pkg 50      Servicing: HC-CARGO 191485 6.3 mm.			
		Dim.: 0.5-1.5 mm <sup>2</sup>	Terminal type: Male
TRANSPARENT			
<b>190876</b> Cable Connector      Std pkg 50      Servicing: HC-CARGO 190875, 191485 6.3 mm.			
		Dim.: 1.5-2.5 mm <sup>2</sup>	Terminal type: Male
SCREW TERMINAL			
<b>190195</b> Cable Connector      Std pkg 10 Number of 12. Max 24 A.			
		Dim.: 2.5 mm <sup>2</sup>	Terminal type: Screw
<b>190196</b> Cable Connector      Std pkg 10 Number of 12. Max 32 A.			
		Dim.: 4-6 mm <sup>2</sup>	Terminal type: Screw
<b>190197</b> Cable Connector      Std pkg 10 Number of 12. Max 76 A.			
		Dim.: 16 mm <sup>2</sup>	Terminal type: Screw
<b>190911</b> Cable Connector      Std pkg 10 Number of 12. Max 41 A.			
		Dim.: 10 mm <sup>2</sup>	Terminal type: Screw
<b>191756</b> Butt Splices      Std pkg 1      Servicing: HC-CARGO 191755 8x6 terminalblock. 25 A. Terminal width: 6.3 mm			
		Dist. mount. holes: 99 mm	Terminal type: Flat Material: Polycarbonate Out: 8 Plugs in: 8

**191771** Butt Splices

Std pkg 1

1x8 20 A. 1x8 20 A.

 Dist. mount. holes:  
99 mm

 Terminal type: Screw  
Material: Polycarbonate  
Out: 8  
Plugs in: 8

**193011** Terminal Block

Std pkg 1

25 A. Terminal width: 6.3 mm.

 Dist. mount. holes:  
77.3 mm

 Terminal type: Flat  
Material: Polycarbonate  
Out: 6  
Plugs in: 6

**BATTERY TERMINALS**
**BRASS CASTING**

 25-35 mm<sup>2</sup>
**192368** Battery Terminal

Std pkg 5

 Length: 46 mm  
Cable size/max: 35 mm<sup>2</sup>  
Cable size/min: 25 mm<sup>2</sup>  
Polarity: Positive

 Material: Moulded brass  
Alternativ no.: 190012

**192369** Battery Terminal

Std pkg 5

 Length: 46 mm  
Cable size/max: 35 mm<sup>2</sup>  
Cable size/min: 25 mm<sup>2</sup>  
Polarity: Negative

 Material: Moulded brass  
Alternativ no.: 190013

**W/ 10 mm BOLT**
**192400** Battery Terminal

Std pkg 5

 Length: 54 mm  
Cable size/max: 70 mm<sup>2</sup>  
Cable size/min: 10 mm<sup>2</sup>  
Cable connection:  
10 mm bolt  
Polarity: Positive

 Material: Moulded brass  
Alternativ no.: 190213

**192401** Battery Terminal

Std pkg 5

 Length: 54 mm  
Cable size/max: 70 mm<sup>2</sup>  
Cable size/min: 10 mm<sup>2</sup>  
Cable connection:  
10 mm bolt  
Polarity: Negative

 Material: Moulded brass  
Alternativ no.: 190214

TIN PLATED			
<b>190213</b> Battery Terminal Std pkg 5			
		ID: 18.5 mm Cable size/max: 70 mm <sup>2</sup> Cable size/min: 10 mm <sup>2</sup> Cable connection: 10 mm bolt Polarity: Positive	Material: Moulded brass Tin plated: Yes Alternativ no.: 192400
<b>190214</b> Battery Terminal Std pkg 5			
		ID: 15.9 mm Cable size/max: 70 mm <sup>2</sup> Cable size/min: 10 mm <sup>2</sup> Cable connection: 10 mm bolt Polarity: Negative	Material: Moulded brass Tin plated: Yes Alternativ no.: 192401
<b>W/ M6 BOLT AND WING NUT</b>			
TIN PLATED			
<b>191134</b> Battery Terminal Std pkg 5			
<i>w/ wing nut.</i>			
		ID: 15.9 mm Cable size/max: 70 mm <sup>2</sup> Cable size/min: 6 mm <sup>2</sup> Cable connection: 8 mm bolt Polarity: Negative	Material: Moulded brass Tin plated: Yes Alternativ no.: 192403
<b>W/ M10 BOLT AND WING NUT</b>			
<b>192402</b> Battery Terminal Std pkg 5			
<i>w/ wing nut.</i>			
		Length: 54 mm Cable size/max: 70 mm <sup>2</sup> Cable size/min: 10 mm <sup>2</sup> Cable connection: 10 mm bolt Polarity: Positive	Material: Moulded brass Alternativ no.: 191133
<b>192403</b> Battery Terminal Std pkg 5			
<i>w/ wing nut.</i>			
		Length: 54 mm Cable size/max: 70 mm <sup>2</sup> Cable size/min: 10 mm <sup>2</sup> Cable connection: 10 mm bolt Polarity: Negative	Material: Moulded brass Alternativ no.: 191134
TIN PLATED			
<b>191133</b> Battery Terminal Std pkg 5			
<i>w/ wing nut.</i>			
		ID: 18.5 mm Cable size/max: 70 mm <sup>2</sup> Cable size/min: 10 mm <sup>2</sup> Cable connection: 10 mm bolt Polarity: Positive	Material: Moulded brass Tin plated: Yes Alternativ no.: 192402

**25 mm<sup>2</sup>**
**192163** Battery Terminal

Std pkg 5

 ID: 19 mm  
 Cable size/max: 25 mm<sup>2</sup>  
 Polarity: Positive

Material: Moulded brass

**192164** Battery Terminal

Std pkg 5

 ID: 17 mm  
 Cable size/max: 25 mm<sup>2</sup>  
 Polarity: Negative

Material: Moulded brass

**W/ SWITCH**
**192493** Battery Terminal

Std pkg 1



Polarity: Negative

 Switch: w/  
 Material: Moulded brass  
 Cable w/fuse: Yes

**16-35 mm<sup>2</sup>**
**TIN PLATED**
**190012** Battery Terminal

Std pkg 5

 ID: 18.5 mm  
 Cable size/max: 35 mm<sup>2</sup>  
 Cable size/min: 16 mm<sup>2</sup>  
 Cable connection:  
 8 mm bolt  
 Polarity: Positive

 Material: Moulded brass  
 Tin plated: Yes  
 Alternativ no.: 192368

**190013** Battery Terminal

Std pkg 5

 ID: 15.9 mm  
 Cable size/max: 35 mm<sup>2</sup>  
 Cable size/min: 16 mm<sup>2</sup>  
 Cable connection:  
 8 mm bolt  
 Polarity: Negative

 Material: Moulded brass  
 Tin plated: Yes  
 Alternativ no.: 192369

**190211** Battery Terminal

Std pkg 5

 Servicing: Fiat, Mazda, Suzuki, Nissan - Visit [www.hc-cargo.com](http://www.hc-cargo.com) for further information.

 ID: 13 mm  
 Cable size/max: 35 mm<sup>2</sup>  
 Cable size/min: 16 mm<sup>2</sup>  
 Polarity: Positive

 Material: Moulded brass  
 Tin plated: Yes

**190212** Battery Terminal

Std pkg 5

 Servicing: Fiat, Mazda, Suzuki, Nissan - Visit [www.hc-cargo.com](http://www.hc-cargo.com) for further information.

 ID: 11.2 mm  
 Cable size/max: 35 mm<sup>2</sup>  
 Cable size/min: 16 mm<sup>2</sup>  
 Polarity: Negative

 Material: Moulded brass  
 Tin plated: Yes

35-70 mm <sup>2</sup>			
TIN PLATED			
<b>191166</b> Battery Terminal		Std pkg 5	
		ID: 18.5 mm Cable size/max: 70 mm <sup>2</sup> Cable size/min: 35 mm <sup>2</sup> Polarity: Positive	Material: Moulded brass Tin plated: Yes
<b>191167</b> Battery Terminal		Std pkg 5	
		ID: 15.9 mm Cable size/max: 70 mm <sup>2</sup> Cable size/min: 35 mm <sup>2</sup> Polarity: Negative	Material: Moulded brass Tin plated: Yes
35-95 mm <sup>2</sup>			
TIN PLATED			
<b>193000</b> Battery Terminal		Std pkg 5	
<i>Heavy duty.</i>			
		ID: 18.5 mm Cable size/max: 95 mm <sup>2</sup> Cable size/min: 35 mm <sup>2</sup> Polarity: Positive	Material: Moulded brass Tin plated: Yes
<b>193001</b> Battery Terminal		Std pkg 5	
<i>Heavy duty.</i>			
		ID: 15.9 mm Cable size/max: 95 mm <sup>2</sup> Cable size/min: 35 mm <sup>2</sup> Polarity: Negative	Material: Moulded brass Tin plated: Yes
TIN PLATED W/DOUBLE SCREW			
<b>190866</b> Battery Terminal		Std pkg 5	
<i>w/ double screws and screw for AUX.</i>			
		ID: 18.5 mm Cable size/max: 95 mm <sup>2</sup> Cable size/min: 35 mm <sup>2</sup> Cable connection: Dual Polarity: Positive	Material: Moulded brass Tin plated: Yes
<b>190867</b> Battery Terminal		Std pkg 5	
<i>w/ double screws and screw for AUX.</i>			
		ID: 15.9 mm Cable size/max: 95 mm <sup>2</sup> Cable size/min: 35 mm <sup>2</sup> Cable connection: Dual Polarity: Negative	Material: Moulded brass Tin plated: Yes

**35 mm<sup>2</sup>**
**TIN PLATED**
**191244** Battery Terminal Std pkg 5

 ID: 18.5 mm  
 Cable size/max: 35 mm<sup>2</sup>  
 Cable size/min: 35 mm<sup>2</sup>  
 Polarity: Positive

 Material: Moulded brass  
 Tin plated: Yes

**191245** Battery Terminal Std pkg 5

 ID: 15.9 mm  
 Cable size/max: 35 mm<sup>2</sup>  
 Cable size/min: 35 mm<sup>2</sup>  
 Polarity: Negative

 Material: Moulded brass  
 Tin plated: Yes

**50 mm<sup>2</sup>**
**TIN PLATED**
**190202** Battery Terminal Std pkg 5

 ID: 18.5 mm  
 Cable size/max: 50 mm<sup>2</sup>  
 Cable size/min: 50 mm<sup>2</sup>  
 Polarity: Positive

 Material: Moulded brass  
 Tin plated: Yes

**190203** Battery Terminal Std pkg 5

 ID: 15.9 mm  
 Cable size/max: 50 mm<sup>2</sup>  
 Cable size/min: 50 mm<sup>2</sup>  
 Polarity: Negative

 Material: Moulded brass  
 Tin plated: Yes

**70 mm<sup>2</sup>**
**TIN PLATED**
**191989** Battery Terminal Std pkg 5

 ID: 18.5 mm  
 Cable size/max: 70 mm<sup>2</sup>  
 Cable size/min: 70 mm<sup>2</sup>  
 Polarity: Positive









 Material: Moulded brass  
 Tin plated: Yes

**191990** Battery Terminal Std pkg 5

 ID: 15.9 mm  
 Cable size/max: 70 mm<sup>2</sup>  
 Cable size/min: 70 mm<sup>2</sup>  
 Polarity: Negative

 Material: Moulded brass  
 Tin plated: Yes



EL. SPECIFICATIONS		DIMENSIONS	ADDITIONAL SPECIFICATIONS
<b>193166</b> Battery Terminal	Std pkg 5		
		Length: 50 mm Cable size/max: 70 mm <sup>2</sup> Cable size/min: 10 mm <sup>2</sup> Polarity: Positive	Material: Moulded brass No./connections: 2 Tin plated: Yes
<b>193167</b> Battery Terminal	Std pkg 5		
		Length: 50 mm Cable size/max: 70 mm <sup>2</sup> Cable size/min: 10 mm <sup>2</sup> Polarity: Negative	Material: Moulded brass No./connections: 2 Tin plated: Yes
<b>ACCESSORIES</b>			
<b>190215</b> Nut & Bolt	Std pkg 100		
		Collar length: 38 mm Thread size: M8	Material: Moulded brass
<b>192681</b> Terminal Cover	Std pkg 10		
		Cable dia.: 17 mm Length: 52 mm Width: 35 mm	Colour: Red Material: PVC
<b>192682</b> Terminal Cover	Std pkg 10		
		Cable dia.: 17 mm Length: 52 mm Width: 35 mm	Colour: Black Material: PVC
<b>192888</b> Terminal Cover	Std pkg 10		
<i>Right +</i>			
		Cable dia.: 17 mm Length: 52 mm Height: 22 mm Width: 35 mm	Colour: Red Material: PVC
<b>192889</b> Terminal Cover	Std pkg 10		
<i>Left -</i>			
		Cable dia.: 17 mm Length: 52 mm Height: 22 mm Width: 35 mm	Colour: Black Material: PVC
<b>192890</b> Terminal Cover	Std pkg 10		
<i>Left +</i>			
		Cable dia.: 17 mm Length: 52 mm Height: 22 mm Width: 35 mm	Colour: Red Material: PVC

192891 Terminal Cover		Std pkg 10		
<i>Right -</i>				
			Cable dia.: 17 mm Length: 52 mm Height: 22 mm Width: 35 mm	Colour: Black Material: PVC
<b>FORMPRESSED</b>				
25-40 mm <sup>2</sup>				
17 mm				
192075 Battery Terminal		Std pkg 5		
			ID: 17 mm Cable size/max: 40 mm <sup>2</sup> Cable size/min: 25 mm <sup>2</sup> Polarity: Negative	Material: Compressed No./connections: 1
192076 Battery Terminal		Std pkg 5		
<i>For M8 stud connection.</i>				
			ID: 17 mm Cable size/max: 40 mm <sup>2</sup> Cable size/min: 25 mm <sup>2</sup> Polarity: Positive	Material: Compressed No./connections: 1
19 MM				
191820 Battery Terminal		Std pkg 1		
			ID: 19 mm Cable size/max: 40 mm <sup>2</sup> Cable size/min: 25 mm <sup>2</sup> Polarity: Positive	Material: Compressed No./connections: 2
<b>3 TERMINAL OUTLETS</b>				
191821 Battery Terminal		Std pkg 1		
			ID: 19 mm Polarity: Positive	Material: Compressed No./connections: 3
			ID: 17 mm Polarity: Negative	Material: Compressed No./connections: 3

**10-20 MM<sup>2</sup>**
**17 MM**
**192074** Battery Terminal Std pkg 5

 ID: 17 mm  
 Cable size/max: 20 mm<sup>2</sup>  
 Cable size/min: 10 mm<sup>2</sup>  
 Polarity: Negative

 Material: Compressed  
 No./connections: 1

**FOR FRENCH APPLICATIONS**
**192053** Battery Terminal Std pkg 5 Servicing: French applications - Visit [www.hc-cargo.com](http://www.hc-cargo.com) for further information.

 ID: 19 mm  
 Polarity: Positive

 Colour: Red  
 Material: Compressed

**192054** Battery Terminal Std pkg 5 Servicing: French applications - Visit [www.hc-cargo.com](http://www.hc-cargo.com) for further information.

 ID: 17 mm  
 Polarity: Negative

 Colour: Green  
 Material: Compressed

**LEADS AND EARTH STRAPS**
**190218** Battery Connection Cable Std pkg 1

 Length: 300 mm  
 Cable size/max: 35 mm<sup>2</sup>  
 Angled: 90°  
 Polarity: Pos./Neg.

No./wires: 1008/0.2

**190220** Earth Strap Std pkg 1

Amp: 110

 Length: 200 mm  
 Cable size/max: 22 mm<sup>2</sup>

No./wires: 432/0.26

**190221** Earth Strap Std pkg 1

Amp: 110

 Length: 250 mm  
 Cable size/max: 22 mm<sup>2</sup>







No./wires: 432/0.26

**190222** Earth Strap Std pkg 1

Amp: 110

 Length: 300 mm  
 Cable size/max: 22 mm<sup>2</sup>

No./wires: 432/0.26

		EL. SPECIFICATIONS	DIMENSIONS	ADDITIONAL SPECIFICATIONS
<b>190223</b> Earth Strap	Std pkg 1	Amp: 110	Length: 350 mm Cable size/max: 22 mm <sup>2</sup>	No./wires: 432/0.26
				
<b>190224</b> Earth Strap	Std pkg 1	Amp: 110	Length: 400 mm Cable size/max: 22 mm <sup>2</sup>	No./wires: 432/0.26
				
<b>190225</b> Earth Strap	Std pkg 1	Amp: 110	Length: 450 mm Cable size/max: 22 mm <sup>2</sup>	No./wires: 432/0.26
				
<b>190226</b> Earth Strap	Std pkg 1	Amp: 110	Length: 500 mm Cable size/max: 22 mm <sup>2</sup>	No./wires: 432/0.26
				
<b>190228</b> Earth Strap	Std pkg 2	Amp: 82	Length: 200 mm Cable size/max: 16 mm <sup>2</sup>	No./wires: 228/0.25
				
<b>190229</b> Earth Strap	Std pkg 2	Amp: 82	Length: 250 mm Cable size/max: 16 mm <sup>2</sup>	No./wires: 228/0.25
				
<b>190230</b> Earth Strap	Std pkg 2	Amp: 82	Length: 350 mm Cable size/max: 16 mm <sup>2</sup>	No./wires: 228/0.25
				

		EL. SPECIFICATIONS	DIMENSIONS	ADDITIONAL SPECIFICATIONS
<b>190231</b>	Earth Strap Std pkg 2		Amp: 82	Length: 400 mm Cable size/max: 16 mm <sup>2</sup> No./wires: 228/0.25
<b>190232</b>	Earth Strap Std pkg 2		Amp: 82	Length: 450 mm Cable size/max: 16 mm <sup>2</sup> No./wires: 228/0.25
<b>190235</b>	Starter Cable Std pkg 1			Length: 300 mm Cable size/max: 25 mm <sup>2</sup> Polarity: Positive No./wires: 742/0.2
<b>190237</b>	Starter Cable Std pkg 1			Length: 500 mm Cable size/max: 25 mm <sup>2</sup> Polarity: Positive No./wires: 742/0.2
<b>190239</b>	Starter Cable Std pkg 1			Length: 700 mm Cable size/max: 25 mm <sup>2</sup> Polarity: Positive No./wires: 742/0.2
<b>190242</b>	Starter Cable Std pkg 1			Length: 1000 mm Cable size/max: 25 mm <sup>2</sup> Polarity: Positive No./wires: 742/0.2
<b>191679</b>	Battery Connection Cable Std pkg 1			Length: 300 mm Cable size/max: 50 mm <sup>2</sup> Angled: 90° Polarity: Pos./Neg. No./wires: 378/0.41

## INDUSTRIAL BATTERY CONNECTORS

### CB Series Details

	CB 50	CB 175	CB 350
	mm	mm	mm
A	19	28.5	28.5
B	6.4	11	35
C	18.2	27	35
D	36.5	55.6	69.8
E	47.6	79.4	108
F	80.9	133.3	182.6
G	11.5	19	27
H	15.9	25.4	33.3
J	3.7	6.7	6.7

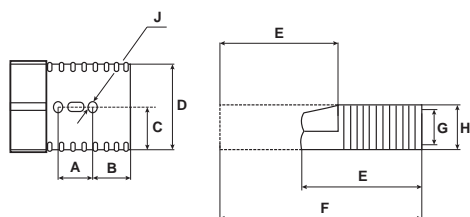

### CBX Series Details

	CBX 175	CBX 350
	mm	mm
A	49.2	61.9
B	28.5	28.5
C	15.9	15.9
D	71.2	85.7
E	85.3	125.4
F	146.3	200
G	25.5	33.3

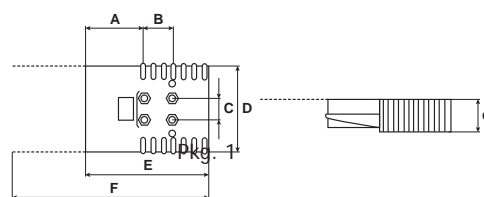

### 50 AMPERE

CB50	HC-CARGO	Std pkg	Max V	Amp	Temp. class °C	Colour	Cable size	Terminals	Handle	Dust cap
	180530	Pkg. 1	600	50	-40 - +125	Grey	6 mm <sup>2</sup>	180390	180548	180516
	180531	Pkg. 1	600	50	-40 - +125	Red	6 mm <sup>2</sup>	180390	180548	180516
	180532	Pkg. 1	600	50	-40 - +125	Black	6 mm <sup>2</sup>	180390	180548	180516
	180381	Pkg. 1	600	50	-40 - +125	Grey	16 mm <sup>2</sup>	180535	180548	180516
	180382	Pkg. 1	600	50	-40 - +125	Red	16 mm <sup>2</sup>	180535	180548	180516
	180383	Pkg. 1	600	50	-40 - +125	Black	16 mm <sup>2</sup>	180535	180548	180516

### SPARE PARTS

**180390** Terminals Std pkg 1 Servicing: HC-CARGO 180381, -382, -383



Voltage: 600  
Amp: 50  
Cable dim.: 16 mm<sup>2</sup>

**180535** Terminals Std pkg 1 Servicing: HC-CARGO 180530, -531, -532



Voltage: 600  
Amp: 50  
Cable dim.: 6 mm<sup>2</sup>

### ACCESSORIES

**180548** Handle Std pkg 1 Servicing: HC-CARGO 180381, -382, -383, -530, -531, -532



Colour: Red

**181516** Dust Cap      Std pkg 1    Servicing: CB50

**80 AMPERE**

NF80	HC-CARGO	Std pkg	Max V	Amp	Temp. class	Colour	Heading type	Cable size
	180542	Pkg. 1	150	80	-20°C - +90°C	Black	Female	25 mm <sup>2</sup>
	180543	Pkg. 1	150	80	-20°C - +90°C	Black	Male	25 mm <sup>2</sup>
	180562	Pkg. 1	150	80	-20°C - +90°C	Black	Female	16 mm <sup>2</sup>
	180563	Pkg. 1	150	80	-20°C - +90°C	Black	Male	16 mm <sup>2</sup>

**100 AMPERE**

CB100	HC-CARGO	Std pkg	Max V	Amp	Temp. class	Colour	Heading type	Cable size	Handle
	181501	Pkg. 1	150	100	-20°C - +90°C	Black	Female	16 mm <sup>2</sup>	181505 (R)
	181502	Pkg. 1	150	100	-20°C - +90°C	Black	Male	16 mm <sup>2</sup>	181505 (R)
	181503	Pkg. 1	150	100	-20°C - +90°C	Black	Female	25 mm <sup>2</sup>	181505 (R)
	181504	Pkg. 1	150	100	-20°C - +90°C	Black	Male	25 mm <sup>2</sup>	181505 (R)

**ACCESSORIES**
**181505** Handle      Std pkg 1    Servicing: HC-CARGO 181501, 181502, 181503, 181504

Colour: Red

**160 AMPERE**

NF160	HC-CARGO	Std pkg	Max V	Amp	Temp. class °C	Colour	Heading type	Cable size	Reducing bush	Handle
	181519	Pkg. 1	150	160	-20 - +90	Black	Female	50 mm <sup>2</sup>	181521	180380 (B)
	181520	Pkg. 1	150	160	-20 - +90	Black	Male	50 mm <sup>2</sup>	181521	Already present

**ACCESSORIES**
**180380** Handle      Std pkg 1    Servicing: HC-CARGO 180395, 180396, 181519, 181520

Colour: Black

**181521** Reducer Kit      Std pkg 1    Servicing: HC-CARGO 181519, 181520

 Voltage: 150  
 Amp: 160  
 Cable dim.: 50/35 mm<sup>2</sup>

## 175 AMPERE

CB175	HC-CARGO	Std pkg	Max V	Amp	Temp. class °C	Colour	Heading type	Cable size	Terminals	Handle	Dust cap
	<b>180384</b>	Pkg. 1	600	175	-40 - +125	Grey	Female	50 mm <sup>2</sup>	180392	180549 (G) 180391 (R)	180517
	<b>180385</b>	Pkg. 1	600	175	-40 - +125	Red	Female	50 mm <sup>2</sup>	180392	180549 (G) 180391 (R)	180517
	<b>180537</b>	Pkg. 1	600	175	-40 - +125	Grey	Female	50 mm <sup>2</sup>	180554	180549 (G) 180391 (R)	
	<b>180538</b>	Pkg. 1	600	175	-40 - +125	Red	Female	50 mm <sup>2</sup>	180554	180549 (G) 180391 (R)	
	<b>180533</b>	Pkg. 1	600	175	-40 - +125	Grey	Female	35 mm <sup>2</sup>	180536	180549 (G) 180391 (R)	180517
	<b>180534</b>	Pkg. 1	600	175	-40 - +125	Red	Female	35 mm <sup>2</sup>	180536	180549 (G) 180391 (R)	180517

## SPARE PARTS

**180392** Terminals Std pkg 1 Servicing: HC-CARGO 180384, -385



Voltage: 600  
Amp: 175  
Cable dim.: 50 mm<sup>2</sup>

**180536** Terminals Std pkg 1 Servicing: HC-CARGO 180533, 180534



Voltage: 600  
Amp: 175  
Cable dim.: 35 mm<sup>2</sup>

**180554** Terminals Std pkg 1 Servicing: HC-CARGO 180537, -538



Voltage: 600  
Amp: 175  
Cable dim.: 50 mm<sup>2</sup>

## ACCESSORIES

**180391** Handle Std pkg 1 Servicing: HC-CARGO 180533, -534, -537, -538, -384, -385



Colour: Red

**180549** Handle Std pkg 1 Servicing: HC-CARGO 180533, -534, -537, -538, -384, -385



Colour: Grey

**181517** Dust Cap Std pkg 1 Servicing: CB175





250 AMPERE											
Y250	HC-CARGO	Std pkg	Max V	Amp	Colour	Heading type	Cable size	Terminals	Handle	Self close lid	
	180580	Pkg. 1	150	250	Yellow	Male	50 mm <sup>2</sup>	180582	180328	181329	
	180581	Pkg. 1	250	250	Black	Female	50 mm <sup>2</sup>	180583	180328	181329	
SPARE PARTS											
<b>181605</b> Terminals      Std pkg 1      Servicing: HC-CARGO 180581											
	Amp: 250						Gender: Female				
<b>181606</b> Terminals      Std pkg 1      Servicing: HC-CARGO 180580											
	Amp: 250						Gender: Male				
ACCESSORIES											
<b>180582</b> Terminals      Std pkg 1      Servicing: HC-CARGO 180580 <i>Single delivered.</i>											
	Amp: 250						Gender: Male				
<b>180583</b> Terminals      Std pkg 1      Servicing: HC-CARGO 180581 <i>Single delivered.</i>											
	Amp: 250						Gender: Female				
<b>181328</b> Rubber Boot      Std pkg 1      Servicing: HC-CARGO 180580											
										Protection degree: IP 66	
<b>181329</b> Lid      Std pkg 1      Servicing: HC-CARGO 180581 <i>Self-closed.</i>											
											

### 300 AMPERE

E300	HC-CARGO	Std pkg	Max V	Amp	Colour	Cable size	Terminals
	180575	Pkg. 1	250	300	Yellow	70 mm <sup>2</sup>	w/brazed solid silver tip
	180577	Pkg. 1	250	300	Yellow	70 mm <sup>2</sup>	w/brazed solid silver tip

### 320 AMPERE

NF320	HC-CARGO	Std pkg	Max V	Amp	Temp. class °C	Colour	Heading type	Cable size	Aux terminals
	180395	Pkg. 1	150	320	-20 - +90	Black	Female	90/70 mm <sup>2</sup>	180916
	180396	Pkg. 1	150	320	-20 - +90	Black	Male	90/70 mm <sup>2</sup>	

### ACCESSORIES

**180616** Terminals Std pkg 1 Servicing: HC-CARGO 180395

	Voltage: 150	Type: Female
	Amp: 160	

### 350 AMPERE

CB350	HC-CARGO	Std pkg	Max V	Amp	Temp. class °C	Colour	Heading type	Cable size	Handle
	180386	Pkg. 1	600	350	-40 - +125	Grey	Female	70 mm <sup>2</sup>	180550 (G)
	180387	Pkg. 1	600	350	-40 - +125	Red	Female	70 mm <sup>2</sup>	180550 (G)

CBX350	HC-CARGO	Std pkg	Max V	Amp	Temp. class °C	Colour	Heading type	Cable size	Handle
	180551	Pkg. 1	600	350	-40 - +125	Grey	Female	70 mm <sup>2</sup>	180550 (G)
	180552	Pkg. 1	600	350	-40 - +125	Red	Female	70 mm <sup>2</sup>	180550 (G)

### ACCESSORIES

**180550** Handle Std pkg 1 Servicing: HC-CARGO 180386, -387, 180551, -552

	Colour: Grey

## PLUGS & SOCKETS

### DIN AND CIGARETTE LIGHTER

**160294** Cigarette Lighter      Std pkg 1      Servicing: Alfa Romeo, Audi, Opel, VW - Visit [www.hc-cargo.com](http://www.hc-cargo.com) for further information.

*Universal.*



Voltage: 12

Light: w/o

**160300** Cigarette Lighter      Std pkg 1

*Universal.*



Voltage: 12

Light: w/

**160551** Cigarette Lighter      Std pkg 1

*Universal.*



Voltage: 24

Light: w/

## SOCKETS

**160409** Lighter Socket      Std pkg 1

*Universal.*



Voltage: 12-24  
Amp: 20

Light: w/o  
Cap: w/  
Resistor: w/o  
DIN norm: 53 505

**180038** DIN Socket      Std pkg 5

*Standard DIN.*



ID/mount. hole:  
18.5 mm

Material: Nickel plated brass  
No./mounting holes: 1  
Cap: w/  
Male/female: Female  
DIN norm: 72591  
ISO norm: 4165

**180115** DIN Socket      Std pkg 1

*Universal. DIN Plug: HC-CARGO 180113.*



Dist. mount. holes:  
46 mm

Material: Cast aluminum  
No./mounting holes: 2  
No./poles: 2  
Male/female: Female  
DIN norm: 72591  
ISO norm: 4165

		EL. SPECIFICATIONS	DIMENSIONS	ADDITIONAL SPECIFICATIONS
<b>180157</b> DIN Socket	Std pkg 5		ID/mount. hole: 18.5 mm	Material: Nickel plated brass No./poles: 2 Cap: w/ Male/female: Female DIN norm: 72591 ISO norm: 4165
				
<b>180315</b> DIN Socket	Std pkg 1	Servicing: HC-CARGO 181579		
<i>Universal. DIN Plug: HC-CARGO 180399, 181629.</i>				
			Dist. mount. holes: 46 mm	Material: Plastic No./mounting holes: 2 No./poles: 2 Male/female: Female
<b>180354</b> Coupling Socket	Std pkg 1			
<i>DIN - coupling socket extension connector, universal. Standard.</i>				
				No./poles: 1 Male/female: Female
<b>180376</b> DIN Socket	Std pkg 5	Servicing: HC-CARGO 170292, 170387, 170405, 170788, 170406, 170562, 170789, 170537, 171576, 170419, 170460		
<i>Also used in sockets for beacons.</i>				
			ID/mount. hole: 18.5 mm	Material: Brass No./poles: 1 Male/female: Female DIN norm: 72591
<b>180377</b> DIN Socket	Std pkg 5			
<i>Also used in sockets for beacons.</i>				
			ID/mount. hole: 18.5 mm	Material: Brass No./poles: 2 Male/female: Female DIN norm: 72591
<b>181275</b> DIN Socket	Std pkg 5			
			ID/mount. hole: 18.5 mm	No./poles: 2 Cap: w/ Male/female: Female DIN norm: 72591 ISO norm: 4165 Alternativ no.: 180157
<b>181548</b> Twin Socket Cigar Adapter	Std pkg 1			
<i>w/ 60 cm cable.</i>				
		Voltage: 12 Amp: 15		

	EL. SPECIFICATIONS	DIMENSIONS	ADDITIONAL SPECIFICATIONS
<b>181549</b> Twin Socket Cigar Adapter    Std pkg 1 	Voltage: 12 Amp: 15		
<b>181550</b> Twin Socket Cigar Adapter    Std pkg 1 <i>w/ 2 USB plugs. Cable lenght: 650 mm. USB Charging Kit: HC-CARGO 181602.</i> 	Voltage: 12-24 Amp: 10		
<b>181575</b> Socket    Std pkg 1 <i>Universal. w/ 30 cm cable 0.8 mm<sup>2</sup>.</i> 			
<b>181601</b> USB Adapter    Std pkg 1 <i>2 horizontally built-in ports, charging two USB devices simultaneously. USB Charging Kit: HC-CARGO 181602.</i> 	Voltage: 12-24 Amp: 3		Material: PVC
<b>181616</b> DIN Socket    Std pkg 1 <i>300 mm cable.</i> 	Voltage: 6-24 Amp: 16	Cable dim.: 2x2.5 mm <sup>2</sup> Mount. hole dia.: 18.4 mm Temp.: -40 - +105 °C Connection: Cable	Mount.: Screw Colour: Black Material: Shockproof plastic No./poles: 2 Male/female: Female ISO norm: 4165 Protection degree: IP 67
<b>181631</b> USB Adapter    Std pkg 1 <i>2 horizontally built-in ports, charging two USB devices simultaneously. USB Charging Kit: HC-CARGO 181602.</i> 	Voltage: 12-24 Amp: 2.1		Colour: White/black Material: Polycarbonate
<b>PLUGS</b>			
<b>180113</b> DIN Plug    Std pkg 5    Servicing: HC-CARGO 180115 <i>Universal.</i> 			Material: Plastic No./poles: 2 Male/female: Male DIN norm: 72591 ISO norm: 4165

		EL. SPECIFICATIONS	DIMENSIONS	ADDITIONAL SPECIFICATIONS
<b>180230</b> DIN Plug		Std pkg 5		
<i>Universal plug suitable for all cigarette lighter sockets. Also suitable for standard DIN socket.</i>				
		Voltage: 12/24 Amp: <8		Material: Plastic No./poles: 2 Male/female: Male ISO norm: 4165
<b>180287</b> DIN Plug		Std pkg 1		
<i>Universal plug suitable for all cigarette lighter sockets. Also suitable for standard DIN socket. w/ built-in 8 A fuse.</i>				
		Voltage: 12/24		Material: Plastic No./poles: 2 Male/female: Male ISO norm: 4165
<b>180399</b> DIN Plug		Std pkg 5 Servicing: HC-CARGO 180315		
<i>Universal.</i>				
		Voltage: 12/24		Material: Plastic No./poles: 2 Male/female: Male
<b>181629</b> DIN Plug		Std pkg 5 Servicing: HC-CARGO 180315, 181579		
<i>Universal.</i>				
		Voltage: 12/24		Material: Plastic No./poles: 2 Male/female: Male
<b>ACCESSORIES</b>				
<b>171518</b> Coiled Cable		Std pkg 1 Servicing: HC-CARGO 170292, 170387, 170405, 170788, 170406, 170562, 170789, 170537, 171576, 170419, 170460		
			Working length: 2 m	Plug type: Cigar plug Plug: 2 ISO norm: 4165
<b>171562</b> Coiled Cable		Std pkg 1 Servicing: HC-CARGO 171494, 171495		
			Working length: 3 m	Plug type: Cigar plug
<b>181579</b> Plug and Socket		Std pkg 10 Servicing: HC-CARGO 181629, 180315		
		Voltage: 12/24		Material: Plastic No./mounting holes: 2 No./poles: 2

<b>181602</b> USB Charging Kit			
Std pkg 1 Servicing: HC-CARGO 181601, 181550, 181631			
Plug 1: Nokia N70/628/6300/N95. Plug 2: Sony PSP. Plug 3: I-Phone. Plug 4: Nokia 8600/6500C. Plug 5: Nintendo DS Lite. Plug 6: Motorola, Android. Plug 7: Samsung Trace/E900.			
			Material: PVC

**ADAPTERS - 12/24 V**

**7-7 PIN**

<b>18201</b> Trailer Adapter			
Std pkg 1			
	Voltage: 24/12		Plug type: 24N, 12N Plug 1: 7 Plug 2: 7 ISO norm: 1724 ISO norm 2: 1185

**ADAPTERS 12 V**

**2-2 PIN**

<b>181622</b> Splitter Cable			
Std pkg 1 Servicing: HC-CARGO 181617			
	Voltage: 12	Cable dim.: 2x1 mm <sup>2</sup> Length: 0.25 m	Plug 1: 2 Plug 2: 2

**7-8 PIN**

<b>181618</b> Trailer Adapter			
Std pkg 1 Servicing: HC-CARGO 181617			
	Voltage: 12	Cable dim.: 6x1 mm <sup>2</sup> Length: 8.5 m	Plug type: 12N, Bayonet Colour: Black Material: ABS plastic Plug 1: 7 Plug 2: 8 ISO norm: 1724

<b>181619</b> Trailer Adapter			
Std pkg 1 Servicing: HC-CARGO 181617			
	Voltage: 12	Cable dim.: 6X1 mm <sup>2</sup> Length: 11 m	Plug type: 12N, Bayonet Colour: Black Material: ABS plastic Plug 1: 7 Plug 2: 8 ISO norm: 1724

<b>181620</b> Trailer Adapter			
Std pkg 1 Servicing: HC-CARGO 181617			
	Voltage: 12	Cable dim.: 6X1 mm <sup>2</sup> Length: 14 m	Plug type: 12N, Bayonet Colour: Black Material: ABS plastic Plug 1: 7 Plug 2: 8 ISO norm: 1724

		EL. SPECIFICATIONS	DIMENSIONS	ADDITIONAL SPECIFICATIONS
<b>181621</b> Trailer Adapter		Std pkg 1	Servicing: HC-CARGO 181617	
		Voltage: 12	Cable dim.: 4x1 mm <sup>2</sup> Length: 2 m	Plug type: 12N, 4 pin Power Seal Colour: Black Material: ABS plastic Plug 1: 7 Plug 2: 4 ISO norm: 1724
<b>7-13 PIN</b>				
<b>180221</b> Trailer Adapter		Std pkg 1	Servicing: Hobby and Hymer caravans - Visit <a href="http://www.hc-cargo.com">www.hc-cargo.com</a> for further information.	
		Voltage: 12	Cable length: 1 m	Plug 1: 7 Plug 2: 13 Cable: w/ ISO norm 1: 11446 ISO norm 2: 1724
<b>181273</b> Trailer Adapter		Std pkg 1	Extremely compact.	
		Voltage: 12		Plug 1: 7 Plug 2: 13 ISO norm 1: 1724 ISO norm 2: 11446
<b>181461</b> Trailer Adapter		Std pkg 1	Connect pos. 2/54 on 7-pin to pos. 9 and 10 on 13-pin. (continuous power supply) and connect 3/31 on 7-pin to pos. 3.11 and 13 on 13-pin.	
		Voltage: 12		Plug 1: 7 Plug 2: 13 ISO norm 1: 1724 ISO norm 2: 11446
<b>181677</b> Trailer Adapter		Std pkg 1	Plug 1: 7 Plug 2: 13 ISO norm 1: 1724 ISO norm 2: 11446	
		Voltage: 12		Plug 1: 7 Plug 2: 13 ISO norm 1: 1724 ISO norm 2: 11446
<b>13-7 PIN</b>				
<b>180213</b> Trailer Adapter		Std pkg 1	Servicing: Hobby and Hymer caravans - Visit <a href="http://www.hc-cargo.com">www.hc-cargo.com</a> for further information.	
		Voltage: 12	Cable length: 0.8 m	Plug 1: 13 Plug 2: 7 Cable: w/ ISO norm 1: 11446 ISO norm 2: 1724
<b>180298</b> Trailer Adapter		Std pkg 1	Plug 1: 13 Plug 2: 7 Cable: w/ ISO norm 1: 11446 ISO norm 2: 1724	
		Voltage: 12		Plug 1: 13 Plug 2: 7 Cable: w/ ISO norm 1: 11446 ISO norm 2: 1724



		EL. SPECIFICATIONS	DIMENSIONS	ADDITIONAL SPECIFICATIONS
<b>180305</b> Trailer Adapter	Std pkg 1		Voltage: 12	Plug 1: 13 Plug 2: 7 ISO norm 1: 11446 ISO norm 2: 1724
<b>180332</b> Trailer Adapter	Std pkg 1		Voltage: 12	Plug type: Multicon Plug 1: 13 Plug 2: 7-13 ISO norm 1: 11446 ISO norm 2: 1724
<b>180373</b> Trailer Adapter	Std pkg 1		Voltage: 12	Cable length: 0.1 mm Plug 1: 7 Plug 2: 13 Cable: w/ ISO norm 1: 11446 ISO norm 2: 1724
<b>180574</b> Trailer Adapter	Std pkg 1		Voltage: 12	Cable length: 0.3 mm Plug type: 12N/12S Plug 1: 13 Plug 2: 7 Cable: w/ ISO norm 1: 11446 ISO norm 2: 1724
<b>180606</b> Trailer Adapter	Std pkg 1	<i>Extremely compact.</i> 	Voltage: 12	Plug 1: 13 Plug 2: 7 ISO norm 1: 11446 ISO norm 2: 1724
<b>181669</b> UK short adapter	Std pkg 1		Service: UK - Visit <a href="http://www.hc-cargo.com">www.hc-cargo.com</a> for further information. Voltage: 12	Plug 1: 13 Plug 2: 2x7 Cable: w/o ISO norm 1: 11446 ISO norm 2: 1724 ISO norm 3: 3732
<b>ADAPTERS 24 V</b>				
<b>15-7 PIN</b>				
<b>180327</b> Trailer Adapter	Std pkg 1		Voltage: 24	Cable dim.: 6x1+1x2.5 mm <sup>2</sup> Cable length: 3.5 mm Plug type: 24N/24S, Europe Colour: Black Material: Polyurethan Plug 1: 15 Plug 2: 2x7 Cable: w/ ISO norm 1: 12098 ISO norm 2: 1185 ISO norm 3: 3731

**180622** Trailer Adapter

Std pkg 1



Voltage: 24

 Plug type: 24N/24S  
 Plug 1: 15  
 Plug 2: 7  
 ISO norm 1: 12098  
 ISO norm 2: 1185  
 ISO norm 3: 3721

**DISTRIBUTOR BOX**
**181617** Distribution Box

Std pkg 1

Trailer Adapter: HC-CARGO 181618, 181619, 181620. Socket w/ cable: HC-CARGO 181621. Splitter Cable: HC-CARGO 181622. Cable w/ connector: HC-CARGO 181623, 181624, 181625, 181626. Bayonet connector: HC-CARGO 181627.

 Dim.: 160x60x120 mm  
 Input: 8 pin  
 Outlet: 6x4 pin + 2x3 pin

Protection degree: IP 54

**TRAILER SOCKETS - 12 V**
**3 PIN**
**180306** Socket

Std pkg 1

 Voltage: 12  
 Amp: 5/25/25

Connection: Terminal

 Colour: Black  
 Material: Plastic  
 No./poles: 3  
 Male/female: Female

**180307** Socket

Std pkg 1

Servicing: HC-CARGO 180308

 Voltage: 12  
 Amp: 5/25/25

Connection: Terminal

 Colour: Black  
 Material: Plastic  
 No./poles: 3  
 Male/female: Female  
 DIN norm: 9680

**7 PIN**
**180110** Trailer Socket

Std pkg 5

Servicing: HC-CARGO 180107, 180108, 180147, 181547

Rubber Gasket: HC-CARGO 180249, 181510, 181612, 181628. Mounting Bracket: HC-CARGO 181583.



Voltage: 12

Connection: Screw

 Plug type: 12N  
 Colour: Black  
 Material: Shock thermo plastic  
 No./poles: 7  
 Male/female: Female  
 DIN norm: 72577  
 ISO norm: 1724

**180150** Coupling Socket

Std pkg 1

Servicing: HC-CARGO 180107, 180108, 180147, 181547



Voltage: 12

Connection: Screw

 Plug type: 12N  
 Colour: Black  
 Material: Shock thermo plastic  
 No./poles: 7  
 Male/female: Female  
 DIN norm: 72579  
 ISO norm: 1724

	EL. SPECIFICATIONS	DIMENSIONS	ADDITIONAL SPECIFICATIONS
<b>180218</b> Trailer Socket      Std pkg 5      Servicing: HC-CARGO 180107, 180108, 180147, 181547 <i>Rubber Gasket: HC-CARGO 180249, 181510, 181612, 181628. Mounting Bracket: HC-CARGO 181583.</i>			
	Voltage: 12	Connection: Screw	Plug type: 12N Colour: Black Material: Cast aluminum No./poles: 7 Male/female: Female DIN norm: 72577 ISO norm: 1724
<b>180239</b> Trailer Socket      Std pkg 5      Servicing: HC-CARGO 180238 <i>w/ changed central contact 7/58L. w/ grey cap. Rubber Gasket: HC-CARGO 180249, 181510, 181612, 181628. Mounting Bracket: HC-CARGO 181583.</i>			
	Voltage: 12	Connection: Screw	Plug type: 12S Colour: Black Material: Shock thermo plastic No./poles: 7 Male/female: Female ISO norm: 3732
<b>180293</b> Trailer Socket      Std pkg 5      Servicing: HC-CARGO 180107, 180108, 180147, 181547 <i>Rubber Gasket: HC-CARGO 180249, 181510, 181612, 181628. Mounting Bracket: HC-CARGO 181583.</i>			
	Voltage: 12	Connection: Terminal	Plug type: 12N Colour: Black Material: Shock thermo plastic No./poles: 7 Male/female: Female DIN norm: 72577 ISO norm: 1724
<b>180620</b> Coupling Socket      Std pkg 1 <i>w/ changed 7/58L contact.</i>			
	Voltage: 12	Connection: Cable	Plug type: 12S Colour: Grey Material: Shock thermo plastic No./poles: 7 Male/female: Female
<b>181485</b> Trailer Socket      Std pkg 5      Servicing: HC-CARGO 180107, 180108, 180147, 181547 <i>w/ rear fog light cut-off. Rubber Gasket: HC-CARGO 180249, 181510, 181612, 181628. Mounting Bracket: HC-CARGO 181583.</i>			
	Voltage: 12	Connection: Screw	Plug type: 12N Colour: Black Material: Shock thermo plastic No./poles: 7 Male/female: Female DIN norm: 72577 ISO norm: 1724
<b>181604</b> Trailer Socket      Std pkg 1      Servicing: HC-CARGO 180107, 180108, 180147, 181547 <i>Micro and mechanical switch.</i>			
	Voltage: 12 Amp: 6	Connection: Screw	Plug type: 12N Colour: Black Material: Shock thermo plastic No./poles: 7 Male/female: Female DIN norm: 72577 ISO norm: 1724

**13 PIN**
**180214** Trailer Socket      Std pkg 1      Servicing: HC-CARGO 180212

*Trailer socket kit: HC-CARGO 180405. Rubber Gasket: HC-CARGO 181582.*

Voltage: 12

Connection: Screw

 Colour: Black  
 Locking device: Bayonet  
 Material: Nickel plated brass  
 No./poles: 13  
 Male/female: Female  
 DIN norm: 72570  
 ISO norm: 11446  
 Protection degree: Splash proof

**181274** Trailer Socket      Std pkg 1      Servicing: HC-CARGO 180212

*w/ micro switch, that switch over the rear fog lamps from car to trailer. Trailer socket kit: HC-CARGO 180405. Rubber Gasket: HC-CARGO 181582.*

Voltage: 12

Connection: Screw

 Colour: Black  
 Locking device: Bayonet  
 Material: Nickel plated brass  
 No./poles: 13  
 Male/female: Female  
 DIN norm: 72570  
 ISO norm: 11446  
 Protection degree: Splash proof

**181576** Coupling Socket      Std pkg 1

Voltage: 12

Connection: Screw

 Colour: Black  
 Material: Shockproof plastic  
 No./poles: 13  
 Male/female: Female  
 ISO norm: 11446

**13-7 PIN**
**180329** Trailer Socket      Std pkg 1      Servicing: HC-CARGO 180330

*w/ micro switch, that switch over the rear fog lamps from car to trailer.*

Voltage: 12

Connection: Screw

 Plug type: Multicon  
 Colour: Black  
 Material: Shock thermo plastic  
 No./poles: 7/13  
 Male/female: Female  
 ISO norm: 1724

**SPARE PARTS**
**180249** Rubber Gasket      Std pkg 10      Servicing: HC-CARGO 180110, 180218, 180239, 180293, 181485

**181510** Rubber Gasket      Std pkg 10      Servicing: HC-CARGO 180110, 180218, 180239, 180293, 181485

**181582** Rubber Gasket Std pkg 1 Servicing: HC-CARGO 180214, 181274  
w/ 90° cable bulge.



Material: Plastics

## TRAILER SOCKETS - 24 V

### 3 PIN

**180402** Trailer Socket Std pkg 1



Voltage: 6/24

Connection: Screw

Colour: Black  
Material: Shock thermo plastic  
No./poles: 3  
Male/female: Female

### 5 PIN

**180243** ABS Socket Std pkg 1

w/ ejector device for correct plug/socket connection. Incl. pins 3x1.5+2x4 mm<sup>2</sup>. Terminal: HC-CARGO 191171, 191172, 191196, 191197.



Voltage: 24

Plug type: ABS  
No./poles: 5  
Male/female: Female  
DIN norm: 74001  
ISO norm: 7638  
Alternativ no.: 181467

**181467** ABS Socket Std pkg 1

Screw connection w/ wirecolour indication.



Voltage: 24

Plug type: ABS  
Locking device: Metal bracket  
No./poles: 5  
Male/female: Female  
ISO norm: 7638  
Alternativ no.: 180243

### 7 PIN

**180112** Trailer Socket Std pkg 1 Servicing: HC-CARGO 180111, 180154

Terminal Coupling: HC-CARGO 180611.



Voltage: 24

Connection: Terminal

Plug type: 24N, Europe  
Colour: Black  
Material: Shock thermo plastic  
No./poles: 7  
Male/female: Female  
DIN norm: 72579  
ISO norm: 1185

**180153** Trailer Socket Std pkg 1 Servicing: HC-CARGO 180111, 180154



Voltage: 24

Connection: Screw

Plug type: 24N, Europe  
Colour: Black  
Material: Shock thermo plastic  
No./poles: 7  
Male/female: Female  
DIN norm: 72579  
ISO norm: 1185

		EL. SPECIFICATIONS	DIMENSIONS	ADDITIONAL SPECIFICATIONS
<b>180219</b> Trailer Socket		Std pkg 1	Servicing: HC-CARGO 180111, 180154	
		Voltage: 24	Connection: Screw	Plug type: 24N, Europe Material: Cast aluminum No./poles: 7 Male/female: Female DIN norm: 72579 ISO norm: 1185
<b>180240</b> Trailer Socket		Std pkg 1	Servicing: HC-CARGO 180610, 180624	
<i>w/ changed 1/31 contact. w/ grey cap.</i>				
		Voltage: 24	Connection: Screw	Plug type: 24S, Europe Colour: Black Material: Shock thermo plastic No./poles: 7 Male/female: Female ISO norm: 3731
<b>180296</b> Trailer Socket		Std pkg 1	Servicing: HC-CARGO 180297	
<i>Terminal Coupling: HC-CARGO 180612.</i>				
		Voltage: 24	Connection: Terminal	Plug type: 24N, Europe Material: Cast aluminum No./poles: 7 Male/female: Female DIN norm: 72579 ISO norm: 1185
<b>180351</b> Trailer Socket		Std pkg 1	Servicing: HC-CARGO 180297	
<i>16x flat tongue. Terminal Coupling: HC-CARGO 180612.</i>				
		Voltage: 24	Connection: Terminal	Plug type: 24N, Europe Material: Cast aluminum No./poles: 7 Male/female: Female DIN norm: 72579 ISO norm: 1185
<b>180568</b> Trailer Socket		Std pkg 1	Servicing: HC-CARGO 180241	
<i>w/ changed 1/31 contact. w/ grey cap. Terminal Coupling: HC-CARGO 180612.</i>				
		Voltage: 24	Connection: Terminal	Plug type: 24S, Europe Colour: Black Material: Shock thermo plastic No./poles: 7 Male/female: Female ISO norm: 3731
<b>180569</b> Trailer Socket		Std pkg 1	Servicing: HC-CARGO 180610, 180624	
<i>w/ changed 1/31 contact. w/ grey cap. Terminal Coupling: HC-CARGO 180611.</i>				
		Voltage: 24	Connection: Terminal	Plug type: 24S, Europe Material: Cast aluminum No./poles: 7 Male/female: Female ISO norm: 3731
<b>180571</b> EBS Socket		Std pkg 1		
<i>w/ ejector device for correct plug/socket connection. Incl. pins 3x1.5+2x4 mm<sup>2</sup>. Terminal: HC-CARGO 191171, 191172, 191196, 191197.</i>				
		Voltage: 24	Connection: Terminal	Plug type: EBS No./poles: 7 Male/female: Female DIN norm: 74001 ISO norm: 7638 Alternativ no.: 181470

		EL. SPECIFICATIONS	DIMENSIONS	ADDITIONAL SPECIFICATIONS
<b>180607</b> Trailer Socket      Std pkg 1      Servicing: HC-CARGO 180111, 180154				
<i>Terminal Coupling: HC-CARGO 180611.</i>				
	Voltage: 24	Connection: Terminal	Plug type: 24N, Europe No./poles: 7 Male/female: Female DIN norm: 72579 ISO norm: 1185 Protection degree: IP 54 ADR-approved: Yes	
<b>180608</b> Trailer Socket      Std pkg 1      Servicing: HC-CARGO 180610, 180624				
<i>w/ changed 1/31 contact. w/ grey cap. Terminal Coupling: HC-CARGO 180611.</i>				
	Voltage: 24	Connection: Terminal	Plug type: 24S, Europe Colour: Black Material: Shock thermo plastic No./poles: 7 Male/female: Female ISO norm: 3731 Protection degree: IP 54 ADR-approved: Yes	
<b>181470</b> EBS Socket      Std pkg 1				
<i>Screw connection w/ wirecolour indication.</i>				
	Voltage: 24		Plug type: EBS Locking device: Metal bracket No./poles: 7 Male/female: Female ISO norm: 7638 Alternativ no.: 180571	
<b>181471</b> EBS Socket      Std pkg 1				
<i>Screw connection w/ wire colour indication. Angled.</i>				
	Voltage: 24		Plug type: EBS Locking device: Bayonet No./poles: 7 ISO norm: 7638	
<b>13 PIN</b>				
<b>180253</b> EBS Socket      Std pkg 1				
<i>Incl. pins 12x1+1x2.5 mm<sup>2</sup>. Weather proof. Terminal: HC-CARGO 191171, 191172, 191196, 191197.</i>				
	Voltage: 24		Plug type: EBS No./poles: 13 Male/female: Female DIN norm: 74001 ISO norm: 12098 ADR-approved: Yes GGVS approval: Yes	
<b>14 PIN</b>				
<b>180352</b> Trailer Socket      Std pkg 1      Servicing: HC-CARGO 180353				
<i>For max. 6 mm<sup>2</sup> cable. Socket and plug can be disconnected automatically.</i>				
	Voltage: 24		Colour: Black Material: Shock thermo plastic No./poles: 14 Male/female: Female	

**15 PIN**
**180286** EBS Socket Std pkg 1

*w/ locking device preventing accidental disengagement. Incl. terminals 10x1.5+2x1+3x2.5 mm<sup>2</sup>. Terminal: HC-CARGO 191171, 191172, 191196, 191197.*

Voltage: 24

 Plug type: EBS  
 No./poles: 15  
 Male/female: Female  
 DIN norm: 72570  
 ISO norm: 12098  
 ADR-approved: Yes  
 GGVS approval: Yes  
 Alternativ no.: 181473

**181473** EBS Socket Std pkg 1

Voltage: 24

Connection: Screw

 Locking device: Metal bracket  
 No./poles: 15  
 Male/female: Female  
 DIN norm: 72570  
 ISO norm: 12098  
 Protection degree: Waterproof  
 ADR-approved: Yes  
 GGVS approval: Yes  
 Alternativ no.: 180286

**181474** EBS Socket Std pkg 1

Voltage: 24

Connection: Screw

 Locking device: Bayonet  
 No./poles: 15  
 Male/female: Female  
 DIN norm: 72570  
 ISO norm: 12098  
 Protection degree: Waterproof  
 ADR-approved: Yes  
 GGVS approval: Yes

**ACCESSORIES**
**180611** Terminal Coupling Std pkg 5 Servicing: HC-CARGO 180112, 180569, 180607, 180608, 180241, 180297

*For trailer sockets.*

Voltage: 24

 Plug type: Europe  
 Colour: White  
 No./poles: 7  
 Male/female: Multiplug

**TRAILER SOCKETS - 6/24 V**
**4 PIN**
**180404** Trailer Socket Std pkg 1

Voltage: 6-24

Connection: Screw

 Colour: Black  
 Material: Shock thermo plastic  
 No./poles: 4  
 Male/female: Female  
 DIN norm: 72575

**TRAILER PLUGS - 12 V**
**3 PIN**
**180308** Plug Std pkg 1 Servicing: HC-CARGO 180307

 Voltage: 12  
 Amp: 5/25/25

Connection: Terminal

 Colour: Black  
 Material: Plastic  
 No./poles: 3  
 Male/female: Male  
 DIN norm: 9680



**7 PIN**
**180107** Trailer Plug Std pkg 5 Servicing: HC-CARGO 180110, 180218, 180293, 181485, 181604

Coupling Socket: HC-CARGO 180150.



Voltage: 12

Connection: Screw

 Plug type: 12N  
 Material: Cast aluminum  
 No./poles: 7  
 Male/female: Male  
 DIN norm: 72577  
 ISO norm: 1724

**180108** Trailer Plug Std pkg 5 Servicing: HC-CARGO 180110, 180218, 180293, 181485, 181604

Coupling Socket: HC-CARGO 180150.



Voltage: 12

Connection: Screw

 Plug type: 12N  
 Colour: Black  
 Material: Shock thermo plastic  
 No./poles: 7  
 Male/female: Male  
 DIN norm: 72577  
 ISO norm: 1724

**180147** Trailer Plug Std pkg 5 Servicing: HC-CARGO 180110, 180218, 180293, 181485, 181604

Coupling Socket: HC-CARGO 180150.



Voltage: 12

Connection: Screw

 Plug type: 12N  
 Mount.: Snap-on  
 Colour: Black  
 Material: Shock thermo plastic w/  
 snap-on session  
 No./poles: 7  
 Male/female: Male  
 DIN norm: 72577  
 ISO norm: 1724

**180238** Trailer Plug Std pkg 5 Servicing: HC-CARGO 180239

w/ changed 7/58L contact.



Voltage: 12

Connection: Screw

 Plug type: 12S  
 Colour: Grey  
 Material: Shock thermo plastic  
 No./poles: 7  
 Male/female: Male  
 ISO norm: 3732

**181547** Trailer Plug Std pkg 5 Servicing: HC-CARGO 180110, 180218, 180293, 181485, 181604

w/ rubber grommet for 1 cable. Grommet for 2 cables: HC-CARGO 181581. Coupling Socket: HC-CARGO 180150.



Voltage: 12

Connection: Terminal

 Plug type: 12N  
 Colour: Black  
 Material: Plastic  
 No./poles: 7  
 Male/female: Male  
 DIN norm: 72577  
 ISO norm: 1724

**13 PIN**
**180212** Trailer Plug Std pkg 1 Servicing: HC-CARGO 180214, 181274

Nickel plated brass pins.



Voltage: 12

Connection: Screw

 Colour: Black  
 Locking device: Bayonet  
 Material: Shock thermo plastic  
 No./poles: 13  
 Male/female: Male  
 DIN norm: 72570  
 ISO norm: 11446  
 Protection degree: Splash proof

**13-7 PIN**
**180330** Trailer Plug Std pkg 1 Servicing: HC-CARGO 180329

+ 6 contacts.



Voltage: 12

Connection: Screw

 Plug type: Multicon  
 Colour: Black  
 Material: Shock thermo plastic  
 No./poles: 7-13  
 Male/female: Male  
 ISO norm: 1724

**181675** Trailer Coil Std pkg 1

Voltage: 12

 Cable dim.:  
 6x1+1x1.5 mm<sup>2</sup>  
 Working length: 1.5 m

 Plug type: 12N  
 Colour: Black  
 Material: Polyurethan  
 Windings: 15  
 Plug 1: 7  
 Plug 2: 13  
 ISO norm 1: 1724  
 ISO norm 2: 11446

**TRAILER PLUGS - 24 V**
**5 PIN**
**180242** ABS Plug Std pkg 1

 Incl. tubes 3x1.5+2x4 mm<sup>2</sup> (HC-CARGO 191170). Terminal: HC-CARGO 191168, 192180, 191169, 192181.

Voltage: 24

Connection: Terminal

 Plug type: ABS  
 Locking device: Metal bracket  
 No./poles: 5  
 Male/female: Male  
 ISO norm: 7638  
 Alternativ no.: 181466

**181466** ABS Plug Std pkg 1

Screw connection w/ wirecolour indication.



Voltage: 24

Connection: Terminal

 Plug type: ABS  
 Locking device: Metal bracket  
 No./poles: 5  
 Male/female: Male  
 ISO norm: 7638  
 Alternativ no.: 180242

**7 PIN**
**180111** Trailer Plug Std pkg 1 Servicing: HC-CARGO 180112, 180153, 180219, 180607

Terminal Coupling: HC-CARGO 180612.



Voltage: 24

Connection: Terminal







 Plug type: 24N, Europe  
 Colour: Black  
 Material: Shock thermo plastic  
 No./poles: 7  
 Male/female: Male  
 DIN norm: 72579  
 ISO norm: 1185

**180154** Trailer Plug Std pkg 1 Servicing: HC-CARGO 180112, 180153, 180219, 180607

Voltage: 24

Connection: Screw

 Plug type: 24N, Europe  
 Colour: Black  
 Material: Shock thermo plastic  
 No./poles: 7  
 Male/female: Male  
 DIN norm: 72579  
 ISO norm: 1185

		EL. SPECIFICATIONS	DIMENSIONS	ADDITIONAL SPECIFICATIONS
<b>180220</b> Trailer Plug		Std pkg 1		
		Voltage: 24	Connection: Screw	Plug type: 24N, Europe Material: Cast aluminum No./poles: 7 Male/female: Male DIN norm: 72579 ISO norm: 1185
<b>180241</b> Trailer Plug		Std pkg 1	Servicing: HC-CARGO 180568	
<i>w/ changed 1/31 contact. w/ grey plastic interior. Terminal Coupling: HC-CARGO 180611.</i>				
		Voltage: 24	Connection: Screw	Plug type: 24S, Europe Colour: Black Material: Shock thermo plastic No./poles: 7 Male/female: Male ISO norm: 3731
<b>180297</b> Trailer Plug		Std pkg 1	Servicing: HC-CARGO 180351, 180296	
<i>Terminal Coupling: HC-CARGO 180611.</i>				
		Voltage: 24	Connection: Terminal	Plug type: 24N, Europe Material: Cast aluminum No./poles: 7 Male/female: Male DIN norm: 72579 ISO norm: 1185
<b>180570</b> EBS Plug		Std pkg 1		
<i>Incl. pins 5x1.5+2x4 mm<sup>2</sup>. w/ locking device. Terminal: HC-CARGO 191168, 192180, 191169, 192181.</i>				
		Voltage: 24	Connection: Terminal	Plug type: EBS Locking device: Metal bracket No./poles: 7 Male/female: Male DIN norm: 40050 ISO norm: 7638 Protection degree: Waterproof Alternativ no.: 181469
<b>180610</b> Trailer Plug		Std pkg 1	Servicing: HC-CARGO 180240, 180569, 180608	
<i>w/ changed 1/31 contact. w/ grey plastic interior.</i>				
		Voltage: 24	Connection: Screw	Plug type: 24S, Europe Colour: Black Material: Shock thermo plastic No./poles: 7 Male/female: Male ISO norm: 3731 Protection degree: IP 54 ADR-approved: Yes
<b>180624</b> Trailer Plug		Std pkg 1	Servicing: HC-CARGO 180240, 180569, 180608	
<i>w/ changed 1/31 contact. w/ grey plastic interior.</i>				
		Voltage: 24	Connection: Screw	Plug type: 24S, Europe Material: Cast aluminum No./poles: 7 Male/female: Male ISO norm: 3731
<b>181469</b> EBS Plug		Std pkg 1		
<i>Screw connection w/ wirecolour indication.</i>				
		Voltage: 24	Connection: Terminal	Plug type: EBS Locking device: Metal bracket No./poles: 7 Male/female: Male ISO norm: 7638 Protection degree: Waterproof Alternativ no.: 180570

## 13 PIN

**180252** EBS Plug Std pkg 1

Incl. pins 12x1+1x2.5 mm<sup>2</sup>. Weather proof. Terminal: HC-CARGO 191168, 192180, 191169, 192181.



Voltage: 24

Connection: Terminal

Plug type: EBS  
No./poles: 13  
Male/female: Male  
DIN norm: 40050  
ISO norm: 7638  
ADR-approved: Yes  
GGVS approval: Yes

## 14 PIN

**180353** Trailer Plug Std pkg 1 Servicing: HC-CARGO 180352

For max. 6 mm<sup>2</sup> cable. Socket and plug can be disconnected automatically.



Voltage: 24

Colour: Black  
Material: Shock thermo plastic  
No./poles: 14  
Male/female: Male

## 15 PIN

**180285** EBS Plug Std pkg 1

Incl. pins 12x1.5+3x2.5 mm<sup>2</sup>. Terminal: HC-CARGO 191168, 192180.



Voltage: 24

Connection: Terminal

Plug type: EBS  
No./poles: 15  
Male/female: Male  
DIN norm: 72570  
ISO norm: 12098  
ADR-approved: Yes  
GGVS approval: Yes  
Alternativ no.: 181472

**181472** EBS Plug Std pkg 1



Voltage: 24

Connection: Screw

Locking device: Metal bracket  
No./poles: 15  
Male/female: Male  
DIN norm: 72570  
ISO norm: 12098  
Protection degree: Waterproof  
GGVS approval: Yes  
Alternativ no.: 180285

## ACCESSORIES

**180612** Terminal Coupling Std pkg 5 Servicing: HC-CARGO 180296, 180351, 180568, 180111



Voltage: 24

Plug type: Europe  
Colour: Red  
No./poles: 7

## TRAILER PLUGS - 6/24 V

### 3 PIN



**180401** Plug Std pkg 1



Voltage: 6-24  
Amp: max. 20

Connection: Screw

Colour: Black  
Material: Shock thermo plastic  
No./poles: 3  
Male/female: Male  
DIN norm: 9680

4 PIN				
<b>180403</b> Plug	Std pkg 1			
		Voltage: 6-24	Connection: Screw	Colour: Black Material: Shock thermo plastic No./poles: 4 Male/female: Male DIN norm: 72575
<b>CABLE KITS 12 V</b>				
<b>7 PIN</b>				
<b>180001</b> Trailer Cable Kit	Std pkg 1			
		Voltage: 12	Length: 1.4 m	Cable type: Single core w/ flex Socket type: 12N Fixing materials: Yes No./poles: 7 Gasket: Yes DIN norm: 72577 ISO norm: 1724
<b>180144</b> Trailer Cable Kit	Std pkg 1			
		Voltage: 12	Length: 1.4 m	Cable type: Multi core Socket type: 12N Fixing materials: Yes No./poles: 7 Gasket: Yes Male/female: Male DIN norm: 72577 ISO norm: 1724
<b>180248</b> Trailer Cable Kit	Std pkg 1			
		Voltage: 12	Length: 2 m	Cable type: Multi core Socket type: 12N Fixing materials: Yes No./poles: 7 Gasket: Yes Male/female: Male DIN norm: 72577 ISO norm: 1724
<b>13 PIN</b>				
<b>180405</b> Trailer Cable Kit	Std pkg 1	Servicing: HC-CARGO 180214, 181274		
<i>w/ rubber gasket.</i>				
		Voltage: 12	Length: 1.8 m	Cable type: Multi core Fixing materials: Yes No./poles: 13 Gasket: Yes DIN norm: 72570 ISO norm: 4091
<b>TRAILER COILS 12 V</b>				
<b>7 PIN</b>				
<b>180225</b> Trailer Coil	Std pkg 1			
		Voltage: 12	Cable dim.: 6x1+1x1.5 mm <sup>2</sup> Working length: 3.5 m	Plug type: 12N, 24N, Europe Colour: Black Material: Polyurethan Windings: 42 Plug 1: 7 Plug 2: 7 ISO norm: 1724

		EL. SPECIFICATIONS	DIMENSIONS	ADDITIONAL SPECIFICATIONS
<b>180372</b> Trailer Coil Std pkg 1			Voltage: 12 Cable dim.: 6x1+1x1.5 mm <sup>2</sup> Working length: 3.5 m	Plug type: 12N, 12N Colour: Black Material: Polyurethan Windings: 42 Plug 1: 7 Plug 2: 7 ISO norm: 1724
<b>180613</b> Trailer Coil Std pkg 1			Voltage: 12 Cable dim.: 6x1+1x1.5 mm <sup>2</sup> Working length: 1.5 m	Plug type: 12N, 12N Colour: Black Material: Polyurethan Windings: 15 Plug 1: 7 Plug 2: 7 ISO norm: 1724
<b>181544</b> Extension Cable Coil Std pkg 1			Voltage: 12 Cable dim.: 6x1.5+1x2 mm <sup>2</sup> Working length: 3.5 m	Plug type: 12N, Europe, 12N, Europe Mount.: Screw Colour: Black Material: Shock thermo plastic Windings: 42 Plug 1: 7 Plug 2: 7 DIN norm: 72577 ISO norm: 1724
<b>13 PIN</b>				
<b>181600</b> Trailer coil Std pkg 1			Voltage: 12 Working length: 3 m	Windings: 17 Plug 1: 13 Plug 2: 13 ISO norm: 11446
<i>Max extension length: 4.5 m.</i>				
<b>TRAILER COILS 24 V</b>				
<b>2 PIN</b>				
<b>181489</b> Trailer Coil Std pkg 1			Voltage: 24 Cable dim.: 2x35 mm <sup>2</sup> Working length: 4 m	Plug type: Nato plug, Nato plug Colour: Red/black Material: Polyurethan Windings: 35 Plug 1: 2 Plug 2: 2
<b>5 PIN</b>				
<b>180247</b> ABS Trailer Coil Std pkg 1			Voltage: 24 Cable dim.: 2x4+3x1.5 mm <sup>2</sup> Working length: 4 m	Plug type: ABS, ABS Material: Polyurethan Plug 1: 5 Plug 2: 5 DIN norm: 74001 ISO norm: 7638

7 PIN			
<b>180194</b> Trailer Coil Std pkg 1			
	Voltage: 24	Cable dim.: 6x1+1x1.5 mm <sup>2</sup> Working length: 3.5 m	Plug type: 12N, 24N, Europe Colour: Black Material: Nylon Windings: 20 Plug 1: 7 Plug 2: 7 ISO norm 1: 1185 ISO norm 2: 1724
<b>180195</b> Trailer Coil Std pkg 1			
<i>Aluminium plug.</i>			
	Voltage: 24	Cable dim.: 6x1+1x1.5 mm <sup>2</sup> Working length: 3.5 m	Plug type: 24N, Europe, 24N, Europe Colour: Black Material: Nylon Windings: 20 Plug 1: 7 Plug 2: 7 DIN norm: 72579 ISO norm: 1185
<b>180196</b> Trailer Coil Std pkg 1			
	Voltage: 24	Cable dim.: 6x1+1x1.5 mm <sup>2</sup> Working length: 3.5 m	Plug type: 24N, Europe, 24N, Europe Colour: Black Material: Nylon Windings: 20 Plug 1: 7 Plug 2: 7 DIN norm: 72579 ISO norm: 1185
<b>180226</b> Trailer Coil Std pkg 1			
	Voltage: 24	Cable dim.: 6x1+1x1.5 mm <sup>2</sup> Working length: 3.5 m	Plug type: 24N, Europe, 24N, Europe Colour: Black Material: Polyurethan Windings: 42 Plug 1: 7 Plug 2: 7 ISO norm: 1185
<b>180227</b> Trailer Coil Std pkg 1			
<i>Aluminium plug.</i>			
	Voltage: 24	Cable dim.: 6x1+1x1.5 mm <sup>2</sup> Working length: 3.5 m	Plug type: 24N, Europe, 24N, Europe Colour: Black Material: Polyurethan Windings: 42 Plug 1: 7 Plug 2: 7 ISO norm: 1185
<b>180228</b> Trailer Coil Std pkg 1			
	Voltage: 24	Cable dim.: 6x1+1x1.5 mm <sup>2</sup> Working length: 3.5 m	Plug type: 24N, Europe, 24N, Europe Mount.: Moulded Colour: Black Material: Polyurethan Windings: 42 Plug 1: 7 Plug 2: 7 ISO norm: 1185
<b>180316</b> Trailer Coil Std pkg 1			
	Voltage: 24	Cable dim.: 6x1+1x1.5 mm <sup>2</sup> Working length: 3.5 m	Plug type: 24S, Europe, 24S, Europe Colour: Black Material: Polyurethan Windings: 42 Plug 1: 7 Plug 2: 7 ISO norm: 3731

		EL. SPECIFICATIONS	DIMENSIONS	ADDITIONAL SPECIFICATIONS	
<b>180572</b> Trailer Coil Std pkg 1			Voltage: 24	Cable dim.: 2x4+5x1.5 mm <sup>2</sup> Working length: 4 m	Plug type: EBS, EBS Material: Polyurethan Plug 1: 7 Plug 2: 7 DIN norm: 74001 ISO norm: 7638
<b>15 PIN</b>					
<b>180251</b> Trailer Coil Std pkg 1			Voltage: 24	Cable dim.: 12x1.5+3x2.5 mm <sup>2</sup> Working length: 3.5 m	Material: Polyurethan Plug 1: 15 Plug 2: 15 ISO norm 1: 4141 ISO norm 2: 6772 ISO norm 3: 12098 GGVS approval: Yes
<b>ACCESSORIES</b>					
<b>180245</b> ABS Sealing Kit Std pkg 1					Socket type: ABS No./poles: 7
<b>181581</b> Rubber Bushing Std pkg 10 Servicing: HC-CARGO 181547 w/ 2 outlets.				OD: 6.5 mm	
<b>181583</b> Mounting Bracket Std pkg 1 Servicing: HC-CARGO 180110, 180218, 180239, 180293, 181485 For trailer socket.				ID: 40 mm OD: 80 mm Dist. mount. holes: 20 mm Mount. hole size: 12 mm	No./mounting holes: 2 (0)
<b>181612</b> Rubber Gasket Std pkg 10 Servicing: HC-CARGO 180110, 180218, 180239, 180293, 181485					Colour: Black Material: EPDM rubber
<b>181623</b> Cable w/ connector Std pkg 1 Servicing: HC-CARGO 181617			Voltage: 12	Cable dim.: 2x1 mm <sup>2</sup> Length: 2 m	Plug type: 2 pin Power Seal Plug: 2



		EL. SPECIFICATIONS	DIMENSIONS	ADDITIONAL SPECIFICATIONS
<b>181624</b> Cable w/ connector	Std pkg 1	Servicing: HC-CARGO 181617 Voltage: 12	Cable dim.: 2x1 mm <sup>2</sup> Length: 3.56 m	Plug type: 2 pin Power Seal Plug: 2
				
<b>181625</b> Cable w/ connector	Std pkg 1	Servicing: HC-CARGO 181617 Voltage: 12	Cable dim.: 4x1 mm <sup>2</sup> Length: 2.3 m	Plug type: 4 pin Power Seal Plug: 4
				
<b>181626</b> Cable w/ connector	Std pkg 1	Servicing: HC-CARGO 181617 Voltage: 12	Cable dim.: 4X1 mm <sup>2</sup> Length: 4.06 m	Plug type: 4 pin Power Seal Plug: 4
				
<b>181627</b> Bayonet connector	Std pkg 1	Servicing: HC-CARGO 181617 Voltage: 12	Cable dim.: 8x1.5-2.5 mm <sup>2</sup>	Mount.: Terminal Locking device: Bayonet No./poles: 8 DIN norm: 72580
				
<b>181628</b> Rubber Gasket	Std pkg 5	Servicing: HC-CARGO 180110, 180218, 180239, 180293, 181485		Colour: Black Material: EPDM rubber
				
<b>NATO CABLE CONNECTORS</b>				
<b>180197</b> Nato Socket	Std pkg 1	Terminal: HC-CARGO 180560. Nato Plug: HC-CARGO 181563, 181611. Rubber Gasket: HC-CARGO 181671. Voltage: 24 Amp: 200	Dim.: 35-50 mm <sup>2</sup> Dist. mount. holes: 82.5/47.6 mm Connection: Solder/crimp	No./mounting holes: 4 No./poles: 2 Male/female: Female Approvals: VG 96917
				
<b>180198</b> Nato Plug	Std pkg 1	Servicing: HC-CARGO 193002 Terminal: HC-CARGO 181670. Voltage: 24 Amp: 200	Dim.: 50 mm <sup>2</sup> Connection: Solder/crimp	Material: Aluminium No./poles: 2 Male/female: Male Approvals: VG 96917
				

180325 Nato Plug		Std pkg 1	
w/ screw device. Terminal: HC-CARGO 181670.			
	Voltage: 24 Amp: 200	Dim.: 50 mm <sup>2</sup> Connection: Solder/ crimp	Material: Metal/Rubber No./poles: 2 Male/female: Male Alternativ no.: 181563
180349 Nato Socket		Std pkg 1	
	Voltage: 24 Amp: 250	Dim.: 70 mm <sup>2</sup> Dist. mount. holes: 85/60 mm Connection: 10 mm ring terminals	No./mounting holes: 4 No./poles: 2 Male/female: Female
180350 Nato Plug		Std pkg 1	
	Voltage: 24 Amp: 250	Dim.: 70 mm <sup>2</sup> Connection: Soldering	No./poles: 2 Male/female: Male
181563 Nato Plug		Std pkg 1 Servicing: HC-CARGO 180197	
Terminal: HC-CARGO 181670.			
	Voltage: 24 Amp: 200	Dim.: 50 mm <sup>2</sup> Connection: Solder/ crimp	No./poles: 2 Male/female: Male Alternativ no.: 180325
181611 Nato Plug		Std pkg 1 Servicing: HC-CARGO 180197	
Terminal: HC-CARGO 180561.			
	Voltage: 24 Amp: Max 300	Dim.: 35 mm <sup>2</sup> Connection: Solder/ crimp	Material: Aluminium No./poles: 2 Male/female: Male Approvals: VG 96917
181630 Nato Socket		Std pkg 1	
Terminal: HC-CARGO 180560. Rubber Gasket: HC-CARGO 181671.			
	Voltage: 24	Dim.: 35-50 mm <sup>2</sup>	Colour: Yellow/black No./mounting holes: 4 No./poles: 2 Male/female: Female Approvals: VG 96917

**193002** Nato Socket

Std pkg 1

Terminal: HC-CARGO 180560. Nato Plug: HC-CARGO 180198. Rubber Gasket: HC-CARGO 181671.



Voltage: 24

 Dim.: 35 mm<sup>2</sup>  
 ID/mount. hole: 6 mm  
 Dist. mount. holes:  
 82x49 mm  
 Connection: Soldering

 Colour: Black  
 Material: Plastic  
 No./mounting holes: 4  
 No./poles: 2  
 Cap: w/  
 Male/female: Female  
 Approvals: VG 96917

**SPARE PARTS**
**180560** Terminal

Std pkg 2 Servicing: HC-CARGO 180197, 181630, 193002

Long.

 Plug length: 67.2 mm  
 Cable size: 35-50 mm<sup>2</sup>

Male/female: Female

**180561** Terminal

Std pkg 2 Servicing: HC-CARGO 181611

 Plug length: 42 mm  
 Cable size: 35 mm<sup>2</sup>

Male/female: Male

**181670** Terminal

Std pkg 1 Servicing: HC-CARGO 180198, 180325, 181563

 Plug length: 42 mm  
 Cable size: 50 mm<sup>2</sup>

Male/female: Male

**ACCESSORIES**
**180199** Nato Coupling

Std pkg 1

 Voltage: 24  
 Amp: 200

 Dim.: 35-50 mm<sup>2</sup>

 No./poles: 2  
 Approvals: VG 96917

**181671** Rubber Gasket

Std pkg 1 Servicing: HC-CARGO 180197, 181630, 193002

 Colour: Black  
 Material: EPDM rubber

## Contact allocation for 7 - 13 and 14 - Pin Sockets

### 7-PIN plugs / sockets 12 V ISO 1724, DIN 72577 (12N)

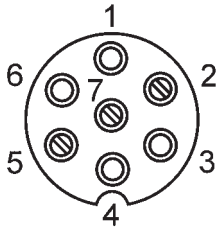

- 1/L) Left-hand direction indicator lamp.
- 2/54G) Rear fog lamp.
- 3/31) Common return.
- 4/R) Right-hand direction indicator lamp.
- 5/58L) Right-hand rear position and end-outline marker lamp, and rear-registration plate illumination device. 1)
- 6/54) Stop lamp.
- 7/58L) Left-hand rear position and end-outline marker lamp, and rear-registration plate illumination device. 1)

1) The rear registration plate illumination device shall be connected in such a manner that no lamp of such a device has a common connection with both contacts 5 and 7.

### 7-PIN plugs / sockets 12 V ISO 3732 (12S)

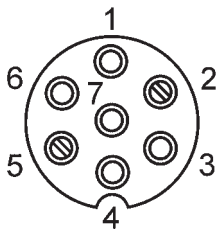

- 1/L) R Reversing lamp. 2)
- 2/54G) Coding for coupled trailer (within the plug pin no. 2 shall be connected to pin no. 3 to signal to the towing vehicle when a trailer is connected).
- 3/31) Common return (for contact no. 4-5).
- 4/R) Continuous power supply.
- 5/58L) Sensing device.
- 6/54) Power supply (controlled by ignition switch).
- 7/58L) Common return (for contact no. 6).

2) The common return for the circuit of this contact will normally be by contact no. 3/31 of the 12N connector according to ISO 1724.

### 7-PIN plugs / sockets 24 V ISO 1185, DIN 72579 (24N)

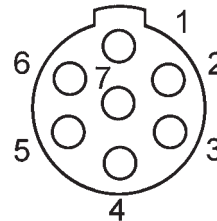

- 1/31) Common return.
- 2/58L) Left-hand rear position and end-outline marker lamp, and rear-registration plate illumination device. 3)
- 3/L) Left-hand direction indicator lamp.
- 4/54) Stop lamp.
- 5/R) Right-hand direction indicator lamp.
- 6/58R) Right-hand rear position and end-outline marker lamp, and rear-registration plate illumination device. 3)
- 7/54G) Braking control for trailers.

3) The rear registration plate illumination device shall be connected in such a manner that no lamp of such a device has a common connection with both contacts 2 and 6.

### 7-PIN plugs / sockets 24 V ISO 3731 (24S)

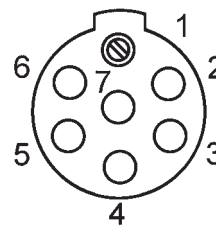

- 1/31) Common return.
- 2/58L) No allocation.
- 3/L) Reversing lamp.
- 4/54) Continuous power supply.
- 5/R) Control via common return.
- 6/58R) Power supply (controlled by ignition switch).
- 7/54G) Rear fog lamp.

13-PIN plugs / sockets  
ISO 11446, DIN 72570  
and 13-PIN Multicon

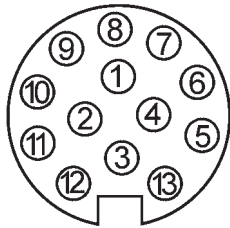

- 1) Left-hand direction indicator lamp.
- 2) Rear fog lamp.
- 3) Common return for contacts nos. 1 to 8. 1)
- 4) Right-hand direction indicator lamp.
- 5) Right-hand rear position and end-outline marker lamp, and rear-registration plate illumination device. 2)
- 6) Stop lamp.
- 7) Left-hand rear position and end-outline marker lamp, and rear-registration plate illumination device. 2)
- 8) Reversing lamp.
- 9) Continuous power supply.
- 10) Power supply (controlled by ignition switch).
- 11) Earth (for contact no. 10). 1)
- 12) Coding for coupled trailer (on the plug, pin no. 12 shall be bridged to pin no. 3 to return to the towing vehicle the information whether a trailer is coupled or not).
- 13) Common return (for contact no. 9). 1)

1) The three common return circuits shall not be connected electrically in the trailer.  
2) The rear registration plate illumination device shall be connected such that no lamp of the device has a common connection with either contact 5 or 7.

VBG contact14

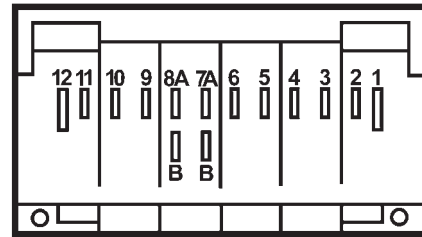

- 1) Common return.
- 2) Left hand direction indicator lamp.
- 3) Right hand direction indicator lamp.
- 4) Stop lamp.
- 5) Left-hand rear position and end-outline marker lamp, and rear-registration plate illumination device.
- 6) Right-hand rear position and end-outline marker lamp, and rear-registration plate illumination device.
- 7) a) Reversing b) Rear fog lamp. lamp.
- 8) a) ..... b) .....
- 9) .....
- 10) .....
- 11) .....
- 12) Charging current.

## Contact Allocation for ABS, EBS and ADR Connections

### ABS / Plugs & Sockets ISO 7638

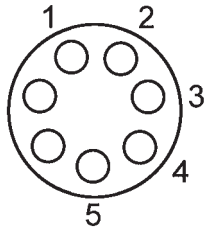

#### Contact allocation w/ electrical features

- |    |                                    |                       |
|----|------------------------------------|-----------------------|
| 1) | Pos. (+) of solenoid valve .....   | 4/6 mm <sup>2</sup> . |
| 2) | Pos. (+) of electronic valve ..... | 1.5 mm <sup>2</sup> . |
| 3) | Neg. (-) of electronic valve ..... | 1.5 mm <sup>2</sup> . |
| 4) | Neg. (-) of solenoid valve .....   | 4/6 mm <sup>2</sup> . |
| 5) | Alarm equipment .....              | 1.5 mm <sup>2</sup> . |

### EBS / Plugs & Sockets ISO 7638

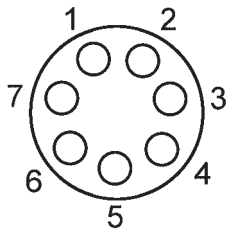

#### Contact allocation w/ electrical features

- |    |                                       |                       |
|----|---------------------------------------|-----------------------|
| 1) | Pos. (+) of solenoid valve .....      | 4/6 mm <sup>2</sup> . |
| 2) | Pos. (+) of electronic valve .....    | 1.5 mm <sup>2</sup> . |
| 3) | Neg. (-) of electronic valve .....    | 1.5 mm <sup>2</sup> . |
| 4) | Neg. (-) of solenoid valve .....      | 4/6 mm <sup>2</sup> . |
| 5) | Alarm equipment .....                 | 1.5 mm <sup>2</sup> . |
| 6) | Reserved for data communication ..... | 1.5 mm <sup>2</sup> . |
| 7) | Reserved for data communication ..... | 1.5 mm <sup>2</sup> . |

### 13-PINS and 15-PINS plugs/sockets DIN 40050 ISO 12098

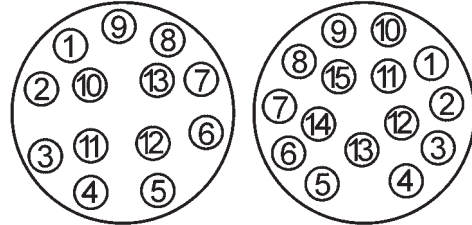

#### Contacts allocation

- 1) Left-hand direction indicator lamp.
- 2) Right-hand direction indicator lamp.
- 3) Rear fog lamp.
- 4) Common return.
- 5) Left-hand rear position and end-outline marker lamp, and rear registration plate illumination device. 1)
- 6) Right-hand rear position and end-outline marker lamp, and rear registration plate illumination device. 1)
- 7) Stop lamp.
- 8) Reversing lamp.
- 9) Power supply (+24V).
- 10) Worn brake lining sensor.
- 11) Pressure sensor for brakes.
- 12) Axle lifting device.
- 13) Common return for contacts 14 and 15.
- 14) Reserved for data communication. 2)
- 15) Reserved for data communication. 2)

1) The rear registration plate illumination shall be connected in such a manner that no lamp device has a common connection with both contacts 5 and 6.  
2) Contacts 14 and 15, which are not used at present, shall be blanked to accept later fitment of pins and sleeves for data transmission functions, which are being designed. These blanks shall permit 13-pole version to mate with 15-pole versions

## FUSES

### TORPEDO

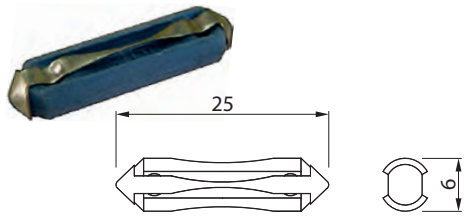

HC-CARGO	Std pkg	Ampere	Voltage	Dim.
190276	Pkg. 50	5	36	25x6 mm
190277	Pkg. 50	8	36	25x6 mm
190278	Pkg. 50	16	36	25x6 mm
190279	Pkg. 50	25	36	25x6 mm
190280	Pkg. 50	40	36	25x6 mm

### CAR RADIO FUSES



HC-CARGO	Std pkg	Ampere	Voltage	Dim.
192721	Pkg. 10	1	250	20x5 mm
190286	Pkg. 10	2	250	20x5 mm
190285	Pkg. 10	5	250	20x5 mm
190734	Pkg. 10	10	250	20x5 mm
191534	Pkg. 10	20	250	20x5 mm
190284	Pkg. 10	63	250	20x5 mm

### GLASS

#### 29X6.3 mm

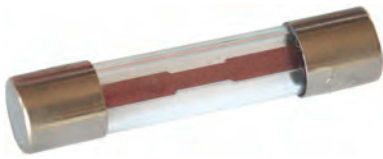

HC-CARGO	Std pkg	Ampere	Voltage	Dim.
190735	Pkg. 10	10	12	29x6.3 mm
191570	Pkg. 10	15	12	29x6.3 mm
191571	Pkg. 10	20	12	29x6.3 mm
190736	Pkg. 10	25	12	29x6.3 mm
191572	Pkg. 10	30	12	29x6.3 mm

#### 32X6.3 mm

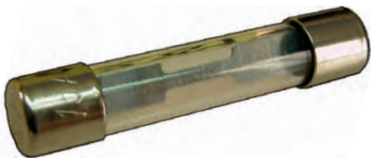

HC-CARGO	Std pkg	Ampere	Voltage	Dim.
190287	Pkg. 10	5	32	32x6.3 mm
190288	Pkg. 10	10	32	32x6.3 mm
190289	Pkg. 10	15	32	32x6.3 mm
190274	Pkg. 10	20	32	32x6.3 mm
190275	Pkg. 10	35	32	32x6.3 mm

### MICRO BLADE

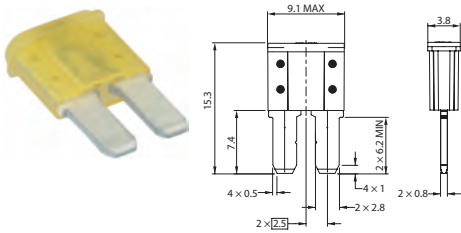

HC-CARGO	Std pkg	HC-CARGO	Std pkg	Ampere	Voltage	Colour
193319*	Pkg. 1	193213	Pkg. 50	5	32	Tan
193321*	Pkg. 1	193215	Pkg. 50	10	32	Red
193322*	Pkg. 1	193216	Pkg. 50	15	32	Blue
193323*	Pkg. 1	193217	Pkg. 50	20	32	Yellow
193324*	Pkg. 1	193218	Pkg. 50	25	32	Transparent
193325*	Pkg. 1	193219	Pkg. 50	30	32	Green
193320*	Pkg. 1	193214	Pkg. 50	75	32	Brown

### MINI BLADE LOW PROFILE

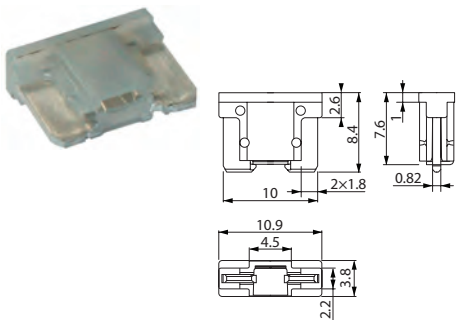

HC-CARGO	Std pkg	HC-CARGO	Std pkg	Ampere	Voltage	Colour
193336*	Pkg. 10	192762	Pkg. 50	2	58	Grey
193337*	Pkg. 10	192763	Pkg. 50	3	58	Purple
193338*	Pkg. 10	192764	Pkg. 50	4	58	Pink
193339*	Pkg. 10	192765	Pkg. 50	5	58	Tan
193341*	Pkg. 10	192767	Pkg. 50	10	58	Red
193342*	Pkg. 10	192768	Pkg. 50	15	58	Blue
193343*	Pkg. 10	192769	Pkg. 50	20	58	Yellow
193344*	Pkg. 10	192770	Pkg. 50	25	58	Nature
193345*	Pkg. 10	192771	Pkg. 50	30	58	Green
193340*	Pkg. 10	192766	Pkg. 50	75	58	Brown

## MINI BLADE

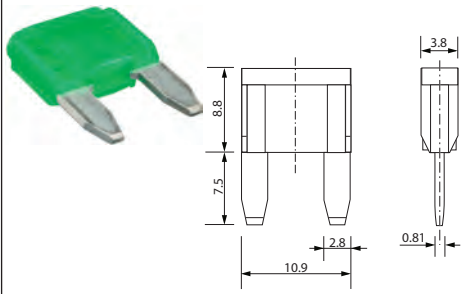

HC-CARGO	Std pkg	HC-CARGO	Std pkg	Ampere	Voltage	Colour
193326*	Pkg. 10	191465	Pkg. 50	2	32	Grey
193327*	Pkg. 10	191466	Pkg. 50	3	32	Purple
193328*	Pkg. 10	191467	Pkg. 50	4	32	Pink
193329*	Pkg. 10	191468	Pkg. 50	5	32	Tan
193331*	Pkg. 10	191470	Pkg. 50	10	32	Red
193332*	Pkg. 10	191471	Pkg. 50	15	32	Blue
193333*	Pkg. 10	191472	Pkg. 50	20	32	Yellow
193334*	Pkg. 10	191473	Pkg. 50	25	32	Nature
193335*	Pkg. 10	191474	Pkg. 50	30	32	Green
193330*	Pkg. 10	191469	Pkg. 50	75	32	Brown

## ATO BLADE

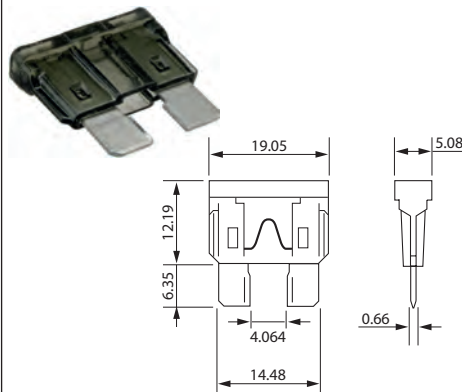

HC-CARGO	Std pkg	HC-CARGO	Std pkg	Ampere	Voltage	Colour
193273*	Pkg. 10	191475	Pkg. 50	1	32	Black
193274*	Pkg. 10	191476	Pkg. 50	2	32	Grey
193275*	Pkg. 10	190053	Pkg. 50	3	32	Purple
193276*	Pkg. 10	190054	Pkg. 50	4	32	Pink
193277*	Pkg. 10	190055	Pkg. 50	5	32	Tan
193279*	Pkg. 10	190057	Pkg. 50	10	32	Red
193280*	Pkg. 10	190058	Pkg. 50	15	32	Blue
193281*	Pkg. 10	190059	Pkg. 50	20	32	Yellow
193282*	Pkg. 10	190060	Pkg. 50	25	32	Nature
193283*	Pkg. 10	190061	Pkg. 50	30	32	Green
193284*	Pkg. 10	192165	Pkg. 50	35	32	Dark blue
193285*	Pkg. 10	191664	Pkg. 50	40	32	Orange
193278*	Pkg. 10	190056	Pkg. 50	75	32	Brown

## MAXI BLADE

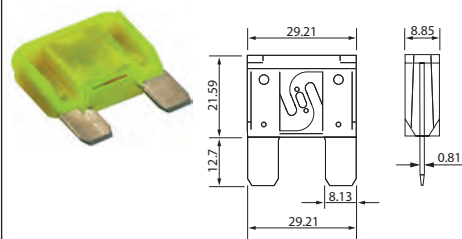

HC-CARGO	Std pkg	HC-CARGO	Std pkg	Ampere	Voltage	Colour
193286*	Pkg. 1	191249	Pkg. 10	20	32	Yellow
193287*	Pkg. 1	191250	Pkg. 10	30	32	Green
193288*	Pkg. 1	191251	Pkg. 10	40	32	Orange
193289*	Pkg. 1	191252	Pkg. 10	50	32	Red
193290*	Pkg. 1	191253	Pkg. 10	60	32	Blue
193291*	Pkg. 1	191254	Pkg. 10	70	32	Beige
193292*	Pkg. 1	191255	Pkg. 10	80	32	Nature
193293*	Pkg. 1	191256	Pkg. 10	100	32	Purple

## MIDI

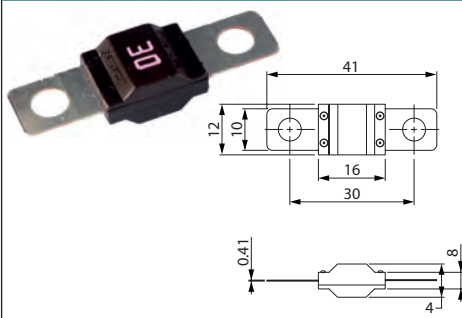

HC-CARGO	Std pkg	HC-CARGO	Std pkg	Ampere	Voltage	Colour
193309*	Pkg. 1	192427	Pkg. 10	30	32	Orange
193310*	Pkg. 1	192428	Pkg. 10	40	32	Green
193311*	Pkg. 1	192429	Pkg. 10	50	32	Red
193312*	Pkg. 1	192430	Pkg. 10	60	32	Yellow
193313*	Pkg. 1	192431	Pkg. 10	70	32	Brown
193314*	Pkg. 1	192432	Pkg. 10	80	32	White
193315*	Pkg. 1	192433	Pkg. 10	100	32	Blue
193316*	Pkg. 1	192434	Pkg. 10	125	32	Pink
193317*	Pkg. 1	192435	Pkg. 10	150	32	White
193318*	Pkg. 1	192976	Pkg. 10	200	32	Purple

## MEGA

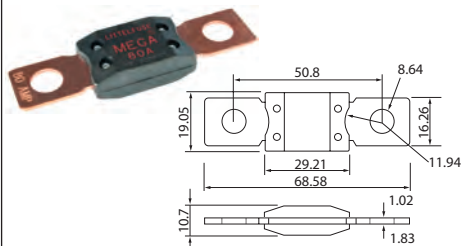

HC-CARGO	Std pkg	HC-CARGO	Std pkg	Ampere	Voltage	Colour
193294*	Pkg. 1	192791	Pkg. 5	40	32	White
193295*	Pkg. 1	192792	Pkg. 5	60	32	White
193296*	Pkg. 1	192793	Pkg. 5	80	32	Red
193297*	Pkg. 1	192049	Pkg. 5	100	32	Yellow
193298*	Pkg. 1	192050	Pkg. 5	125	32	Green
193299*	Pkg. 1	192051	Pkg. 5	150	32	Red
193300*	Pkg. 1	192052	Pkg. 5	175	32	White
193301*	Pkg. 1			200	32	Blue



	HC-CARGO	Std pkg	HC-CARGO	Std pkg	Ampere	Voltage	Colour
	193302*	Pkg. 1	192053	Pkg. 5	200	32	Blue
	193303*	Pkg. 1	192229	Pkg. 5	225	32	Brown
	193304*	Pkg. 1	192230	Pkg. 5	250	32	Pink
	193305*	Pkg. 1	192231	Pkg. 5	300	32	Blue/grey
	193306*	Pkg. 1	192977	Pkg. 5	350	32	Green
	193307*	Pkg. 1	192978	Pkg. 5	400	32	Purple
	193307*	Pkg. 1	192979	Pkg. 5	450	32	Yellow
	193308*	Pkg. 1	192980	Pkg. 5	500	32	Brown

### HSB

	HC-CARGO	Std pkg	Ampere	Voltage	Dim.
	192798	Pkg. 10	30	32	42x12 mm
	192799	Pkg. 10	40	32	42x12 mm
	192800	Pkg. 10	50	32	42x12 mm
	192801	Pkg. 10	60	32	42x12 mm
	192802	Pkg. 10	80	32	42x12 mm
	192803	Pkg. 10	110	32	42x12 mm
	192804	Pkg. 10	150	32	42x12 mm
	192805	Pkg. 10	175	32	42x12 mm

### PAL 293

	HC-CARGO	Std pkg	Ampere	Voltage	Colour
	191638	Pkg. 5	20	32	Blue
	191152	Pkg. 5	30	32	Pink
	191153	Pkg. 5	40	32	Green
	191970	Pkg. 5	50	32	Red
	191154	Pkg. 5	60	32	Yellow

### PAL 2935

	HC-CARGO	Std pkg	Ampere	Voltage	Colour
	191830	Pkg. 5	25	32	Brown
	191831	Pkg. 5	30	32	Green
	191832	Pkg. 5	45	32	Red
	191833	Pkg. 5	65	32	Black
	191834	Pkg. 5	75	32	Grey

### PAL 2938

	HC-CARGO	Std pkg	Ampere	Voltage	Colour
	191672	Pkg. 5	30	32	Pink
	191673	Pkg. 5	40	32	Green

### PAL 294

	HC-CARGO	Std pkg	Ampere	Voltage	Colour
	191155	Pkg. 5	30	32	Pink
	191973	Pkg. 5	40	32	Green
	191974	Pkg. 5	50	32	Red
	191156	Pkg. 5	60	32	Yellow
	191975	Pkg. 5	70	32	Brown
	191157	Pkg. 5	80	32	Black
	191971	Pkg. 5	100	32	Dark blue
	192760	Pkg. 5	120	32	White

## PAL 295

	HC-CARGO	Std pkg	Ampere	Voltage	Colour
	191628	Pkg. 5	30	32	Pink
	191629	Pkg. 5	40	32	Green
	191630	Pkg. 5	50	32	Red
	191631	Pkg. 5	60	32	Yellow
	191632	Pkg. 5	70	32	Brown
	191972	Pkg. 5	80	32	Black
	191977	Pkg. 5	100	32	Dark blue
	192982	Pkg. 5	120	32	White

## PAL 283

	HC-CARGO	Std pkg	Ampere	Voltage	Colour
	191633	Pkg. 5	30	32	Pink
	191634	Pkg. 5	40	32	Green
	191635	Pkg. 5	50	32	Red
	191636	Pkg. 5	60	32	Yellow
	191637	Pkg. 5	70	32	Brown
	191976	Pkg. 5	80	32	Black
	191978	Pkg. 5	100	32	Dark blue
	192981	Pkg. 5	120	32	White

## PAL JCASE

	HC-CARGO	Std pkg	Ampere	Voltage	Colour
	192105	Pkg. 5	20	32	Blue
	192106	Pkg. 5	30	32	Pink
	192107	Pkg. 5	40	32	Green
	192108	Pkg. 5	50	32	Red
	192109	Pkg. 5	60	32	Yellow

## PAL LOW PROFILE

	HC-CARGO	Std pkg	Ampere	Voltage	Colour
	192779	Pkg. 5	20	58	Blue
	192780	Pkg. 5	25	58	White
	192781	Pkg. 5	30	58	Pink
	192782	Pkg. 5	40	58	Green
	192783	Pkg. 5	50	58	Red
	192784	Pkg. 5	60	58	Yellow

## STRIP

### 30 mm

	HC-CARGO	Std pkg	Ampere	Voltage	Length	Lever dim.	DIN norm
	192705	Pkg. 10	25	36	41 mm	5.5 mm	72581/2
	191184	Pkg. 10	30	36	41 mm	5.5 mm	72581/2
	191185	Pkg. 10	40	36	41 mm	5.5 mm	72581/2
	191186	Pkg. 10	50	36	41 mm	5.5 mm	72581/2
	191187	Pkg. 10	60	36	41 mm	5.5 mm	72581/2
	191188	Pkg. 10	80	36	41 mm	5.5 mm	72581/2
	191189	Pkg. 10	100	36	41 mm	5.5 mm	72581/2
	192338	Pkg. 10	150	36	41 mm	5.5 mm	72581/2

### 60 mm

### 9 mm

	HC-CARGO	Std pkg	Ampere	Voltage	Length	Lever dim.	DIN norm
	192298	Pkg. 10	50	48	82 mm	9 mm	43560
	192299	Pkg. 10	80	48	82 mm	9 mm	43560
	192300	Pkg. 10	100	48	82 mm	9 mm	43560
	192301	Pkg. 10	125	48	82 mm	9 mm	43560
	192302	Pkg. 10	160	48	82 mm	9 mm	43560
	192303	Pkg. 10	200	48	82 mm	9 mm	43560
	192304	Pkg. 10	250	48	82 mm	9 mm	43560

### 11 MM

	HC-CARGO	Std pkg	Ampere	Voltage	Length	Lever dim.	DIN norm
	192305	Pkg. 10	35	48	82 mm	11 mm	43560
	192306	Pkg. 10	50	48	82 mm	11 mm	43560
	192307	Pkg. 10	80	48	82 mm	11 mm	43560
	192308	Pkg. 10	100	48	82 mm	11 mm	43560
	192309	Pkg. 10	125	48	82 mm	11 mm	43560
	192310	Pkg. 10	160	48	82 mm	11 mm	43560
	192311	Pkg. 10	200	48	82 mm	11 mm	43560
	192312	Pkg. 10	250	48	82 mm	11 mm	43560
	192313	Pkg. 10	300	48	82 mm	11 mm	43560
	192314	Pkg. 10	355	48	82 mm	11 mm	43560
	192315	Pkg. 10	425	48	82 mm	11 mm	43560
	192316	Pkg. 10	500	48	82 mm	11 mm	43560

### 60 mm, CLOSED TYPE

### 9 mm

	HC-CARGO	Std pkg	Ampere	Voltage	Length	Lever dim.	DIN norm
	192317	Pkg. 5	35	48	82 mm	9 mm	43560
	192318	Pkg. 5	50	48	82 mm	9 mm	43560
	192319	Pkg. 5	80	48	82 mm	9 mm	43560
	192320	Pkg. 5	100	48	82 mm	9 mm	43560
	192321	Pkg. 5	125	48	82 mm	9 mm	43560
	192322	Pkg. 5	160	48	82 mm	9 mm	43560
	192323	Pkg. 5	200	48	82 mm	9 mm	43560
	192324	Pkg. 5	250	48	82 mm	9 mm	43560

### 11 mm



	HC-CARGO	Std pkg	Ampere	Voltage	Length	Lever dim.	DIN norm
	192325	Pkg. 5	35	48	82 mm	11 mm	43560
	192326	Pkg. 5	50	48	82 mm	11 mm	43560
	192327	Pkg. 5	80	48	82 mm	11 mm	43560
	192328	Pkg. 5	100	48	82 mm	11 mm	43560
	192329	Pkg. 5	125	48	82 mm	11 mm	43560
	192330	Pkg. 5	160	48	82 mm	11 mm	43560
	192331	Pkg. 5	200	48	82 mm	11 mm	43560
	192332	Pkg. 5	250	48	82 mm	11 mm	43560
	192333	Pkg. 5	275	48	82 mm	11 mm	43560
	192334	Pkg. 5	300	48	82 mm	11 mm	43560
	192335	Pkg. 5	355	48	82 mm	11 mm	43560
	192336	Pkg. 5	425	48	82 mm	11 mm	43560
192337	Pkg. 5	500	48	82 mm	11 mm	43560	

### COMPACT

	HC-CARGO	Std pkg	Ampere	Voltage	DIN norm	
	192538	Pkg. 5	50	58	72581/3F	w/ ceramic body.
	192539	Pkg. 5	75	58	72581/3F	w/ ceramic body.
	192540	Pkg. 5	100	58	72581/3F	w/ ceramic body.
	192541	Pkg. 5	125	58	72581/3F	w/ ceramic body.
	192542	Pkg. 5	150	58	72581/3F	w/ ceramic body.
	192543	Pkg. 5	175	58	72581/3F	w/ ceramic body.
	192544	Pkg. 5	200	58	72581/3F	w/ ceramic body.
	192545	Pkg. 5	250	58	72581/3F	w/ ceramic body.
	192546	Pkg. 5	300	58	72581/3F	w/ ceramic body.

### ACCESSORIES

192547 Battery Terminal	Std pkg 5	Servicing: Compact fuses - Visit <a href="http://www.hc-cargo.com">www.hc-cargo.com</a> for further information.				
	Amp: 250	Polarity: Positive		No./connections: 1		
				Tin plated: Yes		

<b>192548</b> Battery Terminal	Std pkg 5	Servicing: Compact fuses - Visit <a href="http://www.hc-cargo.com">www.hc-cargo.com</a> for further information.		
		Amp: 250	Polarity: Positive	No./connections: 2 Tin plated: Yes
<b>192549</b> Nut	Std pkg 1	Servicing: Compact fuses - Visit <a href="http://www.hc-cargo.com">www.hc-cargo.com</a> for further information.		
			Spanner size: 19 mm	

## FUSE CARDS



### TORPEDO TYPE

<b>190002</b> Fuse Card	Std pkg 1	Servicing: Compact fuses - Visit <a href="http://www.hc-cargo.com">www.hc-cargo.com</a> for further information.		
<i>Contains: 1x5 A, 4x8 A, 3x16 A, 1x25 A, 1x2 A.</i>				
		Voltage: 36		Type: Torpedo

### ATO BLADE TYPE

<b>190004</b> Fuse Card	Std pkg 1	Servicing: Compact fuses - Visit <a href="http://www.hc-cargo.com">www.hc-cargo.com</a> for further information.		
<i>Contains: 1x3 A, 1x5 A, 1x7.5 A, 2x10 A, 1x15 A, 2x20 A, 1x25 A, 1x30 A.</i>				
		Voltage: 32		Type: ATO

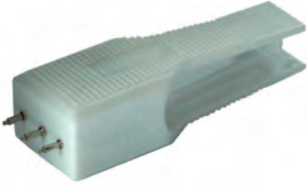
## TESTER/EXTRACTORS

<b>210702</b> Fuse Tester/Puller	Std pkg 1	Servicing: Mini and ATO blade fuses. Max 24 V - Visit <a href="http://www.hc-cargo.com">www.hc-cargo.com</a> for further information.		
				
<b>210841</b> Extractor	Std pkg 10	Servicing: Mini and ATO blade fuse - Visit <a href="http://www.hc-cargo.com">www.hc-cargo.com</a> for further information.		
				
<b>210842</b> Extractor	Std pkg 10	Servicing: Maxi fuses - Visit <a href="http://www.hc-cargo.com">www.hc-cargo.com</a> for further information.		
				

## FUSE BOXES

### TORPEDO TYPE

**190768** Fuse Box Std pkg 1

w/ 8 A fuse.



Type/fuse: Torpedo  
 Plug type: Screw  
 Bracket colour: Transparent  
 Outlets: 2 way  
 No./fuses: 2  
 Fuse incl.: Yes

**190770** Fuse Box Std pkg 1

w/ 8 A fuse.



Type/fuse: Torpedo  
 Plug type: Screw  
 Bracket colour: Transparent  
 Outlets: 4 way  
 No./fuses: 4  
 Fuse incl.: Yes

**190772** Fuse Box Std pkg 1

w/ 8 A fuse.



Type/fuse: Torpedo  
 Plug type: Screw  
 Bracket colour: Transparent  
 Outlets: 6 way  
 No./fuses: 6  
 Fuse incl.: Yes

**190774** Fuse Box Std pkg 1

w/ 8 A fuse.



Type/fuse: Torpedo  
 Plug type: Screw  
 Bracket colour: Transparent  
 Outlets: 8 way  
 No./fuses: 8  
 Fuse incl.: Yes

**190775** Fuse Box Std pkg 1

w/ 8 A fuse.

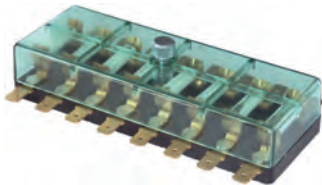

Type/fuse: Torpedo  
 Plug type: Flat  
 Bracket colour: Transparent  
 Outlets: 8 way  
 No./fuses: 8  
 Fuse incl.: Yes

### ATO BLADE TYPE

**191161** Fuse Box Std pkg 1



Type/fuse: ATO  
 Plug type: Flat  
 Bracket colour: Transparent  
 Outlets: 4 way  
 No./fuses: 4  
 Fuse incl.: No

**191162** Fuse Box Std pkg 1



Type/fuse: ATO  
 Plug type: Flat  
 Bracket colour: Transparent  
 Outlets: 6 way  
 No./fuses: 6  
 Fuse incl.: No

		EL. SPECIFICATIONS	DIMENSIONS	ADDITIONAL SPECIFICATIONS
191163	Fuse Box	Std pkg 1		Type/fuse: ATO Plug type: Flat Bracket colour: Transparent Outlets: 8 way No./fuses: 8 Fuse incl.: No
				
191164	Fuse Box	Std pkg 1		Type/fuse: ATO Plug type: Flat Bracket colour: Transparent Outlets: 4 way No./fuses: 4 Fuse incl.: No
				
191165	Fuse Box	Std pkg 1		Type/fuse: ATO Plug type: Flat Bracket colour: Transparent Outlets: 6 way No./fuses: 6 Fuse incl.: No
				
191409	Fuse Box	Std pkg 1		Type/fuse: ATO Plug type: Flat Bracket colour: Transparent Outlets: 16 way No./fuses: 16 Fuse incl.: No
<i>Kit set w/ cover, terminlas and terminal lock. Can be assembled in rows.</i>				
				
192057	Fuse Box	Std pkg 1	Servicing: Blade fuses up to 15 A - Visit <a href="http://www.hc-cargo.com">www.hc-cargo.com</a> for further information.	Type/fuse: ATO Plug type: Flat Bracket colour: Transparent Outlets: 5 way No./fuses: 5 Fuse incl.: No
				
192058	Fuse Box	Std pkg 1	Servicing: Blade fuses up to 15 A - Visit <a href="http://www.hc-cargo.com">www.hc-cargo.com</a> for further information.	Type/fuse: ATO Plug type: Flat Bracket colour: Transparent Outlets: 5 way No./fuses: 5 Fuse incl.: No
				
192484	Fuse Box	Std pkg 1		Type/fuse: ATO Plug type: Flat Bracket colour: Transparent Outlets: 8 way No./fuses: 8 Fuse incl.: No
				

<b>192685</b> Fuse Box <span style="float: right;">Std pkg 1</span> <i>Multi Socket Set: HC-CARGO 192686.</i>			
			Type/fuse: ATO Plug type: Flat Bracket colour: Transparent Outlets: 8 way No./fuses: 8 Fuse incl.: No
<b>192686</b> Multi Socket Set <span style="float: right;">Std pkg 1</span> <span style="float: right;">Servicing: HC-CARGO 192685</span> <i>w/ 4 multi plugs and 2 connectors in each.</i>			
			Plug: Multiplug
<h2>FUSE HOLDERS</h2> <h3>TORPEDO TYPE</h3>			
<b>190273</b> Fuse Holder <span style="float: right;">Std pkg 10</span>			
	Amp/max: 8		Type/fuse: Torpedo Plug type: Screw
<b>190787</b> Fuse Holder <span style="float: right;">Std pkg 10</span>			
	Amp/max: 8		Type/fuse: Torpedo Plug type: Flat
<b>191012</b> Fuse Holder <span style="float: right;">Std pkg 10</span> <i>w/ 16 A fuse.</i>			
	Amp/max: 16		Type/fuse: Torpedo Plug type: Screw
<h3>GLASS TYPE</h3>			
<b>190957</b> Fuse Holder <span style="float: right;">Std pkg 10</span> <i>w/ 2 A radio fuse.</i>			
	Amp/max: <2		Type/fuse: Radio glass Cable incl.: Yes
<h3>MINI BLADE TYPE</h3>			
<b>191768</b> Fuse Holder <span style="float: right;">Std pkg 10</span>			
	Amp/max: 20	Cable dim. max: 2 mm <sup>2</sup>	Type/fuse: Mini blade Material: Rubber Splash proof: Yes Cable incl.: Yes

		EL. SPECIFICATIONS	DIMENSIONS	ADDITIONAL SPECIFICATIONS
<b>191769</b> Fuse Holder Std pkg 10				
		Amp/max: 30	Cable dim. max: 3 mm <sup>2</sup>	Type/fuse: Mini blade Material: Rubber Splash proof: Yes Cable incl.: Yes
<b>ATO BLADE TYPE</b>				
<b>190870</b> Fuse Holder Std pkg 10				
<i>Scotch lock type.</i>				
			Cable dim. max: 2 mm <sup>2</sup> Cable dia. min: 0.8 mm <sup>2</sup>	Type/fuse: ATO Colour: Blue
<b>191001</b> Fuse Holder Std pkg 10				
<i>Can be assembled in rows.</i>				
				Type/fuse: ATO Plug type: Flat
<b>191054</b> Fuse Holder Std pkg 10 Servicing: HC-CARGO 191774				
<i>Can be assembled in rows. Fixing Plate: HC-CARGO 191053. Cover: HC-CARGO 191055.</i>				
				Type/fuse: ATO Plug type: Flat
<b>191640</b> Fuse Holder Std pkg 10				
		Amp/max: 20	Cable dim. max: 1.3 mm <sup>2</sup>	Type/fuse: ATO Material: Rubber Splash proof: Yes Cable incl.: Yes
<b>191680</b> Fuse Holder Std pkg 10				
		Amp/max: 30	Cable dim. max: 3.3 mm <sup>2</sup>	Type/fuse: ATO Material: Rubber Splash proof: Yes Cable incl.: Yes
<b>191774</b> Fuse Holder Kit Std pkg 1				
<i>Contains: 1x HC-CARGO 191053. 1x HC-CARGO 191054. 1x HC-CARGO 191055.</i>				
				



EL. SPECIFICATIONS		DIMENSIONS	ADDITIONAL SPECIFICATIONS
<b>192631 Fuse Holder</b> Std pkg 10 <i>w/ secondary lock. w/ cover and silicone gasket. Terminal: HC-CARGO 191870, 191871, 191872. Single wire seal: HC-CARGO 192647. Fixing Plate: HC-CARGO 192638, 192639.</i>			
		Amp/max: 5	Type/fuse: ATO Colour: Nature Splash proof: Yes Holder incl.: No
<b>192632 Fuse Holder</b> Std pkg 10 <i>w/ secondary lock. w/ cover and silicone gasket. Terminal: HC-CARGO 191870, 191871, 191872. Single wire seal: HC-CARGO 192647.</i>			
		Amp/max: 7.5	Type/fuse: ATO Colour: Brown Splash proof: Yes Holder incl.: No
<b>192633 Fuse Holder</b> Std pkg 10 <i>w/ secondary lock. w/ cover and silicone gasket. Terminal: HC-CARGO 191870, 191871, 191872. Single wire seal: HC-CARGO 192647.</i>			
		Amp/max: 10	Type/fuse: ATO Colour: Red Splash proof: Yes Holder incl.: No
<b>192634 Fuse Holder</b> Std pkg 10 <i>w/ secondary lock. w/ cover and silicone gasket. Terminal: HC-CARGO 191870, 191871, 191872. Single wire seal: HC-CARGO 192647.</i>			
		Amp/max: 15	Type/fuse: ATO Colour: Blue Splash proof: Yes Holder incl.: No
<b>192635 Fuse Holder</b> Std pkg 10 Servicing: Universal - Visit <a href="http://www.hc-cargo.com">www.hc-cargo.com</a> for further information. <i>w/ secondary lock. w/ cover and silicone gasket. Terminal: HC-CARGO 191870, 191871, 191872. Single wire seal: HC-CARGO 192647.</i>			
		Amp/max: 20	Type/fuse: ATO Colour: Yellow Splash proof: Yes Holder incl.: No
<b>192636 Fuse Holder</b> Std pkg 10 <i>w/ secondary lock. w/ cover and silicone gasket. Terminal: HC-CARGO 191870, 191871, 191872. Single wire seal: HC-CARGO 192647.</i>			
		Amp/max: 25	Type/fuse: ATO Colour: White Splash proof: Yes Holder incl.: No
<b>192637 Fuse Holder</b> Std pkg 10 <i>w/ secondary lock. w/ cover and silicone gasket. Terminal: HC-CARGO 191870, 191871, 191872. Single wire seal: HC-CARGO 192647. Fixing Plate: HC-CARGO 192638, 192639.</i>			
		Amp/max: 30	Type/fuse: ATO Colour: Green Splash proof: Yes Holder incl.: No

<b>192759</b> Fuse Holder <i>Can be assembled in rows. w/o terminals.</i>	Std pkg 10	Servicing: HC-CARGO 191411, 191412, 191413, 191870, 191871, 191872			Type/fuse: ATO
<b>192794</b> Fuse Holder <i>w/ mounting bracket. Can be built together w/ relay multi plug. Terminal: HC-CARGO 192986.</i>	Std pkg 10			Type/fuse: ATO Plug type: Flat	
<b>MAXI BLADE TYPE</b>					
<b>191257</b> Maxi Blade Fuse Holder <i>To be assembled in rows. w/o terminals. Terminals: HC-CARGO 191260, 191261, 191262 (2 pcs). Cover: HC-CARGO 191258. Fixing Plate: HC-CARGO 191259.</i>	Std pkg 1	Servicing: HC-CARGO 191775			Type/fuse: Maxi blade Alternativ no.: 193294
<b>191775</b> Maxi Blade Fuse Holder Kit <i>Contains: 1x HC-CARGO 191257. 1x HC-CARGO 191258. 1x HC-CARGO 191259. 2x HC-CARGO 191261.</i>	Std pkg 1			Type/fuse: Maxi blade	
<b>192132</b> Maxi Blade Fuse Holder <i>To be assembled in rows. w/o terminals. w/ bracket. Terminals: HC-CARGO 192134, 192135 (2 pcs). Cover: HC-CARGO 192133.</i>	Std pkg 5	Servicing: HC-CARGO 192137, 192136	Amp/max: 80	Type/fuse: Maxi blade	
<b>192136</b> Maxi Blade Fuse Holder Kit <i>Contains: 1x HC-CARGO 192132, 192133. 2x HC-CARGO 192134, 191554, 190612.</i>	Std pkg 1			Type: Set Type/fuse: Maxi blade	
	Amp/max: 80	Cable dim. max: 6 mm <sup>2</sup> Cable dia. min: 2.5 mm <sup>2</sup>			
<b>192137</b> Maxi Blade Fuse Holder Kit <i>Contains: 1x HC-CARGO 192132, 192133. 2x HC-CARGO 192135, 191554, 190612.</i>	Std pkg 1			Type: Set Type/fuse: Maxi blade	
	Amp/max: 80	Cable dim. max: 10 mm <sup>2</sup> Cable dia. min: 5 mm <sup>2</sup>			

EL. SPECIFICATIONS		DIMENSIONS	ADDITIONAL SPECIFICATIONS
<b>192421</b> Maxi Blade Fuse Holder Kit Std pkg 1			
<i>Contains: 1 splash/waterproof holder, 1 cover, 2 terminals for 4-6 mm cable (HC-CARGO 192486), 2 rubber wire seals.</i>			
	Amp/max: 60	Cable dim. max: 6 mm <sup>2</sup> Cable dia. min: 4 mm <sup>2</sup>	Type: Set Type/fuse: Maxi blade Splash proof: Yes Holder incl.: Yes Cable incl.: Yes
<b>192422</b> Maxi Blade Fuse Holder Kit Std pkg 1			
<i>Contains: 1 cover, 2 terminals for 6-10 mm cable, 2 rubber wire seals.</i>			
	Amp/max: 60	Cable dim. max: 10 mm <sup>2</sup> Cable dia. min: 6 mm <sup>2</sup>	Type: Set Type/fuse: Maxi blade Splash proof: Yes Holder incl.: Yes Cable incl.: Yes
<b>192687</b> Maxi Blade Fuse Holder Kit Std pkg 1			
<i>Contains: 1 splash waterproof holder, 1 cover, 2 terminals for 16 mm<sup>2</sup> cable and 2 wireseals.</i>			
			
<b>193016</b> Fuse Holder Std pkg 1			
	Amp/max: 60	Cable dia. min: 13 mm <sup>2</sup>	Type/fuse: Maxi Colour: Black Cable incl.: Yes
<b>MIDI TYPE</b>			
<b>192436</b> Fuse Holder Std pkg 1			
	Amp/max: 200		Type/fuse: Midi
<b>MEGA TYPE</b>			
<b>192055</b> Mega Blade Fuse Holder Std pkg 1			
<i>2 screws M8.</i>			
	Amp/max: 500		Type/fuse: Mega Plug type: Screw
<b>192423</b> Mega Blade Fuse Holder Std pkg 1			
<i>2 screws M8. Cover: HC-CARGO 192424.</i>			
	Amp/max: 250		Type/fuse: Mega Plug type: Screw Splash proof: Yes

**MICRO BLADE TYPE**
**192864** Fuse Holder Std pkg 10

Amp/max: 10

 Type/fuse: Micro  
 Colour: Black  
 Material: Shockproof plastic  
 Splash proof: Yes  
 Cable incl.: Yes

**JCASE TYPE**
**192952** Fuse Holder Std pkg 1

*Can be used together with JCase + JCase low profile fuses.*

Amp/max: 60

 Type: Single  
 Type/fuse: JCase  
 Colour: Black  
 Material: Rubber  
 Splash proof: Yes  
 Cable incl.: Yes

**VARIOUS**
**191190** Fuse Holder Std pkg 10

*w/o fuse. w/ 2xM5 screws and washers.*

Type/fuse: DIN 72581 strip

**192344** Fuse Holder Std pkg 1

*2 screws M10. w/o fuse.*

 Type: Single  
 Type/fuse: DIN 43560 strip  
 Plug type: Screw

**192345** Fuse Holder Std pkg 1



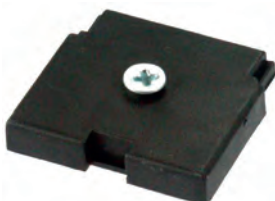

*2 screws M10. w/o fuse.*

 Type: Dual  
 Type/fuse: DIN 43560 strip  
 Plug type: Screw

**ACCESSORIES**
**191053** Fixing Plate Std pkg 25 Servicing: HC-CARGO 191054, 191774

	EL. SPECIFICATIONS	DIMENSIONS	ADDITIONAL SPECIFICATIONS
<b>191055</b> Cover	Std pkg 25	Servicing: HC-CARGO 191054, 191774	Material: Polycarbonate
			
<b>191258</b> Cover	Std pkg 10	Servicing: HC-CARGO 191257, 191775	
			
<b>191259</b> Fixing Plate	Std pkg 10	Servicing: HC-CARGO 191257, 191775	
			
<b>192133</b> Cover	Std pkg 10	Servicing: HC-CARGO 192132, 192136, 192137	
			
<b>192424</b> Cover	Std pkg 1	Servicing: HC-CARGO 192423	Type/fuse: Mega
			
<b>192638</b> Fixing Plate	Std pkg 10	Servicing: HC-CARGO 192631, 192637	
			
<b>192639</b> Fixing Plate	Std pkg 10	Servicing: HC-CARGO 192631, 192637	
			
<b>ADAPTERS</b>			
<b>192419</b> Fuse Adapter	Std pkg 5		
<i>For ATO blade fuse up to 10 A. Adapter for installation of extra fuse for accessories.</i>			
	Voltage: 12 Amp: <10		Type: ATO No./terminals: 2

		EL. SPECIFICATIONS	DIMENSIONS	ADDITIONAL SPECIFICATIONS
<b>192420</b> Fuse Adapter Std pkg 5		<i>For Mini blade fuse up to 10 A. Adapter for installation of extra fuse for accessories. A safe and economical alternative to splicing.</i>		
		Voltage: 12 Amp: <10		Type: Mini blade No./terminals: 2
<b>193265</b> Fuse Adapter Std pkg 5		<i>For Micro blade fuse up to 10 A. Adapter for installation of extra fuse for accessories.</i>		
		Voltage: 12 Amp: 10		Type: Micro No./terminals: 2
<b>INDICATOR LIGHTS</b>				
<b>180014</b> Indicator Light Std pkg 5				
		Voltage: 12/24	Mount. hole size: 17 mm	Socket type: BA9s Colour: Blue Material: Shockproof plastic No./terminals w/screw: 2 Bulb incl.: Yes DIN norm: 72601
<b>180015</b> Indicator Light Std pkg 5				
		Voltage: 12/24	Mount. hole size: 17 mm	Socket type: BA9s Colour: Orange Material: Shockproof plastic No./terminals w/screw: 2 Bulb incl.: No DIN norm: 72601
<b>180016</b> Indicator Light Std pkg 5				
		Voltage: 12/24	Mount. hole size: 17 mm	Socket type: BA9s Colour: Green Material: Shockproof plastic No./terminals w/screw: 2 Bulb incl.: Yes DIN norm: 72601
<b>180017</b> Indicator Light Std pkg 5				
		Voltage: 12/24	Mount. hole size: 17 mm	Socket type: BA9s Colour: Red Material: Shockproof plastic No./terminals w/screw: 2 Bulb incl.: Yes DIN norm: 72601
<b>180343</b> Indicator Light Std pkg 5				
		Voltage: 12 Watt: 1.2	Terminals: 2.8 mm Mount. hole size: 10 mm	Type/terminal: Flat Colour: Orange Material: Shockproof plastic No./terminals: 2 Bulb incl.: Yes

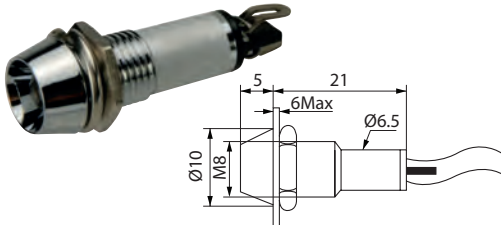
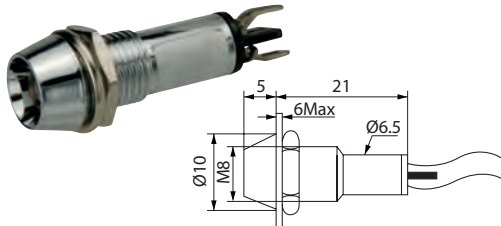
		EL. SPECIFICATIONS	DIMENSIONS	ADDITIONAL SPECIFICATIONS
<b>180344</b> Indicator Light	Std pkg 5	Servicing: Renault, VW - Visit <a href="http://www.hc-cargo.com">www.hc-cargo.com</a> for further information. Voltage: 12 Watt: 1.2	Terminals: 2.8 mm Mount. hole size: 10 mm	Type/terminal: Flat Colour: Green Material: Shockproof plastic No./terminals: 2 Bulb incl.: Yes
				
<b>180345</b> Indicator Light	Std pkg 5	Voltage: 12 Watt: 1.2	Terminals: 2.8 mm Mount. hole size: 10 mm	Type/terminal: Flat Colour: Red Material: Shockproof plastic No./terminals: 2 Bulb incl.: Yes
				
<b>180346</b> Indicator Light	Std pkg 5	Voltage: 24 Watt: 1.2	Terminals: 2.8 mm Mount. hole size: 10 mm	Type/terminal: Flat Colour: Orange Material: Shockproof plastic No./terminals: 2 Bulb incl.: Yes
				
<b>180347</b> Indicator Light	Std pkg 5	Voltage: 24 Watt: 1.2	Terminals: 2.8 mm Mount. hole size: 10 mm	Type/terminal: Flat Colour: Green Material: Shockproof plastic No./terminals: 2 Bulb incl.: Yes
				
<b>180348</b> Indicator Light	Std pkg 5	Voltage: 24 Watt: 1.2	Terminals: 2.8 mm Mount. hole size: 10 mm	Type/terminal: Flat Colour: Red Material: Shockproof plastic No./terminals: 2 Bulb incl.: Yes
				
<b>LED</b>				
<b>181570</b> Indicator Light	Std pkg 5	Voltage: 24	Mount. hole size: 8 mm	Type/terminal: Solder Bulb type: LED Colour: Red Material: Nickel plated brass
				
<b>181571</b> Indicator Light	Std pkg 5	Voltage: 24	Mount. hole size: 8 mm	Type/terminal: Solder Bulb type: LED Colour: Green Material: Nickel plated brass
				

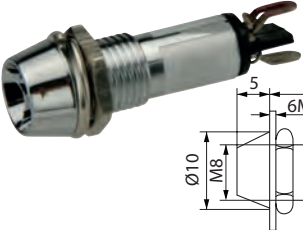
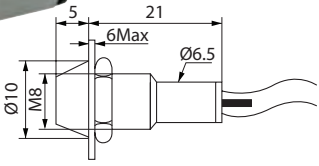
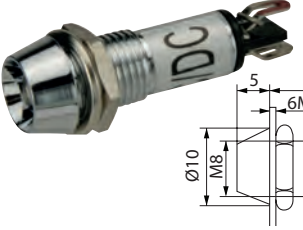
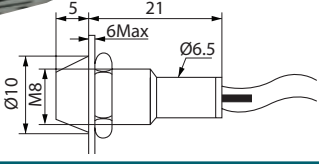
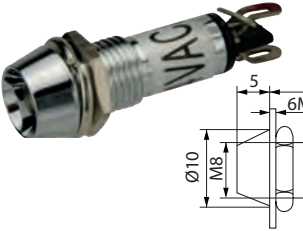
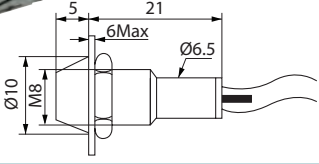
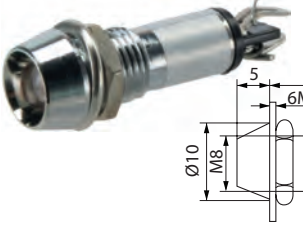
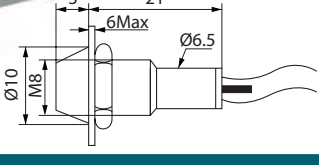
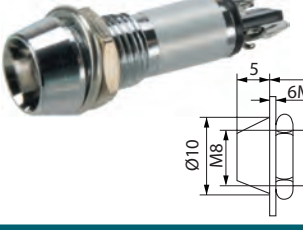
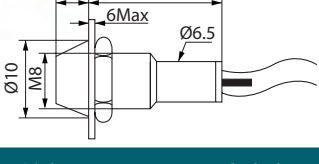
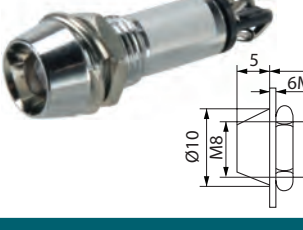
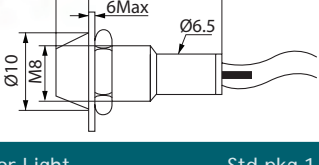
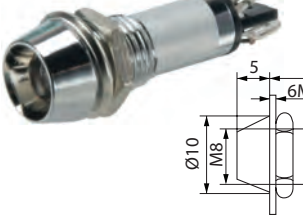
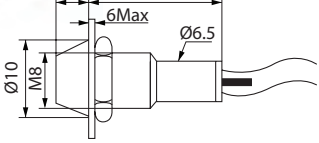
		EL. SPECIFICATIONS	DIMENSIONS	ADDITIONAL SPECIFICATIONS
<b>181572</b> Indicator Light	Std pkg 5	Voltage: 24	Mount. hole size: 8 mm	Type/terminal: Solder Bulb type: LED Colour: Yellow Material: Nickel plated brass
				
<b>181573</b> Indicator Light	Std pkg 5	Voltage: 24	Mount. hole size: 8 mm	Type/terminal: Solder Bulb type: LED Colour: Blue Material: Nickel plated brass
				
<b>181574</b> Indicator Light	Std pkg 5	Voltage: 24	Mount. hole size: 8 mm	Type/terminal: Solder Bulb type: LED Colour: White Material: Nickel plated brass
				
<b>181633</b> Indicator Light	Std pkg 1	Voltage: 12	Mount. hole size: 8 mm	Type/terminal: Solder Bulb type: LED Colour: Red Material: Nickel plated brass
				
<b>181634</b> Indicator Light	Std pkg 1	Voltage: 12	Mount. hole size: 8 mm	Type/terminal: Solder Bulb type: LED Colour: Green Material: Nickel plated brass
				
<b>181635</b> Indicator Light	Std pkg 1	Voltage: 12	Mount. hole size: 8 mm	Type/terminal: Solder Bulb type: LED Colour: Yellow Material: Nickel plated brass
				
<b>181636</b> Indicator Light	Std pkg 1	Voltage: 12	Mount. hole size: 8 mm	Type/terminal: Solder Bulb type: LED Colour: Blue Material: Nickel plated brass
				



**181637** Indicator Light

Std pkg 1

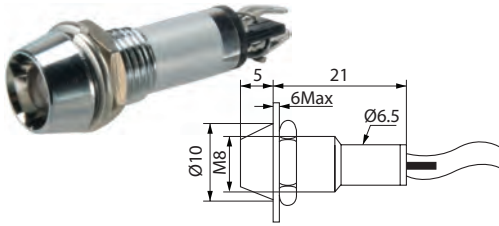

Voltage: 12

Mount. hole size:  
8 mm

Type/terminal: Solder  
Bulb type: LED  
Colour: White  
Material: Nickel plated brass

**CIRCUIT BREAKERS**

**ATO BLADE FUSE TYPE**



	HC-CARGO	Std pkg	Ampere	Voltage	Type	
	<b>192936</b>	Pkg. 1	5	0-28	ATO	Manual reset.
	<b>192937</b>	Pkg. 1	7.5	0-28	ATO	Manual reset.
	<b>192938</b>	Pkg. 1	10	0-28	ATO	Manual reset.
	<b>192939</b>	Pkg. 1	15	0-28	ATO	Manual reset.
	<b>192940</b>	Pkg. 1	20	0-28	ATO	Manual reset.
	<b>192941</b>	Pkg. 1	25	0-28	ATO	Manual reset.

**PANEL MOUNT TYPE**

**192959** Circuit Breaker

Std pkg 1

Servicing: Motors, transformers, battery chargers, machinery, extra low voltage systems

Circuit breaker w/ thread neck for panel mounting. Mounting hole 9.6 mm. Splash Proof Cover: HC-CARGO 192965.



Voltage: Multi  
Amp: 5

Length: 79.4 mm

Type: Thermo contact  
Plug type: Flat

**192960** Circuit Breaker

Std pkg 1

Servicing: Motors, transformers, battery chargers, machinery, extra low voltage systems

Circuit breaker w/ thread neck for panel mounting. Mounting hole 9.6 mm. Splash Proof Cover: HC-CARGO 192965.



Voltage: Multi  
Amp: 7

Length: 79.4 mm

Type: Thermo contact  
Plug type: Flat

**192961** Circuit Breaker

Std pkg 1

Servicing: Motors, transformers, battery chargers, machinery, extra low voltage systems

Circuit breaker w/ thread neck for panel mounting. Mounting hole 9.6 mm. Splash Proof Cover: HC-CARGO 192965.



Voltage: Multi  
Amp: 10

Length: 79.4 mm

Type: Thermo contact  
Plug type: Flat

**192962** Circuit Breaker

Std pkg 1

Servicing: Motors, transformers, battery chargers, machinery, extra low voltage systems

Circuit breaker w/ thread neck for panel mounting. Mounting hole 9.6 mm. Splash Proof Cover: HC-CARGO 192965.



Voltage: Multi  
Amp: 15

Length: 79.4 mm

Type: Thermo contact  
Plug type: Flat

**192963** Circuit Breaker

Std pkg 1

Servicing: Motors, transformers, battery chargers, machinery, extra low voltage systems

Circuit breaker w/ thread neck for panel mounting. Mounting hole 9.6 mm. Splash Proof Cover: HC-CARGO 192965.



Voltage: Multi  
Amp: 20

Length: 79.4 mm

Type: Thermo contact  
Plug type: Flat

		EL. SPECIFICATIONS	DIMENSIONS	ADDITIONAL SPECIFICATIONS						
<b>192964</b> Circuit Breaker      Std pkg 1      Servicing: Motors, transformers, battery chargers, machinery, extra low voltage systems <i>Circuit breaker w/ thread neck for panel mounting. Mounting hole 9.6 mm. Splash Proof Cover: HC-CARGO 192965.</i>										
		Voltage: Multi Amp: 25	Length: 79.4 mm	Type: Thermo contact Plug type: Flat						
<b>ACCESSORIES</b>										
<b>192965</b> Splash Proof Cover      Std pkg 1      Servicing: HC-CARGO 192959, 192960, 192961, 192962, 192963, 192964										
										
<b>RELAYS</b>										
<b>DAYTIME RUNNING LIGHTS</b>										
<b>160278</b> Relay      Std pkg 1      Servicing: HC-CARGO 160274 <i>To be used on vehicles w/ alternator w/o diodetrio.</i>										
		<table border="1" data-bbox="403 929 520 1146"> <tr><td>14</td><td>24</td></tr> <tr><td>13</td><td>23</td></tr> <tr><td>a</td><td>b</td></tr> </table>	14	24	13	23	a	b	Voltage: 12	No./terminals: 6
14	24									
13	23									
a	b									
<b>160904</b> Relay      Std pkg 1      Servicing: Opel, Vauxhall - Visit <a href="http://www.hc-cargo.com">www.hc-cargo.com</a> for further information. <i>For day time running light.</i>										
		Voltage: 12		No./terminals: 8						
<b>161711</b> Daytime Running Light      Std pkg 1      Servicing: Most european and japanese vehicles - Visit <a href="http://www.hc-cargo.com">www.hc-cargo.com</a> for further information. <i>Complete w/ relays, wires and connecting material. Fitting instruction included.</i>										
		Voltage: 12		Alternativ no.: 160274AT						
<b>ACOUSTIC WARNING</b>										
<b>160276</b> Warning Relay      Std pkg 1      Servicing: Nissan - Visit <a href="http://www.hc-cargo.com">www.hc-cargo.com</a> for further information. <i>Light's on warning.</i>										
		Voltage: 12 Decibel: 85		No./terminals: 2						

<b>160347</b> Warning Relay Std pkg 1		Voltage: 12 Decibel: 72	Type: Electronic No./terminals: 2

<b>160509</b> Warning Relay Std pkg 1		Voltage: 12 Decibel: Min 65	Type: Electronic No./terminals: 3

**WORK RELAYS**

**MINI - 6 V**

<b>160652</b> Mini Relay Std pkg 1		Voltage: 6 Amp: 20	No./terminals: 4 Bracket: w/

**MINI - 12 V**

<b>160080</b> Mini Relay Std pkg 1		Voltage: 12 Amp: 30	No./terminals: 4 Bracket: w/ Alternativ no.: 420017

<b>160083</b> Mini Relay Std pkg 1		Servicing: BMW - Visit <a href="http://www.hc-cargo.com">www.hc-cargo.com</a> for further information.	
		Voltage: 12 Amp: 30	No./terminals: 4 Bracket: w/

<b>160155</b> Mini Relay Std pkg 1		Voltage: 12 Amp: 30	Type/fuse: ATO No./terminals: 4 Bracket: w/ Fuse incl.: Yes

**160265 Mini Relay**

Std pkg 1

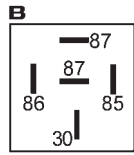
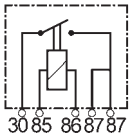
 Voltage: 12  
Amp: 30

 No./terminals: 5  
Bracket: w/

**160282 Mini Relay**

Std pkg 1

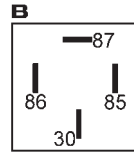
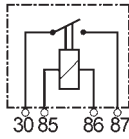
 Servicing: Kia - Visit [www.hc-cargo.com](http://www.hc-cargo.com) for further information.

 Voltage: 12  
Amp: 40

No./terminals: 4

**160311 Mini Relay**

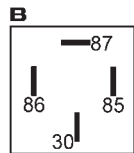
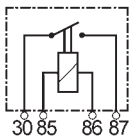
Std pkg 1

 Voltage: 12  
Amp: 40

 No./terminals: 4  
Bracket: w/

**160480 Mini Relay**

Std pkg 1

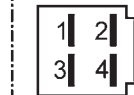
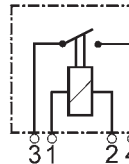
 Voltage: 12  
Amp: 30

 No./terminals: 4  
Bracket: w/

**160903 Mini Relay**

Std pkg 1

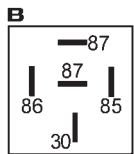
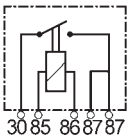
 Voltage: 12  
Amp: 40

 No./terminals: 5  
Bracket: w/

**160929 Mini Relay**

Std pkg 1

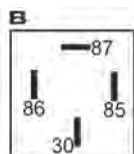
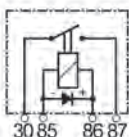
 Voltage: 12  
Amp: 40

 No./terminals: 4  
Bracket: w/  
Diode: w/

**160945 Mini Relay**

Std pkg 1

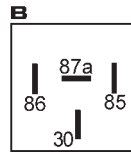
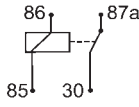
 Voltage: 12  
Amp: 20

 No./terminals: 4  
Bracket: w/

**160982 Mini Relay**

Std pkg 1

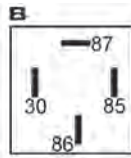
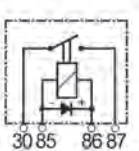
 Voltage: 12  
Amp: 40

 No./terminals: 4  
Bracket: w/  
Diode: w/

**160983 Mini Relay**

Std pkg 1

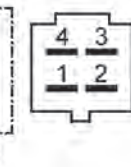
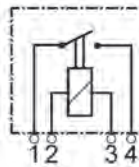
 Voltage: 12  
Amp: 30

 Type: Japanese  
No./terminals: 4  
Bracket: w/

**161009 Mini Relay**

Std pkg 1

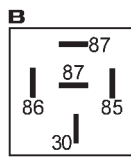
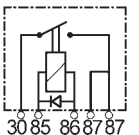

 Voltage: 12  
Amp: 40

 No./terminals: 5  
Bracket: w/  
Diode: w/

**MINI - 12 V HIGH PERFORMANCE**
**160239 Mini Relay**

Std pkg 1

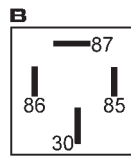
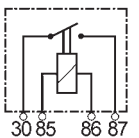
w/ two 6.3 mm and two 9.5 mm terminals. (terminals 30 and 87).



 Voltage: 12  
Amp: 70

 Type: High performance  
No./terminals: 4  
Bracket: w/

**160468 Mini Relay**

Std pkg 1

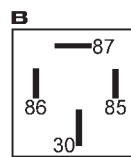
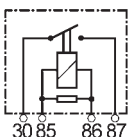
w/ two 6.3 mm and two 9.5 mm terminals. (terminals 30 and 87).



 Voltage: 12  
Amp: 70

 Type: High performance  
No./terminals: 4  
Resistor: w/

**160477 Mini Relay**

Std pkg 1

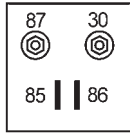
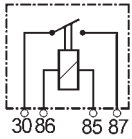
180 A for 15 sec. w/ 2x6.3 mm screws and 2xM6 flat plugs.

 Voltage: 12  
Amp: 100

 Type: High performance  
No./terminals: 4  
Bracket: w/  
Alternativ no.: 160477z

**160720 Mini Relay**

Std pkg 1

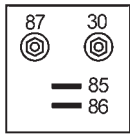
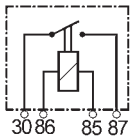
 Voltage: 12  
Amp: 120

 Type: High performance  
No./terminals: 4  
Bracket: w/

**160922 Mini Relay**

Std pkg 1

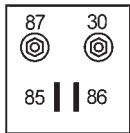
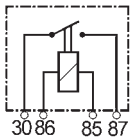
 Voltage: 12  
Amp: 140

 Type: High performance  
No./terminals: 4  
Bracket: w/

**160923 Mini Relay**

Std pkg 1

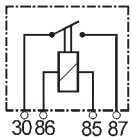

 Voltage: 12  
Amp: 200

 Type: High performance  
No./terminals: 4  
Bracket: w/

**160931 Mini Relay**

Std pkg 1

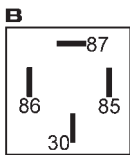
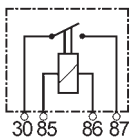
Terminal 85+86=6.3 mm. Terminal 87+30=8 mm.



 Voltage: 12  
Amp: 50

 Type: High performance  
No./terminals: 4  
Bracket: w/

**160940 Mini Relay**

Std pkg 1

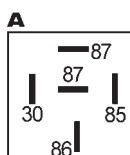
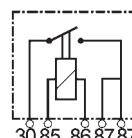
w/ double output.

 Voltage: 12  
Amp: 40

 Type: High performance  
No./terminals: 5  
Bracket: w/

**160941 Mini Relay** Std pkg 1

w/ two 6.3 mm and two 9.5 mm terminals. (terminals 30 and 87).

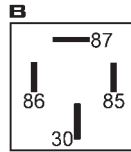
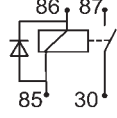
 Voltage: 12  
Amp: 70

 Type: High performance  
No./terminals: 4  
Bracket: w/  
Diode: w/

**160946 Mini Relay** Std pkg 1

w/ two 6.3 mm and two 9.5 mm terminals. (terminals 30 and 87).

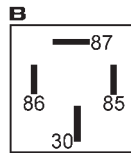
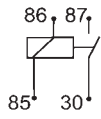
 Voltage: 12  
Amp: 100

 Type: High performance  
No./terminals: 4

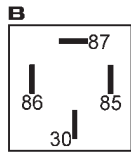
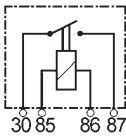
**MINI - 24 V**
**160082 Mini Relay** Std pkg 1

 Voltage: 24  
Amp: 20

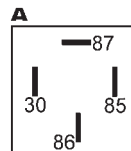
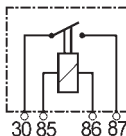
 No./terminals: 4  
Bracket: w/  
Alternativ no.: 160307

**160215 Mini Relay** Std pkg 1

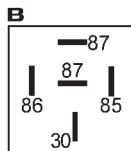
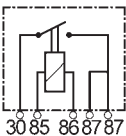
 Voltage: 24  
Amp: 20

No./terminals: 4

**160266 Mini Relay** Std pkg 1

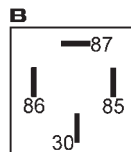
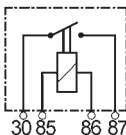
 Voltage: 24  
Amp: 20

 No./terminals: 5  
Bracket: w/

**160307 Mini Relay** Std pkg 1

 Voltage: 24  
Amp: 20

No./terminals: 4

**160473 Mini Relay**

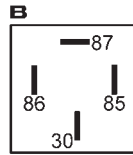
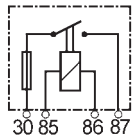
Std pkg 1

 Voltage: 24  
Amp: 30

 Type/fuse: ATO  
No./terminals: 4  
Bracket: w/  
Fuse incl.: Yes

**160890 Mini Relay**

Std pkg 1

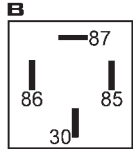
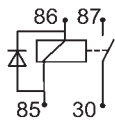
 Voltage: 24  
Amp: 20

 No./terminals: 4  
Bracket: w/  
Diode: w/

**160926 Mini Relay**

Std pkg 1

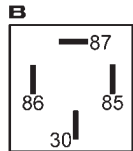
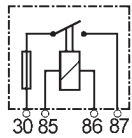
 Voltage: 24  
Amp: 15

 Type/fuse: ATO  
No./terminals: 4  
Bracket: w/  
Fuse incl.: Yes

**160935 Mini Relay**

Std pkg 1

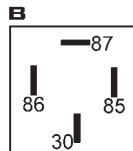
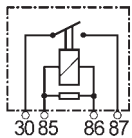
 Voltage: 24  
Amp: 22

 No./terminals: 4  
Bracket: w/  
Resistor: w/

**160936 Mini Relay**

Std pkg 1

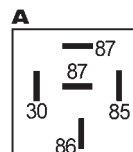
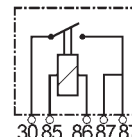
*w/ double output.*

 Voltage: 24  
Amp: 22

 No./terminals: 5  
Bracket: w/

**160947 Mini Relay**

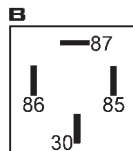
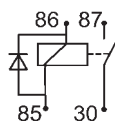
Std pkg 1



 Voltage: 24  
Amp: 30

 No./terminals: 4  
Bracket: w/  
Diode: w/

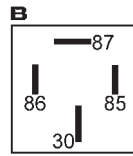
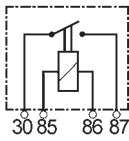

**MINI - 24 V HIGH PERFORMANCE**
**160240** Mini Relay

Std pkg 1

*w/ two 6.3 mm and two 9.5 mm terminals. (terminals 30 and 87).*

 Voltage: 24  
Amp: 40

 Type: High performance  
No./terminals: 4

**160272** Mini Relay

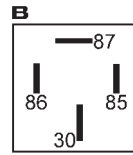
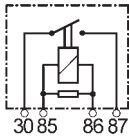
Std pkg 1

*w/ two 6.3 mm and two 9.5 mm terminals. (terminals 30 and 87).*

 Voltage: 24  
Amp: 70

 Type: High performance  
No./terminals: 4  
Resistor: w/

**160478** Mini Relay

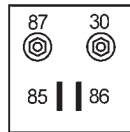
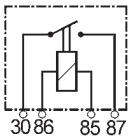
Std pkg 1

*180 A for 15 sec. w/ 2x6.3 mm screws and 2xM6 flat plugs.*

 Voltage: 24  
Amp: 60

 Type: High performance  
No./terminals: 4  
Bracket: w/

**160721** Mini Relay

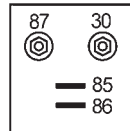
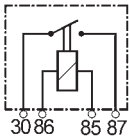
Std pkg 1

*w/ two 6.3 mm and two 9.5 mm terminals. (terminals 30 and 87).*

 Voltage: 24  
Amp: 100

 Type: High performance  
No./terminals: 4  
Bracket: w/

**160769** Mini Relay

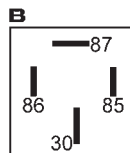
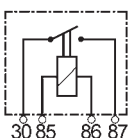
Std pkg 1

*w/ two 6.3 mm and two 9.5 mm terminals. (terminals 30 and 87).*

 Voltage: 24  
Amp: 70

 Type: High performance  
No./terminals: 4

**160937** Mini Relay

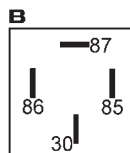
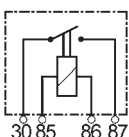
Std pkg 1

*w/ two 6.3 mm and two 9.5 mm terminals. (terminals 30 and 87).*

 Voltage: 24  
Amp: 40

 Type: High performance  
No./terminals: 4  
Bracket: w/

**160975 Mini Relay**

Std pkg 1

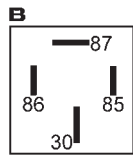
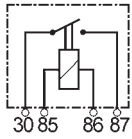
w/ two 6.3 mm and two 9.5 mm terminals. (terminals 30 and 87).



 Voltage: 24  
Amp: 70

 Type: High performance  
No./terminals: 4  
Bracket: w/

**160977 Mini Relay**

Std pkg 1

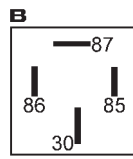
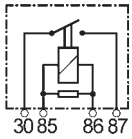
w/ two 6.3 mm and two 9.5 mm terminals. (terminals 30 and 87).



 Voltage: 24  
Amp: 50

 Type: High performance  
No./terminals: 4  
Bracket: w/  
Resistor: w/

**160978 Mini Relay**

Std pkg 1

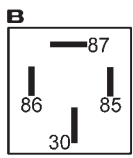
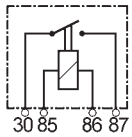
w/ two 6.3 mm and two 9.5 mm terminals. (terminals 30 and 87).

 Voltage: 24  
Amp: 40

 Type: High performance  
No./terminals: 4

**160979 Mini Relay**

Std pkg 1

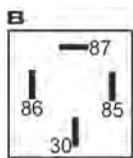
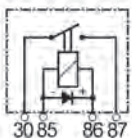
 Voltage: 24  
Amp: 30

 Type: High performance  
No./terminals: 4  
Bracket: w/  
Diode: w/

**161035 Mini Relay**

Std pkg 1

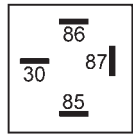
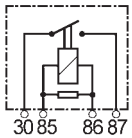
 Servicing: Scania - Visit [www.hc-cargo.com](http://www.hc-cargo.com) for further information.

 Voltage: 24  
Amp: 70

 Type: High performance  
No./terminals: 4  
Bracket: w/  
Resistor: w/

**MICRO**
**160363 Micro Relay**

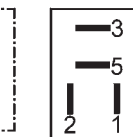
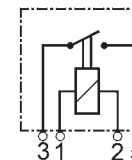
Std pkg 1

 Voltage: 12  
Amp: 30

No./terminals: 4

**160364** Micro Relay

Std pkg 1

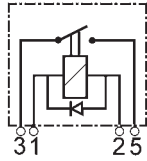

Voltage: 12  
Amp: 25

No./terminals: 4  
Diode: w/

**160918** Micro Relay

Std pkg 1

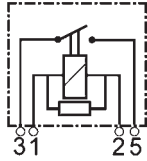

Voltage: 12  
Amp: 25

No./terminals: 4  
Resistor: w/

**DOUBLE CONTACT**

**160168** Relay

Std pkg 1

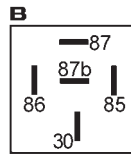
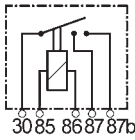

Voltage: 12  
Amp: 2x20

No./terminals: 5  
Bracket: w/

**160902** Relay

Std pkg 1

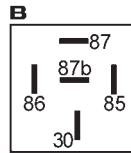
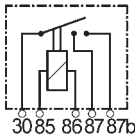

Voltage: 12  
Amp: 2x15

No./terminals: 5  
Bracket: w/

**160933** Mini Relay

Std pkg 1

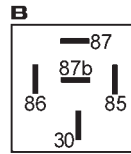
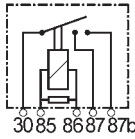

Voltage: 12  
Amp: 2x20

No./terminals: 5  
Bracket: w/  
Resistor: w/

**160934** Mini Relay

Std pkg 1

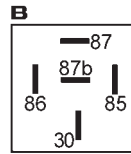
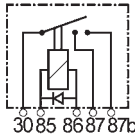

Voltage: 12  
Amp: 2x20

No./terminals: 5  
Bracket: w/  
Diode: w/

**160169 Relay**

Std pkg 1

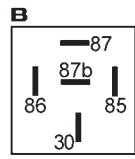
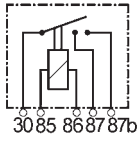

Voltage: 24  
Amp: 2x10

No./terminals: 5  
Bracket: w/

**160938 Relay**

Std pkg 1

w/ double contact.

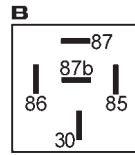
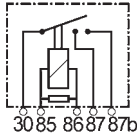

Voltage: 24  
Amp: 2x10

No./terminals: 5  
Bracket: w/  
Resistor: w/

**160939 Relay**

Std pkg 1

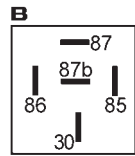
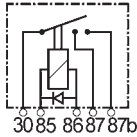

Voltage: 24  
Amp: 2x10

No./terminals: 5  
Bracket: w/  
Diode: w/

**TWIN**

**160267 Twin Relay**

Std pkg 1

Servicing: VW - Visit [www.hc-cargo.com](http://www.hc-cargo.com) for further information.

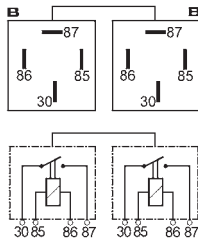

Voltage: 12  
Amp: 2x40

Terminals: 2x4  
Bracket: w/

**HIGH PERFORMANCE 12 V**

**160984 Relay**

Std pkg 1

ADR-approved

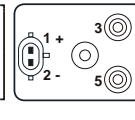
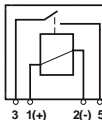

Voltage: 12  
Amp: 300

Type: High performance  
No./terminals: 3  
Bracket: w/

**HIGH PERFORMANCE 24 V**

**160985 Relay**





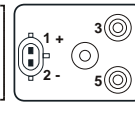
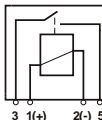





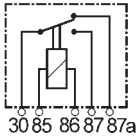
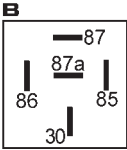

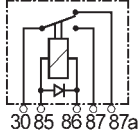
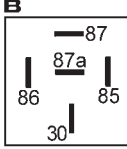
Std pkg 1

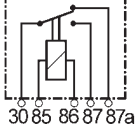
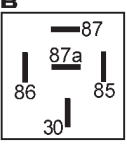
ADR-approved

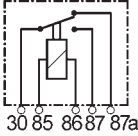
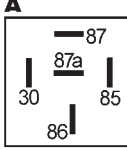

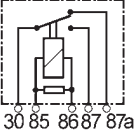
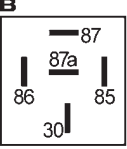
Voltage: 24  
Amp: 200

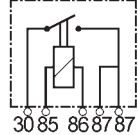
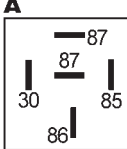
Type: High performance  
No./terminals: 3  
Bracket: w/

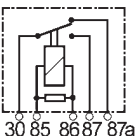
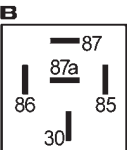
CHANGE OVER - 12 V			
160081 Relay Std pkg 1		Voltage: 12 Amp: 20/30	Type: Change Over No./terminals: 5 Bracket: w/
			
160270 Relay Std pkg 1		Voltage: 12 Amp: 20/30	Type: Change Over No./terminals: 5 Bracket: w/ Diode: w/
			
160308 Relay Std pkg 1		Voltage: 12 Amp: 40/15	Type: Change Over No./terminals: 5
			
160316 Relay Std pkg 1		Voltage: 12 Amp: 15/40	Type: Change Over No./terminals: 5 Bracket: w/
			
160403 Relay Std pkg 1		Voltage: 12 Amp: 15/40	Type: Change Over No./terminals: 5 Bracket: w/ Resistor: w/
			
160921 Relay Std pkg 1		Voltage: 12 Amp: 40	Plug type: Flat No./terminals: 5 Bracket: w/
			
160932 Relay Std pkg 1		Voltage: 12 Amp: 40/15	Type: Change Over No./terminals: 5 Bracket: w/ Resistor: w/
			

**160942 Relay**

Std pkg 1

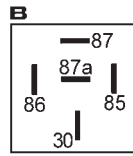
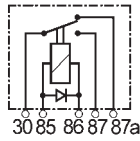
 Voltage: 12  
Amp: 40/15

 Type: Change Over  
No./terminals: 5  
Bracket: w/  
Diode: w/

**160974 Relay**

Std pkg 1

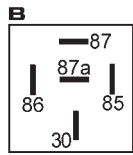
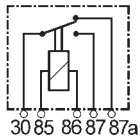
 Voltage: 12  
Amp: 70/40

 Type: Change Over  
Terminals: 2x6.3 mm, 3x9.5 mm  
Bracket: w/

**MICRO**
**160365 Micro Relay**

Std pkg 1

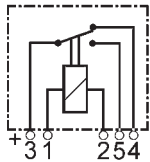
 Voltage: 12  
Amp: 10/20

 Type: Change Over  
No./terminals: 5

**160366 Micro Relay**

Std pkg 1

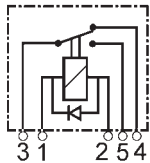
 Voltage: 12  
Amp: 15/25

 Type: Change Over  
No./terminals: 5  
Diode: w/

**160367 Micro Relay**

Std pkg 1

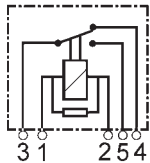
 Voltage: 12  
Amp: 15/25

 Type: Change Over  
No./terminals: 5  
Resistor: w/

**160919 Micro Relay**

Std pkg 1

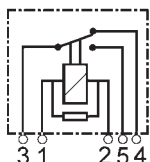
 Voltage: 12  
Amp: 20/10







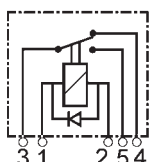



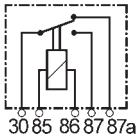
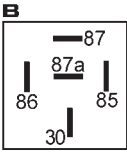

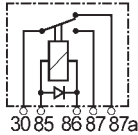
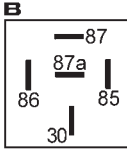
 No./terminals: 5  
Resistor: w/

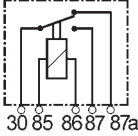
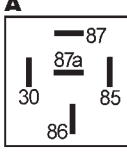

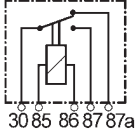
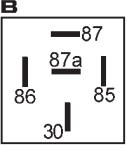

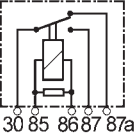
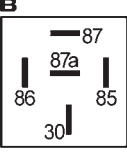

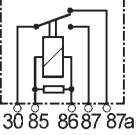
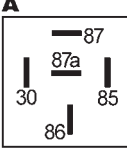

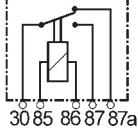
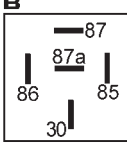

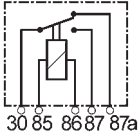
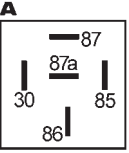

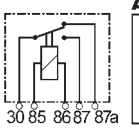
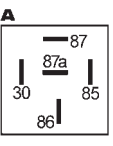
**160920 Micro Relay**

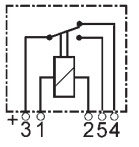
Std pkg 1

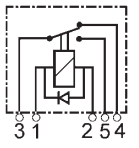
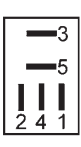
 Voltage: 12  
Amp: 20/10

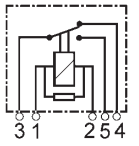
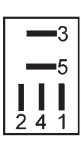
 No./terminals: 5  
Diode: w/

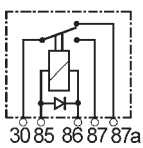
CHANGE OVER - 24 V			EL. SPECIFICATIONS	DIMENSIONS	ADDITIONAL SPECIFICATIONS
160216 Relay Std pkg 1			Voltage: 24 Amp: 10/20		Type: Change Over No./terminals: 5 Bracket: w/
					
160271 Relay Std pkg 1			Voltage: 24 Amp: 10/20		Type: Change Over No./terminals: 5 Bracket: w/ Diode: w/
					
160317 Relay Std pkg 1			Voltage: 24 Amp: 10/22		Type: Change Over No./terminals: 5 Bracket: w/
					
160337 Relay Std pkg 1			Voltage: 24 Amp: 10/22		Type: Change Over No./terminals: 5
					
160394 Relay Std pkg 1			Voltage: 24 Amp: 40/60		Type: Change Over No./terminals: 5 Resistor: w/
					
160944 Relay Std pkg 1			Voltage: 24 Amp: 10/20		Type: Change Over No./terminals: 5 Resistor: w/
					
160976 Relay Std pkg 1			Voltage: 24 Amp: 50/30		Type: Change Over Terminals: 2x6.3 mm, 3x9.5 mm
					

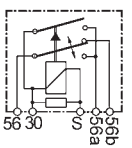
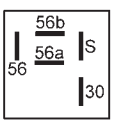
		EL. SPECIFICATIONS	DIMENSIONS	ADDITIONAL SPECIFICATIONS
<b>160980 Relay</b> Std pkg 1				
	 	Voltage: 24 Amp: 30/40		Type: Change Over Terminals: 2x6.3 mm, 3x9.5 mm Bracket: w/
<b>160981 Relay</b> Std pkg 1				
	 	Voltage: 24 Amp: 10/20		Type: Change Over No./terminals: 5 Bracket: w/
<b>MICRO</b>				
<b>160368 Micro Relay</b> Std pkg 1				
	 	Voltage: 24 Amp: 4/10		Type: Change Over No./terminals: 5
<b>160521 Micro Relay</b> Std pkg 1				
	 	Voltage: 24 Amp: 5/10		Type: Change Over No./terminals: 5 Diode: w/
<b>161010 Micro Relay</b> Std pkg 1				
	 	Voltage: 24 Amp: 20/10		Type: Change Over No./terminals: 5 Resistor: w/
<b>161020 Micro Relay</b> Std pkg 1				
	 	Voltage: 24 Amp: 15/10		Type: Change Over No./terminals: 5 Diode: w/
<b>FLIP FLOP</b>				
<b>160654 Flip Flop Relay</b> Std pkg 1		Servicing: Audi, VW - Visit <a href="http://www.hc-cargo.com">www.hc-cargo.com</a> for further information.		
2 sec. on/off.				
	 	Voltage: 12 Watt: 2x150		Type: Flip Flop No./terminals: 5 Bracket: w/ Diode: w/



### TIME DELAY - 12 V

**160297** Time Delay Relay

Std pkg 1

Servicing: Alfa Romeo, Opel, Audi, VW, Renault, Citroen, Peugeot, Volvo, Seat, Saab, Porsche, Skoda, Ford, Vauxhall, Alfa Romeo - Visit [www.hc-cargo.com](http://www.hc-cargo.com) for further information.

For windshield wiper and washer. Also for universal use.

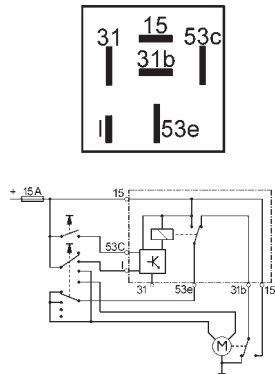

Voltage: 12  
Amp: 15

Delay time: 3.5 sec.

No./terminals: 6

**160570** Relay Time Delay

Std pkg 1

Servicing: Universal - Visit [www.hc-cargo.com](http://www.hc-cargo.com) for further information.

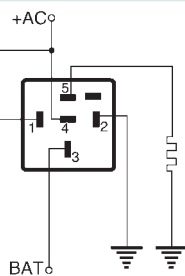

Voltage: 12  
Amp: 20

Delay time: 12 min.

No./terminals: 5

**160749** Relay

Std pkg 1

Servicing: Audi, VW - Visit [www.hc-cargo.com](http://www.hc-cargo.com) for further information.

Washing/wiper unit w/ changeable intervals.

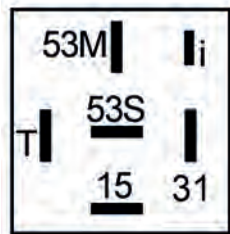

Voltage: 12  
Amp: 30

Delay time: 0.5 sec

No./terminals: 6

**160992** Time Delay Relay

Std pkg 1

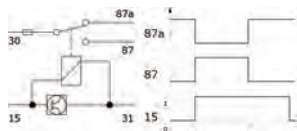

Voltage: 12  
Amp: 20

Delay time: 3.5 sec

Type: Delay off  
No./terminals: 5  
Bracket: w/

### TIME DELAY - 24 V

**160466** Time Delay Relay

Std pkg 1

For A/C compressor, bus doors and time delayed motors.

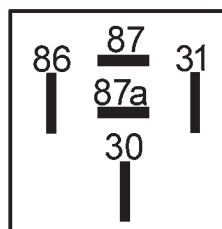

Voltage: 24  
Amp: 5

Delay time: 4 sec

No./terminals: 5

**MULTITIMER**
**160927** Multitimer Relay Std pkg 1

0.5 sec.-6 hours.

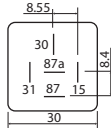
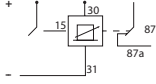
 Voltage: 12  
Amp: 10

No./terminals: 5

**160928** Multitimer Relay Std pkg 1

0.5 sec.-6 hours.

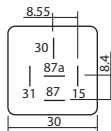
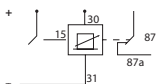
 Voltage: 24  
Amp: 10

No./terminals: 5

**161008** Multitimer Relay Std pkg 1

0.5 sec.-10 hours.

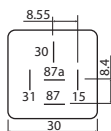
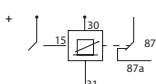

 Voltage: 12  
Amp: 10

No./terminals: 5





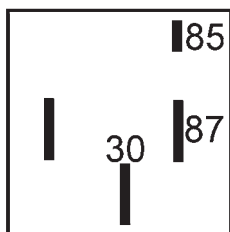



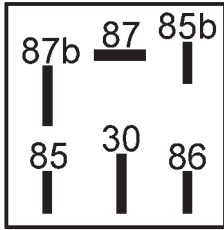

**TIMING DEVICES**
**160287** Timing Device Std pkg 1

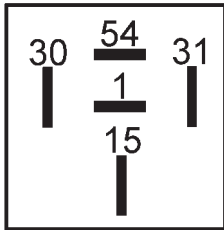
 Voltage: 12  
Watt: 2/4x21

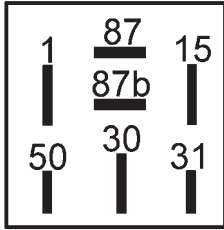
No./terminals: 12

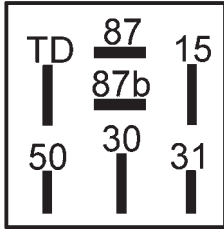
**RADIATOR FANS**
**160637** Relay Std pkg 1

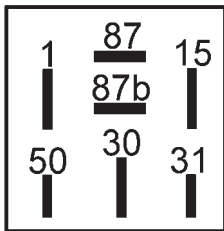
 Voltage: 12  
Amp: 30

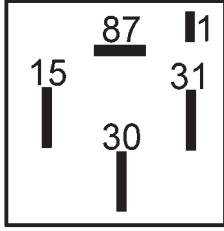







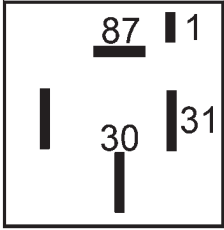

No./terminals: 4

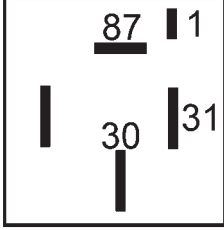
FUEL PUMPS			EL. SPECIFICATIONS	DIMENSIONS	ADDITIONAL SPECIFICATIONS
<b>160295 Fuel Pump Relay</b> Std pkg 1 Servicing: Opel, Vauxhall - Visit <a href="http://www.hc-cargo.com">www.hc-cargo.com</a> for further information.			Voltage: 12		No./terminals: 6
					
<b>160350 Fuel Pump Relay</b> Std pkg 1 Servicing: Ford - Visit <a href="http://www.hc-cargo.com">www.hc-cargo.com</a> for further information.			Voltage: 12 Amp: 16		No./terminals: 5 Bracket: w/
					
<b>160352 Fuel Pump Relay</b> Std pkg 1 Servicing: BMW, Opel, Vauxhall, VW - Visit <a href="http://www.hc-cargo.com">www.hc-cargo.com</a> for further information.			Voltage: 12		No./terminals: 7 Bracket: w/
					
<b>160353 Fuel Pump Relay</b> Std pkg 1 Servicing: Alfa Romeo, Citroen, Ferrari, Fiat, Ford, Lancia, Peugeot, Seat - Visit <a href="http://www.hc-cargo.com">www.hc-cargo.com</a> for further information.			Voltage: 12 Amp: 16		No./terminals: 7 Bracket: w/
					
<b>160354 Fuel Pump Relay</b> Std pkg 1 Servicing: Alfa Romeo, Citroen, Fiat, Lancia, Opel, Peugeot, Renault, Vauxhall - Visit <a href="http://www.hc-cargo.com">www.hc-cargo.com</a> for further information.			Voltage: 12 Amp: 16		No./terminals: 7 Bracket: w/
					
<b>160372 Fuel Pump Relay</b> Std pkg 1 Servicing: Audi - Visit <a href="http://www.hc-cargo.com">www.hc-cargo.com</a> for further information.			Voltage: 12		No./terminals: 5
					

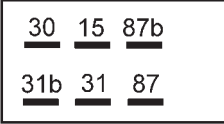
EL. SPECIFICATIONS

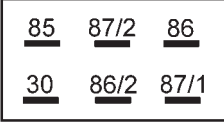
DIMENSIONS

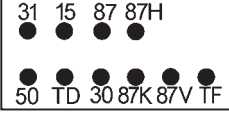
ADDITIONAL SPECIFICATIONS

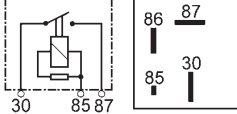
		EL. SPECIFICATIONS	DIMENSIONS	ADDITIONAL SPECIFICATIONS
<b>160374</b> Fuel Pump Relay	Std pkg 1	Servicing: Audi, VW - Visit <a href="http://www.hc-cargo.com">www.hc-cargo.com</a> for further information. Voltage: 12	RPM limited: 6600	No./terminals: 5
				
<b>160375</b> Fuel Pump Relay	Std pkg 1	Servicing: Audi, VW - Visit <a href="http://www.hc-cargo.com">www.hc-cargo.com</a> for further information. Voltage: 12	RPM limited: 6600	No./terminals: 5
				
<b>160400</b> Fuel Pump Relay	Std pkg 1	Servicing: Volvo - Visit <a href="http://www.hc-cargo.com">www.hc-cargo.com</a> for further information. Voltage: 12 Amp: 30		No./terminals: 6
				
<b>160401</b> Fuel Pump Relay	Std pkg 1	Servicing: Volvo - Visit <a href="http://www.hc-cargo.com">www.hc-cargo.com</a> for further information. Voltage: 12 Amp: 15		No./terminals: 6
				
<b>160470</b> Fuel Pump Relay	Std pkg 1	Servicing: Mercedes-Benz - Visit <a href="http://www.hc-cargo.com">www.hc-cargo.com</a> for further information. Cold start valve.	Voltage: 12	RPM limited: 6200
				No./terminals: 10
<b>160751</b> Fuel Pump Relay	Std pkg 1	Servicing: Audi, Seat, Skoda, VW - Visit <a href="http://www.hc-cargo.com">www.hc-cargo.com</a> for further information. Voltage: 12 Amp: 30		No./terminals: 4 Resistor: w/
				

<b>160792</b> Fuel Pump Relay	Std pkg 1	Servicing: Volvo - Visit <a href="http://www.hc-cargo.com">www.hc-cargo.com</a> for further information.
	Voltage: 12	No./terminals: 4

## HAZARD WARNING LIGHT SYSTEM

<b>160578</b> Hazard Warning Light	Std pkg 1	Complete set containing switch, relay and mounting bracket.
	Voltage: 12	

## FLASHER UNITS - 6 V

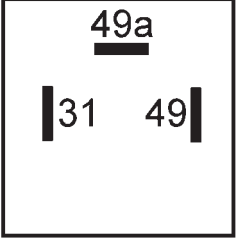



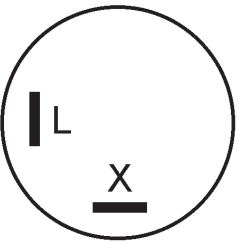

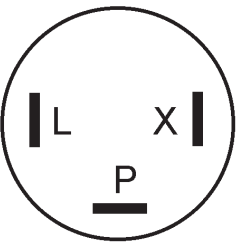

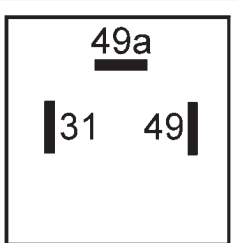

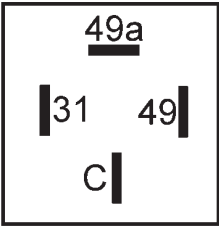
<b>160651</b> Flasher Unit	Std pkg 1	
		Voltage: 6 Watt: 42  No./terminals: 3 Bracket: w/

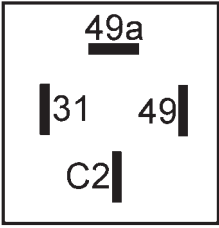

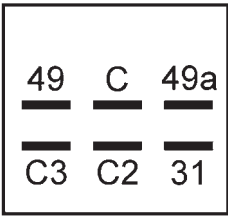

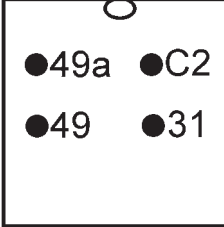

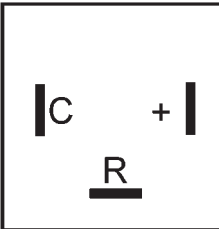

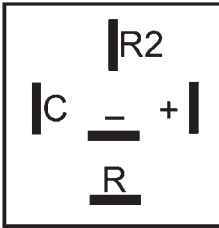

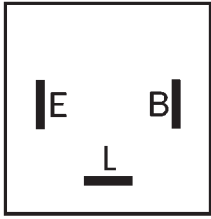
## FLASHER UNITS - 12 V

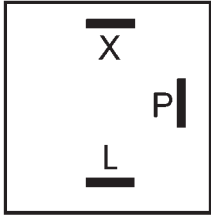



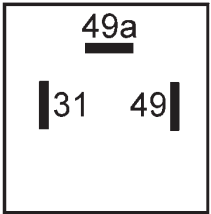

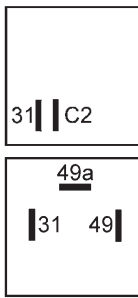

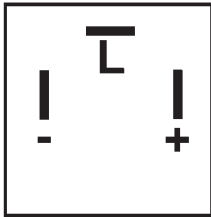
<b>160115</b> Flasher Unit	Std pkg 1	
		Voltage: 12 Watt: 138  No./terminals: 2

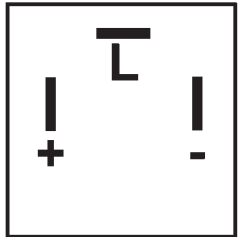
<b>160116</b> Flasher Unit	Std pkg 1	
		Voltage: 12 Watt: 138  No./terminals: 3

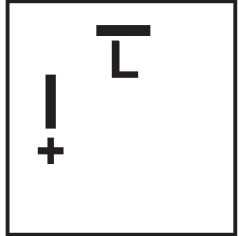

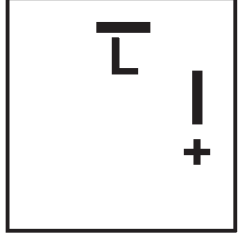

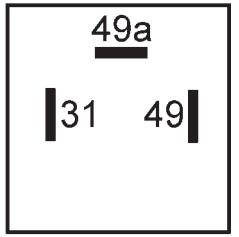

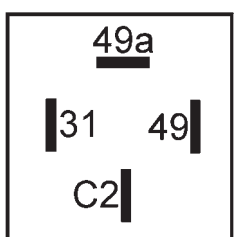

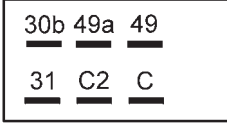

<b>160242</b> Flasher Unit	Std pkg 1	Servicing: Alfa Romeo, Audi, Bedford, Ford, Nissan, Opel, Toyota - Visit <a href="http://www.hc-cargo.com">www.hc-cargo.com</a> for further information.
		Voltage: 12 Watt: 2/4x21  No./terminals: 3 Bracket: w/

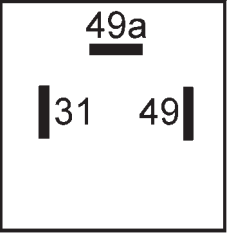
		EL. SPECIFICATIONS	DIMENSIONS	ADDITIONAL SPECIFICATIONS
<b>160243 Flasher Unit</b> Std pkg 1		Servicing: Alfa Romeo, Audi, Austin, BMW, Citroen, Fiat, Ford, Honda, Iveco, Lada, Lancia, Mercedes-Benz, Opel, Peugeot, Porsche - Visit <a href="http://www.hc-cargo.com">www.hc-cargo.com</a> for further information.		
		Voltage: 12 Watt: 2/4x21		No./terminals: 4 Bracket: w/
<b>160244 Flasher Unit</b> Std pkg 1		Servicing: Audi, Austin, BMW, Citroen, Daihatsu, Fiat, Ford, Honda, Lada, Lancia, Lexus, Mazda, Mercedes-Benz, Mitsubishi, Nissan - Visit <a href="http://www.hc-cargo.com">www.hc-cargo.com</a> for further information.		
<i>For vehicles w/ towbars.</i>				
		Voltage: 12 Watt: 2+1/6x21		No./terminals: 4 Bracket: w/
<b>160263 Flasher Unit</b> Std pkg 1		Servicing: Mercedes-Benz - Visit <a href="http://www.hc-cargo.com">www.hc-cargo.com</a> for further information.		
		Voltage: 12 Watt: 2+1+1/8x21		No./terminals: 6 Bracket: w/
<b>160305 Flasher Unit</b> Std pkg 1		Servicing: Mercedes-Benz - Visit <a href="http://www.hc-cargo.com">www.hc-cargo.com</a> for further information.		
<i>For vehicles w/ towbars.</i>				
		Voltage: 12 Watt: 2+1/6x21		No./terminals: 4
<b>160312 Flasher Unit</b> Std pkg 1		Interchangeable w/ all 4 terminal device (+, -, C, R). for SAE standard vehicles (France, Italy, USA, Spain).		
		Voltage: 12 Watt: 2/4x21		No./terminals: 3 Bracket: w/
<b>160314 Flasher Unit</b> Std pkg 1		Servicing: Alfa Romero, Renault, Fiat, Lancia, Lada, Alfa Romeo, BMW, Fiat, Lada, Lancia, Renault - Visit <a href="http://www.hc-cargo.com">www.hc-cargo.com</a> for further information.		
<i>For vehicles w/ towbars. For SAE standard vehicles (France, Italy, USA, Spain).</i>				
		Voltage: 12 Watt: 2+1/6x21		No./terminals: 5 Bracket: w/

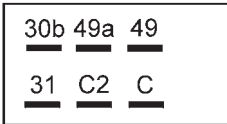
EL. SPECIFICATIONS		DIMENSIONS	ADDITIONAL SPECIFICATIONS
<b>160315 Flasher Unit</b> Std pkg 1      Servicing: Japanese vehicles - Visit <a href="http://www.hc-cargo.com">www.hc-cargo.com</a> for further information.			
		Voltage: 12 Watt: 2/4x21	No./terminals: 3
<b>160341 Flasher Unit</b> Std pkg 1      Servicing: Alfa Romeo, Audi, Austin, BMW, Citroen, Fiat, Ford, Honda, Lada, Mercedes-Benz, Opel, Peugeot, Porsche - Visit <a href="http://www.hc-cargo.com">www.hc-cargo.com</a> for further information.			
		Voltage: 12 Amp: 16 Watt: 180	No./terminals: 3 Bracket: w/
<b>160402 Flasher Unit</b> Std pkg 1 <i>For vehicles w/ towbars.</i>			
		Voltage: 12 Watt: 2+1/6x21	Terminals: 4+2/top
<b>160474 Flasher Unit</b> Std pkg 1			
		Voltage: 12 Watt: 2/4x21	No./terminals: 3
<b>160475 Flasher Unit</b> Std pkg 1 <i>For vehicles w/ towbars.</i>			
		Voltage: 12 Watt: 2+1/6x21	Terminals: 3+2/top
<b>W/ LED</b>			
<b>160948 Flasher Unit</b> Std pkg 1			
		Voltage: 12 Watt: 0.1-150  Height: 30 mm	No./terminals: 3

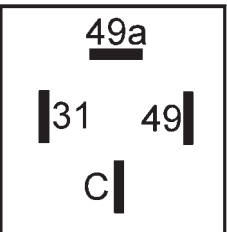
		EL. SPECIFICATIONS	DIMENSIONS	ADDITIONAL SPECIFICATIONS
<b>160949</b> Flasher Unit	Std pkg 1	Voltage: 12 Watt: 0.1-150	Height: 30 mm	No./terminals: 3
				
<b>160950</b> Flasher Unit	Std pkg 1	Voltage: 12 Watt: 0.1-150	Height: 30 mm	No./terminals: 2
				
<b>160951</b> Flasher Unit	Std pkg 1	Voltage: 12 Watt: 0.1-150	Height: 30 mm	No./terminals: 2
				
<b>160954</b> i-LS sensor	Std pkg 1	Voltage: 12	Height: 26 mm	No./terminals: 3
<i>In combination w/ an I-LS flasher unit, the I-LS sensor secures the legal requirements of "lamp failure warning".</i>				
				
<b>160956</b> Flasher Unit i-LS	Std pkg 1	Voltage: 12 Watt: 90		No./terminals: 3 Bracket: w/
<i> servicing: Vehicles w/ 2 LED lamps on front or rear - Visit <a href="http://www.hc-cargo.com">www.hc-cargo.com</a> for further information.</i>				
<i>In combination w/ an I-LS sensor, the I-LS flasher relay secures the legal requirements of "lamp failure warning" by installed LED lamps.</i>				
				
<b>160957</b> Flasher Unit i-LS	Std pkg 1	Voltage: 12 Watt: 170		No./terminals: 4 Bracket: w/
<i> servicing: Vehicles w/ trailer, w/ 2 LED lamps - Visit <a href="http://www.hc-cargo.com">www.hc-cargo.com</a> for further information.</i>				
<i>In combination w/ an I-LS sensor, the I-LS flasher relay secures the legal requirements of "lamp failure warning" by installed LED lamps.</i>				
				

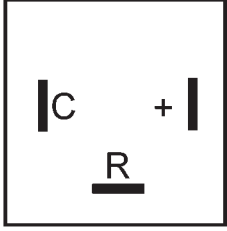

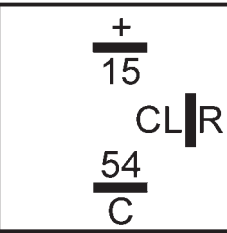
FLASHER UNITS - 24 V		
<b>160199</b> Flasher Unit      Std pkg 1      Servicing: Mazda, Volvo - Visit <a href="http://www.hc-cargo.com">www.hc-cargo.com</a> for further information.		
		Voltage: 24 Watt: 3+1/8x21  No./terminals: 6 Bracket: w/
<b>160261</b> Flasher Unit      Std pkg 1      Servicing: Mercedes-Benz - Visit <a href="http://www.hc-cargo.com">www.hc-cargo.com</a> for further information.		
		Voltage: 24 Watt: 2/4x21  No./terminals: 3 Bracket: w/
<b>160262</b> Flasher Unit      Std pkg 1		
		Voltage: 24 Watt: 2+1/6x21  No./terminals: 6 Bracket: w/
<b>160296</b> Flasher Unit      Std pkg 1		
		Voltage: 24 Watt: 2/4x21  No./terminals: 4 Bracket: w/
<b>160313</b> Flasher Unit      Std pkg 1 Interchangeable w/ all 4 terminal device (+, -, C, R). for SAE standard vehicles (France, Italy, USA, Spain).		
		Voltage: 24 Watt: 2/4x21  No./terminals: 3 Bracket: w/
<b>160716</b> Flasher Unit      Std pkg 1		
		Voltage: 24 Watt: 500  No./terminals: 3 Bracket: w/

**W/ LED**
**160952** Flasher Unit

Std pkg 1

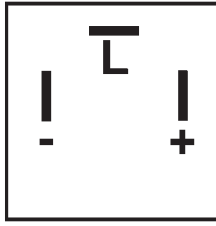

 Voltage: 24  
Watt: 0.1-150

Height: 30 mm

No./terminals: 3

**160953** Flasher Unit

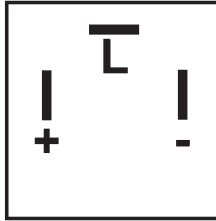
Std pkg 1



 Voltage: 24  
Watt: 0.1-150

Height: 30 mm

No./terminals: 3

**160955** i-LS Sensor

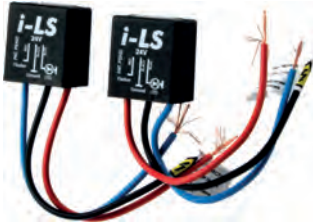
Std pkg 1

*In combination w/ an I-LS flasher unit, the I-LS sensor secures the legal requirements of "lamp failure warning".*

Voltage: 24

No./terminals: 3

**160958** Flasher Unit i-LS

Std pkg 1

 Servicing: Vehicles w/ 2 LED lamps on front or rear - Visit [www.hc-cargo.com](http://www.hc-cargo.com) for further information.

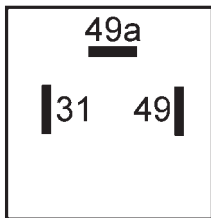
*In combination w/ an I-LS sensor, the I-LS flasher relay secures the legal requirements of "lamp failure warning" by installed LED lamps.*

 Voltage: 24  
Watt: 90

 No./terminals: 3  
Bracket: w/

**160959** Flasher Unit i-LS

Std pkg 1

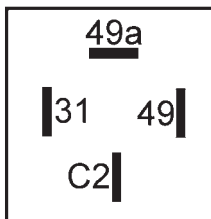
 Servicing: Vehicles w/ trailer, w/ 2 LED lamps - Visit [www.hc-cargo.com](http://www.hc-cargo.com) for further information.

*In combination w/ an I-LS sensor, the I-LS flasher relay secures the legal requirements of "lamp failure warning" by installed LED lamps.*

 Voltage: 24  
Watt: 170







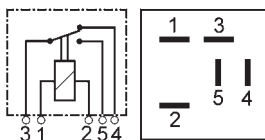

 No./terminals: 4  
Bracket: w/



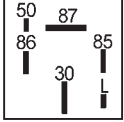
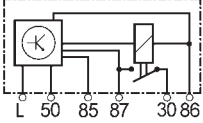
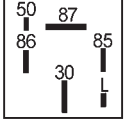
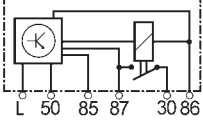

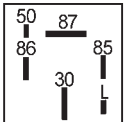
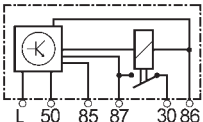

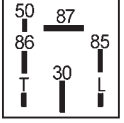
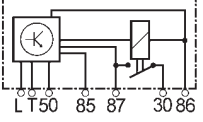

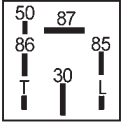
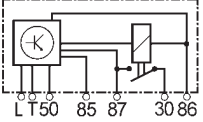

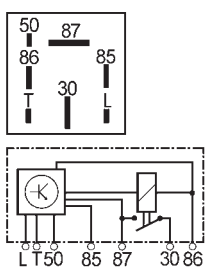
**CHARGE RELAYS**
**160407** Charge Relay

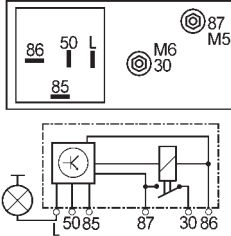

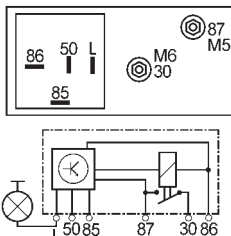

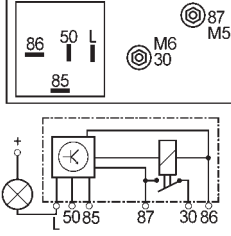

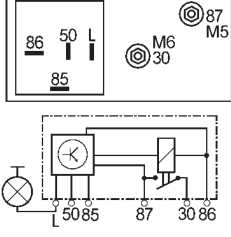

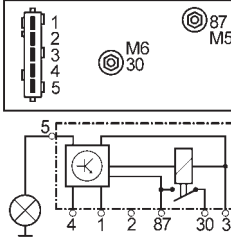

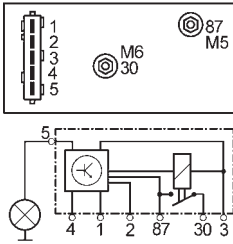
Std pkg 1

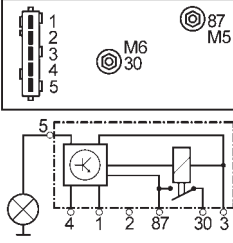
5 terminals.

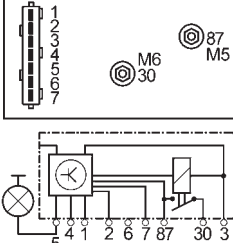
 Voltage: 14  
Amp: 20

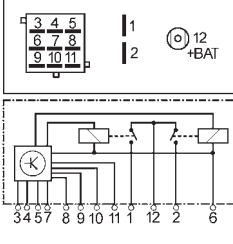
GLOW PLUG RELAYS			EL. SPECIFICATIONS	DIMENSIONS	ADDITIONAL SPECIFICATIONS
<b>160416</b> Glow Plug Relay <span style="float: right;">Std pkg 1</span>			Servicing: Ford, Opel, Vauxhall - Visit <a href="http://www.hc-cargo.com">www.hc-cargo.com</a> for further information.		
	 	Voltage: 12 Amp: 70	Pre-heating time: < 8	No./terminals: 6 Post heating: No Bracket: w/	
<b>160417</b> Glow Plug Relay <span style="float: right;">Std pkg 1</span>			Servicing: Ford, Opel, Vauxhall - Visit <a href="http://www.hc-cargo.com">www.hc-cargo.com</a> for further information.		
	 	Voltage: 12 Amp: 70	Pre-heating time: < 13	No./terminals: 6 Post heating: No Bracket: w/	
<b>160418</b> Glow Plug Relay <span style="float: right;">Std pkg 1</span>			Servicing: Ford, Opel, Vauxhall - Visit <a href="http://www.hc-cargo.com">www.hc-cargo.com</a> for further information.		
	 	Voltage: 12 Amp: 70	Pre-heating time: < 8	No./terminals: 6 Post heating: Yes Bracket: w/	
<b>160419</b> Glow Plug Relay <span style="float: right;">Std pkg 1</span>			Servicing: Ford, Opel, Vauxhall - Visit <a href="http://www.hc-cargo.com">www.hc-cargo.com</a> for further information.		
	 	Voltage: 12 Amp: 70	Pre-heating time: < 6	No./terminals: 6 Post heating: Yes Bracket: w/	
<b>160420</b> Glow Plug Relay <span style="float: right;">Std pkg 1</span>			Servicing: Audi, VW - Visit <a href="http://www.hc-cargo.com">www.hc-cargo.com</a> for further information.		
	 	Voltage: 12	Pre-heating time: < 8	No./terminals: 7 Post heating: Yes	
<b>160421</b> Glow Plug Relay <span style="float: right;">Std pkg 1</span>			Servicing: Audi, Seat, VW - Visit <a href="http://www.hc-cargo.com">www.hc-cargo.com</a> for further information.		
	 	Voltage: 12	Pre-heating time: < 4	No./terminals: 7 Post heating: Yes	

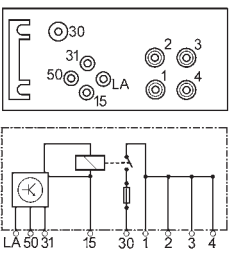
		EL. SPECIFICATIONS	DIMENSIONS	ADDITIONAL SPECIFICATIONS
<b>160422</b> Glow Plug Relay      Std pkg 1		Servicing: Fiat, Seat, VW - Visit <a href="http://www.hc-cargo.com">www.hc-cargo.com</a> for further information.		
		Voltage: 12	Pre-heating time: < 18	No./terminals: 7 Post heating: No
<b>160423</b> Glow Plug Relay      Std pkg 1		Servicing: Citroen, Peugeot, Renault - Visit <a href="http://www.hc-cargo.com">www.hc-cargo.com</a> for further information.		
		Voltage: 12 Amp: 70	Pre-heating time: < 14	No./terminals: 6 Post heating: No
<b>160424</b> Glow Plug Relay      Std pkg 1		Servicing: Alfa Romeo, Citroen, Fiat, Iveco, Peugeot, Renault, Rover, Seat, Talbot - Visit <a href="http://www.hc-cargo.com">www.hc-cargo.com</a> for further information.		
		Voltage: 12 Amp: 70	Pre-heating time: < 8	No./terminals: 6 Post heating: No
<b>160425</b> Glow Plug Relay      Std pkg 1		Servicing: Renault - Visit <a href="http://www.hc-cargo.com">www.hc-cargo.com</a> for further information.		
		Voltage: 12 Amp: 70	Pre-heating time: < 9	No./terminals: 6 Post heating: No
<b>160426</b> Glow Plug Relay      Std pkg 1		Servicing: Fiat - Visit <a href="http://www.hc-cargo.com">www.hc-cargo.com</a> for further information.		
		Voltage: 12 Amp: 70	Pre-heating time: < 7	No./terminals: 6 Post heating: Yes
<b>160431</b> Glow Plug Relay      Std pkg 1		Servicing: Peugeot - Visit <a href="http://www.hc-cargo.com">www.hc-cargo.com</a> for further information.		
		Voltage: 12 Amp: 70	Pre-heating time: < 10	No./terminals: 7 Post heating: No

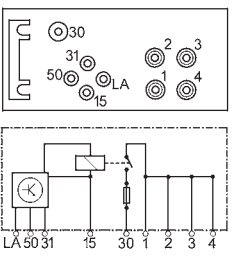
		EL. SPECIFICATIONS	DIMENSIONS	ADDITIONAL SPECIFICATIONS
<b>160432</b> Glow Plug Relay <span style="float: right;">Std pkg 1</span>		Servicing: Citroen, Fiat, Peugeot, Renault, Rover - Visit <a href="http://www.hc-cargo.com">www.hc-cargo.com</a> for further information.		
		Voltage: 12 Amp: 70	Pre-heating time: < 7	No./terminals: 7 Post heating: Yes
<b>160434</b> Glow Plug Relay <span style="float: right;">Std pkg 1</span>		Servicing: Citroen, Fiat, Peugeot - Visit <a href="http://www.hc-cargo.com">www.hc-cargo.com</a> for further information.		
		Voltage: 12 Amp: 70	Pre-heating time: < 8	No./terminals: 7 Post heating: Yes
<b>160436</b> Glow Plug Relay <span style="float: right;">Std pkg 1</span>		Servicing: Citroen, Peugeot - Visit <a href="http://www.hc-cargo.com">www.hc-cargo.com</a> for further information.		
		Voltage: 12 Amp: 70	Pre-heating time: < 8	No./terminals: 9 Post heating: Yes
<b>160438</b> Glow Plug Relay <span style="float: right;">Std pkg 1</span>		Servicing: Renault - Visit <a href="http://www.hc-cargo.com">www.hc-cargo.com</a> for further information.		
		Voltage: 12	Pre-heating time: < 10	No./terminals: 12 Post heating: Yes
<b>160441</b> Glow Plug Relay <span style="float: right;">Std pkg 1</span> <i>w/ "defect" warning.</i>		Servicing: Mercedes-Benz - Visit <a href="http://www.hc-cargo.com">www.hc-cargo.com</a> for further information.		
		Voltage: 12 Amp: 70	Pre-heating time: < 9	No./terminals: 9 Post heating: No
<b>160442</b> Glow Plug Relay <span style="float: right;">Std pkg 1</span> <i>w/ "defect" warning.</i>		Servicing: Mercedes-Benz - Visit <a href="http://www.hc-cargo.com">www.hc-cargo.com</a> for further information.		
		Voltage: 12 Amp: 70	Pre-heating time: < 9	No./terminals: 9 Post heating: No

**160443** Glow Plug Relay

Std pkg 1

Servicing: Mercedes-Benz - Visit [www.hc-cargo.com](http://www.hc-cargo.com) for further information.

w/ "defect" warning.

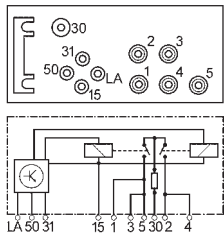

Voltage: 12  
Amp: 140

Pre-heating time: < 9

No./terminals: 10  
Post heating: No

**160445** Glow Plug Relay

Std pkg 1

Servicing: Mercedes-Benz - Visit [www.hc-cargo.com](http://www.hc-cargo.com) for further information.

w/ "defect" warning.

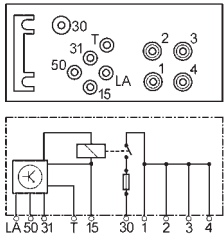

Voltage: 12  
Amp: 70

Pre-heating time: < 9

No./terminals: 10  
Post heating: Yes

**160446** Glow Plug Relay

Std pkg 1

Servicing: Mercedes-Benz - Visit [www.hc-cargo.com](http://www.hc-cargo.com) for further information.

w/ "defect" warning.

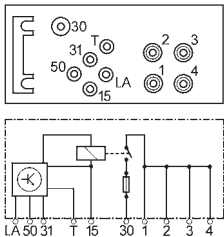

Voltage: 12  
Amp: 70

Pre-heating time: < 9

No./terminals: 10  
Post heating: Yes

**160447** Glow Plug Relay

Std pkg 1

Servicing: Audi, Mercedes-Benz - Visit [www.hc-cargo.com](http://www.hc-cargo.com) for further information.

w/ "defect" warning.

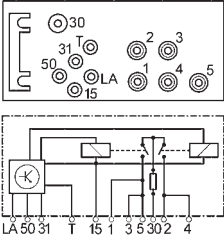

Voltage: 12  
Amp: 140

Pre-heating time: < 9

No./terminals: 11  
Post heating: Yes

**160448** Glow Plug Relay

Std pkg 1

Servicing: Mercedes-Benz, Puch (Steyr-Daimler) - Visit [www.hc-cargo.com](http://www.hc-cargo.com) for further information.

w/ "defect" warning.

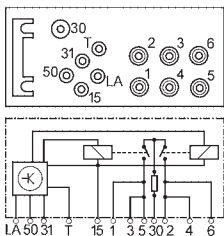

Voltage: 12  
Amp: 140

Pre-heating time: < 9

No./terminals: 12  
Post heating: Yes

**160449** Glow Plug Relay

Std pkg 1

Servicing: Mercedes-Benz, Ssangyong - Visit [www.hc-cargo.com](http://www.hc-cargo.com) for further information.



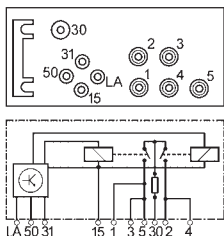





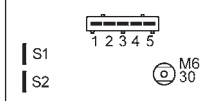
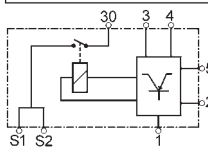
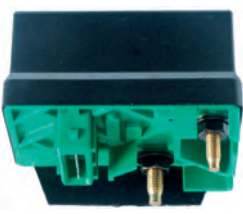

Can replace HC-CARGO 160441 and 160443 in connection w/ change to post heating glow plug.

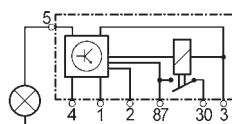

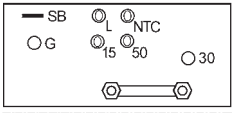
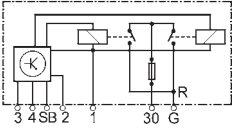

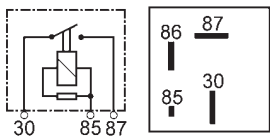

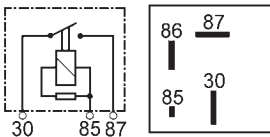

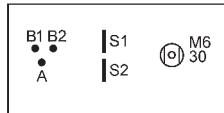
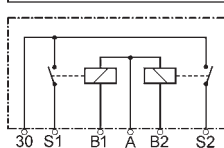
Voltage: 12  
Amp: 140

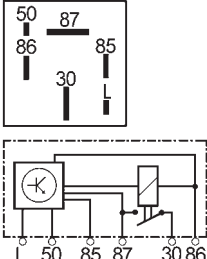
Pre-heating time: < 7

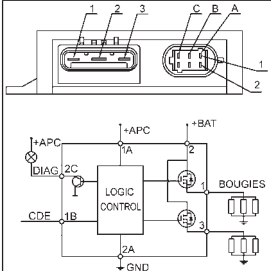
No./terminals: 10  
Post heating: Yes

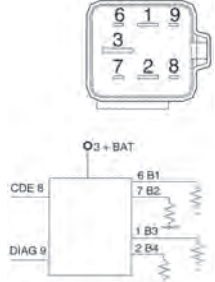
EL. SPECIFICATIONS		DIMENSIONS	ADDITIONAL SPECIFICATIONS
<b>160451</b> Glow Plug Relay   	Std pkg 1	Servicing: Renault - Visit <a href="http://www.hc-cargo.com">www.hc-cargo.com</a> for further information. Voltage: 12 Pre-heating time: < 7	No./terminals: 8 Post heating: Yes
<b>160453</b> Glow Plug Relay   	Std pkg 1	Servicing: Audi, Citroen, Fiat, Lancia, Peugeot - Visit <a href="http://www.hc-cargo.com">www.hc-cargo.com</a> for further information. Voltage: 12	No./terminals: 7 Post heating: No
<b>160458</b> Glow Plug Relay   	Std pkg 1	Servicing: Volvo - Visit <a href="http://www.hc-cargo.com">www.hc-cargo.com</a> for further information. Voltage: 12 Amp: 140 Pre-heating time: < 12	No./terminals: 7 Post heating: Yes
<b>160459</b> Glow Plug Relay <i>Model UWD.</i>  	Std pkg 1	Servicing: Seat, VW - Visit <a href="http://www.hc-cargo.com">www.hc-cargo.com</a> for further information. Voltage: 12	No./terminals: 4 Post heating: No
<b>160460</b> Glow Plug Relay <i>For engines w/ electronic diesel control.</i>  	Std pkg 1	Servicing: Audi, Seat, Skoda, VW - Visit <a href="http://www.hc-cargo.com">www.hc-cargo.com</a> for further information. Voltage: 12	No./terminals: 4 Post heating: No
<b>160461</b> Glow Plug Relay   	Std pkg 1	Servicing: Volvo - Visit <a href="http://www.hc-cargo.com">www.hc-cargo.com</a> for further information. Voltage: 12	No./terminals: 6 Post heating: No

		EL. SPECIFICATIONS	DIMENSIONS	ADDITIONAL SPECIFICATIONS
<b>160469</b> Glow Plug Relay		Std pkg 1	Servicing: Ford - Visit <a href="http://www.hc-cargo.com">www.hc-cargo.com</a> for further information.	
		Voltage: 12	Pre-heating time: < 5	No./terminals: 6 Post heating: Yes Bracket: w/
<b>160718</b> Glow Plug Relay		Std pkg 1		
		Voltage: 12		No./terminals: 9 Post heating: No Bracket: w/
<b>160719</b> Glow Plug Relay		Std pkg 1		
		Voltage: 12		No./terminals: 9 Post heating: No Bracket: w/
<b>160795</b> Glow Plug Relay		Std pkg 1	Servicing: Renault - Visit <a href="http://www.hc-cargo.com">www.hc-cargo.com</a> for further information.	
		Voltage: 12		No./terminals: 7 Post heating: No Bracket: w/
<b>MULTI PLUGS</b>				
<b>190766</b> Relay Multiplug		Std pkg 10	Servicing: HC-CARGO 192158	
<i>Sockets can be built together. 5x6.3 mm flat plug terminals. 4x2.8 mm flat plug terminals.</i>				
				Type: Socket No./poles: 9
<b>190767</b> Relay Multiplug		Std pkg 10	Servicing: HC-CARGO 192159	
<i>6.3 mm.</i>				
				Type: Socket No./poles: 5



EL. SPECIFICATIONS	DIMENSIONS	ADDITIONAL SPECIFICATIONS
<b>191026</b> Relay Multiplug      Std pkg 10    Servicing: HC-CARGO 192160 <i>Sockets can be built together. 2x9.5 mm flat plug terminals. 3x6.3 mm flat plug terminals. 4x2.8 mm flat plug terminals.</i>		
		Type: Socket No./poles: 9
<b>191752</b> Relay Multiplug      Std pkg 10    Servicing: HC-CARGO 192161 <i>Sockets can be built together. 2x6.3 mm flat plug terminals. 3x4.7 mm flat plug terminals.</i>		
		Type: Socket No./poles: 5
<b>KITS</b>		
<b>192158</b> Relay Multiplug Kit      Std pkg 1		
<i>Contains: 1x HC-CARGO 190766. 5x HC-CARGO 190252. 4x HC-CARGO 191083.</i>		
		
<b>192159</b> Relay Multiplug Kit      Std pkg 1		
<i>Contains: 1x HC-CARGO 190767. 5x HC-CARGO 190252.</i>		
		
<b>192160</b> Relay Multiplug Kit      Std pkg 1		
<i>Contains: 1x HC-CARGO 191026. 2x HC-CARGO 191025. 3x HC-CARGO 190252. 1x HC-CARGO 191083.</i>		
		
<b>192161</b> Relay Multiplug Kit      Std pkg 1		
<i>Contains: 1x HC-CARGO 191752. 2x HC-CARGO 190252. 3x HC-CARGO 191089.</i>		
		

## TRAILER SWITCH BOXES

**160167** Relay Box Std pkg 1 Servicing: For 12 V trailer pulled by a 24 V vehicle.

Switches the voltage from 24 V to 12 V by 5 relays. Run at 24 V and leading 12 V from one of the batteries or converter to the lamps of the trailer. For continuous use it has to be connected via a converter. For internal mounting.



Voltage: 12/24  
Amp: 10  
Watt: 250

Dim.: 100x100x58 mm

No./poles: 7  
Relay switch: Yes

**160502** Trailer Connecting Unit Std pkg 1 Servicing: For 12 V trailer pulled by a 24 V vehicle.

Mounted w/o use of converter.



Voltage: 12/24

Dim.: 110x103x43 mm  
IP rating: IP 65

No./poles: 7  
Transistor switch: Yes  
Waterproof: Yes  
C2 control lamp: w/  
Relay switch: No

**160797** Relay Box Std pkg 1

To reduce voltage drop, if you use vehicles w/ trailer. Fitted w/ 5x12 V relays the 12 V function will not be affected.



Voltage: 12-12  
Amp: 5x8  
Watt: 5x250

Dim.: 100x100x58 mm

## BOXES

**191410** Relay Box Std pkg 1

Can be assembled in rows (terminals: HC-CARGO 190252 or 191029).



Capacity: 4  
Assembling: Yes

Regulator type: Standard  
Colour: Transparent  
Terminals: w/  
Lock: w/

**191818** Relay Box Std pkg 1

Can be assembled in rows (terminals: HC-CARGO 190252 or 191029).



Capacity: 7  
Assembling: Yes

Regulator type: Micro  
Colour: Transparent  
Terminals: w/  
Lock: w/

## POWR-BLOKS



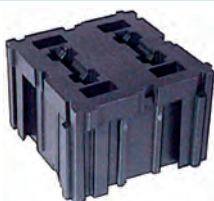

**191717** Powr-Blok Std pkg 10

The POWR-BLOKS system gives you unlimited flexibility to design electrical distribution systems that range from simple to complex. Choose from a variety of POWR-BLOKS modules that accommodate everything you need in power distribution or circuit protection blocks, including fuses, circuit breakers, relays, flashers and specialty devices. It is the totally modular way to build your own junction block. Typical Applications: Buses, Conversion Vans, Off Road and Recreational Vehicles, Construction Equipment, Emergency Vehicles, Farm Equipment, Heavy Duty Trucks, Industrial Vehicles, Marine, High Performance and Racing Vehicles. Terminals: HC-CARGO 191733, 191734, 192758.

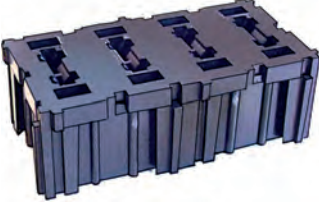

Height: 30.48 mm  
Module: Fuse holder

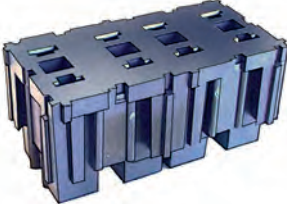
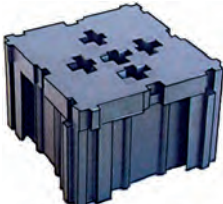
Type/fuse: ATO  
Outlets: 2 way

<p><b>191718</b> Powr-Blok Std pkg 5</p> <p>The POWR-BLOKS system gives you unlimited flexibility to design electrical distribution systems that range from simple to complex. Choose from a variety of POWR-BLOKS modules that accommodate everything you need in power distribution or circuit protection blocks, including fuses, circuit breakers, relays, flashers and specialty devices. It is the totally modular way to build your own junction block. Typical Applications: Buses, Conversion Vans, Off Road and Recreational Vehicles, Construction Equipment, Emergency Vehicles, Farm Equipment, Heavy Duty Trucks, Industrial Vehicles, Marine, High Performance and Racing Vehicles. Terminals: HC-CARGO 191733, 191734, 192758.</p> 		<p>Height: 30.48 mm Module: Fuse holder</p>	<p>Type/fuse: ATO Outlets: 4 way</p>
<p><b>191719</b> Powr-Blok Std pkg 5 Servicing: HC-CARGO 191743</p> <p>The POWR-BLOKS system gives you unlimited flexibility to design electrical distribution systems that range from simple to complex. Choose from a variety of POWR-BLOKS modules that accommodate everything you need in power distribution or circuit protection blocks, including fuses, circuit breakers, relays, flashers and specialty devices. It is the totally modular way to build your own junction block. Typical Applications: Buses, Conversion Vans, Off Road and Recreational Vehicles, Construction Equipment, Emergency Vehicles, Farm Equipment, Heavy Duty Trucks, Industrial Vehicles, Marine, High Performance and Racing Vehicles. Terminals: HC-CARGO 191733, 191734, 192758.</p> 		<p>Height: 30.48 mm Module: Fuse holder</p>	<p>Type/fuse: ATO Outlets: 7 way</p>
<p><b>191721</b> Powr-Blok Std pkg 5</p> <p>The POWR-BLOKS system gives you unlimited flexibility to design electrical distribution systems that range from simple to complex. Choose from a variety of POWR-BLOKS modules that accommodate everything you need in power distribution or circuit protection blocks, including fuses, circuit breakers, relays, flashers and specialty devices. It is the totally modular way to build your own junction block. Typical Applications: Buses, Conversion Vans, Off Road and Recreational Vehicles, Construction Equipment, Emergency Vehicles, Farm Equipment, Heavy Duty Trucks, Industrial Vehicles, Marine, High Performance and Racing Vehicles. Terminal: HC-CARGO 191735, 191736.</p> 		<p>Height: 33.02 mm Module: Fuse holder</p>	<p>Type/fuse: Maxi Outlets: 4 way</p>
<p><b>191722</b> Powr-Blok Relay Multi Plug Std pkg 10</p> <p>The POWR-BLOKS system gives you unlimited flexibility to design electrical distribution systems that range from simple to complex. Choose from a variety of POWR-BLOKS modules that accommodate everything you need in power distribution or circuit protection blocks, including fuses, circuit breakers, relays, flashers and specialty devices. It is the totally modular way to build your own junction block. Typical Applications: Buses, Conversion Vans, Off Road and Recreational Vehicles, Construction Equipment, Emergency Vehicles, Farm Equipment, Heavy Duty Trucks, Industrial Vehicles, Marine, High Performance and Racing Vehicles. Terminal: HC-CARGO 191764, 191765, 191766.</p> 		<p>Height: 25.4 mm Module: Relay holder</p>	<p>Type/fuse: ISO No./relays: 1</p>
<p><b>191723</b> Powr-Blok Relay Multi Plug Std pkg 10</p> <p>The POWR-BLOKS system gives you unlimited flexibility to design electrical distribution systems that range from simple to complex. Choose from a variety of POWR-BLOKS modules that accommodate everything you need in power distribution or circuit protection blocks, including fuses, circuit breakers, relays, flashers and specialty devices. It is the totally modular way to build your own junction block. Typical Applications: Buses, Conversion Vans, Off Road and Recreational Vehicles, Construction Equipment, Emergency Vehicles, Farm Equipment, Heavy Duty Trucks, Industrial Vehicles, Marine, High Performance and Racing Vehicles. Terminal: HC-CARGO 191764, 191765, 191766.</p> 		<p>Height: 25.4 mm Module: Relay holder</p>	<p>Type/fuse: ISO No./relays: 2</p>

**191724 Powr-Blok Std pkg 1**

The POWR-BLOKS system gives you unlimited flexibility to design electrical distribution systems that range from simple to complex. Choose from a variety of POWR-BLOKS modules that accommodate everything you need in power distribution or circuit protection blocks, including fuses, circuit breakers, relays, flashers and specialty devices. It is the totally modular way to build your own junction block. Typical Applications: Buses, Conversion Vans, Off Road and Recreational Vehicles, Construction Equipment, Emergency Vehicles, Farm Equipment, Heavy Duty Trucks, Industrial Vehicles, Marine, High Performance and Racing Vehicles. Terminals 4.7 mm: HC-CARGO 191737, 191738. Terminals 6.3 mm: HC-CARGO 191764, 191765, 191766.

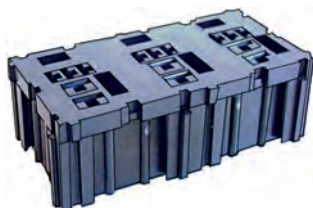

Height: 30.48 mm  
Module: Relay holder

Type/fuse: Micro  
No./relays: 3

**191725 Powr-Blok Stud Module Std pkg 1**

The POWR-BLOKS system gives you unlimited flexibility to design electrical distribution systems that range from simple to complex. Choose from a variety of POWR-BLOKS modules that accommodate everything you need in power distribution or circuit protection blocks, including fuses, circuit breakers, relays, flashers and specialty devices. It is the totally modular way to build your own junction block. Typical Applications: Buses, Conversion Vans, Off Road and Recreational Vehicles, Construction Equipment, Emergency Vehicles, Farm Equipment, Heavy Duty Trucks, Industrial Vehicles, Marine, High Performance and Racing Vehicles. Terminals: HC-CARGO 191733, 191734, 192758.



Height: 44.45 mm

Type/fuse: Assemble

**191726 Powr-Blok Relay Socket Std pkg 10**

The POWR-BLOKS system gives you unlimited flexibility to design electrical distribution systems that range from simple to complex. Choose from a variety of POWR-BLOKS modules that accommodate everything you need in power distribution or circuit protection blocks, including fuses, circuit breakers, relays, flashers and specialty devices. It is the totally modular way to build your own junction block. Typical Applications: Buses, Conversion Vans, Off Road and Recreational Vehicles, Construction Equipment, Emergency Vehicles, Farm Equipment, Heavy Duty Trucks, Industrial Vehicles, Marine, High Performance and Racing Vehicles. Terminals 6.3 mm: HC-CARGO 191764, 191765, 191766. Terminals 9.5 mm: HC-CARGO 191025.

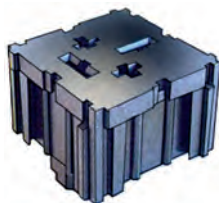

Height: 25.4 mm  
Module: Relay holder

Type/fuse: Power  
No./relays: 1

**191744 Powr-Blok Std pkg 5**

The POWR-BLOKS system gives you unlimited flexibility to design electrical distribution systems that range from simple to complex. Choose from a variety of POWR-BLOKS modules that accommodate everything you need in power distribution or circuit protection blocks, including fuses, circuit breakers, relays, flashers and specialty devices. It is the totally modular way to build your own junction block. Typical Applications: Buses, Conversion Vans, Off Road and Recreational Vehicles, Construction Equipment, Emergency Vehicles, Farm Equipment, Heavy Duty Trucks, Industrial Vehicles, Marine, High Performance and Racing Vehicles. Terminal: HC-CARGO 191739, 191740. Powr-Blok Seal: HC-CARGO 191745.



Height: 34.29 mm  
Module: Fuse holder

Type/fuse: Mini  
Outlets: 4 way

**191767 Powr-Blok Mounting Std pkg 10**

The POWR-BLOKS system gives you unlimited flexibility to design electrical distribution systems that range from simple to complex. Choose from a variety of POWR-BLOKS modules that accommodate everything you need in power distribution or circuit protection blocks, including fuses, circuit breakers, relays, flashers and specialty devices. It is the totally modular way to build your own junction block. Typical Applications: Buses, Conversion Vans, Off Road and Recreational Vehicles, Construction Equipment, Emergency Vehicles, Farm Equipment, Heavy Duty Trucks, Industrial Vehicles, Marine, High Performance and Racing Vehicles. Mounting accessory modules designed for mounting fuse block to be used w/ mounting stand -off.



Height: 76.2 mm

BRIDGE			
<b>191743</b> Powr-Blok Std pkg 2			
<i>Powr-blok: HC-CARGO 191719.</i>			
			Outlets: 7 way
ACCESSORIES			
<b>191727</b> Powr-Blok Connecting Locks Std pkg 10			
<i>Insertable/removable locks designed to connect Powr-blok modules.</i>			
		Height: 20.32 mm	
<b>191728</b> Powr-Blok Std pkg 10			
<i>I.D. 8 mm. O.D. 25 mm. Rigid plastic.</i>			
		Height: 19 mm	
<b>191729</b> Powr-Blok Std pkg 10			
		Height: 25.4 mm	
<b>191730</b> Powr-Blok Std pkg 10			
		Height: 31.7 mm	
<b>191731</b> Powr-Blok Mounting Leg Std pkg 10			
		Height: 25 mm	
<b>191732</b> Powr-Blok Mounting Leg Std pkg 10			
		Height: 76.2 mm	
<b>191745</b> Powr-Blok Seal Std pkg 10 Servicing: HC-CARGO 191744			
		Height: 36.07 mm	Type/fuse: Mini

## SWITCHES

### ROTATING

**180007** 3-Way Switch Std pkg 1

 Voltage: 12/24  
Watt: 3

 Mount. hole size:  
26 mm

 Socket type: BA7s  
Button colour: Black  
Switch: On/Off/On  
No./terminals: 7  
Illuminated: Yes  
Bulb incl.: No

**180156** Rotating Switch Std pkg 1

*Comes w/ 3 lenses. Red/yellow/green.*

 Voltage: 12  
Amp: 15

 Mount. hole size:  
12.5 mm

 Bulb type: Wedge-base  
Button colour: Black  
Switch: On/Off  
No./terminals: 4  
Illuminated: Yes  
Bulb incl.: Yes  
Protection degree: IP 53

**180158** Rotating Switch Std pkg 1 Servicing: HC-CARGO 180159

*For light, fan etc.*

 Voltage: 12/24  
Amp: 15/7.5

 Mount. hole size:  
12.5 mm  
Positions: 0-1-2-3

 Button colour: Black  
No./terminals: 5  
Protection degree: IP 53

**180314** Rotating Switch Std pkg 1

*w/ blower symbol.*

 Voltage: 12/24  
Amp: 15/7.5

 Mount. hole size:  
12.5 mm  
Positions: 0-1-2

 Button colour: Black  
Button symbol: Blower  
No./terminals: 3  
Protection degree: IP 53

## ACCESSORIES

**180159** Multi Socket Std pkg 5

*For HC-CARGO 180158.*

## MINI ROCKER

**180597** Mini Rocker Switch Std pkg 5

 Voltage: 12/24  
Amp: 20/10

 Mount. hole size:  
21 mm

 Switch: On/Off  
No./terminals: 2





		EL. SPECIFICATIONS	DIMENSIONS	ADDITIONAL SPECIFICATIONS
<b>180598</b> Mini Rocker Switch	Std pkg 5	 Voltage: 12 Amp: 20	Mount. hole size: 21 mm	Type/terminal: Flat Button colour: Orange Switch: On/Off No./terminals: 3 Illuminated: Yes
<b>180599</b> Mini Rocker Switch	Std pkg 5	 Voltage: 12 Amp: 20	Mount. hole size: 21 mm	Servicing: Citroen, Fiat - Visit <a href="http://www.hc-cargo.com">www.hc-cargo.com</a> for further information. Type/terminal: Flat Button colour: Red Switch: On/Off No./terminals: 3 Illuminated: Yes
<b>180600</b> Mini Rocker Switch	Std pkg 5	 Voltage: 12 Amp: 10	Mount. hole size: 21 mm Positions: On-on	Button colour: Black Switch: On/On No./terminals: 3
<b>180601</b> Mini Rocker Switch	Std pkg 5	 Voltage: 12 Amp: 20	Mount. hole size: 20 mm	Type/terminal: Flat Bulb type: LED Button colour: Red Switch: On/Off No./terminals: 3 Illuminated: Yes Alternativ no.: 181560
<b>180627</b> Mini Rocker Switch	Std pkg 5	 Voltage: 12 Amp: 20	Mount. hole size: 21 mm	Type/terminal: Flat Button colour: Blue Switch: On/Off No./terminals: 3 Illuminated: Yes
<b>180628</b> Mini Rocker Switch	Std pkg 5	 Voltage: 12 Amp: 20	Mount. hole size: 21 mm	Type/terminal: Flat Button colour: Green Switch: On/Off No./terminals: 3 Illuminated: Yes
<b>181557</b> Mini Rocker Switch	Std pkg 5	 Voltage: 12 Amp: 20	Mount. hole size: 20 mm	Bulb type: LED Button colour: Orange Switch: On/Off Material: Plastic Automatic return: No





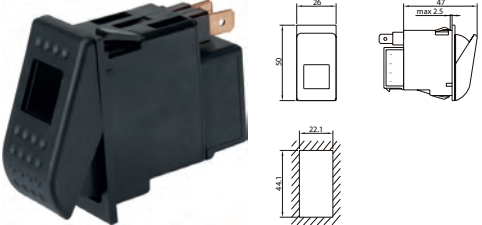
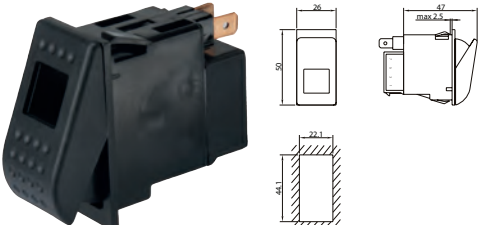



		EL. SPECIFICATIONS	DIMENSIONS	ADDITIONAL SPECIFICATIONS
<b>181558</b> Mini Rocker Switch	Std pkg 5	Voltage: 12 Amp: 20	Mount. hole size: 20 mm	Type/terminal: Flat Bulb type: LED Button colour: Blue Switch: On/Off Material: Plastic No./terminals: 3 Illuminated: Yes Automatic return: No
				
<b>181559</b> Mini Rocker Switch	Std pkg 5	Voltage: 12 Amp: 20	Mount. hole size: 20 mm	Type/terminal: Flat Bulb type: LED Button colour: Green Switch: On/Off Material: Plastic No./terminals: 3 Illuminated: Yes Automatic return: No
				
<b>181607</b> Mini Rocker Switch	Std pkg 5	Voltage: 24 Amp: 10	Mount. hole size: 21 mm	Type/terminal: Flat Bulb type: LED Button colour: Red Switch: On/Off No./terminals: 3 Illuminated: Yes
				
<b>181608</b> Mini Rocker Switch	Std pkg 5	Voltage: 24 Amp: 10	Mount. hole size: 20 mm	Type/terminal: Flat Bulb type: LED Button colour: Orange Switch: On/Off No./terminals: 3 Illuminated: Yes
				
<b>181609</b> Mini Rocker Switch	Std pkg 5	Voltage: 24 Amp: 10	Mount. hole size: 20 mm	Type/terminal: Flat Bulb type: LED Button colour: Blue Switch: On/Off No./terminals: 3 Illuminated: Yes
				
<b>181610</b> Mini Rocker Switch	Std pkg 5	Voltage: 24 Amp: 10	Mount. hole size: 20 mm	Type/terminal: Flat Bulb type: LED Button colour: Green Switch: On/Off No./terminals: 3 Illuminated: Yes
				
<b>ROCKER</b>				
<b>180090</b> Rocker Switch	Std pkg 5	Voltage: 12/24 Amp: 16/8	Mount. hole size: 28.5x11.5 mm	Switch: On/Off No./terminals: 2
				





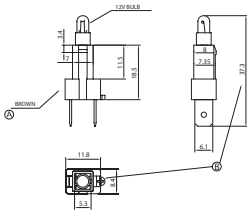

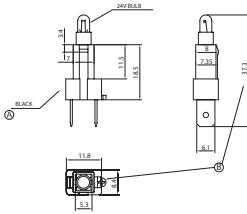











		EL. SPECIFICATIONS	DIMENSIONS	ADDITIONAL SPECIFICATIONS
<b>180099</b> Rocker Switch		Std pkg 5		
<i>Supplied w/ 12 V bulb.</i>				
		Voltage: 12 Amp: 16	Mount. hole size: 28.5x11.5 mm	Button colour: Blue Switch: On/Off No./terminals: 3 Illuminated: Yes
<b>180100</b> Rocker Switch		Std pkg 5		
<i>Supplied w/ 12 V bulb.</i>				
		Voltage: 12 Amp: 16	Mount. hole size: 28.5x11.5 mm	Button colour: Green Switch: On/Off No./terminals: 3 Illuminated: Yes
<b>180101</b> Rocker Switch		Std pkg 5		
<i>Supplied w/ 12 V bulb.</i>				
		Voltage: 12 Amp: 16	Mount. hole size: 28.5x11.5 mm	Button colour: Red Switch: On/Off No./terminals: 3 Illuminated: Yes
<b>180176</b> Rocker Switch		Std pkg 5		
		Voltage: 12/24 Amp: 10/5	Mount. hole size: 12.5 mm	Switch: On/Off No./terminals: 2
<b>180177</b> Rocker Switch		Std pkg 5		
<i>Supplied w/ 12 V bulb.</i>				
		Voltage: 12 Amp: 10	Mount. hole size: 12.5 mm	Button colour: Blue Switch: On/Off No./terminals: 3 Illuminated: Yes
<b>180178</b> Rocker Switch		Std pkg 5		
<i>Supplied w/ 12 V bulb.</i>				
		Voltage: 12 Amp: 10	Mount. hole size: 12.5 mm	Button colour: Green Switch: On/Off No./terminals: 3 Illuminated: Yes
<b>180179</b> Rocker Switch		Std pkg 5		
<i>Supplied w/ 12 V bulb.</i>				
		Voltage: 12 Amp: 10	Mount. hole size: 12.5 mm	Button colour: Red Switch: On/Off No./terminals: 3 Illuminated: Yes

	EL. SPECIFICATIONS	DIMENSIONS	ADDITIONAL SPECIFICATIONS
<b>180180</b> Rocker Switch <span style="float: right;">Std pkg 5</span> <i>Supplied w/ 12 V bulb.</i>		Voltage: 12 Amp: 10	Mount. hole size: 12.5 mm Positions: 3 Button colour: Orange Switch: On/Off No./terminals: 3 Illuminated: Yes
<b>180206</b> Rocker Switch <span style="float: right;">Std pkg 1</span> <i>w/o symbol plate. Illuminated w/ location and function light. Bulb: HC-CARGO 181615, 181667 (LED). Blind cover: HC-CARGO 181661. Multi Plug: HC-CARGO 180208. Plastic Module Panel: HC-CARGO 181662, 181663, 181664, 181665, 181666. Symbol Plate: HC-CARGO 180209, 180210, 181462, 181463, 181641...181660.</i>		Voltage: 12 Amp: 16 Watt: 1.2	Mount. hole size: 22.1x44.1 mm Bulb type: 170758 Socket type: T5 Switch: On/Off No./terminals: 4 Illuminated: Yes Bulb incl.: Yes
<b>180207</b> Rocker Switch <span style="float: right;">Std pkg 1</span> <i>w/o symbol plate. Illuminated w/ location and function light. Bulb: HC-CARGO 181632, 181668 (LED). Blind cover: HC-CARGO 181661. Multi Plug: HC-CARGO 180208. Plastic Module Panel: HC-CARGO 181662, 181663, 181664, 181665, 181666. Symbol Plate: HC-CARGO 180209, 180210, 181462, 181463, 181641...181660.</i>		Voltage: 24 Amp: 8 Watt: 1.2	Mount. hole size: 22.1x44.1 mm Socket type: T5 Switch: On/Off No./terminals: 4 Illuminated: Yes Bulb incl.: Yes
<b>181546</b> Rocker Switch <span style="float: right;">Std pkg 1</span> <i>w/o symbol plate. Illuminated w/ location and function light. Bulb: HC-CARGO 181615, 181667 (LED), 181632, 181668 (LED). Blind cover: HC-CARGO 181661. Multi Plug: HC-CARGO 180208. Plastic Module Panel: HC-CARGO 181662, 181663, 181664, 181665, 181666. Symbol Plate: HC-CARGO 180209, 180210, 181462, 181463, 181641...181660. Spring loaded = (On).</i>		Voltage: 12/24	Mount. hole size: 22.1x44.1 mm Type/terminal: Flat Switch: (On)/Off/(On) No./terminals: 6 Bulb incl.: No Automatic return: Yes
<b>181554</b> Rocker Switch <span style="float: right;">Std pkg 5</span>		Voltage: 12 Amp: 16	Mount. hole size: 12.5 mm Bulb type: LED Button colour: Orange Switch: On/Off Material: Plastic No./terminals: 3 Automatic return: No
<b>181555</b> Rocker Switch <span style="float: right;">Std pkg 5</span>		Voltage: 12 Amp: 16	Mount. hole size: 12.5 mm Bulb type: LED Colour: Green Switch: On/Off Material: Plastic No./terminals: 3 Automatic return: No

		EL. SPECIFICATIONS	DIMENSIONS	ADDITIONAL SPECIFICATIONS
<b>181556</b> Rocker Switch <span style="float: right;">Std pkg 5</span>		Voltage: 12 Amp: 16	Mount. hole size: 12.5 mm	Bulb type: LED Button colour: Red Switch: On/Off Material: Plastic No./terminals: 3 Automatic return: No
				
<b>181638</b> Rocker Switch <span style="float: right;">Std pkg 1</span>		<i>w/o symbol plate. Illuminated w/ location and function light. Bulb: HC-CARGO 181615, 181667 (LED). Blind cover: HC-CARGO 181661. Multi Plug: HC-CARGO 180208. Plastic Module Panel: HC-CARGO 181662, 181663, 181664, 181665, 181666. Symbol Plate: HC-CARGO 180209, 180210, 181462, 181463, 181641...181660.</i>		
		Voltage: 12 Amp: 16 Watt: 1.2	Mount. hole size: 22.1x44.1 mm	Socket type: T5 Switch: On/Off No./terminals: 4 Bulb incl.: Yes Automatic return: Yes
<b>181639</b> Rocker Switch <span style="float: right;">Std pkg 1</span>		<i>w/o symbol plate. Illuminated w/ location and function light. Bulb: HC-CARGO 181632, 181668 (LED). Blind cover: HC-CARGO 181661. Multi Plug: HC-CARGO 180208. Plastic Module Panel: HC-CARGO 181662, 181663, 181664, 181665, 181666. Symbol Plate: HC-CARGO 180209, 180210, 181462, 181463, 181641...181660.</i>		
		Voltage: 24 Amp: 8 Watt: 1.2	Mount. hole size: 22.1x44.1 mm	Socket type: T5 Switch: On/Off No./terminals: 4 Bulb incl.: Yes Automatic return: Yes
<b>181640</b> Rocker Switch <span style="float: right;">Std pkg 1</span>		<i>w/o symbol plate. Illuminated w/ location and function light. Bulb: HC-CARGO 181615, 181667 (LED), 181632, 181668 (LED). Blind cover: HC-CARGO 181661. Multi Plug: HC-CARGO 180208. Plastic Module Panel: HC-CARGO 181662, 181663, 181664, 181665, 181666. Symbol Plate: HC-CARGO 180209, 180210, 181462, 181463, 181641...181660. Spring loaded = (On).</i>		
		Voltage: 12/24	Mount. hole size: 22.1x44.1 mm	Type/terminal: Flat Switch: (On)/Off/(On) No./terminals: 6 Bulb incl.: No Automatic return: Yes
<b>211123</b> Rocker Switch <span style="float: right;">Std pkg 1</span> <span style="float: right;">Servicing: HC-CARGO 211083, 211097</span>		<i>w/o symbol plate. Illuminated w/ location and function light. Bulb: HC-CARGO 181615, 181667 (LED), 181632, 181668 (LED). Blind cover: HC-CARGO 181661. Multi Plug: HC-CARGO 180208. Plastic Module Panel: HC-CARGO 181662, 181663, 181664, 181665, 181666. Symbol Plate: HC-CARGO 180209, 180210, 181462, 181463, 181641...181660. Spring loaded = (On).</i>		
		Voltage: 12/24		Type/terminal: Flat No./terminals: 3
<b>ACCESSORIES</b>				
<b>180208</b> Multi Plug <span style="float: right;">Std pkg 10</span> <span style="float: right;">Servicing: HC-CARGO 180206, 180207, 181546, 181638, 181639, 181640</span>		<i>For SWF-type switches. Terminal: HC-CARGO 19025, 190868, 192377, 192376, 191029.</i>		
				Type/terminal: Flat No./poles: 8 Plug: Female

	EL. SPECIFICATIONS	DIMENSIONS	ADDITIONAL SPECIFICATIONS
<b>180209</b> Symbol Plate	Std pkg 10	Servicing: HC-CARGO 180206, 180207, 181546, 181638, 181639, 181640	Colour: Yellow Symbol: Rotating beacon
			
<b>180210</b> Symbol Plate	Std pkg 10	Servicing: HC-CARGO 180206, 180207, 181546, 181638, 181639, 181640	Colour: Green Symbol: Work Light, front
			
<b>181462</b> Symbol Plate	Std pkg 10	Servicing: HC-CARGO 180206, 180207, 181546, 181638, 181639, 181640	Colour: Green
			
<b>181463</b> Symbol Plate	Std pkg 10	Servicing: HC-CARGO 180206, 180207, 181546, 181638, 181639, 181640	Colour: Red
			
<b>181615</b> Bulb Holder 12 V	Std pkg 10	Servicing: HC-CARGO 180206, 181546, 181638, 181640	
<i>Bulb: HC-CARGO 170758.</i>			
		Voltage: 12	
<b>181632</b> Bulb Holder 24 V	Std pkg 10	Servicing: HC-CARGO 180207, 181546, 181639, 181640	
<i>Bulb: HC-CARGO 171029.</i>			
		Voltage: 24	
<b>181641</b> Symbol Plate	Std pkg 10	Servicing: HC-CARGO 180206, 180207, 181546, 181638, 181639, 181640	Colour: Green Symbol: High Beam
			

EL. SPECIFICATIONS		DIMENSIONS		ADDITIONAL SPECIFICATIONS
<b>181642</b> Symbol Plate	Std pkg 10	Servicing: HC-CARGO 180206, 180207, 181546, 181638, 181639, 181640		Colour: Green Symbol: Fog Light
				
<b>181643</b> Symbol Plate	Std pkg 10	Servicing: HC-CARGO 180206, 180207, 181546, 181638, 181639, 181640		Colour: Black Symbol: Parking light
				
<b>181644</b> Symbol Plate	Std pkg 10	Servicing: HC-CARGO 180206, 180207, 181546, 181638, 181639, 181640		Colour: Red Symbol: Hazard Warning Lamp
				
<b>181645</b> Symbol Plate	Std pkg 10	Servicing: HC-CARGO 180206, 180207, 181546, 181638, 181639, 181640		Colour: Black Symbol: Interior Lighting
				
<b>181646</b> Symbol Plate	Std pkg 10	Servicing: HC-CARGO 180206, 180207, 181546, 181638, 181639, 181640		Colour: Green Symbol: Work Light
				
<b>181647</b> Symbol Plate	Std pkg 10	Servicing: HC-CARGO 180206, 180207, 181546, 181638, 181639, 181640		Colour: Green Symbol: Work Light
				
<b>181648</b> Symbol Plate	Std pkg 10	Servicing: HC-CARGO 180206, 180207, 181546, 181638, 181639, 181640		Colour: Black Symbol: Loading Floor Lamp
				
<b>181649</b> Symbol Plate	Std pkg 10	Servicing: HC-CARGO 180206, 180207, 181546, 181638, 181639, 181640		Colour: Green Symbol: Rotating beacon
				

	EL. SPECIFICATIONS	DIMENSIONS	ADDITIONAL SPECIFICATIONS
<b>181650</b> Symbol Plate	Std pkg 10	Servicing: HC-CARGO 180206, 180207, 181546, 181638, 181639, 181640	Colour: Green Symbol: Wiper & Washer
			
<b>181651</b> Symbol Plate	Std pkg 10	Servicing: HC-CARGO 180206, 180207, 181546, 181638, 181639, 181640	Colour: Green Symbol: Horn
			
<b>181652</b> Symbol Plate	Std pkg 10	Servicing: HC-CARGO 180206, 180207, 181546, 181638, 181639, 181640	Colour: Green Symbol: Blower
			
<b>181653</b> Symbol Plate	Std pkg 10	Servicing: HC-CARGO 180206, 180207, 181546, 181638, 181639, 181640	Colour: Green Symbol: Washer
			
<b>181654</b> Symbol Plate	Std pkg 10	Servicing: HC-CARGO 180206, 180207, 181546, 181638, 181639, 181640	Colour: Green Symbol: Windscreen Wiper
			
<b>181655</b> Symbol Plate	Std pkg 10	Servicing: HC-CARGO 180206, 180207, 181546, 181638, 181639, 181640	Colour: Green Symbol: Seat Heating
			
<b>181656</b> Symbol Plate	Std pkg 10	Servicing: HC-CARGO 180206, 180207, 181546, 181638, 181639, 181640	Colour: Green Symbol: Parking Brake
			
<b>181657</b> Symbol Plate	Std pkg 10	Servicing: HC-CARGO 180206, 180207, 181546, 181638, 181639, 181640	Colour: Green Symbol: Indicator
			

	EL. SPECIFICATIONS	DIMENSIONS	ADDITIONAL SPECIFICATIONS
<b>181658</b> Symbol Plate	Std pkg 10	Servicing: HC-CARGO 180206, 180207, 181546, 181638, 181639, 181640	Colour: Green Symbol: Rear Window Wiper
			
<b>181659</b> Symbol Plate	Std pkg 10	Servicing: HC-CARGO 180206, 180207, 181546, 181638, 181639, 181640	Colour: Green Symbol: Rear Windscreen Wash
			
<b>181660</b> Symbol Plate	Std pkg 10	Servicing: HC-CARGO 180206, 180207, 181546, 181638, 181639, 181640	Colour: White Symbol: Heating & Ventilation
			
<b>181661</b> Blind cover	Std pkg 10	Servicing: HC-CARGO 180206, 180207, 181546, 181638, 181639, 181640	
			
<b>181662</b> Plastic Module Panel	Std pkg 1	Servicing: HC-CARGO 180206, 180207, 181546, 181638, 181639, 181640	
			
<b>181663</b> Plastic Module Panel	Std pkg 1	Servicing: HC-CARGO 180206, 180207, 181546, 181638, 181639, 181640	<i>Can be assembled in rows.</i>
			
<b>181664</b> Plastic Module Panel	Std pkg 1	Servicing: HC-CARGO 180206, 180207, 181546, 181638, 181639, 181640	<i>Can be assembled in rows (end piece.)</i>
			

**181665** Plastic Module Panel

Std pkg 1

Servicing: HC-CARGO 180206, 180207, 181546, 181638, 181639, 181640

3 holes.

**181666** Plastic Module Panel

Std pkg 1

Servicing: HC-CARGO 180206, 180207, 181546, 181638, 181639, 181640

6 holes.

**181667** Bulb Holder 12 V LED

Std pkg 10

Servicing: HC-CARGO 180206, 181546, 181638, 181640

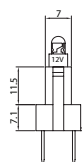
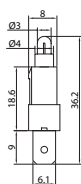

Voltage: 12

**181668** Bulb Holder 24 V LED

Std pkg 10

Servicing: HC-CARGO 180207, 181546, 181639, 181640

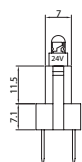
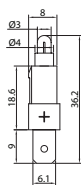

Voltage: 24

## TOGGLE

### METAL ARM

**180039** 3-Way Switch

Std pkg 1

For steering column of 35-40 mm.

 Voltage: 12/24  
 Amp: 16/8  
 Watt: 1.5

 Bulb type: T 1 1/2 Midget  
 Socket type: T-1 1/2  
 Button colour: Green  
 Illuminated: Yes  
 Bulb incl.: Yes

**180048** 3-Way Switch







Std pkg 5







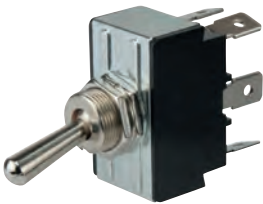

 Voltage: 12  
 Amp: 20

 Mount. hole size:  
 12.5 mm

 Button colour: Black  
 Switch: On/Off/On  
 No./terminals w/screw: 3



		EL. SPECIFICATIONS	DIMENSIONS	ADDITIONAL SPECIFICATIONS
<b>180584 Toggle Switch</b> Std pkg 1		<i>Rubber Boot: HC-CARGO 181672. Cover For Toggle Switch: HC-CARGO 181551, 181552.</i>		
	Voltage: 12/24 Amp: 16/8	Mount. hole size: 12 mm	Switch: On/Off Material: Metal No./terminals: 2 Arm: Short	
<b>180585 Toggle Switch</b> Std pkg 1		<i>Rubber Boot: HC-CARGO 180595, 181672. Spring loaded = (On).</i>		
	Voltage: 12/24 Amp: 16/8	Mount. hole size: 12 mm	Switch: On/(On) Material: Metal No./terminals: 3 Arm: Short	
<b>180586 Toggle Switch</b> Std pkg 1		<i>Rubber Boot: HC-CARGO 181672.</i>		
	Voltage: 12/24 Amp: 16/8	Mount. hole size: 12 mm	Switch: On/On Material: Metal No./terminals: 3 Arm: Short	
<b>180587 Toggle Switch</b> Std pkg 1		<i>Rubber Boot: HC-CARGO 181672. Spring loaded = (On).</i>		
	Voltage: 12/24 Amp: 16/8	Mount. hole size: 12 mm	Switch: (On)/Off/(On) Material: Metal No./terminals: 3 Arm: Short	
<b>180588 Toggle Switch</b> Std pkg 1		<i>Service: Ford - Visit <a href="http://www.hc-cargo.com">www.hc-cargo.com</a> for further information.</i>		
<i>Rubber Boot: HC-CARGO 181672. Spring loaded = (On).</i>				
	Voltage: 12/24 Amp: 16/8	Mount. hole size: 12 mm	Switch: On/Off/(On) Material: Metal No./terminals: 3 Arm: Short	
<b>180589 Toggle Switch</b> Std pkg 1		<i>Rubber Boot: HC-CARGO 181672.</i>		
	Voltage: 12/24 Amp: 16/8	Mount. hole size: 12 mm	Switch: On/Off/On Material: Metal No./terminals: 3 Arm: Short	
<b>180590 Toggle Switch</b> Std pkg 1		<i>Rubber Boot: HC-CARGO 181672.</i>		
	Voltage: 12/24 Amp: 16/8	Mount. hole size: 12 mm	Switch: On/Off Material: Metal No./terminals: 4 Arm: Short 2 poles: w/	

		EL. SPECIFICATIONS	DIMENSIONS	ADDITIONAL SPECIFICATIONS
<b>180591 Toggle Switch</b> Std pkg 1 <i>Rubber Boot: HC-CARGO 181672.</i>				
		Voltage: 12/24 Amp: 16/8	Mount. hole size: 12 mm	Switch: On/On Material: Metal No./terminals: 6 Arm: Short 2 poles: w/
<b>180592 Toggle Switch</b> Std pkg 1 <i>Rubber Boot: HC-CARGO 181672. Spring loaded = (On).</i>				
		Voltage: 12/24 Amp: 16/8	Mount. hole size: 12 mm	Switch: (On)/Off/(On) Material: Metal No./terminals: 6 Arm: Short 2 poles: w/
<b>180593 Toggle Switch</b> Std pkg 1 <i>Rubber Boot: HC-CARGO 181672. Spring loaded = (On).</i>				
		Voltage: 12/24 Amp: 16/8	Mount. hole size: 12 mm	Switch: On/Off/(On) Material: Metal No./terminals: 6 Arm: Short 2 poles: w/
<b>180594 Toggle Switch</b> Std pkg 1 <i>Rubber Boot: HC-CARGO 181672. Cover For Toggle Switch: HC-CARGO 181551, 181552.</i>				
		Voltage: 12/24 Amp: 16/8	Mount. hole size: 12 mm	Switch: On/Off/On Material: Metal No./terminals: 6 Arm: Short 2 poles: w/
<b>180618 Toggle Switch</b> Std pkg 1 <i>Spring loaded = (On).</i>				
		Voltage: 12/24 Amp: 6/3	Mount. hole size: 12 mm	Switch: (On)/Off/(On) Material: Metal No./terminals: 3 Arm: Long
<b>181276 Mini Toggle Switch</b> Std pkg 5 <i>Mini.</i>				
		Voltage: 12/24 Amp: 6/3	Mount. hole size: 6 mm	Switch: On/Off Material: Metal No./terminals: 2 Arm: Short
<b>181277 Mini Toggle Switch</b> Std pkg 5 <i>Mini.</i>				
		Voltage: 12/24 Amp: 6/3	Mount. hole size: 6 mm	Switch: On/On Material: Metal No./terminals: 3 Arm: Short

		EL. SPECIFICATIONS	DIMENSIONS	ADDITIONAL SPECIFICATIONS
<b>181278</b> Mini Toggle Switch	Std pkg 5	Voltage: 12/24 Amp: 6/3	Mount. hole size: 6 mm	Switch: On/Off/On Material: Metal No./terminals: 3 Arm: Short
				
<b>PLAST ARM</b>				
<b>180018</b> Toggle Switch	Std pkg 5	Voltage: 12/24 Amp: 10/5	Mount. hole size: 12.5 mm	Colour: Black Switch: On/Off No./terminals: 2 Arm: Long
				
<b>180036</b> 3-Way Switch	Std pkg 5	Voltage: 12/24 Amp: 16/8	Mount. hole size: 12.5 mm	Button colour: Black Switch: On/Off/On No./terminals: 3 Arm: Short
				
<b>180088</b> Toggle Switch	Std pkg 5	Voltage: 12/24 Amp: 16/8	Mount. hole size: 12.5 mm	Colour: Black Switch: Off/(On) No./terminals: 2 Arm: Short
<i>Spring loaded = (On).</i> 				
<b>180091</b> Toggle Switch	Std pkg 5	Voltage: 12 Amp: 10	Mount. hole size: 12.5 mm	Colour: Blue Switch: On/Off No./terminals: 3 Arm: Short Illuminated: Yes Bulb incl.: Yes
				
<b>180092</b> Toggle Switch	Std pkg 5	Voltage: 12 Amp: 10	Mount. hole size: 12.5 mm	Colour: Green Switch: On/Off No./terminals: 3 Arm: Short Illuminated: Yes Bulb incl.: Yes
				
<b>180094</b> Toggle Switch	Std pkg 5	Voltage: 12 Amp: 10	Mount. hole size: 12.5 mm	Colour: Red Switch: On/Off No./terminals: 3 Arm: Short Illuminated: Yes Bulb incl.: Yes
				

		EL. SPECIFICATIONS	DIMENSIONS	ADDITIONAL SPECIFICATIONS
<b>180140</b> Toggle Switch	Std pkg 5	Voltage: 12/24 Amp: 10/5	Mount. hole size: 12.5 mm	Colour: Black Switch: On/Off No./terminals: 2 Arm: Short
				
<b>180141</b> Toggle Switch	Std pkg 5	Voltage: 12/24 Amp: 5/2.5	Mount. hole size: 12.5 mm	Colour: Black Switch: On/On No./terminals: 3 Arm: Short 2 poles: w/
				
<b>ACCESSORIES</b>				
<b>180595</b> Rubber Boot	Std pkg 5	Servicing: HC-CARGO 180585		
			Thread: M12x1	Thread type: Internal Material: Rubber
<b>181551</b> Cover For Toggle Switch	Std pkg 5	Servicing: HC-CARGO 180584, 180594		
				Colour: Red Automatic return: Yes
<b>181552</b> Cover For Toggle Switch	Std pkg 5	Servicing: HC-CARGO 180584, 180594		
				Colour: Yellow Automatic return: Yes
<b>181672</b> Rubber Boot	Std pkg 5	Servicing: HC-CARGO 180584, 180585, 180586, 180587, 180588, 180589, 180590, 180591, 180592, 180593, 180594		
 			Thread: M12x0.75	Thread type: Internal Material: Rubber
<b>PUSH-PULL</b>				
<b>180010</b> Push/Pull Switch	Std pkg 1	For lights ect.		
		Voltage: 12 Amp: 30	Mount. hole size: 10 mm	Button colour: Black Switch: Off/On/On No./terminals w/screw: 4

	EL. SPECIFICATIONS	DIMENSIONS	ADDITIONAL SPECIFICATIONS
<b>180021 Push/Pull Switch</b> Std pkg 1			
<i>Max. 3 W BA 7 bulb.</i>			
	Voltage: 12/24 Amp: 6/3	Mount. hole size: 12.5 mm	Type/terminal: Flat Button colour: Orange Switch: On/Off No./terminals: 2 Illuminated: Yes Bulb incl.: No
<b>180022 Push/Pull Switch</b> Std pkg 1			
<i>Max. 3 W BA 7 bulb.</i>			
	Voltage: 12/24 Amp: 6/3	Mount. hole size: 12.5 mm	Type/terminal: Terminal Button colour: Green Switch: On/Off No./terminals: 2 Illuminated: Yes Bulb incl.: No
<b>180023 Push/Pull Switch</b> Std pkg 1			
<i>Max. 3 W BA 7 bulb.</i>			
	Voltage: 12/24 Amp: 6/3	Mount. hole size: 12.5 mm	Type/terminal: Terminal Button colour: Red Switch: On/Off No./terminals: 2 Illuminated: Yes Bulb incl.: No
<b>180103 Push/Pull Switch</b> Std pkg 5			
	Voltage: 12/24 Amp: 25/12.5	Neck: Short Mount. hole size: 8 mm	Type/terminal: Screw Button colour: Black Switch: On/Off No./terminals w/screw: 2 Illuminated: No
<b>180104 Push/Pull Switch</b> Std pkg 5			
	Voltage: 12/24 Amp: 25/12.5	Neck: Long Mount. hole size: 8 mm	Button colour: Black Switch: On/Off No./terminals w/screw: 2
<b>181233 Push/Pull Switch</b> Std pkg 5			
	Voltage: 12/24 Amp: 25/12.5	Neck: Short Mount. hole size: 8 mm	Type/terminal: Flat Button colour: Black Switch: On/Off No./terminals: 2
<b>PUSH BUTTON</b>			
<b>180040 Push Button Switch</b> Std pkg 1			
<i>Rubber Boot: HC-CARGO 181272. Spring loaded = (On).</i>			
	Voltage: 12/24 Amp: 25/12.5	Mount. hole size: 22.5 mm	Switch: Off/(On) No./terminals w/screw: 2 Moulded: Yes DIN norm: 72764

		EL. SPECIFICATIONS	DIMENSIONS	ADDITIONAL SPECIFICATIONS
<b>180047</b> Push Button Switch      Std pkg 1				
		Voltage: 12/24	Mount. hole size: 12.5 mm	Button colour: Black Switch: Off/(On) No./terminals w/screw: 1
<b>180049</b> Push Button Switch      Std pkg 1				
<i>Rubber Boot: HC-CARGO 181272. Spring loaded = (On).</i>				
		Voltage: 12/24 Amp: 25/12.5	Mount. hole size: 22.5 mm	Button colour: Black Switch: Off/(On) No./terminals w/screw: 2 DIN norm: 72764
<b>180121</b> Push Button Switch      Std pkg 1				
<i>Spring loaded = (On).</i>				
		Voltage: 12/24 Amp: 25/12.5	Mount. hole size: 22 mm	Button colour: Black Switch: Off/(On) Material: Metal No./terminals w/screw: 2 DIN norm: 72764
<b>180215</b> Push Button Switch      Std pkg 1				
<i>Rubber Boot: HC-CARGO 181272. Spring loaded = (On).</i>				
		Voltage: 12/24 Amp: 25/12.5	Mount. hole size: 22.5 mm	Switch: Off/(On) No./terminals w/screw: 2 Moulded: Yes Silver contact: Yes
<b>180400</b> Push Button Switch      Std pkg 1				
<i>Depth: 20 mm. Spring loaded = (On).</i>				
		Voltage: 12/24 Amp: 7/3.5	Mount. hole size: 15.5 mm	Type/terminal: Screw Button colour: Black Switch: Off/(On) No./terminals w/screw: 2
<b>SPARE PARTS</b>				
<b>181272</b> Rubber Boot      Std pkg 10      Servicing: HC-CARGO 180049, 180040, 180215				
<i>Moulded.</i>				
			OD: 28.3 mm Length: 18 mm	Colour: Black Material: Rubber
<b>PUSH-PUSH</b>				
<b>180123</b> On/Off Switch      Std pkg 1				
		Voltage: 12/24	Mount. hole size: 8 mm	Button colour: White Switch: On/Off No./terminals w/screw: 2

		EL. SPECIFICATIONS	DIMENSIONS	ADDITIONAL SPECIFICATIONS
<b>181564 Push Button Switch</b> Std pkg 1				
<i>Illuminated ring. Vandal proof.</i>				
		Voltage: 12/24 Amp: <2 Voltage 2: 250 Amp 2: 3	Mount. hole size: 16 mm	Type/terminal: Solder Socket type: LED Colour: Red Switch: On/Off Material: Nickel plated brass Moulded: No Silver contact: Yes Protection degree: IP 67
<b>181565 Push Button Switch</b> Std pkg 1				
<i>Illuminated ring. Vandal proof.</i>				
		Voltage: 12/24 Amp: <2 Voltage 2: 250 Amp 2: 3	Mount. hole size: 16 mm	Type/terminal: Solder Socket type: LED Button colour: Green Switch: On/Off Material: Nickel plated brass Moulded: No Silver contact: Yes Protection degree: IP 67
<b>181566 Push Button Switch</b> Std pkg 1				
<i>Illuminated ring. Vandal proof.</i>				
		Voltage: 12/24 Amp: <2 Voltage 2: 250 Amp 2: 3	Mount. hole size: 16 mm	Type/terminal: Solder Socket type: LED Button colour: Yellow Switch: On/Off Material: Nickel plated brass Moulded: No Silver contact: Yes Protection degree: IP 67
<b>181567 Push Button Switch</b> Std pkg 1				
<i>Illuminated ring. Vandal proof.</i>				
		Voltage: 12/24 Amp: <2 Voltage 2: 250 Amp 2: 3	Mount. hole size: 16 mm	Type/terminal: Solder Socket type: LED Button colour: Orange Switch: On/Off Material: Nickel plated brass Moulded: No Silver contact: Yes Protection degree: IP 67
<b>181568 Push Button Switch</b> Std pkg 1				
<i>Illuminated ring. Vandal proof.</i>				
		Voltage: 12/24 Amp: <2 Voltage 2: 250 Amp 2: 3	Mount. hole size: 16 mm	Type/terminal: Solder Socket type: LED Button colour: Blue Switch: On/Off Material: Nickel plated brass Moulded: No Silver contact: Yes Protection degree: IP 67
<b>181569 Push Button Switch</b> Std pkg 1				
<i>Illuminated ring. Vandal proof.</i>				
		Voltage: 12/24 Amp: <2 Voltage 2: 250 Amp 2: 3	Mount. hole size: 16 mm	Type/terminal: Solder Socket type: LED Colour: White Button colour: Blank Switch: On/Off Material: Nickel plated brass Moulded: No Silver contact: Yes Protection degree: IP 67

**MULTI PURPOSE**
**181249** Push Switch Std pkg 1

Spring loaded = (On).

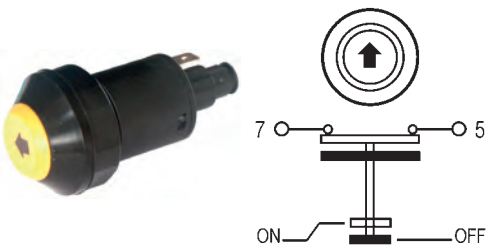
 Voltage: 12/24  
Amp: 50/25

 Mount. hole size:  
30.5 mm

 Button symbol: Lift & lower  
Switch: Off/(On)  
No./terminals: 2  
DIN norm: 40053  
Protection degree: IP 67

**181251** Push Switch Std pkg 1

 Voltage: 12/24  
Amp: 50/25

 Mount. hole size:  
30.5 mm

 Button symbol: Rotating beacon  
Switch: On/Off  
No./terminals: 6  
Illuminated: Yes  
DIN norm: 40053  
Protection degree: IP 67

**181252** Push Switch Std pkg 1

Spring loaded = (On).

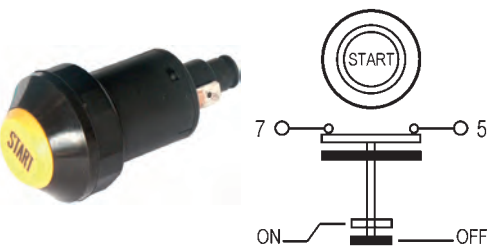
 Voltage: 12/24  
Amp: 50/25

 Mount. hole size:  
30.5 mm

 Button symbol: Start  
Switch: Off/(On)  
No./terminals: 2  
DIN norm: 40053  
Protection degree: IP 67

**181253** Push Switch Std pkg 1

 Voltage: 12/24  
Amp: 50/25

 Mount. hole size:  
30.5 mm

 Button symbol: Adjustable light  
Switch: On/Off  
No./terminals: 4  
Illuminated: Yes  
DIN norm: 40053  
Protection degree: IP 67

**181256** Push Switch Std pkg 1

 Voltage: 12/24  
Amp: 50/25

 Mount. hole size:  
30.5 mm

 Button symbol: Hazard Warning Lamp  
Switch: On/Off  
No./terminals: 7  
Illuminated: Yes  
Automatic return: Yes  
DIN norm: 40053  
Protection degree: IP 67

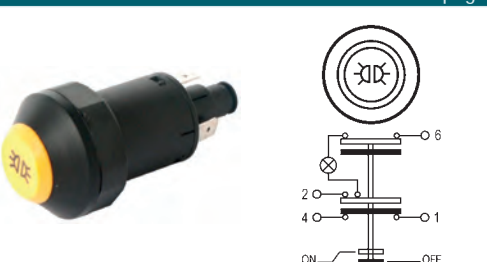





**181257** Push Switch Std pkg 1

 Voltage: 12/24  
Amp: 50/25







 Mount. hole size:  
30.5 mm





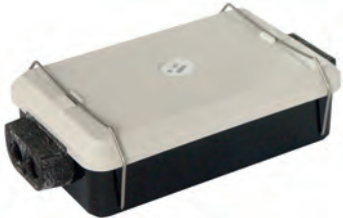

 Button symbol: Sidemarker  
Switch: On/Off  
No./terminals: 4  
Illuminated: Yes  
DIN norm: 40053  
Protection degree: IP 67

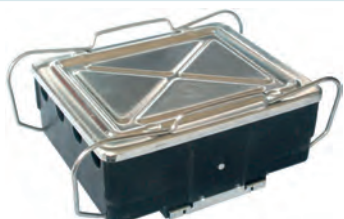

<b>181258 Push Switch</b> Std pkg 1 <i>Spring loaded = (On).</i>			Voltage: 12/24 Amp: 50/25	Mount. hole size: 30.5 mm	Button symbol: Horn Switch: Off/(On) No./terminals w/screw: 2 DIN norm: 40053 Protection degree: IP 67
<b>181263 Push Switch</b> Std pkg 1			Voltage: 12/24 Amp: 50/25	Mount. hole size: 30.5 mm	Switch: On/Off No./terminals w/screw: 6 Illuminated: Yes Automatic return: Yes DIN norm: 40053 Protection degree: IP 67
<b>181264 Multi Socket</b> Std pkg 5 <i>For multi purpose switches.</i>					Type/terminal: Flat No./poles: 7
<h2>DOOR &amp; BURGLAR ALARM</h2>					
<b>180254 Door Switch</b> Std pkg 2 <i>Universal.</i>				L1 dim.: 10-15 mm L2 dim.: 0-20 mm L2/self adjustable: Yes	No./terminals: 1
<b>180255 Door Switch</b> Std pkg 2 <i>Universal.</i>				L1 dim.: 10-15 mm L2 dim.: 0-20 mm L2/self adjustable: Yes	No./terminals: 2
<b>180261 Door Switch</b> Std pkg 10 <i>For luggage compartment.</i>				L1 dim.: 15 mm L2 dim.: 49 mm L2/self adjustable: Yes	No./terminals: 1

		EL. SPECIFICATIONS	DIMENSIONS	ADDITIONAL SPECIFICATIONS
<b>180263</b> Door Switch	Std pkg 10	Servicing: Austin, Rover - Visit <a href="http://www.hc-cargo.com">www.hc-cargo.com</a> for further information.		
			L1 dim.: 13 mm L2 dim.: 15 mm	No./terminals: 1
<b>180265</b> Door Switch	Std pkg 2	Servicing: Fiat, Seat - Visit <a href="http://www.hc-cargo.com">www.hc-cargo.com</a> for further information.		
			L1 dim.: 12 mm L2 dim.: 9 mm	No./terminals: 1
<b>180266</b> Door Switch	Std pkg 2	Servicing: Fiat Uno - Visit <a href="http://www.hc-cargo.com">www.hc-cargo.com</a> for further information.		
			L1 dim.: 15 mm L2 dim.: 9 mm	No./terminals: 2
<b>180268</b> Door/Alarm Switch	Std pkg 1	<i>Universal.</i>		
			L1 dim.: 11 mm L2 dim.: 22 mm Dist. mount. holes: 22 mm	No./terminals: 1
<b>180269</b> Door Switch	Std pkg 1	<i>Universal.</i>		
			L1 dim.: 12 mm L2 dim.: 4.5 mm Dist. mount. holes: 22 mm	No./terminals: 1
<b>180529</b> Door Switch	Std pkg 1	<i>Universal.</i>		
			L1 dim.: 14.5 mm L2 dim.: 12 mm Dist. mount. holes: 30 mm	No./terminals: 2
<b>180625</b> Door/Alarm Switch	Std pkg 10	<i>Universal. Suitable for cutting to length.</i>		
			L1 dim.: 15 mm L2 dim.: 40 mm	No./terminals: 1

JUNCTION BOXES			
191183 Junction Box	Std pkg 1		Length: 75 mm Height: 35 mm Width: 75 mm  Cable entries: 12 Connection block: No
191202 Junction Box	Std pkg 1		Length: 120 mm Height: 36 mm Width: 79 mm  Mount.: Screw Locking device: Mounting bracket Material/house: Plastic No./poles: 6 Cable entries: 4 Waterproof: Yes Dust proof: Yes
191203 Junction Box	Std pkg 1		Length: 120 mm Height: 36 mm Width: 79 mm  Type: Dual Mount.: Terminal Locking device: Mounting bracket Material/house: Plastic No./poles: 8 Cable entries: 4 Waterproof: Yes Dust proof: Yes
191204 Junction Box	Std pkg 1		Length: 120 mm Height: 36 mm Width: 79 mm  Mount.: Screw Locking device: Mounting bracket Material/house: Plastic No./poles: 8 Cable entries: 4 Waterproof: Yes Dust proof: Yes
191205 Junction Box	Std pkg 1		Length: 120 mm Height: 36 mm Width: 79 mm  Mount.: Terminal Locking device: Mounting bracket Material/house: Plastic No./poles: 12 Cable entries: 4 Waterproof: Yes Dust proof: Yes
191206 Junction Box	Std pkg 1		Length: 120 mm Height: 36 mm Width: 79 mm  Mount.: Screw Locking device: Mounting bracket Material/house: Plastic No./poles: 12 Cable entries: 4 Waterproof: Yes Dust proof: Yes
191207 Junction Box	Std pkg 1		Length: 140 mm Height: 47 mm Width: 100 mm  Type: Dual Mount.: Terminal Locking device: Mounting bracket Material/house: Plastic No./poles: 12 Cable entries: 6 Waterproof: Yes Dust proof: Yes

		EL. SPECIFICATIONS	DIMENSIONS	ADDITIONAL SPECIFICATIONS
<b>191208</b> Junction Box	Std pkg 1		Length: 145 mm Height: 45 mm Width: 100 mm	Mount.: Terminal Locking device: Screw Material/house: Plastic No./poles: 24 Cable entries: 4 Waterproof: Yes Dust proof: Yes
				
<b>191209</b> Junction Box	Std pkg 1		Length: 150 mm Height: 45 mm Width: 93 mm	Type: Dual Mount.: Terminal Locking device: Mounting bracket Material/house: Plastic Material/lid: Aluminium No./poles: 8 Waterproof: Yes Dust proof: Yes
				
<b>191210</b> Junction Box	Std pkg 1		Length: 120 mm Height: 30 mm Width: 69 mm	Mount.: Screw Locking device: Mounting bracket Material/house: Plastic Material/lid: Aluminium No./poles: 6 Waterproof: Yes Dust proof: Yes
				
<b>191211</b> Junction Box	Std pkg 1	<i>Cable entries and blind: HC-CARGO 191220, 191221, 191222, 191223. Terminal Block: HC-CARGO 191212, 191213, 191214.</i>		Locking device: Mounting bracket Material/house: Plastic Material/lid: Aluminium Cable entries: 8 Waterproof: Yes Dust proof: Yes Connection block: No
			Length: 190 mm Height: 80 mm Width: 135 mm	
<b>191215</b> Junction Box	Std pkg 1	<i>Cable entries and blind: HC-CARGO 191220, 191221, 191222, 191223. Connecting block: HC-CARGO 191212, 191213, 191214, 191218, 191219.</i>		Locking device: Mounting bracket Material/house: Plastic Material/lid: Aluminium Cable entries: 5 Waterproof: Yes Dust proof: Yes Connection block: No
			Length: 151 mm Height: 55 mm Width: 93 mm	
<b>191216</b> Junction Box	Std pkg 1	<i>Cable entries and blind: HC-CARGO 191220, 191221, 191222, 191223. Connecting block: HC-CARGO 191212, 191213, 191214, 191218, 191219.</i>		Locking device: Mounting bracket Material/house: Plastic Material/lid: Aluminium Cable entries: 6 Waterproof: Yes Dust proof: Yes Connection block: No
			Length: 151 mm Height: 55 mm Width: 93 mm	
<b>191429</b> Junction Box	Std pkg 1		Length: 127 mm Height: 41 mm Width: 108 mm	Mount.: Screw Colour: Transparent Material/house: Rubber Material/lid: Plastic No./poles: 8 Cable entries: 4 Waterproof: Yes Dust proof: Yes
				

EL. SPECIFICATIONS		DIMENSIONS	ADDITIONAL SPECIFICATIONS
<b>191507</b> Junction Box      Std pkg 1 		Cable dim.: 6 mm <sup>2</sup> Length: 125 mm Height: 25 mm Width: 73 mm	Mount.: Screw Material/house: Plastic No./poles: 6 Cable entries: 4 Waterproof: Yes Dust proof: Yes
<b>191508</b> Junction Box      Std pkg 1 		Cable dim.: 6 mm <sup>2</sup> Length: 125 mm Height: 25 mm Width: 73 mm	Mount.: Screw Material/house: Plastic No./poles: 8 Cable entries: 4 Waterproof: Yes Dust proof: Yes
<b>191510</b> Junction Box      Std pkg 1 		Cable dim.: 6 mm <sup>2</sup> Length: 125 mm Height: 25 mm Width: 73 mm	Type: Dual Mount.: Terminal Material/house: Plastic No./poles: 8 Cable entries: 4 Waterproof: Yes Dust proof: Yes
<b>191755</b> Junction Box      Std pkg 1 <i>Butt Splices: HC-CARGO 191756.</i> 		Length: 105 mm Height: 66 mm Width: 105 mm	Colour: White Material/house: Plastic Waterproof: Yes Dust proof: Yes
<b>191984</b> Junction Box      Std pkg 1 <i>4 double 11 pole flat plug connection and 2 double 4 pole flat plug connection. w/ locking clamps or alternatively 4 screws.</i> 		Length: 167 mm Height: 99 mm Width: 157 mm	Mount.: Terminal Material/house: Plastic Cable entries: 16 Waterproof: Yes Protection degree: IP 65 ADR-approved: Yes GGVs approval: Yes
<b>192218</b> Junction Box      Std pkg 1 <i>Power junction box for cables up to 25 mm<sup>2</sup>. Contains 2xM8 studs.</i> 			
<b>ACCESSORIES</b>			
<b>191220</b> Cable Entries      Std pkg 10      Servicing: HC-CARGO 191211, 191215, 191216 <i>O.D. 7 mm.</i> 			

	EL. SPECIFICATIONS	DIMENSIONS	ADDITIONAL SPECIFICATIONS
<b>191221</b> Cable Entries <i>O.D. 9.5 mm.</i>	Std pkg 10	Servicing: HC-CARGO 191211, 191215, 191216	
			
<b>191222</b> Cable Entries <i>O.D. 13 mm.</i>	Std pkg 10	Servicing: HC-CARGO 191211, 191215, 191216	
			
<b>191223</b> Cable Entries	Std pkg 10	Servicing: HC-CARGO 191211, 191215, 191216	
			
<b>BLOCK</b>			
<b>191212</b> Terminal Block	Std pkg 1	Servicing: HC-CARGO 191211, 191215, 191216	Type: Dual Mount.: Terminal No./poles: 14
			
<b>191213</b> Terminal Block	Std pkg 1	Servicing: HC-CARGO 191211, 191215, 191216	Type: Dual Mount.: Terminal No./poles: 28
			
<b>191214</b> Terminal Block <i>1 double 14-pole and 1 single 14-pole flat plug connection block.</i>	Std pkg 1	Servicing: HC-CARGO 191211, 191215, 191216	Type: Dual Mount.: Terminal No./poles: 14
			
<b>191218</b> Terminal Block	Std pkg 1	Servicing: HC-CARGO 191215, 191216	Type: Dual Mount.: Terminal No./poles: 8
			

**191219** Terminal Block Std pkg 1 Servicing: HC-CARGO 191215, 191216  
 1 double 8-pole and 1 single 8-pole flat plug connection block.



Type: Dual  
 Mount.: Terminal  
 No./poles: 8

**191756** Butt Splices Std pkg 1 Servicing: HC-CARGO 191755  
 8x6 terminalblock. 25 A. Terminal width: 6.3 mm



Dist. mount. holes:  
 99 mm

Terminal type: Flat  
 Material: Polycarbonate  
 Out: 8  
 Plugs in: 8

**191771** Butt Splices Std pkg 1  
 1x8 20 A.



Dist. mount. holes:  
 99 mm

Terminal type: Screw  
 Material: Polycarbonate  
 Out: 8  
 Plugs in: 8

**193011** Terminal Block Std pkg 1  
 25 A. Terminal width: 6.3 mm.



Dist. mount. holes:  
 77.3 mm

Terminal type: Flat  
 Material: Polycarbonate  
 Out: 6  
 Plugs in: 6

**CABLE & WIRING**

**CABLE CLIPS**

**RUBBER-PROFILE**



	HC-CARGO	Std pkg	Width	ID	Mount. hole size	Type	Material
	191666	Pkg. 10	12.7 mm	3.2 mm	6.8 mm	3	Rubber
	191667	Pkg. 10	12.7 mm	4.8 mm	6.8 mm	5	Rubber
	190899	Pkg. 10	12.7 mm	6.4 mm	6.8 mm	6	Rubber
	190900	Pkg. 10	12.7 mm	7.9 mm	6.8 mm	8	Rubber
	190901	Pkg. 10	12.7 mm	9.5 mm	6.8 mm	10	Rubber
	190902	Pkg. 10	12.7 mm	11.1 mm	6.8 mm	11	Rubber
	190903	Pkg. 10	12.7 mm	12.7 mm	6.8 mm	13	Rubber
	190904	Pkg. 10	12.7 mm	14.3 mm	6.8 mm	14	Rubber
	190905	Pkg. 10	12.7 mm	15.9 mm	6.8 mm	16	Rubber
	190906	Pkg. 10	12.7 mm	17.5 mm	6.8 mm	18	Rubber
	190907	Pkg. 10	12.7 mm	19 mm	6.8 mm	19	Rubber
	191668	Pkg. 10	12.7 mm	20.6 mm	6.8 mm	21	Rubber
	190908	Pkg. 10	12.7 mm	22.2 mm	6.8 mm	22	Rubber
	191669	Pkg. 10	12.7 mm	24 mm	6.8 mm	24	Rubber
	190909	Pkg. 10	12.7 mm	25.4 mm	6.8 mm	25	Rubber
	191417	Pkg. 10	12.7 mm	28.6 mm	6.8 mm	29	Rubber
	191992	Pkg. 10	12.7 mm	30.2 mm	6.8 mm	30	Rubber
	191994	Pkg. 10	12.7 mm	33.3 mm	6.8 mm	33	Rubber
	191553	Pkg. 10	12.7 mm	34.9 mm	6.8 mm	35	Rubber
	191996	Pkg. 10	12.7 mm	38.1 mm	6.8 mm	38	Rubber
	191997	Pkg. 10	12.7 mm	41 mm	6.8 mm	41	Rubber
	191998	Pkg. 10	12.7 mm	44.5 mm	6.8 mm	45	Rubber
	191814	Pkg. 10	12.7 mm	50.8 mm	6.8 mm	51	Rubber

**SELF-ADHESIVE**

	HC-CARGO	Std pkg	Cable dia.	
	190962	Pkg. 100	10 mm	<i>Self-adhesive.</i>
	190961	Pkg. 100	6 mm	<i>Self-adhesive.</i>

**BLACK PLASTIC**

	HC-CARGO	Std pkg	Length	ID	Mount. hole dia.	Colour
	191950	Pkg. 100	9.5 mm	3.2 mm	4.6 mm	Black
	191951	Pkg. 100	10.5 mm	4.8 mm	4.6 mm	Black
	191952	Pkg. 100	12 mm	6.4 mm	4.6 mm	Black
	191953	Pkg. 100	12 mm	7.9 mm	4.6 mm	Black
	191954	Pkg. 100	12.5 mm	9.5 mm	4.6 mm	Black
	191955	Pkg. 100	15.2 mm	12.7 mm	4.6 mm	Black
	191956	Pkg. 100	18.2 mm	15.8 mm	4.6 mm	Black
	191957	Pkg. 100	18.2 mm	19.4 mm	4.6 mm	Black
	191958	Pkg. 100	22 mm	25.4 mm	4.6 mm	Black
	191959	Pkg. 100	26.2 mm	31.8 mm	4.6 mm	Black

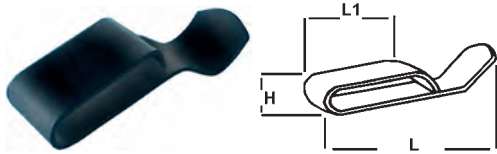
**CHASSIS CLIPS**
**191228** Chassis Clips Std pkg 100

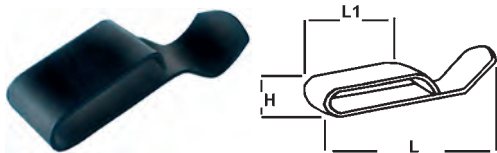
 Length: 22 mm  
 Total length: 43 mm  
 Height: 7 mm

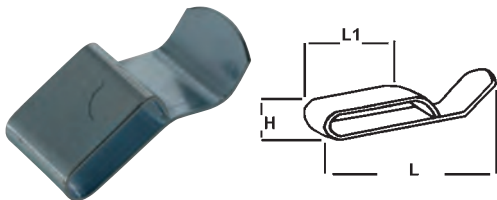
**191229** Chassis Clips Std pkg 100

 Length: 31 mm  
 Total length: 52 mm  
 Height: 7 mm

**193046** Chassis Clips Std pkg 100

 Length: 15.5 mm  
 Total length: 28 mm  
 Height: 6 mm

**PIPE CLIPS**

	HC-CARGO	Std pkg	Cable dia.	Length	Width
	193256	Pkg. 100	3 mm	12 mm	7 mm
	193257	Pkg. 100	5 mm	16 mm	12 mm
	193258	Pkg. 100	7 mm	16 mm	12 mm
	193259	Pkg. 100	8 mm	16 mm	12 mm
	193260	Pkg. 100	10 mm	16 mm	12 mm
	193261	Pkg. 100	12 mm	16 mm	14 mm
	193262	Pkg. 100	15 mm	16 mm	14 mm



**CABLE TIES**
**BLACK**

	HC-CARGO	Std pkg	Length	Width	ID	Colour	Material
	191128	Pkg. 100	92 mm	2.4 mm	16 mm	Black	Nylon 66
	191003	Pkg. 100	102 mm	2.5 mm	25 mm	Black	Nylon 66
	191939	Pkg. 100	140 mm	2.5 mm	44 mm	Black	Nylon 66
	190188	Pkg. 100	150 mm	3.6 mm	39 mm	Black	Nylon 66
	190248	Pkg. 100	190 mm	4.8 mm	52 mm	Black	Nylon 66
	191094	Pkg. 100	200 mm	2.5 mm	55 mm	Black	Nylon 66
	192112	Pkg. 100	240 mm	7.6 mm	66 mm	Black	Nylon 66
	192110	Pkg. 100	292 mm	3.6 mm	85 mm	Black	Nylon 66
	190011	Pkg. 100	310 mm	4.8 mm	89 mm	Black	Nylon 66
	190190	Pkg. 100	368 mm	4.8 mm	102 mm	Black	Nylon 66
	190189	Pkg. 100	380 mm	7.6 mm	110 mm	Black	Nylon 66
	192068	Pkg. 100	450 mm	4.8 mm	130 mm	Black	Nylon 66
	191776	Pkg. 100	550 mm	8 mm	166 mm	Black	Nylon 66
	192041	Pkg. 100	730 mm	12.7 mm	225 mm	Black	Nylon 66
	190191	Pkg. 100	762 mm	9 mm	236 mm	Black	Nylon 66
192111	Pkg. 100	812 mm	9 mm	246 mm	Black	Nylon 66	

**MOUNTING**

	HC-CARGO	Std pkg	Length	Width	ID	Mount. hole dia.
	192013	Pkg. 100	205 mm	4.2 mm	60 mm	4.8 mm
	192014	Pkg. 100	370 mm	4.8 mm	102 mm	4.8 mm
	192015	Pkg. 100	400 mm	7.9 mm	122 mm	4.8 mm

**COLOURED**

	HC-CARGO	Std pkg	Length	Width	ID	Colour
	192498	Pkg. 100	190 mm	4.8 mm	52 mm	White
	192497	Pkg. 100	190 mm	4.8 mm	52 mm	Yellow
	192494	Pkg. 100	190 mm	4.8 mm	52 mm	Red
	192495	Pkg. 100	190 mm	4.8 mm	52 mm	Blue
	192496	Pkg. 100	190 mm	4.8 mm	52 mm	Green

**W/ LOCK**
**191943** Cable Tie Std pkg 100

*Releasable w/ lock.*

	Length: 300 mm Width: 8 mm ID: 80 mm	Colour: Black
---	--	---------------

**TIE MOUNT**
**190014** Tie Mount Std pkg 100

	Dim.: 27x27 mm Mount. hole dia.: 5 mm ID: 5 mm	Colour: Black Material: Nylon 66 Self adhesive: Yes Alternativ no.: 192997
---	--	---

		EL. SPECIFICATIONS	DIMENSIONS	ADDITIONAL SPECIFICATIONS
<b>191941</b>	Tie Mount Std pkg 100		Dim.: 12.9x17.8x6.6 mm Mount. hole dia.: 6.2 mm Max width: 8 mm	Colour: White Material: Nylon 66 Self adhesive: No
<b>191960</b>	Tie Mount Std pkg 100		Dim.: 21x21 mm Mount. hole dia.: 5 mm Max width: 3.2 mm	Colour: Black Material: Nylon 66 Self adhesive: Yes
<b>192489</b>	Tie Mount Std pkg 100		Dim.: 16x15 mm Cable dia.: 8 mm	Colour: White Material: Nylon 66 Self adhesive: Yes
<b>192983</b>	Tie Mount Std pkg 100		Dim.: 38x38 mm Mount. hole dia.: 5 mm Max width: 10 mm	Colour: Black Material: Nylon 66 Self adhesive: Yes
<b>192985</b>	Tie Mount Std pkg 100 <i>w/ 5 mm hole for screw mount.</i>		Dim.: 23x16x10 mm Mount. hole dia.: 5 mm Max width: 12 mm	Colour: Black Material: Nylon Self adhesive: No
<b>192997</b>	Tie Mount Std pkg 100		Dim.: 26.1x26.1 mm Mount. hole dia.: 4.3 mm Max width: 8 mm	Colour: Black Material: Nylon Self adhesive: No

## CONNECTORS

	HC-CARGO	Std pkg	Size 1	Size 2	Size 3	Temp.	Colour	Material	Type
	<b>193164</b>	Pkg. 5	7.5 mm	7.5 mm	7.5 mm	-40 - +135 °C	Black	Polyamid	T
	<b>193129</b>	Pkg. 5	10 mm	10 mm	10 mm	-40 - +135 °C	Black	Polyamid	T
	<b>193128</b>	Pkg. 5	10 mm	7.5 mm	10 mm	-40 - +135 °C	Black	Polyamid	T
	<b>193152</b>	Pkg. 5	10 mm	7.5 mm	7.5 mm	-40 - +135 °C	Black	Polyamid	T
	<b>193153</b>	Pkg. 5	13 mm	10 mm	10 mm	-40 - +135 °C	Black	Polyamid	T
	<b>193131</b>	Pkg. 5	13 mm	10 mm	13 mm	-40 - +135 °C	Black	Polyamid	T

	HC-CARGO	Std pkg	Size 1	Size 2	Size 3	Temp.	Colour	Material	Type
	193151	Pkg. 5	13 mm	13 mm	13 mm	-40 - +135 °C	Black	Polyamid	T
	193130	Pkg. 5	13 mm	7.5 mm	13 mm	-40 - +135 °C	Black	Polyamid	T
	193134	Pkg. 5	17 mm	10 mm	13 mm	-40 - +135 °C	Black	Polyamid	T
	193135	Pkg. 5	17 mm	10 mm	17 mm	-40 - +135 °C	Black	Polyamid	T
	193136	Pkg. 5	17 mm	13 mm	13 mm	-40 - +135 °C	Black	Polyamid	T
	193137	Pkg. 5	17 mm	13 mm	17 mm	-40 - +135 °C	Black	Polyamid	T
	193212	Pkg. 5	17 mm	17 mm	17 mm	-40 - +135 °C	Black	Polyamid	T
	193138	Pkg. 5	17 mm	22 mm	17 mm	-40 - +135 °C	Black	Polyamid	T
	193132	Pkg. 5	17 mm	7.5 mm	13 mm	-40 - +135 °C	Black	Polyamid	T
	193133	Pkg. 5	17 mm	7.5 mm	17 mm	-40 - +135 °C	Black	Polyamid	T
	193139	Pkg. 5	22 mm	10 mm	10 mm	-40 - +135 °C	Black	Polyamid	T
	193140	Pkg. 5	22 mm	10 mm	22 mm	-40 - +135 °C	Black	Polyamid	T
	193141	Pkg. 5	22 mm	13 mm	17 mm	-40 - +135 °C	Black	Polyamid	T
	193142	Pkg. 5	22 mm	13 mm	22 mm	-40 - +135 °C	Black	Polyamid	T
	193143	Pkg. 5	22 mm	17 mm	13 mm	-40 - +135 °C	Black	Polyamid	T
	193144	Pkg. 5	22 mm	22 mm	22 mm	-40 - +135 °C	Black	Polyamid	T
	193165	Pkg. 5	22 mm	7.5 mm	22 mm	-40 - +135 °C	Black	Polyamid	T
	193145	Pkg. 5	26 mm	10 mm	26 mm	-40 - +135 °C	Black	Polyamid	T
	193146	Pkg. 5	26 mm	13 mm	22 mm	-40 - +135 °C	Black	Polyamid	T
	193147	Pkg. 5	26 mm	13 mm	26 mm	-40 - +135 °C	Black	Polyamid	T
193148	Pkg. 5	26 mm	17 mm	17 mm	-40 - +135 °C	Black	Polyamid	T	
193149	Pkg. 5	26 mm	17 mm	22 mm	-40 - +135 °C	Black	Polyamid	T	
193150	Pkg. 5	26 mm	26 mm	26 mm	-40 - +135 °C	Black	Polyamid	T	

	HC-CARGO	Std pkg	Size 1	Size 2	Size 3	Temp.	Colour	Material	Type
	193163	Pkg. 5	10 mm	10 mm	10 mm	-40 - +135 °C	Black	Polyamid	Y
	193157	Pkg. 5	13 mm	7.5 mm	10 mm	-40 - +135 °C	Black	Polyamid	Y
	193158	Pkg. 5	13 mm	10 mm	10 mm	-40 - +135 °C	Black	Polyamid	Y
	193159	Pkg. 5	13 mm	10 mm	13 mm	-40 - +135 °C	Black	Polyamid	Y
	193160	Pkg. 5	13 mm	13 mm	13 mm	-40 - +135 °C	Black	Polyamid	Y
	193161	Pkg. 5	17 mm	13 mm	10 mm	-40 - +135 °C	Black	Polyamid	Y
	193154	Pkg. 5	17 mm	13 mm	17 mm	-40 - +135 °C	Black	Polyamid	Y
	193155	Pkg. 5	22 mm	10 mm	17 mm	-40 - +135 °C	Black	Polyamid	Y
	193156	Pkg. 5	22 mm	13 mm	17 mm	-40 - +135 °C	Black	Polyamid	Y
	193162	Pkg. 5	26 mm	22 mm	22 mm	-40 - +135 °C	Black	Polyamid	Y

## FLEXIBLE CONVOLUTED TUBING

	HC-CARGO	Std pkg	ID	OD	Length	ISO Norm	Colour	Material
	193121	Pkg. 50	6.6 mm	10 mm	50 m	9772 9773	Black	Nylon 66
	193122	Pkg. 50	9.8 mm	13 mm	50 m	9772 9773	Black	Nylon 66
	193123	Pkg. 50	12.2 mm	15.8 mm	50 m	9772 9773	Black	Nylon 66
	193124	Pkg. 100	17.2 mm	20 mm	100 m		Black	Polypropylene
	193125	Pkg. 100	21.2 mm	25.8 mm	100 m		Black	Polypropylene
	193126	Pkg. 50	25 mm	30 mm	50 m		Black	Polypropylene
	193127	Pkg. 50	28 mm	34 mm	50 m		Black	Polypropylene

## FLEXIBLE CONVOLUTED SPLIT TUBING

	HC-CARGO	Std pkg	HC-CARGO	Std pkg	ID	OD	Length	Colour	Material
	191944	Pkg. 25	B191944	Pkg. 300	7.4 mm	10.2 mm	25 m	Black	Polypropylene
	191945	Pkg. 25	B191945	Pkg. 200	10.7 mm	14.1 mm	25 m	Black	Polypropylene
	191946	Pkg. 25	B191946	Pkg. 200	13.2 mm	17.5 mm	25 m	Black	Polypropylene
	191947	Pkg. 10	B191947	Pkg. 100	15 mm	19.5 mm	10 m	Black	Polypropylene
	191948	Pkg. 10	B191948	Pkg. 100	19.3 mm	23.8 mm	10 m	Black	Polypropylene
	191949	Pkg. 10	B191949	Pkg. 100	22 mm	27 mm	10 m	Black	Polypropylene
	192009	Pkg. 10	B192009	Pkg. 50	25 mm	30 mm	10 m	Black	Polypropylene
	192010	Pkg. 10	B192010	Pkg. 50	28 mm	34 mm	50 m	Black	Polypropylene

## GLANDS

192355 Cable Gland

Std pkg 50



Cable dia.: 3.5 mm  
ID: 6.9 mm  
Mount. hole dia.: 12.1 mm  
Length: 41.2 mm  
Max width: 6 mm

Colour: Grey  
Protection degree: IP 68

		EL. SPECIFICATIONS	DIMENSIONS	ADDITIONAL SPECIFICATIONS
<b>192356</b>	Cable Gland	Std pkg 50		
			Cable dia.: 4 mm ID: 8 mm Mount. hole dia.: 14.3 mm Length: 45 mm Max width: 8 mm	Colour: Grey Protection degree: IP 68
<b>192357</b>	Cable Gland	Std pkg 50		
			Cable dia.: 5 mm ID: 10.5 mm Mount. hole dia.: 18.23 mm Length: 49.9 mm Max width: 10 mm	Colour: Grey Protection degree: IP 68
<b>192358</b>	Cable Gland	Std pkg 50		
			Cable dia.: 6 mm ID: 12 mm Mount. hole dia.: 19.9 mm Length: 52.4 mm Max width: 12 mm	Colour: Grey Protection degree: IP 68
<b>192359</b>	Cable Gland	Std pkg 50		
			Cable dia.: 10 mm ID: 14 mm Mount. hole dia.: 22.1 mm Length: 55.5 mm Max width: 14 mm	Colour: Grey Protection degree: IP 68
<b>192360</b>	Cable Gland	Std pkg 50		
			Cable dia.: 13 mm ID: 18.4 mm Mount. hole dia.: 27.5 mm Length: 64.5 mm Max width: 18 mm	Colour: Grey Protection degree: IP 68
<b>192479</b>	Cable Gland	Std pkg 50		
			Cable dia.: 3 mm ID: 6.9 mm Mount. hole dia.: 12 mm Length: 41.7 mm Max width: 6.5 mm	Colour: Grey Protection degree: IP 68
<b>192480</b>	Cable Gland	Std pkg 50		
			Cable dia.: 5 mm ID: 10.5 mm Mount. hole dia.: 16 mm Length: 55.8 mm Max width: 10 mm	Colour: Grey Protection degree: IP 68
<b>192481</b>	Cable Gland	Std pkg 50		
			Cable dia.: 10 mm ID: 14 mm Mount. hole dia.: 20 mm Length: 62 mm Max width: 14 mm	Colour: Grey Protection degree: IP 68

**192482 Cable Gland**

Std pkg 50

 Cable dia.: 13 mm  
 ID: 18.4 mm  
 Mount. hole dia.: 25 mm  
 Length: 66.9 mm  
 Max width: 18 mm

 Colour: Grey  
 Protection degree: IP 68

**192483 Cable Gland**

Std pkg 25

 Cable dia.: 18 mm  
 ID: 25 mm  
 Mount. hole dia.: 32 mm  
 Length: 74.9 mm  
 Max width: 25 mm

 Colour: Grey  
 Protection degree: IP 68

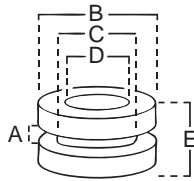
**GROMMET**

	HC-CARGO	Std pkg	A	B	C	D	E	Colour	Material
	190964	Pkg. 100	1.6 mm	11.1 mm	7.9 mm	5.6 mm	6.4 mm	Black	PVC
	190120	Pkg. 100	1.6 mm	14.2 mm	9.5 mm	6.4 mm	5 mm	Black	PVC
	190965	Pkg. 100	1.6 mm	14.2 mm	9.5 mm	8 mm	4.8 mm	Black	PVC
	190966	Pkg. 100	1.6 mm	14.2 mm	11 mm	8 mm	4.8 mm	Black	PVC
	190967	Pkg. 100	1.6 mm	16 mm	11 mm	8 mm	6.4 mm	Black	PVC
	192138	Pkg. 100	3 mm	16 mm	12.5 mm	8 mm	8 mm	Black	PVC
	190122	Pkg. 100	1.6 mm	17 mm	12.5 mm	9.5 mm	7 mm	Black	PVC
	190968	Pkg. 100	1.6 mm	19 mm	14.2 mm	11 mm	6.4 mm	Black	PVC
	190969	Pkg. 100	1.6 mm	22 mm	17.5 mm	12.5 mm	6.4 mm	Black	PVC
	190970	Pkg. 100	1.6 mm	25.5 mm	19 mm	12.5 mm	6.4 mm	Black	PVC
	192139	Pkg. 100	3 mm	30 mm	24 mm	16 mm	11 mm	Black	PVC

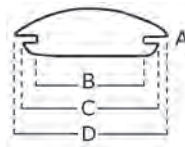
**END PLUG**

	HC-CARGO	Std pkg	A	B	C	D	Colour	Material
	190110	Pkg. 100	1.6 mm	6.4 mm	9.5 mm	9.5 mm	Black	PVC
	190111	Pkg. 100	1.6 mm	8 mm	10.6 mm	14.2 mm	Black	PVC
	190112	Pkg. 100	1.6 mm	9.5 mm	12.8 mm	15.4 mm	Black	PVC
	190114	Pkg. 100	1.6 mm	12.5 mm	15.5 mm	18.7 mm	Black	PVC
	190115	Pkg. 100	1.6 mm	15.5 mm	19 mm	22 mm	Black	PVC
	190116	Pkg. 100	1.6 mm	19 mm	22.1 mm	25.5 mm	Black	PVC
	190958	Pkg. 100	1.6 mm	22.5 mm	27 mm	28.5 mm	Black	PVC
	190959	Pkg. 100	1.6 mm	25.4 mm	28.3 mm	32 mm	Black	PVC

**POLYURETHAN WIRE SLEEVING**

	HC-CARGO	Std pkg	Voltage	ID	Length	Temp. resistant	Thermal class.	Colour
	191380	Pkg. 1	4000	1 mm	1 m	+155 °C	F	Nature
	B191380	Pkg. 200	4000	1 mm	200 m	+155 °C	F	Nature
	191383	Pkg. 1	4000	2.5 mm	1 m	+155 °C	F	Nature
	B191383	Pkg. 200	4000	2.5 mm	200 m	+155 °C	F	Nature
	B191382	Pkg. 200	4000	2 mm	200 m	+155 °C	F	Nature
	191384	Pkg. 1	4000	3 mm	1 m	+155 °C	F	Nature
	B191384	Pkg. 100	4000	3 mm	100 m	+155 °C	F	Nature
	B191385	Pkg. 100	4000	4 mm	100 m	+155 °C	F	Nature
	191387	Pkg. 1	4000	6 mm	1 m	+155 °C	F	Nature
	B191387	Pkg. 100	4000	6 mm	100 m	+155 °C	F	Nature
	B191386	Pkg. 100	4000	7 mm	100 m	+155 °C	F	Nature
	191494	Pkg. 1	4000	8 mm	1 m	+155 °C	F	Nature
	B191494	Pkg. 100	4000	8 mm	100 m	+155 °C	F	Nature

## PVC SLEEVINGS

	HC-CARGO	Std pkg	Cable dim.	Colour	Material
	190175	Pkg. 100	4 mm	Black	PVC
	191388	Pkg. 100	5 mm	Black	PVC
	190176	Pkg. 100	6 mm	Black	PVC
	190177	Pkg. 100	8 mm	Black	PVC
	190178	Pkg. 50	10 mm	Black	PVC
	190179	Pkg. 50	12 mm	Black	PVC

## SPIRAL BINDINGS

	HC-CARGO	Std pkg	Recommended loom	Length	Temp.	Colour
<i>Gives a simple and fast method of binding and protecting cable looms, whilst at the same time allowing wires to be brought from the loom.</i>						
	191881	Pkg. 50	2 mm - 10 mm	50 m	-50 - +85 °C	Black
	191882	Pkg. 25	5 mm - 40 mm	25 m	-50 - +85 °C	Black
	191883	Pkg. 25	10 mm - 50 mm	25 m	-50 - +85 °C	Black

## HEAT SHRINK TUBING

### BLACK

	HC-CARGO	Std pkg	Crimp ratio	Crimp temp.	Before crimp	After crimp	Length	Dim.	Packaging	Colour
	192513	Pkg. 1	2:1	70 °C	1.6 mm	0.8 mm	12 m	17x17x5.5 cm	Minibox	Black
	193169	Pkg. 1	2:1	90 °C	1.6 mm	0.8 mm	10 m	16x16x5 cm	Minibox	Black
	193170	Pkg. 1	2:1	90 °C	2.4 mm	1.2 mm	10 m	16x16x5 cm	Minibox	Black
	193171	Pkg. 1	2:1	90 °C	3.2 mm	1.6 mm	10 m	16x16x5 cm	Minibox	Black
	193172	Pkg. 1	2:1	90 °C	4.8 mm	2.4 mm	8 m	16x16x5 cm	Minibox	Black
	193173	Pkg. 1	2:1	90 °C	6.4 mm	3.2 mm	6 m	16x16x5 cm	Minibox	Black
	193174	Pkg. 1	2:1	90 °C	9.5 mm	4.7 mm	5 m	16x16x5 cm	Minibox	Black
	193175	Pkg. 1	2:1	90 °C	12.7 mm	6.4 mm	5 m	16x16x5 cm	Minibox	Black
	193176	Pkg. 1	2:1	90 °C	19.1 mm	9.5 mm	4 m	16x16x5 cm	Minibox	Black
	193177	Pkg. 1	2:1	90 °C	25.4 mm	12.7 mm	3 m	16x16x5 cm	Minibox	Black
	193178	Pkg. 1	2:1	90 °C	31.8 mm	15.9 mm	1 m		Plastic bag	Black
193179	Pkg. 1	2:1	90 °C	38.1 mm	19.1 mm	1 m		Plastic bag	Black	
193180	Pkg. 1	2:1	90 °C	50.8 mm	25.4 mm	1 m		Plastic bag	Black	

### RED

	HC-CARGO	Std pkg	Crimp ratio	Crimp temp.	Before crimp	After crimp	Length	Dim.	Packaging	Colour
	193181	Pkg. 1	2:1	90 °C	3.2 mm	1.6 mm	10 m	16x16x5 cm	Minibox	Red
	193182	Pkg. 1	2:1	90 °C	4.8 mm	2.4 mm	8 m	16x16x5 cm	Minibox	Red
	193183	Pkg. 1	2:1	90 °C	6.4 mm	3.2 mm	6 m	16x16x5 cm	Minibox	Red
	193184	Pkg. 1	2:1	90 °C	9.5 mm	4.7 mm	5 m	16x16x5 cm	Minibox	Red
	193185	Pkg. 1	2:1	90 °C	12.7 mm	6.4 mm	5 m	16x16x5 cm	Minibox	Red
	193186	Pkg. 1	2:1	90 °C	19.1 mm	9.5 mm	4 m	16x16x5 cm	Minibox	Red
	193187	Pkg. 1	2:1	90 °C	25.4 mm	12.7 mm	3 m	16x16x5 cm	Minibox	Red
	193188	Pkg. 1	2:1	90 °C	31.8 mm	15.9 mm	1 m		Plastic bag	Red
	193189	Pkg. 1	2:1	90 °C	38.1 mm	19.1 mm	1 m		Plastic bag	Red
	193190	Pkg. 1	2:1	90 °C	50.8 mm	25.4 mm	1 m		Plastic bag	Red

## BLACK - BLISTER PACK

	HC-CARGO	Std pkg	Crimp ratio	Crimp temp.	Before crimp	After crimp	Length	Packaging	Colour
	193003	Pkg. 1	2:1	110 °C	2.4 mm	1.2 mm	2 m	Blister pack	Black
	193004	Pkg. 1	2:1	110 °C	3.2 mm	1.6 mm	2 m	Blister pack	Black
	193005	Pkg. 1	2:1	110 °C	4.8 mm	2.4 mm	2 m	Blister pack	Black
	193006	Pkg. 1	2:1	110 °C	6.4 mm	3.2 mm	2 m	Blister pack	Black
	193007	Pkg. 1	2:1	110 °C	9.5 mm	4.8 mm	2 m	Blister pack	Black
	193008	Pkg. 1	2:1	110 °C	12.7 mm	6.4 mm	2 m	Blister pack	Black
	193009	Pkg. 1	2:1	110 °C	19 mm	9.5 mm	2 m	Blister pack	Black

## BLACK W/ GLUE

	HC-CARGO	Std pkg	Crimp ratio	Crimp temp.	Before crimp	After crimp	Length	Dim.	Packaging	Colour
	193191	Pkg. 5	3:1	100 °C	3 mm	1 mm	5x0.2 m		Plastic bag	Black
	193197	Pkg. 1	3:1	100 °C	3 mm	1 mm	5 m	16x16x5 cm	Minibox	Black
	193192	Pkg. 5	3:1	100 °C	6 mm	2 mm	5x0.2 m		Plastic bag	Black
	193198	Pkg. 1	3:1	100 °C	6 mm	2 mm	3.5 m	16x16x5 cm	Minibox	Black
	193193	Pkg. 5	3:1	100 °C	9 mm	3 mm	5x0.2 m		Plastic bag	Black
	193199	Pkg. 1	3:1	100 °C	9 mm	3 mm	3 m	16x16x5 cm	Minibox	Black
	193194	Pkg. 5	3:1	100 °C	12 mm	4 mm	5x0.2 m		Plastic bag	Black
	193200	Pkg. 1	3:1	100 °C	12 mm	4 mm	2.5 m	16x16x5 cm	Minibox	Black
	193195	Pkg. 5	3:1	100 °C	18 mm	6 mm	5x0.2 m		Plastic bag	Black
	193201	Pkg. 1	3:1	100 °C	18 mm	6 mm	2 m	16x16x5 cm	Minibox	Black
	193196	Pkg. 5	3:1	100 °C	24 mm	8 mm	5x0.2 m		Plastic bag	Black
	193202	Pkg. 1	3:1	100 °C	24 mm	8 mm	1.5 m	16x16x5 cm	Minibox	Black
	193203	Pkg. 1	3:1	100 °C	39 mm	13 mm	1 m		Plastic bag	Black
	193204	Pkg. 1	4:1	100 °C	52 mm	13 mm	1 m		Plastic bag	Black

## RED W/ GLUE

	HC-CARGO	Std pkg	Crimp ratio	Crimp temp.	Before crimp	After crimp	Length	Dim.	Packaging	Colour
	193205	Pkg. 1	3:1	100 °C	3 mm	1 mm	5 m	16x16x5 cm	Minibox	Red
	193206	Pkg. 1	3:1	100 °C	6 mm	2 mm	3.5 m	16x16x5 cm	Minibox	Red
	193207	Pkg. 1	3:1	100 °C	9 mm	3 mm	3 m	16x16x5 cm	Minibox	Red
	193208	Pkg. 1	3:1	100 °C	12 mm	4 mm	2.5 m	16x16x5 cm	Minibox	Red
	193209	Pkg. 1	3:1	100 °C	18 mm	6 mm	2 m	16x16x5 cm	Minibox	Red
	193210	Pkg. 1	3:1	100 °C	24 mm	8 mm	1.5 m	16x16x5 cm	Minibox	Red
	193211	Pkg. 1	3:1	100 °C	39 mm	13 mm	1.22 m		Plastic bag	Red

## TOOLS

### CABLE CUTTER

**211096** Cable Cutter Std pkg 1

Cutting size O.D. 50 mm<sup>2</sup>.



### CABLE STRIPPER

**210828** Cable Stripper Std pkg 1

Self-adjusting.



Cable dia.: 0.5-8 mm  
Max width: 5 mm

### CABLE TIE GUNS

**210827** Cable Tie Gun Std pkg 1

Professional, adjustable, fasten and cut ties automatically.



Cable dia.: 2.5-5 mm  
Max width: 4.8 mm

**210849** Cable Tie Gun Std pkg 1

*Professional, adjustable, fasten and cut ties automatically.*

 Cable dia.: 2.5-10 mm  
 Max width: 10 mm

**BUSHES**
**210644** Dismounting Bushes Std pkg 1 Servicing: HC-CARGO 210643

OD: 6.5 mm

**210645** Contact Insertion Sleeve Std pkg 1 Servicing: HC-CARGO 210643

 Dim.: 6.5 mm<sup>2</sup>
**CABLES**
**SINGLE CORE**
**0.5 mm<sup>2</sup>**

HC-CARGO	Voltage	Amp	Conductor dim.	OD	Temp. area	Insulator	Colour	Material	Min supply
191930	300/500	5	16/0.195 mm	2.5 mm	70 °C	Unleaded PVC	Brown	PVC	100 m
191936	300/500	5	16/0.195 mm	2.5 mm	70 °C	Unleaded PVC	Grey	PVC	100 m

**0.75 mm<sup>2</sup>**

HC-CARGO	Voltage	Amp	Conductor dim.	OD	Temp. area	Insulator	Colour	Material	Min supply
192275	100	6	24/0.19 mm	2 mm	-40 - +100 °C	ISO 6722, Class B	Red/black	PVC	100 m
192276	100	6	24/0.19 mm	2 mm	-40 - +100 °C	ISO 6722, Class B	Red/Blue	PVC	100 m
192277	100	6	24/0.19 mm	2 mm	-40 - +100 °C	ISO 6722, Class B	Red/yellow	PVC	100 m
192278	100	6	24/0.19 mm	2 mm	-40 - +100 °C	ISO 6722, Class B	Yellow/green	PVC	100 m
192279	100	6	24/0.19 mm	2 mm	-40 - +100 °C	ISO 6722, Class B	Grey/red	PVC	100 m
192280	100	6	24/0.19 mm	2 mm	-40 - +100 °C	ISO 6722, Class B	Black/white	PVC	100 m
192282	100	6	24/0.19 mm	2 mm	-40 - +100 °C	ISO 6722, Class B	Blue/green	PVC	100 m
192283	100	6	24/0.19 mm	2 mm	-40 - +100 °C	ISO 6722, Class B	Black/yellow	PVC	100 m
192284	100	6	24/0.19 mm	2 mm	-40 - +100 °C	ISO 6722, Class B	White/blue	PVC	100 m
192286	100	6	24/0.19 mm	2 mm	-40 - +100 °C	ISO 6722, Class B	White/green	PVC	100 m
192287	100	6	24/0.19 mm	2 mm	-40 - +100 °C	ISO 6722, Class B	White/yellow	PVC	100 m
192288	100	6	24/0.19 mm	2 mm	-40 - +100 °C	ISO 6722, Class B	White/red	PVC	100 m
191402	300/500	6	24/0.195 mm	2.7 mm	70 °C	Unleaded PVC	Purple	PVC	100 m
191403	300/500	10	24/0.195 mm	2.7 mm	70 °C	Unleaded PVC	Orange	PVC	100 m
193253	300/500	10	24/0.195 mm	2.7 mm	70 °C	Unleaded PVC	Brown	PVC	100 m
190674	50	10	24/0.195 mm	2.8 mm	70 °C	Unleaded PVC	Black	PVC	100 m
191395	50	10	24/0.195 mm	2.8 mm	70 °C	Unleaded PVC	Blue	PVC	100 m
191396	50	10	24/0.195 mm	2.8 mm	70 °C	Unleaded PVC	Brown	PVC	100 m
191397	50	10	24/0.195 mm	2.8 mm	70 °C	Unleaded PVC	Green	PVC	100 m
191398	50	10	24/0.195 mm	2.8 mm	70 °C	Unleaded PVC	Yellow	PVC	100 m
191399	50	10	24/0.195 mm	2.8 mm	70 °C	Unleaded PVC	White	PVC	100 m
191400	50	10	24/0.195 mm	2.8 mm	70 °C	Unleaded PVC	Red	PVC	100 m
191401	50	10	24/0.195 mm	2.8 mm	70 °C	Unleaded PVC	Grey	PVC	100 m



1 mm <sup>2</sup>									
HC-CARGO	Voltage	Amp	Conductor dim.	OD	Temp. area	Insulator	Colour	Material	Min supply
190987	50	10	32/0.195 mm	2.8 mm	70 °C	Unleaded PVC	Yellow	PVC	100 m
190988	50	10	32/0.195 mm	2.8 mm	70 °C	Unleaded PVC	Green	PVC	100 m
191090	50	10	32/0.195 mm	2.8 mm	70 °C	Unleaded PVC	Grey	PVC	100 m
191404	50	10	32/0.195 mm	2.8 mm	70 °C	Unleaded PVC	Purple	PVC	100 m
1 mm <sup>2</sup> , H05V-K									
HC-CARGO	Voltage	Amp	Conductor dim.	OD	Temp. area	Insulator	Colour	Material	Min supply
190986	300/500	14	32/0.195 mm	2.8 mm	70 °C	Unleaded PVC	Black	PVC	100 m
190989	300/500	14	32/0.195 mm	2.8 mm	70 °C	Unleaded PVC	Blue	PVC	100 m
190990	300/500	14	32/0.195 mm	2.8 mm	70 °C	Unleaded PVC	Red	PVC	100 m
190991	300/500	14	32/0.195 mm	2.8 mm	70 °C	Unleaded PVC	White	PVC	100 m
190992	300/500	14	32/0.195 mm	2.8 mm	70 °C	Unleaded PVC	Brown	PVC	100 m
1.5 mm <sup>2</sup>									
HC-CARGO	Voltage	Amp	Conductor dim.	OD	Temp. area	Insulator	Colour	Material	Min supply
192289	50	16	30/0.250 mm	2.22 mm	70 °C	Unleaded PVC	Orange	PVC	100 m
191176	100	16	27-30/0.25 mm	2.7 mm	-40 - +100 °C	ISO 6722, Class B	White/red	PVC R2G4	100 m
191177	100	16	27-30/0.25 mm	2.7 mm	-40 - +100 °C	ISO 6722, Class B	Yellow/blue	PVC R2G4	100 m
191178	100	16	27-30/0.25 mm	2.7 mm	-40 - +100 °C	ISO 6722, Class B	Brown/blue	PVC R2G4	100 m
192259	100	16	27-30/0.25 mm	2.7 mm	-40 - +100 °C	ISO 6722, Class B	Yellow/black	PVC R2G4	100 m
192260	100	16	27-30/0.25 mm	2.7 mm	-40 - +100 °C	ISO 6722, Class B	Red/Blue	PVC R2G4	100 m
192261	100	16	27-30/0.25 mm	2.7 mm	-40 - +100 °C	ISO 6722, Class B	Green/red	PVC R2G4	100 m
192262	100	16	27-30/0.25 mm	2.7 mm	-40 - +100 °C	ISO 6722, Class B	Grey/red	PVC R2G4	100 m
192263	100	16	27-30/0.25 mm	2.7 mm	-40 - +100 °C	ISO 6722, Class B	White/blue	PVC R2G4	100 m
192264	100	16	27-30/0.25 mm	2.7 mm	-40 - +100 °C	ISO 6722, Class B	Green/yellow	PVC R2G4	100 m
192265	100	16	27-30/0.25 mm	2.7 mm	-40 - +100 °C	ISO 6722, Class B	Brown/black	PVC R2G4	100 m
192267	100	16	27-30/0.25 mm	2.7 mm	-40 - +100 °C	ISO 6722, Class B	Black/red	PVC R2G4	100 m
192269	100	16	27-30/0.25 mm	2.7 mm	-40 - +100 °C	ISO 6722, Class B	Black/green	PVC R2G4	100 m
192270	100	16	27-30/0.25 mm	2.7 mm	-40 - +100 °C	ISO 6722, Class B	Black/blue	PVC R2G4	100 m
192271	100	16	27-30/0.25 mm	2.7 mm	-40 - +100 °C	ISO 6722, Class B	Black/orange	PVC R2G4	100 m
192272	100	16	27-30/0.25 mm	2.7 mm	-40 - +100 °C	ISO 6722, Class B	White/black	PVC R2G4	100 m
192273	100	16	27-30/0.25 mm	2.7 mm	-40 - +100 °C	ISO 6722, Class B	White/orange	PVC R2G4	100 m
192274	100	16	27-30/0.25 mm	2.7 mm	-40 - +100 °C	ISO 6722, Class B	White/green	PVC R2G4	100 m
193255	450/750	16	30/0.250 mm	3 mm	70 °C	Unleaded PVC	Black	PVC	100 m
190696	50	18	30/0.250 mm	3 mm	70 °C	Unleaded PVC	White	PVC	100 m
190697	50	18	30/0.250 mm	3 mm	70 °C	Unleaded PVC	Black	PVC	100 m
190698	50	18	30/0.250 mm	3 mm	70 °C	Unleaded PVC	Red	PVC	100 m
190699	50	18	30/0.250 mm	3 mm	70 °C	Unleaded PVC	Blue	PVC	100 m
190700	50	18	30/0.250 mm	3 mm	70 °C	Unleaded PVC	Yellow	PVC	100 m
190701	50	18	30/0.250 mm	3 mm	70 °C	Unleaded PVC	Grey	PVC	100 m
190702	50	18	30/0.250 mm	3 mm	70 °C	Unleaded PVC	Green	PVC	100 m
190847	50	18	30/0.250 mm	3 mm	70 °C	Unleaded PVC	Brown	PVC	100 m
2.5 mm <sup>2</sup>									
HC-CARGO	Voltage	Amp	Conductor dim.	OD	Temp. area	Insulator	Colour	Material	Min supply
190703	50	24	50/0.250 mm	3.5 mm	70 °C	Unleaded PVC	Black	PVC	50 m
190704	50	24	50/0.250 mm	3.5 mm	70 °C	Unleaded PVC	Red	PVC	50 m
190705	50	24	50/0.250 mm	3.5 mm	70 °C	Unleaded PVC	Blue	PVC	50 m
190706	50	24	50/0.250 mm	3.5 mm	70 °C	Unleaded PVC	Yellow	PVC	50 m
190910	50	24	50/0.250 mm	3.5 mm	70 °C	Unleaded PVC	Brown	PVC	50 m
190972	50	24	50/0.250 mm	3.5 mm	70 °C	Unleaded PVC	White	PVC	50 m
190707	450/750	25	50/0.250 mm	3.7 mm	70 °C	Unleaded PVC	Grey	PVC	100 m
190708	450/750	25	50/0.250 mm	3.7 mm	70 °C	Unleaded PVC	Green	PVC	100 m
193251	450/750	25	50/0.250 mm	3.7 mm	70 °C	Unleaded PVC	Black	PVC	100 m
193252	450/750	25	50/0.250 mm	3.7 mm	70 °C	Unleaded PVC	Red	PVC	100 m
4 mm <sup>2</sup>									
HC-CARGO	Voltage	Amp	Conductor dim.	OD	Temp. area	Insulator	Colour	Material	Min supply
193254	450/750	28	48/ 0.310 mm	4.3 mm	70 °C	Unleaded PVC	Black	PVC	50 m
190677	50	32	48/ 0.310 mm	4.8 mm	70 °C	Unleaded PVC	Black	PVC	50 m
190951	50	32	48/ 0.310 mm	4.8 mm	70 °C	Unleaded PVC	Red	PVC	50 m

### 6 mm<sup>2</sup>

HC-CARGO	Voltage	Amp	Conductor dim.	OD	Temp. area	Insulator	Colour	Material	Min supply
191175	450/750	36	72/0.380 mm	4.8 mm	70 °C	Unleaded PVC	Brown	PVC	100 m
190678	50	41	72/0.310 mm	6.3 mm	70 °C	Unleaded PVC	Black	PVC	50 m
191027	50	41	72/0.310 mm	6.3 mm	70 °C	Unleaded PVC	Red	PVC	50 m

### THIN WALL

#### FLRY-B 0.35 mm<sup>2</sup>

HC-CARGO	Voltage	Amp	Conductor dim.	OD	Temp. area	Insulator	Colour	Material	Min supply
193012	100	7	11-12/0.19 mm	1.6 mm	-40 - +100 °C	ISO 6722, Class B	Black	PVC	100 m
193013	100	7	11-12/0.19 mm	1.6 mm	-40 - +100 °C	ISO 6722, Class B	Red	PVC	100 m

#### FLRY-B 0.5 mm<sup>2</sup>

HC-CARGO	Voltage	Amp	Conductor dim.	OD	Temp. area	Insulator	Colour	Material	Min supply
193047	60	11	16/0.21 mm	1.6 mm	-40 - +100 °C	Unleaded PVC	Brown	PVC	100 m
193048	60	11	16/0.21 mm	1.6 mm	-40 - +100 °C	Unleaded PVC	Green	PVC	100 m
193049	60	11	16/0.21 mm	1.6 mm	-40 - +100 °C	Unleaded PVC	White	PVC	100 m
193050	60	11	16/0.21 mm	1.6 mm	-40 - +100 °C	Unleaded PVC	Grey	PVC	100 m
193051	60	11	16/0.21 mm	1.6 mm	-40 - +100 °C	Unleaded PVC	Blue	PVC	100 m
193052	60	11	16/0.21 mm	1.6 mm	-40 - +100 °C	Unleaded PVC	Yellow	PVC	100 m
193014	100	11	15-16/0.19 mm	1.6 mm	-40 - +100 °C	ISO 6722 Class B	Black	PVC	100 m
193015	100	11	15-16/0.19 mm	1.6 mm	-40 - +100 °C	ISO 6722, Class B	Red	PVC	100 m

#### FLRY-B 0.75 mm<sup>2</sup>

HC-CARGO	Voltage	Amp	Conductor dim.	OD	Temp. area	Insulator	Colour	Material	Min supply
193053	60	14	24/0.21 mm	1.9 mm	-40 - +100 °C	Unleaded PVC	Blue	PVC	100 m
193054	60	14	24/0.21 mm	1.9 mm	-40 - +100 °C	Unleaded PVC	Brown	PVC	100 m
193055	60	14	24/0.21 mm	1.9 mm	-40 - +100 °C	Unleaded PVC	Green	PVC	100 m
193056	60	14	24/0.21 mm	1.9 mm	-40 - +100 °C	Unleaded PVC	Yellow	PVC	100 m
193057	60	14	24/0.21 mm	1.9 mm	-40 - +100 °C	Unleaded PVC	White	PVC	100 m
193058	60	14	24/0.21 mm	1.9 mm	-40 - +100 °C	Unleaded PVC	Red	PVC	100 m
193059	60	14	24/0.21 mm	1.9 mm	-40 - +100 °C	Unleaded PVC	Black	PVC	100 m
193060	60	14	24/0.21 mm	1.9 mm	-40 - +100 °C	Unleaded PVC	Grey	PVC	100 m

#### FLRY-B 1 mm<sup>2</sup>

HC-CARGO	Voltage	Amp	Conductor dim.	OD	Temp. area	Insulator	Colour	Material	Min supply
193061	60	16.5	32/0.210 mm	2.1 mm	-40 - +100 °C	Unleaded PVC	Blue	PVC	100 m
193062	60	16.5	32/0.210 mm	2.1 mm	-40 - +100 °C	Unleaded PVC	Brown	PVC	100 m
193063	60	16.5	32/0.210 mm	2.1 mm	-40 - +100 °C	Unleaded PVC	Green	PVC	100 m
193064	60	16.5	32/0.210 mm	2.1 mm	-40 - +100 °C	Unleaded PVC	Yellow	PVC	100 m
193065	60	16.5	32/0.210 mm	2.1 mm	-40 - +100 °C	Unleaded PVC	White	PVC	100 m
193066	60	16.5	32/0.210 mm	2.1 mm	-40 - +100 °C	Unleaded PVC	Red	PVC	100 m
193067	60	16.5	32/0.210 mm	2.1 mm	-40 - +100 °C	Unleaded PVC	Black	PVC	100 m
193068	60	16.5	32/0.210 mm	2.1 mm	-40 - +100 °C	Unleaded PVC	Grey	PVC	100 m

#### FLRY-B 1.5 mm<sup>2</sup>

HC-CARGO	Voltage	Amp	Conductor dim.	OD	Temp. area	Insulator	Colour	Material	Min supply
193069	60	21	30/0.26 mm	2.4 mm	-40 - +100 °C	Unleaded PVC	Blue	PVC	50 m
193070	60	21	30/0.26 mm	2.4 mm	-40 - +100 °C	Unleaded PVC	Brown	PVC	50 m
193071	60	21	30/0.26 mm	2.4 mm	-40 - +100 °C	Unleaded PVC	Green	PVC	50 m
193072	60	21	30/0.26 mm	2.4 mm	-40 - +100 °C	Unleaded PVC	Yellow	PVC	50 m
193073	60	21	30/0.26 mm	2.4 mm	-40 - +100 °C	Unleaded PVC	White	PVC	50 m
193074	60	21	30/0.26 mm	2.4 mm	-40 - +100 °C	Unleaded PVC	Red	PVC	50 m
193075	60	21	30/0.26 mm	2.4 mm	-40 - +100 °C	Unleaded PVC	Grey	PVC	50 m
193076	60	21	30/0.26 mm	2.4 mm	-40 - +100 °C	Unleaded PVC	Black	PVC	50 m

#### FLRY-B 2 mm<sup>2</sup>

HC-CARGO	Voltage	Amp	Conductor dim.	OD	Temp. area	Insulator	Colour	Material	Min supply
193077	60	25	28/0.31 mm	2.8 mm	-40 - +100 °C	Unleaded PVC	Blue	PVC	50 m
193078	60	25	28/0.31 mm	2.8 mm	-40 - +100 °C	Unleaded PVC	Brown	PVC	50 m
193079	60	25	28/0.31 mm	2.8 mm	-40 - +100 °C	Unleaded PVC	Green	PVC	50 m

HC-CARGO	Voltage	Amp	Conductor dim.	OD	Temp. area	Insulator	Colour	Material	Min supply
193080	60	25	28/0.31 mm	2.8 mm	-40 - +100 °C	Unleaded PVC	Yellow	PVC	50 m
193081	60	25	28/0.31 mm	2.8 mm	-40 - +100 °C	Unleaded PVC	White	PVC	50 m
193082	60	25	28/0.31 mm	2.8 mm	-40 - +100 °C	Unleaded PVC	Red	PVC	50 m
193083	60	25	28/0.31 mm	2.8 mm	-40 - +100 °C	Unleaded PVC	Grey	PVC	50 m
193084	60	25	28/0.31 mm	2.8 mm	-40 - +100 °C	Unleaded PVC	Black	PVC	50 m

### FLRY-B 4 mm<sup>2</sup>

HC-CARGO	Voltage	Amp	Conductor dim.	OD	Temp. area	Insulator	Colour	Material	Min supply
193085	60	39	56/0.31 mm	3.7 mm	-40 - +100 °C	Unleaded PVC	Red	PVC	50 m
193086	60	39	56/0.31 mm	3.7 mm	-40 - +100 °C	Unleaded PVC	Black	PVC	50 m
193087	60	39	56/0.31 mm	3.7 mm	-40 - +100 °C	Unleaded PVC	Brown	PVC	50 m

### FLRY-B 6 mm<sup>2</sup>

HC-CARGO	Voltage	Amp	Conductor dim.	OD	Temp. area	Insulator	Colour	Material	Min supply
193088	60	50	84/0.31 mm	4.3 mm	-40 - +100 °C	Unleaded PVC	Red	PVC	50 m
193089	60	50	84/0.31 mm	4.3 mm	-40 - +100 °C	Unleaded PVC	Black	PVC	50 m
193090	60	50	84/0.31 mm	4.3 mm	-40 - +100 °C	Unleaded PVC	Brown	PVC	50 m

## DOUBLE INSULATED

### 1.5 mm<sup>2</sup>

HC-CARGO	Voltage	Amp	Conductor dim.	OD	Temp. area	Insulator	Colour	Material	Min supply
190948	50	16	30/0.250 mm	4 mm	70 °C	Unleaded PVC	Black	PVC	100 m
190954	50	16	30/0.250 mm	4 mm	70 °C	Unleaded PVC	Black	PVC	100 m

### 2.5 mm<sup>2</sup>

HC-CARGO	Voltage	Amp	Conductor dim.	OD	Temp. area	Insulator	Colour	Material	Min supply
191002	50	25	50/0.250 mm	4.2 mm	70 °C	Unleaded PVC	Black	PVC	100 m

## SINGLE CORE SILICONE

HC-CARGO	Voltage	Amp	Conductor dim.	OD	Temp. area	Insulator	Colour	Material	Min supply
191923	50	16	392/0.07 mm	2.7 mm	-50 - +180 °C	Silicone	Black	Silicone	50 m
191924	50	16	392/0.07 mm	2.8 mm	-50 - +180 °C	Silicone	Red	Silicone	50 m

## TRAILFLEX ADR

HC-CARGO	Voltage	Amp	No./core	Conductor dim.	OD	Insulator	Colour	Min supply
----------	---------	-----	----------	----------------	----	-----------	--------	------------

- TÜV Approved for ADR Applications.
- Specially developed and approved durable dual sheath construction.
- Cores insulated to a minimum of ISO 6722.
- Polyurethane sheathing ensures resistance to diesel oil, lerosene, dilute acids and alkalis.
- Excellent short-term dielectric strength (upto 3KV).

192093	50	10	2×1 mm <sup>2</sup>	27/0.210 mm	6 mm	ISO 6722	White/brown	50 m
B192093	50	10	2×1 mm <sup>2</sup>	27/0.210 mm	6 mm	ISO6722	White/brown	3000 m
192096	50	12/24	5×3x1.5+2x4 mm <sup>2</sup>	19/0.31+48/0.31 mm	12.1 mm	ISO 6722	Red/brown/black/ yellow/white	50 m
192099	50	10/16	7×6x1.5+1x2.5 mm <sup>2</sup>	30/0.250+50/0.250 mm	10.3 mm	ISO 6722	White/black/yellow/ red/green/brown/blue	50 m
192227	50	10/24	7×3x1.5+2x4+(2x1.5) mm <sup>2</sup>	19/0.31+48/0.31 mm	13.3 mm	ISO 7638	Red/brown/black/white/ white-green/white- brown	50 m
192102	50	8/12.5	15×10x1.5+ 3x2.5+1x(2x1.5) mm <sup>2</sup>	30/0.250+50/ 0.250 mm	14.4 mm	ISO 12098	White/orange/white- red/yellow/lightgreen/ blue, Black/red/pink/ grey/white-black/white- lightgreen/white-blue/ white-brown/brown	50 m

## LOUDSPEAKER

HC-CARGO	Voltage	Amp	No./core	Conductor dim.	OD	Temp. area	Colour	Min supply
191777	50	3	2×0.38 mm <sup>2</sup>	12/0.200 mm	2x4.2 mm	70 °C	Black/red	100 m
190710	50	3	2×0.38 mm <sup>2</sup>	12/0.200 mm	1.9x4.1 mm	70 °C	Blue/grey	100 m
190845	50	6	2×0.75 mm <sup>2</sup>	24/0.195 mm	2.5x5 mm	70 °C	Black/red	100 m
191087	50	6	2×0.75 mm <sup>2</sup>	24/0.195 mm	2.9x5.5 mm	70 °C	Transparent	100 m
191086	50	16	2×1.5 mm <sup>2</sup>	30/0.250 mm	3x6 mm	70 °C	Black/red	100 m
191093	50	20	2×2.5 mm <sup>2</sup>	50/0.250 mm	3.6x7.4 mm	70 °C	Black/red	100 m

## MULTI CORE SILICONE

### 2×0.75 mm<sup>2</sup>

HC-CARGO	Voltage	Amp	No./core	Conductor dim.	OD	Temp. area	Insulator	Colour	Min supply
191927	500	6	2×0.75 mm <sup>2</sup>	24/0.195 mm	6.4 mm	-60 - +180 °C	Silicone	Blue/brown	100 m

### 2×1.5 mm<sup>2</sup>

HC-CARGO	Voltage	Amp	No./core	Conductor dim.	OD	Temp. area	Insulator	Colour	Min supply
191928	500	16	2×1.5 mm <sup>2</sup>	30/0.250 mm	7.6 mm	-60 - +180 °C	Silicone	Blue/brown	100 m

## MULTI CORE

### WHITE COVER

HC-CARGO	Voltage	Amp	No./core	Conductor dim.	OD	Temp. area	Insulator	Colour	Min supply
190685	300/300	6	2×0.75 mm <sup>2</sup>	24/0.195 mm	6.4 mm	70 °C	Unleaded PVC	Blue/brown	100 m
190675	450/750	6	2×0.75 mm <sup>2</sup>	24/0.195 mm	5.4 mm	60 °C	Unleaded PVC	Blue/brown	100 m
192820	300/500	16	3g×1.5 mm <sup>2</sup>	25/0.260 mm	9.4 mm	70 °C	Unleaded PVC	Blue/brown/ yellow-green	50 m

### GREY COVER

HC-CARGO	Voltage	Amp	No./core	Conductor dim.	OD	Temp. area	Insulator	Colour	Min supply
191620	50	9	2×0.75 mm <sup>2</sup>	24/0.200 mm	8.7 mm	-5 - +50 °C	Unleaded PVC	White/brown	100 m
191621	50	9	4×0.75 mm <sup>2</sup>	24/0.200 mm	10.4 mm	-5 - +50 °C	Unleaded PVC	White/brown/ green/yellow	100 m
191623	50	12	12×1 mm <sup>2</sup>	32/0.210 mm	12 mm	-5 - +70 °C	Unleaded PVC		100 m

### BLACK COVER

HC-CARGO	Voltage	Amp	No./core	Conductor dim.	OD	Insulator	Colour	Min supply
190979	50	3.9	7×0.75 mm <sup>2</sup>	24/0.195 mm	9.2 mm	Unleaded PVC	Blue/brown/black/ yellow/green	50 m
191419	50	4.5	5×0.75 mm <sup>2</sup>	24/0.195 mm	8.1 mm	Unleaded PVC	Blue/brown/black/ yellow/green	50 m
191418	50	4.5	6×0.75 mm <sup>2</sup>	24/0.195 mm	7.5 mm	Unleaded PVC	Blue/brown/black/ yellow/white/red	50 m
190690	300/500	6	2×0.75 mm <sup>2</sup>	20/0.210 mm	6 mm	IEC 60332-1	Blue/brown	100 m
190676	50	6	2×0.75 mm <sup>2</sup>	24/0.195 mm	4.4×6.8 mm	Unleaded PVC	Blue/brown	50 m
190686	50	6	2×0.75 mm <sup>2</sup>	24/0.195 mm	6 mm	Unleaded PVC	Blue/brown	50 m
190687	50	6	3×0.75 mm <sup>2</sup>	24/0.195 mm	6.7 mm	Unleaded PVC	Blue/brown/black	50 m
191135	50	6	4×0.75 mm <sup>2</sup>	24/0.195 mm	7.4 mm	Unleaded PVC	Blue/brown/black/yellow	50 m
190993	50	6.5	7×1 mm <sup>2</sup>	32/0.195 mm	9.3 mm	Unleaded PVC	Blue/brown/black/ yellow/green	50 m
190981	50	7.5	5×1 mm <sup>2</sup>	32/0.195 mm	8.6 mm	Unleaded PVC	Blue/brown/black/ yellow/green	50 m
190711	50	7.5/18.7	7×6x1+1x2.5 mm <sup>2</sup>	32/0.195+50/0.250 mm	10.5 mm	Unleaded PVC	Blue/brown/black/ yellow/green	50 m
192104	50	8/12.5	13×9x1.5+4x2.5 mm <sup>2</sup>	30/0.250+50/0.250 mm	16.6 mm	Unleaded PVC	Blue/brown/black/ yellow/green/red/ white/grey/purple/ pink/orange/turquoise	50 m
191095	50	8/12.5/7	13×10x1.5+3x2.5 mm <sup>2</sup>	30/0.250+50/0.250 mm	16 mm	Unleaded PVC	Blue/brown/black/ yellow/green/red/white/ grey/violet/pink/orange/ turquoise/transparent	50 m
191058	50	8.8	12×1.5 mm <sup>2</sup>	30/0.250 mm	16.4 mm	Unleaded PVC	Blue/brown/black/yellow/ green/red/white/grey/ violet/pink/orange/turquoise	50 m
191617	300/500	10	2×1 mm <sup>2</sup>	26/0.210 mm	7.2 mm	Unleaded PVC	Blue/brown	100 m
192789	50	10	2×1 mm <sup>2</sup>	32/0.195 mm	4×6.4 mm	Unleaded PVC	White/black	50 m
191817	50	10	2×1 mm <sup>2</sup>	32/0.195 mm	6.4 mm	Unleaded PVC	Blue/brown	50 m
190689	50	10	3×1 mm <sup>2</sup>	32/0.195 mm	6.8 mm	Unleaded PVC	Blue/brown/black	50 m
190950	50	10	4×1 mm <sup>2</sup>	32/0.195 mm	7.6 mm	Unleaded PVC	Blue/brown/black/yellow	50 m
191043	50	10/16	7×6x1.5+1x2.5 mm <sup>2</sup>	30/0.250+50/0.250 mm	11.1 mm	Unleaded PVC	Blue/brown/black/ yellow/green	50 m
190691	450/750	12	2×1 mm <sup>2</sup>	26/0.210 mm	9 mm	IEC 60332-1	Blue/brown	100 m
190666	50	12	5×1.5 mm <sup>2</sup>	30/0.250 mm	9.3 mm	Unleaded PVC	Blue/brown/black/ yellow/green	50 m

HC-CARGO	Voltage	Amp	No./core	Conductor dim.	OD	Insulator	Colour	Min supply
190709	50	16	2×1.5 mm <sup>2</sup>	30/0.250 mm	4.6×7.6 mm	Unleaded PVC	Blue/brown	50 m
190688	50	16	2×1.5 mm <sup>2</sup>	30/0.250 mm	6.7 mm	Unleaded PVC	Blue/brown	50 m
191618	300/500	16	2×1.5 mm <sup>2</sup>	25/0.260 mm	7 mm	Unleaded PVC	Blue/brown	100 m
190693	450/750	16	2×1.5 mm <sup>2</sup>	25/0.260 mm	10 mm	IEC 60332-1	Blue/brown	100 m
191130	50	16	3×1.5 mm <sup>2</sup>	30/0.250 mm	7.6 mm	Unleaded PVC	Blue/brown/black	50 m
192555	300/500	16	3×1.5 mm <sup>2</sup>	25/0.260 mm	8.9 mm	Unleaded PVC	Blue/brown/yellow-green	50 m
191131	450/750	16	3×1.5 mm <sup>2</sup>	25/0.260 mm	10 mm	IEC 60332-1	Blue/brown/yellow-green	100 m
191136	50	16	4×1.5 mm <sup>2</sup>	30/0.250 mm	8.6 mm	Unleaded PVC	Blue/brown/black/yellow	50 m
191619	300/500	16	4×1.5 mm <sup>2</sup>	25/0.260 mm	9.1-10.5 mm	Unleaded PVC	Blue/brown/black/ yellow-green	50 m
191062	450/750	16	4×1.5 mm <sup>2</sup>	25/0.260 mm	11 mm	IEC 60332-1	Blue/brown/black/ yellow-green	100 m
190667	50	16	7×1.5 mm <sup>2</sup>	30/0.250 mm	10.5 mm	Unleaded PVC	Blue/brown/black/ yellow/green	50 m
192103	450/750	20	5×2.5 mm <sup>2</sup>	25/0.260 mm	13.7 mm	IEC 60332-1	Blue/brown/black/ black/yellow-green	50 m
191160	50	20	2×2.5 mm <sup>2</sup>	50/0.250 mm	5.3×8.8 mm	Unleaded PVC	Blue/brown	50 m
192951	50	20	2×2.5 mm <sup>2</sup>	50/0.250 mm	8.6 mm	Unleaded PVC	Blue/brown	50 m

## WELDING

### RED PVC COVER

HC-CARGO	Min supply	HC-CARGO	Min supply	Voltage	Amp	No./core	Conductor dim.	OD	Temp. area
191535	25 m			200	106	1×10 mm <sup>2</sup>	304/0.2 mm	7.3 mm	-5 - +85 °C
191574	25 m	B191574	100 m	200	135	1×16 mm <sup>2</sup>	462/0.2 mm	8.7 mm	-5 - +85 °C
191451	25 m	B191451	100 m	200	170	1×25 mm <sup>2</sup>	742/0.2 mm	10.5 mm	-5 - +85 °C
191452	25 m	B191452	100 m	200	217	1×35 mm <sup>2</sup>	1008/0.2 mm	12 mm	-5 - +85 °C
191453	25 m	B191453	50 m	200	280	1×50 mm <sup>2</sup>	1482/0.2 mm	13.8 mm	-5 - +85 °C
192446	10 m	B192446	50 m	200	350	1×70 mm <sup>2</sup>	2090/0.2 mm	15.9 mm	-5 - +85 °C

### ORANGE PVC/NBR COVER

HC-CARGO	Min supply	HC-CARGO	Min supply	Voltage	Amp	No./core	Conductor dim.	OD	Temp. area	Insulator
191522	25 m			450/750	195	1×25 mm <sup>2</sup>	742/0.2 mm	10.8 mm	-5 - +90 °C	Dual
191523	25 m	B191523	100 m	450/750	245	1×35 mm <sup>2</sup>	1050/0.2 mm	12 mm	-5 - +90 °C	Dual
191524	25 m			450/750	310	1×50 mm <sup>2</sup>	1482/0.2 mm	14.2 mm	-5 - +90 °C	Dual
192445	10 m			450/750	385	1×70 mm <sup>2</sup>	2090/0.2 mm	16.7 mm	-5 - +90 °C	Dual

### BLACK PVC COVER

HC-CARGO	Min supply	HC-CARGO	Min supply	Voltage	Amp	No./core	Conductor dim.	OD	Temp. area
191445	25 m			200	106	1×10 mm <sup>2</sup>	312/0.2 mm	7.3 mm	-5 - +85 °C
191446	25 m	B191446	100 m	200	124	1×16 mm <sup>2</sup>	462/0.2 mm	8.7 mm	-5 - +85 °C
191447	25 m	B191447	100 m	200	170	1×25 mm <sup>2</sup>	742/0.2 mm	10.5 mm	-5 - +85 °C
191448	25 m	B191448	100 m	200	217	1×35 mm <sup>2</sup>	1008/0.2 mm	10.5 mm	-5 - +85 °C
191449	25 m	B191449	50 m	200	280	1×50 mm <sup>2</sup>	1482/0.2 mm	13.8 mm	-5 - +85 °C
191450	10 m	B191450	50 m	200	346	1×70 mm <sup>2</sup>	2090/0.2 mm	15.9 mm	-5 - +85 °C
192881	10 m	B192881	50 m	200	387	1×95 mm <sup>2</sup>	2812/0.20 mm	18.2 mm	-5 - +85 °C

### BLACK PVC/NBR COVER

HC-CARGO	Voltage	Amp	No./core	Conductor dim.	OD	Temp. area	Insulator	Min supply
191516	450/750	115	1×10 mm <sup>2</sup>	304/0.2 mm	7.4 mm	-5 - +90 °C	Dual	25 m
191517	450/750	145	1×16 mm <sup>2</sup>	490/0.2 mm	8.6 mm	-5 - +90 °C	Dual	25 m
191518	450/750	195	1×25 mm <sup>2</sup>	742/0.2 mm	10.8 mm	-5 - +90 °C	Dual	25 m
191519	450/750	245	1×35 mm <sup>2</sup>	1050/0.2 mm	12 mm	-5 - +90 °C	Dual	25 m
191520	450/750	310	1×50 mm <sup>2</sup>	1482/0.2 mm	14.2 mm	-5 - +90 °C	Dual	25 m
191521	450/750	385	1×70 mm <sup>2</sup>	2090/0.2 mm	16.7 mm	-5 - +90 °C	Dual	10 m
192882	450/750	430	95 mm <sup>2</sup>	2812/0.20 mm	18.8 mm	-5 - +90 °C	Dual	10 m

## STARTER

### RED PVC COVER

HC-CARGO	Min supply	HC-CARGO	Min supply	Voltage	Amp	No./core	Conductor dim.	OD	Temp. area
192291	25 m	B192291	100 m	450/750	135	1×35 mm <sup>2</sup>	420/0.32 mm	10 mm	-25 - +70 °C
192292	25 m	B192292	50 m	450/750	160	1×50 mm <sup>2</sup>	588/0.32 mm	12 mm	-25 - +70 °C

## BLACK PVC COVER

HC-CARGO	Min supply	HC-CARGO	Min supply	Voltage	Amp	No./core	Conductor dim.	OD	Temp. area
191132	25 m	B191132	100 m	450/750	63	1×10 mm <sup>2</sup>	120/0.32 mm	6.5 mm	-25 - +70 °C
190680	25 m	B190680	100 m	450/750	82	1×16 mm <sup>2</sup>	196/0.32 mm	7.5 mm	-25 - +70 °C
190681	25 m	B190681	100 m	200	110	1×25 mm <sup>2</sup>	294/0.31 mm	10.5 mm	70 °C
190682	25 m	B190682	100 m	450/750	135	1×35 mm <sup>2</sup>	420/0.32 mm	10 mm	-25 - +70 °C
190683	25 m	B190683	50 m	450/750	160	1×50 mm <sup>2</sup>	588/0.32 mm	12 mm	-25 - +70 °C
190684	10 m	B190684	50 m	450/750	205	1×70 mm <sup>2</sup>	840/0.32 mm	14.5 mm	-25 - +70 °C

## PARALLEL TWIN BATTERY

HC-CARGO	Min supply	HC-CARGO	Min supply	Voltage	Amp	No./core	Conductor dim.	OD	Temp. area
191793	25 m			500	28	2×4 mm <sup>2</sup>	114/0.2 mm	6x13 mm	-5 - +70 °C
191794	25 m			500	36	2×6 mm <sup>2</sup>	172/0.2 mm	6.5x14 mm	-5 - +70 °C
191795	25 m			500	63	2×10 mm <sup>2</sup>	296/0.2 mm	8x17 mm	-5 - +70 °C
191796	25 m			500	135	2×16 mm <sup>2</sup>	462/0.2 mm	9x19 mm	-5 - +70 °C
191525	10 m			B191525	100 m	500	230	2×25 mm <sup>2</sup>	722/0.21 mm
191526	10 m	B191526	50 m	500	290	2×35 mm <sup>2</sup>	1026/0.2 mm	12.5x26 mm	-5 - +70 °C
191527	10 m			500	370	2×50 mm <sup>2</sup>	1482/0.2 mm	14.5x30 mm	-5 - +70 °C

## DISPLAY

06219 Cable/Shrink Pipe Display Std pkg 1

Contains maks. 8 boxes. Can be placed on the counter or mounted on wall.



## BOOSTER

### STEEL CLIPS

192206 Booster cable set Std pkg 1



Amp: 80

Conductor dim.:  
79/0.4 mm  
Conductor dim. 1:  
10 mm<sup>2</sup>  
Length: 2.5 m

Colour: Red/black  
Material: Galvanized steel  
No./wires: 2

192207 Booster cable set Std pkg 1



Amp: 100

Conductor dim.:  
126/0.4 mm  
Conductor dim. 1:  
16 mm<sup>2</sup>  
Length: 2.5 m

Colour: Red/black  
Material: Galvanized steel  
No./wires: 2







192208 Booster cable set Std pkg 1



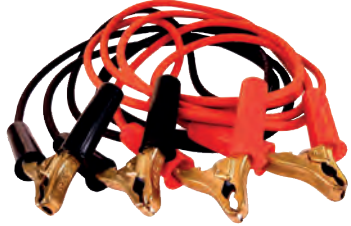



Amp: 120

Conductor dim.:  
188/0.4 mm  
Conductor dim. 1:  
25 mm<sup>2</sup>  
Length: 2.5 m



Colour: Red/black  
Material: Galvanized steel  
No./wires: 2

BRASS CHARGING CLIPS			
192209 Booster cable set Std pkg 1			
	Amp: 230	Conductor dim.: 770/0.2 mm Conductor dim. 1: 25 mm <sup>2</sup> Length: 3.5 m	Colour: Red/black Material: Moulded brass No./wires: 2 BS-approved: BS638
192210 Booster cable set Std pkg 1			
	Amp: 290	Conductor dim.: 1083/0.2 mm Conductor dim. 1: 35 mm <sup>2</sup> Length: 3.5 m	Colour: Red/black Material: Moulded brass No./wires: 2 BS-approved: BS638
192211 Booster cable set Std pkg 1			
	Amp: 370	Conductor dim.: 1558/0.2 mm Conductor dim. 1: 50 mm <sup>2</sup> Length: 3.5 m	Colour: Red/black Material: Moulded brass No./wires: 2 BS-approved: BS638
192212 Booster cable set Std pkg 1			
	Amp: 370	Conductor dim.: 1558/0.2 mm Conductor dim. 1: 50 mm <sup>2</sup> Length: 5 m	Colour: Red/black Material: Moulded brass No./wires: 2 BS-approved: BS638
192295 Booster cable set Std pkg 1			
	Amp: 135	Conductor dim.: 265/0.41 mm Conductor dim. 1: 35 mm <sup>2</sup> Length: 3.5 m	Colour: Red/black Material: Moulded brass No./wires: 2
192296 Booster cable set Std pkg 1			
	Amp: 160	Conductor dim.: 378/0.41 mm Conductor dim. 1: 50 mm <sup>2</sup> Length: 5 m	Colour: Red/black Material: Moulded brass No./wires: 2
192844 Booster cable set Std pkg 1			
	Amp: 290	Conductor dim.: 1008/0.2 mm Conductor dim. 1: 35 mm <sup>2</sup> Length: 5 m	Colour: Red/black Material: Moulded brass No./wires: 2 BS-approved: BS638

**FULLY INSULATED CLIPS**

192213 Booster cable set		Std pkg 1			
	Amp: 290	Conductor dim.: 1083/0.2 mm Conductor dim. 1: 35 mm <sup>2</sup> Length: 3.5 m	Colour: Red/black No./wires: 2 Insulator: Yes Braided link: w/ BS-approved: BS638 Alternativ no.: 192384		
192214 Booster cable set		Std pkg 1			
	Amp: 370	Conductor dim.: 1558/0.2 mm Conductor dim. 1: 50 mm <sup>2</sup> Length: 3.5 m	Colour: Red/black Material: Compressed steel No./wires: 2 Insulator: Yes Braided link: w/ BS-approved: BS638		
192215 Booster cable set		Std pkg 1			
	Amp: 370	Conductor dim.: 1558/0.2 mm Conductor dim. 1: 50 mm <sup>2</sup> Length: 5 m	Colour: Red/black Material: Compressed steel No./wires: 2 Insulator: Yes Braided link: w/ BS-approved: BS638 Alternativ no.: 192385		
192384 Booster cable set		Std pkg 1			
	Amp: 290	Conductor dim.: 1083/0.2 mm Conductor dim. 1: 35 mm <sup>2</sup> Length: 3.5 m	Colour: Red/black Material: Copper/Brass No./wires: 2 Insulator: Yes Braided link: w/ DIN no.: 72553 Alternativ no.: 192213		
192385 Booster cable set		Std pkg 1			
	Amp: 370	Conductor dim.: 1558/0.2 mm Conductor dim. 1: 50 mm <sup>2</sup> Length: 5 m	Colour: Red/black Material: Copper/Brass No./wires: 2 Insulator: Yes Braided link: w/ DIN no.: 72553 Alternativ no.: 192215		

**CHARGING CLIPS**





192196 Charging Clips		Std pkg 1			
	Amp: 275	Cable dim.: 16 mm <sup>2</sup>	Colour: Red Material: Moulded brass		
192197 Charging Clips		Std pkg 1			
	Amp: 275	Cable dim.: 16 mm <sup>2</sup>	Colour: Black Material: Moulded brass		



		EL. SPECIFICATIONS	DIMENSIONS	ADDITIONAL SPECIFICATIONS
<b>192293</b> Charging Clips      Std pkg 1 <i>Lenght: 210 mm.</i>		Amp: 420	Cable dim.: 35-50 mm <sup>2</sup>	Colour: Red Material: PP/PVC
				
<b>192294</b> Charging Clips      Std pkg 1 <i>Lenght: 210 mm.</i>		Amp: 420	Cable dim.: 35-50 mm <sup>2</sup>	Colour: Black Material: PP/PVC
				
<b>192386</b> Charging Clips      Std pkg 1		Amp: 275	Cable dim.: 16 mm <sup>2</sup>	Colour: Red Material: Moulded brass
				
<b>192387</b> Charging Clips      Std pkg 1		Amp: 275	Cable dim.: 16 mm <sup>2</sup>	Colour: Black Material: Moulded brass
				
<b>192388</b> Charging Clips      Std pkg 1		Amp: 320	Cable dim.: 25 mm <sup>2</sup>	Colour: Red Material: Moulded brass
				
<b>192389</b> Charging Clips      Std pkg 1		Amp: 320	Cable dim.: 25 mm <sup>2</sup>	Colour: Black Material: Moulded brass
				
<b>192390</b> Charging Clips      Std pkg 1		Amp: 420	Cable dim.: 50 mm <sup>2</sup>	Colour: Red Material: Moulded brass
				

		EL. SPECIFICATIONS	DIMENSIONS	ADDITIONAL SPECIFICATIONS
<b>192391</b> Charging Clips	Std pkg 1	Amp: 420	Cable dim.: 50 mm <sup>2</sup>	Colour: Black Material: Moulded brass
				
<b>192903</b> Charging clips, red	Std pkg 1	Amp: 1200	Cable dim.: 25-50 mm <sup>2</sup>	Colour: Red Material: Brass
				
<b>192904</b> Charging clips	Std pkg 1	Amp: 1200	Cable dim.: 25-50 mm <sup>2</sup>	Colour: Black Material: Brass
				
<b>FULLY INSULATED</b>				
<b>192204</b> Charging clips	Std pkg 1	Amp: 600	Cable dim.: 25-50 mm <sup>2</sup>	Colour: Red Material: Compressed steel Fully insulated: Yes Braided link: w/ Alternativ no.: 192398
				
<b>192205</b> Charging clips	Std pkg 1	Amp: 600	Cable dim.: 25-50 mm <sup>2</sup>	Colour: Black Material: Compressed steel Fully insulated: Yes Braided link: w/ Alternativ no.: 192399
				
<b>192398</b> Charging Clips	Std pkg 1	Amp: 600	Cable dim.: 50 mm <sup>2</sup>	Colour: Red Material: Copper/Brass Fully insulated: Yes Braided link: w/ Alternativ no.: 192204
				
<b>192399</b> Charging Clips	Std pkg 1	Amp: 600	Cable dim.: 50 mm <sup>2</sup>	Colour: Black Material: Copper/Brass Fully insulated: Yes Braided link: w/ Alternativ no.: 192205
				
<b>192559</b> Charging Clips	Std pkg 1	Amp: 500	Cable dim.: 25-50 mm <sup>2</sup>	Colour: Red Material: Moulded brass Fully insulated: Yes
<i>Ergonomic.</i> 				

		EL. SPECIFICATIONS	DIMENSIONS	ADDITIONAL SPECIFICATIONS
<b>192560</b> Charging Clips Std pkg 1				
<i>Ergonomic.</i>				
		Amp: 500	Cable dim.: 25-50 mm <sup>2</sup>	Colour: Black Material: Moulded brass Fully insulated: Yes
<b>ALLIGATOR AND UNIVERSAL CLIPS</b>				
<b>ALLIGATOR</b>				
<b>192190</b> Alligator Clip Std pkg 25				
		Amp: 5	Jaw opening: 11 Length: 50 mm	
<b>192191</b> Alligator Clip Std pkg 10				
		Amp: 40	Jaw opening: 14 Length: 75 mm	Type: Positive Colour: Red
<b>192192</b> Alligator Clip Std pkg 10				
		Amp: 40	Jaw opening: 14 Length: 75 mm	Type: Negative Colour: Black
<b>192659</b> Alligator Clip Std pkg 1				
		Amp: 10	Jaw opening: 11 Length: 80 mm	Type: Positive Colour: Red
<b>192660</b> Alligator Clip Std pkg 1				
		Amp: 10	Jaw opening: 11 Length: 80 mm	Type: Negative Colour: Black
<b>UNIVERSAL</b>				
<b>192700</b> Universal Clips Std pkg 5				
		Amp: 25	Jaw opening: 19 Length: 70 mm	Type: Positive Alternativ no.: 193239

		EL. SPECIFICATIONS	DIMENSIONS	ADDITIONAL SPECIFICATIONS
<b>192701</b> Universal Clips	Std pkg 5	 Amp: 25	Jaw opening: 19 Length: 70 mm	Type: Negative Alternativ no.: 193240
<b>192702</b> Universal Clips	Std pkg 5			
 Amp: 50	Jaw opening: 25 Length: 100 mm	Type: Positive		
			<b>192703</b> Universal Clips	Std pkg 5
 Amp: 50	Jaw opening: 25 Length: 100 mm	Type: Negative		
			<b>193239</b> Universal Clips	Std pkg 1
 Amp: 25	Jaw opening: 12 Length: 75 mm	Type: Positive Alternativ no.: 192700		
			<b>193240</b> Universal Clips	Std pkg 1
 Amp: 25	Jaw opening: 12 Length: 75 mm	Type: Negative Alternativ no.: 192701		

## CABLE COILS

### BATTERY

	HC-CARGO	Std pkg	Lead dim.	Windings	Material	Colour	OD	Working length
	<b>191201</b>	Pkg. 1	25 mm <sup>2</sup>	35	Polyurethan	Black	13.5 mm	3.5 m
	<b>192724</b>	Pkg. 1	35 mm <sup>2</sup>	35	Polyurethan	Red	13.5 mm	3.5 m
	<b>192723</b>	Pkg. 1	35 mm <sup>2</sup>	35	Polyurethan	Black	13.5 mm	3.5 m
	<b>191238</b>	Pkg. 1	25 mm <sup>2</sup>	35	Polyurethan	Red	13.5 mm	3.5 m
	<b>192722</b>	Pkg. 1	2x35 mm <sup>2</sup>	35	Polyurethan	Red/black	13.5 mm	3.5 m

### ELECTRICAL

	HC-CARGO	Std pkg	Lead dim.	Windings	Material	DIN Norm	ISO Norm	Plug type	Working length
	<b>191179</b>	Pkg. 1	2x4/3x1.5 mm <sup>2</sup>	48	Polyurethan	74001	4141	5-core	4 m
	<b>192582</b>	Pkg. 1	4x0.75 mm <sup>2</sup>	68	Polyurethan	72575		4-core	5.5 m
	<b>192583</b>	Pkg. 1	5x0.75 mm <sup>2</sup>	68	Polyurethan		7638	5-core	5.5 m
	<b>191013</b>	Pkg. 1	6x1+1x2 mm <sup>2</sup>	20	Nylon	72551	4141	7-core	3.5 m
	<b>191088</b>	Pkg. 1	6x1+1x2 mm <sup>2</sup>	42	Polyurethan		4141	7-core	3.5 m
	<b>191495</b>	Pkg. 1	6x1+1x2 mm <sup>2</sup>	63	Polyurethan			7-core	5 m
	<b>191195</b>	Pkg. 1	12x1.5+3x2.5 mm <sup>2</sup>	34	Polyurethan		12098	15-core	3.5 m

**IGNITION**
**150401** Protection Cap      Std pkg 10

For spark plug cap. Angled.

 Cable dia. 1: 7.5 mm  
 Cable dia. 2: 15  
 Length: 41 mm

 Colour: Black  
 Material: PVC

**190695** Ignition Cable      Std pkg 50

 Conductor dim. 1:  
 19/0.3 mm  
 Conductor dim. 2:  
 1.5 mm<sup>2</sup>  
 OD: 7 mm  
 Rolls size: 50 m

 Type: Ignition cable  
 Cap colour: Black  
 Cap material: PVC

**CABLE EYELETS**
**191805** Cable Eyelet      Std pkg 100

 ID: 4.3 mm  
 OD: 7.2 mm  
 Height: 3.6 mm

Material: Brass

**192658** Cable Eyelet      Std pkg 100

 ID: 5 mm  
 OD: 8 mm  
 Height: 3.6 mm

Material: Brass

**HOSES**
**WOVEN**

	HC-CARGO	Std pkg	ID	Length	Box dim.	Pressure	
	<b>191499</b>	Pkg. 20	3.2 mm	20 m	28.5x29.5x11.5	5 bar	Also for unleaded petrol.
	<b>190994</b>	Pkg. 20	3.5 mm	20 m	28.5x29.5x11.5	5 bar	Also for unleaded petrol.
	<b>191014</b>	Pkg. 20	4.5 mm	20 m	28.5x29.5x11.5	5 bar	Also for unleaded petrol.
	<b>190995</b>	Pkg. 20	5 mm	20 m	28.5x29.5x11.5	5 bar	Also for unleaded petrol.
	<b>190996</b>	Pkg. 20	6 mm	20 m	28.5x29.5x11.5	5 bar	Also for unleaded petrol.
	<b>190997</b>	Pkg. 20	7.5 mm	20 m	28.5x29.5x11.5	5 bar	Also for unleaded petrol.
	<b>191015</b>	Pkg. 20	9 mm	20 m	28.5x29.5x11.5	5 bar	Also for unleaded petrol.
	<b>192361</b>	Pkg. 10	11 mm	10 m	28.5x29.5x11.5	5 bar	Also for unleaded petrol.

**NON-WOVEN**

	HC-CARGO	Std pkg	ID	Length	Box dim.	Pressure	DIN Norm	
	<b>191182</b>	Pkg. 20	3.5 mm	20 m	28.5x29.5x11.5	10 bar	73379	Also for unleaded petrol.
	<b>191063</b>	Pkg. 20	5.5 mm	20 m	28.5x29.5x11.5	10 bar	73379	Also for unleaded petrol.
	<b>190998</b>	Pkg. 20	5 mm	20 m	28.5x29.5x11.5	10 bar	73379	Also for unleaded petrol.
	<b>190999</b>	Pkg. 20	6 mm	20 m	28.5x29.5x11.5	10 bar	73379	Also for unleaded petrol.
	<b>191000</b>	Pkg. 20	7.5 mm	20 m	28.5x29.5x11.5	10 bar	73379	Also for unleaded petrol.
	<b>190984</b>	Pkg. 20	9.5 mm	20 m	28.5x29.5x11.5	10 bar	73379	Also for unleaded petrol.

**PLASTIC**

	HC-CARGO	Std pkg	ID	OD	Length	Pressure	Temp.	Hose type
	<b>190093</b>	Pkg. 50	3 mm	4.5 mm	10 m		-15°C - +60°C	Washer
	<b>190094</b>	Pkg. 50	4 mm	5.5 mm	50 m		-15°C - +60°C	Washer
	<b>190095</b>	Pkg. 50	5 mm	7.3 mm	50 m		-15°C - +60°C	Washer
	<b>190096</b>	Pkg. 50	6 mm	9.8 mm	50 m		-15°C - +60°C	Washer
	<b>090170</b>	Pkg. 10	6 mm	10 mm	10 m	2.8-3.5 bar		Fuel
	<b>190097</b>	Pkg. 50	8 mm	11.6 mm	50 m		-15°C - +60°C	Washer
	<b>090171</b>	Pkg. 10	8 mm	12 mm	10 m	2.8-3.5 bar		Fuel

## ARMoured PLASTIC

**190100** Armoured PA hose Std pkg 50

*Petrol and fuel resistant.*



ID: 6 mm  
Length: 50 m  
Temp.: -5°C - +60°C.  
Working pressure at °C:  
25 kg./cm<sup>2</sup>

Hose type: Armoured  
Colour: Transparent  
Material: PVC

**190101** Armoured hose Std pkg 50

*Petrol and fuel resistant.*



ID: 8 mm  
Length: 50 m  
Temp.: -5°C - +60°C.  
Working pressure at °C:  
20 kg./cm<sup>2</sup>

Hose type: Armoured  
Colour: Transparent  
Material: PVC

## OVERFLOW

**090293** Over flow hose high temperatur Std pkg 20 Servicing: Among others Mercedes - Visit [www.hc-cargo.com](http://www.hc-cargo.com) for further information.

*Specially designed for Mercedes where the nozzle is stored in the valve cover. Tolerates higher temperatures.*



ID: 3 mm  
OD: 7 mm  
Length: 20 m  
Temp.: 110  
Pressure: 10 bar  
Working pressure at °C:  
5 kg./cm<sup>2</sup>

Colour: Grey/red  
Woven: Yes

## HEATER

**192720** Heater Hose Std pkg 10

*Black EPDM rubber. Temperature resistant between -25°C-+100°C.*



Box dim.:  
28.5x29.5x11.5 cm  
ID: 16 mm  
Length: 10 m  
Temp.: -25°C - +100°C.  
Pressure: 10 bar

Hose type: Water  
Colour: Black

## SYNTHETIC RUBBER STEEL WIRE

	HC-CARGO	Std pkg	ID	OD	Length	Pressure	DIN Norm	Temp.
<i>Braiding of galvanized steel wire.</i>								
	<b>090078</b>	Pkg. 10	4.5 mm	9.5 mm	10 m	20 bar	73379	-35°C - +80°C
	<b>090079</b>	Pkg. 10	5.5 mm	10.5 mm	10 m	20 bar	73379	-35°C - +80°C
	<b>B090079</b>	Pkg. 50	5.5 mm	10.5 mm	50 m	20 bar	73379	-35°C - +80°C
	<b>090080</b>	Pkg. 10	7.5 mm	12.5 mm	10 m	20 bar	73379	-35°C - +80°C
	<b>B090080</b>	Pkg. 50	7.5 mm	12.5 mm	50 m	20 bar	73379	-35°C - +80°C
	<b>090081</b>	Pkg. 10	9 mm	14 mm	10 m	20 bar	73379	-35°C - +80°C
	<b>B090081</b>	Pkg. 50	9 mm	14 mm	50 m	20 bar	73379	-35°C - +80°C
	<b>090082</b>	Pkg. 10	11 mm	17.7 mm	10 m	20 bar	73379	-35°C - +80°C

## POLYAMID

	HC-CARGO	Std pkg	ID	OD	Length	Pressure	DIN Norm	Temp.
	<b>B090148</b>	Pkg. 25	4 mm	6 mm	25 m	27 bar	74324	-40°C - +100°C
	<b>B090083</b>	Pkg. 25	6 mm	8 mm	25 m	27 bar	74324	-40°C - +100°C
	<b>B090084</b>	Pkg. 25	8 mm	10 mm	25 m	27 bar	74324	-40°C - +100°C
	<b>B090119</b>	Pkg. 25	9 mm	12 mm	25 m	27 bar	74324	-40°C - +100°C

## VACUUM

**191192** Vacuum Hose Std pkg 20



Box dim.: 28.5x29.5x11.5 cm  
ID: 3 mm  
Length: 20 m

Colour: Black

<b>191193 Vacuum Hose</b>		Std pkg 20
	Box dim.: 28.5x29.5x11.5 cm	Hose type: Armoured
	ID: 4 mm Length: 20 m	Colour: Black

## PIPES

### HOSE SLEEVES

	HC-CARGO	Std pkg	ID	OD	Length
	080285	Pkg. 10	5 mm	6 mm	14.1 mm
	080260	Pkg. 10	11 mm	11.5 mm	17 mm
	080259	Pkg. 10	11 mm	13 mm	17 mm
	080261	Pkg. 10	12 mm	12.5 mm	20 mm
	080262	Pkg. 10	13.5 mm	13.5 mm	20 mm
	080263	Pkg. 10	14 mm	14.5 mm	20 mm
	080264	Pkg. 10	16 mm	16 mm	20 mm
	080265	Pkg. 10	17 mm	17.5 mm	21 mm

## NUTS

<b>080297 Pipe Nut</b>		Std pkg 10
	Thread: M10-1.5	
	Spanner size: 14 mm	

<b>080667 Pipe Nut</b>		Std pkg 10
	Thread: M10-1	
	Spanner size: 12 mm	

<b>080668 Pipe Nut</b>		Std pkg 10
	Thread: M 14-1.5	
	Spanner size: 17 mm	

<b>080669 Pipe Nut</b>		Std pkg 10
	Thread: M16-1.5	
	Spanner size: 19 mm	

## CONNECTIONS

	HC-CARGO	Std pkg	ID	Thread
	080829	Pkg. 1	6 mm	M10-1
	080830	Pkg. 1	6 mm	M12-1.5
	080831	Pkg. 1	8 mm	M14-1.5
	080930	Pkg. 5	8 mm	1/2"-20 UNF
	080931	Pkg. 5	8 mm	1/2"-20 UNF
	080268	Pkg. 5	8 mm	

## STRAIGHT CONNECTIONS

	HC-CARGO	Std pkg	Pipe	Thread	Length
	080287	Pkg. 1	6 mm	M12-1.5	39 mm
	080288	Pkg. 1	8 mm	M14-1.5	40 mm
	080289	Pkg. 1	10 mm	M16-1.5	42 mm

## CLAMPS

### HOSE

	HC-CARGO	Std pkg	ID min	ID max	Width	Spanner size	Ref. no.	Material
Coating: El. galvanized, Alu/zinc, Lacquered								
	190157	Pkg. 50	8 mm	14 mm	9 mm	7 mm	15	Steel
	193027	Pkg. 50	8 mm	14 mm	10 mm	7 mm	15	Carbon steel
	190158	Pkg. 50	11 mm	17 mm	9 mm	7 mm	17	Steel
	193028	Pkg. 50	11 mm	17 mm	10 mm	7 mm	17	Carbon steel
	190159	Pkg. 50	13 mm	20 mm	9 mm	7 mm	22	Steel
	193029	Pkg. 50	13 mm	20 mm	10 mm	7 mm	22	Carbon steel
	190160	Pkg. 50	15 mm	24 mm	12 mm	7 mm	25	Steel
	193030	Pkg. 50	15 mm	24 mm	12 mm	7 mm	25	Carbon steel
	190161	Pkg. 50	19 mm	28 mm	12 mm	7 mm	28	Steel
	193031	Pkg. 50	19 mm	28 mm	12 mm	7 mm	28	Carbon steel
	190162	Pkg. 50	22 mm	32 mm	12 mm	7 mm	32	Steel
	193032	Pkg. 50	22 mm	32 mm	12 mm	7 mm	32	Carbon steel
	190163	Pkg. 50	26 mm	38 mm	12 mm	7 mm	40	Steel
	193033	Pkg. 50	26 mm	38 mm	12 mm	7 mm	40	Carbon steel
	190164	Pkg. 50	32 mm	44 mm	12 mm	7 mm	45	Steel
	193034	Pkg. 50	32 mm	44 mm	12 mm	7 mm	45	Carbon steel
	190165	Pkg. 50	38 mm	50 mm	12 mm	7 mm	51	Steel
	193035	Pkg. 50	38 mm	50 mm	12 mm	7 mm	51	Carbon steel
	190166	Pkg. 50	44 mm	56 mm	12 mm	7 mm	56	Steel
	193036	Pkg. 50	44 mm	56 mm	12 mm	7 mm	56	Carbon steel
190167	Pkg. 10	50 mm	65 mm	12 mm	7 mm	65	Carbon steel	
193037	Pkg. 10	50 mm	65 mm	12 mm	7 mm	65	Steel	
190168	Pkg. 10	58 mm	75 mm	12 mm	7 mm	75	Carbon steel	
193038	Pkg. 10	58 mm	75 mm	12 mm	7 mm	75	Steel	
190169	Pkg. 10	68 mm	85 mm	12 mm	7 mm	85	Carbon steel	
193039	Pkg. 10	68 mm	85 mm	12 mm	7 mm	85	Steel	
190170	Pkg. 10	77 mm	95 mm	12 mm	7 mm	96	Carbon steel	
193040	Pkg. 10	77 mm	95 mm	12 mm	7 mm	96	Steel	
190171	Pkg. 10	87 mm	112 mm	12 mm	7 mm	113	Carbon steel	
193041	Pkg. 10	87 mm	112 mm	12 mm	7 mm	113	Steel	
190172	Pkg. 10	104 mm	138 mm	12 mm	7 mm	139	Steel	
191239	Pkg. 10	130 mm	165 mm	12 mm	7 mm	166	Steel	

### MINI

	HC-CARGO	Std pkg	ID min	ID max	Width	Spanner size	Ref. no.	Material
Coating: El. galvanized, Alu/zinc, Lacquered								
	190005	Pkg. 50	6 mm	8.3 mm	9 mm	7 mm	8	Steel
	190006	Pkg. 50	7 mm	9.3 mm	9 mm	7 mm	9	Steel
	190007	Pkg. 50	8 mm	10.3 mm	9 mm	7 mm	10	Steel
	190008	Pkg. 50	9 mm	11.3 mm	9 mm	7 mm	10	Steel
	190009	Pkg. 50	9 mm	12.3 mm	9 mm	7 mm	12	Steel
	190010	Pkg. 50	10 mm	13.3 mm	9 mm	7 mm	13	Steel
	190937	Pkg. 50	11 mm	14.3 mm	9 mm	7 mm	14	Steel
	190938	Pkg. 50	12 mm	15.3 mm	9 mm	7 mm	15	Steel
	191056	Pkg. 50	13 mm	16.3 mm	9 mm	7 mm	16	Steel
	192054	Pkg. 50	14 mm	17.3 mm	9 mm	7 mm	17	Steel

### TOOLS

#### HOSE CLAMP SCREWDRIVERS

210249 Hose Clamp Screwdriver Std pkg 1

Flexible.





PIPE						
	HC-CARGO	Std pkg	ID		Thickness	Material
	191592	Pkg. 10	42 mm	1 5/8"	8 mm	Galvanized steel
	191593	Pkg. 10	45 mm	1 3/4"	8 mm	Galvanized steel
	191594	Pkg. 10	48 mm	1 7/8"	8 mm	Galvanized steel
	191595	Pkg. 10	51 mm	2"	8 mm	Galvanized steel
	191596	Pkg. 10	54 mm	2 1/8"	8 mm	Galvanized steel
	191597	Pkg. 10	57 mm	2 1/4"	8 mm	Galvanized steel
EAR CLIPS						
192817 Ear Clip Std pkg 100						
<i>w/ inserts. Min. 8.5 mm. Max 10.5 mm.</i>						
192818 Ear Clip Std pkg 100						
<i>w/ inserts. Min. 9.5 mm. Max 11.5 mm.</i>						
TAPES						
INSULATION TAPE						
	HC-CARGO	Std pkg	Width	Colour	Dim.	Material
	193220	Pkg. 10	15 mm	Black	0.1 mm x 10 m	PVC
	193221	Pkg. 10	15 mm	Red	0.1 mm x 10 m	PVC
	193222	Pkg. 10	15 mm	Blue	0.1 mm x 10 m	PVC
	193223	Pkg. 10	15 mm	Green	0.1 mm x 10 m	PVC
	193224	Pkg. 10	15 mm	Yellow	0.1 mm x 10 m	PVC
	193225	Pkg. 10	15 mm	Grey	0.1 mm x 10 m	PVC
	193226	Pkg. 10	15 mm	White	0.1 mm x 10 m	PVC
	193227	Pkg. 10	19 mm	Black	0.1 mm x 10 m	PVC
	190180	Pkg. 20	15 mm	Black	0.1 mm x 10 m	
	190181	Pkg. 20	15 mm	Red	0.1 mm x 10 m	
	190182	Pkg. 20	15 mm	Blue	0.1 mm x 10 m	
	190183	Pkg. 20	15 mm	Green	0.1 mm x 10 m	
	190184	Pkg. 20	15 mm	Yellow	0.1 mm x 10 m	
	190185	Pkg. 20	15 mm	Grey	0.1 mm x 10 m	
	190186	Pkg. 20	15 mm	White	0.1 mm x 10 m	
	190187	Pkg. 16	19 mm	Black	0.1 mm x 10 m	
191065	Pkg. 6	50 mm	Black	0.2 mm x 20 m		
TEXTILE TAPE						
	HC-CARGO	Std pkg	Width	Colour	Length	Material
	192366	Pkg. 5	9 mm	Black	25 m	Textile
	193231	Pkg. 5	9 mm	Black	25 m	Textile
	191237	Pkg. 5	19 mm	Black	25 m	Textile
	193230	Pkg. 5	19 mm	Black	25 m	Textile
	193232	Pkg. 1	50 mm	Grey	50 m	
	192755	Pkg. 1	50 mm	Grey	50 m	
FIELD COIL TAPE						
	HC-CARGO	Std pkg	Width	Length	Material	
	191377	Pkg. 100	10 mm	100 m	Cotton	
	191378	Pkg. 100	20 mm	100 m	Cotton	

## THREAD SEAL TAPE

192379 Threaded Tape

Std pkg 10



Length: 12 m  
Thickness: 12 mm

Colour: White  
Material: PTFE

## MASKING

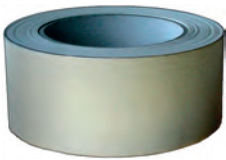

HC-CARGO	Std pkg	Width	Length
200005	Pkg. 1	25 mm	50 m
200004	Pkg. 1	50 mm	50 m

## ADHESIVE

### CYANOACRYLATE

200697 Cyanoacrylate Adhesive

Std pkg 1

*LOCTITE 480 is a medium viscosity, fast curing, single component cyanoacrylate adhesive. It is specially formulated for increased flexibility and peel strength. TYPICAL APPLICATIONS: Rapid bonding of a wide range of metal, plastic and electrometric materials.*



Temp.: 22 °C  
Hardening time:  
60-120 sec.  
Content: 20 g

Type: 480  
Adhesive type: Cyanoacrylate adhesive

## SILICONE COMPOUND

134686 Dielectric Gel

Std pkg 1

*Prevents fusing of spark wires and corrosion. Odourless, non-volatile. Works in extreme temperatures. Resists moisture, air, acids and alkalines.*



Content: 142 g

Alternativ no.: 232776

200094 Silicone Compound

Std pkg 1

*Used for motors, windshield and sunroof.*



Content: >85

## SURFACE CLEANING

200300 Glass beads 300-400 micron Std pkg 25

*Used for sand blowing. Used for surface treatment eg. cleaning, fine trimming, deburring and tumbling.*



Grades: 300-400  
Grades 2: 0.3-0.4

Material: Glass  
Alternativ no.: b200300

**200400** Steel Shot Std pkg 25

Used for sand blowing. Used for surface treatment eg. cleaning, fine trimming, deburring and tumbling.



Grades: 300-500  
Grades 2: 0.3-0.5

Material: Steel  
Approval: SAEJ444

**200500** Steel Shot Std pkg 25

Used for sand blowing. Used for surface treatment eg. cleaning, fine trimming, deburring and tumbling.



Grades: 212-600  
Grades 2: 0.2-0.6

Material: Steel

**ABRASIVE CLOTHS**

	HC-CARGO	Std pkg	Grades	Dim.	Type	
	200721	Pkg. 1	P40	40 mm x 50 m	Rolls	A flexible resin bonded aluminium oxide cloth for general purpose work shop use.
	200722	Pkg. 1	P60	40 mm x 50 m	Rolls	A flexible resin bonded aluminium oxide cloth for general purpose work shop use.
	200723	Pkg. 1	P80	40 mm x 50 m	Rolls	A flexible resin bonded aluminium oxide cloth for general purpose work shop use.
	200734	Pkg. 1	P120	40 mm x 50 m	Rolls	A flexible resin bonded aluminium oxide cloth for general purpose work shop use.
	200810	Pkg. 1	P180	40 mm x 50 m	Rolls	A flexible resin bonded aluminium oxide cloth for general purpose work shop use.
	200724	Pkg. 1	P320	40 mm x 50 m	Rolls	A flexible resin bonded aluminium oxide cloth for general purpose work shop use.

**OIL & GREASE**

**BEARING GREASE**

**200746** Molykote br2+ Bearing Grease Std pkg 1

Molykote BR 2 plus universal heavy duty grease provides:

- Reduction of wear
- Emergency lubrication
- Higher operational reliability
- Extended lubrication intervals even under high loads and difficult running conditions. Molykote BR 2 plus is suitable for a wide temperature range; it is resistant to oxidation and resist hot and cold water. It also has good corrosion-inhibiting properties.

Range of application

Molykote BR 2 plus can be used wherever grease lubrication is normally applied, e.g. for:

- All types of antifriction bearings
- Plain bearings and guides
- Joints and splined shafts
- Threaded spindles and small gear units at low speeds and all bearings subject to severe impact loads or exposed to extreme atmospheric conditions
- For chassis lubrication on motor vehicles.



Content: 100 g

**200748** Molykote 33 Bearing Grease Std pkg 1

Molykote 33 is used to lubricate ball and sometimes roller bearings operating under light to moderate loads and at low to medium speeds. Typical applications include: Starter drives, freezer, car casters and cold room conveyor equipment. Maximum demand meters, power factor meters, watt-hour meters, windshield wiper motor gears.



Content: 100 g

**200749 Molykote 33 Bearing Grease Std pkg 1**

Molykote 33 is used to lubricate ball and sometimes roller bearings operating under light to moderate loads and at low to medium speeds. Typical applications include: Starter drives, freezer, car casters and cold room conveyor equipment. Maximum demand meters, power factor meters, watt-hour meters, windshield wiper motor gears.



Content: 1 kg

**HEAT TRANSFER COMPOUND**
**200618 Heat Transfer Compound Std pkg 1**

Heat transfer grease is a grease-like silicone material heavily filled with heat conductive metal oxides. This material maintains a positive heat sink seal that transfer from electrical and electronic devices to the heat sink or chassis. Used where heat dissipation is required.



Content: 142 g

**MULTI PURPOSE GREASE**
**200745 Multi Purpose Grease Std pkg 1**

Universal grease for general and industrial use. For small and medium sized bearings, even under demanding conditions. Has water repellent properties and protects against corrosion. Used in: agricultural machinery, motor wheel bearings, small electric motors, conveyor systems etc.



Content: 200 g

**200747 Multi Purpose Grease Std pkg 1**

Molykote BR 2 plus universal heavy duty grease provides:

- Reduction of wear
- Emergency lubrication
- Higher operational reliability
- Extended lubrication intervals even under high loads and difficult running conditions. Molykote BR 2 plus is suitable for a wide temperature range; it is resistant to oxidation and resist hot and cold water. It also has good corrosion-inhibiting properties.







Range of application

Molykote BR 2 plus can be used wherever grease lubrication is normally applied, e.g. for:

- All types of antifriction bearings
- Plain bearings and guides
- Joints and splined shafts
- Threaded spindles and small gear units at low speeds and all bearings subject to severe impact loads or exposed to extreme atmospheric conditions
- For chassis lubrication on motor vehicles.



Content: 1 kg





DRY BATTERIES			
CARBON-ZINK			
200735 Battery	Std pkg 4		
	Voltage: 1.5	Dim.: 13.9x50 mm	ASA type: AA LEC type: R6 Battery type: Carbon-Zinc Heavy duty: Yes Mercury: w/o Cadmium: w/o
200796 Battery	Std pkg 1		
	Voltage: 6	Dim.: 66x66x111 mm	LEC type: 4R25 Battery type: Carbon-Zinc Heavy duty: Yes
ALKALINE			
200601 Battery	Std pkg 1		
GP 23AE-C1 Ultra FRP 20/400.			
	Voltage: 12	Dim.: 10x28 mm	Battery type: Ultra Alkaline
200738 Battery	Std pkg 4	Servicing: HC-CARGO 171749, 171805, 172089, 172103, 172104	
	Voltage: 1.5	Dim.: 10.5x44.5 mm	ASA type: AAA LEC type: LR03 Battery type: Alkaline Mercury: w/o Cadmium: w/o
200739 Battery	Std pkg 4	Servicing: HC-CARGO 171797	
	Voltage: 1.5	Dim.: 14.5x50.5 mm	ASA type: AA LEC type: LR6 Battery type: Alkaline Mercury: w/o Cadmium: w/o
200740 Battery	Std pkg 2	Servicing: HC-CARGO 171787	
	Voltage: 1.5	Dim.: 25.4x49.5 mm	ASA type: C LEC type: LR14 Battery type: Alkaline Mercury: w/o Cadmium: w/o
200741 Battery	Std pkg 2	Servicing: HC-CARGO 170353, 170683	
	Voltage: 1.5	Dim.: 33x60.3 mm	ASA type: D LEC type: LR20 Battery type: Alkaline Mercury: w/o Cadmium: w/o

		EL. SPECIFICATIONS	DIMENSIONS	ADDITIONAL SPECIFICATIONS
<b>200742 Battery</b> Std pkg 1      Servicing: HC-CARGO 171464, 171466 <i>Digital Multimeter: HC-CARGO 210977.</i>				
		Voltage: 9	Dim.: 25.5x16.5x47 mm	LEC type: 6LR61 Battery type: Alkaline
<b>200792 Battery</b> Std pkg 2				
		Voltage: 1.5	Dim.: 11.7x29.1 mm	ASA type: N LEC type: LR1 Battery type: Alkaline Mercury: w/o Cadmium: w/o
<b>200808 Battery</b> Std pkg 2				
		Voltage: 1.5	Dim.: 42.5x8.3 mm	ASA type: AAAA LEC type: LR61 Battery type: Alkaline Mercury: w/o Cadmium: w/o
<b>HIGH VOLTAGE</b>				
<b>200776 Battery</b> Std pkg 1 <i>Major applications: Electronic instruments, photo and remote control. High voltage.</i>				
		Voltage: 6	Dim.: 10x16 mm	LEC type: 4LR23 Battery type: Alkaline
<b>200777 Battery</b> Std pkg 1 <i>Major applications: Electronic instruments, photo and remote control. High voltage. 27 Amp.</i>				
		Voltage: 12	Dim.: 7.7x28 mm	Battery type: Alkaline
<b>200791 Battery</b> Std pkg 1 <i>Major applications: Electronic instruments, photo and remote control. High voltage.</i>				
		Voltage: 6	Dim.: 13x25.2 mm	LEC type: 4LR44 Battery type: Alkaline
<b>LITHIUM</b>				
<b>200828 Lithium Battery</b> Std pkg 1 <i>Major applications: Torch light and photo.</i>				
		Voltage: 3 Miliamp: 1400	Dim.: 16.8x34.5 mm	Battery type: Lithium

		EL. SPECIFICATIONS	DIMENSIONS	ADDITIONAL SPECIFICATIONS
<b>200848</b> Lithium Battery Std pkg 1				
		Voltage: 3 Miliamp: 160	Dim.: 11.6x10 mm	Battery type: Lithium
<b>BUTTON</b>				
<b>200772</b> Battery Std pkg 10				
<i>Major applications: computer memory backup, photo, remote control and watch.</i>				
		Voltage: 3 Miliamp: 90	Dim.: 20x1.6 mm	LEC type: CR2016 Battery type: Lithium
<b>200773</b> Battery Std pkg 10				
<i>Major applications: computer memory backup, photo, remote control and watch.</i>				
		Voltage: 3 Miliamp: 36	Dim.: 12.5x2 mm	LEC type: CR1220 Battery type: Lithium
<b>200774</b> Battery Std pkg 10				
<i>Major applications: computer memory backup, photo, remote control and watch.</i>				
		Voltage: 3 Miliamp: 160	Dim.: 20x2.5 mm	LEC type: CR2025 Battery type: Lithium
<b>200775</b> Battery Std pkg 10				
<i>Major applications: computer memory backup, photo, remote control, watch and digital sliding gauge.</i>				
		Voltage: 3 Miliamp: 220	Dim.: 20x3.2 mm	LEC type: CR2032 Battery type: Lithium
<b>200778</b> Battery Std pkg 10				
<i>Major applications: calculator, photo, remote control and watch.</i>				
		Voltage: 1.5 Miliamp: 190	Dim.: 15.6x5.95 mm	LEC type: LR9 Battery type: Alkaline
<b>200779</b> Battery Std pkg 10				
<i>Major applications: calculator, photo, watch and digital sliding gauge.</i>				
		Voltage: 1.55 Miliamp: 130	Dim.: 11.6x5.4 mm	LEC type: SR44 Battery type: Mercury

200802 Battery		Std pkg 10	
<i>Major applications: computer memory backup, photo, remote control, watch and digital sliding gauge.</i>			
	Voltage: 3 Miliamp: 7.8	Dim.: 16x2 mm	LEC type: CR1620 Battery type: Lithium
200813 Battery		Std pkg 10	
<i>Major applications: computer memory backup, photo, remote control and watch.</i>			
	Voltage: 3 Miliamp: 140	Dim.: 16x3.2 mm	LEC type: CR1632 Battery type: Lithium
200846 Battery		Std pkg 10	
<i>Major application: Eberspächer heater.</i>			
	Voltage: 3 Miliamp: 300	Dim.: 24x3 mm	LEC type: CR2430 Battery type: Lithium
200854 Battery		Std pkg 10	
<i>Major applications: computer memory backup, photo, remote control and watch.</i>			
	Voltage: 3 Miliamp: 55	Dim.: 16x1.6 mm	LEC type: CR1616 Battery type: Lithium
200858 Battery		Std pkg 10 Servicing: HC-CARGO 253489	
<i>For calculator, photo, clock and IA.</i>			
	Voltage: 1.5 Miliamp: 160	Dim.: 7.9x3.48 mm	LEC type: LR41 Battery type: Alkaline
200898 Battery		Std pkg 10	
<i>Major applications: computer memory backup, photo, remote control and watch.</i>			
	Voltage: 3 Miliamp: 610	Dim.: 24.5x5 mm	LEC type: CR2450 Battery type: Lithium
<b>RECHARGEABLE</b>			
200765 Battery		Std pkg 2	
	Voltage: 1.2 Miliamp: 950	Dim.: 10.5x44.5 mm	ASA type: AAA LEC type: RC03 Battery type: NIMH



		EL. SPECIFICATIONS	DIMENSIONS	ADDITIONAL SPECIFICATIONS
200766 Battery	Std pkg 4	 Voltage: 1.2 Miliamp: 2600	Dim.: 14.5x50.5 mm	ASA type: AA LEC type: RC06 Battery type: NIMH
200768 Battery	Std pkg 2			
	Servicing: HC-CARGO 170353, 170683	 Voltage: 1.2 Miliamp: 2200	Dim.: 34.2x61.5 mm	ASA type: D LEC type: RC20 Battery type: NIMH
200769 Battery	Std pkg 1			
	Servicing: HC-CARGO 171464, 171466	 Voltage: 8.4 Miliamp: 170	Dim.: 15.7x26.5x48 mm	LEC type: 9 V Battery type: NIMH
200851 ReCyco Battery	Std pkg 2			
<i>New generation of rechargeable batteries. Recyco batteries have a superior charge retention capability. Comes precharged and ready to use right out of the pack.</i>				
		 Voltage: 1.2 Miliamp: 1000	Dim.: 10.5x44.5 mm	ASA type: AAA LEC type: RC03 Battery type: NIMH
200852 ReCyco Battery	Std pkg 4			
	Servicing: HC-CARGO 200853	 Voltage: 1.2 Miliamp: 2100	Dim.: 14.5x50 mm	ASA type: AA LEC type: RC06 Battery type: NIMH
<h2>BATTERY CHARGER</h2>				
200771 Battery Charger	Std pkg 1	<i>For AA, AAA, C, D and 9 V NIMH batteries. 7 hours to full charge. w/ automatic timer cut-out on full charge.</i>		
			Weight: 0.5 kg	Auto stop: Yes
200853 ReCyco Battery Charger	Std pkg 1			
<i>For AA and AAA NIMH batteries. Individual charging channels, damaged battery detection, car charging function, universal voltage for worldwide use. Can charge 1-4 AA batteries or AAA batteries. Supplied w/ 4 pcs AA batteries (HC-CARGO 200852).</i>				
			Weight: 0.5 kg	Auto stop: Yes

## PROTECTING CAPS, TUBES & PLUGS

### PROTECTING CAPS

	HC-CARGO	Std pkg	OD/cone	ID/cone	Height	Type no.	Colour	Material
	192988	Pkg. 250		4.8 mm	12.8 mm		Black	EPDM rubber
	191364	Pkg. 100	4.8/5.5	3.2/4	5.7 mm	3	Red	Polyethylen
	191365	Pkg. 100	6/6.7	4.5/5.3	5.9 mm	5	Red	Polyethylen
	191366	Pkg. 100	6.8/7.4	5/5.6	6.8 mm	6	Red	Polyethylen
	191367	Pkg. 100	7.6/8.5	6/7.1	8 mm	8	Red	Polyethylen
	191368	Pkg. 100	8.3/9.4	6.9/7.9	9 mm	10	Red	Polyethylen
	191369	Pkg. 100	10.1/11	8.2/9.5	9.9 mm	12	Red	Polyethylen
	191370	Pkg. 100	10.8/12.5	9/10.8	9.6 mm	15	Red	Polyethylen
	191371	Pkg. 100	11.4/12.8	10.1/11.3	9.8 mm	16	Red	Polyethylen
	191642	Pkg. 100	12/13.8	10.6/12.1	11.1 mm	17	Red	Polyethylen
	191372	Pkg. 100	13.1/14.5	11.5/13	11.1 mm	18	Red	Polyethylen
	191373	Pkg. 100	13.9/15.4	12.4/14	12 mm	20	Red	Polyethylen
	191374	Pkg. 100	14.2/15.7	13/14.7	12.8 mm	25	Red	Polyethylen
	191375	Pkg. 100	14.9/16.8	14/15.5	12.8 mm	27	Red	Polyethylen
	191480	Pkg. 100	17.2/18.9	15.8/17.6	14 mm	30	Red	Polyethylen
191376	Pkg. 100	18.2/20.2	16.4/18.8	13.9 mm	35	Red	Polyethylen	

### PROTECTING PLUGS

	HC-CARGO	Std pkg	Thread	Colour	Material
	191862	Pkg. 100	M8-1	Red	Polyethylen
	191857	Pkg. 100	M8-1	Red	Polyethylen
	191863	Pkg. 100	M10-1	Red	Polyethylen
	191858	Pkg. 100	M10-1	Red	Polyethylen
	191864	Pkg. 100	M12-1	Red	Polyethylen
	191859	Pkg. 100	M12-1	Red	Polyethylen
	191865	Pkg. 100	M12-1.5	Red	Polyethylen
	191860	Pkg. 100	M12-1.5	Red	Polyethylen
	191866	Pkg. 100	M14-1.5	Yellow	Polyethylen
	191861	Pkg. 100	M14-1.5	Red	Polyethylen

### PROTECTING TUBES

#### PLASTIC

	HC-CARGO	Std pkg	OD	ID	Height	Colour	Material
	191392	Pkg. 100	14 mm	10 mm	10 mm	Transparent	Plastic

#### PAPER

	HC-CARGO	Std pkg	OD	ID	Height	Material
	191391	Pkg. 500	22.4 mm	19.5 mm	14 mm	Cardboard

### RUBBER BOOTS

	191616 Rubbe Boot "denka lift"	Std pkg 150	ID: 25 mm ID/cone: 63 mm Length: 80 mm			
--	--------------------------------	-------------	--	--	--	--

**ASSEMBLY PARTS**
**SEALS & WIRE**
**080751** Seal Wire      Std pkg 100

Length: 210 mm

**081006** Seal      Std pkg 100

OD: 9 mm

 Colour: Red  
Material: Plastic

**VALVES**
**080108** Overflow Valve      Std pkg 1

 Thread: M14-1.5  
Pressure: 0.5-1 bar

**080109** Overflow Valve      Std pkg 1

 Thread: M14-1.5  
Pressure: 1.3-1.8 bar

**080111** Overflow Valve      Std pkg 1

*Can be used w/ petrol & E85.*





 Thread: M14-1.5  
Pressure: 1.3-1.8 bar

**080213** Overflow Valve      Std pkg 1

Thread: M12x1.5

**080250** Overflow Valve      Std pkg 1

 Thread: M14-1.5  
Pressure: 1.2-1.5 bar

		EL. SPECIFICATIONS	DIMENSIONS	ADDITIONAL SPECIFICATIONS
<b>080690</b>	Overflow Valve	Std pkg 1		
			Thread: M14-1.5	Calibrated: Yes
<b>080784</b>	Overflow Valve	Std pkg 1		
	Aluminium. Can be used w/ petrol & E85.		Hose connection: 6 mm Pressure: 1.5-2 bar	
<b>080785</b>	Overflow Valve	Std pkg 1		
	Can be used w/ petrol & E85.		Hose connection: 8 mm Pressure: 1.5-2 bar	
<b>080786</b>	Overflow Valve	Std pkg 1		
	Pipe diameter 10 mm. Can be used w/ petrol & E85.		Hose connection: 10 mm Pressure: 1.5-2 bar	
<b>081111</b>	Overflow Valve	Std pkg 1		
			Hose connection: 12 mm Pressure: 1.5-2 bar	

## JOINTS

### ANGLE

	HC-CARGO	Std pkg	Thread	
	<b>080653</b>	Pkg. 5	M5-0.8	Type AS w/ threaded journal, hex nut and lock pin. DIN 71802.
	<b>080629</b>	Pkg. 1	M6x1	Type AS w/ threaded journal, hex nut and lock pin. DIN 71802.
	<b>080654</b>	Pkg. 5	M6x1x10	Type AS w/ threaded journal, hex nut and lock pin. DIN 71802.
	<b>080655</b>	Pkg. 5	M8x1.25	Type AS w/ threaded journal, hex nut and lock pin. DIN 71802.
	<b>080656</b>	Pkg. 1	M10x1.5	Type AS w/ threaded journal, hex nut and lock pin. DIN 71802.
	<b>080657</b>	Pkg. 1	M12x1.75	Type AS w/ threaded journal, hex nut and lock pin. DIN 71802.

### FORK BOLTS

	HC-CARGO	Std pkg	OD	Length
	<b>080662</b>	Pkg. 10	6 mm	18 mm
	<b>080663</b>	Pkg. 10	8 mm	22 mm
	<b>080664</b>	Pkg. 10	10 mm	28 mm
	<b>080665</b>	Pkg. 10	12 mm	35 mm
	<b>080666</b>	Pkg. 10	14 mm	40 mm

IN LINE					
	HC-CARGO	Std pkg	Thread		
	080744	Pkg. 1	M6-1		
	080745	Pkg. 1	M8-1		
FORK HEADS					
	HC-CARGO	Std pkg	Thread	Length	Slot wide
	080863	Pkg. 1	M5	10 mm	5 mm
	080843	Pkg. 1	M5	10 mm	5 mm
	080659	Pkg. 1	M6	12 mm	6 mm
	080660	Pkg. 1	M8	16 mm	8 mm
	080661	Pkg. 1	M8	16 mm	8 mm
HOSE NIPPLES					
	HC-CARGO	Std pkg	Hose ID		Length
	080274	Pkg. 5	5 mm		26 mm
	080275	Pkg. 5	8 mm		32 mm
	080276	Pkg. 5	10 mm		34 mm
DOUBLE					
	HC-CARGO	Std pkg	Bolt size	ID/demister tube connection	Type
	080245	Pkg. 5	8 mm	6 mm	Dual
	080859	Pkg. 5	10 mm	6 mm	Dual
	080246	Pkg. 5	12 mm	8 mm	Dual
	080247	Pkg. 5	14 mm	10 mm	Dual
DIN 7622					
	HC-CARGO	Std pkg	Bolt size	ID/demister tube connection	Type
	080795	Pkg. 5	8 mm	4 mm	Single
	080237	Pkg. 5	8 mm	6 mm	Single
	080239	Pkg. 5	10 mm	7 mm	Single
	080678	Pkg. 5	10 mm	8 mm	Single
	080679	Pkg. 5	12 mm	10 mm	Single
	080240	Pkg. 5	12 mm	7 mm	Single
	080241	Pkg. 5	12 mm	9 mm	Single
	080243	Pkg. 5	14 mm	11 mm	Single
	080826	Pkg. 5	14 mm	12 mm	Single
	080238	Pkg. 5	14 mm	6 mm	Single
	080242	Pkg. 5	14 mm	9 mm	Single
	080002	Pkg. 5	16 mm	10 mm	Single
	080003	Pkg. 5	16 mm	12 mm	Single
	080860	Pkg. 5	1/2"	8 mm	Single
	T-CONNECTOR				
	HC-CARGO	Std pkg	Hose ID		
	080836	Pkg. 5	4 mm		
	080838	Pkg. 5	6 mm		
	080839	Pkg. 5	8 mm		

## PIPE NIPPLES

	HC-CARGO	Std pkg	Hose ID
	080269	Pkg. 5	5 mm
	080270	Pkg. 5	6 mm
	080271	Pkg. 5	8 mm
	080272	Pkg. 5	10 mm
	080273	Pkg. 5	12 mm

## HOLLOW SCREWS

	HC-CARGO	Std pkg	Thread	Bore	Type
	080575	Pkg. 10	M6-1		Drain bolt
	080251	Pkg. 10	M8-1	4.2 mm	Ordinary
	080001	Pkg. 10	M10-1.25	4 mm	Ordinary
	080253	Pkg. 10	M10-1.5	4 mm	Ordinary
	081116	Pkg. 5	M10-1.5	4 mm	Ordinary
	080252	Pkg. 10	M10-10	4 mm	Ordinary
	080254	Pkg. 10	M12-1.5	6 mm	Ordinary
	080255	Pkg. 10	M14-1.5	8 mm	Ordinary
	080256	Pkg. 10	M16-1.5	9 mm	Ordinary
	080731	Pkg. 1	M16-1.5	11 mm	Short
	080812	Pkg. 10	1/2"-20 UNF	6 mm	Ordinary

## DOUBLE

	HC-CARGO	Std pkg	Thread	Bore	Type
	080257	Pkg. 5	M8-1	2 mm	Dual
	080258	Pkg. 5	M14-1.5	8 mm	Dual

## EYE UNION

### SOLDER

	HC-CARGO	Std pkg	Bolt size	OD/pipe	Type
	080298	Pkg. 1	16 mm	12 mm	Single

## POLYAMID TUBES

	HC-CARGO	Std pkg	Bolt size	ID/demister tube connection	Type
	080627	Pkg. 5	12 mm	8 mm	Single
	080283	Pkg. 5	14 mm	8 mm	Single
	080284	Pkg. 5	14 mm	10 mm	Single

## RETAINING RINGS FOR SHAFT AND BORES

### LOCK RINGS

#### EXTERNAL

	HC-CARGO	Std pkg	OD/housing	DIN norm	Material
	191799	Pkg. 100	14 mm	471	Steel spring
	191270	Pkg. 100	15 mm	471	Steel spring
	192524	Pkg. 100	16 mm	471	Steel spring
	191816	Pkg. 100	17 mm	471	Steel spring
	191271	Pkg. 100	18 mm	471	Steel spring
	191333	Pkg. 100	19 mm	471	Steel spring
	191272	Pkg. 100	20 mm	471	Steel spring
	191273	Pkg. 100	21 mm	471	Steel spring
	191274	Pkg. 100	22 mm	471	Steel spring
	191481	Pkg. 100	23 mm	471	Steel spring
	191275	Pkg. 100	24 mm	471	Steel spring
	191276	Pkg. 100	25 mm	471	Steel spring
	191914	Pkg. 100	26 mm	471	Steel spring
	191433	Pkg. 100	27 mm	471	Steel spring

## CIRCLIPS

	HC-CARGO	Std pkg	OD/housing	DIN norm	Material
	191277	Pkg. 100	3.2 mm	6799	Steel spring
	192707	Pkg. 100	4 mm	6799	Steel spring
	191278	Pkg. 100	6 mm	6799	Steel spring
	191573	Pkg. 100	7 mm	6799	Steel spring
	191279	Pkg. 100	8 mm	6799	Steel spring
	191280	Pkg. 100	9 mm	6799	Steel spring
	192507	Pkg. 100	15 mm	6799	Steel spring

## SPRING PINS

135061 Spring Pin Std pkg 5

For mounting bushing.

	ID: 11.50 mm OD: 14.00 mm Length: 50.00 mm	Material: Steel spring Heat treated: Yes DIN norm: 7336 ISO norm: 13337
---	--	--

192814 Spring Pin Std pkg 100

	ID: 8.5 mm OD: 10.5 mm Length: 14 mm	Material: Steel spring Heat treated: Yes Heavy duty: No DIN norm: 7336 ISO norm: 13337
---	--	--

230858 Spring Pin Std pkg 5

	ID: 8.00 mm OD: 10.00 mm Length: 25.40 mm	Material: Steel spring Heat treated: Yes DIN norm: 7336 ISO norm: 13337
--	---	--

## BRASS OLIVES

	HC-CARGO	Std pkg	OD
	080277	Pkg. 10	4 mm
	080278	Pkg. 10	5 mm
	080279	Pkg. 10	6 mm
	080280	Pkg. 10	8 mm
	080281	Pkg. 10	10 mm
	080282	Pkg. 10	12 mm

## TOOLS

### HSS DRILLS

#### TWIST

	HC-CARGO	Std pkg	OD	DIN norm	Material	Type
	210141	Pkg. 10	1 mm	338	High Speed Steel	N
	210142	Pkg. 10	1.5 mm	338	High Speed Steel	N
	210143	Pkg. 10	2 mm	338	High Speed Steel	N
	210144	Pkg. 10	2.5 mm	338	High Speed Steel	N
	210145	Pkg. 10	3 mm	338	High Speed Steel	N
	210146	Pkg. 10	3.3 mm	338	High Speed Steel	N
	210164	Pkg. 10	3.5 mm	338	High Speed Steel	N
	210147	Pkg. 10	4 mm	338	High Speed Steel	N
	210148	Pkg. 10	4.5 mm	338	High Speed Steel	N
	210149	Pkg. 10	5 mm	338	High Speed Steel	N
	210150	Pkg. 10	5.5 mm	338	High Speed Steel	N
	210151	Pkg. 10	6 mm	338	High Speed Steel	N
	210152	Pkg. 10	6.5 mm	338	High Speed Steel	N
	210153	Pkg. 10	7 mm	338	High Speed Steel	N
	210154	Pkg. 10	7.5 mm	338	High Speed Steel	N
	210155	Pkg. 5	8 mm	338	High Speed Steel	N
	210156	Pkg. 5	8.5 mm	338	High Speed Steel	N
	210157	Pkg. 5	9 mm	338	High Speed Steel	N
210158	Pkg. 5	9.5 mm	338	High Speed Steel	N	
210159	Pkg. 5	10 mm	338	High Speed Steel	N	
210160	Pkg. 5	10.5 mm	338	High Speed Steel	N	

## ASSORTMENT

**210140** Drill Assortment Std pkg 1

Contains 19 drills from 1-10 mm.



Type: HSS

## SOLDERING

### SOLDER

**200838** Solder Std pkg 1

99.3% tin. 0.7% copper. Unleaded.



Content: 1 kg

**200850** Solder Std pkg 1

99.3% tin. 0.7% copper. Unleaded.



Content: 500 g

### SILVER

**200790** Ribbon Silver Solder Std pkg 1

125 g.



Width: 6 mm

### IRONS







**210897** Soldering Iron Std pkg 1

HRT soldering irons are a patented technical innovation. An armoured teating element of very compact design is located in the heart of the tip and compared to the traditional method, this provides: A reduction of energy consumption by 25 to 35 % at equivalent power. 230 V. AC. Soldering capacity: Wires max. 7 mm, metal max. 7 mm. Tip: HC-CARGO 210903.



Voltage: 230  
Watt: 75



210898 Soldering Iron		Std pkg 1		
<p><i>HRT soldering irons are a patented technical innovation. An armoured teating element of very compact design is located in the heart of the tip and compared to the traditional method, this provides: A reduction of energy consump-tion by 25 to 35 % at equivalent power. 230 V. AC. Soldering capacity: Wires max. 9 mm, metal max. 12 mm. Tip: HC-CARGO 210904. Heating element: HC-CARGO 210901.</i></p>				
		<p>Voltage: 230 Watt: 100</p>		
210899 Soldering Iron		Std pkg 1		
<p><i>HRT soldering irons are a patented technical innovation. An armoured teating element of very compact design is located in the heart of the tip and compared to the traditional method, this provides: A reduction of energy consump-tion by 25 to 35 % at equivalent power. 230 V. AC. Soldering capacity: Wires max. 12 mm, metal max. 15 mm. Tip: HC-CARGO 210904. Heating element: HC-CARGO 210902.</i></p>				
		<p>Voltage: 230 Watt: 125</p>		
210910 Soldering Iron		Std pkg 1		
<p><i>HRT soldering irons are a patented technical innovation. An armoured teating element of very compact design is located in the heart of the tip and compared to the traditional method, this provides: A reduction of energy consump-tion by 25 to 35 % at equivalent power. 230 V. AC. Soldering capacity: Wires max. 13 mm, metal max. 22 mm. Tip: HC-CARGO 210912. Heating element: HC-CARGO 210911.</i></p>				
		<p>Voltage: 230 Watt: 200</p>		
211090 Soldering Gun		Std pkg 1		
<p><i>Tip: HC-CARGO 211092.</i></p>				
		<p>Voltage: 230 Watt: 250</p>		
211106 Gas Soldering Iron		Std pkg 1		
<p><i>Max. temperature 1371°C when used as a torch. Max. temperatur 510°C, when used for soldering. Tip: HC-CARGO 211107, -108, -109, -110.</i></p>				
				
SPARE PARTS				
210901 Heating Element		Std pkg 1	Servicing: HC-CARGO 210898	
		<p>Voltage: 230 Watt: 100</p>		

	EL. SPECIFICATIONS	DIMENSIONS	ADDITIONAL SPECIFICATIONS
<b>210902</b> Heating Element 	Std pkg 1	Servicing: HC-CARGO 210899 Voltage: 230 Watt: 125	
<b>210903</b> Soldering Tip 	Std pkg 1	Servicing: HC-CARGO 210897	
<b>210904</b> Soldering Tip 	Std pkg 1	Servicing: HC-CARGO 210898, 210899	
<b>210911</b> Heating Element 	Std pkg 1	Servicing: HC-CARGO 210910 Voltage: 230 Watt: 200	
<b>210912</b> Soldering Tip 	Std pkg 1	Servicing: HC-CARGO 210910	
<b>211092</b> Soldering Tip <i>For gun.</i> 	Std pkg 1	Voltage: 230 Watt: 250	
<b>211107</b> Soldering Tip 	Std pkg 1	Servicing: HC-CARGO 211106	
<b>211108</b> Chisel Tip 	Std pkg 1	Servicing: HC-CARGO 211106	

**211109 Soldering Tip**

Std pkg 1 Servicing: HC-CARGO 211106

*Wedge-shaped.*

**211110 Hot Knife**

Std pkg 1 Servicing: HC-CARGO 211106

**WORK GLOVES**
**LEATHER**

	HC-CARGO	Std pkg	Size	Approval	Material	Colour	
	200140	Pkg. 12	9	CE	Grain palm leather	Yellow	w/ Cuff
	200141	Pkg. 12	10	CE	Grain palm leather	Blue	w/ Cuff
	200142	Pkg. 12	11	CE	Grain palm leather	Yellow	w/ Cuff
	200526	Pkg. 12	10	CE	Grain palm leather	Red	Shoulded spilt palm.
	200527	Pkg. 12	11	CE	Grain palm leather	Red	

**RUBBER**

	HC-CARGO	Std pkg	Size	Approval	Material	Colour	
	200686	Pkg. 1	10	CE	Rubber	Black	<i>Strong quality. For short-blastning etc.</i>
	200787	Pkg. 1	10	CE	Rubber	Black	<i>Strong quality. For short-blastning etc.</i>
	200831	Pkg. 150	7	CE	Nitrile	Blue	
	200832	Pkg. 150	8	CE	Nitrile	Blue	
	200833	Pkg. 150	9	CE	Nitrile	Blue	
	200834	Pkg. 150	10	CE	Nitrile	Blue	
	200890	Pkg. 10	S	CE	Polyurethan	Grey	
	200891	Pkg. 10	M	CE	Polyurethan	Grey	
	200892	Pkg. 10	L	CE	Polyurethan	Grey	
	200893	Pkg. 10	XL	CE	Polyurethan	Grey	
	200897	Pkg. 10	XXL	CE	Polyurethan	Grey	
	200889	Pkg. 10	7	CE	Polyurethan	Red	
	200884	Pkg. 10	8	CE	Polyurethan	Red	
	200885	Pkg. 10	9	CE	Polyurethan	Red	
	200886	Pkg. 10	10	CE	Polyurethan	Red	
	200887	Pkg. 10	11	CE	Polyurethan	Red	

**COTTON & VINYL**

	HC-CARGO	Std pkg	Size	Approval	Material	Colour	
	200603	Pkg. 12	6	CE	Cotton	White	
	200805	Pkg. 12	8	CE	Cotton	White	
	200640	Pkg. 10	10	CE	Cotton	White	
	200655	Pkg. 12	8	CE	Nitrile	White/Grey	w/ rib.
	200685	Pkg. 12	10	CE	Nitrile	White/Grey	w/ rib.
	200869	Pkg. 100	10	CE	Vinyl	Transparent	

## LATEX

	HC-CARGO	Std pkg	Size	Approval	Material	Colour	
	200687	Pkg. 100	8	CE	Latex	Nature	<i>Universal.</i>
	200688	Pkg. 100	9	CE	Latex	Nature	<i>Universal.</i>

## SAFETY GLASSES

253488 UV Glasses

Std pkg 1

Size: One size



## PROTECTING MASKS

200127 Protective Face Mask

Std pkg 10

*Protects against solid and liquid particles. Offers no protection against gases, vapours or oxygen deficiency. Maintenance-free.*



Class: FFP2S  
Approval: EN149

200144 Protective Face Mask

Std pkg 20

*Protects against solid particles bigger than 5 mg/m<sup>3</sup>. Offers no protection against liquid particles, gasses, vapours or oxygen deficiency.*



Disposable mask: Yes  
Class: FFP1S  
Approval: EN149

200624 Protective Face Mask

Std pkg 10

*Protects against solid particles bigger than 5 mg/m<sup>3</sup>. Offers no protection against liquid particles, gasses, vapours or oxygen deficiency.*



Disposable mask: Yes  
Class: FFP2S  
Approval: EN149

## THREADED INSERTS

	HC-CARGO	Std pkg	Internal thread	External thread	Length	
	192578	Pkg. 10	M10-1	M12-1	10 mm	<i>For glow plugs</i>

## WIRE THREAD

	HC-CARGO	Std pkg	Thread	Length	
	200698	Pkg. 25	M4	6 mm	For repairing or creating stronger threads.
	200699	Pkg. 10	M4	8 mm	For repairing or creating stronger threads.
	200700	Pkg. 10	M5	7.5 mm	For repairing or creating stronger threads.
	200701	Pkg. 10	M5	10 mm	For repairing or creating stronger threads.
	200702	Pkg. 10	M6	9 mm	For repairing or creating stronger threads.
	200703	Pkg. 10	M6	12 mm	For repairing or creating stronger threads.
	200704	Pkg. 10	M7	10.5 mm	For repairing or creating stronger threads.
	200706	Pkg. 10	M8	12 mm	For repairing or creating stronger threads.
	200707	Pkg. 10	M8	16 mm	For repairing or creating stronger threads.
	200708	Pkg. 10	M8	20 mm	For repairing or creating stronger threads.
	200709	Pkg. 10	M10	15 mm	For repairing or creating stronger threads.
	200710	Pkg. 10	M10	20 mm	For repairing or creating stronger threads.
	200712	Pkg. 10	M10-1.25	20 mm	For repairing or creating stronger threads.
	200711	Pkg. 10	M12	18 mm	For repairing or creating stronger threads.
200713	Pkg. 10	M12-1.25	18 mm	For repairing or creating stronger threads.	

## DIES AND TAPS

### MACHINE

	HC-CARGO	Std pkg	Thread	Length	DIN Norm	
	210789	Pkg. 1	M4	63 mm	376	Form A, HSS.
	210813	Pkg. 1	M5	50 mm	8140	For threaded inserts.
	210790	Pkg. 1	M5	70 mm	376	Form A, HSS.
	210791	Pkg. 1	M6	80 mm	376	Form A, HSS.
	210793	Pkg. 1	M8	90 mm	376	Form A, HSS.
	210818	Pkg. 1	M12	80 mm	8140	For threaded inserts.
	210822	Pkg. 1	M12-1.5	70 mm	8140	For threaded inserts.

## HOSE CLAMP SCREWDRIVERS

210249 Hose Clamp Screwdriver Std pkg 1

Flexible.



## COMBI TOOLS

210050 Multi Tool Std pkg 1

Pulley: HC-CARGO 330716. Multi Tool: HC-CARGO 210051.



210051 Multi Tool Std pkg 1 Servicing: HC-CARGO 210050

Freewheel Pulley: HC-CARGO 330716.



**210843** Combi Tool      Std pkg 1      Servicing: Bosch Alternators  
*33 teeth combitool for the disassembly and assembly of the free wheel pulley. XZN 10x110 mm, w/ 1/2" socket and 22 mm hexagon.*



**210873** Combi Tool      Std pkg 1      Servicing: Magneti Marelli - Visit [www.hc-cargo.com](http://www.hc-cargo.com) for further information.  
*For removing and installing of rubber clutch pulley. 200 mm spec. tool + 8x100 mm allen wrench w/ 1/2" socket.*



**210877** Combi Tool      Std pkg 1      Servicing: Bosch - Visit [www.hc-cargo.com](http://www.hc-cargo.com) for further information.  
*For removing and installing of rubber clutch pulley. XZN 10x112 mm w/ 1/2" socket and 30/28 mm hexagon.*



**210909** Combi Tool      Std pkg 1      Servicing: Valeo Alternators  
*33 teeth combitool for disassembly and assembly of free wheel pulley. Torx 50x110 mm, w/ 1/2" socket and 22 mm hexagon.*



**210948** Combi Tool      Std pkg 1      Servicing: Audi, VW, MB, SEAT, Skoda - Visit [www.hc-cargo.com](http://www.hc-cargo.com) for further information.  
*33 teeth combitool for the disassembly and assembly of the free wheel pulley, XZN 10x135 mm, w/ 1/2" socket and 22 mm hexagon.*



**211048** Combitool MK2      Std pkg 1      Servicing: Generators



**211049** Combitool MK3      Std pkg 1      Servicing: Generators



	EL. SPECIFICATIONS	DIMENSIONS	ADDITIONAL SPECIFICATIONS
<p><b>211081</b> Combi Tool</p> <p>For removing and installing of rubber clutch pulley.</p> 	<p>Std pkg 1</p>	<p>Servicing: VALEO - Visit <a href="http://www.hc-cargo.com">www.hc-cargo.com</a> for further information.</p>	<p>XZN 10x128 mm w/ 1/2" socket and 28/19 mm hexagon.</p>
<p><b>211129</b> Combi Tool set for Freewheel Pulley</p> <p>For removing/installing of Freewheel Pulley. Combi Tool: HC-CARGO 211130-211152.</p> 	<p>Std pkg 1</p>	<p>Servicing: Audi, BMW, Citroen, Chrysler, Fiat, Ford, Mercedes, Mazda, Opel, Peugeot, Porsche, Renault, Saab, Seat, Skoda, Toyota - Visit <a href="http://www.hc-cargo.com">www.hc-cargo.com</a> for further information.</p>	
<p><b>211130</b> Combi Tool</p> <p>Combi Tool 36R*H17*4 pins.</p> 	<p>Std pkg 1</p>	<p>Servicing: HC-CARGO 211129</p>	
<p><b>211131</b> Combi Tool</p> <p>Combi Tool H38*3 pins.</p> 	<p>Std pkg 1</p>	<p>Servicing: HC-CARGO 211129</p>	
<p><b>211132</b> Combi Tool</p> <p>Combi Tool H22.1*H28.1.</p> 	<p>Std pkg 1</p>	<p>Servicing: HC-CARGO 211129</p>	
<p><b>211133</b> Combi Tool</p> <p>Combi Tool H19*H28.</p> 	<p>Std pkg 1</p>	<p>Servicing: HC-CARGO 211129</p>	
<p><b>211134</b> Combi Tool</p> <p>Combi Tool H21*H28.</p> 	<p>Std pkg 1</p>	<p>Servicing: HC-CARGO 211129</p>	

211135 Combi Tool Std pkg 1 Servicing: HC-CARGO 211129  
 Combi Tool H22\*33T.



211136 Combi Tool Std pkg 1 Servicing: HC-CARGO 211129  
 Combi Tool H15\*33T(18R).



211137 Combi Tool Std pkg 1 Servicing: HC-CARGO 211129  
 Combi Tool H15\*33T(19.7R).



211138 Combi Tool Std pkg 1 Servicing: HC-CARGO 211129  
 Combi Tool H17\*35 mm.



211139 Combi Tool Std pkg 1 Servicing: HC-CARGO 211129  
 Combi Tool H22\*30 mm.



211140 Combi Tool Std pkg 1 Servicing: HC-CARGO 211129  
 Combi Tool 1/2"DRx1/2"adapter.



211141 Combi Tool Std pkg 1 Servicing: HC-CARGO 211129  
 Combi Tool 12R\*75 mm\*M10.





	EL. SPECIFICATIONS	DIMENSIONS	ADDITIONAL SPECIFICATIONS
<p><b>211142</b> Combi Tool  <i>Combi Tool 12R*75 mm*M8.</i></p> 	Std pkg 1	Servicing: HC-CARGO 211129	
<p><b>211143</b> Combi Tool  <i>Combi Tool 12R*75 mm*H10.</i></p> 	Std pkg 1	Servicing: HC-CARGO 211129	
<p><b>211144</b> Combi Tool  <i>Combi Tool 12R*75 mm*H8.</i></p> 	Std pkg 1	Servicing: HC-CARGO 211129	
<p><b>211145</b> Combi Tool  <i>Combi Tool 12R*75 mm*T50.</i></p> 	Std pkg 1	Servicing: HC-CARGO 211129	
<p><b>211146</b> Combi Tool  <i>Combi Tool 12R*75 mm*T40.</i></p> 	Std pkg 1	Servicing: HC-CARGO 211129	
<p><b>211147</b> Combi Tool  <i>Combi Tool 16R*64 mm*M10.</i></p> 	Std pkg 1	Servicing: HC-CARGO 211129	
<p><b>211148</b> Combi Tool  <i>Combi Tool 3/8"DR*M10*31T.</i></p> 	Std pkg 1	Servicing: HC-CARGO 211129	

211149 Combi Tool Std pkg 1 Servicing: HC-CARGO 211129

Combi Tool 1/2"DR\*110L\*M10.



211150 Combi Tool Std pkg 1 Servicing: HC-CARGO 211129

Combi Tool 1/2"DR\*113L\*M10.



211151 Combi Tool Std pkg 1 Servicing: HC-CARGO 211129

Combi Tool 1/2"DR\*113L\*T50.



211152 Combi Tool Std pkg 1 Servicing: HC-CARGO 211129

Combi Tool 1/4"DR\*10MM/35L.



## LAMBDA SENSOR TOOL

210763 Oxygen Sensor Tool Std pkg 1

Special tool for mounting/removing oxygen sensors.



Thread type: M18

## REMOVE/INSTALL

## INTERNAL EXTRACTORS

210777 Internal Extractor Std pkg 1

Suitable for extraction of needle/roller bearings, ball bearings, brass sleeves and flame arresters.

Dia.: 5-7 mm



210778 Internal Extractor Std pkg 1

Suitable for extraction of needle/roller bearings, ball bearings, brass sleeves and flame arresters.

Dia.: 7-9 mm



EL. SPECIFICATIONS	DIMENSIONS	ADDITIONAL SPECIFICATIONS
<p><b>210779</b> Internal Extractor      Std pkg 1</p> <p><i>Suitable for extraction of needle/roller bearings, ball bearings, brass sleeves and flame arresters.</i></p> 	<p>Dia.: 9-12 mm</p>	
<p><b>210780</b> Internal Extractor      Std pkg 1</p> <p><i>Suitable for extraction of needle/roller bearings, ball bearings, brass sleeves and flame arresters.</i></p> 	<p>Dia.: 10-13 mm</p>	
<p><b>210781</b> Internal Extractor      Std pkg 1</p> <p><i>Suitable for extraction of needle/roller bearings, ball bearings, brass sleeves and flame arresters.</i></p> 	<p>Dia.: 13-17 mm</p>	
<p><b>210782</b> Internal Extractor      Std pkg 1</p> <p><i>Suitable for extraction of needle/roller bearings, ball bearings, brass sleeves and flame arresters.</i></p> 	<p>Dia.: 14-19 mm</p>	
<p><b>210786</b> Internal Extractor      Std pkg 1</p> <p><i>Suitable for extraction of needle/roller bearings, ball bearings, brass sleeves and flame arresters.</i></p> 	<p>Dia.: 25-30 mm</p>	
<p><b>UNIVERSAL PULLER</b></p>		
<p><b>210868</b> Universal Puller      Std pkg 1</p> <p><i>w/ slender hooks. Min.-max. 10-80 mm.</i></p> 		
<p><b>SOLENOID TOOLS</b></p>		
<p><b>210686</b> Solenoid Tool      Std pkg 1</p> <p><i>Makes opening and closing Bosch, Bosch industrial, hitachi and mitsubishi passenger car "crimp cap" -solenoids a fast and simple press operation. Complete set in carrying box.</i></p> 		

## SOLENOID COIL

210567 Mounting Sleeve Std pkg 1

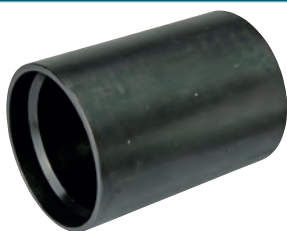

## DRIVE TOOLS

210867 Assembly Tool Std pkg 1

Tool for renewing of new type Bosch starter. For mounting of repair kit: HC-CARGO 136856. Mounting Pin: HC-CARGO 210995, 210996.



210995 Mounting Pin Std pkg 1 Servicing: HC-CARGO 210867



OD: 13 mm  
Length: 70 mm

210996 Mounting Pin Std pkg 1 Servicing: HC-CARGO 210867



OD: 13 mm  
Length: 70 mm

## ADJUSTMENT TOOLS

090153 Test Kit Std pkg 1 Servicing: Opel, VAG, Ford, Volvo, (TDI), Japanese applications - Visit [www.hc-cargo.com](http://www.hc-cargo.com) for further information.

Contains: Micrometers O.D. 41 mm, 0.01-5 mm. Mount micrometer: length 38 mm. Extension for micrometer: length 42 mm. Extension for micrometer: length 101 mm. Extender w/ M8-1. Extension cradle M10-1. align tool (VAG). dorn (VAG).



## TEST INJECTION PIPES

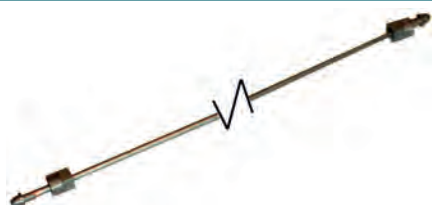

HC-CARGO	Std pkg	Screw device	Wall thicknes	Dim.
090255	Pkg. 1	12&14 mm	2 mm	6×2×600 mm
090257	Pkg. 1	14&14 mm	1.5 mm	6×3×600 mm
090292	Pkg. 1	14&14 mm	2.5 mm	8×3×600 mm

## SPECIAL TOOLS

**090133** Injector Tester Std pkg 1

Filter: HC-CARGO 090259. Quick Release Tool: HC-CARGO 090239.



Dim.: 200x516 mm  
 Piston cycle: 10.5  
 OD: 14 mm  
 Fuel cap: 3.2 l  
 Pressure: 0-40 mPa  
 Test quantity: 1600 mm<sup>2</sup>  
 Weight: 15 kg

**090239** Quick Release Tool Std pkg 1 Servicing: HC-CARGO 090133

Quik connector to the nozzle tester 12x1.5 mm/14x1.5 mm.



**090241** Wrench Std pkg 1 Servicing: Bosch VE pump, Audi, BMW - Visit [www.hc-cargo.com](http://www.hc-cargo.com) for further information.

For screwhead O.D. 7.5 mm.



**090269** Glow Plug Tool Std pkg 1

Tool set for the drilling of broken off CDI glow plugs M10-1. Contains: torx top E10, 3/8". Single-purpose drill w/ counterbore I.D. 9 mm turned from 5.4 to 4 mm (HC-CARGO 090273.) Special retainer for single-purpose drill. Drill and extraction housing for glow plugs locked.



**090273** Glow Plug Drill Std pkg 1 Servicing: HC-CARGO 090269

9 mm to 5.4 mm to 4 mm.



**090301** Extraction Tool Std pkg 1 Servicing: Universal - Visit [www.hc-cargo.com](http://www.hc-cargo.com) for further information.

Tool set for the drilling of broken off glow plugs M12-1.5. Contains: Torx top E10, 3/8". Single purpose drill w/ counterbore ID 10.75 mm turned from 6 to 5 mm drill and extraction housing for glow plugs locked in the hole. Screw tap HSSG UNF 1/4" DIN 351. Tool holder w/ long ratchet for M3-M8. Thread adaptor UNF 1/4": M16-1.5 w/ extraction nut. Bearing adaptor w/ bore ID 16 mm. Screw tap hmb M12-1.5 RSPI 354 plug tap.



**090349** Special Drill Std pkg 1 Servicing: HC-CARGO 090301

Single purpose drill w/ counterbore. I.D. 10.75 mm turned from 6 to 5 mm.



**090372** Hose Press Std pkg 1

Presses from 6-18 mm OD.



**090409** CR Return Flow Meter Std pkg 1

For measuring af back lift on CR nozzles.



## KIT

**090296** Extraction Tool Std pkg 1 Servicing: Mercedes CDI - Visit [www.hc-cargo.com](http://www.hc-cargo.com) for further information.

Contains: 1 threaded hole protector. 2 fork. 3 guidetubes. 4 short piston rods. 5 long piston rods. 6 press-on nuts. 7 handles. 8 proctive caps.



## SPARE PARTS

**090259** Glass Bowl Kit Std pkg 1 Servicing: HC-CARGO 090133



## WORKS AND TEST EQUIPMENT

### ANTIFREEZE HYDROMETERS

**210052** Antifreeze Tester Std pkg 1

Glykomat, for ethyleneglycol.



**210053** Antifreeze Tester Std pkg 1

*Gefo Coldomat, for ethyleneglycol.*



**BATTERY ACID HYDROMETERS**

**210134** Battery Acid Tester Std pkg 1



**REFRACTOMETERS**

**210771** Refractometer Std pkg 1 Servicing: G11, G12, G13 - Visit [www.hc-cargo.com](http://www.hc-cargo.com) for further information.

*Ethylene glycol, propylene glycol, battery liquid, windshield washer fluid.*



**TEST PLUGS**

**210054** Test Plug Std pkg 1

*The test lead makes it possible for one person alone to control the socket from the drivers seat.*



Length/test cable: 5 m

Plug type: 7, 12N, 12, 1724, 72577  
Test cable incl.: Yes

**210758** Test Plug Std pkg 1

Servicing: Commercial vehicles w/ w/o CAN-BUS/check control system - Visit [www.hc-cargo.com](http://www.hc-cargo.com) for further information.

*The test lead makes it possible for one person alone to control the socket from the drivers seat.*



Length/test cable: 5 m

Plug type: 13, 12, 11446, 72570, 7, 12N, 12, 1724, 72577, 7/13, Multicon, 12  
Can-Bus: Yes  
Test cable incl.: Yes

**210869** Test Plug Std pkg 1



Plug type: 7, 12N, 12, 1724, 72577

		EL. SPECIFICATIONS	DIMENSIONS	ADDITIONAL SPECIFICATIONS
<b>210871 Test Plug</b> Std pkg 1				Plug type: 13, 12, 11446, 72570
				
<b>210872 Test Plug</b> Std pkg 1				Plug type: 13, 12, 11446, 72570
<i>The test lead of 5 m allows one person to check the socket from the drivers seat.</i>			Length/test cable: 5 m	Test cable incl.: Yes
				
<b>211059 Adaptor</b> Std pkg 1		Servicing: HC-CARGO 211058 for check of 7 pole and 7/13 multicon sockets.		
				Plug type: 7/13, Multicon, 12, 7, 12N, 12, 1724, 72577
<b>W/LOAD</b>				
<b>211058 Trailer Socket Tester</b> Std pkg 1		Servicing: Commercial vehicles w/ w/o CAN-BUS/check control system - Visit <a href="http://www.hc-cargo.com">www.hc-cargo.com</a> for further information.		
<i>Accessories: HC-CARGO 211059.</i>			Length/test cable: 5 m	Plug type: 13, 12, 11446, 72570 Can-Bus: Yes Test cable incl.: Yes
				
<b>TRAILER LIGHT TESTER</b>				
<b>211113 Trailer Lighttester</b> Std pkg 1		Used for testing, faultfinding and repair of light installation of trailers, caravans and cars w/o CAN-BUS. Provided w/ built in battery and charger.		
			Dim.: 225x120 mm	Plug type: 7, 12, 1724, 72577 Colour: White Material: ABS plastic Can-Bus: No Warning lamp: w/ Batteries incl.: Yes
<b>211114 Trailer Light Tester</b> Std pkg 1		Testing of light installation on a trailer and caravans w/o CAN-BUS. w/ built-in battery. Comes w/ charger. 13 poles.		
			Dim.: 225x120 mm	Plug type: 13, 12, 4091, 72570 Colour: White Material: ABS plastic Can-Bus: No Warning lamp: w/ Batteries incl.: Yes



## OXYGEN SENSOR TESTER

210762 Oxygen Sensor Tester Std pkg 1

Shows if the oxygen sensor is active.



## BLADES

210699 Blades Std pkg 1



ID: 3.2 mm  
OD: 7.86 mm  
Thread: 0.4

## DIGITAL MULTIMETER

210977 Digital Multimeter Std pkg 1

3.5 digital LCD display. Battery: HC-CARGO 200742. Test Lead: HC-CARGO 210980.



Voltage/AC: 200V/600V  
Voltage/DC 1: 200mV/2/20  
/200/600 V  
Amp/DC: 0.2/2/20  
/200mA/15A  
Ohm: 200 hm/2/20 /200/2000  
KOhm

Dim.: 74x145x40 mm  
Reading/max: 1999

Colour: Black  
Material: Plastic  
HFE transistor: Yes  
Batteries incl.: Yes  
Battery check: Yes  
Diode check: Yes  
Test cable incl.: Yes  
Approval: CE

211065 AC/DC Clamp Multimeter Std pkg 1 Servicing: CE/LVD CAT III 600 V - Visit [www.hc-cargo.com](http://www.hc-cargo.com) for further information.

3 3/4 Digits compact clamp and multimeter for measuring ampere as well as DC & AC voltage. Test Lead: HC-CARGO 210980.



Voltage/AC: 4/40/400V  
/±1.0%, 40/400mV /600V±1.5%  
Amp/AC: 400A±2.0%, 1000A±2.5%  
Voltage/DC 1: 400 mV/4/40  
/400 V±0.5%, 40 mV/600 V±0.8%  
Amp/DC: 400A±1.5%, 1000A±2%  
Ohm: 400ohm/4/40 /400kohm  
/4Mohm±1.0%, 40Mohm±2%  
Frequency: 1Hz--10MHz±0.1%

Dim.: 220x64x35 mm  
Temp.: -20°C - +150°C  
Reading/max: 4000  
Capacity: 40nF±3%,  
400nF /4µF±2.5%,  
40µF±5%,  
400/4000µF±20%

Batteries incl.: Yes  
Battery check: Yes  
Diode check: Yes  
Continuity test: Yes  
Reading: Yes  
LCD display: Yes  
C°/F° selection: Yes  
Auto power off: Yes  
Approval: CE

211101 Smart Multimeter SD-5803 Std pkg 1

Test leads: HC-CARGO 210980. Fuse: HC-CARGO 192862.



Voltage/AC: 4/40/400V±0.8%,  
400mV/600V±1.2%  
Voltage/DC 1: 4/40/400  
V±0.5%, 600 V±0.8%  
Ohm: 400ohm/4/40 /400kohm/  
4Mohm±1%, 40Mohm±2%  
Frequency: 1Hz--500kHz±0.1%

Dim.: 152x78x33 mm  
Duty cycle: 0.1%--  
99.9±2.5%  
Temp.: 0°C - +40°C  
Reading/max: 4000  
Capacity: 40nF/400nF/  
4µF /40µF±3%, 400µF/  
4000µF±20%

Batteries incl.: Yes  
Diode check: Yes  
Continuity test: Yes  
Reading: Yes  
Test cable incl.: Yes  
LCD display: Yes  
Smart function: Yes  
Auto power off: Yes  
Approval: CE

211102 Smart Multimeter SD-5813 Std pkg 1

CE/LVD CAT III 500 V. Test cable: HC-CARGO 210980. Fuses: HC-CARGO 190285, 192861.



Voltage/AC: 4/40/400V±0.8%,  
400mV/500V±1.2%  
Amp/AC: 40/400mA±2.0%,  
4/10A±2.5%  
Voltage/DC 1: ±400 mV/4/40  
/400 V±0.5%, ± 500 V±0.8%  
Amp/DC: 40/400mA±1.2%,  
4/10A±2.0%  
Ohm: 400ohm/4/40 /400kohm/  
4Mohm±1.0%, 40Mohm±2.0%  
Frequency: 1Hz--500kHz±0.1%

Dim.: 165x83x37 mm  
RPM: (0-10.000RPM)±0.1%  
Duty cycle: 0.1%--  
99.9±2.0%  
Dwell angle: ±2%  
Temp.: -50°C - +150°C  
Reading/max: 4000  
Capacity: 40nF±3%,  
400nF /4µF±2.5%,  
40µF±5%,  
400/4000µF±20%

Batteries incl.: Yes  
Battery check: Yes  
Diode check: Yes  
Continuity test: Yes  
Reading: Yes  
Test cable incl.: Yes  
LCD display: Yes  
C°/F° selection: Yes  
Smart function: Yes  
Auto power off: Yes  
Approval: CE

**SPARE PARTS**
**210980** Test Lead      Std pkg 1      Servicing: HC-CARGO 210977, 211065, 211101, 211102

**INFRARED THERMOMETER**
**211128** Infrared Thermometer      Std pkg 1

*Used for measurement of surface temperatures which are not suitable for physical contact: 1. high voltage areas, 2. high temperature non-touchable objects. 3. moving objects.*

 Dim.: 153x101x143 mm  
 Temp.: -50°C - 380°C  
 (-58°F - 716°F)  
 Weight: 0.147 kg

 Colour: Yellow/black  
 Batteries incl.: No  
 Reading: Yes  
 LCD display: Yes  
 C°/F° selection: Yes  
 Auto power off: Yes

**ACCESSORIES**
**ALLIGATOR CLIPS**
**211013** Alligator Clip      Std pkg 10

*Connction for test probes.*

Amp: 5

 Jaw opening: 11  
 Length: 50 mm

 Type: Positive  
 Colour: Red

**211014** Alligator Clip      Std pkg 10

*Connction for test probes.*

Amp: 5

 Jaw opening: 11  
 Length: 50 mm

 Type: Negative  
 Colour: Black

**TEST BOX**
**210878** Tester      Std pkg 1      Servicing: Magneti Marelli, Ford - Visit [www.hc-cargo.com](http://www.hc-cargo.com) for further information.

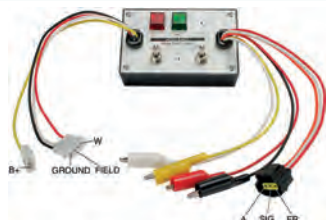
*To simulate the function of the vehicle computer.*

**211126** Alternator Tester      Std pkg 1      Servicing: BSS & LIN - Visit [www.hc-cargo.com](http://www.hc-cargo.com) for further information.

*To simulate the function of the vehicle computer.*

Voltage/DC 1: 12

**TEST LEAD**

**210845** Test Lead Std pkg 1 Servicing: Mitsubishi, Hitachi, Mazda - Visit [www.hc-cargo.com](http://www.hc-cargo.com) for further information.

For testing fo alternators w/ P-D terminals.

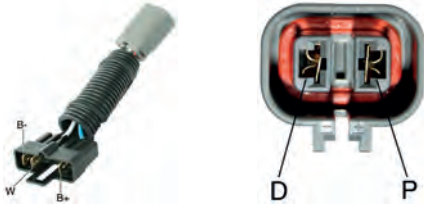

Plug type: 2

**210846** Alternator Test Lead Std pkg 1 Servicing: Denso - Visit [www.hc-cargo.com](http://www.hc-cargo.com) for further information.

For testing alternator w/ IG-S-L terminals.

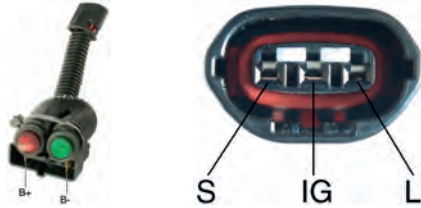

Plug type: 3

**REGULATOR TESTER**

**210649** Regulator Tester Std pkg 1

14 V and 28 V electronic and mechanical regulators can be tested independently of positive or negative grounded field. Tests lamp relays and can be used as digital voltmeter effective range 0-200 V. Adjustable field load of 0.5 amp or 3.0 amp. Instructions for use according to manual. Service voltage 230/240 V. AC. 50/60 Hz.



**SLIDING GAUGE**

**211045** Vernier Gauge Std pkg 1

Jaw L. 40 mm. Reading 0.05 mm.



Length: 150 mm  
Measuring range: 0-150

**BATTERY CHARGERS**

**211035** Battery Charger Std pkg 1



Voltage: 6-12  
Amp: 1.5-3

Weight: 1.550 kg

Auto stop: No  
Approvals: CE

**211036** Battery Charger Std pkg 1



Voltage: 12-24  
Amp: 4-8

Weight: 4.230 kg

Auto stop: No  
Approvals: CE

**211073 Auto/Manual Charger** Std pkg 1

230 V. AC.

 Voltage: 12-24  
Amp: 8

Weight: 4.950 kg

 Auto stop: Yes  
Approvals: CE

**SPARE PARTS**
**211077 Test Connection** Std pkg 1

Plug type: RCA

**BATTERY TESTER**
**211040 Battery Tester** Std pkg 1

Voltage: 12-24

Weight: 0.124 kg

**211041 Battery Tester** Std pkg 1

*Easy to read digital display.*

Voltage: 12/24

Weight: 0.070 kg

**211103 Battery Tester** Std pkg 1

*Heavy duty copper plated clamps and nickel/chrome plated steel case.*

 Voltage: 6-12  
Amp: 0-100

Protection degree: Amp

**211124 Battery/Starting/  
Charging System Analyzer** Std pkg 1

*Functions: 1. Check of battery condition. 2. Check of the cold cranking amps of the battery. 3 Check of the starting system. 4. Check of the charging system.*

 Voltage: 12  
Amp/hour: 25-  
200

Weight: 0.18 kg



Approvals: CE

**CIRCUIT TESTER**
**210212 Circuit Tester** Std pkg 1

*Bulb (18 V, 3 W): HC-CARGO 170643.*

Voltage/DC: 6-24

 Material: Chromed brass  
Alternativ no.: 211153

	EL. SPECIFICATIONS	DIMENSIONS	ADDITIONAL SPECIFICATIONS
<b>211042</b> Circuit Tester <span style="float: right;">Std pkg 1</span> 	Voltage/DC: 2.8-48	Dim.: 160x22x16 mm Weight: 0.027 kg	
<b>211083</b> Power Probe II <span style="float: right;">Std pkg 1</span> <i>Features: testing of polarity and continuity. Activating components by post. or neg. voltage. Tester trailer lights and connections. Locate short-circuits. Rocker switch: HC-CARGO 211123.</i>	Voltage/DC: 6-24	Length/test cable: 6 m	Test cable incl.: Yes
<b>211094</b> Circuit Tester <span style="float: right;">Std pkg 1</span> 	Voltage: 6/12		
<b>211119</b> Circuit Tester <span style="float: right;">Std pkg 1</span> 	Voltage/DC: 3-48		Warning lamp: w/
<b>211122</b> Circuit Tester <span style="float: right;">Std pkg 1</span> <i>Computersafe wire 1.20 m w/ alligator clips.</i>	Voltage/DC 1: 6-12		Warning lamp: w/
<b>211153</b> Circuit Tester <span style="float: right;">Std pkg 1</span> <i>Bulb (18 V, 3 W): HC-CARGO 170643.</i>	Voltage/DC 1: 6-24		Material: Chromed brass Alternativ no.: 210212
<b>W/VOLTMETER</b>			
<b>211097</b> Circuit Tester <span style="float: right;">Std pkg 1</span> <i>Features: test light. Short circuit indicator. Continuity tester. Indicator for poor ground connection. Short circuit protection. Voltmeter. 6 m cable. Rocker Switch HC-CARGO 211123. Power Probe: HC-CARGO 211118.</i>	Voltage/DC 1: 12-24		Colour: Red

**SPARE PARTS**
**170643** Bulb Pinol      Std pkg 10      Servicing: HC-CARGO 210212, 210212Z, 211153

 Voltage: 18  
 Watt: 3

**211123** Rocker Switch      Std pkg 1      Servicing: HC-CARGO 211083, 211097

Voltage: 12/24

 Type/terminal: Flat  
 No./terminals: 3

**ACCESSORIES**
**211117** Lead Set      Std pkg 1

*Contains: 1-3-6 ft. stackable leads. Banana jack adapter. Large piercing probe. Small piercing probe. Alligator clip adapter. Case w/organizer. Probe tip. Male/male adapter. Female/female adapter.*

**211118** Power Probe      Std pkg 1      Servicing: HC-CARGO 211097













*Tip. 3".*















**SHORT CIRCUIT SEEKER**
**211091** Short Circuit Seeker      Std pkg 1

*The ECT 2000 makes locating short and open circuits easier than ever before. Its advanced digital intelligence puts it above all others. The ECT 2000 detects and alerts you immediately whether a circuit is shorted or open.*

**A/C PARTS**
**VALVE CORE**
**211027** Valve Core Tool      Std pkg 1

**211028** Valve Core Tool      Std pkg 1

BITS 1/4"					
SLOTTED					
39 mm					
	HC-CARGO	Std pkg	Size	Length	
 	210708	Pkg. 10	5.5x1 mm	39 mm	
	210709	Pkg. 10	8x1.2 mm	39 mm	
	210710	Pkg. 10	8x1.6 mm	39 mm	
PH					
25 mm					
	HC-CARGO	Std pkg	Type	Length	
 	210759	Pkg. 10	2	25 mm	
	210712	Pkg. 10	3	25 mm	
32 mm					
	HC-CARGO	Std pkg	Type	Length	
 	210713	Pkg. 1	4	32 mm	
	210744	Pkg. 10	4	32 mm	
50 mm					
	HC-CARGO	Std pkg	Type	Length	
 	210750	Pkg. 10	1	50 mm	
	210853	Pkg. 10	2	50 mm	
	210751	Pkg. 10	3	50 mm	
PZ					
25 mm					
	HC-CARGO	Std pkg	Type	Length	
 	210859	Pkg. 10	1	25 mm	
	210860	Pkg. 10	2	25 mm	
	210715	Pkg. 10	3	25 mm	
	210716	Pkg. 1	4	32 mm	
50 mm					
	HC-CARGO	Std pkg	Type	Length	
 	210740	Pkg. 10	2	50 mm	
TORX					
25 mm					
	HC-CARGO	Std pkg	Type	Length	
 	210718	Pkg. 10	T06	25 mm	
	210720	Pkg. 10	T08	25 mm	
	210722	Pkg. 10	T10	25 mm	
	210723	Pkg. 10	T15	25 mm	
	210724	Pkg. 10	T20	25 mm	
	210725	Pkg. 10	T25	25 mm	
	210726	Pkg. 10	T27	25 mm	
	210727	Pkg. 10	T30	25 mm	

W/ BORING						
	HC-CARGO	Std pkg	Type	Length		
 	210729	Pkg. 10	T40	25 mm		
HEX						
	HC-CARGO	Std pkg	Type	Length		
 	210752	Pkg. 1	3	50 mm		
	210753	Pkg. 1	4	50 mm		
	210754	Pkg. 1	5	50 mm		
BIT HOLDER						
W/RETAINING RING						
	HC-CARGO	Std pkg	Size	Length		
 	210755	Pkg. 1	57x6.3 mm	57 mm		
MAGNETIC						
	HC-CARGO	Std pkg	Size	Length		
 	210757	Pkg. 1	75x6.3 mm	75 mm		
BITS 5/16"						
SLOTTED						
	HC-CARGO	Std pkg	Size	Length		
 	210741	Pkg. 1	12x2 mm	41 mm		
PH						
	HC-CARGO	Std pkg	Type	Length		
 	210742	Pkg. 10	2	32 mm		
	210743	Pkg. 10	3	32 mm		
TORX						
	HC-CARGO	Std pkg	Type	Length		
 	210745	Pkg. 1	T25	35 mm		
	210747	Pkg. 1	T45	35 mm		
	210905	Pkg. 1	T40	35 mm		
	210748	Pkg. 1	T50	35 mm		
FASTENING PARTS						
TAPPING SCREWS						
POZIDRIV						
FLAT HEAD W/GIMLET POINT						
	HC-CARGO	Std pkg	Dim.	Spanner size	ISO norm	DIN norm
	192122	Pkg. 200	4.2x13 mm	8	7050	7982
	192123	Pkg. 200	4.8x16 mm	8	7050	7982



PAN HEAD						
	HC-CARGO	Std pkg	Dim.	Spanner size	ISO norm	DIN norm
	192006	Pkg. 200	2.9x9.5 mm	4	7049	7981C
	191753	Pkg. 200	2.9x16 mm	4	7049	7981C
	191798	Pkg. 200	2.9x19 mm	4	7049	7981C
	190360	Pkg. 500	3.5x9.5 mm	6	7049	7981C
	190361	Pkg. 200	3.5x16 mm	6	7049	7981C
	190362	Pkg. 200	3.5x19 mm	6	7049	7981C
	190366	Pkg. 200	4.2x9.5 mm	8	7049	7981C
	192554	Pkg. 200	4.2x13 mm	8	7049	7981C
	190367	Pkg. 200	4.2x16 mm	8	7049	7981C
	190368	Pkg. 200	4.2x19 mm	8	7049	7981C
	190371	Pkg. 200	4.2x25 mm	8	7049	7981C
	190373	Pkg. 200	4.8x19 mm	10	7049	7981C
	PAN HEAD W/GIMLET POINT					
	HC-CARGO	Std pkg	Dim.	Spanner size	ISO norm	DIN norm
	192114	Pkg. 200	3.5x13 mm	6	7049	7981
	190372	Pkg. 200	4.8x13 mm	10	7049	7981C
HEX W/FLANGE						
	HC-CARGO	Std pkg	Dim.	Spanner size	DIN norm	
	191988	Pkg. 100	6.3x19 mm	10 mm	7976C	
HEX SCREWS FULLY THREADED EL-PLATED						
	HC-CARGO	Std pkg	Dim.	Spanner size	ISO norm	DIN norm
	192508	Pkg. 500	M4x14 mm	7 mm	4017	933
	191293	Pkg. 200	M4x25 mm	7 mm	4017	933
	192588	Pkg. 200	M5x6 mm	8 mm	4017	933
	192753	Pkg. 200	M5x10 mm	8 mm	4017	933
	192255	Pkg. 200	M5x12 mm	8 mm	4017	933
	191789	Pkg. 200	M5x14 mm	8 mm	4017	933
	190469	Pkg. 200	M5x16 mm	8 mm	4017	933
	190470	Pkg. 200	M5x20 mm	8 mm	4017	933
	190474	Pkg. 200	M5x40 mm	8 mm	4017	933
	191615	Pkg. 200	M5x50 mm	8 mm	4017	933
	191644	Pkg. 200	M6x10 mm	10 mm	4017	933
	192418	Pkg. 200	M6x12 mm	10 mm	4017	933
	190477	Pkg. 200	M6x16 mm	10 mm	4017	933
	190478	Pkg. 200	M6x20 mm	10 mm	4017	933
	190479	Pkg. 200	M6x25 mm	10 mm	4017	933
	190480	Pkg. 200	M6x30 mm	10 mm	4017	933
	192063	Pkg. 200	M6x35 mm	10 mm	4017	933
	190482	Pkg. 200	M6x40 mm	10 mm	4017	933
	191536	Pkg. 100	M6x45 mm	10 mm	4017	933
	191854	Pkg. 200	M6x50 mm	10 mm	4017	933
	191645	Pkg. 200	M6x65 mm	10 mm	4017	933
	191804	Pkg. 200	M6x90 mm	10 mm	4017	933

	HC-CARGO	Std pkg	Dim.	Spanner size	ISO norm	DIN norm
	190492	Pkg. 200	M8×16 mm	13 mm	4017	933
	190493	Pkg. 200	M8×20 mm	13 mm	4017	933
	190494	Pkg. 200	M8×25 mm	13 mm	4017	933
	190495	Pkg. 200	M8×30 mm	13 mm	4017	933
	192251	Pkg. 200	M8×40 mm	13 mm	4017	933
	192752	Pkg. 100	M10×12 mm	17 mm	4017	933
	190506	Pkg. 200	M10×30 mm	17 mm	4017	933
	190508	Pkg. 200	M10×40 mm	17 mm	4017	933
	192248	Pkg. 200	M10×50 mm	17 mm	4017	933
	192407	Pkg. 200	M12×50 mm	19 mm	4017	933
	192404	Pkg. 100	1/4" UNF×7/8"	7/16"	4017	933
	192365	Pkg. 200	UNC 1/4"×3/4"	7/16"	4017	933
	192778	Pkg. 200	UNC 5/16"×3/4"	1/2"	4017	933

### EL-PLATED W/ESLOK

	HC-CARGO	Std pkg	Dim.	Spanner size	ISO norm	DIN norm
	191900	Pkg. 200	M5×16 mm	8 mm	4017	933

### PARTLY THREADED

#### EL-PLATED

	HC-CARGO	Std pkg	Dim.	Spanner size	ISO norm	DIN norm
	191294	Pkg. 200	M6×80 mm	10 mm	4014	931
	190499	Pkg. 200	M8×50 mm	13 mm	4014	931
	190500	Pkg. 200	M8×60 mm	13 mm	4014	931
	192252	Pkg. 200	M8×70 mm	13 mm	4014	931
	192253	Pkg. 200	M8×80 mm	13 mm	4014	931
	192071	Pkg. 200	M8×100 mm	13 mm	4014	931
	190510	Pkg. 100	M10×50 mm	17 mm	4014	931
	190511	Pkg. 200	M10×60 mm	17 mm	4014	931
	192249	Pkg. 200	M10×70 mm	17 mm	4014	931
	192250	Pkg. 200	M10×80 mm	17 mm	4014	931

### FLANGE

	HC-CARGO	Std pkg	HC-CARGO	Std pkg	Dim.	Spanner size	DIN norm
	191325	Pkg. 200	B191325	Pkg. 4000	M4×8 mm	7 mm	6921
	191326	Pkg. 200	B191326	Pkg. 2000	M4×10 mm	7 mm	6921
			B192519	Pkg. 3000	M4×12 mm	7 mm	6921
	191327	Pkg. 200	B191327	Pkg. 2000	M4×12 mm	7 mm	6921
			B191328	Pkg. 2000	M4×14 mm	7 mm	6921
	191329	Pkg. 200	B191329	Pkg. 2000	M4×16 mm	7 mm	6921
	191330	Pkg. 200	B191330	Pkg. 2000	M4×18 mm	7 mm	6921
			B191651	Pkg. 2000	M4×20 mm	7 mm	6921
	191514	Pkg. 200	B191514	Pkg. 4000	M4×28 mm	7 mm	6921
	191545	Pkg. 100			M5×12 mm	8 mm	6921
	191546	Pkg. 100			M5×16 mm	8 mm	6921
			B191867	Pkg. 2000	M5×20 mm	8 mm	6921
	191772	Pkg. 100			M5×25 mm	7 mm	6921
			B191792	Pkg. 2000	M5×30 mm	8 mm	6921
	192416	Pkg. 100			M6×10 mm	10 mm	6921
	192425	Pkg. 100			M6×20 mm	10 mm	6921
	191987	Pkg. 100			M8×16 mm	13 mm	6921

### W/ ESLOK

	HC-CARGO	Std pkg	Dim.	Spanner size	DIN norm
	192563	Pkg. 200	M4×8 mm	7 mm	6921
	192564	Pkg. 200	M4×10 mm	7 mm	6921
	192565	Pkg. 200	M4×14 mm	7 mm	6921
	192567	Pkg. 200	M5×12 mm	8 mm	6921
	192568	Pkg. 200	M5×16 mm	8 mm	6921

W/SPRING WASHER					
	HC-CARGO	Std pkg	Dim.	Spanner size	
	192536	Pkg. 100	M5×20 mm	7 mm	
	192550	Pkg. 100	M5×20 mm	7 mm	
MACHINE SCREWS					
POZIDRIV					
FLAT HEAD					
	HC-CARGO	Std pkg	Dim.	ISO norm	DIN norm
	191643	Pkg. 200	M4×18 mm	7046	965
	B192569	Pkg. 1000	M4×18 mm	7046	965
	B191643	Pkg. 2000	M4×18 mm	7046	965
	190561	Pkg. 200	M4×20 mm	7046	965
	B191533	Pkg. 2000	M4×22 mm	7046	965
	191533	Pkg. 200	M4×22 mm	7046	965
	191322	Pkg. 200	M4×25 mm	7046	965
	191323	Pkg. 200	M4×30 mm	7046	965
	191678	Pkg. 200	M5×16 mm	7046	965
	191435	Pkg. 200	M5×35 mm	7046	965
	192822	Pkg. 200	M6×10 mm	7046	965
	191763	Pkg. 200	M6×20 mm	7046	965
	192347	Pkg. 100	M6×30 mm	7046	965
	PAN HEAD				
	HC-CARGO	Std pkg	Dim.	ISO norm	DIN norm
	191266	Pkg. 200	M3×5 mm	7045	7985
	190531	Pkg. 200	M3×10 mm	7045	7985
	192413	Pkg. 200	M3×16 mm	7045	7985
	192254	Pkg. 500	M3×20 mm	7045	7985
	191586	Pkg. 200	M4×6 mm	7045	7985
	191770	Pkg. 200	M4×8 mm	7045	7985
	190536	Pkg. 200	M4×10 mm	7045	7985
	190537	Pkg. 200	M4×12 mm	7045	7985
	191317	Pkg. 200	M4×14 mm	7045	7985
	190538	Pkg. 200	M4×16 mm	7045	7985
	191318	Pkg. 200	M4×18 mm	7045	7985
	190539	Pkg. 200	M4×20 mm	7045	7985
	192586	Pkg. 200	M4×22 mm	7045	7985
	190540	Pkg. 200	M4×25 mm	7045	7985
	190541	Pkg. 200	M4×30 mm	7045	7985
	190542	Pkg. 200	M4×40 mm	7045	7985
	191319	Pkg. 200	M5×6 mm	7045	7985
	191554	Pkg. 200	M5×8 mm	7045	7985
	190544	Pkg. 500	M5×10 mm	7045	7985
	192145	Pkg. 200	M5×12 mm	7045	7985
	192065	Pkg. 200	M5×16 mm	7045	7985
	192046	Pkg. 200	M5×20 mm	7045	7985
	192216	Pkg. 200	M5×25 mm	7045	7985
	190549	Pkg. 200	M5×30 mm	7045	7985
	192444	Pkg. 100	M5×35 mm	7045	7985
	190550	Pkg. 200	M5×40 mm	7045	7985
	191762	Pkg. 200	M5×45 mm	7045	7985
	190551	Pkg. 200	M5×50 mm	7045	7985
	191267	Pkg. 200	M5×60 mm	7045	7985
	192676	Pkg. 100	M6×8 mm	7045	7985
	190552	Pkg. 200	M6×10 mm	7045	7985
	190556	Pkg. 200	M6×25 mm	7045	7985
190558	Pkg. 200	M6×40 mm	7045	7985	
191624	Pkg. 100	M6×45 mm	7045	7985	
192704	Pkg. 200	M6×50 mm	7045	7985	

### PAN HEAD W/ESLOK

	HC-CARGO	Std pkg	Dim.	ISO norm	DIN norm
	192569	Pkg. 100	M4×18 mm	7046	965
	192571	Pkg. 200	M4×22 mm	7046	965

### PAN HEAD W/WASHER

	HC-CARGO	Std pkg	Dim.
	191478	Pkg. 100	M4×25 mm
	B192572	Pkg. 1000	M4×25 mm
	B191478	Pkg. 5000	M4×25 mm

### THRU BOLTS

	HC-CARGO	Std pkg	Dim.	Thread length
	B230731	Pkg. 100	M5×65.3 mm	21.7 mm
	191899	Pkg. 20	M5×90 mm	35 mm
	191528	Pkg. 20	M5×95 mm	30 mm
	191582	Pkg. 20	M5×100 mm	60 mm
	B191582	Pkg. 100	M5×100 mm	60 mm
	191873	Pkg. 20	M5×120 mm	60 mm
	191584	Pkg. 20	M5×125 mm	60 mm
	191585	Pkg. 20	M5×138.7 mm	61.2 mm
	191530	Pkg. 10	M6×79 mm	24.6 mm
	191531	Pkg. 10	M6×89.4 mm	25.3 mm
	191558	Pkg. 20	M6×95 mm	30 mm

### TORX

#### FLAT HEAD

192754 Hex Screw

Std pkg 100



Length: 12 mm  
Thread: M8

Head type: Flat head  
Screw type: Torx  
ISO norm: 14581

### SLOTTED

#### CHEESE HEAD

	HC-CARGO	Std pkg	Dim.	ISO norm	DIN norm
	191320	Pkg. 200	M5×8 mm	1207	84A
	190545	Pkg. 200	M5×12 mm	1207	84A
	191505	Pkg. 200	M5×14 mm	1207	84A
	190546	Pkg. 200	M5×16 mm	1207	84A
	190547	Pkg. 200	M5×20 mm	1207	84A
	191557	Pkg. 200	M5×25 mm	1207	84A
	191321	Pkg. 200	M6×12 mm	1207	84A
	190555	Pkg. 200	M6×20 mm	1207	84A
	192515	Pkg. 200	M6×22 mm	1207	84A

#### CHEESE HEAD, PHILLIPS

	HC-CARGO	Std pkg	Dim.	ISO norm
	192984	Pkg. 200	M4×30 mm	7048
	192364	Pkg. 200	M4×35 mm	7048

FLANGE						
	HC-CARGO	Std pkg	Dim.			
	191658	Pkg. 200	M4×6 mm			
	191677	Pkg. 200	M4×8 mm			
	191661	Pkg. 200	M5×10 mm			
	191790	Pkg. 200	M5×12 mm			
	191659	Pkg. 100	M5×6 mm			
	191660	Pkg. 200	M5×8 mm			
SOCKET HEAD CAPS						
FULLY THREADED						
	HC-CARGO	Std pkg	Dim.	Quality	ISO norm	DIN norm
	192672	Pkg. 100	M4×10 mm	12.9	4762	912
	191486	Pkg. 100	M5×14 mm	12.9	4762	912
	192414	Pkg. 100	M5×16 mm	10.9	7380	912
	191613	Pkg. 100	M5×20 mm	12.9	4762	912
	192440	Pkg. 100	M5×25 mm	12.9	4762	912
	192405	Pkg. 100	M5×45 mm	12.9	4762	912
	192591	Pkg. 100	M6×16 mm	12.9	4762	912
	191614	Pkg. 100	M6×20 mm	12.9	4762	912
	192592	Pkg. 100	M6×25 mm	12.9	4762	912
	192594	Pkg. 100	M6×50 mm	12.9	4762	912
	192790	Pkg. 1	M7×50 mm	12.9	4762	912
	PARTLY THREADED					
	HC-CARGO	Std pkg	Dim.	Thread length	Quality	
	192073	Pkg. 100	M5×55 mm	22 mm	12.9	
	192441	Pkg. 100	M5×60 mm	22 mm	12.9	
	191539	Pkg. 20	M5×75 mm	25 mm	12.9	
THREAD FORMING						
PAN HEAD						
	HC-CARGO	Std pkg	Dim.	Torx	DIN norm	
	192727	Pkg. 500	M4×16 mm	T20	7500	
	192725	Pkg. 100	M4×10 mm	T20	7500	
NUTS						
HEX						
STEEL, DIN 934						
	HC-CARGO	Std pkg	Thread	Spanner size	DIN norm	
	190520	Pkg. 200	M3	5.5 mm	934	
	190521	Pkg. 200	M4	7 mm	934	
	190779	Pkg. 200	M5	8 mm	934	
	190780	Pkg. 200	M6	10 mm	934	
	190781	Pkg. 200	M7	11 mm	934	
	190782	Pkg. 200	M8	13 mm	934	
	191898	Pkg. 25	M10	14 mm	934	
	190783	Pkg. 200	M10	17 mm	934	
	191297	Pkg. 200	M12-1.25	19 mm	934	
	191296	Pkg. 200	M12-1.5	19 mm	934	
	191477	Pkg. 200	M12	19 mm	934	
	191298	Pkg. 200	M14-1.5	22 mm	934	
	191299	Pkg. 200	M16-1.5	24 mm	934	
	191754	Pkg. 200	M17-1.5	27 mm	934	
	192127	Pkg. 200	UNC 1/4"	7/16"	934	

## STEEL, DIN 439B

	HC-CARGO	Std pkg	Thread	Spanner size	ISO norm	DIN norm
	191302	Pkg. 200	M5	8 mm	4035	439B
	191303	Pkg. 500	M6	10 mm	4035	439B
	191304	Pkg. 200	M8	13 mm	4035	439B
	191305	Pkg. 200	M10	17 mm	4035	439B
	191439	Pkg. 200	M12	19 mm	4035	439B
	192228	Pkg. 100	M14-1.5	22 mm	4035	439B
	191657	Pkg. 100	M16-1.5	24 mm	4035	439B

## SELF-LOCKING W/NYLON

	HC-CARGO	Std pkg	Thread	Spanner size	DIN norm
	190524	Pkg. 200	M5	8 mm	985-6
	190525	Pkg. 200	M6	10 mm	985-6
	190527	Pkg. 200	M8	13 mm	985-6
	190528	Pkg. 200	M10	17 mm	985-6
	192143	Pkg. 200	M12	19 mm	985-6

## SELF-LOCKING W/FLANGE

	HC-CARGO	Std pkg	HC-CARGO	Std pkg	Thread	Spanner size
	191306	Pkg. 200	B191306	Pkg. 5000	M4	7 mm
	191307	Pkg. 200	B191307	Pkg. 5000	M5-0.8	8 mm
	191308	Pkg. 200	B191308	Pkg. 3000	M6	10 mm
	191513	Pkg. 200	B191513	Pkg. 2000	M8	13 mm

## COUPLING

	HC-CARGO	Std pkg	Thread	Spanner size
	192417	Pkg. 200	M6	10 mm
	192072	Pkg. 200	M8	13 mm

## THREADED SPACERS

191580 Threaded Spacer Std pkg 100

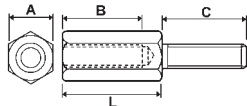

A: 7 mm  
B: M4x9 mm  
C: M4x8 mm  
L: 12 mm  
Coating: Electro galvanized

Thread type: Inner & Outer  
Material: Steel

191625 Threaded Spacer Std pkg 10

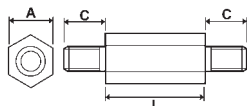

A: 8 mm  
C: M5x10 mm  
L: 40 mm  
Coating: Electro galvanized

Thread type: External  
Material: Steel

191626 Threaded Spacer Std pkg 100

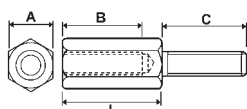

A: 8 mm  
B: M5x9 mm  
C: M4x10 mm  
L: 12 mm  
Coating: Electro galvanized

Thread type: Inner & Outer  
Material: Steel

## FLAME ARRESTERS

### COPPER

	HC-CARGO	Std pkg	ID	OD	Thickness
	080696	Pkg. 10	6.2 mm	9.8 mm	1 mm
	080456	Pkg. 10	6.8 mm	14.5 mm	1 mm
	080689	Pkg. 10	7 mm	11 mm	1.5 mm
	080403	Pkg. 10	7 mm	15 mm	6.7 mm
	080439	Pkg. 10	7.2 mm	20 mm	1.5 mm
	080412	Pkg. 10	7.3 mm	14 mm	4 mm
	080410	Pkg. 10	7.3 mm	14 mm	4.8 mm
	080691	Pkg. 10	7.35 mm	14.95 mm	1.5 mm
	080739	Pkg. 10	7.4 mm	13.8 mm	1.55 mm
	081068	Pkg. 10	7.4 mm	14.95 mm	1.96 mm
	081067	Pkg. 5	7.4 mm	14.95 mm	1.76 mm
	081209	Pkg. 10	7.5 mm	15 mm	2 mm
	081114	Pkg. 10	7.5 mm	15 mm	3 mm
	080425	Pkg. 10	7.5 mm	15 mm	2 mm
	081113	Pkg. 10	7.6 mm	13 mm	2.5 mm
	081212	Pkg. 10	7.6 mm	17 mm	3.5 mm
	080397	Pkg. 20	7.7 mm	20 mm	2.7 mm
	081115	Pkg. 10	7.75/7.15 mm	15 mm	1.5 mm
	081173	Pkg. 10	7.75/7 mm	15.1 mm	2 mm
	080417	Pkg. 20	7.8 mm	10.8 mm	1.5 mm
	081055	Pkg. 10	7.8 mm	14.95 mm	1.56 mm
	080427	Pkg. 10	8 mm	15 mm	2 mm
	080426	Pkg. 10	8 mm	15 mm	1 mm
	080803	Pkg. 10	8.3 mm	12.9 mm	2.5 mm
	080454	Pkg. 10	9.5 mm	22.5 mm	0.4 mm
	080692	Pkg. 10	9.75 mm	18.7 mm	2 mm
	080428	Pkg. 10	10 mm	15 mm	2 mm
	080431	Pkg. 10	10 mm	16.3 mm	1.5 mm
	080433	Pkg. 10	10 mm	18 mm	1.5 mm
	080432	Pkg. 10	10 mm	18 mm	1 mm
	080438	Pkg. 10	10 mm	19 mm	0.3 mm
	080436	Pkg. 10	10 mm	19 mm	2 mm
	080443	Pkg. 10	10 mm	20 mm	2 mm
	080442	Pkg. 10	10 mm	20 mm	1.5 mm
	080441	Pkg. 10	10 mm	20 mm	1 mm
	080440	Pkg. 10	10 mm	20 mm	0.5 mm
	080296	Pkg. 10	10 mm	21 mm	1 mm
	080453	Pkg. 10	10 mm	22 mm	1 mm
	080452	Pkg. 10	10 mm	22 mm	0.7 mm
	080402	Pkg. 20	11 mm	17.5 mm	5.4 mm
	080434	Pkg. 10	12 mm	18 mm	2 mm
	080705	Pkg. 10	12.3 mm	17.9 mm	1.4 mm
	080444	Pkg. 10	14 mm	20 mm	1.8 mm
	080447	Pkg. 10	14 mm	20 mm	2.5 mm
	080446	Pkg. 10	14.3 mm	20 mm	2 mm
	080734	Pkg. 10	14.4 mm	20.8 mm	1.4 mm
	080430	Pkg. 10	14.5 mm	21 mm	1.5 mm
	080688	Pkg. 10	14.5 mm	22.5 mm	1.4 mm
	080435	Pkg. 10	15 mm	18 mm	0.5 mm
	080448	Pkg. 10	15.3 mm	20 mm	2 mm
	080802	Pkg. 10	15.6 mm	21.2 mm	2.25 mm
	080763	Pkg. 10	15.7 mm	20.5 mm	2 mm
	080761	Pkg. 10	17 mm	20 mm	1.5 mm
	080777	Pkg. 10	17.1 mm	21.2 mm	1.7 mm
	080450	Pkg. 10	17.5 mm	21.5 mm	1.5 mm

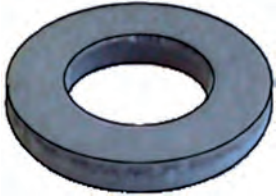

## FIBER

	HC-CARGO	Std pkg	ID	OD	Thickness
	080031	Pkg. 10	5 mm	9.5 mm	2 mm
	080035	Pkg. 100	12 mm	18 mm	1.5 mm
	134768	Pkg. 10	15 mm	22 mm	2 mm
	080033	Pkg. 100	15 mm	8 mm	1.5 mm

## STEEL

	HC-CARGO	Std pkg	ID	OD	Thickness
	080404	Pkg. 25	4.9 mm	11.5 mm	1.25 mm
	080408	Pkg. 25	5.2 mm	13.9 mm	1.1 mm
	080390	Pkg. 20	5.5 mm	20.15 mm	3.5 mm
	080407	Pkg. 25	6.4 mm	13.9 mm	1.7 mm
	080388	Pkg. 25	7.3 mm	13.6 mm	1.3 mm
	080398	Pkg. 20	7.3 mm	13.8 mm	1.4 mm
	080423	Pkg. 10	7.6 mm	20.3 mm	2.5 mm
	080736	Pkg. 20	7.9 mm	20 mm	2.85 mm
	080449	Pkg. 10	9.3 mm	20.5 mm	2.6 mm
	080732	Pkg. 20	10.1 mm	20 mm	2.6 mm

## ALUMINIUM

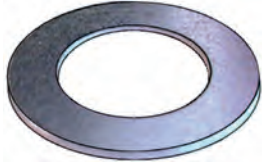
	HC-CARGO	Std pkg	ID	OD	Thickness
	080437	Pkg. 10	10 mm	19 mm	0.3 mm

## BRASS

	HC-CARGO	Std pkg	ID	OD	Thickness
	080236	Pkg. 10	7.1 mm	13.4 mm	1.1 mm
	080405	Pkg. 25	7.1 mm	13.8 mm	1.3 mm
	080406	Pkg. 25	8.5 mm	14.3 mm	1.1 mm
	080419	Pkg. 25	8.8 mm	14 mm	1.3 mm
	080424	Pkg. 10	10.8 mm	17.5 mm	1.7 mm
	080418	Pkg. 10	12.6 mm	18 mm	2.5 mm

## WASHERS

### FLAT STEEL

	HC-CARGO	Std pkg	ID	OD	Thickness	Material
	190587	Pkg. 200	3.5 mm	9.5 mm	0.8 mm	Steel
	190588	Pkg. 200	4.3 mm	9.5 mm	0.8 mm	Steel
	191506	Pkg. 200	5.3 mm	10 mm	1 mm	Steel
	192667	Pkg. 200	5.3 mm	12 mm	1 mm	Steel
	191502	Pkg. 200	5.3 mm	9 mm	1 mm	Steel
	190589	Pkg. 200	5.5 mm	12.7 mm	1 mm	Steel
	192695	Pkg. 200	6.4 mm	25 mm	1.8 mm	Steel
	191290	Pkg. 200	6.5 mm	13 mm	1 mm	Steel
	190590	Pkg. 200	6.8 mm	16 mm	1.1 mm	Steel
	190591	Pkg. 200	7.4 mm	14 mm	1.6 mm	Steel
	190592	Pkg. 200	8.4 mm	18 mm	1.25 mm	Steel
	192696	Pkg. 200	8.4 mm	30 mm	2 mm	Steel
	193025	Pkg. 100	10 mm	16 mm	0.25 mm	Steel
	192362	Pkg. 100	10 mm	16 mm	1 mm	Steel
	191337	Pkg. 100	10 mm	16 mm	0.5 mm	Steel
190593	Pkg. 100	10 mm	21 mm	1.25 mm	Steel	

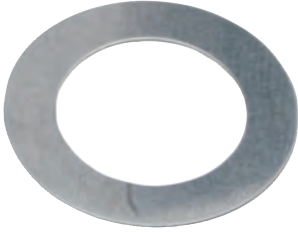

	HC-CARGO	Std pkg	ID	OD	Thickness	Material
	192124	Pkg. 100	11 mm	17 mm	1 mm	Steel
	191503	Pkg. 100	11.5 mm	19 mm	1.5 mm	Steel
	192062	Pkg. 200	12 mm	18 mm	0.5 mm	Steel
	192363	Pkg. 100	12 mm	18 mm	0.3 mm	Steel
	191491	Pkg. 100	12 mm	18 mm	1 mm	Steel
	192245	Pkg. 100	12 mm	22 mm	0.5 mm	Steel
	191457	Pkg. 100	13 mm	19 mm	0.5 mm	Steel
	190594	Pkg. 100	13 mm	24 mm	2.5 mm	Steel
	192585	Pkg. 100	14 mm	26 mm	0.3 mm	Steel
	191335	Pkg. 100	14 mm	26 mm	0.5 mm	Steel
	191548	Pkg. 100	15 mm	22 mm	0.5 mm	Steel
	191538	Pkg. 100	15 mm	22 mm	1 mm	Steel
	191868	Pkg. 100	15 mm	22 mm	0.1 mm	Steel
	191487	Pkg. 100	16 mm	28 mm	0.5 mm	Steel
	191560	Pkg. 100	17 mm	24 mm	1.5 mm	Steel
	192663	Pkg. 100	17 mm	24 mm	1 mm	Steel
	191901	Pkg. 100	17 mm	24 mm	0.5 mm	Steel
	192821	Pkg. 100	18 mm	31.9 mm	0.5 mm	Metal
	191815	Pkg. 100	20 mm	28 mm	0.5 mm	Steel
	191504	Pkg. 100	28 mm	40 mm	0.3 mm	Steel

### SEALING RINGS

	HC-CARGO	Std pkg	ID	OD	Thickness	Material
	190823	Pkg. 100	6 mm	10 mm	1 mm	Copper
	080032	Pkg. 100	6 mm	10 mm	1.5 mm	Nylon
	080004	Pkg. 25	6 mm	12 mm	1 mm	Copper
	190824	Pkg. 100	6.3 mm	12 mm	1 mm	Copper
	190828	Pkg. 100	8 mm	14 mm	1 mm	Copper
	190826	Pkg. 100	8.2 mm	12 mm	1 mm	Copper
	190806	Pkg. 100	10.3 mm	16 mm	1 mm	Copper
	190808	Pkg. 100	12 mm	16 mm	1.5 mm	Copper
	190807	Pkg. 100	12 mm	16 mm	1.5 mm	Aluminium
	190809	Pkg. 100	12 mm	18 mm	1.5 mm	Copper
	191358	Pkg. 100	12 mm	24 mm	1 mm	Copper
	190810	Pkg. 100	13 mm	18 mm	1.5 mm	Copper
	190812	Pkg. 100	14 mm	18 mm	1.5 mm	Copper
	190811	Pkg. 100	14 mm	18 mm	1.5 mm	Aluminium
	190815	Pkg. 100	14 mm	20 mm	1.5 mm	Copper
	190813	Pkg. 100	14 mm	20 mm	1.5 mm	Aluminium
	190817	Pkg. 100	16 mm	20 mm	1.5 mm	Copper
	190816	Pkg. 100	16 mm	20 mm	1 mm	Copper
	190818	Pkg. 100	16 mm	22 mm	1.5 mm	Copper
	191489	Pkg. 100	16 mm	24 mm	1.5 mm	Copper
	190819	Pkg. 100	18 mm	22 mm	1.5 mm	Copper
	190820	Pkg. 100	18 mm	24 mm	1.5 mm	Copper
	191490	Pkg. 100	18 mm	26 mm	1.5 mm	Copper
	190821	Pkg. 100	20 mm	26 mm	1.5 mm	Copper
	190822	Pkg. 100	22 mm	27 mm	1.5 mm	Copper

## INSULATORS

### FIBERS

	HC-CARGO	Std pkg	ID	OD	Thickness	Material
	191346	Pkg. 100	4 mm	13 mm	1 mm	Red fiber
	191351	Pkg. 100	5 mm	12 mm	1 mm	Red fiber
	191352	Pkg. 100	5 mm	16 mm	1 mm	Red fiber
	191344	Pkg. 100	6 mm	10 mm	1 mm	Red fiber
	191350	Pkg. 100	6 mm	18 mm	1.5 mm	Red fiber
	191442	Pkg. 100	7.5 mm	14 mm	3 mm	Red fiber
	191353	Pkg. 100	8 mm	12 mm	0.5 mm	Red fiber
	191345	Pkg. 100	8 mm	20 mm	2 mm	Red fiber
	191434	Pkg. 100	10 mm	14 mm	1 mm	Red fiber
	191349	Pkg. 100	10 mm	16 mm	1 mm	Red fiber
	191648	Pkg. 100	10 mm	25 mm	2 mm	Red fiber
	191356	Pkg. 100	10 mm	29 mm	1 mm	Red fiber
	191339	Pkg. 100	12 mm	19 mm	1 mm	Red fiber
	191348	Pkg. 100	12.2 mm	22 mm	1 mm	Red fiber
	191347	Pkg. 100	13 mm	23 mm	1.5 mm	Red fiber
	191646	Pkg. 100	13 mm	29 mm	2 mm	Red fiber
	191532	Pkg. 100	14 mm	34 mm	2 mm	Red fiber
	191430	Pkg. 100	14.5 mm	29 mm	1 mm	Red fiber
	191869	Pkg. 100	15 mm	24 mm	0.5 mm	Red fiber
	191355	Pkg. 100	20.5 mm	35 mm	1.5 mm	Red fiber
191354	Pkg. 100	45 mm	51 mm	1 mm	Red fiber	

### FENDERS

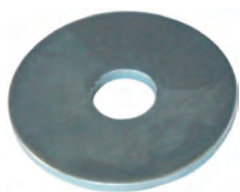
	HC-CARGO	Std pkg	ID	OD	Thickness	ISO norm	DIN norm
	191813	Pkg. 1000	3.2 mm	9 mm	0.8 mm	7093	9021A
	191289	Pkg. 200	4.3 mm	12 mm	1 mm	7093	9021A
	190603	Pkg. 200	5.3 mm	15 mm	1.2 mm	7093	9021A
	192694	Pkg. 200	5.3 mm	20 mm	1.5 mm	7093	9021A
	190604	Pkg. 200	6.4 mm	18 mm	1.6 mm	7093	9021A
	191291	Pkg. 200	8.4 mm	15 mm	1.6 mm	7092	433
	190605	Pkg. 200	8.4 mm	24 mm	2 mm	7093	9021A

### SPRING LOCK

	HC-CARGO	Std pkg	ID	Material
	192348	Pkg. 200	1/2"	Steel spring
	192128	Pkg. 200	1/4"	Steel spring







### CURVED

	HC-CARGO	Std pkg	ID	OD	Thickness	Material
	190577	Pkg. 200	3.1 mm	6.2 mm	0.7 mm	Steel spring
	190578	Pkg. 1000	4.11 mm	7.2 mm	0.85 mm	Steel spring
	192678	Pkg. 200	5.3 mm	10 mm	0.5 mm	Steel spring
	190579	Pkg. 1000	5.4 mm	9.2 mm	1 mm	Steel spring
	190580	Pkg. 200	6.1 mm	11.8 mm	1.3 mm	Steel spring
	190581	Pkg. 500	7.1 mm	12.8 mm	1.3 mm	Steel spring
	190582	Pkg. 500	8.1 mm	14.8 mm	1.6 mm	Steel spring
	192679	Pkg. 200	8.4 mm	15 mm	0.5 mm	Steel spring
	190583	Pkg. 200	10.2 mm	18.1 mm	1.8 mm	Steel spring
	190584	Pkg. 200	12.2 mm	18.1 mm	2.1 mm	Steel spring
	191287	Pkg. 200	14.2 mm	24.1 mm	2.4 mm	Steel spring
	191288	Pkg. 200	16.2 mm	27.4 mm	2.8 mm	Steel spring

### STEEL

#### W/CHAMFER

	HC-CARGO	Std pkg	ID	OD	Thickness	ISO norm	DIN norm	Material
	190598	Pkg. 200	6.4 mm	12 mm	1.6 mm	7090	125B	Steel
	190599	Pkg. 200	8.4 mm	16 mm	1.6 mm	7090	125B	Steel
	191579	Pkg. 100	10.5 mm	20 mm	2 mm	7090	125B	Steel

W/KEY SLOT						
	HC-CARGO	Std pkg	ID	OD	Thickness	Material
	191265	Pkg. 100	17 mm	34 mm	2 mm	Steel
LOCK						
EXTERNAL SERRATED						
	HC-CARGO	Std pkg	ID	DIN norm	Material	
	190616	Pkg. 200	M4	6798A	Steel	
	190612	Pkg. 200	M5	6798A	Steel	
	190613	Pkg. 200	M6	6798A	Steel	
	190614	Pkg. 200	M8	6798A	Steel	
INTERNAL SERRATED						
	HC-CARGO	Std pkg	ID	DIN norm	Material	
	190608	Pkg. 200	M6	6798J	Steel	
	190609	Pkg. 200	M8	6798J	Steel	
	190610	Pkg. 200	M10	6798J	Steel	
WAVED TYPE						
	HC-CARGO	Std pkg	ID	OD	Thickness	
	191903	Pkg. 100	11.4 mm	18.8 mm	0.3 mm	
	191913	Pkg. 100	16.3 mm	24 mm	1.5 mm	
	191336	Pkg. 100	17 mm	30 mm	1.6 mm	
COTTER PINS						
	HC-CARGO	Std pkg	OD	Length	DIN norm	Material
	191575	Pkg. 100	1.6 mm	16 mm	94	Steel
	190632	Pkg. 100	2 mm	32 mm	94	Steel
	190633	Pkg. 100	2 mm	40 mm	94	Steel
	190634	Pkg. 100	2.5 mm	25 mm	94	Steel
	191576	Pkg. 100	3.2 mm	25 mm	94	Steel
	190638	Pkg. 100	3.2 mm	32 mm	94	Steel
	191587	Pkg. 100	4 mm	25 mm	94	Steel
	191577	Pkg. 100	4 mm	36 mm	94	Steel
BUSHINGS						
	HC-CARGO	Std pkg	Length			
<i>For cover.</i>						
	080161	Pkg. 1	20 mm			
	080162	Pkg. 1	25 mm			
	080165	Pkg. 1	30.5 mm			
	080232	Pkg. 1	33.5 mm			
	080164	Pkg. 1	35 mm			
	080163	Pkg. 1	40.5 mm			
THREADED						
	HC-CARGO	Std pkg	Length	Thread/ internal	Thread/ external	
	192578	Pkg. 10	10 mm	M10-1	M12-1	<i>For glow plugs.</i>

## RIVETS

	HC-CARGO	Std pkg	OD	Length	DIN norm	Material
	191441	Pkg. 100	3 mm	6 mm	660	Steel
	191284	Pkg. 100	4 mm	6 mm	660	Copper
	191285	Pkg. 100	4 mm	12 mm	660	Aluminium
	192048	Pkg. 100	5 mm	20 mm	674	Aluminium

## BLIND

	HC-CARGO	Std pkg	OD	Length	Grip range	DIN norm	Material
	193263*	Pkg. 1					
	191649	Pkg. 100	4 mm	10 mm	4.5-6.5	7337A	Stainless steel
	191458	Pkg. 100	4 mm	10 mm	5-6.5	7337A	Alu/Steel
	191459	Pkg. 100	4 mm	16 mm	8.5-12	7337A	Alu/Alu

## TUBULAR

	HC-CARGO	Std pkg	OD	Length	Material
	191552	Pkg. 100	6 mm	25 mm	Brass

## STORAGE

**200633** Assortment Box Std pkg 1

Metal. w/ plastic insertion. 20 rooms. Dim.: 333x230x55 mm.



## ASSORTMENTS

### BOXES

**200663** Assortment Box Std pkg 1

Can be divided using inserts.



Length: 265.00 m  
Thickness: 57.00 mm  
Width: 340.00 mm

Material: Polypropylene

**200875** Carry Lite Assortment Box Std pkg 1



Length: 413 m  
Thickness: 57 mm  
Width: 330 mm

Colour: Anthracite  
Material: Polypropylene





**200876** Carry Lite Assortment Box Std pkg 1

80-01.

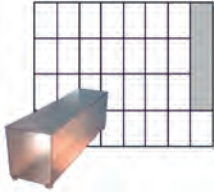
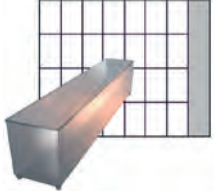

Length: 413 m  
Thickness: 79 mm  
Width: 330 mm

Colour: Anthracite  
Material: Polypropylene

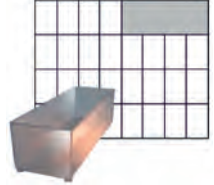
EL. SPECIFICATIONS		DIMENSIONS	ADDITIONAL SPECIFICATIONS
<b>200877</b> Carry Lite Assortment Box    Std pkg 1 		Length: 413 m Thickness: 147 mm Width: 330 mm	Colour: Anthracite Material: Polypropylene
<b>INSERTS</b>			
<b>200664</b> Insert    Std pkg 1 <i>Unbreakable.</i> 		Length: 40.00 m Thickness: 45.00 mm Width: 55.00 mm	Material: Polypropylene
<b>200665</b> Insert    Std pkg 1 <i>Unbreakable.</i> 		Length: 110.00 m Thickness: 45.00 mm Width: 40.00 mm	Material: Polypropylene
<b>200666</b> Insert    Std pkg 1 <i>Unbreakable.</i> 		Length: 165.00 m Thickness: 45.00 mm Width: 40.00 mm	Material: Polypropylene
<b>200667</b> Insert    Std pkg 1 <i>Unbreakable.</i> 		Length: 220.00 m Thickness: 45.00 mm Width: 40.00 mm	Material: Polypropylene
<b>200668</b> Insert    Std pkg 1 <i>Unbreakable.</i> 		Length: 80.00 m Thickness: 45.00 mm Width: 55.00 mm	Material: Polypropylene
<b>200669</b> Insert    Std pkg 1 <i>Unbreakable.</i> 		Length: 160.00 m Thickness: 45.00 mm Width: 55.00 mm	Material: Polypropylene

EL. SPECIFICATIONS		DIMENSIONS	ADDITIONAL SPECIFICATIONS
<b>200670</b> Insert Std pkg 1 Unbreakable.		Length: 240.00 m Thickness: 45.00 mm Width: 55.00 mm	Material: Polypropylene
			
<b>200671</b> Insert Std pkg 1 Unbreakable.		Length: 110.00 m Thickness: 45.00 mm Width: 80.00 mm	Material: Polypropylene
			
<b>200672</b> Insert Std pkg 1 Unbreakable.		Length: 220.00 m Thickness: 45.00 mm Width: 80.00 mm	Material: Polypropylene
			
<b>200673</b> Insert Std pkg 1 Unbreakable.		Length: 160.00 m Thickness: 45.00 mm Width: 110.00 mm	Material: Polypropylene
			
<b>DISPLAY</b>			
<b>200676</b> Display for 4 Assortments Std pkg 1 Frame for 4 Profi service cases.		Length: 200.00 m Thickness: 330.00 mm Width: 360.00 mm	
			
<b>200693</b> Assortment Display Std pkg 1 Frame for 4 Profi service cases. Can be assembled horizontally or vertically.		Length: 265.00 m Thickness: 313.00 mm Width: 373.00 mm	
			
<b>HSS DRILLS</b>			
<b>210574</b> Drill Assortment Std pkg 1 Contains 178 drills from 1-10.5 mm.			
			



# Assortments

Edition 2016/2017

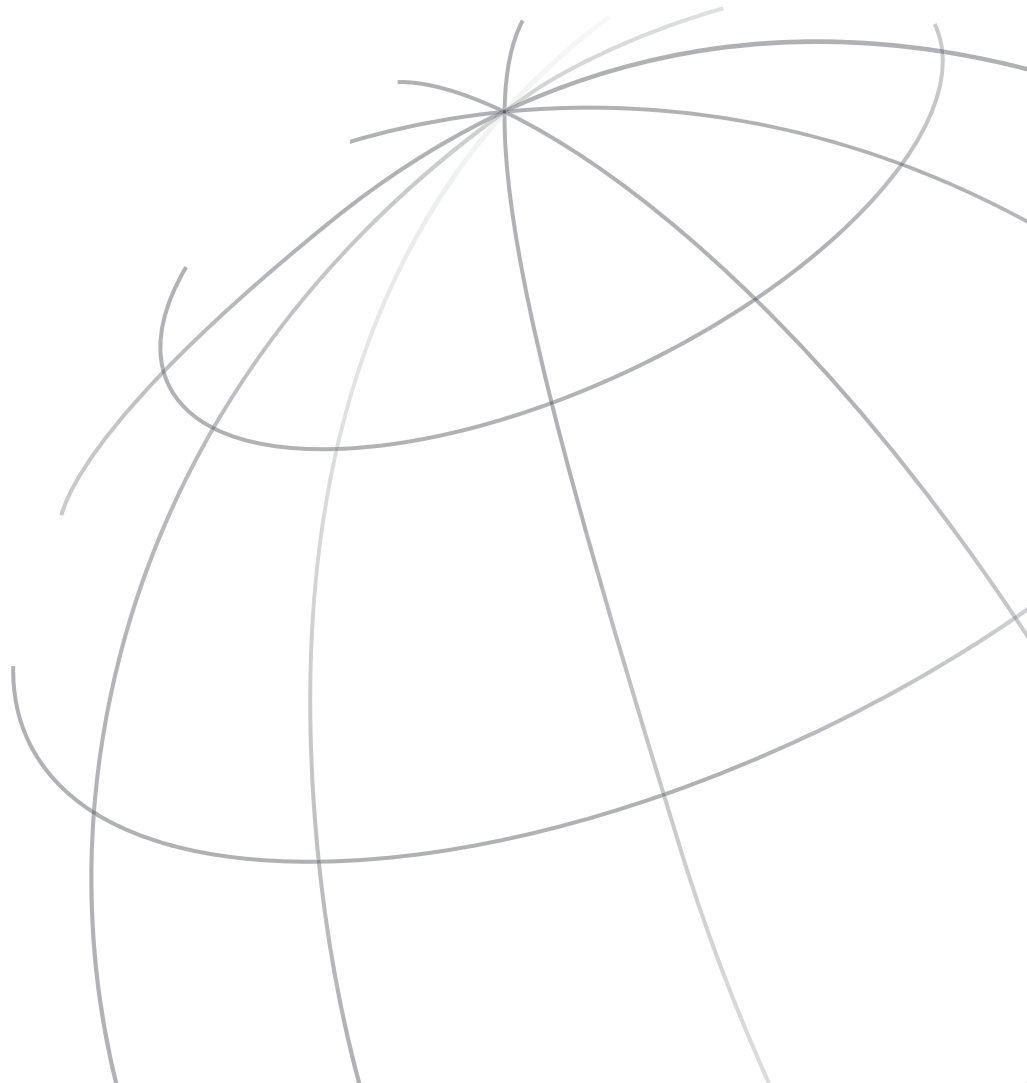

**ATO Blade Fuses**
**804008**

Type	Amp	Qty.
191465 ... Mini blade fuse	2	10
191466 ... Mini blade fuse	3	10
191467 ... Mini blade fuse	4	10
191468 ... Mini blade fuse	5	10
191469 ... Mini blade fuse	7.5	10
191470 ... Mini blade fuse	10	10
191471 ... Mini blade fuse	15	10
191472 ... Mini blade fuse	20	10
191473 ... Mini blade fuse	25	10
191474 ... Mini blade fuse	30	10
191475 ... ATO blade fuse	1	25
191476 ... ATO blade fuse	2	25
190053 ... ATO blade fuse	3	50
190054 ... ATO blade fuse	4	50

Type	Amp	Qty.
190055 ... ATO blade fuse	5	50
190056 ... ATO blade fuse	7.5	50
190057 ... ATO blade fuse	10	50
190058 ... ATO blade fuse	15	50
190059 ... ATO blade fuse	20	50
190060 ... ATO blade fuse	25	50
190061 ... ATO blade fuse	30	50
191664 ... ATO blade fuse	40	50

**Connectors & Insulators**
**804012**

Type	Pole	Qty.
191007 . Insulator		50
191126 . Insulator		20
191127 . Insulator		50
191227 . Insulator		10
191226 . Insulator		10
190260 . Multiple connector	2-pole	10
190261 . Multiple connector	2-pole	10
190843 . Multiple connector	2-pole	10
190272 . Multiple connector	2-pole	10
191158 . Multiple connector	2-pole	10
191159 . Multiple connector	2-pole	10
190262 . Multiple connector	3-pole	10
190263 . Multiple connector	3-pole	10
191224 . Multiple connector	3-pole	10

Type	Pole	Qty.
191225 . Multiple connector	3-pole	10
190264 . Multiple connector	4-pole	10
190265 . Multiple connector	4-pole	10
190266 . Multiple connector	6-pole	2
190267 . Multiple connector	6-pole	2

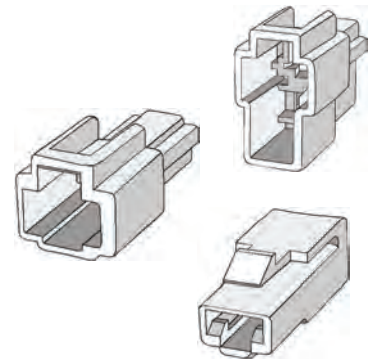
**Crimp Terminals - Non-insulated**
**804013**

	Qty.
190256 .... Terminal	20
190725 .... Terminal	20
191025 .... Terminal	20
191064 .... Terminal	20
191069 .... Terminal	20
191411 .... Terminal	20
191412 .... Terminal	20
191413 .... Terminal	20
190726 .... Terminal	25
190270 .... Terminal	100
190868 .... Terminal	100
191028 .... Terminal	100
191029 .... Terminal	100
191083 .... Terminal	100

	Qty.
191089 .... Terminal	100
191129 .... Terminal	100
191200 .... Terminal	100
191415 .... Terminal	100
190252 .... Terminal	200
191008 .... Terminal	200

**Insulated Terminals**
**804014**

	Qty.
190049 Terminal 2.8 mm. red	100
190045 Terminal 4.7 mm. red	100
190022 Terminal 6.3 mm. red	100
190020 Terminal 6.3 mm. blue	100
190024 Terminal 6.3 mm. yellow	50
190041 Terminal 8.0 mm. blue	50
190048 Terminal 9.5 mm. yellow	50
190985 Terminal 6.3 mm. red	100
190046 Terminal 6.3 mm. blue	100
190025 Terminal 6.3 mm. red	50
190026 Terminal 6.3 mm. blue	50
190016 Terminal 6.3 mm. blue	100
190019 Terminal 6.3 mm. red	100
190021 Terminal, O.D. 4 mm. red	100

	Qty.
190023 Terminal, O.D. 4 mm. blue	75
190017 Terminal, I.D. 5 mm. red	100
191009 Shrinkable full insulated, red	25
191010 Shrinkable full insulated, blue	25
190028 Butt connector, red	100
190001 Butt connector, blue	100
190018 Terminal, blue	50
191011 Shrinkable full insul., yellow	20





**Ring Crimp Terminals - Insulated**

804015

	mm	Qty.		mm	Qty.
190038	Terminal .... 3 ... red	100	190255	Terminal .... 8 .... yellow	50
190257	Terminal .... 3 ... blue	100	190042	Terminal .. 10 .... yellow	50
190027	Terminal .... 4 ... red	100	190974	Terminal ..... red	100
190973	Terminal .... 4 ... red	100	190952	Terminal ..... blue	100
190029	Terminal .... 4 ... blue	100	190953	Terminal ..... yellow	50
190032	Terminal .... 4 ... blue	100			
191067	Terminal .... 4 ... blue	100			
190031	Terminal .... 5 ... red	100			
190037	Terminal .... 5 ... blue	100			
190033	Terminal .... 5 ... yellow	50			
190015	Terminal .... 6 ... red	100			
190034	Terminal .... 6 ... blue	100			
190035	Terminal .... 6 ... yellow	50			
190039	Terminal .... 8 ... blue	50			

**ABS Connectors & Tools**

804017

	Qty.
191168 . Tube for 1.5 mm <sup>2</sup> .	10
192180 . Tube for 1.5 mm <sup>2</sup> .	10
192181 . Tube for 1.5 mm <sup>2</sup> .	10
191196 . Tube for 4.0 mm <sup>2</sup> .	10
191197 . Tube for 4.0 mm <sup>2</sup> .	10
191169 . Tube for 6.0 mm <sup>2</sup> .	10
191171 . Pin for 1.5 mm <sup>2</sup> .	10
191172 . Pin for 6.0 mm <sup>2</sup> .	10
180245 . Sealing disc kit set	2
210643 . Ejection tool 6.5 mm <sup>2</sup> .	1
210639 . Crimping tool	1
210644 . Dismounting bush 6.5 mm <sup>2</sup> .	1
210645 . Mounting bush 6.5 mm <sup>2</sup> .	1

**Sealing Rings I**

804020

ID	OD	Th. mm	Qty.	ID	OD	Th. mm	Qty.
190823	6	10	1	Copper	20		
190824	6	12	1	Copper	20		
190826	8	12	1	Copper	20		
190828	8	14	1	Copper	20		
080009	10	14	1	Copper	20		
190806	10	16	1	Copper	20		
190807	12	16	1.5	Alu.	20		
190808	12	16	1.5	Copper	20		
190809	12	18	1.5	Copper	20		
191358	12	24	1	Copper	20		
190810	13	18	1.5	Copper	20		
190811	14	18	1.5	Alu.	20		
190812	14	18	1.5	Copper	20		
190813	14	20	1.5	Alu.	20		
190815	14	20	1.5	Copper	20		
190816	16	20	1	Copper	20		
190817	16	20	1.5	Copper	20		
190818	16	22	1.5	Copper	20		
191489	16	24	1.5	Copper	20		
190819	18	22	1.5	Copper	20		
190820	18	24	1.5	Copper	20		
191490	18	26	1.5	Copper	20		
190821	20	26	1.5	Copper	20		
190822	22	27	1.5	Copper	20		

**Rubber Clamps (Rubber profile 12.7 mm. - Fixing hole 6.8 mm.)**

804021

	Pipe OD	Type	Qty.
190899	6.4 mm	6	10
190900	7.9 mm	8	10
190901	9.5 mm	10	10
190902	11.1 mm	11	10
190903	12.7 mm	13	5
190904	14.3 mm	14	5
190905	15.9 mm	16	5
190906	17.5 mm	18	5
190907	19.0 mm	19	5
190908	22.2 mm	22	5
190909	25.4 mm	25	5
191417	28.6 mm	29	5



## Rubber Grommets &amp; Blankings

804022

	B mm	C mm	D mm	Amp	Qty.
190964	5.5		8	1.6	20
190120	6.4		9.5	1.6	20
190965	8		9.5	1.6	20
190966	8		11	1.6	20
190967	8		12.5	1.6	20
190122	9.5		12.5	1.6	20
190968	11		14.2	1.6	20
190969	12.5		17.5	1.6	20
190970	12.5		19	1.6	20
190110	6.4	9.5	9.5	1.6	20
190111	8	10.6	14.2	1.6	20
190112	9.5	12.8	15.4	1.6	20
190114	12.5	15.5	18.7	1.6	20
190115	15.5	19	22	1.6	20

	B mm	C mm	D mm	Amp	Qty.
190116	19	22.1	25.5	1.6	20
190958	22.5	27	28.5	1.6	10
190959	24.4	28.3	32	1.6	10

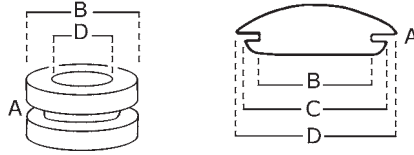

## Cable Ties

804024

	L.	W.	Max dia.	Qty.
191003	102	2.50	25 mm	200
191188	150	3.60	39 mm	100
191094	200	2.50	55 mm	200
190248	190	4.80	52 mm	100
191128	92	2.40	16 mm	200
190014	Self adhesive 27 x 27 mm.			300



## Torpedo &amp; Glass Fuses

804036

	Dim. mm	Amp	Qty.
190285	20 x 5	0.5	20
190286	20 x 5	2	20
190284	20 x 5	6.3	20
190734	20 x 5	10	20
191534	20 x 5	20	20
190276	25 x 6	5	100
190277	25 x 6	8	100
190278	25 x 6	16	100
190279	25 x 6	25	100
190280	25 x 6	40	100
190735	29 x 6.3	10	20
191570	29 x 6.3	15	20
190736	29 x 6.3	25	20
190287	32 x 6.3	5	20

	Dim. mm	Amp	Qty.
190288	32 x 6.3	10	20
190289	32 x 6.3	15	20
190274	32 x 6.3	20	20
190275	32 x 6.3	35	20



## Machine Screws &amp; Nuts

804037

	Spanner size mm		Qty.
190520	5.5	M3	200
190521	7	M4	200
190779	8	M5	200
190780	10	M6	200

	Length mm.	Qty.
190531	M3 x 10	200
191770	M4 x 8	200
190536	M4 x 10	200
191317	M4 x 14	200
191318	M4 x 18	200
190540	M4 x 25	200
190541	M4 x 30	200
191319	M5 x 6	200
190544	M5 x 10	200
190547	M5 x 20	200
190552	M6 x 10	100



**Mini Clamps**

804040

	Min mm	Max mm	Ref. no.	Qty.
190005	6	8.3	8	10
190006	7	9.3	9	10
190007	8	10.3	10	10
190008	9	11.3	11	10
190009	9	12.3	12	10
190010	10	13.3	13	10
190937	11	14.3	14	10
190938	12	15.3	15	10

**PVC Caps**

804041

	OD mm	ID mm	H mm	No.	Qty.
191364	4.8/5.5	3.2/4	5.7	3	100
191365	6/6.7	4.5/5.3	5.9	5	100
191366	6.8/7.4	5/5.6	6.8	6	100
191367	7.6/8.5	6/7.1	8	8	100
191368	8.3/9.4	6.9/7.9	9	10	100
191369	10.1/11	8.2/9.5	9.9	12	50
191370	10.8/12.5	9/10.8	9.6	15	50
191371	11.4/12.8	10.1/11.3	9.8	16	50
191372	13.1/14.5	11.5/13	11.1	18	25
191373	13.9/15.4	12.4/14	12	20	25
191374	14.2/15.7	13/14.7	12.8	25	25
191375	14.9/16.8	14/15.5	12.8	27	50
191480	17.2/18.9	15.8/17.6	14	30	25
191376	18.2/20.2	16.4/18.8	13.9	35	25

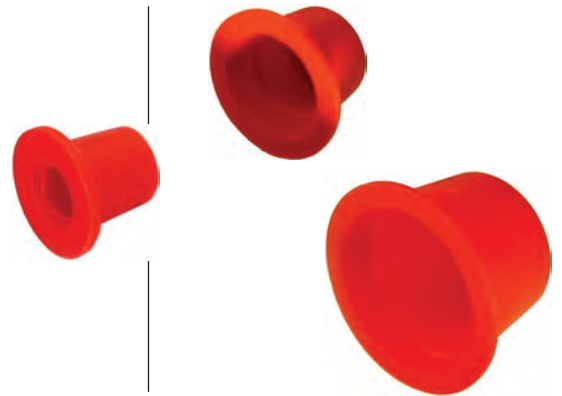
**Red Crimp Terminals - Insulated**

804048

	mm	Qty.		mm	Qty.		
190049	Flat plug	2.8	100	191501	Spade	2	100
190045	Flat plug	4.7	100	190973	Spade	4	100
190022	Flat plug	6.3	100	190974	Pin		100
190025	Flat plug and piggy back	6.3	50				
190985	Flat plug, fully insulated	6.3	100				
190019	Flat tongue	6.3	100				
190021	Round plug, O.D. 4 mm		100				
190017	Round plug receptacle, I.D. 4 mm		100				
190028	Butt connector		100				
191009	Butt connector		25				
190038	Ring	3	100				
190027	Ring	4	100				
190031	Ring	5	100				
190015	Ring	6	100				

**Blue Crimp Terminals - Insulated**

804049

	mm	Qty.		mm	Qty.		
190020	Flat plug	6.3	100	191067	Spade	4	100
190041	Flat plug	8	50	190037	Spade	5	100
190026	Flat plug, fully insulated	4.7	50	190952	Pin		100
190046	Flat plug, fully insulated	6.3	100				
190016	Flat tongue	6.3	100				
190023	Round plug, O.D. 5 mm		100				
190018	Round plug receptacle, I.D. 5 mm		50				
190001	Butt connector		100				
191010	Butt connector		25				
190257	Ring	3	100				
190029	Ring	4	100				
190032	Ring	5	100				
190034	Ring	6	100				
190039	Ring	8	100				



## Yellow Crimp Terminals - Insulated

804050

	mm	Qty.
190024 Flat plug.....	6.3	50
190048 Flat plug.....	9.5	50
191191 Flat tongue .....	6.3	50
190051 Round plug, O.D. 5 mm. ....	5	50
190050 Round plug receptacle, I.D. 5 mm.	5	50
190030 Butt connector .....		50
191011 Butt connector .....		25
190033 Ring .....	5	50
190035 Ring .....	6	50
190255 Ring .....	8	50
190042 Ring .....	10	50
191515 Ring .....	12	100
190953 Pin.....		100



## Cable Joints

804054

	mm <sup>2</sup>	Ring	Qty.
190846	4.0 - 6.0	M6	50
190716	10.0	M6	20
190717	16.0	M6	20
190718	16.0	M8	20
190719	25.0	M8	10
190720	25.0	M10	10
191416	35.0	M8	10
190721	35.0	M10	10
190722	50.0	M8	10
190723	50.0	M10	10



## Crimp Seal Terminals

804055

	Type	mm	Qty.
191009	Butt connector Red	10	10
191010	Butt connector Blue	10	10
191011	Butt connector Yellow	10	10
191682	Ring Red	4	10
191685	Ring Blue	4	10
191689	Ring Yellow	5	10
191683	Ring Red	5	10
191686	Ring Blue	5	10
191684	Ring Red	6	10
191687	Ring Blue	6	10
191690	Ring Yellow	6	10
191688	Ring Blue	8	10
191691	Ring Yellow	8	10
191692	Ring Yellow	10	10
191693	Spade Red	4	10
191694	Spade Blue	4	10
191695	Spade Blue	5	10
191696	Spade Yellow	5	10
191697	Flat plug, ful.insul. Red	6.3	10
191698	Flat plug, ful.insul. Blue	6.3	10
191699	Flat tongue Red	6.3	10
191700	Flat tongue Blue	6.3	10

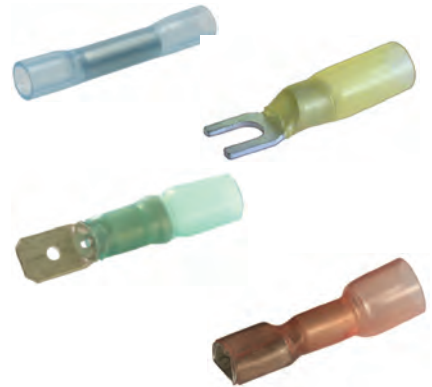

## Protection Caps

804065

	H. mm	Qty.
191862	M8-1	10
191863	M10-1	10
191864	M12-1	10
191865	M12-1.5	10
191866	M14-1.5	10



**Lock Washer**

804068

	ID mm	Qty.
191277	M3.2	100
191278	M6	100
191573	M7	100
191279	M8	100
191280	M9	100
191270	M15	100
191271	M18	100
191333	M19	100
191272	M20	100
191273	M21	100
191274	M22	100
191481	M23	100
191275	M24	100
191276	M25	100

	ID mm	Qty.
191433	M27	100

**Tapping Screws I**

804069

	Dim. mm	Type no.	Qty.
191753	2.9 x 16	4	200
191798	2.9 x 19	4	200
190360	3.5 x 9.5	6	250
190361	3.5 x 16	6	200
190362	3.5 x 19	6	200
190366	4.2 x 9.5	8	200
190367	4.2 x 16	8	200
190368	4.2 x 19	8	200
190371	4.2 x 25	8	200
190372	4.8 x 13	10	200
190373	4.8 x 19	10	200

**Cable Clips**

804070

	Pipe OD	Type	Qty.
191950	3.2 mm	9.5	100
191951	4.8 mm	10.5	100
191952	6.4 mm	12.0	50
191953	7.9 mm	12.0	50
191954	9.5 mm	12.5	50
191955	12.7 mm	15.2	20
191956	15.8 mm	18.2	20
191957	19.4 mm	18.2	20
191958	25.4 mm	22.0	20
191959	31.8 mm	26.2	20

**Butt Splices**

804073

	mm <sup>2</sup>	Qty.
192007	1.3	100
192008	2.0	100
191885	6.0	10
191886	10.0	10
191887	16.0	10
191888	25.0	10
191889	35.0	10
191890	50.0	10
191891	70.0	10



**Super Seal Connectors**
**804075**

	Qty.		Qty.
192587 . Single wire seal Insulation dia.: 1.8-2.4 mm.	100	192085 . Superseal.... 5 pole. Female .5	5
192091 . Single wire seal Insulation dia.: 2.6-3.3 mm.	100	192086 . Superseal.... 5 pole. Male ....5	5
192089 . Male. 1.5 mm. 1-1.5 mm <sup>2</sup> .	100	192087 . Superseal.... 6 pole. Female .5	5
192090 . Female. 1.5 mm. 1-1.5 mm <sup>2</sup> .	100	192088 . Superseal.... 6 pole. Male ....5	5
192077 . Superseal.. 1 pole ..Male.....5	5		
192078 . Superseal.. 1 pole ..Female ...5	5		
192079 . Superseal.. 2 pole .. Female...5	5		
192080 . Superseal.. 2 pole ..Male.....5	5		
192081 . Superseal.. 3 pole ..Female ...5	5		
192082 . Superseal.. 3 pole ..Male.....5	5		
192083 . Superseal.. 4 pole ..Female ...5	5		
192084 . Superseal.. 4 pole ..Male.....5	5		

**PAL Fuses II (Slow Blow Fuses)**
**804076**

Type	Amp	Qty.	Type	Amp	Qty.	Type	Amp	Qty.
191153 ... Green.....	40	1	191975 ... Brown .....	70	1	191637 ... Brown .....	70	1
191154 ... Yellow .....	60	1	191157 ... Black .....	80	1	191976 ... Black .....	80	1
191970 ... Red .....	50	1	191971 ... Darkblue .....	100	1	191978 ... Darkblue .....	100	1
191830 ... Brown .....	25	1	191628 ... Pink .....	30	1			
191831 ... Green.....	30	1	191629 ... Green.....	40	1			
191832 ... Red .....	45	1	191630 ... Red .....	50	1			
191833 ... Black .....	65	1	191631 ... Yellow .....	60	1			
191834 ... Grey .....	75	1	191632 ... Brown .....	70	1			
191672 ... Pink .....	30	1	191972 ... Black .....	80	1			
191673 ... Green.....	40	1	191977 ... Darkblue .....	100	1			
191155 ... Pink .....	30	1	191633 ... Pink .....	30	1			
191973 ... Green.....	40	1	191634 ... Green.....	40	1			
191974 ... Red .....	50	1	191635 ... Red .....	50	1			
191156 ... Yellow .....	60	1	191636 ... Yellow .....	60	1			

**Heat Shrink Pipes I**
**804077**

	mm before crimp	mm after crimp	Qty. m
193170 ...	2.4	1.2	10
193171 ...	3.2	1.6	10
193172 ...	4.8	2.4	8
193173 ...	6.4	3.2	6
193174 ...	9.5	4.8	5
193175 ...	12.7	6.4	5
193176 ...	19.1	9.5	4
193177 ...	25.4	12.7	3

06219 Display stand..... 1

 Shrinking temp. 90 °C.  
Shrink ration 2:1.

**Single Core Cables**
**804078**

	Dim. mm	Length
190697 ..	Black ..... 1 x 1.5	100 m
190698 ..	Red ..... 1 x 1.5	100 m
190699 ..	Blue..... 1 x 1.5	100 m
190700 ..	Yellow ..... 1 x 1.5	100 m
190702 ..	Green..... 1 x 1.5	100 m

06219 .... Display stand..... 1

 1 x 1.5 mm<sup>2</sup>. 30 / 0.250 mm. 16 Amp.

**Junior-Timer/Junior-Power-Timer II**
**804081**

		Qty.			Qty.
192177	Single wire seal for 0.5-1.0 mm <sup>2</sup> . cable	100	192153	Rubber boot for 3-pole. L. 57 mm.	2
192178	Single wire seal for 1.5-2.5 mm <sup>2</sup> . cable	100	192172	5-pole female holder, black	2
192156	Male 2.8 mm. 0.5 - 1.0 mm <sup>2</sup>	100	192173	6-pole female holder, black	1
192175	Female terminal 0.5-1.0 mm <sup>2</sup>	100			
192157	Male 2.8 mm. 1.5 - 2.5 mm <sup>2</sup>	100			
192176	Female terminal 1.0-2.5 mm <sup>2</sup>	100			
192167	2-pole male holder, black	2			
192147	2-pole female holder, black	3			
192150	Rubber boot for 2-pole. L. 57 mm	2			
192152	Rubber boot for 2-pole. Angled	4			
192148	3-pole female holder, black	2			
192171	4-pole female holder, black	1			

**Cord End Terminals**
**804085**

	mm <sup>2</sup>	L. mm	Qty.
191962	0.5	10	100
191963	0.75	10	100
191964	1	10	100
191965	1.5	10	100
191966	2.5	10	100
191967	4	12	100
191968	6	15	100
191969	10	15	100
192047	16	18	100

**Mega Blade Fuses**
**804086**

	Type	Amp	Qty.
192791	White	40	3
192792	White	60	3
192793	Red	80	3
192049	Yellow	100	3
192050	Green	125	3
192051	Tan	150	3
192052	White	175	3
192053	Blue	200	3
192229	Brown	225	3
192230	Pink	250	3
192231	Grey	300	3
192055	Fuse holder (Terminals: M8)		2

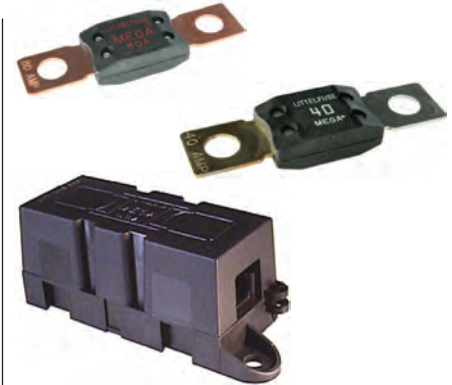
**Batteries**
**804088**

		Qty.			Qty.
200772	Lithium Button Battery	5	200791	Alkaline Battery	5
200773	Lithium Button Battery	5			
200774	Lithium Button Battery	5			
200775	Lithium Button Battery	5			
200802	Lithium Button Battery	5			
200813	Lithium Button Battery	5			
200854	Lithium Button Battery	5			
200858	Lithium Button Battery	5			
200779	Silver Oxide Button Battery	5			
200778	Alkaline Button Battery	5			
200792	Alkaline Button Battery	5			
200601	Alkaline Battery	5			
200776	Alkaline Battery	5			
200777	Alkaline Battery	5			



**Battery Terminals II**
**804089**

	Qty.
190012 .... Battery Terminal +.....	5
190013 .... Battery Terminal -.....	5
190202 .... Battery Terminal +.....	5
190203 .... Battery Terminal -.....	5
190213 .... Battery Terminal +.....	5
190214 .... Battery Terminal -.....	5
190866 .... Battery Terminal +.....	5
190867 .... Battery Terminal -.....	5

**Strip Fuses**
**804090**

	Qty.
192305 ..... Fuse, 35 Amp.....	5
192306 ..... Fuse, 50 Amp.....	5
192307 ..... Fuse, 80 Amp.....	5
192308 ..... Fuse, 100 Amp.....	5
192309 ..... Fuse, 125 Amp.....	5
192310 ..... Fuse, 160 Amp.....	5
192311 ..... Fuse, 200 Amp.....	5
192312 ..... Fuse, 250 Amp.....	5
192313 ..... Fuse, 300 Amp.....	5
192314 ..... Fuse, 355 Amp.....	5
192315 ..... Fuse, 425 Amp.....	5
192316 ..... Fuse, 500 Amp.....	5
192344 ..... Fuse holder.....	2

**PG Cable Glands**
**804091**

Type	Qty.
192355 Mountinghole 12.1 mm. .... PG7	20
192356 Mountinghole 14.3 mm. .... PG9	15
192357 Mountinghole 18.23 mm. ... PG11	10
192358 Mountinghole 19.9 mm. ... PG13.5	8
192359 Mountinghole 22.1 mm. ... PG16	10
192360 Mountinghole 27.5 mm. ... PG21	10

**Pin Terminals - Non-insulated I**
**804092**

	Dia.	mm <sup>2</sup>	Qty.
191915 .	1.0	0.3-0.9	50
191916 .	1.0	0.3-0.9	50
191985 .	1.6	0.75-1.5	50
191543 .	1.6	1.0-2.5	50
191544 .	1.6	1.0-2.5	50
191074 .	2.1	1.0-2.5	50
191075 .	2.1	1.0-2.5	50
191091 .	2.1	0.5-2.1	50
191092 .	2.1	0.5-2.1	50
191563 .	3.5	0.5-2.0	50
191564 .	3.5	0.5-2.0	50
191078 .....		0.5-2.5	50
191079 .....		0.5-2.5	50





**Insulated Terminals w/ Tool**
**804093**

	Qty.		Qty.
190001	Butt connector	10	
190016	6.3 mm. flat tongue	10	
190017	I.D. 4.0 mm. round plug receptacle	10	
190019	6.3 mm. flat tongue	10	
190020	6.3 mm. flat plug	10	
190021	O.D. 4.0 mm. round plug	10	
190022	6.3 mm. flat plug	10	
190024	6.3 mm. flat plug	5	
190026	6.3 mm. flat plug and piggyback	10	
190028	Butt connector	10	
190030	Butt connector	5	
190031	5.0 mm. ring	10	
190032	5.0 mm. ring	10	
190035	6.0 mm. ring	5	
190037	5.0 mm. spade	10	
190042	10.0 mm. ring	5	
190046	6.3 mm. flat plug, fully insulated	10	
190050	I.D. 5.0 mm. round plug receptacle	5	
190051	O.D. 5.0 mm. round plug	5	
190952	Pin	10	
190953	Pin	5	
190973	4.0 mm. spade	10	



	Qty.
190985	6.3 mm. flat plug, fully insulated
192142	6.0 mm. spade
210121	Crimping tool

**Midi Blade Fuses**
**804094**

Type	Amp	Qty.
192427 .. Pink	30	3
192428 .. Green	40	3
192429 .. Red	50	3
192430 .. Yellow	60	3
192431 .. Brown	70	3
192432 .. White	80	3
192433 .. Blue	100	3
192434 .. Tan	125	3
192435 .. White	150	3
192436 .. Fuse holder		2

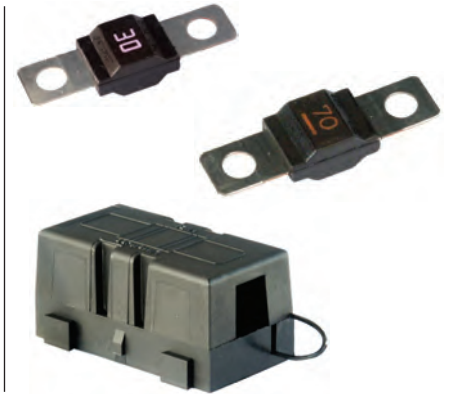
**Insulated Crimp Terminals**
**804095**

	Qty.		Qty.
190022	Terminal 6.3 mm. red	100	
190020	Terminal 6.3 mm. blue	100	
190048	Terminal 9.5 mm. yellow	50	
190985	Terminal 6.3 mm. red	100	
190046	Terminal 6.3 mm. blue	100	
190026	Terminal 6.3 mm. blue	100	
190016	Terminal 6.3 mm. blue	100	
190019	Terminal 6.3 mm. red	100	
190021	Terminal, O.D. 4 mm. red	100	
190023	Terminal, O.D. 4 mm. blue	100	
190017	Terminal, I.D. 5 mm. red	100	
190028	Butt connector, red	100	
190001	Butt connector, blue	100	
190018	Terminal, blue	100	
190255	Ring	8 mm	50
190034	Ring	6 mm	100

**Mini Blade Fuses**
**804096**

	Qty.
191465 .... 2 Amp. Grey	10
191466 .... 3 Amp. Violet	10
191467 .... 4 Amp. Pink	10
191468 .... 5 Amp. Tan	10
191469 .... 7.5 Amp. Brown	10
191470 .... 10 Amp. Red	10
191471 .... 15 Amp. Blue	10
191472 .... 20 Amp. Yellow	10
191473 .... 25 Amp. Natural	10
191474 .... 30 Amp. Green	10
210841 .... Extractor	1



### ATO/Mini/Maxi Fuses

804097

	Qty.
190055 . 5 Amp. Tan, ATO.....	20
190056 . 7.5 Amp. Brown, ATO.....	20
190057 . 10 Amp. Red, ATO.....	20
190058 . 15 Amp. Blue, ATO.....	20
190059 . 20 Amp. Yellow, ATO.....	20
190060 . 25 Amp. Natural, ATO.....	20
190061 . 30 Amp. Green, ATO.....	20
191468 . 5 Amp. Tan, Mini.....	15
191469 . 7 Amp. Brown, Mini.....	15
191470 . 10 Amp. Red, Mini.....	15
191471 . 15 Amp. Blue, Mini.....	15
191472 . 20 Amp. Yellow, Mini.....	15
191473 . 25 Amp. Natural, Mini.....	15
191474 . 30 Amp. Green, Mini.....	15

	Qty.
191250 . 30 Amp. Green, Maxi.....	3
191251 . 40 Amp. Orange, Maxi.....	3
191252 . 50 Amp. Red, Maxi.....	2
191253 . 60 Amp. Blue, Maxi.....	2

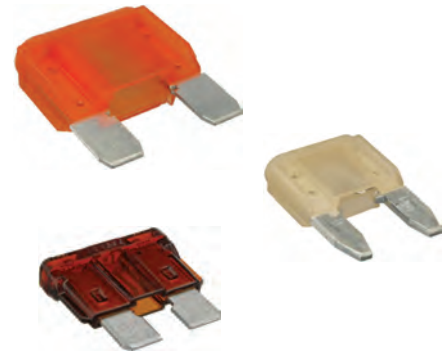

### ATO/Mini/PAL Fuses

804098

	Qty.
190056 . 7.5 Amp. Brown, ATO.....	20
190057 . 10 Amp. Red, ATO.....	20
190058 . 15 Amp. Blue, ATO.....	20
190059 . 20 Amp. Yellow, ATO.....	20
190061 . 30 Amp. Green, ATO.....	20
191469 . 7 Amp. Brown, Mini.....	15
191470 . 10 Amp. Red, Mini.....	15
191471 . 15 Amp. Blue, Mini.....	15
191472 . 20 Amp. Yellow, Mini.....	15
191474 . 30 Amp. Green, Mini.....	15
191628 . 30 Amp. Pink, PAL.....	1
191629 . 40 Amp. Green, PAL.....	1
191630 . 50 Amp. Red, PAL.....	1

	Qty.
191152 . 30 Amp. Pink, PAL.....	20
191153 . 40 Amp. Green, PAL.....	1
191970 . 50 Amp. Red, PAL.....	1
191830 . 25 Amp. Brown, PAL.....	1
191831 . 30 Amp. Green, PAL.....	1

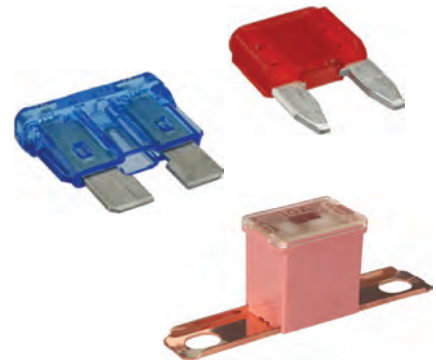

### Maxi Blade Fuses I

804099

	Qty.
191249 . 20 Amp. Yellow.....	2
191250 . 30 Amp. Green.....	6
191251 . 40 Amp. Orange.....	6
191252 . 50 Amp. Red.....	4
191253 . 60 Amp. Blue.....	4
191254 . 70 Amp. Beige.....	2
191255 . 80 Amp. Natural.....	2
210842 . Extractor.....	1



### DT Connectors

804100

	Qty.
192457 . 2-pole, female holder.....	3
192458 . 2-pole, male holder.....	3
192459 . 3-pole, female holder.....	3
192460 . 3-pole, male holder.....	3
192461 . 4-pole, female holder.....	3
192462 . 4-pole, male holder.....	3
192463 . 6-pole, female holder.....	3
192464 . 6-pole, male holder.....	3
192465 . 8-pole, female holder.....	3
192466 . 8-pole, male holder.....	3
192450 . 12-pole, female holder.....	3
192451 . 12-pole, male holder.....	3
192467 . 2-pole, Sekundary lock part ..	3
192468 . 2-pole, Sekundary lock part ..	3

	Qty.
192469 . 3-pole, Secondary lock part ..	3
192470 . 3-pole, Secondary lock part ..	3
192471 . 4-pole, Secondary lock part ..	3
192472 . 4-pole, Secondary lock part ..	3
192473 . 6-pole, Secondary lock part ..	3
192474 . 6-pole, Secondary lock part ..	3
192475 . 8-pole, Secondary lock part ..	3
192476 . 8-pole, Secondary lock part ..	3
192452 . 12-pole, Secondary lock part ..	3
192453 . 12-pole, Secondary lock part ..	3
192477 . Pin terminal.....	50
192478 . Socket terminal.....	50



**Heat Shrink Pipes II**

804101

	mm before crimp	mm after crimp	Qty. mtr.
193197	3	1	5
193198	6	2	3.5
193199	9	3	3
193200	12	4	2.5
193201	18	6	2
193202	24	8	1.5
06219	Display stand		1

Shrinking temp. 100 °C  
Shrink ration 3:1.

**Strip Fuses - Closed Type**

804102

		Qty.
192325	35 Amp	5
192326	50 Amp	5
192327	80 Amp	5
192328	100 Amp	5
192329	125 Amp	5
192330	160 Amp	5
192331	200 Amp	5
192332	250 Amp	5
192333	275 Amp	5
192334	300 Amp	5
192335	355 Amp	5
192336	425 Amp	5
192337	500 Amp	5
192344	Fuse holder	2

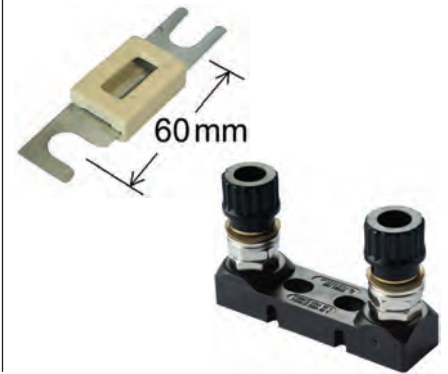
**Pin Terminals - Non-insulated II**

804103

	mm	mm <sup>2</sup>	Qty.		mm	mm <sup>2</sup>	Qty.
192174	0.4x1.5	0.35	50	191807	3	1x3	50
192089	1.5	1x1.5	50	192140	3.3	0.5x1	50
192090	1.5	1x1.5	50	191551	4	0.5x1.5	50
192410	1.8	0.5x1.25	50	192175	4.3	0.5x1	50
192217	2.7	0.5x1	50	192155	4.5	1.5x2.5	50
192239	2.8	0.5-1.5	50	191129	4.7	0.5x1.5	50
191083	2.8	0.5x1	50	191089	4.8	0.5x1	50
191681	2.8	0.5x1	50	192156	5	0.5x1	50
192411	2.8	0.5x1.25	50	192157	5	1.5x2.5	50
192240	2.8	0.5x1.5	50	192176	6	1x2.5	50
192373	2.8	0.5x1.5	50				
192374	2.8	0.5x1.5	50				
191806	3	1x3	50				

**Maxi Blade Fuses II**

804106

		Qty.
191249	20 Amp	10
191250	30 Amp	10
191251	40 Amp	10
191252	50 Amp	10
191253	60 Amp	10
191254	70 Amp	10
191255	80 Amp	10
191256	100 Amp	10
210842	Extractor	1
191775	Holder kit set	2



**DTM Connectors**
**804107**

	Qty.
192619 .. Male type .....	50
192620 .. Female type .....	50
192596 .. 2-pole male holder .....	3
192595 .. 2-pole female holder .....	3
192608 .. For 2-pole male holder .....	3
192607 .. For 2-pole female holder .....	3
192598 .. 3-pole male holder .....	3
192597 .. 3-pole female holder .....	3
192610 .. For 3-pole male holder .....	3
192609 .. For 3-pole female holder .....	3
192600 .. 4-pole male holder .....	3
192599 .. 4-pole female holder .....	3
192612 .. For 4-pole male holder .....	3
192611 .. For 4-pole female holder .....	3

	Qty.
192602 .. 6-pole male holder .....	3
192601 .. 6-pole female holder .....	3
192614 .. For 6-pole male holder .....	3
192613 .. For 6-pole female holder .....	3
192604 .. 8-pole male holder .....	3
192603 .. 8-pole female holder .....	3
192616 .. For 8-pole male holder .....	3
192615 .. For 8-pole female holder .....	3
192606 .. 12-pole male holder .....	3
192605 .. 12-pole female holder .....	3
192618 .. For 12-pole male holder .....	3
192617 .. For 12-pole female holder .....	3

**Cable Lugs**
**804110**

	mm <sup>2</sup>	Ring	Qty.
192906 .....	4-6	M8	10
192908 .....	6-10	M6	10
192909 .....	6-10	M8	10
192910 .....	6-10	M10	10
192911 .....	10-16	M6	10
192912 .....	10-16	M8	10
192913 .....	10-16	M10	10
192915 .....	16-25	M6	10
192916 .....	16-25	M8	10
192917 .....	16-25	M10	10
192920 .....	25-35	M8	10
192921 .....	25-35	M10	10
192922 .....	35-35	M12	10
192923 .....	35-50	M8	10

	mm <sup>2</sup>	Ring	Qty.
192924 .....	35-50	M10	10
192925 .....	35-50	M12	10
192926 .....	50-70	M8	8
192927 .....	50-70	M10	8



**Thin Wall Cables**
**804113**

193012 .....	1x0.35 mm <sup>2</sup>	Black
193013 .....	1x0.35 mm <sup>2</sup>	Red
193014 .....	1x0.5 mm <sup>2</sup>	Black
193015 .....	1x0.5 mm <sup>2</sup>	Red

**Fuses - Micro / Mini Low Profile / PAL - Assortment**
**804117**

	Qty.
193213 .. 5 Amp. Tan, Micro .....	10
193214 .. 7.5 Amp. Brown, Micro .....	10
193215 .. 10 Amp. Red, Micro .....	10
193216 .. 15 Amp. Blue, Micro .....	10
193217 .. 20 Amp. Yellow, Micro .....	10
193218 .. 25 Amp. Natural, Micro .....	10
193219 .. 30 Amp. Green, Micro .....	10
192762 .. 2 Amp. Grey, Mini .....	10
192763 .. 3 Amp. Violet, Mini .....	10
192764 .. 4 Amp. Pink, Mini .....	10
192765 .. 5 Amp. Tan, Mini .....	10
192766 .. 7.5 Amp. Brown, Mini .....	10
192767 .. 10 Amp. Red, Mini .....	10
192768 .. 15 Amp. Blue, Mini .....	10

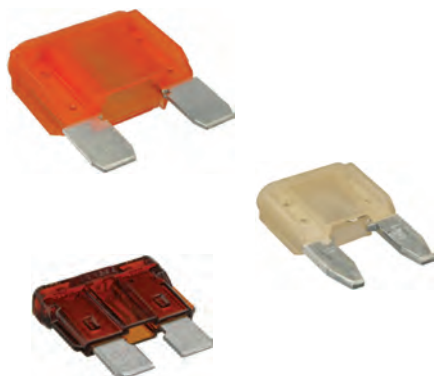
	Qty.
192769 .. 20 Amp. Yellow, Mini .....	10
192770 .. 25 Amp. Natural, Mini .....	10
192771 .. 30 Amp. Green, Mini .....	10
192779 .. 20 Amp. Blue, PAL .....	2
192780 .. 25 Amp. White, PAL .....	2
192781 .. 30 Amp. Pink, PAL .....	2
192782 .. 40 Amp. Green, PAL .....	2
192783 .. 50 Amp. Red, PAL .....	2
192784 .. 60 Amp. Yellow, PAL .....	2



**Hose Nipples**

807002

	Hose ID	Qty.
070067	. R 1/4" ..... 10.0 mm.	3
080855	. R 1/2" ..... 10.0 mm.	3
070077	. 1/8-27 NPTF ..... 6.0 mm.	3
080955	. 1/8-27 NPFT ..... 8.0 mm.	3
080857	. 1/2" -20 UNF ..... 8.0 mm.	3
080960	. 1/2" -20 UNF ..... 10.0 mm.	3
080954	. M14-1.5 ..... 6.0 mm.	3
080854	. M14-1.5 ..... 8.0 mm.	3
080959	. M14-1.5 ..... 10.0 mm.	3
080858	. M16-1.5 ..... 8.0 mm.	3
070070	. M16-1.5 ..... 10.0 mm.	3
080958	. M18-1.5 ..... 10.0 mm.	3

**Toggle Switches**

808014

	Qty.
180584 ... Toggle switch, 2 terminals	2
180585 ... Toggle switch, 3 terminals	2
180586 ... Toggle switch, 3 terminals	2
180587 ... Toggle switch, 3 terminals	2
180588 ... Toggle switch, 3 terminals	2
180589 ... Toggle switch, 3 terminals	2
180590 ... Toggle switch, 4 terminals	2
180591 ... Toggle switch, 6 terminals	2
180592 ... Toggle switch, 6 terminals	2
180593 ... Toggle switch, 6 terminals	2
180594 ... Toggle switch, 6 terminals	2
180595 ... Rubber cap	5
181672 ... Rubber cap	5

**Mini Rocker Switches**

808015

	Qty.
180597 ... 2 terminals, On/Off,	10
180598 ... 3 terminals, On/Off, amber	10
180599 ... 3 terminals, On/Off, red	10
180600 ... 3 terminals, On/On	10
180601 ... 3 terminals, On/Off,	
red spot diode	10
180628 ... 3 terminals, On/Off, green	10
180627 ... 3 terminals, On/Off, blue	10

**Mini Relays 12 V**

811001

	Qty.
160080 ... 30 Amp 4 terminals	6
160081 ... 20/30 Amp 4 terminals	6
160083 ... 30 Amp 4 terminals	2
160155 ... 15 Amp 4 terminals	2
160168 ... 2 x 15 Amp 5 terminals	2
160239 ... 70 Amp 4 terminals	2
160265 ... 30 Amp 5 terminals	2
160270 ... 20/30 Amp 5 terminals	2
160282 ... 40 Amp 4 terminals	6
160308 ... 20/30 Amp 5 terminals	6
160403 ... 15/40 Amp 5 terminals	2
160468 ... 70 Amp 4 terminals	2



## Micro Relays

811004

	Qty.
160363 25 Amp 4 terminals .....	2
160364 Normally open w/ diode .....	2
160365 Change over 12 V. 10/20 Amp.....	2
160366 Change over w/ diode.....	2
160367 Change over w/ resistor .....	2
160368 Change over 24 V. 4/10 Amp. ...	2
160521 5/10 Amp. 5 terminals .....	2
191089 Terminal 4.7 mm. 0.5-1.0 mm <sup>2</sup> . 100	
190868 Terminal 6.3 mm. 0.5-1.0 mm <sup>2</sup> . 100	
190252 Terminal 6.3 mm. 1.0-2.5 mm <sup>2</sup> . 100	
191752 Relay multi plug.....	10





# Cross Reference List

## OE No. - HC-CARGO No.

Edition 2016/2017

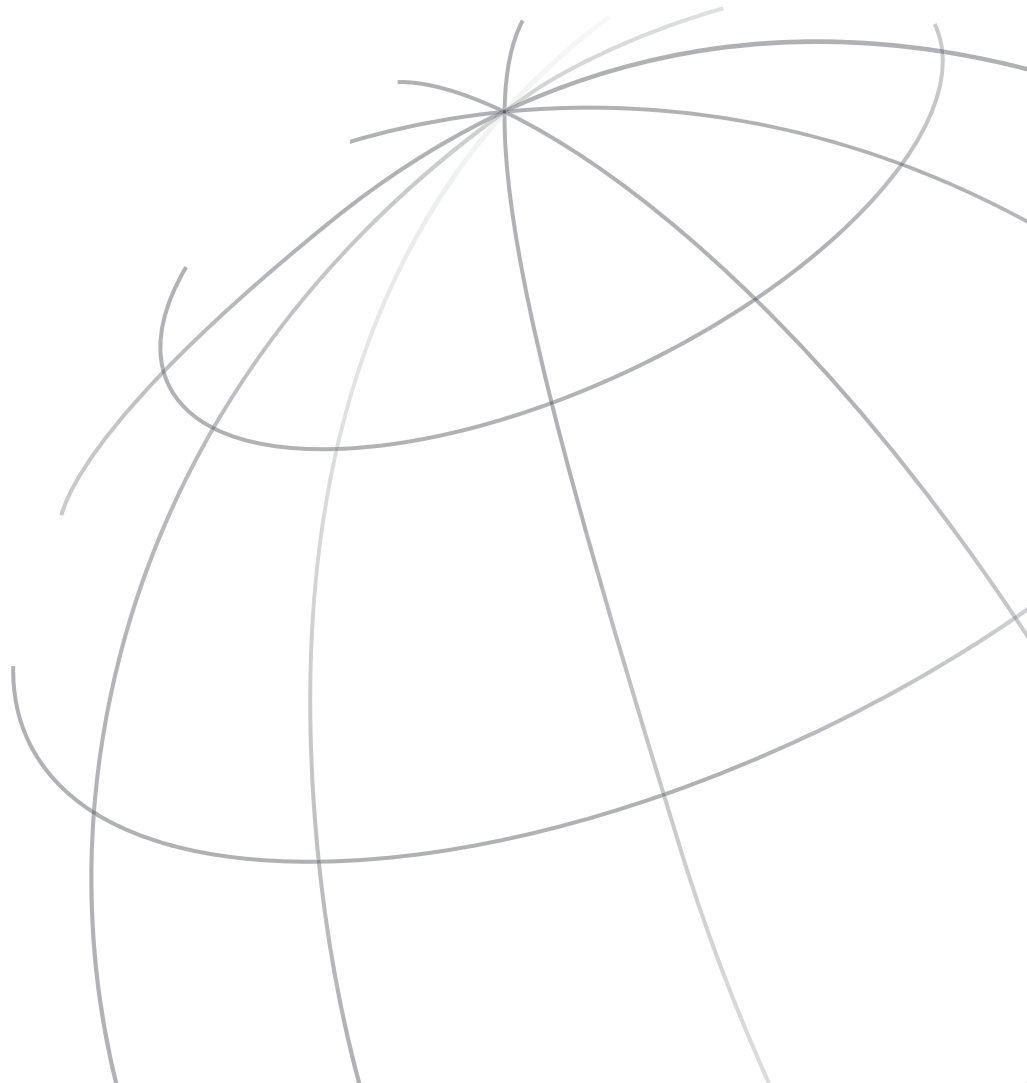





OE No.	HC-CARGO	OE No.	HC-CARGO	OE No.	HC-CARGO	OE No.	HC-CARGO
0100266008	100624	727MJ	100511	GN107	100670	11781734393	181586
0100266009	100625	730MJ	100320	GN109	100653	11781735345	181586
0100266011	100652	749MJ	100245	GN855	100436	11781735710	181586
0100266016	100673	783MJ	100307	GN858	100331	11781738331	181586
0100271101	100614	819MJ	100616	GN912	100335	11781739642	181586
0100271103	100614	823MJ	100614	GN939	100561	11781741317	181586
0100276002	100622	844MJ	100512	GN961	100337	11781742023	181586
0100276004	100593	853MJ	100306	GN963	100532	11781747005	181586
0100276005	100622	854MJ	100306	GN967	100283	11787530285	181590
0100276006	100622	855MJ	100436	GN970	100650	11787530287	181590
0100276007	100627	857MJ	100512	GN984	100669	11787539125	181591
0100276008	100627	858MJ	100331	GN992	100544	11787539126	181591
0100276012	100663	860MJ	100327	GN993	100565	11787539137	181591
0100276015	100642	885MJ	100280	GR001	160420	11787544654	181591
0100800031	100653	886MJ	100257	GR031	160421	11787544655	181591
0101022604	100177	889MJ	100251	GR034	160432	11787545074	181591
0101072405	100580	890MJ	100252	GR049	160442	11787545075	181591
0101072603	100177	892MJ	100254	GR054	160436	1179232	070053
105MN	100511	894MJ	100258	GR059	160423	12121286059	100511
107MJ	100262	895MJ	100259	GR061	160451	12121288161	100511
108MJ	100262	905MJ	100323	GR064	160416	12121357296	150395
112M	100263	909MJ	100511	GR065	160424	12141244089	150056
124MJ	100262	912MJ	100335	GR066	160425	12141244191	150056
137MJ	100086	918MJ	100303	GR067	160438	12141244226	150056
141MJ	100512	920MJ	100271	GV107	100583	12141244477	150056
151MJ	100511	921MJ	100287	GV153	100656	12141244481	150056
153MJ	100656	946MJ	100292	GV155	100566	12141266702	150055
154GS	100177	947MJ	100426	GV626	100295	12141273217	150055
161MJ	100511	948MJ	100339	GV657	100284	12141273298	150055
162MJ	100512	950MJ	100436	GV666	100303	12141274698	150055
171MJ	100262	954MJ	100511	GV823	100614	12141461441	150379
2901520015	080388	961MJ	100337	GV889	100251	12230035934	100679
348GK	100079	966MJ	100531	GV920	100271	12232248059	100536
382GK	100079	967MJ	100283	GV968	100260	12237786869	100641
502MJ	100245	968MJ	100291	WS015	080388	12237803368	100679
512MJ	100252	969MJ	100282	ZM001	150055	12411266702	150055
513MJ	100247	999MJ	100529	ZM002	150056	12512247471	192902
514MJ	100254	GE100	100624	ZM003	150057	1277565	181584
515MJ	100258	GE101	100625	ZS234	150252	12781405324	181588
517MJ	100280	GE102	100641	ZS259	150521	13532247156	081115
518MJ	100259	GE105	100652			13537785722	081209
551MJ	100251	GE108	100673	<b>BMW</b>		1354273	180648
555MJ	100260	GF859	100580	1115862	070053	13621284397	180875
557MJ	100257	GN003	100537	11621308366	181585	13621401945	180875
571MJ	100271	GN005	100515	11621308367	181585	13621422567	181500
576MJ	100276	GN007	100527	11761277565	181584	13621433565	181500
577MJ	100277	GN008	100538	11761466063	181584	13621709966	180875
580MJ	100280	GN012	100540	11761707391	181585	13622247074	181500
582MJ	100282	GN013	100541	11761714772	181586	13627787076	181500
583MJ	100283	GN016	100335	11781247406	181588	13631273139	160416
587MJ	100287	GN017	100534	11781247475	181586	13631276264	160352
591MJ	100291	GN018	100684	11781266736	181584	1364272	181034
592MJ	100292	GN019	100592	11781271670	181584	13712247002	181500
601MJ	100511	GN020	100671	11781277565	181584	13781405324	181588
602MJ	100511	GN022	100531	11781286638	181585	14781405324	181588
603MJ	100511	GN024	100536	11781286838	181585	15781405324	181588
604MJ	100303	GN026	100646	11781310838	181585	16121115862	070053
605MJ	100511	GN027	100533	11781310860	181585	16141178751	070053
607MJ	100511	GN030	100639	11781405324	181588	16141179232	070053
609MJ	100511	GN033	100594	11781464492	181589	16781405324	181588
611MJ	100295	GN035	100595	11781468620	181586	17781405324	181588
613MJ	100511	GN039	100666	11781468621	181586	18781405324	181588
626MJ	100295	GN041	100645	11781468630	181586	19781405324	181588
627MJ	100511	GN042	100590	11781702951	181586	20781405324	181588
631MJ	100303	GN043	100283	11781704259	181586	21781405324	181588
633MJ	100511	GN045	100622	11781714772	181586	22781405324	181588
636MJ	100511	GN046	100527	11781714873	181589	23781405324	181588
642MJ	100511	GN047	100593	11781715263	181585	24781405324	181588
654MJ	100511	GN050	100667	11781716114	181586	25781405324	181588
657MJ	100284	GN053	100627	11781716156	181585	26781405324	181588
661MJ	100303	GN054	100674	11781720019	181586	27781405324	181588
666MJ	100303	GN055	100675	11781720536	181586	28781405324	181588
673MJ	100246	GN056	100663	11781720672	181586	29781405324	181588
678MJ	100256	GN059	100642	11781720860	181586	30781405324	181588
688MJ	100260	GN061	100657	11781727451	181586	31781405324	181588
705MJ	100261	GN062	100661	11781730005	181586	32781405324	181588
718MJ	100331	GN063	100664	11781730007	181586	61311243414	180648
719MJ	100545	GN104	100555	11781734345	181586	61311350645	180734
725MJ	100436	GN106	100662	11781734390	181586	61311351799	180634

OE No.	HC-CARGO	OE No.	HC-CARGO	OE No.	HC-CARGO	OE No.	HC-CARGO
<b>BMW continued</b>							
61311354272	180648	0227100124	150098	0250201038	100339	0250204001	100593
61311354273	180648	0227100126	150154	0250201039	100511	0250204002	100663
61311354274	180648	0227100129	150154	0250201041	100331	0250212009	100684
61311357073	181034	0227100136	150154	0250201042	100541	0250312001	100302
61311364272	181034	0227100137	150056	0250201049	100531	0250312002	100326
61311368786	180734	0227100138	150056	0250201050	100512	0250312003	100513
61311378830	180734	0227100139	150056	0250201053	100639	0250312007	100510
61311379830	180734	0227100140	150057	0250201405	100511	0250402001	100624
61661367616	160197	0227100142	150075	0250201415	100511	0250402002	100641
61661368569	160197	0227100143	150075	0250201904	100511	0250403002	100625
61661368585	160197	0227100147	150075	0250201905	100512	0250403003	100660
61661368589	160197	0227100148	150055	0250201933	160420	0250603001	100676
61661380066	160680	0227100200	150379	0250201952	160424	0250603006	100679
64116923204	160765	0227100201	150379	0250202001	100303	0250603008	100665
64116929486	160765	0227100203	150387	0250202002	100320	0257100010	100177
64116931680	160765	0227100204	150379	0250202003	100246	0258001012	181584
64118364173	160765	0227100208	150387	0250202004	100256	0258001014	181584
64118377579	160765	0227100209	150409	0250202006	100260	0258001021	181584
64118383835	160765	0227100210	150409	0250202007	100261	0258001025	181584
64118385549	160765	0227100211	150406	0250202008	100245	0258001026	181584
7786869	100641	0227100212	150406	0250202009	100436	0258001027	181584
		0227100213	150379	0250202014	100251	0258001028	181584
		0227100214	150387	0250202017	100254	0258001029	181584
		0227100215	150379	0250202018	100303	0258001031	181584
<b>BOMAG</b>		0227200005	150056	0250202020	100335	0258001032	181584
05716363	090015	0232101009	150496	0250202021	100432	0258001035	181584
05726030	080390	0232101023	150496	0250202022	100436	0258001037	181584
05726781	090076	0232101030	150496	0250202023	100527	0258001038	181584
05727558	080692	0250001008	100079	0250202024	100432	0258001039	181584
09331628	080696	0250001012	100079	0250202025	100323	0258001040	181584
		0250001016	100079	0250202026	100337	0258001041	181584
		0250001416	100079	0250202028	100534	0258001042	181584
		0250001782	100674	0250202029	100537	0258001043	181584
		0250200001	100583	0250202030	100659	0258001044	181584
		0250200014	100583	0250202032	100533	0258001047	181584
		0250200020	100583	0250202034	100650	0258001051	181584
		0250200035	100263	0250202035	100532	0258001052	181584
		0250200037	100566	0250202036	100645	0258001060	181584
		0250200051	100086	0250202038	100675	0258001061	181584
		0250200052	100512	0250202040	100307	0258001062	181584
		0250200053	100284	0250202042	100544	0258001063	181584
		0250200054	100511	0250202043	100594	0258001064	181584
		0250200055	100583	0250202046	100527	0258001097	181584
		0250200056	100511	0250202051	100257	0258001248	181584
		0250200058	100511	0250202052	100283	0258001929	181584
		0250200059	100511	0250202053	100291	0258001931	181584
		0250200060	100511	0250202054	100258	0258001947	181584
		0250200061	100511	0250202060	100287	0258001960	181584
		0250200063	100512	0250202064	100276	0258001961	181584
		0250200064	100656	0250202065	100657	0258001962	181584
		0250200065	100511	0250202069	100252	0258001963	181584
		0250200066	100303	0250202073	100277	0258001964	181584
		0250200068	100511	0250202076	100259	0258002014	181584
		0250200069	100511	0250202077	100271	0258002024	181584
		0250200420	100262	0250202085	100292	0258002029	181584
		0250200451	100086	0250202087	100426	0258002030	181584
		0250200454	100511	0250202089	100515	0258002035	181584
		0250200456	100511	0250202090	100668	0258002038	181584
		0250200464	100656	0250202092	100670	0258002040	181584
		0250200465	100511	0250202093	100306	0258002041	181584
		0250200468	100511	0250202094	100246	0258002044	181584
		0250201001	100511	0250202095	100283	0258002049	181584
		0250201004	100511	0250202096	100260	0258002050	181584
		0250201006	100511	0250202102	100538	0258002052	181584
		0250201008	100511	0250202103	100536	0258002053	181584
		0250201009	100511	0250202105	100658	0258002054	181584
		0250201010	100295	0250202110	100247	0258002055	181584
		0250201011	100511	0250202119	100280	0258002057	181584
		0250201012	100284	0250202120	100658	0258002061	181584
		0250201015	100511	0250202121	100559	0258002203	181584
		0250201017	100303	0250202125	100556	0258002909	181584
		0250201019	100511	0250202126	100548	0258002919	181584
		0250201022	100640	0250202128	100646	0258003001	181585
		0250201026	100331	0250202129	100592	0258003003	181585
		0250201027	100545	0250202130	100561	0258003004	181585
		0250201031	100512	0250202135	100674	0258003005	181585
		0250201032	100512	0250202254	100614	0258003006	181585
		0250201033	100511	0250203001	100642	0258003008	181585
		0250201035	100327	0250203004	100622	0258003009	181585

OE No.	HC-CARGO	OE No.	HC-CARGO	OE No.	HC-CARGO	OE No.	HC-CARGO
0258003010	181585	0258003099	181585	0258003192	181587	0258003289	181586
0258003011	181585	0258003101	181585	0258003193	181589	0258003290	181589
0258003012	181585	0258003102	181585	0258003194	181585	0258003291	181589
0258003013	181585	0258003103	181589	0258003195	181586	0258003292	181589
0258003014	181585	0258003104	181585	0258003196	181586	0258003293	181585
0258003015	181585	0258003105	181585	0258003197	181586	0258003294	181585
0258003016	181587	0258003106	181585	0258003198	181586	0258003297	181585
0258003017	181585	0258003108	181586	0258003199	181586	0258003298	181585
0258003018	181585	0258003109	181586	0258003200	181586	0258003299	181585
0258003019	181585	0258003112	181585	0258003201	181585	0258003300	181585
0258003020	181587	0258003113	181585	0258003202	181586	0258003301	181589
0258003021	181585	0258003114	181587	0258003203	181589	0258003302	181589
0258003023	181585	0258003115	181587	0258003204	181586	0258003303	181589
0258003024	181585	0258003116	181587	0258003206	181585	0258003304	181589
0258003025	181585	0258003117	181587	0258003209	181585	0258003305	181587
0258003026	181585	0258003118	181589	0258003211	181585	0258003306	181587
0258003027	181585	0258003119	181587	0258003212	181585	0258003307	181590
0258003028	181585	0258003120	181589	0258003213	181585	0258003308	181587
0258003030	181585	0258003122	181585	0258003215	181586	0258003309	181589
0258003031	181585	0258003123	181585	0258003216	181589	0258003310	181586
0258003032	181585	0258003125	181590	0258003217	181589	0258003311	181585
0258003034	181587	0258003127	181590	0258003218	181590	0258003312	181585
0258003035	181585	0258003128	181590	0258003219	181586	0258003313	181585
0258003036	181585	0258003129	181590	0258003220	181586	0258003314	181586
0258003037	181589	0258003130	181585	0258003222	181589	0258003315	181586
0258003038	181586	0258003131	181585	0258003223	181590	0258003316	181586
0258003039	181585	0258003132	181585	0258003224	181590	0258003317	181586
0258003040	181585	0258003133	181585	0258003225	181590	0258003318	181589
0258003041	181585	0258003134	181585	0258003226	181590	0258003319	181589
0258003043	181585	0258003135	181585	0258003227	181590	0258003320	181589
0258003044	181585	0258003136	181585	0258003228	181590	0258003321	181589
0258003045	181586	0258003137	181585	0258003229	181589	0258003322	181589
0258003046	181585	0258003138	181585	0258003231	181586	0258003323	181589
0258003047	181585	0258003139	181585	0258003232	181585	0258003324	181589
0258003048	181585	0258003140	181585	0258003233	181585	0258003325	181589
0258003049	181585	0258003141	181585	0258003236	181586	0258003326	181586
0258003050	181585	0258003142	181585	0258003237	181586	0258003327	181586
0258003051	181589	0258003143	181585	0258003238	181589	0258003328	181586
0258003052	181589	0258003144	181587	0258003239	181589	0258003329	181586
0258003054	181585	0258003145	181587	0258003240	181589	0258003330	181590
0258003056	181585	0258003146	181587	0258003241	181587	0258003331	181585
0258003057	181585	0258003147	181587	0258003242	181587	0258003332	181585
0258003058	181585	0258003148	181587	0258003243	181585	0258003333	181589
0258003059	181585	0258003149	181587	0258003244	181586	0258003334	181586
0258003060	181585	0258003150	181587	0258003245	181585	0258003335	181588
0258003061	181585	0258003151	181587	0258003246	181585	0258003336	181588
0258003062	181586	0258003152	181587	0258003247	181587	0258003337	181585
0258003063	181585	0258003153	181587	0258003248	181587	0258003338	181586
0258003064	181586	0258003154	181585	0258003249	181587	0258003339	181590
0258003065	181588	0258003155	181585	0258003250	181587	0258003340	181590
0258003067	181586	0258003156	181585	0258003251	181589	0258003341	181590
0258003068	181586	0258003157	181585	0258003252	181589	0258003342	181590
0258003069	181586	0258003160	181585	0258003253	181589	0258003343	181590
0258003070	181587	0258003161	181585	0258003254	181587	0258003346	181587
0258003072	181585	0258003162	181585	0258003256	181585	0258003347	181587
0258003073	181585	0258003163	181586	0258003257	181585	0258003349	181585
0258003074	181589	0258003164	181585	0258003258	181587	0258003351	181587
0258003075	181585	0258003165	181585	0258003259	181589	0258003352	181589
0258003076	181589	0258003166	181585	0258003260	181586	0258003353	181586
0258003077	181585	0258003169	181587	0258003261	181586	0258003354	181586
0258003078	181589	0258003170	181587	0258003262	181589	0258003355	181589
0258003079	181587	0258003171	181587	0258003263	181585	0258003356	181588
0258003080	181585	0258003172	181587	0258003264	181585	0258003357	181586
0258003081	181585	0258003173	181585	0258003267	181586	0258003358	181589
0258003082	181585	0258003174	181585	0258003268	181586	0258003359	181586
0258003083	181587	0258003175	181585	0258003271	181586	0258003360	181589
0258003084	181585	0258003177	181590	0258003273	181585	0258003363	181587
0258003085	181587	0258003178	181590	0258003274	181585	0258003365	181589
0258003086	181585	0258003181	181585	0258003275	181590	0258003366	181589
0258003087	181589	0258003182	181585	0258003276	181585	0258003367	181589
0258003088	181586	0258003183	181590	0258003277	181585	0258003368	181589
0258003090	181585	0258003184	181590	0258003278	181587	0258003369	181588
0258003091	181587	0258003185	181590	0258003279	181585	0258003370	181585
0258003092	181587	0258003186	181590	0258003283	181585	0258003373	181589
0258003093	181585	0258003187	181590	0258003284	181585	0258003374	181588
0258003094	181585	0258003188	181590	0258003285	181587	0258003375	181588
0258003095	181587	0258003189	181585	0258003286	181585	0258003376	181585
0258003096	181585	0258003190	181585	0258003287	181585	0258003377	181587
0258003097	181585	0258003191	181587	0258003288	181586	0258003378	181587

OE No.	HC-CARGO	OE No.	HC-CARGO	OE No.	HC-CARGO	OE No.	HC-CARGO
<b>BOSCH continued</b>							
0258003379	181587	0258003481	181590	0258003590	181590	0258003709	181586
0258003380	181587	0258003483	181585	0258003591	181590	0258003710	181586
0258003381	181585	0258003484	181590	0258003592	181588	0258003711	181590
0258003382	181590	0258003485	181590	0258003593	181588	0258003712	181590
0258003383	181590	0258003486	181590	0258003594	181588	0258003713	181590
0258003384	181590	0258003492	181590	0258003596	181586	0258003714	181590
0258003385	181590	0258003494	181590	0258003597	181586	0258003715	181585
0258003386	181590	0258003496	181590	0258003598	181586	0258003716	181589
0258003387	181590	0258003498	181590	0258003599	181586	0258003717	181589
0258003388	181590	0258003499	181590	0258003600	181586	0258003718	181589
0258003389	181590	0258003500	181590	0258003601	181586	0258003719	181589
0258003390	181589	0258003503	181585	0258003602	181586	0258003721	181588
0258003391	181586	0258003504	181585	0258003603	181588	0258003722	181588
0258003392	181590	0258003505	181585	0258003604	181586	0258003723	181588
0258003393	181585	0258003506	181590	0258003605	181586	0258003725	181590
0258003394	181588	0258003507	181590	0258003607	181590	0258003726	181590
0258003395	181588	0258003508	181585	0258003611	181588	0258003727	181590
0258003396	181585	0258003509	181585	0258003621	181590	0258003729	181590
0258003397	181585	0258003510	181585	0258003622	181585	0258003731	181590
0258003398	181590	0258003512	181586	0258003623	181585	0258003733	181590
0258003399	181590	0258003513	181589	0258003624	181585	0258003736	181588
0258003401	181590	0258003514	181589	0258003625	181585	0258003737	181588
0258003402	181590	0258003515	181589	0258003626	181588	0258003740	181588
0258003403	181586	0258003516	181589	0258003627	181589	0258003741	181588
0258003414	181588	0258003517	181586	0258003629	181590	0258003742	181585
0258003415	181588	0258003518	181588	0258003630	181588	0258003743	181585
0258003417	181585	0258003521	181590	0258003631	181588	0258003744	181587
0258003418	181585	0258003522	181586	0258003632	181586	0258003745	181588
0258003419	181585	0258003523	181586	0258003633	181586	0258003746	181588
0258003420	181585	0258003524	181585	0258003634	181585	0258003748	181588
0258003421	181585	0258003525	181585	0258003635	181585	0258003749	181588
0258003422	181587	0258003526	181588	0258003636	181589	0258003750	181588
0258003423	181590	0258003528	181586	0258003637	181589	0258003751	181588
0258003425	181588	0258003533	181590	0258003638	181588	0258003752	181588
0258003426	181586	0258003535	181590	0258003639	181588	0258003754	181586
0258003427	181586	0258003537	181590	0258003640	181588	0258003757	181588
0258003428	181586	0258003538	181586	0258003641	181588	0258003758	181588
0258003429	181586	0258003539	181586	0258003642	181588	0258003759	181590
0258003430	181586	0258003540	181589	0258003643	181588	0258003760	181590
0258003431	181586	0258003541	181590	0258003644	181590	0258003762	181590
0258003432	181586	0258003542	181588	0258003645	181588	0258003763	181587
0258003433	181586	0258003543	181588	0258003648	181589	0258003764	181587
0258003434	181586	0258003544	181590	0258003649	181589	0258003765	181587
0258003436	181588	0258003548	181586	0258003652	181585	0258003766	181587
0258003439	181586	0258003549	181586	0258003653	181585	0258003769	181589
0258003440	181586	0258003550	181588	0258003654	181588	0258003770	181589
0258003441	181587	0258003551	181588	0258003655	181588	0258003771	181588
0258003443	181586	0258003552	181588	0258003656	181588	0258003772	181589
0258003444	181586	0258003553	181588	0258003657	181588	0258003773	181588
0258003445	181585	0258003554	181587	0258003658	181588	0258003774	181585
0258003446	181585	0258003555	181587	0258003659	181590	0258003775	181590
0258003447	181585	0258003556	181590	0258003660	181590	0258003776	181590
0258003448	181585	0258003557	181590	0258003661	181588	0258003778	181590
0258003450	181589	0258003558	181588	0258003662	181588	0258003779	181590
0258003451	181589	0258003559	181588	0258003664	181586	0258003780	181590
0258003453	181586	0258003560	181586	0258003666	181586	0258003781	181590
0258003456	181590	0258003561	181588	0258003667	181589	0258003782	181588
0258003457	181590	0258003564	181588	0258003669	181589	0258003783	181588
0258003458	181588	0258003567	181589	0258003671	181589	0258003784	181586
0258003459	181588	0258003568	181589	0258003672	181589	0258003785	181586
0258003460	181586	0258003569	181585	0258003673	181589	0258003786	181586
0258003461	181585	0258003570	181589	0258003674	181586	0258003787	181586
0258003462	181589	0258003571	181589	0258003678	181590	0258003788	181586
0258003463	181589	0258003572	181589	0258003679	181590	0258003789	181586
0258003464	181589	0258003573	181589	0258003681	181590	0258003790	181586
0258003465	181586	0258003574	181589	0258003683	181590	0258003791	181586
0258003466	181589	0258003575	181586	0258003684	181588	0258003792	181586
0258003467	181590	0258003576	181586	0258003685	181588	0258003793	181586
0258003468	181590	0258003577	181588	0258003686	181589	0258003794	181588
0258003469	181589	0258003578	181589	0258003687	181586	0258003795	181588
0258003470	181588	0258003579	181589	0258003689	181588	0258003797	181588
0258003472	181590	0258003580	181588	0258003692	181588	0258003798	181588
0258003473	181585	0258003581	181588	0258003693	181588	0258003799	181588
0258003474	181585	0258003582	181588	0258003698	181588	0258003800	181588
0258003475	181588	0258003583	181588	0258003699	181588	0258003801	181588
0258003476	181588	0258003584	181589	0258003700	181586	0258003802	181588
0258003477	181588	0258003585	181589	0258003703	181585	0258003805	181589
0258003478	181588	0258003586	181586	0258003704	181585	0258003806	181588
0258003479	181588	0258003588	181586	0258003705	181586	0258003807	181588

OE No.	HC-CARGO	OE No.	HC-CARGO	OE No.	HC-CARGO	OE No.	HC-CARGO
0258003808	181589	0258003999	181585	0258005135	181590	0258005244	181588
0258003809	181589	0258005001	181590	0258005136	181590	0258005245	181588
0258003810	181586	0258005002	181590	0258005138	181588	0258005246	181587
0258003811	181588	0258005003	181588	0258005139	181588	0258005247	181588
0258003812	181588	0258005004	181588	0258005141	181590	0258005249	181590
0258003813	181590	0258005005	181588	0258005142	181590	0258005251	181590
0258003814	181590	0258005006	181588	0258005143	181588	0258005253	181590
0258003815	181590	0258005007	181588	0258005144	181588	0258005254	181590
0258003816	181590	0258005009	181590	0258005147	181586	0258005255	181590
0258003817	181588	0258005011	181590	0258005148	181586	0258005256	181590
0258003819	181590	0258005013	181590	0258005149	181586	0258005257	181586
0258003820	181588	0258005015	181590	0258005150	181586	0258005258	181588
0258003821	181585	0258005017	181590	0258005151	181586	0258005259	181588
0258003822	181585	0258005019	181590	0258005152	181586	0258005260	181587
0258003823	181588	0258005021	181590	0258005153	181588	0258005261	181590
0258003824	181588	0258005023	181590	0258005154	181588	0258005262	181590
0258003827	181585	0258005024	181588	0258005155	181588	0258005263	181590
0258003828	181585	0258005025	181588	0258005156	181589	0258005264	181590
0258003829	181586	0258005026	181588	0258005157	181589	0258005265	181590
0258003830	181586	0258005027	181588	0258005160	181588	0258005266	181590
0258003832	181585	0258005030	181586	0258005161	181588	0258005267	181589
0258003833	181585	0258005034	181590	0258005162	181590	0258005268	181589
0258003835	181590	0258005036	181590	0258005163	181590	0258005269	181589
0258003837	181590	0258005038	181590	0258005164	181590	0258005270	181588
0258003839	181590	0258005047	181589	0258005169	181590	0258005271	181588
0258003840	181588	0258005051	181589	0258005170	181588	0258005272	181589
0258003841	181585	0258005052	181590	0258005171	181588	0258005273	181589
0258003842	181588	0258005053	181590	0258005172	181588	0258005274	181585
0258003843	181588	0258005054	181588	0258005173	181588	0258005275	181585
0258003848	181588	0258005055	181590	0258005174	181590	0258005276	181589
0258003852	181585	0258005058	181586	0258005175	181588	0258005277	181589
0258003853	181585	0258005059	181586	0258005176	181588	0258005278	181589
0258003854	181588	0258005061	181590	0258005177	181588	0258005279	181589
0258003855	181590	0258005062	181588	0258005178	181586	0258005280	181588
0258003856	181590	0258005063	181588	0258005179	181588	0258005281	181588
0258003860	181588	0258005065	181588	0258005180	181588	0258005283	181588
0258003861	181588	0258005070	181590	0258005181	181587	0258005284	181589
0258003862	181588	0258005071	181590	0258005182	181588	0258005285	181589
0258003863	181588	0258005074	181588	0258005183	181588	0258005286	181589
0258003864	181588	0258005078	181588	0258005184	181588	0258005287	181589
0258003865	181588	0258005079	181588	0258005185	181588	0258005289	181585
0258003868	181586	0258005080	181588	0258005186	181588	0258005292	181590
0258003869	181586	0258005081	181588	0258005187	181588	0258005293	181590
0258003870	181590	0258005082	181588	0258005189	181588	0258005294	181590
0258003871	181590	0258005083	181590	0258005191	181590	0258005295	181590
0258003872	181590	0258005084	181590	0258005192	181586	0258005296	181590
0258003873	181590	0258005087	181589	0258005197	181590	0258005297	181588
0258003890	181590	0258005088	181588	0258005200	181588	0258005298	181588
0258003891	181590	0258005089	181588	0258005201	181588	0258005302	181590
0258003892	181585	0258005090	181588	0258005202	181588	0258005303	181588
0258003893	181590	0258005091	181588	0258005203	181588	0258005304	181588
0258003894	181590	0258005092	181588	0258005205	181588	0258005305	181588
0258003895	181588	0258005093	181588	0258005206	181588	0258005306	181588
0258003896	181588	0258005094	181588	0258005207	181588	0258005308	181585
0258003897	181585	0258005095	181588	0258005208	181588	0258005309	181588
0258003898	181585	0258005096	181586	0258005209	181588	0258005310	181588
0258003913	181585	0258005097	181588	0258005210	181588	0258005311	181588
0258003915	181585	0258005098	181588	0258005213	181589	0258005312	181590
0258003918	181585	0258005099	181588	0258005214	181589	0258005314	181586
0258003924	181585	0258005109	181588	0258005215	181589	0258005315	181586
0258003925	181585	0258005110	181590	0258005216	181589	0258005316	181586
0258003926	181585	0258005112	181588	0258005219	181588	0258005317	181586
0258003930	181585	0258005113	181588	0258005220	181588	0258005318	181586
0258003931	181585	0258005115	181590	0258005221	181588	0258005321	181588
0258003936	181585	0258005116	181590	0258005222	181588	0258005322	181586
0258003942	181585	0258005119	181588	0258005223	181585	0258005323	181586
0258003943	181585	0258005121	181588	0258005224	181585	0258005324	181586
0258003950	181585	0258005123	181588	0258005226	181589	0258005325	181586
0258003953	181585	0258005124	181588	0258005227	181589	0258005327	181586
0258003956	181585	0258005125	181589	0258005228	181586	0258005328	181585
0258003957	181585	0258005126	181586	0258005229	181586	0258005329	181585
0258003965	181588	0258005127	181586	0258005236	181588	0258005334	181585
0258003970	181587	0258005128	181586	0258005237	181588	0258005335	181588
0258003972	181585	0258005129	181586	0258005238	181585	0258005650	181590
0258003973	181585	0258005130	181586	0258005239	181585	0258005651	181588
0258003979	181587	0258005131	181586	0258005240	181590	0258005652	181588
0258003980	181585	0258005132	181588	0258005241	181590	0258005653	181588
0258003994	181585	0258005133	181588	0258005242	181590	0258005654	181590
0258003995	181587	0258005134	181590	0258005243	181590	0258005657	181589



OE No.	HC-CARGO	OE No.	HC-CARGO	OE No.	HC-CARGO	OE No.	HC-CARGO
0258006389	181592	0258006468	181592	0258006547	181591	0258006658	181592
0258006390	181592	0258006469	181591	0258006548	181591	0258006659	181591
0258006391	181591	0258006470	181592	0258006549	181591	0258006660	181591
0258006392	181592	0258006471	181592	0258006550	181591	0258006661	181591
0258006393	181592	0258006472	181592	0258006551	181591	0258006662	181591
0258006394	181592	0258006473	181591	0258006552	181591	0258006663	181591
0258006395	181592	0258006474	181591	0258006553	181591	0258006664	181591
0258006396	181592	0258006475	181591	0258006554	181591	0258006665	181591
0258006397	181592	0258006476	181591	0258006555	181591	0258006666	181591
0258006398	181592	0258006477	181591	0258006556	181591	0258006667	181591
0258006399	181592	0258006478	181591	0258006557	181591	0258006668	181591
0258006400	181591	0258006479	181591	0258006558	181591	0258006669	181591
0258006401	181591	0258006480	181591	0258006559	181591	0258006670	181591
0258006402	181591	0258006481	181591	0258006560	181591	0258006671	181591
0258006403	181591	0258006482	181591	0258006561	181591	0258006672	181591
0258006404	181592	0258006483	181591	0258006562	181591	0258006673	181591
0258006405	181592	0258006484	181591	0258006563	181592	0258006674	181591
0258006406	181592	0258006485	181592	0258006564	181592	0258006675	181591
0258006407	181592	0258006486	181592	0258006566	181591	0258006676	181591
0258006408	181591	0258006487	181591	0258006568	181591	0258006677	181591
0258006409	181591	0258006488	181591	0258006569	181591	0258006678	181591
0258006410	181591	0258006489	181591	0258006570	181591	0258006679	181591
0258006411	181592	0258006490	181591	0258006571	181591	0258006682	181591
0258006412	181591	0258006491	181591	0258006572	181591	0258006683	181591
0258006413	181591	0258006492	181591	0258006573	181591	0258006684	181591
0258006414	181591	0258006493	181591	0258006574	181591	0258006685	181591
0258006415	181591	0258006494	181591	0258006575	181591	0258006686	181591
0258006416	181591	0258006495	181591	0258006576	181591	0258006687	181591
0258006417	181591	0258006496	181591	0258006577	181591	0258006688	181591
0258006418	181591	0258006497	181591	0258006578	181592	0258006689	181591
0258006419	181591	0258006498	181591	0258006579	181592	0258006690	181591
0258006420	181592	0258006499	181591	0258006582	181592	0258006691	181591
0258006421	181592	0258006500	181591	0258006583	181592	0258006692	181591
0258006422	181592	0258006501	181591	0258006584	181592	0258006693	181591
0258006423	181592	0258006502	181591	0258006585	181592	0258006694	181591
0258006424	181591	0258006503	181591	0258006586	181591	0258006695	181591
0258006425	181591	0258006504	181591	0258006587	181591	0258006696	181591
0258006426	181591	0258006505	181591	0258006588	181592	0258006697	181591
0258006427	181591	0258006506	181591	0258006589	181591	0258006698	181591
0258006428	181591	0258006507	181591	0258006590	181591	0258006699	181591
0258006429	181592	0258006508	181591	0258006591	181591	0258006700	181591
0258006430	181592	0258006509	181591	0258006592	181591	0258006701	181591
0258006431	181592	0258006510	181591	0258006593	181591	0258006702	181591
0258006432	181592	0258006511	181591	0258006594	181591	0258006703	181591
0258006433	181591	0258006512	181591	0258006595	181591	0258006704	181591
0258006434	181591	0258006513	181591	0258006596	181591	0258006705	181591
0258006435	181591	0258006514	181591	0258006597	181591	0258006706	181591
0258006436	181591	0258006515	181591	0258006598	181591	0258006707	181591
0258006437	181591	0258006516	181591	0258006599	181591	0258006708	181591
0258006438	181591	0258006517	181591	0258006600	181591	0258006709	181591
0258006439	181591	0258006518	181591	0258006601	181591	0258006710	181591
0258006440	181591	0258006519	181591	0258006602	181591	0258006711	181591
0258006441	181591	0258006520	181591	0258006603	181591	0258006712	181591
0258006442	181592	0258006521	181591	0258006604	181591	0258006713	181591
0258006443	181592	0258006522	181591	0258006605	181591	0258006714	181591
0258006444	181592	0258006523	181591	0258006606	181591	0258006715	181591
0258006445	181592	0258006524	181591	0258006607	181591	0258006716	181591
0258006446	181591	0258006525	181592	0258006608	181591	0258006717	181591
0258006447	181591	0258006526	181592	0258006609	181592	0258006718	181591
0258006448	181591	0258006527	181592	0258006610	181592	0258006719	181591
0258006449	181592	0258006528	181592	0258006611	181591	0258006720	181591
0258006450	181591	0258006529	181591	0258006612	181591	0258006721	181591
0258006451	181591	0258006530	181591	0258006613	181591	0258006722	181592
0258006452	181591	0258006531	181591	0258006614	181591	0258006723	181592
0258006453	181591	0258006532	181591	0258006615	181591	0258006724	181591
0258006454	181591	0258006533	181591	0258006616	181591	0258006725	181591
0258006455	181591	0258006534	181591	0258006617	181591	0258006726	181591
0258006456	181591	0258006535	181592	0258006618	181591	0258006727	181591
0258006457	181591	0258006536	181592	0258006619	181591	0258006728	181591
0258006458	181591	0258006537	181591	0258006620	181591	0258006729	181591
0258006459	181591	0258006538	181591	0258006621	181592	0258006730	181591
0258006460	181591	0258006539	181591	0258006622	181592	0258006731	181591
0258006461	181591	0258006540	181591	0258006623	181592	0258006732	181591
0258006462	181591	0258006541	181591	0258006624	181592	0258006733	181591
0258006463	181591	0258006542	181591	0258006625	181592	0258006735	181591
0258006464	181591	0258006543	181591	0258006626	181592	0258006737	181591
0258006465	181592	0258006544	181592	0258006627	181592	0258006738	181591
0258006466	181592	0258006545	181592	0258006628	181592	0258006739	181591
0258006467	181592	0258006546	181591	0258006629	181591	0258006740	181591





OE No.	HC-CARGO	OE No.	HC-CARGO	OE No.	HC-CARGO	OE No.	HC-CARGO
0258010111	181591	0258986622	181591	0280130094	181395	0311424008	171195
0258010112	181591	0258986623	181591	0280130107	180875	0330001015	080177
0258010119	181591	0258986625	181591	0280217114	181500	0330001016	080178
0258010120	181591	0258986627	181591	0280217115	181500	0330001018	080177
0258010121	181591	0258986628	181591	0280217121	181491	0330001040	081166
0258010124	181591	0258986629	181591	0280217122	181491	0330001041	080177
0258010125	181591	0258986630	181591	0280217123	181495	0330106017	081002
0258010126	181591	0258986631	181591	0280217124	181500	0330106018	081000
0258010127	181591	0258986633	181591	0280217515	181500	0332014119	160282
0258010128	181591	0258986634	181591	0280217516	181500	0332014125	160265
0258010131	181591	0258986635	181591	0280217517	181500	0332014150	160265
0258010139	181591	0258986636	181591	0280217518	181500	0332014151	160265
0258010140	181591	0258986637	181591	0280217532	181500	0332014203	160266
0258010145	181591	0258986638	181591	0280217810	181500	0332014409	160083
0258010146	181591	0258986641	181591	0280217811	181500	0332015001	160168
0258010147	181591	0258986642	181591	0280217814	181500	0332015002	160169
0258010148	181591	0258986643	181591	0280218001	181495	0332017100	160365
0258010155	181591	0258986644	181591	0280218004	181495	0332017103	160363
0258010156	181591	0258986645	181591	0280218010	181500	0332201201	160337
0258010157	181591	0258986646	181591	0280218012	181495	0332204101	160308
0258010158	181591	0258986647	181591	0280218013	181491	0332204113	160308
0258010159	181591	0258986648	181591	0280218014	181491	0332204125	160081
0258010160	181591	0258986649	181591	0280218019	181495	0332204150	160081
0258010161	181591	0258986650	181591	0280218031	181494	0332204151	160308
0258010162	181591	0258986651	181591	0280218032	181491	0332204202	160337
0258010165	181591	0258986652	181591	0280218033	181491	0332204203	160216
0258010166	181591	0258986653	181591	0280218034	181491	0332204212	160271
0258010167	181592	0258986654	181591	0280218035	181491	0332204402	160316
0258010174	181591	0258986655	181591	0280218037	181494	0332207104	160366
0258010175	181591	0258986657	181591	0280218051	181495	0332207202	160368
0258010176	181591	0258986659	181591	0280218063	181491	0332207402	160521
0258010177	181591	0258986660	181591	0280218064	181491	0332209159	160403
0258010178	181591	0258986662	181591	0280218100	181491	0332515022	160654
0258010179	181591	0258986663	181591	0280218101	181491	0333300003	180290
0258010180	181591	0258986664	181591	0280218108	181495	0333301007	180232
0258010181	181591	0258986665	181591	0280218471	181491	0333301009	180233
0258010190	181591	0258986667	181591	0280230001	160352	0333402501	160423
0258010196	181591	0258986668	181591	0280230005	160352	0333402505	160441
0258010200	181591	0258986669	181591	0280230006	160354	0333402506	160441
0258010201	181591	0258986672	181591	0280230009	160353	0333402507	160443
0258010202	181591	0258986673	181591	0280230014	160354	0333402508	160443
0258010203	181591	0258986674	181591	0280230016	160352	0333402509	160424
0258010204	181591	0258986675	181591	0280230018	160353	0333402512	160420
0258010207	181591	0258986676	181591	0281002169	181395	0333402513	160425
0258010218	181591	0258986678	181591	0281002170	181395	0333402515	160442
0258010220	181591	0258986680	181591	0281002180	181494	0333402516	160442
0258010225	181591	0258986681	181591	0281002184	181495	0333402517	160424
0258010227	181591	0258986683	181591	0281002209	181395	0333402524	160425
0258010231	181591	0258986684	181591	0281002214	150451	0334200045	160242
0258010232	181591	0258986685	181591	0281002308	181494	0335200003	160242
0258010233	181591	0258986687	181591	0281002309	181494	0335200004	160242
0258010235	181591	0258986690	181591	0281002318	181491	0335200005	160244
0258010236	181591	0258986692	181591	0281002319	181491	0335200006	160244
0258010239	181591	0258986694	181591	0281002428	181495	0335200012	160242
0258010247	181591	0258986695	181591	0281002447	181495	0335200013	160242
0258010252	181591	0258986696	181591	0281002448	181495	0335200016	160244
0258010256	181591	0258986697	181591	0281002461	181491	0335200017	160244
0258010323	181591	0258986698	181591	0281002462	181491	0335200022	160242
0258986502	181585	0258986699	181591	0281002463	181491	0335200023	160242
0258986503	181586	0258986701	181591	0281002464	181491	0335200027	160242
0258986504	181587	0258986702	181591	0281002473	181395	0335200028	160242
0258986505	181588	0258986703	181591	0281002474	150451	0335200029	160244
0258986506	181589	0258986705	181591	0281002478	181491	0335200030	160244
0258986507	181590	0258986709	181591	0281002531	181491	0335200031	160244
0258986601	181588	0258986711	181591	0281002532	181491	0335200035	160242
0258986602	181591	0258986712	181591	0281002554	181495	0335200036	160242
0258986603	181591	0258986713	181591	0281002555	181495	0335200037	160244
0258986604	181591	0258986716	181591	0281002613	181495	0335200038	160242
0258986605	181591	0258986718	181591	0281003005	160432	0335200041	160244
0258986606	181591	0258986719	181591	0281003006	160434	0335200043	160242
0258986607	181591	0258986720	181591	0281003009	160436	0335200044	160244
0258986608	181591	0261210114	150354	0281003012	160434	0335200045	160242
0258986609	181591	0261210151	150468	0281003096	160449	0335200050	160305
0258986611	181591	0261210200	150470	0281003098	160419	0335200051	160305
0258986612	181591	0280130026	180875	0281003099	160421	0335200052	160242
0258986613	181591	0280130033	180875	0290800022	150100	0335200053	160242
0258986615	181592	0280130068	180875	0290800044	150408	0335200054	160242
0258986618	181591	0280130077	180875	0290800052	150101	0335200058	160242
0258986621	181591	0280130093	181395	0311424007	171194	0335200066	160242



OE No.	HC-CARGO	OE No.	HC-CARGO	OE No.	HC-CARGO	OE No.	HC-CARGO
2910012154	190545	2918740007	190582	F00HL00118	181590	F00M390002	190367
2910012164	191557	2918740008	190583	F00HL00120	181589	F00M390005	192586
2910012191	190552	2918750111	190579	F00HL00123	181589	F00M390009	192569
2910021128	B191329	2918750112	190580	F00HL00126	181589	F00M390013	191528
2910021150	191319	2918750134	190584	F00HL00127	181584	F00M990011	191318
2910021157	190546	3334485007	190767	F00HL00128	181589	F00M990012	191657
2910022118	191586	3334485008	190766	F00HL00129	181590	F00M990014	191304
2910022170	190550	3337213001	080177	F00HL00135	181590	F00M990024	192564
2910022196	190555	6033GC8223	191657	F00HL00137	181589	F00M990053	191533
2910022201	190555	9001140234	192347	F00HL00139	181590	F00M990062	191478
2910042138	190542	9001333411	191770	F00HL00141	181588	F00M990102	B230731
2910641154	192145	9001333451	191321	F00HL00147	181588	F00M990104	191304
2911011213	191854	9005140254	191048	F00HL00151	181590	F00M990127	191513
2911051237	190492	9121333305	191645	F00HL00152	181590	F00M990127	B191513
2911051281	192752	9187451002	160734	F00HL00153	181590	F00M990136	191318
2911061301	190510	9222067034	150377	F00HL00154	181590	F00M990139	191318
2911121152	190545	9401240170	090062	F00HL00155	181590	F00M990150	191308
2911201701	080252	9431610005	080424	F00HL00156	181590	F00M990151	191318
2911201702	080254	9431610156	080389	F00HL00157	181590	F00M990164	191318
2911202703	080255	9431610274	080688	F00HL00158	181590	F00M990165	191326
2911421158	190546	9431610276	080736	F00HL00161	181590	F00M990166	191267
2911432156	191900	9431610282	080734	F00HL00162	181585	F00M990175	192569
2912452152	190544	9431610360	080388	F00HL00163	181585	F00M990178	191304
2912452191	190552	9431610604	080689	F00HL00165	181590	F00M990180	191318
2912772152	190545	9432610003	100342	F00HL00166	181590	F00M990181	191513
2914502010	191329	9432610038	100353	F00HL00167	181590	F00M990184	192586
2915010007	190780	9432610295	100573	F00HL00168	181590	F00M990188	192586
2915010405	190521	9440030003	090016	F00HL00174	181590	F00M990191	191657
2915010406	190779	9491143302	080242	F00HL00176	181590	F00M990195	192586
2915010407	190780	9491143304	080240	F00HL00178	181590	F00RJ01086	081173
2915010409	191304	9491337029	191657	F00HL00179	181590	F00VC17503	081115
2915010410	190783	9580810046	070053	F00HL00180	181590	F00VC17504	081209
2915011007	190780	AE34	161061	F00HL00181	181590	FP/K22P22	090020
2915011010	191305	AE38	161062	F00HL00182	181590	FP/K22P31	090020
2915011039	191305	AE40	161063	F00HL00183	181590	FP/K22P36	090020
2915012006	190779	AE45	161064	F00HL00184	181590	FP/K22P39	090020
2915012007	190780	AE48	161065	F00HL00185	181590	FP/K22P48	090020
2915039028	191657	AE50	161066	F00HL00186	181590	FP/K22P60	090020
2915050408	191305	AE53	161067	F00HL00187	181590	FP/K22P77	090020
2915051106	191303	AE55	161068	F00HL00191	181590	FP/K22P9	090020
2915051107	191304	AE60	161069	F00HL00192	181590	FP/KE22AD112/2	090202
2915051108	190783	AE65	161070	F00HL00196	181584	FP/KE22AD174/2	090015
2915051119	191439	AE70	161071	F00HL00198	181590	FP/KE22AD174/4	090015
2915059107	191304	DLLA150S720	100525	F00HL00199	181590	FP/KE22AD190/2	090202
2915059108	191305	DN0SD193	100342	F00HL00202	181589	FP/KE22AD202/2	090202
2915061005	190527	DN0SD220	100344	F00HL00205	181585	FP/KE22AD207/2	090015
2916011007	191303	DN0SD265	100352	F00HL00206	181585	FP/KE22AD207/4	090015
2916011012	190589	DN0SD293	100348	F00HL00207	181590	FP/KE22AD223/2	090015
2916011013	191290	DN0SD297	100471	F00HL00208	181590	FP/KE22AD223/4	090015
2916011018	191503	DN10PDN130	100573	F00HL00217	181590	FP/KE22AD240/2	090015
2916012012	191506	DN12SD12	100353	F00HL00218	181590	FP/KE22AD244/2	090015
2916012014	190598	F000ZS0212	150416	F00HL00219	181590	FP/KE22AD246/2	090202
2916012020	190594	F002G91122	192586	F00HL00220	181590	FP/KE22AD247/2	090015
2916022013	190599	F00HL00010	181589	F00HL00221	181590	FP/KE22AD247/2H	090015
2916022014	191579	F00HL00014	181589	F00HL00222	181590	FP/KE22AD249/2	090202
2916060008	191337	F00HL00030	181584	F00HL00224	181589	FP/KE22AD252/2	090015
2916060013	190582	F00HL00031	181584	F00HL00225	181589	FP/KE22AD252/4	090015
2916062008	191337	F00HL00034	181590	F00HL00226	181590	FP/KE22AD265/2	090202
2916063008	191337	F00HL00035	181584	F00HL00227	181589	FP/KE22AD278/2	090015
2916063013	190582	F00HL00036	181590	F00HL00230	181590	FP/KE22AD279/2	090015
2916069081	190588	F00HL00037	181584	F00HL00233	181585	FP/KE22AD281/2H	090015
2916069084	191337	F00HL00038	181585	F00HL00234	181589	FP/KE22AD283/2	090202
2916069086	190583	F00HL00042	181590	F00HL00235	181590	FP/KE22AD285/2	090015
2916069091	190582	F00HL00043	181590	F00HL00236	181590	FP/KE22AD286/2	090202
2916069161	191337	F00HL00050	181590	F00HL00237	181589	FP/KE22AD288/2	090202
2916680035	190506	F00HL00052	181590	F00HL00238	181589	FP/KE22AD293/4	090015
2916690004	190579	F00HL00054	181590	F00HL00239	181590	FP/KE22AD294/2	090202
2916690005	190580	F00HL00060	181590	F00HL00240	181590	FP/KE22AD297/2	090202
2916691007	190582	F00HL00061	181590	F00HL00246	181590	FP/KE22AD301/2	090202
2916693007	190582	F00HL00063	181590	F00HL00248	181590	FP/KE22AD305	090015
2916699081	190578	F00HL00065	181590	F00HL00254	181590	FP/KE22AD15	090016
2916699082	190579	F00HL00083	181585	F00HL00255	181590	FP/KS22AD15/3	090016
2916699083	190580	F00HL00085	181590	F00HL00257	181590	FP/KS22AD16	090016
2916699085	190582	F00HL00086	181590	F00HL00267	181590	FP/KS22AD25/4	090016
2916699086	190583	F00HL00088	181590	F00HL00271	181590	FP/KS22AD26/4	090016
2916710602	080696	F00HL00103	181588	F00HL00303	181590	FP/KS22AD27/2	090016
2916710604	190826	F00HL00108	181589	F00HL00305	181588	FP/KS22AD31/2	090016
2918740004	190579	F00HL00109	181590	F00HL00309	181590	FP/KS22AD36/2	090016
2918740005	190580	F00HL00111	181590	F00HL00311	181584	FP/KS22AD41/2	090016

ACCESSORIES

O.E.M. names and numbers are used for reference purposes only.

OE No.	HC-CARGO	OE No.	HC-CARGO	OE No.	HC-CARGO	OE No.	HC-CARGO
<b>BOSCH continued</b>							
FP/KS22AD46/2	090016	100010	080289	134078	191307	170921	170923
FP/KS22AD53/4	090016	100012	080292	134349	080242	170926	171006
FP/KS22AD6	090016	100013	080259	134350	080240	170932	172014
FP/KS22AD6/2	090016	100014	080260	135936	191585	171170	170857
FP/KS22AD6/3	090016	100015	080261	135983	191585	171223	170935
FP/KS22AD6/4	090016	100016	080262	136358	191530	171298	170998
HB9440030004	090202	100017	080263	150034	150395	171432	171602
HB9440030010	090202	100019	080264	160027	160323	171472	171983
HB9440030013	090202	100020	080265	160029	160321	171475	171984
HB9440030014	090202	100023	080295	160030	160323	171481	171981
HB9440030016	090202	100024	080251	160044	160333	171504	171584
		100025	080257	160059	160986	171509	171507
		100026	080252	160134	160326	171526	171507
		100027	080254	160135	160328	171552	171749
		100028	080255	160241	160473	171579	172034
		100029	080258	160254	160250	171580	172035
		100030	080281	160259	160305	171581	172036
		100031	080277	160260	160314	171582	172037
		100032	080278	160274	161711	171583	172038
		100033	080279	160274AT	161711	171584	172039
		100034	080280	160299	160689	171599	172034
		100036	080274	160302	160987	171601	172036
		100038	080275	160318	160389	171602	172037
		100039	080276	160319	160389	171604	172039
		100040	090082	160320	160389	171607	172041
		100042	090078	160335	160988	171608	172042
		100044	090080	160336	160989	171641	171905
		100046	080250	160349	160350	171678	171776
		100048	080003	160351	160352	171698	171734
		100049	080237	160369	160326	171815	172087
		100050	080245	160371	160326	171890	171891
		100051	080239	160465	160426	171932	172010
		100052	080241	160476	160314	172006	172046
		100053	080243	160477Z	160477	180258	180254
		100054	080242	160505	160031	180259	180254
		100082	100512	160582	160596	180260	180255
		100083	100511	160585	160619	180331	180330
		100088	100512	160886	160996	180816	180839
		100111	080283	160887	161043	181399	181400
		100122	080297	160997	161040	181560	180601
		100128	080285	161031	161048	181593	180560
		100133	080284	170096	171361	190333	190360
		100148	080268	170153	170935	190339	190366
		100176	090079	170163Z	170163	190341	190368
		100182	080238	170214	170213	190535	191770
		100183	080240	170481	171982	190563	191678
		100189	080282	170573	171974	190795	080664
		100191	080246	170574	171976	190796	080665
		100192	080247	170578	171978	190797	080666
		100193	080269	170649	170308	190798	080662
		100194	080272	170652	170528	190799	080663
		100204	080256	170660	171980	190802	080659
		100242	100511	170678	171573	190803	080660
		100244	100303	170682	170683	190804	080661
		100255	100260	170686	170685	190830	080656
		100285	100303	170699	171025	190831	080657
		100289	100303	170700	170163	190832	080653
		100290	080253	170701	170165	190833	080654
		100293	100511	170702	170169	190834	080655
		100296	100331	170704	170675	190886	193004
		100300	100511	170717	171564	190887	193005
		100308	100511	170728	170804	190888	193006
		100314	100303	170743	171363	190889	193007
		100315	100511	170801	171084	190890	193008
		100317	100436	170814	171985	190891	193009
		100318	100512	170815	171975	190949	190709
		100319	100511	170818	171935	191017	191447
		100322	100512	170831	171793	191018	191448
		100328	100534	170851	170980	191019	191449
		100334	100531	170857	170982	191020	191452
		100338	100303	170860	170859	191021	191453
		100511	100511	170876	171331	191068	191446
		100526	100303	170877	171332	191174	192096
		100542	100335	170892	170893	191180	192582
		100672	100652	170903	171328	191198	192180
		100677	100641	170904	171329	191199	192181
		131447	190510	170908	171917	191232	193258
		133614	191298	170914	170916	191588	192096
		133615	191299	170915	170917	191757	192357

OE No.	HC-CARGO	OE No.	HC-CARGO	OE No.	HC-CARGO	OE No.	HC-CARGO
191836	192906	420089	181579	<b>CAV</b>		9001-742A	090316
191837	192908	804038	811001	1854040	100177	9001-742B	090316
191838	192909	804044	809002	5001-10	190580	9001-742G	090316
191841	192912	804047	809003	5001-26	190583	9007-497L	080738
191842	192913	804051	809004	5001-31	190582	9009-041	080207
191843	192915	804057	811004	5001-43	190584	9009-049	080207
191844	192916	804060	809005	5001-48	190580	9009-050	080208
191845	192917	804061	804110	5001-53	190582	9009-073	080207
191846	192920	804087	808014	5001-74	190582	9100-191	080213
191847	192921	805010	804096	5244-22	190579	9100-319	090233
191848	192922	805011	804097	5334-476	192145	9100-560	080969
191849	192923	805012	804098	5335-960	191321	9100-560S	080969
191850	192924	805013	804099	5335-963C	192592	9100-561A	080752
191851	192925	B180634	180626	5335-963E	192591	9100-742G	090203
191852	192926	B181273	181273	5339-401	080296	9108-073A	080998
191853	192927	G804008	804008	5339-423	080430	9108-147C	080942
191874	193171	G804012	804015	5339-970	080031	9108-152A	081117
191875	193172	G804013	804013	5641-02	100342	9108-153A	080941
191876	193173	G804014	804014	5641-020	100342	9108-154B	080940
191877	193174	G804015	804015	5641-025	100348	9109-210	090136
191878	193175	G804017	804017	5641-892	100342	9109-25	090061
191880	193177	G804020	804020	5641-896	100344	9109-262	080929
191892	193197	G804021	804021	5836B320	090194	9109-750V	090294
191893	193198	G804022	804022	5864-002	090145	9145-040D	080209
191894	193199	G804024	804024	5864-003	090146	9185-900G	080995
191895	193200	G804027	210574	5886-200C	191276	9185-900H	080996
191896	193201	G804036	804036	5936-102	190582	9A384-AA	090159
191897	193202	G804037	804037	5936-482C	191290	BDNOSD193	100342
191905	193191	G804038	811001	5936-482D	191502	BDNOSD220	100344
191906	193192	G804040	804040	5936-487	190577	BDNOSD293	100348
191907	193193	G804041	804041	5936-495M	190593	BDN12SD12	100353
191908	193194	G804042	806015	5936-495N	190594	HPS102	080595
191909	193195	G804044	809002	6010-177	191308	HPS103	080212
191910	193196	G804047	809003	6211-168	191274	HPS105	080998
192069	193170	G804048	804048	6223-001	080071	NM1-9	191274
192378	191029	G804049	804049	6223-004	090159	NS200-4T1	191266
192504	192177	G804050	804050	7097-81M	080809	NS209-10Z1	192065
192626	193182	G804051	809004	7111-296	AS301	NS209-14Z1	190549
192627	193183	G804054	804054	7111-353	090320	NS212-17Z1	192063
192628	193184	G804055	804055	7111-353AS	090071	NS212-2Z1	191321
192629	193185	G804057	811004	7111-353AZ	090404	NS230-7T1	192145
192630	193186	G804060	809005	7111-353BH	090345	NU11-10T1	191439
192776	190252	G804065	804065	7111-353BR	090346	NU11-1T1	190520
193242	193242	G804068	804068	7111-353BV	090072	NU11-3T1	190779
193243	193243	G804069	804069	7111-403	090074	NU11-7T1	191305
20.017-001	171171	G804070	804070	7111-429	090073	NW1-14Z1	191290
20.017-041	171173	G804073	804073	7111-439	080465	NW5-43	080734
20.022-021	171180	G804075	804075	7111-843	080701	NW5-43W4	080430
20.024-001	170875	G804076	804076	7111-853	080702	RDN12SD6236	100353
20.026-001	171181	G804077	804077	7123-19	080773		
20.026-021	171182	G804078	804078	7123-287	080205	<b>CHAMPION</b>	
20.026-031	171183	G804081	804081	7123-351A	080038	CH102	100251
20.027-211	171332	G804085	804085	7123-351B	080038	CH102/002	100251
20.104-031	170880	G804086	804086	7123-388	080614	CH103	100260
20.104-041	170881	G804087	808014	7123-770	080188	CH104	100259
20.196-001	170884	G805010	804096	7135-104	081007	CH110	100245
20.196-021	170885	G805011	804097	7135-110	090047	CH121	100256
20.196-041	170887	G805012	804098	7135-124	090055	CH137	100511
200116	192190	G805013	804099	7167-620A	080595	CH144	100521
200617	200618	G806011	806011	7167-620B	080207	CH147	100303
200644	200723	G806015	806015	7167-620C	080212	CH152	100644
200645	200724	G806020	806020	7167-620D	080212	CH154/002	100260
200674	200721	RES10922	191584	7169-519A	080739	CH156	100331
200677	200676			7174-496	080933	CH159	100511
200683	200728	<b>CARTIER</b>		7180-451	080205	CH160	100512
200743	200601	02386	160423	7180-49A	080211	CH161	100271
200881	171999	02388	160423	7180-49B	080211	CH166	100534
21.002-021	170893	02389	160424	7180-49C	080210	CH167/002	100650
21.002-031	170893	02393	160425	7180-49D	080210	CH172	100529
21.002-071	170895	02394	160424	7182-580A	080757	CH180	100675
210642	210696	02396	160438	7185-900G	080995	CH184	100436
210646	210686	02474	160354	7185-900H	080996	CH185	100335
210690	210638			7185-900K	080211	CH190	100544
211129	211129	<b>CASE</b>		7185-900P	080210	CH196/002	100565
233859	192752	3136900	172088	7185-900T	080212	CH203/002	100536
251726	190780	31636910	172088	7185-900W	080595	CH205	100531
252035	190780	904374	090156	7240-20B	080038	CH207/002	100544
420053	193010			9001-088	080703	CH209	100639
420055	181576			9001-142	090381	CH215/002	100538

OE No.	HC-CARGO	OE No.	HC-CARGO	OE No.	HC-CARGO	OE No.	HC-CARGO
<b>CHAMPION continued</b>							
CH216/002	100540	04686938AA	181590	4727225AB	181590	56041951AA	181590
CH218	100537	04727 225	181587	5014780AA	181584	56041952AA	181590
CH222/002	100645	04727225AB	181590	5033 039AA	181590	56041953AA	181590
CH224/002	100642	04727436AB	181590	5033 081AA	181590	56044215AA	181590
CH238	100548	05014780AA	181584	5033 200AA	181590	56044580AA	181591
CH256	100670	05033039AA	181590	5033 500AA	181590	56044581AA	181591
CH268	100674	05033081AA	181590	5099 817AA	181592	56044582AA	181591
CH275	100667	05033200AA	181590	5099 821AA	181592	56044583AA	181591
CH32	100263	05033500AA	181590	5139 021AA	181590	8933000598	181584
CH60	100512	05099817AA	181592	5227 268	181585	8933002455	181584
CH602	100670	05099821AA	181592	5227 368	181585	96 253 547	181591
CH603	100555	05139021AA	181590	5227 628	181585	96 291 086	181591
CH61	100079	05175756AA	100652	5234 921	181584	96 291 099	181591
CH62	100284	05227 268	181585	5269 711	181590	96 333 009	181591
CH63	100511	05227 368	181585	5269 714	181590	96 394 003	181591
CH65	100262	05227 628	181585	5269 868AB	181592	96 394 004	181591
CH66	100086	05234 921	181584	5269 973	181590	96 423 429	181591
CH68	100511	05269 564	181590	5269564	181590	96253547	181591
CH69	100511	05269 707	181590	5269707	181590	96291086	181591
CH70	100284	05269 711	181590	5269743	181590	96291099	181591
CH77	100548	05269 714	181590	5269866	181590	96333009	181591
CH78	100548	05269 743	181590	5293 038AB	181591	96394003	181591
CH79	100303	05269 866	181590	5293036AB	181590	96394004	181591
CH8	100511	05269 973	181590	5293037AD	181590	96423429	181591
CH80	100548	05269868AB	181592	5293037AA	181590	M05269711	181590
CH802	100641	05293036AB	181590	5293038AB	181591	MD003824	150395
CH84	100614	05293037AD	181590	53000886	181584	MD011 25	181584
CH87	100511	05293037AA	181590	53002 106	181585	MD011225	181584
CH88	100511	05293038AB	181591	56027 978	181591	MD01125	181584
CH90	100320	0M05269711	181590	56027978	181591	MD073036	181584
CH94	100246	12 578 576	181591	56028232AA	181590	MD073175	181584
CH95	100257	12578576	181591	56028233AA	181591	MD073461	181584
CH97	100261	258986507	181590	56028235AA	181591	MD073546	181584
		3000598	181584	56028584AA	181590	MD076706	181584
		3236666	181584	56028586AA	181591	MD077621	181584
		3238765	181584	56028587AA	181591	MD088616	181584
		33004243	181584	56028765AA	181590	MD089922	181584
		4004 675	181584	56028766AA	181590	MD107793	181584
		4275685	181584	56028996AA	181590	MD108934	181584
		4301 175	181584	56028997AA	181590	MD110487	181584
		4301 246	181584	56028998AB	181591	MD110492	181584
		4301 275	181584	56028998AA	181590	MD112479	150377
		4301 346	181584	56028999AA	181590	MD117240	181584
		4301 375	181584	56029049AA	181590	MD119210	181584
		4605270	181590	56029050AA	181590	MD119609	181584
		4606 061	181587	56029084AA	181591	MD121306	181584
		4606 069	181589	56029085AA	181591	MD127062	181584
		4606 133AE	181590	56029112AA	181590	MD128262	181584
		4606 135AD	181590	56029333AA	181591	MD131446	181584
		4606 555AB	181590	56030100AA	181590	MD131447	181584
		4606 555AC	181590	56030111AA	181590	MD135140	181584
		4606 555AD	181590	56041 000	181590	MD136 491	181590
		4606 555AA	181590	56041 056	181586	MD136308	181590
		4606 950AB	181585	56041000	181590	MD136309	181584
		4606063	181590	56041004	181590	MD136310	181590
		4606067	181590	56041107	181590	MD136493	181590
		4606071	181590	56041212AB	181590	MD137 224	181584
		4606075	181590	56041212AC	181590	MD137224	181584
		4606090	181590	56041212AF	181590	MD137274	181584
		4606133AB	181590	56041213AB	181590	MD140388	181584
		4606133AC	181590	56041213AC	181591	MD143 490	181591
		4606135AB	181590	56041213AE	181590	MD143490	181591
		4606422	181590	56041344AC	181591	MD148687	181584
		4606523	181590	56041345AB	181591	MD149813	181584
		4606950	181590	56041345AC	181591	MD164 422	181591
		4671 030	181590	56041345AD	181591	MD164422	181591
		4671 052	181591	56041345AE	181591	MD164423	181591
		4671052	181591	56041702AA	181590	MD165083	181591
		4686 935AB	181590	56041706AA	181590	MD181 398	181591
		4686 938AB	181590	56041731AA	181591	MD181398	181591
		4686120	181590	56041732AA	181591	MD182 691	181590
		4686621	181590	56041845AA	181590	MD182 793	181590
		4686622	181590	56041846AA	181590	MD183 145	181591
		4686723	181590	56041847AA	181590	MD183 399	181591
		4686934	181590	56041848AA	181590	MD183145	181591
		4686934AB	181590	56041887AA	181590	MD183399	181591
		4686938AA	181590	56041941AA	181591	MD184 939	181591
		4727 225	181587	56041942AA	181591	MD184939	181591
		4727 436AB	181590	56041950AA	181590	MD185 334	181591



OE No.	HC-CARGO	OE No.	HC-CARGO	OE No.	HC-CARGO	OE No.	HC-CARGO
<b>DENSO continued</b>							
949007-7450	191327	DTP06-2S	193018	P702	160411	B411FL	191029
949010-2000	191350	DTP06-4S	193020	P80	160329	B411H	191028
949015-0720	191288	HDP24-24-23-SE	192652	P90	160757	<b>FACET</b>	
949042-1840	191585	HDP24-24-31-SE	192656	<b>DUCELLIER</b>		40107	070191
949042-2960	191528	HDP24-24-9PN	193045	245510	150055	40159E	070058
949042-3950	191539	HDP26-24-23-PE	192651	2526037A	150259	40164	070056
949044-4270	190474	HDP26-24-31-PE	192655	2526040A	150259	40185	070057
949046-2040	191293	HDP26-24-9SN	193044	254410	150055	40220	070134
949047-1961	190479	W12P	192453	521007	150055	476087E	070003
949047-2130	191546	W12S	192452	521008	150055	476088	070004
949047-3410	190474	W2P	192468	521013	150055	50107	070191
949047-3560	191293	W2S	192467	<b>DURACELL</b>		60104	070187
949047-4440	191545	W3P	192470	D357	200779	60106	070188
949047-5010	190549	W3S	192469	MN11	200776	60107	070191
949047-5440	191326	W4P	192472	MN27	200777	7.0001	180631
949047-7870	191545	W4S	192471	PX625A	200778	7.0007	180634
949050-1080	192228	W6P	192474	<b>EFEL</b>		7.0008	180635
949050-3340	191657	W6S	192473	O4117	190510	7.0008	180634
949056-0750	191308	W8P	192476	<b>ELETTROSTART</b>		7.0011	180636
949056-0990	191307	W8S	192475	ES612AM3TG	090318	7.0017	180641
949056-1001	191308	WM12P	192618	ES622AM3TG	090317	7.0026	180648
949056-1130	191308	WM12S	192617	<b>ELPRESS</b>		7.0027	180649
949056-1370	191513	WM2P	192608	A1504FL5	190045	7.0028	180649
949056-2360	191513	WM2S	192607	A1504HA	190021	7.0045	180658
949056-2480	191307	WM3P	192610	A1504HO	190017	7.0047	180660
949056-2481	191307	WM3S	192609	A1507FL	190022	7.0095	180688
949056-2520	191298	WM4P	192612	A1507FLF	190985	7.0108	180694
949056-2750	191657	WM4S	192611	A1507FLH	190025	7.1000	180726
949056-3080	191308	WM6P	192614	A1507FLH	190025	7.1005	180009
949056-3300	191513	WM6S	192613	A1507H	190019	7.1007	180731
949056-3460	191513	WM8P	192616	A1519SR	190974	7.1014	180734
949056-4480	191305	WM8S	192615	A1525SK	190028	7.1091	180785
949056-4910	191307	WP2P	193021	A1532G	191501	7.1101	180790
949180-0490	080001	WP2S	193022	A1532R	190038	7.1102	180791
DG-108	100657	WP4P	193023	A1537R	190027	7.1119	181367
DG-174	100670	WP4S	193024	A1543G	190973	7.1151	181369
DG-176	100675	<b>DOGA</b>		A1553R	190031	7.2004	180790
DG180	100663	111.3756.2B.00	160503	A1565R	190015	7.2005	180791
ND-DN0SD193	100342	111.3756.3B.00	160504	A2505HA	190023	7.3000	180804
ND-DN12SD12	100353	111.9001.2B.00	160395	A2505HO	190018	7.3005	180808
NP-DN10PDN130	100573	112.1340.2B.04	160558	A2507FL	190020	7.3018	180839
<b>DEUTSCH</b>							
0413-204-2005	192788	112.1380.2B.00	160031	A2507FLF	190046	7.3028	180820
0460-202-16141	192505	112.1380.3B.00	160032	A2507FLH	190026	7.3028	180839
0460-202-20141	192619	112.1540.2B.00	160506	A2507H	190016	7.3073	180839
0460-204-11817	192621	112.1580.3B.00	160034	A2508FL	190041	7.3086	180848
0460-215-16141	192477	113.2550.2B.00	160292	A2519SR	190952	7.3101	180861
0462-201-16141	192506	113.2550.3B.00	160293	A2527SK	190001	7.3128	180875
0462-201-20141	192620	113.5440.2B.00	160357	A2532R	190257	7.3146	180883
0462-203-12141	192622	113.5623.2B.10	160290	A2537R	190029	7.3165	180893
0462-209-16141	192478	113.5623.3B.10	160291	A2543C	191067	7.3191	180905
112263-90	192683	116.5365.2B.IE	160659	A2553G	190037	7.3239	181395
DT04-08PA	192466	116.5404.2B.D0	160725	A2553R	190032	7.3257	181400
DT04-12	192451	116.5565.2B.D0	160258	A2565R	190034	7.3258	181400
DT04-2P	192458	116.5565.3B.D0	160408	A2585R	190039	7.3308	181373
DT04-3P	192460	121.0901.GA.16	160484	A4605HA	190051	7.4000	180945
DT04-4P	192462	127.0907.GA.04	160571	A4605HO	190050	7.4007	180949
DT04-6P	192464	128.1204.00.04	161021	A4607FL	190024	7.4014	180950
DT06-12SA	192450	13650070706	160727	A4607H	191191	7.4029	180953
DT06-2P	192457	162.4102.2B.00	160005	A4609FL	190048	7.4030	180954
DT06-3S	192459	162.4102.3B.00	160006	A4610R	190042	7.4042	180959
DT06-4S	192461	316.5369.30.14	161023	A4613R	191515	7.4048	180963
DT06-6S	192463	316.5565.3B.D0	160408	A4630SR	190953	7.4079	180985
DT06-8S	192465	319.0724.30.00	161022	A4652SK	190030	7.4080	180986
DTM04-12PA	192606	319.1063.30.10	161025	A4653R	190033	7.5000	181001
DTM04-2P	192596	319.1724.30.00	161024	A4665R	190035	7.5004	181005
DTM04-3P	192598	P100	160330	A4685R	190255	7.5007	181008
DTM04-4P	192600	P40	160321	B0457H4	191016	7.5008	181009
DTM04-6P	192602	P45	160322	B0457H5	190283	7.5018	181015
DTM04-8PA	192604	P50.1	160323	B0907H5	191047	7.5031	181021
DTM06-12SA	192605	P60	160325	B2507H	191415	7.5064	181034
DTM06-2S	192595	P60.1	160326	B409FL	190868	7.5128	181064
DTM06-3S	192597	P60.3	160326	B409H	191549	7.5129	181065
DTM06-4S	192599	P60.4	160326	B410FL	190252	7.5142	181073
DTM06-6S	192601	P65	160327	B410H	190270	7.5145	181076
DTM06-8SA	192603	P65.1	160327			7.5146	181077
DTP04-2P	193017	P65.2	160370			7.5155	181034
DTP04-4P	193019	P70	160328			7.5182	181088
		P70.2	160411			7.5187	181089
						7.5626	181121



OE No.	HC-CARGO	OE No.	HC-CARGO	OE No.	HC-CARGO	OE No.	HC-CARGO
7.5635	181126	1293	180688	<b>FERRARI</b>		46428175	160426
7.6007	181147	1342	180649	121515	181585	46434552	181589
7.6009	181148	1352	180636	124717	160354	46443793	160197
7.6011	181150	2101	180790	137511	150379	46447503	181495
7.6015	181152	2102	180791	138225	150387	46447610	100650
7.6019	181156	2108	180791	142514	181589	46451951	100534
7.6021	181158	2401	180726	146650	181589	46452813	181589
7.6067	181179	2402	180734	155010	181589	46469917	181495
7.6073	181182	2407	180731	161853	181589	46533308	181495
7.6075	181183	2415	180734	162462	181590	46541253	181495
7.6096	181191	2444	180785	165170	181588	46543562	150246
7.6099	181194	3114	180804	171707	181495	46548037	150246
7.6102	181197	3211	180839	180915	181592	46559804	181494
7.6108	181201	3223	180808	311609	160423	4655982	181494
7.6125	181212	3301	180875	62370600	160353	46751764	100639
7.6215	181456	3306	180905	654603	070203	46754154	100645
9.0016	150340	3326	180893			46779614	100627
9.0053	150354	3362	180848	<b>FIAT</b>		46784582	181495
9.0169	150451	3363	180861	07161230	100353	46796050	100627
9.0195	150414	3364	180883	10171194	192998	46806128	150451
9.0196	150404	3507	180945	112016	181584	4714294	100511
9.0235	150468	3513	180950	12345123	181584	4729585	100511
9.0241	150470	3517	180953	1324369080	181495	4738576	100511
9.0254	150470	3525	180963	31331116	180790	4752281	100284
9.0371	150496	3537	180953	33331115	180649	4754011	100511
9.0543K	150404	3538	180954	4067872	180804	4774412	100511
9.4001	150058	3549	180986	4067916	180726	4774413	100511
9.4002	150062	3550(2)	180985	4071394	150395	4781356	100511
9.4003	150064	3552	180949	4108672	180804	4783047	100511
9.4005	150055	3578	180959	4114572	181001	4792112	160424
9.4006	150057	3580	180959	4124209	180726	4833643	100511
9.4007	150075	3605	181077	4141538	180945	4841294	100511
9.4009	150072	3701	181001	4151243	180631	4849406	100511
9.4012	150067	3704	181008	4151564	180631	4998770	180631
9.4015	150068	3705	181005	4152127	180631	500303569	100540
9.4020	150088	3708	181005	4163888	180945	500316493	100540
9.4025	150063	3712	181009	4165210	180790	500382599	181395
9.4027	150068	3718	181005	4169122	180945	504678	090076
9.4028	150057	3722	181021	4177122	180726	51774422	181590
9.4030	150165	3724	181065	4177124	180726	5430044	180950
9.4031	150154	3725	181064	4185217	180945	5493206	100511
9.4036	150175	3731	181001	4189508	180945	55192494	081115
9.4038	150157	3734	181008	4220470	180726	55193048	181494
9.4044	150234	3735	181005	4220471	180726	55200817	100645
9.4052	150236	3738	181005	4235333	181001	55201610	181591
9.4068	150160	3739	181005	4263597	181001	55218148	181591
9.4070	150377	3742	181009	4276954	180804	55222112	181591
9.4076	150406	3767	181064	4304418	180631	55331172	181001
9.6046	150246	3795	181121	4305685	180631	55556818	181591
9.6068	150252	4029	181147	4318331	181001	5882107	160308
9.6088	150259	4030	181148	4320622	160308	5927407	180631
9.6098	150266	4038	181150	4320627	160308	5946923	160354
9.6114	150270	4051	181182	4334613	180945	5946932	160354
9.6216	150424	4052	181179	4340878	181001	5950464	100511
9.6254	150428	4057	181194	4345643	180726	5951861	100511
9.6277	150433	4060	181191	4345645	180726	5951879	100511
9.6278	150434	4065	181201	4349082	180804	5951880	100511
9.6279	150416	4066	181212	4379249	160327	5951881	100511
9.6279S	150416	4107	181156	4384184	150395	5951882	100511
9.6280S	150416	4112	181197	4384372	160327	59635160	181584
9.6281	150435	4212	181183	4393814	100511	5972332	180875
9.6295	150416			4407984	180804	5973752	100511
9.6319	150441	<b>FAIRCHILD</b>		4409505	180804	5973753	100511
9.8034	150403	8115FD2	150056	4414600	180804	5973754	160426
9.8114	150227	SH4240	150058	4414779	180945	5979027	160197
9.8120	150435	SH4243	150055	4419628	150058	5990986	160424
Q-40106	070188	SH4246	150056	4421193	070053	5992746	181021
		SH4279	150056	4429209	070053	60504288	150055
<b>FAE</b>		SH4333	150056	4430291	181584	60518322	070054
1106	180634	SH4418	150058	4431182	180631	60522876	160352
1107	180635			4448131	180804	60534316	160353
1120	180631	<b>FAUN</b>		4460210	070053	60546091	070053
1138	180649	0796720	090015	4460464	070053	605581530	150379
1140	180631	FEMSA		4460646	070053	60562702	150387
1146	180631	314271	150055	4473333	180631	60581530	150379
1161	180641			4474413	100511	60590028	150055
1169	180694	<b>FENDT</b>		4477218	080390	60590029	150055
1222	180636	F281.201.710010	090202	4552281	100511	60733358	181584
1291	180658			46410523	181179	60755012	150057



OE No.	HC-CARGO	OE No.	HC-CARGO	OE No.	HC-CARGO	OE No.	HC-CARGO
85AG9P704AA	160350	D9AE9F472AB	181584	E7TE 9F472 DA	181585	F5AZ 9G444 B	181590
85BB9350AA	070055	D9AE9F472AA	181584	E7TE 9F472 EA	181585	F5CZ 9F472 A	181590
85GB9350BA	070055	D9EE 9F472 AB	181584	E7TF 9F472 CA	181585	F5MF 9F472 A2A	181590
85GB9350AA	070055	D9EE 9F472 AA	181584	E7TF 9F472 DA	181585	F5MF 9F472 B1B	181592
85GG9P704AA	160350	D9EE9F472AB	181584	E7TF 9F472 EA	181585	F5MF 9F472 B2B	181592
86AB9278BA	180636	D9EE9F472AA	181584	E7TZ 9F472 B	181585	F5MF 9F472 BA	181592
86AB9278BB	180636	D9FZ 9F472 A	181584	E7TZ 9F472 E	181585	F5MF 9F472 BB	181592
86BB9350AA	070055	D9FZ9F472A	181584	E7TZ12A342A	100614	F5MF 9F472 DB	181592
86BF12K062AA	150057	E0DE9F472AA	181584	E8308395	080427	F5MF 9F472 DC	181592
86GB9350BA	070055	E0FZ9F472B	181584	E836240S	080696	F5MF 9F472 AA	181590
86VB17K624AA	160535	E0ZE9F472AA	181584	E8BZ 9F472 A	181584	F5MZ 9F472 B	181591
87AB 9F472 AA	181589	E17Z12A199A	150068	E8BZ12A297A	150417	F5MZ 9F472 DB	181592
87AB17K624AC	160535	E1AF 9F472 AA	181584	E8BZ212A297A	150160	F5MZ 9F472 AA	181590
87AB9F472AA	181589	E1AF9F472AA	181584	E8BZ9472A	181584	F5MZ9F472B	181591
87GB 9F472 BA	181585	E1AZ 9F472 A	181584	E8GY 9F472 A	181584	F5RZ 9F472 B	181590
88BG8B658AA	160416	E1AZ9F472A	181584	E8GY9F472A	181584	F5RZ 9F472 D	181590
89EB8B607AA	181065	E1SE9F472AA	181584	E8GY9F472F	181584	F5RZ 9F472 AA	181590
89FB6M092AA	160419	E1SF9F472AA	181584	E8TZ 9F472B	181585	F5WF 9F472 BA	181590
89FB8B607A1A	181065	E2FZ12A297A	150064	E92Z12A297A	150160	F62Z 9F472 BB	181590
89FB8B607AA	181065	E2TZ12A342A	100614	E92Z9F472A	181584	F62Z 9F472 DD	181590
89FF6M090AA	100303	E3BF9F472AA	181584	E93F 9F472 CA	181585	F62Z 9F472 FF	181590
89FF6M091AA	100303	E3EF 9F472 BA	181584	E93F 9F472BA	181585	F62Z 9F472 GG	181590
904F9350AB	090197	E3EF 9F472 AA	181584	E97F 9F472 BA	181585	F62Z9F472EE	181589
90BB6M092BA	160419	E3EF9F472BA	181584	E97F 9F472 CA	181585	F62Z9F472AA	181589
90BB6M092BB	160419	E3EF9F472AA	181584	E97F 9F472 DA	181585	F6C6 9F472 AA	181590
90BB6M092CA	160419	E3FZ 9F472 A	181584	E9BZ 9F472 A	181584	F6CF 9G444 BA	181590
90BB6M092AA	160419	E3FZ9F472A	181584	E9BZ9F472A	181584	F6CF 9G444 CA	181590
90GB108843AA	180636	E3TZ 9F472 B	181584	E9SF 9F472 BA	181585	F6CF 9G444 DA	181590
90GB10B843AA	180953	E3TZ9F472B	181584	E9SF 9F472 CA	181585	F6CF 9G444 DB	181590
910X6M090BA	100511	E43Z 9F472 A	181584	E9ZZ12A297A	150160	F6CF 9G444 DC	181590
914F9350AA	090197	E43Z9F472A	181584	EDY4	150067	F6CZ 9F472 AA	181590
91AB10884AA	180893	E47F 9F472 AA	181584	EODE 9F472 AA	181584	F6CZ 9G444 BA	181590
91AB8B607A1A	180893	E47F9F472AA	181584	EODE9F472AA	181584	F6CZ 9G444 CA	181590
92VB9N424BA	100580	E4TF9F47AA	181584	EOFZ 9F472 B	181584	F6CZ 9G444 DA	181590
92VW85Q2AA	070192	E4TZ12A342A	100614	EOFZ9F472B	181584	F6CZ 9G444 DB	181590
93151848	090197	E53F9F472AA	181584	EZD30	100511	F6DF 9G444 B2A	181590
93AB 9F472 CA	181590	E53Z 9F472 B	181584	EZD36	100527	F6DF 9G444 BA	181590
93BB6M090A2A	100511	E53Z9F472B	181584	EZD37	100565	F6DF 9G444 E1A	181590
93BB6M092BA	160469	E63F 9F472 AB	181584	EZD8	100303	F6DF 9G444 E2A	181590
93BB6M092AA	160469	E63F 9F472 BA	181584	F0212A297A	150160	F6DF 9G444 EA	181590
93FF6M090AA	100303	E63F 9F472 AA	181584	F02Z 9F472 A	181584	F6DF 9G444 AA	181590
94BB 9F472 BB	181590	E63F9F472AB	181584	F02Z 9F472 B	181584	F6DZ 9G444 B	181590
94BB 9F472 DA	181590	E63F9F472BA	181584	F02Z 9F472 C	181584	F6DZ 9G444 C	181590
94DD6M090AA	100511	E63F9F472AA	181584	F02Z12A297A	150160	F6DZ 9G444 CA	181590
95DD6M090AA	100527	E63Z 9F472 A	181584	F02Z9 F472 AA	181584	F6DZ 9G444 E2A	181590
95NW18456BB	160550	E63Z9F472A	181584	F02Z9F472A	181584	F6DZ 9G444 EA	181590
95NW18456CB	160550	E6DF 9F472 A1A	181584	F02Z9F472B	181584	F6DZ 9G444 EA	181590
95VB9N424AA	100580	E6DF 9F472 B1A	181584	F02Z9F472C	181584	F6MF 9F472 AA	181590
95VW10884BA	180848	E6DF9F472A1A	181584	F02Z9F472AA	181584	F6MF 9F72 AA	181590
95VW10884AA	180883	E6DF9F472B1A	181584	F0BZ9F472B	181584	F6MZ 9F472 AA	181590
95VW12029AA	150516	E6DF9F472AA	181584	F0BZ9F472C	181584	F6MZ 9F472 AA	181590
95VW12A648BA	180861	E6DZ 9F472 A	181584	F0C69F472EB	181584	F6XA 9F472 BA	181590
95VW6M090AA	100436	E6DZ 9F472 B	181584	F0JY12A297B	150417	F6XA 9F472 CA	181590
95VW8502BA	070192	E6DZ9F472A	181584	F0JY9F472A	181584	F6XA 9F472 CB	181590
95VW8502AA	070192	E6DZ9F472B	181584	F0JY9F472B	181584	F6XA 9G444 AA	181590
95VW9278BA	180694	E6SZ 9F472 A	181584	F0SZ 9F472 B	181585	F6XZ 9F472 CA	181590
95VW9278CA	180688	E6SZ9F472A	181584	F0TZ 9F472 E	181585	F6ZF 9G444 AA	181590
96BB 9F472 BA	181590	E6ZF 9F472 AB	181584	F1CF9F472A	181584	F6ZZ 9G444 AA	181590
96BB 9F472 BB	181590	E6ZF 9F472 BA	181584	F1CZ 9F472 A	181584	F7Z 9F472 GG	181590
96BB 9F472 AA	181590	E6ZF9F472AB	181584	F1CZ9F472A	181584	F7XA 9F472 CA	181590
97FB10884AA	180893	E6ZF9F472AC	181584	F1UF 9F472 AA	181590	F7XA 9F472 FB	181590
988F12029AB	150416	E6ZF9F472BA	181584	F1UF 9F472 AA	181590	F7XA 9F472 FC	181590
988F12029AC	150416	E6ZF9F472CA	181584	F2T212A342A	100614	F7XZ 9F472 FA	181590
988F12029AD	150416	E6ZF9F472AA	181584	F4AF 9F472 A	181590	F7XZ 9F472 FB	181590
988F12029BA	150416	E6ZZ 9F472 A	181584	F4AZ 9F472 A	181590	F8CZ 9F472 BB	181590
98AB 9F472 BB	181590	E6ZZ 9F472 B	181584	F4BZ 9F472 A	181584	F8RZ 9G444 BB	181590
98FB9278AA	180636	E6ZZ9F472A	181584	F4BZ9F472A	181584	F8XZ9F472CA	181589
98VW12A223AA	150406	E6ZZ9F472B	181584	F4SF 9F472 AB	181590	FBO06M092BA	160418
98W13480AA	181369	E73F 9F472 BA	181585	F4SF 9F472 DA	181590	FBO06M092CB	160418
9968969	160647	E73F 9F472 CA	181585	F4SZ 9F472 A	181590	FO2Z 9F472 C	181584
9X2Q6M090AC	100683	E73F 9F472 AA	181585	F4SZ 9F472 D	181590	FO2Z9F472A	181584
A710X12K018E2	150395	E73Z 9F472 A	181585	F4ZF 9F472 A	181590	FO2Z9F472B	181584
A790X12K018CA	150395	E73Z 9F472 B	181585	F4ZF 9F472 AB	181590	FO2Z9F472C	181584
B3124Q03A	150068	E73Z 9F472 A	181585	F4ZF 9F472 BB	181590	FO2Z9F472C	181584
C3TZ12029A	150395	E73Z 9F472 BA	181585	F4ZZ 9F472 A	181590	FO2Z9F472AA	181584
C6AH12171A	150395	E73Z9F472C	181591	F4ZZ 9F472 AB	181590	FOBZ 9F472 B	181584
D0HZ9278A	180636	E7RY 9F472 A	181585	F4ZZ 9F472 B	181590	FOBZ9F472B	181584
D8EE9F472AA	181584	E7SF 9F472 BA	181585	F5AF 9G444 AB	181590	FOJY 9F472 B	181584
D8FZ9F472A	181584	E7SF 9F472 CA	181585	F5AF 9G444 BB	181590	FOJY9F472B	181584
		E7SF 9F472 AA	181585	F5AZ 9G444 A	181590	FOSZ 9F472B	181585



OE No.	HC-CARGO	OE No.	HC-CARGO	OE No.	HC-CARGO	OE No.	HC-CARGO
4RV008188-201	160417	9XD997909-801	171266	CP-51	100555	30510-PT2-006	150270
4RV008188-211	160418	9XX009122-011	160549	CP-52	100662	30520-PDF-E01	150252
4RV008188-221	160419			CP-70	100324	36531-P01-004	181584
4RV008188-241	160438	<b>HENCHEL</b>		CP-71	100325	36531-P01-G01	181584
4RV008188-271	160431	0614204001	090202	CP-72	100560	36531-P01-G02	181584
4RV008188-281	160432			PD-190	100257	36531-P05-A01	181584
4RV008188-301	160434	<b>HITACHI</b>		PD-191	100283	36531-P05-A02	181584
4RV008188-321	160436	080253	080253	PH-22	100658	36531-P06-A01	181584
5DA006623-001	150055	080256	080256	PH-23	100658	36531-P06-A11	181591
5DA006623-011	150056	191489	191489	PH-25	100657	36531-P07-A01	181584
5DA006623-031	150075	210843	210843	PI-42	100275	36531-P07-L01	181591
5DA006623-041	150057	210948	210948	PI-44	100658	36531-P08-004	181584
5DA006623-051	150058	2114-2835	190537	PI-46	100245	36531-P0A-A11	181591
5DA006623-061	150062	2114-2867	190482	PI-49	100657	36531-P0B-A01	181591
5DA006623-071	150064	2114-3835	190537	PI-50	100658	36531-P12-A02	181591
5DA006623-151	150068	2114-58005	191584	PI-56	100657	36531-P12-A03	181591
5DA006623-161	150088	2114-5866	190480	PI-57	100426	36531-P12-A12	181591
5DA006623-181	150154	2114-5867	190482	PI-58	100292	36531-P1A-004	181584
5DA006623-241	150072	2114-68005	191873	PK-115	100280	36531-P1E-J01	181591
5DA006623-251	150175	2114-7867	192063	PM-165	100559	36531-P1K-E01	181584
5DA006623-261	150067	2116-1131	190806	PM-167	100670	36531-P1K-E11	181591
5DA006623-371	150157	2116-1491	190820	PM-75	100246	36531-P1R-004	181592
5DA006623-401	150236	2116-1501	190818	PM-79	100521	36531-P1R-A01	181590
5DA006623-411	150096	2116-1502	190818	PN-123	100251	36531-P1R-A02	181590
5DA006623-421	150160	2116-1511	191358	PN-124	100252	36531-P2A-J01	181584
5DA006623-431	150165	2130-3822	192063	PN-128	100254	36531-P2A-J02	181584
5DA006623-461	150215	2240-1801	190482	PN-131	100276	36531-P2P-A01	181590
5DA006623-471	150384	2240-6801	191326	PN-132	100271	36531-P2Y-G01	181584
5DA006623-481	150234	2250-2802	191536	PN-135	100287	36531-P3F-004	181591
5DA006623-491	150378	3062-1231	080875	PN-138	100306	36531-P3F-014	181591
5DA006623-511	150377	7120632	190480	PN-87	100247	36531-P3F-902	181591
5DA006623-581	150063	B354-144	191307	PS-201	100433	36531-P3Y-G01	181584
5DA006623-591	150409	B-424588	190806	PS-202	100434	36531-P3Y-G02	181584
5DA006623-601	150379	B-424590	190820	PS-203	100634	36531-P45-G01	181591
5DA006623-611	150387	B-437057	191358	PS-204	100435	36531-P45-G02	181591
5DA006623-621	150227	C6R800	150395	PS-206	100518	36531-P5A-003	181590
5DA006623-731	150380	DIS405	150409	PS-207	100523	36531-P5A-A01	181591
8EG008497-231	100533	DIS408	150406	PS-208	100524	36531-P5G-003	181590
8EG008497-561	100592	E12-117	150398	PS-210	100522	36531-P5K-003	181591
8EW009100-201	160550	E123-02	150384	PS-216	100636	36531-P5M-004	181591
8EW009100-301	160515	E123-03	150384	PT-100	100256	36531-P5M-014	181591
8EW009100-311	160520	L150-1810	191657	PT-101	100280	36531-P5P-004	181591
8EW009100-461	160513	L150-28001	192145	PT-103	100260	36531-P5P-014	181591
8JA001909-001	170964	L150-28011	191528	PT-104	100256	36531-P64-004	181584
8JA001920-001	180403	L150-5810	191299	PT-107	100257	36531-P64-901	181584
8JA002263-001	180401	L160-3801	191528	PT-108	100282	36531-P64-902	181584
8JA003525-001	190766	L160-5801	191528	PT-109	100280	36531-P6W-A01	181590
8JA005951-051	180330	L170-2910	191307	PT-140	100258	36531-P72-A01	181591
8JA103500-001	180332			PT-141	100259	36531-P75-A01	181591
8JA715606-001	190767			PT-144	100260	36531-P7A-003	181584
8JB001933-001	180402	<b>HKT</b>		PT-147	100277	36531-P7J-004	181591
8JB001944-001	180404	B-004	100079	PT-150	100283	36531-P8A-A01	181591
8JB102100-001	180329	B-028	100512	PT-151	100291	36531-P8C-A01	181591
8KV002142-031	191507	B-029	100262	PT-154	100514	36531-P8C-A11	181590
8KV002143-031	191508	B-031	100086	PT-155	100516	36531-P8C-A21	181590
8PD003798-001	210212	B-032	100303	PT-157	100556	36531-P8D-J21	181590
8RA002014-031	170165	B-033	100511	PV-138	100306	36531-P8E-A01	181591
8RA002014-041	170170	B-037	100512	PZ-30	100286	36531-P8E-A11	181590
8RA002014-051	170169	B-040	100511	PZ-33	100261	36531-P8F-A11	181590
8RA002020-001	170163	B-043	100511	PZ-38	100515	36531-P9L-E02	181590
8RA003326-011	171230	B-044	100511	PZ-39	100520	36531-PBC-A01	181591
8TW004223-031	160197	B-045	100511			36531-PBF-A11	181590
8TW005206-031	160381	B-049	100284	<b>HONDA</b>		36531-PBY-003	181590
8TW005206-051	160382	B-053	100303	06302-PT2-000	150236	36531-PBY-J01	181590
8TW005496-0051	160198	B-055	100263	06302-PT2-A00	150236	36531-PC7-661	181584
8TW006847-001	160535	B-101	100561	06302-PT3-000	150236	36531-PC7-662	181584
8TW006849-001	160386	B-102	100592	06302-PTA-00	150236	36531-PC7-663	181584
9DF112247-001	170621	B-105	100565	12291-PLZ-D00	100555	36531-PC7-664	181584
9EL112753-001	171236	B-106	100593	16400-PDD-X00	181495	36531-PC7-665	181584
9EL112758-001	171236	B-107	100594	30120-PM3-0050	150398	36531-PC7-682	181584
9EL118445-001	171252	B-119	100639	30120-PM5-A01	150236	36531-PCA-004	181591
9EL118697-001	171258	CP-01	100302	30120-PMA-01	150236	36531-PCA-014	181591
9EL118700-001	171258	CP-02	100326	30120-PR3-003	150236	36531-PCC-004	181591
9EL122689-027	171263	CP-03	100336	30120-PT3-003	150236	36531-PCC-014	181591
9EL146451-001	171236	CP-05	100563	30120-PT3-004	150236	36531-PCX-000	181590
9EL786000-001	170641	CP-06	100310	30130-P06-006	150384	36531-PCX-004	181590
9EL787000-001	170642	CP-07	100510	30130-P54-006	150236	36531-PCX-014	181590
9EL997451-001	171258	CP-22	100429	30130-P06-006	150384	36531-PD2-305	181584
9EL998002-001	171253	CP-50	100513	30500-634-005	150395	36531-PD2-661	181584



OE No.	HC-CARGO	OE No.	HC-CARGO	OE No.	HC-CARGO	OE No.	HC-CARGO
8-94404544-0	150157	ERC 6193	181584	1312	171996	1608	170758
8-94408151-0	181584	LNA1682AC	181591	1318LL	170658	1609	170755
8-94481972-0	100426	LNE1682BB	181590	1318LL	171979	1611	170331
8-94511978-0	100275	LNE1682BC	181590	1320	171984	1611	171104
8-97018586-0	181584	ULC 1917	181584	1321	170335	1611-AMBER	170778
8-97018587-0	181585	XR8 1557	181590	1321	170769	1611-BLUE	170780
8-97024256-0	181590	XR8 2007	181590	1322	170349	1611-GREEN	170779
8-97032102-1	181590	XR8 22998	181590	1322	170826	1611-RED	170781
8-97062292-0	181585	XR8 6938	181590	1326	170451	1612	170476
8-97073641-0	100657			1326	171078	1612	171106
8-97080554-0	100513	<b>JAHN</b>		1338LL	170659	1612-AMBER	170805
8-97287352-0	181591	1000	171133	1341	170336	1612-BLUE	170807
9-81360005	150395	1100	170804	1341	170770	1612-GREEN	170806
9-81360007	150395	1101	170334	1342	170452	1612-RED	170808
9-82511535	150395	1101	170768	1342	171092	1621	170347
9-82511978-0	100275	1102	170348	1345	170644	1621	171105
9-82513508-0	150395	1102	170792	1345	171093	1622	170542
9-82513509-0	150395	1103	170360	1362	170614	1622	171107
9-82513928-0	100658	1104LL	170657	1362	171986	1624	170754
9-82513928-2	100658	1104LL	171113	1365	170816	1628LL	170662
9-82513928-3	100658	1106	170692	1375	171989	1631	170777
9-82513928-4	100658	1107	170450	1376	170481	1632	170776
9-82513928-5	100658	1107	171125	1380	171995	1633	171398
9-82513928-6	100658	1109	170009	1383	170648	1641	170727
9-82513928-7	100658	1109	171065	1383	171089	1641	171109
9-82513928-8	100658	11101	170802	1385	171994	1645	170756
9-82513928-9	100658	1111	170069	1390	171998	1645	171110
		1111	170332	1391	170583	1646	171033
<b>IVECO</b>		11117	170825	1392	171088	1651	170545
01287474	090202	1112	170449	1393	170849	1655	170610
1173764	090020	1112	171072	1393	171090	1661	170357
41118038	192902	1115	170965	1400	171981	1662	170358
4448131	180804	1115	171070	1401	170340	1665	170611
4609596	090187	1117	170720	1401	170773	1671	170612
4648022	090187	1119	170800	1402	170413	1682	170613
4660069	090187	1121	170070	1402	170794	1692	170757
4667509	090187	1121	170333	1406	170455	1692	171111
4709282	090187	1122	170412	1406	171118	1695	170753
4740717	090187	1122	170836	1408LL	170660	1695	171112
4756678	090187	1125	170696	1408LL	171980	1696	170698
4757883	090187	1131	171073	1410	171480	1699	171025
4802839	080188	1134	170804	1410	171993	1701	170590
4899689	081115	1152	170006	1411	170339	1705	170591
504051082	181495	1155	170359	1411	170772	1710	171484
5946923	160354	1173	170718	1412	170351	1711	170341
5963516	181584	1176	170951	1412	170793	1711	171094
62190090	090202	1176	171953	1415	171990	1712	170414
71445067	090315	1177	170693	1416	170454	1712	171096
751874	160337	1178	170694	1416	171076	1715	170411
752785	090202	1179	171039	1417	171997	1715	171095
7648798	150379	1181	170496	1418LL	171992	1721	170343
764898	150379	1182	170362	1431	170593	1721	171097
8092471	090315	1183	171009	1432	171102	1722	171099
9462703	160424	1184	171010	1500	171492	1731	170344
960099	160478	1186	171034	1501	170346	1731	171098
975301258	150055	1187	171035	1501	170774	1732	171100
99463242	170998	1188	171036	1502	170417	1735	170005
99463243	171098	1189	171037	1502	170795	1741	170342
99463244	170999	1191	170493	1510	171491	1742	170592
9981541	090202	1191	171068	1511	170345	1750	171479
		1192	170494	1511	171103	1751	170588
<b>JAEGER</b>		1195	170380	1512	170416	1752	170589
09477509	180950	1199	170681	1512	170796	1761	171139
31556605	181005	1200	171477	1520	171490	1836	170470
		1201	170338	1521	170594	1848	170380
		1201	170771	1551	170448	1849	170502
		1202	170350	1551	171119	1855	170839
<b>JAGUAR</b>		1211	171985	1552	170456	1855	171987
02JD61604	100622	1221	170815	1601	170410	1896	170741
AGU 1108	181584	1221	171975	1601	170775	1896	171082
AGU 1870	181585	1231	171974	1601-AMBER	170782	1897	170742
C2C 25956	181590	1232	171976	1601-BLUE	170784	1898	170751
C2C 7360	181590	1241	170575	1601-GREEN	170783	1899	170752
C2S 38497	181590	1245	170579	1601-RED	170785	1920	171042
CAC2263	070053	1248	170577	1602	170477	1921	171043
CAC4269	070053	1248	170577	1602	171108	1932	171044
CBC5657	070053	1248	171991	1603	170617	1950	171040
DAC 2549	181584	1249	171978	1605	171283	2000	171132
DAC 6907	181585	1310	171983	1607	170813	20238	170726
DBC 10744	181585	1311	171988				

OE No.	HC-CARGO	OE No.	HC-CARGO	OE No.	HC-CARGO	OE No.	HC-CARGO
<b>JAHN continued</b>							
24338	170509	39210 02910	181591	39210-23030	181588	8311999717	090076
27225	170725	39210 22017	181585	39210-23035	181588	8312032676	100344
27243	171027	39210 22018	181584	39210-23036	181588		
37755	170664	39210 22026	181590	39210-23046	181588		
50440MPU	171064	39210 22030	181588	39210-23500	181591	<b>LADA</b>	
7234	171531	39210 22045	181588	39210-23710	181591	2101-3808600	180804
7234	171977	39210 22050	181588	39210-26700	181591	2103-3808800	181001
H4360	H4360	39210 22051	181588	39210-2X010	181590		
H5360	H5360	39210 22610	181591	39210-32500	181584	<b>LAMBORGHINI</b>	
		39210 22620	181591	39210-32520	181584	245195200	090016
		39210 22810	181591	39210-33440	181591		
<b>KHD</b>		39210 23025	181588	39210334601	181591	<b>LIEBHERR</b>	
01200772020	100511	39210 23026	181588	39210-33461	181591	7006472	080692
01286852	090202	39210 23030	181588	39210-35110	181591	7360197	090076
01287472	090202	39210 23035	181588	39210-37523	181591		
01287482	090202	39210 23036	181588	39210-37525	181590	<b>LUCAS</b>	
01441724410	090016	39210 23046	181588	39210-38015	181591	190725	190725
01521721310	090015	39210 23500	181591	39210-38025	181591	190726	190726
0154170514	090076	39210 23710	181591	39210-38035	181590	192404	192404
0155190601	080390	39210 24310	181584	39210-39027	181591	30972	181183
0721215	100342	39210 24320	181584	39210-39030	181590	34228	181235
0771215	100342	39210 24520	181584	39210-39500	181591	34542	180790
1118641	080696	39210 24550	181584	39210-39550	181591	35630	181236
1177424	150056	39210 24610	181590	39210-39650	181591	35631	181183
12037942	080692	39210 24660	181590	39210-39660	181591	35670	181235
12038254	090020	39210 26700	181591	39210-39840	181591	36614	181237
12152597	090016	39210 2X020	181590	39220-22010	180875	38890B	181183
12152965	100342	39210 32510	181584	39350 32510	181584	54134027	192228
1260840	090076	39210 32810	181584	94750-11010	180641	54142360	191287
1277476	090015	39210 33000	181590	94750-11102	180641	54324157	181465
1287479	090015	39210 33010	181590	94750-11110	180641	54403549(2)	150055
1287480	090015	39210 33030	181590	94750-21000	180641	54403575(2)	150055
1287481	090015	39210 33070	181590	94750-21010	180641	54960402	132804
1287485	090016	39210 33340	181590	94750-21020	180641	54987086	150175
1287489	090016	39210 33440	181591	94750-21030	180641	60600983	132804
1290871	080696	39210 33461	181591	96056-317	150377	7111/296	AS301
1310021	090015	39210 35110	181590	KK348 18861	181584	80334A	150175
3366125	090015	39210 35120	181590	MBP0318861B	181584	80334A	150380
3369488	090076	39210 35121	181590	MBP3C 18861	181591	84403	150072
3372153	080390	39210 37140	181590	MBP3C18861	181591	84403D	150072
3550549	090016	39210 37190	181590	MBP3C-18861	181591	84890D	150175
4188108	090315	39210 37510	181590	MBP3D 18861	181591	84896A	150072
8122184	090016	39210 37520	181590	MBP3D18861	181591	8490D	150175
		39210 37523	181591	MBP3D-18861	181591	84950	150072
		39210 37525	181590	MBP3D18861A	181591	84950A	150072
		39210 37530	181590	MBPD3 18861	181591	84972	150072
		39210 37540	181590	MBPD318861	181591	9490D	150380
		39210 38005	181590	MBPD3-18861	181591	BAE800AK	150246
		39210 38015	181591	MBPD318861A	181590	CIM15A	100262
		39210 38025	181590	MBPD418861	181591	DAB118	150072
		39210 38035	181590	MBPD418861A	181591	DAB125	150058
		39210 39025	181590	MZ553-18861	181591	DAB126	150175
		39210 39027	181591	MZ55318861A	181590	DAB129	150072
		39210 39030	181590	OK32B 18861	181590	DAB134	150175
		39210 39500	181591			DAB200	150055
		39210 39550	181591	<b>KOMATSU</b>		DAB201	150055
		39210 39600	181590	122-3901-H91	090076	DAB400	150056
		39210 39650	181591	6008-15-1340	100280	DAB401	150057
		39210 39660	181591			DAB402	150075
		39210 39800	181590	<b>KUBOTA</b>		DAB404	150154
		39210 39820	181590	15204-65511	100581	DAB405	150098
		39210 39840	181591	15221-65513	100435	DAB700	150062
		39210-02610	181591	15521-65512	100434	DAB702	150064
		39210-02620	181591	15951-65512	100433	DAB752	150067
		39210-02630	181591	16241-65511	100523	DAB800	150088
		39210-02640	181591	16261-65511	100523	DAB801	150165
		39210-02900	181591	16604-05230	090333	DAJ204	150068
		39210-02910	181591	16616-60011	090216	DAJ902	150157
		39210-21320	181584	16851-65512	100518	DAJ904	150236
		39210-21340	181584	19077-65510	100524	DS001	100511
		39210-22030	181588	19844-52031	090333	DS002	100511
		39210-22045	181588	3518110	160311	DS003	100511
		39210-22050	181588	MDF44-7	090253	DS004	100512
		39210-22051	181588			DS005	100086
		39210-22610	181591	<b>KÄSSBOHRER</b>		DS006	100511
		39210-22620	181591	737515000	160443	DS007	100303
		39210-22810	181591	73751591000	160441	DS008	100512
		39210-23025	181588	83119997110	090076	DS010	100262
		39210-23026	181588			DS012	100263



OE No.	HC-CARGO	OE No.	HC-CARGO	OE No.	HC-CARGO	OE No.	HC-CARGO
DS017	100246	HDS243	100247	SOB500	180634	64833036	150165
DS018	100256	HDS245	100256	SOB501	180634	64833040	150088
DS019	100260	HDS247	100245	SOB502	180634	64833040010	150088
DS020	100258	HDS249	100275	SOB503	180658	64833060	150057
DS022	100282	HDS262	100256	SOB507	180635	64833060010	150057
DS023	100280	HDS266	100284	SOB600	180631	64833100	150057
DS024	100251	HDS267	100284	SOB601	180631	64833100010	150057
DS025	100252	HDS271	100303	SOB802	180636	64833131	150165
DS026	100261	HDS272	100286	SOB807	180641	940038500	150056
DS027	100259	HDS273	100303	SPB400	180790	940038501	150055
DS028	100247	HDS276	100287	SSB100	181476	940038502	150057
DS032	100245	HDS280	100254	SSB101	181476	940038503	150075
DS034	100275	HDS283	100271	T1W6A	100086	940038506	150154
DS047	100256	HDS297	100331	TGE426A	160376	940038520	150062
DS052	100284	HDS306	100548	TIX1A	100512	940038522	150064
DS056	100303	HDS307	100614	TIX2A	100511	940038526	150063
DS057	100286	HDS316	100079	TIX4A	100511	940038540	150067
DS058	100303	HDS337	100511	TIX6A	100511	940038544	150072
DS061	100287	HDS340	100276	UX1A	100086	940038550	150236
DS065	100254	HDS341	100512	UX2A	100511	940038603	150075
DS068	100271	HDS342	100511	UX4A	100511	940138501	150055
DS082	100331	HDS343	100512	UX7A	100284	940385521	150058
DS092	100614	HDS345	100292	UX8A	100512	943251408010	150056
DS092A	100614	HDS346	100426	UX9A	100511	9940096	150088
DS095	100616	HDS349	100511	UXA2	100511	BKL1A	150058
DS095A	100616	HDS350	100335			BKL2A	150055
DS101	100079	HDS352	100331			BKL3B	150165
DS122	100511	HDS353	100511	<b>MAGNETI MARELLI</b>		BKL3BD	150165
DSC02	160424	HDS354	100339	060708038010	150246	BKL3C	150056
DSC18	160417	HDS355	100323	062500300304	100650	BKL4A	150088
DX1A	100511	HDS356	100534	062900011304	100639	MTR01	150055
FDB501	160352	HDS357	100320	062900030304	100642	MTR02	150057
FDB502	160350	HDS358	100306	064342204010	160671	MTR03	150098
FDB504	160295	OPS101	180649	064342210010	160671	MTR2	150057
FDB505	160353	OPS103	180649	064342601010	160376	REP1A	160423
FDB506	160354	OPS104	180649	064833010010	150058		
FDB508	160372	OPS110	180634	064833020010	150055	<b>MAGNETON (PAL/SKODA)</b>	
FDB510	160374	OPS112	180631	064833031010	150165	210843	210843
FDB511	160375	OPS113	180631	064833032010	150056	210948	210948
HDC101	160423	SFB165	160314	064833036010	150165	443213221020	150215
HDC102	160424	SMB406	180009	064833040	150088	852018	180634
HDC103	160425	SMB412	180731	064833100010	150057	852076	180634
HDC104	160420	SMB418	180734	07029585	100511	TZP443213221020	150215
HDC105	160418	SMB423	180790	0940038506	150154		
HDC108	160416	SMB510	181179	0940038522	150064		
HDC111	160419	SMB511	181179	0940038526	150063	<b>MAN</b>	
HDC113	160417	SMB512	181182	0940038540	150067	51.98701-0118	081115
HDC114	160458	SMB526	181201	0941038520	150062	81.25229-6051	170968
HDC116	160441	SMB528	181212	116459169917	180631	81.25475-0152	192902
HDC117	160443	SMB531	181194	116459169925	180631	81.25902-0264	161035
HDC118	160442	SMB539	180785	116580459904	180945	81.25902-0317	161035
HDC122	160426	SNB116	180839	116580679904	181021	81.25902-0363	161035
HDC124	160438	SNB150	180950	116580729901	181001	81.25902-0425	161035
HDC125	160436	SNB171	180848	116580729908	181009	81.25902-0452	161035
HDC126	160434	SNB606	180959	116580729913	181005	81.25902-0491	161035
HDC127	160421	SNB612	180963	116580739902	181009	81.25902-0519	161035
HDC128	160469	SNB618	180985	116580739927	181005	81.25902-0520	161035
HDS124	100258	SNB701	180954	116596409901	180804	81.66804-6032	171797
HDS216	100511	SNB702	180953	210843	210843	81.66804-6034	171797
HDS217	100511	SNB703	180945	210873	210873		
HDS218	100511	SNB708	180949	210948	210948	<b>MANN</b>	
HDS219	100512	SNB713	181015	34542	180790	P917X	AS301
HDS220	100086	SNB714	181005	410782000800	100352	WK31/4	RT2002
HDS221	100511	SNB718	181008	417745950000	100342		
HDS222	100303	SNB723	181001	417746240000	100353	<b>MASSEY FERGUSON</b>	
HDS223	100512	SNB727	181009	417746280000	100344	2868360M1	090016
HDS225	100263	SNB730	181021	417747190000	100348		
HDS226	100566	SNB746	181064	54403549	150055	<b>MATSUSHITA</b>	
HDS227	100263	SNB750	181065	54403575	150055	192145	192145
HDS232	100246	SNB756	181088	581701010000	150165		
HDS233	100257	SNB768	181121	581701020000	150165	<b>MAZDA</b>	
HDS234	100260	SNB785	181034	581701070000	150088	0222-18-100A	150395
HDS235	100258	SNB792	181076	581701080000	150057	0258-00-2035	181584
HDS237	100282	SNB793	181077	60708038	150246	0290-18-100	150395
HDS238	100280	SNB809	180875	64822032	150056	0294-18-100	150395
HDS239	100251	SNB814	180861	64833010	150058	0324-18-100	150395
HDS240	100252	SOB101	180649	64833020	150055	0381-18-100	150395
HDS241	100261	SOB103	180649	64833031	150165	0419-18-100	150395
HDS242	100259	SOB104	180649	64833031010	150165	0453-18-100	150395
				648330311010	150165		





OE No.	HC-CARGO	OE No.	HC-CARGO	OE No.	HC-CARGO	OE No.	HC-CARGO
<b>MERCEDES BENZ continued</b>							
2218690121	160379	A0015408517	181592	A715X01971	191789	MD128262	181584
3460170160	080441	A0015408717	181592	A715X05271	190470	MD129183	181584
3460170260	080442	A0015409217	181592	A715X05371	191789	MD129550	150377
3645427319	161035	A0015409517	181591	AW327504	181584	MD131446	181584
554 224 17	181584	A0025400117	181591	CYGS065A	150157	MD131447	181584
6010170060	080736	A0025400617	181591	DYE923	150068	MD131540	181584
6010170360	160197	A0025400817	181591	EJN902	150096	MD132243	150377
6110170060	081055	A0025421218	181584	J007T00371	150068	MD136308	181590
6110170360	081067	A0045420718	181591	J007T01571	150234	MD136309	181584
6110170460	081068	A0045420818	181591	J007X00671	150160	MD136310	181590
6388600126	160197	A0055422417	181584	J007X00812	150417	MD136491	181590
654 221 17	181584	A0055422517	181584	J007X00871	150160	MD136493	181590
9094302225	160794	A0055426217	181584	J007X00971	150377	MD138993	180641
A0005402417	181586	A0055426317	181584	J007X01172	150234	MD140388	181584
A0005402617	181586	A0055427317	181584	J007X01175	150234	MD142206	181591
A0005402717	181586	A0055428517	181584	J007X01271	150377	MD142209	181591
A0005402917	181586	A0065421917	181584	J009T02071	150377	MD143490	181591
A0005403817	181586	A0065422117	181584	J106	150068	MD147878	181584
A0005404117	181586	A0065422217	181584	J117	150160	MD149813	181584
A0005404517	181586	A0065422317	181584	J120	150234	MD150609	181584
A0005404817	181589	A0065429017	181585	J121	150377	MD153923	181584
A0005404917	181586	A0065429617	181585	J152	150096	MD164422	181591
A0005405017	181586	A0075423117	181585	J153	150378	MD164423	181591
A0005405217	181589	A0075423217	181585	J170	150234	MD164475	150377
A0005405517	181586	A0075425217	181585	J170A	150234	MD165081	181591
A0005405617	181586	A0075426817	181585	J207	150417	MD165083	181591
A0005405917	181586	A0075429417	181585	J862	150512	MD17613	150395
A0005406017	181592	A0095420517	181585	J9T03372	150377	MD177968	181591
A0005406217	181590	A0095420617	181585	MO 4606037	181590	MD177969	181591
A0005406517	181589	A0095423817	181584	MO 4671052	181591	MD180388	181584
A0005407117	181588	A0095424317	181585	MO 5269711	181590	MD180618	181591
A0005407217	181588	A0095424517	181585	MO4671066	181590	MD181398	181591
A0005407317	181586	A0095428717	181585	M901X01571	191531	MD182691	181590
A0005407417	181588	A0095429017	181587	M981D73202	191873	MD182792	181590
A0005407517	181588	A0095429117	181587	M981D73205	191585	MD182793	181590
A0005407617	181588	A0095429217	181587	M981S70101	191584	MD183145	181590
A0005408117	181588	A0095429317	181587	M981S70106	192063	MD183399	181590
A0005408217	181586	A0095429417	181587	MC840219	180641	MD184939	181591
A0005408317	181586			MD001482	180641	MD185334	181591
A0005408517	181588	<b>mitsubishi</b>		MD001483	180641	MD185335	181591
A0005408617	181586	134768	134768	MD001800	150395	MD186392	181591
A0005408917	181588	1588A002	181591	MD001804	150395	MD186990	181591
A0005409017	181588	1588A005	181591	MD003801	150395	MD186991	181590
A0005409117	181588	1588A020	181590	MD003804	150395	MD186992	181591
A0005409517	181590	1588A021	181591	MD003806	150395	MD188208	181590
A0005409617	181588	1588A043	181591	MD008820	150395	MD188408	181590
A0005409717	181588	1588A050	181591	MD008821	150395	MD189007	181591
A0006409617	181588	1588A051	181591	MD011225	181584	MD189008	181591
A0011595001	100652	1588A069	181591	MD017430	180641	MD192071	181591
A0011595601	100678	1588A070	181591	MD017612	150395	MD192072	181591
A0011595701	100680	1588A107	181591	MD021566	180641	MD192091	181591
A0011595801	100680	1588A117	181591	MD021567	180641	MD194705	181591
A0011596601	100680	1588A206	181590	MD050212	100246	MD197511	100510
A0011596801	100678	1588A207	181590	MD068355	080457	MD198529	181590
A0015400117	181588	1588A209	181591	MD070717	080705	MD198535	181590
A0015400417	181590	1588A210	181591	MD070718	080417	MD300080	181590
A0015400517	181592	210843	210843	MD073175	181584	MD301950	100670
A0015400717	181592	210948	210948	MD073461	181584	MD302068	181591
A0015400817	181588	3921021320	181584	MD073546	181584	MD305144	181590
A0015401017	181588	3921021340	181584	MD076706	181584	MD305145	181591
A0015401117	181588	3921024520	181584	MD077621	181584	MD305146	181591
A0015401217	181588	3921024550	181584	MD078791	181584	MD305147	181591
A0015401317	181586	56028998AB	181591	MD088116	181584	MD305148	181591
A0015402817	181588	56029049AA	181590	MD088616	181584	MD305149	181591
A0015403717	181592	56029050AA	181590	MD089922	181584	MD306893	181591
A0015403817	181592	9475021010	180641	MD092392	100310	MD306894	181591
A0015404617	181592	9475021020	180641	MD107793	181584	MD307258	181590
A0015404717	181592	9475021030	180641	MD108934	181584	MD311230	181590
A0015405017	181592	A00715X05271	190470	MD109613	181584	MD312083	181591
A0015405117	181592	A00715X05371	191789	MD110487	181584	MD312084	181591
A0015406017	181592	A414X01471	192065	MD1110492	181584	MD313819	181591
A0015407017	181592	A414X06771	192065	MD117240	181584	MD314060	181591
A0015407117	181592	A414X12771	191267	MD117242	181584	MD314061	181591
A0015407317	181592	A414X12871	191267	MD117280	181584	MD314062	181591
A0015407417	181592	A414X18271	191267	MD119210	181584	MD314687	181590
A0015407517	181592	A414X22871	191267	MD119609	181584	MD315175	181591
A0015407617	181592	A414X24271	191586	MD121306	181584	MD319786	181590
A0015407917	181591	A414X24671	191586	MD126181	181584	MD319787	181591
A0015408017	181592	A715X01871	190470	MD127062	181584	MD319788	181592

OE No.	HC-CARGO	OE No.	HC-CARGO	OE No.	HC-CARGO	OE No.	HC-CARGO
MD327610	181590	MN122267	181591	IG-D1908H	150072	RL18012	160477
MD327611	181590	MN135962	181591	IG-D1910H	150057	RL8024	160478
MD329341	181591	MN135963	181591	IG-D1912	150175	RLAC412	160239
MD330259	181591	MN153010	181590	IG-D1951	150064	RLAC424	160240
MD331050	181590	MN158670	181590	IG-D1951H	150064	RLP412	160311
MD331887	181591	MN158671	181590	IG-D1959H	150062	RLP512	160265
MD332735	181591	MN158757	181590	IG-D1961HV	150063	RLP5212D	160270
MD333990	181591	MN158758	181590	IG-D1978	150239	RLP5224	160216
MD333993	181591	MN158759	181591	IG-D1979	150239	RLP5224D	160271
MD333994	181591	MN158773	181591	IG-D1980HV	150239	RLP524	160266
MD333995	181590	MN158916	181591	IG-F138H	150067	RLPA412	160083
MD333996	181590	MN158917	181591	IG-FT001H	150088	RLPA424	160215
MD334299	181590	MN158918	181590	IG-FT004	150165	RLPA5212	160316
MD335028	181590	MN158919	181590	IG-H004H	150056	RLPA5224	160317
MD335040	181591	MN158920	181591	IG-H005H	150075	RLPD12	160267
MD335051	181591	MN158921	181591	IG-H010	150154	RLPS12	160282
MD335431	181590	MN158997	181592	IG-H016K	150227	RLPS412	160282
MD335916	181591	MN163400	181590	IG-HD003	150236	RLPS424	160307
MD336448	181590	MN163401	181590	IG-M001	150068	RLPS5212	160308
MD336490	181590	MN163465	181590	IG-M004H	150096	RLPS5224	160337
MD337891	181590	MN163466	181590	IG-M004HV	150096	RP10024	160721
MD338845	181591	MN163467	181590	IG-M005	150160	RP12012	160720
MD338846	181590	MN163468	181591	IG-M007	150234	RTP612	160461
MD339640	181591	MN163469	181591	IG-M009	150377	RZE212	160347
MD339641	181591	MN163470	181591	IG-M010	150378	TDP1212	160423
MD342323	181590	MN163491	181590	IG-N5016	150398	TPD1010	160426
MD342688	181591	MN163492	181591	IG-SK001	150215	TPD512	160424
MD342689	181591	MN183468	181590			TPD612	160425
MD342693	181590	MN183469	181590	<b>MOTORCRAFT</b>		TPDSG612	160451
MD342694	181590	MN985103	181591	EDY4(2)	150067	TPF612	160416
MD342775	181590	MR135963	181591	EDY8	150057	TPPF612	160469
MD343421	181591	MR420631	181590	EFG3	AS301	TPPSS712	160421
MD343986	181591	MR420979	181591	EFG315	AS301	TPPSS712	160422
MD343987	181591	MR507028	181591	EFG5	AS301	TRM1212	160438
MD343988	181591	MR507031	181591	SW978	180636	TRMK1212	160438
MD343989	181591	MR507385	181590				
MD344002	181591	MR507386	181590	<b>MOTOROLA</b>		<b>NEC</b>	
MD344469	100670	MR507387	181591	AM2	150058	MC8132	150236
MD345230	181591	MR507809	181591	GM1	150058	MC8183	150236
MD345770	181591	MR507846	181590			MC8541	150236
MD345771	181591	MR507854	181591				
MD345772	181590	MR514342	181591	<b>MWM</b>		<b>NEW HOLLAND</b>	
MD345773	181591	MR560318	181591	008379050055	090020	8017114	090318
MD348512	181591	MR560331	181590	2613603	080696	82006984	070134
MD354500	100670	MR560364	181590	304920000002	080692		
MD354850	181590	MR560365	181591	305209900020	090020	<b>NGK</b>	
MD354851	181590	MR560366	181591	305209900039	090020	1239	100512
MD357265	181591	MR561593	181590	604920100610	080696	1249	100271
MD357266	181591	MR578081	181590	605202000021	090016	1250	100511
MD357284	181590	MR578113	181591	605202030028	090015	2188	100259
MD357285	181590	MR578114	181591	605202030031	090202	2190	100282
MD357286	181591	MR578532	181591	606901200143	080696	2408	100436
MD359910	181591	MR578634	181590	905202000021	090016	2431	100252
MD360181	181591	MR985102	181590	906901200136	080390	2785	100331
MD360182	181590	MR985103	181591			3413	100645
MD365014	181590	MR985164	181590	<b>NAGARES</b>		3782	100283
MD365016	181591	MR985165	181591	AVE212	160276	4389	100650
MD366935	181591	MR988902	181590	BED712	160795	4479	100303
MD366936	181591	MR988903	181590	BRE512	160718	4602	100284
MD369190	181590	MR988905	181590	BRE612	160719	4751	100303
MD369192	181591	MR998905	181590	IT4412	160243	5116	100515
MD560366	181591	MW119210	181584	ITA412	160312	5274	100335
MD607364	150068	MW30899625	181191	ITA512	160314	5376	100260
MD607409	150417			ITE3	160312	7-207	100512
MD607478(2)	150068	<b>MOBILETRON</b>		ITE324	160313	7464	100515
MD607814(2)	150096	CE-08	150246	ITG312	160242	7825	100280
MD611384(2)	150096	CE-24	150259	ITG324	160261	CX-01	100325
MD611384(2)	150377	CE-28	150505	ITG412	160244	CY-01	100302
MD618268	150377	CE-30	150434	ITGS312	160242	CY-02	100326
MD618293	150378	CE-38	150433	ITGS324	160261	CY-03	100513
MD620889	100573	CE-42	150441	ITGS412	160243	CY-05	100563
ME200970	100563	CE-45	150508	ITH3	160341	CY-07	100510
ME201632	100559	CE-51	150509	ITJS312	160315	CY-08	100336
ME201638	100563	CE-56	150428	ITRC6	160262	CZ-01	100324
ME203583	100559	CF-46	150416	MR1220	160363	CZ-104	100681
ME203754	100559	CG-16	150403	PPC512	160434	CZ-106	100678
MM401621	100581	IG-B002H	150055	PPC712	160436	CZ-22	100555
MM409510	100521	IG-B018K	150435	RDP512	160168	CZ-301	100641
MN119979	181591	IG-D1906	150058	RDP524	160169		



OE No.	HC-CARGO	OE No.	HC-CARGO	OE No.	HC-CARGO	OE No.	HC-CARGO
226A0-3S601	181589	226A0-EA210	181591	1214311	100292	6237754	150064
226A0-3S602	181589	226A1-0W002	181589	1214312	100292	6237777	150175
226A0-3S603	181589	226A1-18Y01	181589	1214317	100511	6238109	150468
226A0-3S606	181589	226A1-18Y02	181589	1214319	100511	6238179	181395
226A0-3S607	181589	226A1-18Y03	181589	1214427	100527	6238317	180875
226A0-3S608	181589	226A1-18Y05	181589	1214457	100544	6238422	181395
226A0-3S660	181589	226A1-4L711	181589	1237334	150380	8 55 305	181584
226A0-3S661	181589	226A1-4L712	181589	1237464	150380	8 55 315	181584
226A0-3S665	181589	226A1-4L715	181589	1237504	150063	8 55 333	181584
226A0-3S666	181589	226A1-4S100	181589	1237539	150387	8 55 389	181590
226A0-4J901	181589	226A1-4S101	181589	1238532	160416	813561	AS301
226A0-4J903	181589	226A1-4S102	181589	1238537	160416	815004	070053
226A0-4L710	181589	226A1-4S103	181589	1238539	160295	815005	070053
226A0-4L711	181589	226A1-4W001	181589	1238540	160295	815011	070053
226A0-4L713	181589	226A1-4W004	181589	1238542	160352	819833	080696
226A0-4M210	181589	226A1-4W010	181589	1238549	160295	821093	081129
226A0-4M221	181589	226A1-4W011	181589	1238550	160297	821204	080444
226A0-4S000	181589	226A1-5M011	181589	1238563	160352	821701	080388
226A0-4S001	181589	226A1-5M012	181589	1238565	160416	82511978	100275
226A0-4S010	181589	226A1-5W900	181591	1238566	160352	88900717	100538
226A0-4S011	181589	226A1-5Y700	181589	1238621	160311	88900729	100650
226A0-4S100	181589	226A1-5Y701	181589	1238966	160295	90006499	150098
226A0-4S101	181589	226A1-67U02	181589	1239260	181150	90019495	100086
226A0-4S102	181589	226A1-8J100	181589	1239266	181182	90020443	070053
226A0-4S103	181589	226A1-8U700	181590	1239271	181182	90033357	100086
226A0-4S110	181589	226A1-AM601	181591	1245789	160549	90040991	100303
226A0-4S112	181589	226A1-AR210	181591	12565428	181591	90040992	160416
226A0-4S113	181589	23750-00QAH	150404	12567680	181591	90051950	100511
226A0-4W001	181589	25012-4A00A	181591	12569391	181591	90062964	150098
226A0-4W005	181589	25230-89978	160480	13101741	160904	90093867	100511
226A0-4W010	181589	25240-89911	180641	1337464	150175	90093897	100511
226A0-5E410	181589	26350-G9801	160276	1338444	180875	90140327	080696
226A0-5E411	181589	28810-G9708	160395	1338448	180808	90166155	100511
226A0-5E412	181589	28810-G9709	160396	1338451	180875	9018201	100544
226A0-5E413	181589	31661-11300	100353	1338458	180875	90187341(2)	150056
226A0-5E460	181589	36531-PNB014	181591	1338467	181395	90188755	150098
226A0-5E461	181589	98831-6F720	181584	1338506	180636	90210824	100511
226A0-5M010	181589	B2690-12P01	181585	1338511	181395	90228928	160416
226A0-5M011	181589	B2690-30R00	181584	1341010	181034	90240651	160416
226A0-5M012	181589	B26A0-67U01	181589	1341030	181088	90243618	150175
226A0-5W900	181591			13411010	181034	90292723	070053
226A0-5Y700	181589	<b>NORTHWEST</b>		1342561	180808	90349944	070053
226A0-5Y701	181589	889-NT	210846	1342567	180808	90360315	150175
226A0-67U01	181589	<b>OKI</b>		1342568	180808	90383817	160549
226A0-67U03	181589	MNE-301	150236	1450156	160197	90444189	150387
226A0-6B701	181589	MNE-302	150236	1450174	160197	90444650	150379
226A0-6B702	181589	MNE-303	150236	1450182	160197	90448286	070203
226A0-6B703	181589	<b>OPEL</b>		1780229	080696	90449574	150379
226A0-6M402	181589	1207248	150055	1845089	160879	90450998	160549
226A0-6M406	181589	1208008	150525	1845110	160879	90462248	150387
226A0-6N161	181590	1208033	150056	1845789	160549	90464952	160416
226A0-6P101	181589	1208037	150056	1845790	160549	90487858	100511
226A0-6P103	181589	1208063	150403	1845791	160549	90502704	081129
226A0-6P104	181589	1208074	150379	22127653	160197	90509271	070203
226A0-6P107	181589	1208241	150056	24402859	181592	90510089	160549
226A0-6P108	181589	1208243	150098	24403860	181592	90510924	100511
226A0-7B013	181589	1208246	150056	25133391	181584	90529673	181495
226A0-7B014	181589	1208248	150055	25163613	181584	90526650	080388
226A0-7B503	181589	1208307	150521	25164596	181584	90543282	181495
226A0-7B504	181589	1211560	150062	32017066	100665	91159996	150505
226A0-7J100	181589	1211561	150064	32017084	100665	9117693	081115
226A0-7J101	181589	1211582	150063	4401810	180905	9150494480(2)	150055
226A0-7J400	181589	1211591	150063	4402309	181064	9150633880(2)	150055
226A0-7J401	181589	1214028	100662	4402560	150404	9158718	181590
226A0-7J402	181589	1214032	100627	440389	150505	9196669	100594
226A0-7S001	181591	1214035	100555	4409990	160795	9202575	181590
226A0-81F01	181589	1214036	100662	4506156	160795	9202577	181590
226A0-81F02	181589	1214065	100555	4772216	180808	9287211	160311
226A0-81F04	181589	1214300	100583	592790	150055	93161575	100676
226A0-81F11	181589	1214301	100555	594502	150055	93178047	100627
226A0-81F12	181589	1214303	100086	594503	150055	93198468	100676
226A0-8J010	181591	1214304	100511	594531(2)	150055	94221719	100245
226A0-8U300	181591	1214305	100511	594533(2)	150055	94241449	100245
226A0-9E800	181589	1214306	100511	594539(2)	150055	94255588	100245
226A0-9E801	181589	1214307	100511	594548	150055	94319700	100292
226A0-AM601	181591	1214310	100426	594560(2)	150055	94481972	100426
226A0-AR210	181591			5954839	100662	97080554	100336
226A0-AU011	181591			6237752	150062	97532831(2)	150055
226A0-EA200	181591			6237753	150063		

## ACCESSORIES

O.E.M. names and numbers are used for reference purposes only.

OE No.	HC-CARGO	OE No.	HC-CARGO	OE No.	HC-CARGO	OE No.	HC-CARGO
<b>OSRAM</b>		64115	170380	7225	171093	1192.W5	181495
0881	171010	64122MF	170751	7234	171531	1264.03	181008
2321MFX	171379	64124MF	170752	7234	171977	1264.04	181009
2322MFX	171380	6413	170343	7240	171994	1264.13	181009
2351MF6	171381	6413	171097	7240	172033	1264.14	181008
2351MFX6	170727	64132	170741	7301	170579	1264.26	181076
2351MFX6	171109	64132	171082	7309	170575	1264.37	181076
2352MFX6	170756	64136	170742	7326	171985	1264.40	181076
2352MFX6	171110	64136	171083	7327	170815	126403	181008
2452MFX6	171023	64138	171084	7327	171975	126404	181009
2473MFX6	171033	64149	170696	7351	171974	126413	181009
2721	170410	64150	170069	7360	171976	126414	181008
2721	170775	64150	170332	7429	171088	126426	181076
2721MF	170357	64150NBU	171686	7430	170583	126432	181089
2721MF8	170612	64150SUP	170965	7501	171984	126437	181076
2721MF8W	170545	64150SUP	171070	7506	170335	126440	181076
2721MFHZ	171382	64151	170070	7506	170769	1338.10	181373
2721MFJF	171384	64151	170333	7506L	170658	1338.55	181373
2721MFX	171024	64151NBP	171687	7506L	171979	133850	180875
2722MF	170610	64152	170493	7507	171089	133857	180875
2722MF8	170611	64153	170496	7507	170648	1338C7	181395
2741	170477	64155	170449	7507LDA	171371	145059	070053
2741	171108	64155	171072	7511	170349	145070	070054
2741MF	170358	64156	170412	7511	170826	145205	160354
2741MF8	170613	64156	170836	7512	170481	1618 V3	181591
2741MFX	171028	64173	171073	7512A	170481	1625 09	181584
2820	170725	64176	171691	7517	171476	1628 58	181584
2820	171121	6418	170341	7526	171983	1628 7R	181589
2821	170331	6418	171094	7527	171988	1628 J4	181589
2821	171104	64183	170681	7528	170336	1628 KN	181590
2825	170347	64185	170718	7528	170770	1628 KP	181591
2825	171105	64193	170334	7528L	170659	1628 L4	181589
2825L	170662	64193	170768	7535	171996	1628 LP	181590
2827	170754	64193	170804	7537	170452	1628 NY	181590
2840	171027	64193GP	171114	7537	171092	1628 AA	181589
2841	170476	64193L	170657	7569	170577	1628L4	160424
2841	171106	64193L	171113	7597	170614	1906-08	AS301
2845	170542	64193NBU	171688	7597	171986	1906-13	AS301
2845	171107	64193SUP	170804	7669	171978	194101	080696
3757	170711	64193SUP	171066	7869	170577	197805	080696
3796	170345	64196	170348	7869	171991	197806	080696
3796	171103	64196	170792	7950	171477	198105	080802
3797	170416	64199	170006	7951	170338	198133	080761
3797	170796	64210	170720	7951	170771	2257.17	181152
3892	171492	64210NBU	171689	7952	170350	2257.22	181156
3893	170346	64211	171037	9004	170692	2257.33	181201
3893	170774	64211NBU	171690	9005	170693	2257.34	181194
3894	170594	64212	171034	9006	170694	2257.40	181194
3895	171491	64213	171035	9006XS	171794	2257.41	181201
3896	171490	64215	170800	9145	171036	225734	181194
3898	170448	64215	171080	94196	170450	225740	181194
3898	171119	64215L	171532	94196	171125	225741	181201
3899	170456	64216	172073	9507	170849	321430650	AS301
3930	170417	6423	170414	9507	171090	33781405324	181588
3930	170795	6423	171096	9511	170451	4534.02	180731
5001	171480	6424	171099	9511	171078	4534.06	180726
5001	171993	6428	170590	9627	170455	453411	180785
5006	171981	6429	171100	9627	171118	453421	180785
5007	170340	6438	170005	9637	170454	5414813	100262
5007	170773	6439	170591	9637	171076	5471660	070053
5007L	170660	6451	170342			5906079	100663
5007L	171980	6453	170592	<b>PERKINS</b>		592789	150058
5008	170339	6457	170643	185366190	100619	594525	150055
5008	170772	6461	170411	2848A270	090225	594533	150055
5008L	171992	6461	171095	2848A275	090225	594539	150055
5407	170593	6475	170588	2848A279	090225	594545	150057
5626	171102	6476	171139	3028666	090254	594554	150379
5627	170413	6480	170589	5836B100	090404	594555	150057
5627	170794	66042	171613			594555	150057
5631	171990	66050	171132	<b>PEUGEOT</b>		594560	150055
5637	170351	66140	171613	0242.12	181005	596012	100593
5637	170793	66144	171613	0242.18	180950	596019	100593
62203	170009	66154	171683	0242.26	180954	596064	100674
64070	170493	66240	171133	0242.30	180953	596065	100674
64070	171068	66350	171710	0242.36	180950	596076	100622
6411	170344	66440	171713	0242.36	180950	596078	100663
6411	171098	66450	171711	0242.43	180953	596099	100664
64111	170470	7135	170816	0242.46	180875	5960E7	100683
64113	170502	7225	170644	0242.49	180954	596118	100566
				024246	180875	596139	100511



OE No.	HC-CARGO	OE No.	HC-CARGO	OE No.	HC-CARGO	OE No.	HC-CARGO
596140	100511	9150633880	150055	9639912580	160453	12454	170493
596153	100511	9150771880	100511	9752287580	150055	12454	171068
596154	100511	9150861080	100511	97522876	150055	12455	170496
596157	100511	91514046	181008	97530125	150055	12458	170718
596158	100511	9151404980	070053	9753012580	150055	12475	170681
59622Z	100335	91514549	180875	9753130180	150057	12496	170648
59623C	100533	91514733	181152	97531304	150057	12496	171089
59623E	100533	9151586980	160424	9753130480	150057	12496SV	171371
59623H	100541	91517978	181584	97531922	150055	12498	170335
59623J	100541	9151797880	181584	97532831	150055	12498	170769
59624J	100436	9151819080	070054	9753283180	150055	12498LL	170658
596274	100511	9151819380	181585	97533831	150055	12498LL	171979
59627F	100533	91519272	180954	9999163554	160354	12499	170336
59627G	100533	91521849	100511	E144001	181589	12499	170770
5962J2	100511	91521918	100511	E144003	181590	12499LL	170659
5962J4	100511	9153571880	181585	E144004	181592	12503	171994
5962J5	100511	9153664680	100511	E144005	181584	12503	172033
5962J6	100511	9153880680	070053	E144008	181586	12516	170410
5962K5	100511	9153880780	070054	MKD00066	100511	12516	170775
5962R8	100511	91541882	160354	MKD00068	100303	12569	170009
5962S8	100511	9250883280	160423	MKP00064	100511	12569	171065
5962T1	100511	9250888280	160423	MKP00065	100511	12594	170644
5962T3	100511	92515667	160424	MKP00067	100511	12594	171093
5962T7	100511	9251586780	160424	MKP00068	100303	12596	170071
5962W2	100335	9251586980	160424	MKP00069	100511	12597	170612
5962W3	100335	93010500	100656	ND14365	AS301	12598	170357
5962W8	100511	9301050080	100656	PD14365A	AS301	12600	170610
5962X1	100511	9401906138	AS301			12601	170611
5970.80	150520	94531104	150057	<b>PHILIPS</b>		12602	170611
597010	150395	9453130480	150057	12023	170470	12604	170610
597011	150395	9456130480	150057	12025	170380	12605	170357
597026	150395	95 494 924	181584	12027	171124	12605	170610
597048	150259	9549299580	160423	12036	170741	12620	170338
597053	150252	95493206	100511	12036	171082	12620	170771
597078	150522	95493258	181015	12039	170591	12718	171985
597079	150522	95494924	181584	12040	170948	12728	170815
5974555	150057	95495591	180953	12052	170822	12728	171975
598110	160423	95496621	160353	12060	170726	12748	171974
598111	160424	95534787	160423	12060C1	171010	12803	171139
598113	160423	95534788	100511	12064	171135	12807	170588
598115	160424	95575783	AS301	12065	170777	12814	170339
598116	160431	95579683	180953	12066	170776	12814	170772
598119	160432	95658442	160518	12188	171869	12814LL	171992
598120	160431	96009783	100511	12190NA	172074	12818	170590
598121	160436	9600978380	100303	12227	170575	12821	170340
598124	160434	9601329480	160354	12241	170577	12821	170773
598126	160436	96018108	181201	12241	171991	12821LL	170660
598127	160436	96018110	181194	12247	170579	12821LL	171980
598131	160453	96033248	181373	12256	170331	12822	170593
6434.60	160629	9603682780	181589	12256	171104	12829	170448
644178	160565	96040821	180785	12258	170069	12829	171119
644195	160518	9604807080	150098	12258	170332	12844	170341
655117	160308	96053749	160431	12258BV	171071	12844	171094
655504	160308	9607312	150379	12258PR	170965	12850	170342
655522	160353	96073612	150379	12258PR	171070	12854	170411
655533	160282	9607361280	150379	12258VP	171136	12854	171095
655547	160354	96076258	100303	12311	171073	12860	170005
75454205	181156	96104689	100511	12336	170070	12864	170343
75491289	181156	96117510	160431	12336	170333	12864	171097
75513845	150058	96123564	181064	12342	170334	12865	170005
7563225100	100566	9613572480	100541	12342	170768	12866	170344
7700591730	181152	96138637	181076	12342	170804	12866	171098
7910013785	180950	96141677	160432	12342	171067	12875	170509
7910014016	180950	96141678	100511	12342BV	171114	12886	170951
7910014017	180950	96165724	100511	12342GO	171114	12886	171953
7910033931	180731	96165734	100335	12342GOLD	171114	12886	171953
7910035100	150055	96165823	160436	12342LL	170657	12894	170726
7910035225	181584	9616582380	160436	12342LL	171113	12910	170594
7920076593	160423	9616582480	160434	12342PR	170804	12913	170345
7932564528	100511	96165824	160434	12342PR	171066	12913	171103
7932564528	100511	9616582480	160434	12342VP	171134	12929	170346
7932565492	100566	9619879180	160570	12356	170742	12929	170774
7932567717	100511	96236383	100533	12356	171083	12960	170725
7932567718	100511	96252036	160432	12396	170754	12960	171121
91 517 978	181584	9633214380	100541	12396	171123	12961	170347
91000409	160354	9635864980	150522	12402	170583	12961	171105
9100040980	160354	9635884880	150522	12413	171990	12961LL	170662
91504912	150055	9636997880	150520	12422	171989	12972	170720
9150491280	150055	96381671	192902	12428	170696	12972	171077
9150494480	150055	96389858	100533	12445	171988	12972BV	171079

OE No.	HC-CARGO	OE No.	HC-CARGO	OE No.	HC-CARGO	OE No.	HC-CARGO
<b>PHILIPS continued</b>							
12972LL	171117	6910	171490	15-8345	160250	7700590793	160316
12972PR	171081	6913	171491	16010892	150063	7700663363	080388
12972VP	171137	6929	171492	16017433	150062	7700670255	180511
13241	171978	7779	171027	1875990	150058	7700673874	100511
13256	170476	85122	171133	1894322	150058	7700681024	181584
13256	171106	85126	171132	1978778	150062	7700687710	070053
13258	170449	85410	171613	1987465	150239	7700701130	100511
13258	171072	9004	170692	1987466	150239	7700702747	160425
13324	170614	9005	170693	1989233	191554	7700704185	100511
13324	171986	9006	170694	1989649	191307	7700708605	181584
13336	170412			1989747	150239	7700708955	181584
13336	170836	<b>PIAGGIO</b>		210843	210843	7700708960	160352
13342	170348	639523	181584	210909	210909	7700715675	160352
13342	170792			7033103	150064	7700715768	100511
13342HD	170450	<b>PORSCHE</b>		7954117	180660	7700721268	160354
13342HD	171125	043906091	070053	830931	150058	7700722393	070053
13401	171086	191905351A	150075	93488922	150058	7700728637	150340
13402	171088	90161357101	180634	9348922	150058	7700728638	150340
13413	171997	91109417700	181584	9439738	191545	7700729063	181584
13422	170481	91160612300	181584	D1906	150058	7700729963	181584
13445	171996	92860270601	150098	D1951	150064	7700732506	181152
13454	170494	92860612301	181584	D1957	150063	7700733076	100511
13496	170849	92860612400	181585	D1958	150063	7700737571	180905
13496	171090	92860612800	181585	D1959	150062	7700739793	150340
13498	170349	92860612801	181585	D1961	150063	7700739794	150340
13498	170826	92860810401	070054	D1978	150239	7700740296	080390
13498HD	170451	92860810402	070054	D1979	150239	7700741144	100511
13498HD	171078	92862817200	160197	D1980	150239	7700751089	160425
13499	170452	93060612400	181585	D1990	150239	7700757776	160425
13499	171092	93160620600	181584	D1993	150239	7700771786	180963
13516	170477	94460612500	180875	SU31	180808	7700778780	181191
13516	171108	94460613300	181584			7700782503	181064
13521M	170358	94460613500	181585	<b>RENAULT</b>		7700786460	180963
13593	170360	94460613501	181585	0003005810	090076	7700790579	160438
13597	170613	94460613502	181585	0003008010	080696	7700796048	181064
13598	170358	94460810200	070054	0003008077	080696	7700802640	181191
13620	170350	94460810201	070054	0003020501	090016	7700851443	160438
13628	170362	94460810202	070054	0003020504	090015	7700854406	080388
13748	171976	94460810203	070054	0024571084	090016	7700855358	070053
13807	170589	94460810204	070054	0024571087	090202	7700855865	100511
13814	170351	94460810205	070054	0025835028	090020	7700856238	100511
13814	170793	94460810206	070054	0025838009	090202	7700856789	160438
13814HD	170454	95160613500	181585	0025838028	090020	7700863454	160438
13814HD	171076	96460612401	181586	0122910100	090016	7700864987	181585
13821	170413	96560612600	181585	0854672000	090076	7700866727	160451
13821	170794	96560612601	181585	0855454800	080696	7700867374	160438
13821HD	170455	98660612600	181588	0870363800	090016	7700867408	181590
13821HD	171118	98660612601	181588	5000409614	160417	7700867558C	160461
13822	171102	98660612701	181588	5000787913	161035	7700869343	180905
13829	170456	98660612801	181588	5000812388	090020	7700875000	150505
13844	170414	99360270600	150379	5001001311	100342	7701006410	090016
13844	171096	99360611600	181588	5001001587	100511	7701010100	AS301
13850	170592	99360611601	181588	5010589425	161035	7701011757	090015
13864	171099	99360611800	181588	5100106510	080696	7701021955	150058
13866	171100	99360611801	181588	6001008001	070053	7701026846	080696
13913	170416	99360612600	181588	7401269084	150056	7701029762	100511
13929	170417	99360612601	181588	7401271939	181588	7701039387	100511
13929	170795	99360612700	181588	7439146108	150496	7701044974	080940
13961	170542	99360612800	181588	7700100635	100592	7701045695	080942
13961	171107	99360612801	181588	7700100643	150434	7701052949	100662
13972	170800	99660611800	181588	7700100940	100592	7701057806	100662
13972	171080			7700101969	150414	7701348194	181008
13972LL	171532	<b>PUROLATOR</b>		7700101970	150404	7701348716	181152
24356	171084	40106N	070188	7700103069A	150404	7701348734	160438
24362	172073	40222	070076	7700103674	100646	7701348772	180950
6336	171469	50107	070191	7700107177	150505	7701349475	100511
6402	171998	60107	070191	7700107794	160461	7701349943	100511
6421	171995			7700109860	160718	7701414081	100303
6445/99	171983	<b>REMY (DELCO)</b>		7700111323	100436	7701414083	100303
6458	171473	10471917	191304	7700111525	160719	7701414086	100511
6498	171984	10475057	191584	7700113357	150505	7701414089	100303
6499	171476	10488150	191304	7700113357A	150505	7701414162	100511
6620	171477	10496048	150239	7700115078	160795	7703597062	192902
6807	171479	10496541	150239	7700260678	070054	7704002224	080390
6811	171484	10496784	150239	7700267774	070054	8200012099	100646
6814	171480	10498156	191304	7700273273	181585	8200051128	150441
6814	171993	11505767	191573	7700273715	181585	8200052063	181590
6821	171981	13010892	150063	7700274008	150433	8200084401	150441
6854	171487	13017433	150062	7700414988	181367	8200154186	150505















OE No.	HC-CARGO	OE No.	HC-CARGO	OE No.	HC-CARGO	OE No.	HC-CARGO
1270535	181588	35175017	180839	13132031	160442	54401101	160261
1271576	181586	3523608	160401	13132032	160443	54401102	160296
1271939	181588	3523639	160400	13132034	160445	54407006	160262
1271940	181588	35254	150395	13132035	160446	54407008	160199
1271955	181588	3531075	181589	13132036	160447	58226606A	160904
1271986	181588	3531251	181587	13132037	160448	58226608	160904
1274144	181584	3531400	181587	13731048	160425	60201001	160297
1274367	181584	35446913	180734	13735045	160438	60201002	160297
1274746	181584	35601160	160416	13735052	160425	60215005	160287
1275610	181588	36446913	180734	20200000	160282		
1276951	181584	3650116	160416	20200006	160282	<b>WOODWARD</b>	
1287028	160792	464901	181584	20200100A	160080	1504-12A7U1B1000	090439
1298429	150055	464947	181584	20200102	160155	1751-12A3U1B1S1A	090210
1306932	070054	679364	180734	20200111	160239	2300-1505	090431
1317809	150056	6793640	180734	20200140	160155	SA-3527-TX	090439
1317820	150055	6820812	160734	20201000	160308	SA-4092-24	090116
131-8906	081004	6842522	181588	20201000A	160308		
1324750	180660	6842619	181588	20201100	160081	<b>YANMAR</b>	
13247507	180660	7035254	150395	20201100A	160081	129155-77801	100522
1326730	160352	77989	090076	20201101	160403		
13323969	180875	829857	100511	20201103	160270	<b>ZEXEL</b>	
13325840	150098	829859	100511	20206100	160267	105000-1600	100353
13336679	070054	829859	100656	20207100	160265	105000-1740	100342
1336679	070054	834461	150395	20207100A	160265	105210-6560	090440
1347603	160401	837329	100511	20210100	160083	105210-0720	080177
1348600	160400	840643	100511	20211100	160316	146650-0820	080178
1363438	160458	8627600	181591	20400000	160307	146650-1220	080177
1367776	150387	8631582	081115	20400100	160082	146650-1320	080178
1378123	181587	8631607	100622	20400100A	160082	150623-4000	080389
1378504	181034	8642230	181591	20400102	160473	150623-4200	080688
13785043	181034	8658090	181591	20400111	160240	150623-4400	080736
1383966	150496	8670112	181495	20401000	160337	150623-4500	080734
1389939	150056	8670130	181591	20401100	160216	150623-4900	080388
1542303	100342	8670167	181591	20401100A	160216	150623-5200	080689
1542319	100284	8670263	181495	20401103	160271	NP-DN0SD193	100342
1542411	100284	8677894	181591	20407100	160266	NP-DN12SD12	100353
1606877	180660	870240	090015	20410100	160215		
16068777	180660	870680	100583	20411100	160317		
190990	080696	870846	100583	21203100	160168		
20390648	161035	874368	192902	21403100	160169		
21255974	161035	9125371	181588	22200111	160239		
2223608	160401	9125372	181588	22200117A	160239		
2223639	160400	9125580	181588	22400111	160240		
233379	080696	9125582	181588	22400117A	160240		
236628	AS301	9125601	150514	29200006	160363		
238364	090202	9135621	181585	29200045	160364		
239235	090202	9135622	181588	29201005	160365		
241380	090016	9135664	181589	29201045	160366		
243083	090020	9135793	181587	29201075	160367		
243488	080696	9135794	181585	29401000	160368		
244002	090020	9142045	070054	29401041	160521		
244391	090020	9146108	150496	50205002	160295		
244825	090315	9148494	181584	50205603	160295		
285211	070054	9162987	160458	50237009	160459		
285227	160352	9179101	181588	50237010	160460		
30617335	181592	9186934	181592	51216001	160416		
30617336	181592	9202719	181588	51216002	160416		
3062252	181591	9434225	160792	51216003	160416		
30637520	181591	9458187	181591	51216901	160421		
30637521	181591	9458189	181592	51223908	160352		
30637837	181591	9470011	181591	51223909	160352		
30650109	181591	9497345	181592	51233001	160421		
30713416	150514	9497347	181592	51233006	160421		
30777311	100665	968372	171026	51233011	160422		
30777404	080209	968689	171025	51299002	160424		
30872555	160461	981189	171377	51299003	160431		
30873658	160461	990053	192902	51299004	160432		
3205207	160197			51299006	160431		
32112047	181073	<b>WEBCON</b>		51299007	160453		
32772047	181073	13704	210762	51401004	160466		
3285227	160352	13710	210763	54201006	160305		
32866410	181077	GAS1	180526	54201030	160305		
32940645	150395			54201101	160242		
3345280	AS301	<b>WEHRLE</b>		54201102	160243		
33452806	AS301	10485007	190767	54201103	160244		
34741140	181191	10485008	190766	54201108	160314		
34741143	181191	10700005	191026	54212001	160314		
3477646	160197	13003404	160769	54229001	160263		
3517501	180839	13132030	160441	54229002	160263		





# Index

Edition 2016/2017

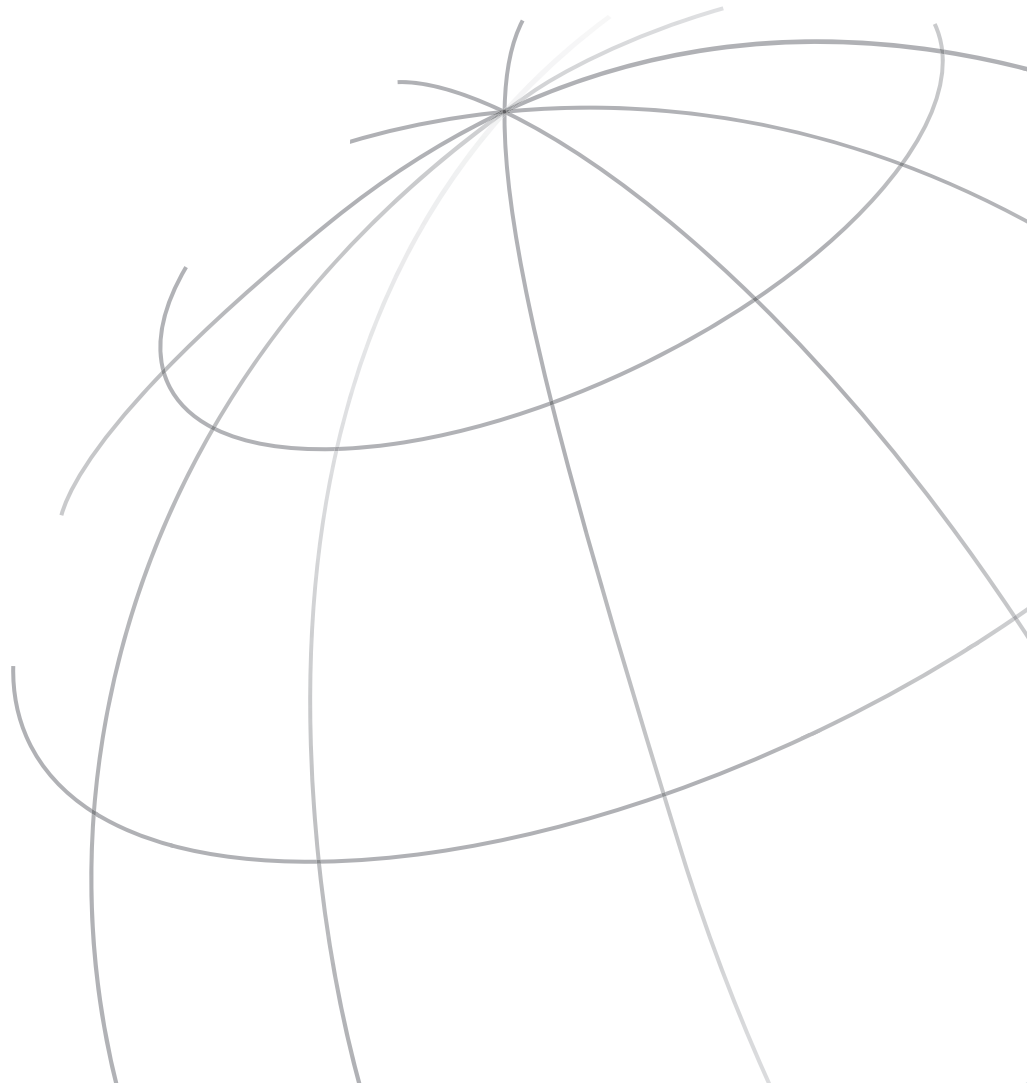

HC-CARGO	Page	HC-CARGO	Page	HC-CARGO	Page	HC-CARGO	Page
06219	508	070156	226	080237	531	080405	566
040019	289	070157	226	080238	531	080406	566
040077	288	070160	226	080239	531	080407	566
040094	288	070161	232	080240	531	080408	566
040096	289	070162	230	080241	531	080410	565
040149	291	070172	227	080242	531	080412	565
040170	291	070173	229	080243	531	080417	565
040181	288	070175	230	080245	531	080418	566
040182	288	070177	231	080246	531	080419	566
040190	289	070181	234	080247	531	080423	566
040191	289	070182	229	080250	529	080424	566
040192	289	070184	233	080251	532	080425	565
040193	291	070187	232	080252	532	080426	565
040197	290	070188	232	080253	532	080427	565
040199	289	070191	232	080254	532	080428	565
040200	290	070192	227	080255	532	080430	565
040201	290	070203	227	080256	532	080431	565
040215	289	070206	227	080257	532	080432	565
060058	274	070208	229	080258	532	080433	565
060213	273	070209	229	080259	517	080434	565
060214	273	070214	231	080260	517	080435	565
060215	274	080001	532	080261	517	080436	565
060216	272	080002	531	080262	517	080437	566
060219	274	080003	531	080263	517	080438	565
060220	272	080004	567	080264	517	080439	565
060222	272	080031	566	080265	517	080440	565
060223	272	080032	567	080268	517	080441	565
060227	274	080033	566	080269	532	080442	565
060229	273	080035	566	080270	532	080443	565
060233	273	080038	241	080271	532	080444	565
060235	273	080046	252	080272	532	080446	565
060237	274	080047	252	080273	532	080447	565
060241	273	080055	254	080274	531	080448	565
070003	230	080059	247	080275	531	080449	566
070004	230	080064	247	080276	531	080450	565
070019	233	080071	248	080277	533	080452	565
070021	233	080097	248	080278	533	080453	565
070032	231	080099	248	080279	533	080454	565
070053	235	080108	529	080280	533	080456	565
070054	235	080109	529	080281	533	080457	254
070055	236	080111	529	080282	533	080458	254
070056	233	080114	241	080283	532	080459	254
070057	233	080161	569	080284	532	080465	238
070058	230	080162	569	080285	517	080467	254
070067	233	080163	569	080287	517	080575	532
070070	234	080164	569	080288	517	080582	255
070076	231	080165	569	080289	517	080595	224
070077	234	080168	248	080292	248	080614	241
070078	231	080170	248	080294	249	080627	532
070107	232	080177	223	080295	249	080629	530
070134	231	080178	223	080296	565	080653	530
070144	226	080188	256	080297	517	080654	530
070145	227	080205	248	080298	532	080655	530
070147	228	080207	223	080340	254	080656	530
070148	228	080208	223	080388	566	080657	530
070149	228	080209	223	080389	254	080659	531
070150	228	080210	223	080390	566	080660	531
070151	228	080211	223	080397	565	080661	531
070152	229	080212	224	080398	566	080662	530
070153	227	080213	529	080402	565	080663	530
070154	225	080232	569	080403	565	080664	530
070155	226	080236	566	080404	566	080665	530

HC-CARGO	Page	HC-CARGO	Page	HC-CARGO	Page	HC-CARGO	Page
080666	530	080855	234	090061	241	090200	218
080667	517	080857	234	090062	243	090202	246
080668	517	080858	234	090071	239	090203	236
080669	517	080859	531	090072	239	090206	218
080678	531	080860	531	090073	239	090210	220
080679	531	080863	531	090074	251	090212	256
080680	224	080865	255	090076	251	090213	236
080688	565	080866	255	090078	516	090216	218
080689	565	080868	256	090079	516	090218	220
080690	530	080873	224	090080	516	090222	243
080691	565	080875	234	090081	516	090223	243
080692	565	080879	255	090082	516	090224	221
080695	249	080926	224	090086	252	090225	218
080696	565	080929	224	090087	252	090226	218
080701	238	080930	517	090092	256	090228	218
080702	238	080931	517	090095	215	090233	243
080703	249	080933	250	090096	215	090235	246
080705	565	080940	222	090097	216	090239	547
080721	251	080941	222	090098	217	090241	547
080730	249	080942	222	090099	215	090242	243
080731	532	080944	238	090100	215	090244	244
080732	566	080954	234	090101	217	090250	246
080734	565	080955	235	090102	217	090251	246
080736	566	080958	235	090103	216	090253	246
080738	249	080959	235	090104	216	090254	246
080739	565	080960	235	090105	216	090255	546
080742	249	080969	242	090106	216	090257	546
080744	531	080995	224	090107	216	090259	548
080745	531	080996	225	090108	216	090267	219
080751	529	080998	225	090109	217	090268	221
080752	241	081000	225	090110	217	090269	547
080757	241	081002	225	090111	217	090273	547
080761	565	081003	250	090113	217	090277	244
080763	565	081004	242	090115	222	090278	244
080773	241	081006	529	090116	222	090281	219
080777	565	081007	239	090127	239	090292	546
080783	250	081039	235	090133	547	090293	516
080784	530	081040	235	090136	243	090294	244
080785	530	081041	255	090145	238	090296	548
080786	530	081055	565	090146	238	090297	221
080793	250	081058	251	090147	252	090301	547
080795	531	081067	565	090150	243	090314	246
080802	565	081068	565	090151	245	090315	247
080803	565	081111	530	090153	546	090316	240
080805	239	081113	565	090156	245	090317	221
080809	251	081114	565	090159	251	090318	221
080811	250	081115	565	090160	220	090319	240
080812	532	081116	532	090161	220	090320	240
080815	242	081117	222	090165	256	090333	247
080824	242	081129	255	090166	239	090334	221
080826	531	081166	225	090167	240	090337	247
080828	256	081169	251	090168	220	090344	244
080829	517	081173	565	090169	220	090345	236
080830	517	081176	238	090170	515	090346	236
080831	517	081209	565	090171	515	090347	240
080836	531	081212	565	090172	240	090348	219
080838	531	090015	244	090187	245	090349	548
080839	531	090016	245	090193	236	090370	219
080840	250	090020	245	090194	236	090371	219
080843	531	090027	242	090197	245	090372	548
080852	250	090047	242	090198	245	090373	219
080854	234	090055	242	090199	218	090381	240

HC-CARGO	Page	HC-CARGO	Page	HC-CARGO	Page	HC-CARGO	Page
090391	247	100432	257	100639	258	150165	299
090402	221	100433	257	100640	258	150169	296
090404	237	100434	257	100641	258	150175	299
090409	548	100435	257	100642	258	150215	300
090430	222	100436	257	100644	258	150227	302
090431	219	100471	253	100645	258	150234	300
090439	220	100510	257	100646	258	150236	300
090440	247	100511	257	100650	258	150239	300
090441	244	100512	257	100651	258	150246	293
100079	257	100513	258	100652	258	150252	294
100086	257	100514	258	100653	258	150259	294
100177	257	100515	258	100656	258	150266	294
100245	257	100516	258	100657	258	150270	294
100246	257	100518	258	100658	259	150340	313
100247	257	100520	258	100659	259	150354	313
100251	257	100521	258	100660	259	150377	300
100252	257	100522	258	100661	259	150378	300
100254	257	100523	258	100662	259	150379	300
100256	257	100524	258	100663	259	150380	301
100257	257	100525	253	100664	259	150384	301
100258	257	100527	258	100665	259	150387	301
100259	257	100529	258	100666	259	150395	297
100260	257	100531	258	100667	259	150398	301
100261	257	100532	258	100668	259	150401	515
100262	257	100533	258	100669	259	150403	302
100263	257	100534	258	100670	259	150404	314
100271	257	100536	258	100671	259	150406	301
100275	257	100537	258	100673	259	150408	290
100276	257	100538	258	100674	259	150409	301
100277	257	100540	258	100675	259	150414	314
100280	257	100541	258	100676	259	150416	294
100282	257	100544	258	100678	259	150417	301
100283	257	100545	258	100679	259	150424	294
100284	257	100548	258	100680	259	150428	294
100286	257	100555	258	100681	259	150433	295
100287	257	100556	258	100682	259	150434	295
100291	257	100557	258	100683	259	150435	302
100292	257	100559	258	100684	259	150441	295
100295	257	100560	258	132804	366	150451	314
100302	257	100561	258	134686	520	150468	314
100303	257	100563	258	134768	566	150470	314
100306	257	100565	258	135061	533	150496	314
100307	257	100566	258	150037	296	150505	295
100310	257	100573	253	150055	297	150508	295
100320	257	100578	258	150056	297	150509	295
100323	257	100580	258	150057	297	150512	302
100324	257	100581	258	150058	297	150513	295
100325	257	100583	258	150062	297	150514	296
100326	257	100590	258	150063	298	150516	302
100327	257	100592	258	150064	298	150520	296
100331	257	100593	258	150067	298	150521	296
100335	257	100594	258	150068	298	150522	296
100336	257	100595	258	150072	298	150525	296
100337	257	100614	258	150075	298	160002	186
100339	257	100616	258	150088	298	160005	264
100342	252	100619	258	150096	299	160006	264
100344	253	100622	258	150098	299	160019	275
100348	253	100624	258	150100	290	160022	276
100352	253	100625	258	150101	290	160023	276
100353	253	100627	258	150154	299	160024	276
100426	257	100634	258	150157	299	160025	275
100429	257	100636	258	150160	299	160026	275

HC-CARGO	Page	HC-CARGO	Page	HC-CARGO	Page	HC-CARGO	Page
160028	275	160291	280	160379	285	160469	259, 462
160031	279	160292	280	160380	285	160470	450
160032	279	160293	280	160381	285	160473	438
160033	279	160294	385	160382	285	160474	453
160034	280	160295	449	160383	285	160475	453
160035	275	160296	455	160386	285	160477	436
160036	185	160297	447	160387	189	160478	439
160038	187	160300	385	160388	189	160480	434
160039	188	160305	452	160389	189	160481	184
160042	188	160306	189	160390	190	160482	184
160048	187	160307	437	160391	191	160483	261
160080	433	160308	443	160392	191	160484	277
160081	443	160311	434	160393	185	160485	277
160082	437	160312	452	160394	445	160486	277
160083	433	160313	455	160395	278	160487	277
160115	451	160314	452	160396	279	160502	192, 464
160116	451	160315	453	160398	203	160503	281
160150	278	160316	443	160399	203	160504	281
160155	433	160317	445	160400	450	160506	281
160167	192, 464	160321	275	160401	450	160507	286
160168	441	160322	275	160402	453	160508	187
160169	442	160323	275	160403	443	160509	433
160186	283	160325	275	160407	456	160510	261
160187	283	160326	275	160408	281	160511	262
160188	283	160327	275	160409	385	160512	262
160192	287	160328	275	160410	184	160513	260
160195	288	160329	275	160411	275	160515	260
160197	284	160330	275	160413	288	160518	260
160198	284	160332	284	160414	185	160520	260
160199	455	160333	188	160415	185	160521	446
160213	188	160334	188	160416	259, 457	160533	184
160215	437	160337	445	160417	259, 457	160534	185
160216	445	160338	276	160418	259, 457	160535	286
160223	284	160339	277	160419	259, 457	160536	266
160239	435	160341	453	160420	259, 457	160537	266
160240	439	160342	202	160421	259, 457	160538	266
160242	451	160343	203	160422	259, 458	160539	266
160243	452	160346	184	160423	259, 458	160541	193
160244	452	160347	433	160424	259, 458	160542	193
160250	265	160350	449	160425	259, 458	160543	193
160251	265	160352	449	160426	259, 458	160544	193
160252	265	160353	449	160431	259, 458	160545	193
160253	265	160354	449	160432	259, 459	160546	193
160256	276	160355	187	160434	259, 459	160549	263
160257	276	160356	187	160436	259, 459	160550	260
160258	280	160357	281	160438	259, 459	160551	385
160261	455	160358	277	160441	259, 459	160556	262
160262	455	160359	277	160442	259, 459	160557	262
160263	452	160360	284	160443	259, 460	160558	281
160265	434	160361	284	160445	259, 460	160565	263
160266	437	160363	440	160446	259, 460	160569	193
160267	442	160364	441	160447	259, 460	160570	447
160270	443	160365	444	160448	259, 460	160571	278
160271	445	160366	444	160449	259, 460	160578	451
160272	439	160367	444	160451	259, 461	160579	192
160273	283	160368	446	160453	259, 461	160580	192
160276	432	160370	275	160458	259, 461	160581	194
160278	432	160372	449	160459	259, 461	160584	268
160282	434	160374	450	160460	259, 461	160586	275
160287	448	160375	450	160461	259, 461	160587	268
160289	284	160376	278	160466	447	160588	269
160290	280	160378	285	160468	435	160591	260

HC-CARGO	Page	HC-CARGO	Page	HC-CARGO	Page	HC-CARGO	Page
160592	262	160689	184	160874	201	160952	456
160593	262	160695	291	160875	201	160953	456
160594	262	160696	292	160876	203	160954	454
160595	269	160697	291	160877	204	160955	456
160596	263	160698	291	160878	263	160956	454
160597	269	160699	293	160879	261	160957	454
160598	266	160700	293	160880	178	160958	456
160599	269	160701	292	160881	279	160959	456
160600	269	160702	292	160884	183	160960	191
160601	266	160710	261	160888	182	160965	183
160610	178	160712	186	160889	182	160966	272
160611	182	160714	270	160890	438	160967	283
160612	182	160716	455	160897	292	160970	99, 113, 200
160613	182	160718	259, 462	160899	189	160971	99, 114, 201
160619	269	160719	259, 462	160900	189	160972	178
160620	260	160720	436	160901	189	160973	283
160621	261	160721	439	160902	441	160974	444
160622	265	160725	282	160903	434	160975	440
160626	265	160727	278	160904	432	160976	445
160627	200	160734	264	160906	270	160977	440
160628	275	160737	270	160907	270	160978	440
160629	286	160739	267	160908	271	160979	440
160630	286	160740	203	160909	271	160980	446
160631	261	160741	275	160910	267	160981	446
160632	187	160742	203	160911	267	160982	435
160633	275	160744	187	160912	267	160983	435
160635	275	160745	275	160913	267	160984	442
160637	448	160746	186	160914	267	160985	442
160638	275	160747	292	160915	268	160986	186
160639	263	160748	275	160916	183	160987	186
160640	190	160749	447	160917	287	160988	186
160641	275	160750	275	160918	441	160989	186
160642	190	160751	450	160919	444	160990	201
160643	275	160753	275	160920	444	160991	194
160644	191	160755	275	160921	443	160992	447
160645	275	160756	188	160922	436	160993	183
160646	190	160757	275	160923	436	160994	176
160647	263	160758	276	160926	438	160995	180
160648	275	160761	275	160927	448	160996	176
160649	263	160762	264	160928	448	160997	180
160650	275	160765	264	160929	434	160998	271
160651	451	160766	275	160930	184	160999	271
160652	433	160767	261	160931	436	161000	268
160653	275	160769	439	160932	443	161001	271
160654	446	160771	275	160933	441	161002	268
160655	275	160775	176	160934	441	161003	268
160658	185	160776	180	160935	438	161004	271
160659	282	160777	270	160936	438	161005	176
160660	194	160778	293	160937	439	161006	178
160661	275	160779	293	160938	442	161007	177
160671	279	160783	176	160939	442	161008	448
160672	182	160784	180	160940	436	161009	435
160674	264	160786	311	160941	437	161010	446
160676	194	160787	313	160942	444	161013	275
160677	286	160792	451	160944	445	161014	202
160679	286	160793	176	160945	435	161015	202
160680	286	160794	264	160946	437	161016	202
160681	287	160795	259, 462	160947	438	161017	202
160682	287	160797	192, 464	160948	453	161018	202
160683	287	160799	270	160949	454	161019	202
160686	287	160872	292	160950	454	161020	446
160688	287	160873	293	160951	454	161021	278



HC-CARGO	Page	HC-CARGO	Page	HC-CARGO	Page	HC-CARGO	Page
161022	282	161086	195	170169	135	170410	165
161023	282	161087	195	170170	136	170411	165
161024	282	161088	195	170171	144	170412	156
161025	282	161089	195	170208	136	170413	164
161026	201	161090	195	170212	136	170414	166
161027	177	161091	196	170213	136	170416	164
161028	178	161092	196	170237	40	170417	164
161029	178	161093	196	170239	62	170419	38
161030	179	161094	196	170292	37	170433	149
161032	180	161095	196	170293	59	170435	10
161033	179	161096	196	170295	10	170436	10
161034	181	161097	196	170296	10	170437	10
161035	440	161098	197	170308	14	170438	10
161036	183	161099	197	170309	14	170448	164
161037	183	161100	197	170310	60	170449	156
161038	179	161101	197	170311	60	170450	157
161039	177	161102	197	170313	40	170451	163
161040	181	161103	197	170331	164	170452	162
161041	179	161104	197	170332	156	170454	163
161042	200	161105	198	170333	156	170455	164
161043	179	161106	198	170334	157	170456	164
161044	183	161107	198	170335	163	170460	38
161045	200	161108	198	170336	162	170470	169
161046	177	161109	198	170338	167	170476	165
161047	181	161110	198	170339	164	170477	165
161048	177	161111	198	170340	164	170488	40
161049	181	161112	199	170341	165	170489	40
161050	179	161113	199	170342	166	170490	11
161051	177	161114	199	170343	165	170491	11
161052	181	161115	199	170344	166	170492	15
161053	181	161116	199	170345	164	170493	156
161054	178	161580	275	170346	164	170494	156
161055	182	161701	201	170347	164	170496	156
161056	179	161704	199	170348	157	170502	169
161057	180	161705	199	170349	163	170505	15
161058	180	161706	200	170350	167	170506	15
161059	204	161707	200	170351	163	170509	169
161060	204	161710	200	170353	146	170512	156
161061	274	161711	432	170357	168	170513	157
161062	274	170002	122	170358	168	170514	157
161063	275	170005	166	170359	157	170515	157
161064	275	170006	157	170360	157	170525	16, 24
161065	275	170009	157	170362	156	170528	15, 24
161066	275	170032	134	170364	167	170531	38
161067	275	170033	134	170366	15	170534	41
161068	275	170035	134	170380	169	170537	38
161069	275	170036	134	170387	37	170540	11
161070	275	170069	156	170390	144	170541	11
161071	275	170070	156	170391	145	170542	165
161072	190	170071	157	170392	145	170543	15
161073	190	170093	40	170393	145	170545	168
161074	191	170132	60	170394	141	170550	65
161075	191	170135	149	170395	142	170551	11
161077	191	170136	149	170396	142	170552	116
161078	194	170137	149	170397	140	170562	38
161079	192	170138	149	170398	140	170564	59
161080	190	170139	149	170401	142	170575	166
161081	192	170142	135	170402	142	170577	166
161082	194	170143	135	170403	140	170579	166
161083	194	170144	135	170405	37	170583	162
161084	195	170163	135	170406	38	170588	166
161085	195	170165	135	170407	144	170589	166

HC-CARGO	Page	HC-CARGO	Page	HC-CARGO	Page	HC-CARGO	Page
170590	165	170688	79	170795	163	170929	79
170591	165	170689	78	170796	163	170930	80
170592	166	170690	63	170797	145	170934	78
170593	163	170692	159	170798	12	170935	78
170594	164	170693	159	170799	150	170936	122
170596	150	170694	159	170800	158	170939	81, 127
170598	11	170696	156	170802	157	170940	81, 128
170599	12	170698	167	170803	157	170941	71, 128
170601	12	170710	160	170804	157	170942	128
170602	99	170711	160	170805	165	170943	82
170603	99	170712	169	170806	164	170944	89
170604	92	170713	72	170807	164	170945	15, 20
170610	168	170718	157	170808	164	170946	74
170611	168	170720	158	170809	126	170948	164
170612	168	170725	164	170810	164	170951	161
170613	168	170726	161	170811	157	170952	68
170614	163	170727	168	170812	157	170960	148
170616	64	170729	138	170813	163	170964	151
170617	165	170731	165	170816	166	170965	156
170619	150	170732	165	170822	163	170968	108
170621	66	170741	158	170825	158	170970	41
170623	136	170742	159	170826	162	170972	168
170624	136	170746	125	170827	151	170974	61
170625	136	170748	125	170828	126	170975	75
170626	137	170749	169	170829	126	170976	68
170627	137	170750	169	170830	12	170979	42
170628	137	170751	169	170833	89, 127	170980	42
170629	137	170752	169	170834	71, 127	170981	42
170630	137	170753	168	170835	126	170982	42
170631	137	170754	164	170836	156	170983	42
170632	117	170755	168	170837	158	170984	43
170633	117	170756	168	170839	169	170985	82
170635	118	170757	168	170843	61	170986	82
170636	118	170758	168	170844	62	170987	90
170640	117	170759	145	170846	81	170989	72
170641	118	170762	167	170847	89	170990	101
170642	118	170763	150	170848	169	170991	101
170643	556	170768	157	170849	163	170998	101
170644	162	170769	162	170850	162	170999	101
170648	163	170770	161	170851	41	171000	108
170650	21	170771	166	170857	41	171005	21
170651	21	170772	162	170859	41	171006	61
170653	24, 59	170773	163	170865	61	171007	62
170654	23	170774	163	170867	63	171008	62
170657	157	170775	164	170868	63	171009	160
170658	163	170776	162	170875	67	171010	161
170659	162	170777	163	170880	74	171013	82
170662	164	170778	164	170881	67	171014	82
170664	135	170779	164	170884	74	171015	90
170665	108	170780	164	170885	74	171016	90
170668	117	170781	164	170887	68	171019	12
170670	73	170782	168	170893	100	171023	167
170671	73, 118	170783	168	170895	100	171024	167
170675	137	170784	168	170909	78, 80, 110	171025	167
170676	137	170785	168	170910	79, 81, 108	171026	167
170677	138	170788	38	170916	100	171027	164
170680	21	170789	39	170917	100	171028	167
170681	157	170790	150	170922	100	171029	168
170683	145	170791	150	170923	101	171031	167
170684	165	170792	157	170925	71	171032	167
170685	81	170793	162	170927	71	171033	168
170687	89	170794	163	170928	79	171034	160

HC-CARGO	Page	HC-CARGO	Page	HC-CARGO	Page	HC-CARGO	Page
171035	160	171108	164	171284	167	171426	151
171036	160	171109	167	171299	102	171427	151
171037	160	171110	167	171302	103	171428	129
171038	61	171111	168	171303	103	171441	104
171039	159	171112	167	171306	103	171442	104
171040	170	171113	157	171307	109	171443	104
171042	170	171114	157	171308	103	171444	105
171043	170	171117	158	171311	103	171446	109
171044	170	171118	163	171312	109	171447	105
171045	123	171119	163	171322	109	171448	105
171049	126	171120	165	171328	85, 104	171449	43
171050	83	171121	164	171329	86, 104	171451	65
171051	83	171122	164	171330	91, 109	171452	64
171052	83	171123	164	171331	114	171453	152
171053	83	171124	169	171332	68	171455	167
171054	84	171125	157	171337	73	171464	59
171055	84	171128	165	171339	73	171466	59
171056	90	171129	165	171343	74	171469	156
171057	90	171132	161	171345	123	171472	164
171058	90	171133	161	171347	43	171473	157
171059	90	171134	157	171356	129	171474	157
171060	12	171135	159	171359	65	171476	162
171061	13	171136	156	171360	64	171477	167
171062	108	171137	158	171361	65	171479	165
171064	157	171139	166	171362	64	171480	164
171065	157	171140	72	171363	65	171484	165
171066	157	171141	72	171364	64	171487	165
171067	157	171147	72	171365	65	171490	163
171068	156	171148	73	171366	64	171491	164
171070	156	171153	73	171369	74	171492	164
171071	156	171162	90	171371	162	171493	68
171072	156	171164	123	171372	92	171494	13
171073	156	171166	123	171373	93	171495	22
171076	162	171167	43	171376	23	171497	22
171077	158	171168	43	171377	167	171498	22
171078	162	171173	114	171378	156, 169	171505	22
171079	158	171181	114	171379	167	171506	105
171080	158	171183	73	171380	167	171507	109
171081	158	171192	84, 102	171381	167	171508	105
171082	158	171193	84, 102	171382	167	171510	71
171083	159	171195	84, 102	171383	167	171513	39
171084	159	171196	117	171384	167	171518	39, 388
171086	162	171202	85	171388	168	171521	109
171088	162	171203	85	171389	167	171528	118
171089	162	171206	102	171390	162	171529	118
171090	162	171213	85	171391	164	171530	119
171091	162	171214	85	171392	134	171531	166
171092	161	171217	71	171396	134	171532	158
171093	161	171220	80	171398	163	171533	86
171094	165	171222	78	171399	13	171534	86
171095	165	171225	123	171401	163	171536	138
171096	165	171228	138	171402	162	171537	93
171097	165	171230	138	171403	162	171538	93
171098	165	171253	91	171404	156	171540	22
171099	165	171258	91	171405	156	171541	22
171100	165	171263	108	171407	156, 169	171549	94, 111
171102	163	171265	91	171408	169	171550	111
171103	163	171266	92	171410	169	171554	141
171104	164	171280	169	171411	169	171555	141
171105	164	171281	151	171423	13	171556	141
171106	164	171282	151	171424	13	171561	23
171107	164	171283	165	171425	169	171562	39, 388

HC-CARGO	Page	HC-CARGO	Page	HC-CARGO	Page	HC-CARGO	Page
171564	44	171677	129	171750	130	171822	86, 128
171565	62	171679	130	171751	46	171823	123
171566	44	171680	32	171752	47	171824	125
171568	142	171681	31	171753	47	171825	131
171570	141	171682	35	171755	47	171826	131
171571	142	171683	161	171756	95	171827	131
171572	141	171684	79	171757	95	171828	132
171573	148	171685	80	171758	96	171829	132
171575	141	171686	156	171759	96	171830	132
171576	39	171687	156	171760	32	171831	132
171577	13	171688	157	171761	32	171832	132
171587	14	171689	158	171762	35	171833	128
171588	14	171690	160	171763	17	171834	128
171590	23	171691	158	171764	17	171835	76
171591	119	171695	130	171767	130	171836	76
171592	119	171696	130	171768	130	171837	167
171593	119	171700	106	171769	131	171838	48
171594	57	171701	106	171770	74	171839	76
171595	58	171702	109	171771	115	171840	115
171597	66	171703	110	171772	96	171841	69
171605	114	171704	147	171773	131	171842	76
171610	68	171705	14	171774	47	171843	115
171611	58	171706	117	171775	47	171844	69
171613	161	171708	23	171776	131	171845	45
171614	23	171709	124	171777	35	171846	48
171615	58	171710	161	171778	35	171847	48
171617	119	171711	161	171779	36	171848	45
171618	75	171712	161	171780	36	171849	32
171619	44	171713	161	171781	36	171850	32
171620	44	171714	124	171782	45	171851	33
171621	125	171715	124	171783	152	171852	33
171622	123	171716	124	171784	152	171853	33
171624	124	171717	69	171787	146	171854	33
171625	58	171718	69	171788	93, 110	171855	36
171626	58	171719	115	171789	96	171856	36
171627	117	171720	115	171790	96	171857	36
171635	114	171721	75	171791	97	171858	36
171636	75	171722	75	171793	14	171859	37
171637	114	171723	46	171794	159	171860	76
171638	68	171725	95, 111	171795	128	171861	116
171639	77	171726	79, 80, 95, 111	171796	158	171862	69
171640	45	171727	46	171797	146	171863	132
171642	24	171728	30	171798	23	171864	133
171644	24	171729	75	171800	72	171865	37
171646	24	171730	119	171801	72	171866	133
171648	25	171731	119	171802	106	171867	116
171657	29	171732	120	171803	106	171868	70
171658	30	171733	120	171804	159	171869	166
171661	25	171734	120	171805	146	171870	107, 129
171662	25	171735	75	171806	106	171871	107, 129
171663	30	171736	76	171807	107	171872	127
171664	30	171737	124	171808	107	171873	127
171665	94, 111	171738	124	171809	107	171874	133
171666	94, 111	171739	67	171810	110	171875	133
171667	94	171740	67	171811	48	171876	133
171668	95	171741	67	171813	25	171877	133
171671	46	171742	76	171814	25	171878	142
171672	46	171743	115	171816	30	171879	143
171673	16	171744	69	171817	31	171880	143
171674	16	171745	44	171818	126	171881	143
171675	30	171746	25	171820	31	171882	143
171676	129	171749	146	171821	127	171883	138

HC-CARGO	Page	HC-CARGO	Page	HC-CARGO	Page	HC-CARGO	Page
171884	138	171948	50	172011	27	172073	160
171885	139	171949	50	172012	27	172074	166
171886	139	171950	50	172013	27	172075	20
171887	139	171951	50	172014	78	172076	27
171888	139	171952	98, 112	172015	93	172077	55
171889	139	171953	160	172016	93	172078	55
171891	143	171954	152	172017	51	172079	55
171892	143	171955	50	172018	52	172080	55
171893	143	171956	70	172019	52	172081	55
171894	144	171957	18	172020	52	172082	56
171895	144	171958	120	172021	87	172083	56
171896	144	171959	120	172022	87	172084	56
171897	144	171960	120	172023	91	172085	27
171898	139	171961	121	172024	91	172086	27
171899	139	171962	121	172025	87	172087	28
171900	140	171963	121	172026	87	172088	53
171901	140	171964	121	172027	19	172089	28
171902	140	171965	121	172028	19	172090	28
171903	140	171966	121	172029	19	172091	28
171904	26	171967	122	172030	19	172092	66
171905	26	171968	122	172031	52	172093	66
171906	26	171969	122	172032	52	172094	35
171907	31	171970	122	172033	162	172095	56
171908	31	171971	18	172034	116	172096	56
171909	33	171972	19	172035	116	172097	57
171910	34	171973	19	172036	77	172098	57
171911	34	171974	166	172037	77	172099	20
171912	34	171975	166	172038	70	172100	20
171913	34	171976	166	172039	70	172101	20
171914	34	171977	166	172040	116	172102	67
171915	37	171978	166	172041	77	172103	147
171916	37	171979	162	172042	77	172104	147
171917	86, 108	171980	163	172043	70	172105	53
171918	17	171981	163	172044	70	172106	54
171919	17	171982	162	172045	53	172107	54
171920	17	171983	163	172046	53	172108	28
171921	18	171984	162	172047	88	172109	28
171922	18	171985	166	172048	88	172110	16
171923	18	171986	162	172049	88	172111	158
171924	152	171987	168	172050	88	172112	28
171925	152	171988	162	172051	91	172113	29
171926	26	171989	162	172052	91	172114	20
171927	97, 112	171990	162	172053	60	172115	35
171928	97, 112	171991	166	172054	60	172116	57
171929	97, 112	171992	162	172055	53	172117	80
171930	97, 112	171993	163	172056	53	172118	29
171931	18	171994	162	172057	92	172119	54
171933	26	171995	162	172058	92	172120	54
171934	26	171996	162	172059	66	172121	29
171935	127	171997	162	172060	66	172122	29
171936	45, 59	171998	162	172061	98, 112	172123	29
171937	62	171999	148	172062	98, 113	172124	29
171938	48	172000	149	172063	98, 113	172125	31
171939	49	172001	51	172064	98, 113	180001	403
171940	49	172002	125	172065	99, 113	180007	468
171941	21	172003	51	172066	94, 110	180008	305
171942	21	172004	51	172067	99, 113	180009	306
171943	27	172005	54	172068	89	180010	482
171944	49	172007	79	172069	89	180014	428
171945	49	172008	54	172070	92	180015	428
171946	49	172009	125	172071	92	180016	428
171947	49	172010	51	172072	152	180017	428

HC-CARGO	Page	HC-CARGO	Page	HC-CARGO	Page	HC-CARGO	Page
180018	481	180201	389	180296	396	180529	488
180021	483	180202	208	180297	401	180530	380
180022	483	180203	204	180298	390	180531	380
180023	483	180206	472	180305	391	180532	380
180025	212	180207	472	180306	392	180533	382
180027	213	180208	473	180307	392	180534	382
180028	204	180209	474	180308	398	180535	380
180029	208	180210	474	180313	205	180536	382
180036	481	180211	204	180314	468	180537	382
180038	385	180212	399	180315	386	180538	382
180039	478	180213	390	180316	405	180542	381
180040	483	180214	394	180324	212	180543	381
180041	213	180215	484	180325	408	180548	380
180043	213	180216	205	180326	205	180549	382
180044	213	180218	393	180327	391	180550	384
180045	212	180219	396	180329	394	180551	384
180047	484	180220	401	180330	400	180552	384
180048	478	180221	390	180332	391	180554	382
180049	484	180225	403	180333	209	180556	210
180087	204	180226	405	180338	207	180560	409
180088	481	180227	405	180339	214	180561	409
180090	470	180228	405	180340	214	180562	381
180091	481	180229	205	180341	214	180563	381
180092	481	180230	388	180343	428	180568	396
180094	481	180232	209	180344	429	180569	396
180099	471	180233	210	180345	429	180570	401
180100	471	180238	399	180346	429	180571	396
180101	471	180239	393	180347	429	180572	406
180103	483	180240	396	180348	429	180574	391
180104	483	180241	401	180349	408	180575	384
180107	399	180242	400	180350	408	180577	384
180108	399	180243	395	180351	396	180580	383
180110	392	180245	406	180352	397	180581	383
180111	400	180247	404	180353	402	180582	383
180112	395	180248	403	180354	386	180583	383
180113	387	180249	394	180372	404	180584	479
180115	385	180251	406	180373	391	180585	479
180121	484	180252	402	180374	208	180586	479
180123	484	180253	397	180375	208	180587	479
180140	482	180254	487	180376	39, 386	180588	479
180141	482	180255	487	180377	39, 386	180589	479
180143	208	180261	487	180380	381	180590	479
180144	403	180263	488	180381	380	180591	480
180147	399	180265	488	180382	380	180592	480
180150	392	180266	488	180383	380	180593	480
180153	395	180268	488	180384	382	180594	480
180154	400	180269	488	180385	382	180595	482
180156	468	180271	206	180386	384	180596	205
180157	386	180272	206	180387	384	180597	468
180158	468	180273	208	180390	380	180598	469
180159	468	180274	206	180391	382	180599	469
180176	471	180275	206	180392	382	180600	469
180177	471	180276	207	180395	384	180601	469
180178	471	180277	207	180396	384	180602	210
180179	471	180278	207	180399	388	180603	210
180180	472	180285	402	180400	484	180604	210
180194	405	180286	398	180401	402	180605	210
180195	405	180287	388	180402	395	180606	391
180196	405	180288	208	180403	403	180607	397
180197	407	180289	205	180404	398	180608	397
180198	407	180290	210	180405	403	180610	401
180199	409	180293	393	180526	316	180611	398

HC-CARGO	Page	HC-CARGO	Page	HC-CARGO	Page	HC-CARGO	Page
180612	402	181089	311	181473	398	181586	315
180613	404	181121	311	181474	398	181587	315
180614	205	181126	311	181475	206	181588	315
180616	384	181147	307	181476	211	181589	315
180618	480	181148	307	181477	209	181590	315
180619	209	181150	307	181485	393	181591	315
180620	393	181152	307	181489	404	181592	316
180622	392	181156	307	181491	316	181595	215
180624	401	181158	308	181494	316	181596	215
180625	488	181179	308	181495	316	181597	215
180626	302	181182	308	181500	316	181598	214
180627	469	181183	308	181501	381	181599	207
180628	469	181191	308	181502	381	181600	404
180631	303	181194	308	181503	381	181601	387
180634	303	181197	308	181504	381	181602	389
180635	303	181201	308	181505	381	181603	209
180636	303	181212	309	181510	394	181604	393
180641	303	181233	483	181516	381	181605	383
180648	303	181235	213	181517	382	181606	383
180649	303	181236	214	181518	213	181607	470
180658	304	181237	214	181519	381	181608	470
180660	304	181238	207	181520	381	181609	470
180688	304	181244	211	181521	381	181610	470
180694	304	181245	211	181540	212	181611	408
180726	306	181246	212	181544	404	181612	406
180731	306	181247	211	181545	367	181613	206
180734	306	181249	486	181546	472	181614	206
180785	306	181251	486	181547	399	181615	474
180790	307	181252	486	181548	386	181616	387
180791	307	181253	486	181549	387	181617	392
180804	311	181256	486	181550	387	181618	389
180808	311	181257	486	181551	482	181619	389
180820	312	181258	487	181552	482	181620	389
180839	312	181263	487	181554	472	181621	390
180848	312	181264	487	181555	472	181622	389
180861	312	181270	209	181556	473	181623	406
180875	313	181271	211	181557	469	181624	407
180883	312	181272	484	181558	470	181625	407
180893	312	181273	390	181559	470	181626	407
180905	313	181274	394	181562	211	181627	94, 110, 407
180945	304	181275	386	181563	408	181628	407
180949	304	181276	480	181564	485	181629	388
180950	304	181277	480	181565	485	181630	408
180953	305	181278	481	181566	485	181631	387
180954	305	181328	383	181567	485	181632	474
180959	305	181329	383	181568	485	181633	430
180963	305	181367	306	181569	485	181634	430
180985	305	181369	306	181570	429	181635	430
180986	305	181373	313	181571	429	181636	430
181001	309	181395	313	181572	430	181637	431
181005	309	181400	312	181573	430	181638	473
181008	309	181456	309	181574	430	181639	473
181009	309	181461	390	181575	387	181640	473
181015	309	181462	474	181576	394	181641	474
181021	310	181463	474	181577	212	181642	475
181034	310	181465	214	181578	209	181643	475
181064	310	181466	400	181579	388	181644	475
181065	310	181467	395	181581	406	181645	475
181073	310	181469	401	181582	395	181646	475
181076	310	181470	397	181583	406	181647	475
181077	310	181471	397	181584	314	181648	475
181088	311	181472	402	181585	315	181649	475

## ACCESSORIES

O. E. M. names and numbers are used for reference purposes only.

HC-CARGO	Page	HC-CARGO	Page	HC-CARGO	Page	HC-CARGO	Page
181650	476	190041	320	190186	519	190285	413
181651	476	190042	321	190187	519	190286	413
181652	476	190043	367	190188	495	190287	413
181653	476	190045	320	190189	495	190288	413
181654	476	190046	320	190190	495	190289	413
181655	476	190048	320	190191	495	190360	559
181656	476	190049	320	190195	369	190361	559
181657	476	190050	320	190196	369	190362	559
181658	477	190051	320	190197	369	190366	559
181659	477	190052	333	190202	374	190367	559
181660	477	190053	414	190203	374	190368	559
181661	477	190054	414	190211	372	190371	559
181662	477	190055	414	190212	372	190372	559
181663	477	190056	414	190213	371	190373	559
181664	477	190057	414	190214	371	190469	559
181665	478	190058	414	190215	375	190470	559
181666	478	190059	414	190218	377	190474	559
181667	478	190060	414	190220	377	190477	559
181668	478	190061	414	190221	377	190478	559
181669	391	190093	515	190222	377	190479	559
181670	409	190094	515	190223	378	190480	559
181671	409	190095	515	190224	378	190482	559
181672	482	190096	515	190225	378	190492	560
181675	400	190097	188,	190226	378	190493	560
181677	390	190097	515	190228	378	190494	560
190001	321	190100	516	190229	378	190495	560
190002	418	190101	516	190230	378	190499	560
190004	418	190110	499	190231	379	190500	560
190005	518	190111	499	190232	379	190506	560
190006	518	190112	499	190235	379	190508	560
190007	518	190114	499	190237	379	190510	560
190008	518	190115	499	190239	379	190511	560
190009	518	190116	499	190242	379	190520	563
190010	518	190120	499	190248	495	190521	563
190011	495	190122	499	190252	326	190524	564
190012	372	190157	518	190253	377	190525	564
190013	372	190158	518	190254	377	190527	564
190014	495	190159	518	190255	321	190528	564
190015	321	190160	518	190256	327	190531	561
190016	320	190161	518	190257	321	190536	561
190017	320	190162	518	190260	339	190537	561
190018	320	190163	518	190261	339	190538	561
190019	320	190164	518	190262	340	190539	561
190020	320	190165	518	190263	341	190540	561
190021	320	190166	518	190264	341	190541	561
190022	320	190167	518	190265	341	190542	561
190023	320	190168	518	190266	342	190544	561
190024	320	190169	518	190267	342	190545	562
190025	320	190170	518	190268	342	190546	562
190026	320	190171	518	190269	342	190547	562
190027	321	190172	518	190270	324	190549	561
190028	321	190175	500	190272	340	190550	561
190029	321	190176	500	190273	421	190551	561
190030	321	190177	500	190274	413	190552	561
190031	321	190178	500	190275	413	190555	562
190032	321	190179	500	190276	413	190556	561
190033	321	190180	519	190277	413	190558	561
190034	321	190181	519	190278	413	190561	561
190035	321	190182	519	190279	413	190577	568
190037	321	190183	519	190280	413	190578	568
190038	321	190184	519	190283	333	190579	568
190039	321	190185	519	190284	413	190580	568



HC-CARGO	Page	HC-CARGO	Page	HC-CARGO	Page	HC-CARGO	Page
190581	568	190708	503	190899	493	191009	322
190582	568	190709	507	190900	493	191010	322
190583	568	190710	505	190901	493	191011	322
190584	568	190711	506	190902	493	191012	421
190587	566	190716	332	190903	493	191013	514
190588	566	190717	332	190904	493	191014	515
190589	566	190718	332	190905	493	191015	515
190590	566	190719	332	190906	493	191016	333
190591	566	190720	332	190907	493	191025	326
190592	566	190721	332	190908	493	191026	463
190593	566	190722	332	190909	493	191027	504
190594	567	190723	332	190910	503	191028	324
190598	568	190725	326	190911	369	191029	326
190599	568	190726	326	190937	518	191030	331
190603	568	190734	413	190938	518	191043	506
190604	568	190735	413	190948	505	191044	333
190605	568	190736	413	190950	506	191047	333
190608	569	190762	366	190951	503	191048	333
190609	569	190766	462	190952	321	191049	332
190610	569	190767	462	190953	321	191050	331
190612	569	190768	419	190954	505	191051	331
190613	569	190770	419	190956	367	191053	426
190614	569	190772	419	190957	421	191054	422
190616	569	190774	419	190958	499	191055	427
190632	569	190775	419	190959	499	191056	518
190633	569	190776	367	190961	494	191058	506
190634	569	190779	563	190962	494	191060	332
190638	569	190780	563	190964	499	191062	507
190666	506	190781	563	190965	499	191063	515
190667	507	190782	563	190966	499	191064	326
190674	502	190783	563	190967	499	191065	519
190675	506	190787	421	190968	499	191067	321
190675	506	190806	567	190969	499	191069	326
190676	506	190807	567	190970	499	191070	341
190677	503	190808	567	190971	368	191071	341
190678	504	190809	567	190972	503	191074	328
190680	508	190810	567	190973	321	191075	327
190681	508	190811	567	190974	321	191076	368
190682	508	190812	567	190979	506	191077	368
190683	508	190813	567	190981	506	191078	328
190684	508	190815	567	190984	515	191079	327
190685	506	190816	567	190985	320	191080	338
190686	506	190817	567	190986	503	191081	338
190687	506	190818	567	190987	503	191082	327
190688	507	190819	567	190988	503	191083	324
190689	506	190820	567	190989	503	191086	505
190690	506	190821	567	190990	503	191087	505
190691	506	190822	567	190991	503	191088	514
190693	507	190823	567	190992	503	191089	325
190695	515	190824	567	190993	506	191090	503
190696	503	190826	567	190994	515	191091	328
190697	503	190828	567	190995	515	191092	327
190698	503	190843	340	190996	515	191093	505
190699	503	190845	505	190997	515	191094	495
190700	503	190846	332	190998	515	191095	506
190701	503	190847	503	190999	515	191126	339
190702	503	190866	373	191000	515	191127	338
190703	503	190867	373	191001	422	191128	495
190704	503	190868	325	191002	505	191129	324
190705	503	190870	422	191003	495	191130	507
190706	503	190875	368	191007	337	191131	507
190707	503	190876	369	191008	326	191132	508

HC-CARGO	Page	HC-CARGO	Page	HC-CARGO	Page	HC-CARGO	Page
191133	371	191219	493	191302	564	191397	502
191134	371	191220	491	191303	564	191398	502
191135	506	191221	492	191304	564	191399	502
191136	507	191222	492	191305	564	191400	502
191152	415	191223	492	191306	564	191401	502
191153	415	191224	341	191307	564	191402	502
191154	415	191225	341	191308	564	191403	502
191155	415	191226	339	191317	561	191404	503
191156	415	191227	338	191318	561	191405	366
191157	415	191228	494	191319	561	191406	366
191158	340	191229	494	191320	562	191407	367
191159	340	191237	519	191321	562	191408	367
191160	507	191238	514	191322	561	191409	420
191161	419	191239	518	191323	561	191410	464
191162	419	191244	374	191325	560	191411	330
191163	420	191245	374	191326	560	191412	330
191164	420	191246	325	191327	560	191413	330
191165	420	191247	326	191329	560	191415	324
191166	373	191248	326	191330	560	191416	332
191167	373	191249	414	191333	532	191417	493
191168	329	191250	414	191335	567	191418	506
191169	329	191251	414	191336	569	191419	506
191171	329	191252	414	191337	566	191429	490
191172	329	191253	414	191339	568	191430	568
191175	504	191254	414	191344	568	191433	532
191176	503	191255	414	191345	568	191434	568
191177	503	191256	414	191346	568	191435	561
191178	503	191257	424	191347	568	191439	564
191179	514	191258	427	191348	568	191441	570
191182	515	191259	427	191349	568	191442	568
191183	489	191260	326	191350	568	191445	507
191184	416	191261	326	191351	568	191446	507
191185	416	191262	326	191352	568	191447	507
191186	416	191263	333	191353	568	191448	507
191187	416	191264	333	191354	568	191449	507
191188	416	191265	569	191355	568	191450	507
191189	416	191266	561	191356	568	191451	507
191190	426	191267	561	191358	567	191452	507
191191	320	191270	532	191364	528	191453	507
191192	516	191271	532	191365	528	191457	567
191193	517	191272	532	191366	528	191458	570
191195	514	191273	532	191367	528	191459	570
191196	329	191274	532	191368	528	191465	414
191197	329	191275	532	191369	528	191466	414
191200	326	191276	532	191370	528	191467	414
191201	514	191277	533	191371	528	191468	414
191202	489	191278	533	191372	528	191469	414
191203	489	191279	533	191373	528	191470	414
191204	489	191280	533	191374	528	191471	414
191205	489	191284	570	191375	528	191472	414
191206	489	191285	570	191376	528	191473	414
191207	489	191287	568	191377	519	191474	414
191208	490	191288	568	191378	519	191475	414
191209	490	191289	568	191380	499	191476	414
191210	490	191290	566	191383	499	191477	563
191211	490	191291	568	191384	499	191478	562
191212	492	191293	559	191387	499	191480	528
191213	492	191294	560	191388	500	191481	532
191214	492	191296	563	191391	528	191484	368
191215	490	191297	563	191392	528	191485	368
191216	490	191298	563	191395	502	191486	563
191218	492	191299	563	191396	502	191487	567

HC-CARGO	Page	HC-CARGO	Page	HC-CARGO	Page	HC-CARGO	Page
191489	567	191573	533	191673	415	191751	338
191490	567	191574	507	191677	563	191752	463
191491	567	191575	569	191678	561	191753	559
191494	499	191576	569	191679	379	191754	563
191495	514	191577	569	191680	422	191755	491
191498	369	191579	568	191681	323	191756	369, 493
191499	515	191580	564	191682	322	191762	561
191501	321	191582	562	191683	322	191763	561
191502	566	191584	562	191684	322	191764	331
191503	567	191585	562	191685	322	191765	331
191504	567	191586	561	191686	322	191766	331
191505	562	191587	569	191687	322	191767	466
191506	566	191592	519	191688	322	191768	421
191507	491	191593	519	191689	322	191769	422
191508	491	191594	519	191690	322	191770	561
191510	491	191595	519	191691	322	191771	370, 493
191513	564	191596	519	191692	322	191772	560
191514	560	191597	519	191693	322	191774	422
191515	321	191613	563	191694	322	191775	424
191516	507	191614	563	191695	322	191776	495
191517	507	191615	559	191696	322	191777	505
191518	507	191616	528	191697	322	191789	559
191519	507	191617	506	191698	322	191790	563
191520	507	191618	507	191699	322	191791	333
191521	507	191619	507	191700	322	191793	508
191522	507	191620	506	191701	323	191794	508
191523	507	191621	506	191702	323	191795	508
191524	507	191623	506	191703	323	191796	508
191525	508	191624	561	191704	323	191798	559
191526	508	191625	564	191705	323	191799	532
191527	508	191626	564	191706	323	191801	330
191528	562	191628	416	191707	323	191804	559
191530	562	191629	416	191708	323	191805	515
191531	562	191630	416	191709	323	191806	325
191532	568	191631	416	191710	323	191807	324
191533	561	191632	416	191711	323	191808	340
191534	413	191633	416	191713	323	191809	340
191535	507	191634	416	191717	464	191813	568
191536	559	191635	416	191718	465	191814	493
191538	567	191636	416	191719	465	191815	567
191539	563	191637	416	191721	465	191816	532
191543	328	191638	415	191722	465	191817	506
191544	328	191640	422	191723	465	191818	464
191545	560	191642	528	191724	466	191820	376
191546	560	191643	561	191725	466	191821	376
191548	567	191644	559	191726	466	191830	415
191549	324	191645	559	191727	467	191831	415
191551	325	191646	568	191728	467	191832	415
191552	570	191648	568	191729	467	191833	415
191553	493	191649	570	191730	467	191834	415
191554	561	191650	339	191731	467	191854	559
191556	327	191657	564	191732	467	191855	330
191557	562	191658	563	191733	330	191856	331
191558	562	191659	563	191734	330	191857	528
191560	567	191660	563	191735	331	191858	528
191561	342	191661	563	191737	331	191859	528
191562	342	191664	414	191738	331	191860	528
191563	328	191666	493	191739	331	191861	528
191564	328	191667	493	191740	331	191862	528
191570	413	191668	493	191743	467	191863	528
191571	413	191669	493	191744	466	191864	528
191572	413	191672	415	191745	467	191865	528

## ACCESSORIES

O. E. M. names and numbers are used for reference purposes only.

HC-CARGO	Page	HC-CARGO	Page	HC-CARGO	Page	HC-CARGO	Page
191866	528	191969	333	192081	359	192166	360
191868	567	191970	415	192082	359	192167	361
191869	568	191971	415	192083	359	192171	362
191870	330	191972	416	192084	359	192172	362
191871	330	191973	415	192085	360	192173	362
191872	330	191974	415	192086	360	192174	323
191873	562	191975	415	192087	360	192175	325
191881	500	191976	416	192088	360	192176	325
191882	500	191977	416	192089	323	192177	335
191883	500	191978	416	192090	324	192178	335
191884	332	191983	333	192091	335	192179	335
191885	332	191984	491	192093	505	192180	329
191886	332	191985	328	192096	505	192181	329
191887	332	191987	560	192099	505	192190	513
191888	332	191988	559	192102	505	192191	513
191889	332	191989	374	192103	507	192192	513
191890	332	191990	374	192104	506	192196	510
191891	332	191992	493	192105	416	192197	510
191898	563	191994	493	192106	416	192204	512
191899	562	191996	493	192107	416	192205	512
191900	560	191997	493	192108	416	192206	508
191901	567	191998	493	192109	416	192207	508
191903	569	192002	339	192110	495	192208	508
191913	569	192003	331	192111	495	192209	509
191914	532	192004	331	192112	495	192210	509
191915	328	192005	331	192114	559	192211	509
191916	327	192006	559	192122	558	192212	509
191923	505	192007	332	192123	558	192213	510
191924	505	192008	332	192124	567	192214	510
191927	506	192009	497	192127	563	192215	510
191928	506	192010	497	192128	568	192216	561
191930	502	192013	495	192132	424	192217	323
191936	502	192014	495	192133	427	192218	491
191937	338	192015	495	192134	332	192222	333
191938	326	192036	320	192135	332	192224	333
191939	495	192041	495	192136	424	192225	333
191941	496	192046	561	192137	424	192226	320
191943	495	192047	333	192138	499	192227	505
191944	497	192048	570	192139	499	192228	564
191945	497	192049	414	192140	325	192229	415
191946	497	192050	414	192142	321	192230	415
191947	497	192051	414	192143	564	192231	415
191948	497	192052	414	192145	561	192234	376
191949	497	192053	415	192146	360	192236	327
191950	494	192054	518	192147	361	192237	327
191951	494	192055	425	192148	362	192239	324
191952	494	192057	420	192149	361	192240	323
191953	494	192058	420	192150	363	192242	333
191954	494	192062	567	192151	363	192245	567
191955	494	192063	559	192152	363	192248	560
191956	494	192065	561	192153	363	192249	560
191957	494	192068	495	192154	363	192250	560
191958	494	192071	560	192155	325	192251	560
191959	494	192072	564	192156	324	192252	560
191960	496	192073	563	192157	324	192253	560
191962	333	192074	377	192158	463	192254	561
191963	333	192075	376	192159	463	192255	559
191964	333	192076	376	192160	463	192259	503
191965	333	192077	357	192161	463	192260	503
191966	333	192078	357	192163	372	192261	503
191967	333	192079	358	192164	372	192262	503
191968	333	192080	358	192165	414	192263	503

HC-CARGO	Page	HC-CARGO	Page	HC-CARGO	Page	HC-CARGO	Page
192264	503	192332	417	192419	427	192495	495
192265	503	192333	417	192420	428	192496	495
192267	503	192334	417	192421	425	192497	495
192269	503	192335	417	192422	425	192498	495
192270	503	192336	417	192423	425	192501	343
192271	503	192337	417	192424	427	192502	361
192272	503	192338	416	192425	560	192503	323
192273	503	192344	426	192427	414	192505	328
192274	503	192345	426	192428	414	192506	328
192275	502	192347	561	192429	414	192507	533
192276	502	192348	568	192430	414	192508	559
192277	502	192352	321	192431	414	192513	500
192278	502	192353	321	192432	414	192515	562
192279	502	192354	321	192433	414	192524	532
192280	502	192355	497	192434	414	192528	323
192282	502	192356	498	192435	414	192529	324
192283	502	192357	498	192436	425	192536	561
192284	502	192358	498	192440	563	192538	417
192286	502	192359	498	192441	563	192539	417
192287	502	192360	498	192442	338	192540	417
192288	502	192361	515	192443	325	192541	417
192289	503	192362	566	192444	561	192542	417
192291	507	192363	567	192445	507	192543	417
192292	507	192364	562	192446	507	192544	417
192293	511	192365	560	192449	320	192545	417
192294	511	192366	519	192450	347	192546	417
192295	509	192368	370	192451	348	192547	417
192296	509	192369	370	192452	348	192548	418
192298	416	192371	321	192453	348	192549	418
192299	416	192373	324	192457	343	192550	561
192300	416	192374	325	192458	343	192552	330
192301	416	192375	335	192459	344	192554	559
192302	416	192376	326	192460	344	192555	507
192303	416	192377	325	192461	345	192557	332
192304	416	192379	520	192462	345	192559	512
192305	417	192380	324	192463	346	192560	513
192306	417	192381	326	192464	346	192563	560
192307	417	192383	327	192465	347	192564	560
192308	417	192384	510	192466	347	192565	560
192309	417	192385	510	192467	343	192567	560
192310	417	192386	511	192468	344	192568	560
192311	417	192387	511	192469	344	192569	562
192312	417	192388	511	192470	344	192571	562
192313	417	192389	511	192471	345	192573	325
192314	417	192390	511	192472	345	192574	325
192315	417	192391	512	192473	346	192575	327
192316	417	192398	512	192474	346	192576	333
192317	417	192399	512	192475	347	192578	569, 538
192318	417	192400	370	192476	347	192582	514
192319	417	192401	370	192477	328	192583	514
192320	417	192402	371	192478	328	192585	567
192321	417	192403	371	192479	498	192586	561
192322	417	192404	560	192480	498	192587	335
192323	417	192405	563	192481	498	192588	559
192324	417	192407	560	192482	499	192591	563
192325	417	192410	323	192483	499	192592	563
192326	417	192411	324	192484	420	192594	563
192327	417	192413	561	192486	327	192595	348
192328	417	192414	563	192488	343	192596	348
192329	417	192416	560	192489	496	192597	349
192330	417	192417	564	192493	372	192598	349
192331	417	192418	559	192494	495	192599	350

## ACCESSORIES

O. E. M. names and numbers are used for reference purposes only.

HC-CARGO	Page	HC-CARGO	Page	HC-CARGO	Page	HC-CARGO	Page
192600	350	192704	561	192820	506	192959	431
192601	351	192705	416	192821	567	192960	431
192602	351	192707	533	192822	561	192961	431
192603	352	192720	516	192825	320	192962	431
192604	352	192721	413	192828	337	192963	431
192605	353	192722	514	192829	337	192964	432
192606	353	192723	514	192830	337	192965	432
192607	349	192724	514	192831	337	192975	332
192608	349	192725	563	192832	337	192976	414
192609	349	192727	563	192833	337	192977	415
192610	350	192752	560	192844	509	192978	415
192611	350	192753	559	192859	336	192979	415
192612	350	192754	562	192864	426	192980	415
192613	351	192755	519	192871	366	192981	416
192614	351	192758	330	192881	507	192982	416
192615	352	192759	424	192882	507	192983	496
192616	352	192760	415	192884	361	192984	562
192617	353	192762	413	192888	375	192985	496
192618	353	192763	413	192889	375	192986	325
192619	328	192764	413	192890	375	192987	355
192620	328	192765	413	192891	376	192988	528
192621	329	192766	413	192902	361	192997	496
192622	329	192767	413	192903	512	192998	325
192631	423	192768	413	192904	512	193000	373
192632	423	192769	413	192905	332	193001	373
192633	423	192770	413	192906	332	193002	409
192634	423	192771	413	192907	332	193003	500
192635	423	192772	325	192908	332	193004	500
192636	423	192778	560	192909	332	193005	500
192637	423	192779	416	192910	332	193006	500
192638	427	192780	416	192911	332	193007	500
192639	427	192781	416	192912	332	193008	500
192645	323	192782	416	192913	332	193009	500
192646	324	192783	416	192914	332	193010	343
192647	336	192784	416	192915	332	193011	370, 493
192648	368	192786	324	192916	332	193012	504
192651	356	192787	357	192917	332	193013	504
192652	356	192788	353	192918	332	193014	504
192655	357	192789	506	192919	332	193015	504
192656	357	192790	563	192920	332	193016	425
192658	515	192791	414	192921	332	193017	354
192659	513	192792	414	192922	332	193018	354
192660	513	192793	414	192923	332	193019	355
192663	567	192794	424	192924	332	193020	355
192667	566	192795	320	192925	332	193021	354
192672	563	192798	415	192926	332	193022	354
192676	561	192799	415	192927	332	193023	355
192678	568	192800	415	192928	332	193024	355
192679	568	192801	415	192929	322	193025	566
192681	375	192802	415	192930	322	193027	518
192682	375	192803	415	192931	322	193028	518
192683	357	192804	415	192932	332	193029	518
192685	421	192805	415	192933	332	193030	518
192686	421	192808	336	192936	431	193031	518
192687	425	192809	336	192937	431	193032	518
192694	568	192810	336	192938	431	193033	518
192695	566	192811	336	192939	431	193034	518
192696	566	192812	336	192940	431	193035	518
192700	513	192813	336	192941	431	193036	518
192701	514	192814	533	192950	321	193037	518
192702	514	192817	519	192951	507	193038	518
192703	514	192818	519	192952	426	193039	518

HC-CARGO	Page	HC-CARGO	Page	HC-CARGO	Page	HC-CARGO	Page
193040	518	193102	348	193164	496	193226	519
193041	518	193103	349	193165	497	193227	519
193042	356	193104	349	193166	375	193230	519
193043	356	193105	350	193167	375	193231	519
193044	356	193106	350	193168	332	193232	519
193045	356	193107	351	193169	500	193233	329
193046	494	193108	351	193170	500	193234	329
193047	504	193109	351	193171	500	193235	329
193048	504	193110	352	193172	500	193236	329
193049	504	193111	352	193173	500	193237	323
193050	504	193112	352	193174	500	193238	325
193051	504	193113	353	193175	500	193239	514
193052	504	193114	353	193176	500	193240	514
193053	504	193115	354	193177	500	193241	362
193054	504	193116	354	193178	500	193242	323
193055	504	193117	355	193179	500	193243	323
193056	504	193118	355	193180	500	193244	322
193057	504	193119	77, 362	193181	500	193245	322
193058	504	193120	330	193182	500	193246	322
193059	504	193121	497	193183	500	193247	322
193060	504	193122	497	193184	500	193248	322
193061	504	193123	497	193185	500	193250	327
193062	504	193124	497	193186	500	193251	503
193063	504	193125	497	193187	500	193252	503
193064	504	193126	497	193188	500	193253	502
193065	504	193127	497	193189	500	193254	503
193066	504	193128	496	193190	500	193255	503
193067	504	193129	496	193191	501	193256	494
193068	504	193130	497	193192	501	193257	494
193069	504	193131	496	193193	501	193258	494
193070	504	193132	497	193194	501	193259	494
193071	504	193133	497	193195	501	193260	494
193072	504	193134	497	193196	501	193261	494
193073	504	193135	497	193197	501	193262	494
193074	504	193136	497	193198	501	193263*	570
193075	504	193137	497	193199	501	193264	332
193076	504	193138	497	193200	501	193265	428
193077	504	193139	497	193201	501	193266	358
193078	504	193140	497	193202	501	193267	358
193079	504	193141	497	193203	501	193268	358
193080	505	193142	497	193204	501	193269	358
193081	505	193143	497	193205	501	193270	359
193082	505	193144	497	193206	501	193271	359
193083	505	193145	497	193207	501	193272	358
193084	505	193146	497	193208	501	193273*	414
193085	505	193147	497	193209	501	193274*	414
193086	505	193148	497	193210	501	193275*	414
193087	505	193149	497	193211	501	193276*	414
193088	505	193150	497	193212	497	193277*	414
193089	505	193151	497	193213	413	193278*	414
193090	505	193152	496	193214	413	193279*	414
193091	344	193153	496	193215	413	193280*	414
193092	344	193154	497	193216	413	193281*	414
193093	345	193155	497	193217	413	193282*	414
193094	345	193156	497	193218	413	193283*	414
193095	345	193157	497	193219	413	193284*	414
193096	346	193158	497	193220	519	193285*	414
193097	346	193159	497	193221	519	193286*	414
193098	346	193160	497	193222	519	193287*	414
193099	347	193161	497	193223	519	193288*	414
193100	347	193162	497	193224	519	193289*	414
193101	348	193163	497	193225	519	193290*	414

HC-CARGO	Page	HC-CARGO	Page	HC-CARGO	Page	HC-CARGO	Page
193291*	414	200181	147	200745	522	210054	549
193292*	414	200300	520	200746	521	210121	333
193293*	414	200400	521	200747	522	210134	549
193294*	414	200500	521	200748	521	210140	534
193295*	414	200526	537	200749	522	210141	533
193296*	414	200527	537	200765	526	210142	533
193297*	414	200601	523	200766	527	210143	533
193298*	414	200603	537	200768	527	210144	533
193299*	414	200618	522	200769	527	210145	533
193300*	414	200624	538	200771	527	210146	533
193301*	414	200633	570	200772	525	210147	533
193302*	415	200635	147	200773	525	210148	533
193303*	415	200640	537	200774	525	210149	533
193304*	415	200655	537	200775	525	210150	533
193305*	415	200659	148	200776	524	210151	533
193306*	415	200663	570	200777	524	210152	533
193307*	415	200664	571	200778	525	210153	533
193308*	415	200665	571	200779	525	210154	533
193309*	414	200666	571	200787	537	210155	533
193310*	414	200667	571	200790	534	210156	533
193311*	414	200668	571	200791	524	210157	533
193312*	414	200669	571	200792	524	210158	533
193313*	414	200670	572	200796	523	210159	533
193314*	414	200671	572	200802	526	210160	533
193316*	414	200672	572	200805	537	210164	533
193317*	414	200673	572	200808	524	210212	554
193318*	414	200676	572	200810	521	210249	539
193319*	413	200684	148	200813	526	210567	546
193320*	413	200685	537	200828	524	210574	572
193321*	413	200686	537	200831	537	210638	333
193322*	413	200687	538	200832	537	210639	334
193323*	413	200688	538	200833	537	210643	363
193324*	413	200693	572	200834	537	210644	502
193325*	413	200697	520	200837	148	210645	502
193326*	414	200698	539	200838	534	210649	553
193327*	414	200699	539	200846	526	210661	363
193328*	414	200700	539	200848	525	210667	364
193329*	414	200701	539	200850	534	210675	364
193330*	414	200702	539	200851	527	210686	545
193331*	414	200703	539	200852	527	210689	334
193332*	414	200704	539	200853	527	210696	334
193333*	414	200706	539	200854	526	210699	551
193334*	414	200707	539	200858	526	210702	418
193335*	414	200708	539	200869	537	210708	557
193336*	413	200709	539	200875	570	210709	557
193337*	413	200710	539	200876	570	210710	557
193338*	413	200711	539	200877	571	210712	557
193339*	413	200712	539	200884	537	210713	557
193340*	413	200713	539	200885	537	210715	557
193341*	413	200721	521	200886	537	210716	557
193342*	413	200722	521	200887	537	210718	557
193343*	413	200723	521	200889	537	210720	557
193344*	413	200724	521	200890	537	210722	557
193345*	413	200728	147	200891	537	210723	557
200004	520	200733	148	200892	537	210724	557
200005	520	200734	521	200893	537	210725	557
200094	520	200735	523	200897	537	210726	557
200127	538	200738	523	200898	526	210727	557
200140	537	200739	523	210050	539	210729	558
200141	537	200740	523	210051	539	210740	557
200142	537	200741	523	210052	548	210741	558
200144	538	200742	524	210053	549	210742	558



HC-CARGO	Page	HC-CARGO	Page	HC-CARGO	Page	HC-CARGO	Page
210743	558	210911	536	211126	552	804088	581
210744	557	210912	536	211127	366	804089	582
210745	558	210918	364	211128	552	804090	582
210747	558	210919	364	211129	541	804091	582
210748	558	210921	364	211130	541	804092	582
210750	557	210937	334	211131	541	804093	583
210751	557	210938	334	211132	541	804094	583
210752	558	210939	334	211133	541	804095	583
210753	558	210948	540	211134	541	804096	583
210754	558	210973	365	211135	542	804097	584
210755	558	210977	551	211136	542	804098	584
210757	558	210980	552	211137	542	804099	584
210758	549	210995	546	211138	542	804100	584
210759	557	210996	546	211139	542	804101	585
210760	334	211013	552	211140	542	804102	585
210762	551	211014	552	211141	542	804103	585
210763	544	211017	365	211142	543	804106	585
210771	549	211018	365	211143	543	804107	586
210777	544	211027	556	211144	543	804110	586
210778	544	211028	556	211145	543	804113	586
210779	545	211030	364	211146	543	804117	586
210780	545	211035	553	211147	543	806011	318
210781	545	211036	553	211148	543	806015	318
210782	545	211040	554	211149	544	806020	318
210786	545	211041	554	211150	544	806030	318
210789	539	211042	555	211151	544	807002	587
210790	539	211045	553	211152	544	808014	588
210791	539	211048	540	211153	555	808015	588
210793	539	211049	540	230858	533	809002	172
210813	539	211051	365	253488	538	809003	172
210818	539	211052	365	253489	146	809004	173
210822	539	211053	365	804008	574	809005	172
210827	501	211058	550	804012	574	809009	172
210828	501	211059	550	804013	574	811001	588
210841	418	211065	551	804014	574	811004	588
210842	418	211073	554	804015	575	4440X	63
210843	540	211077	554	804017	575	AS301	237
210845	553	211081	541	804020	575	B090079	516
210846	553	211083	555	804021	575	B090080	516
210849	502	211090	535	804022	576	B090081	516
210851	364	211091	556	804024	576	B090083	516
210853	557	211092	536	804036	576	B090084	516
210859	557	211094	555	804037	576	B090119	516
210860	557	211096	501	804040	577	B090148	516
210867	546	211097	555	804041	577	B190680	508
210868	545	211101	551	804048	577	B190681	508
210869	549	211102	551	804049	577	B190682	508
210871	550	211103	554	804050	578	B190683	508
210872	550	211106	535	804054	578	B190684	508
210873	540	211107	536	804055	578	B191132	508
210877	540	211108	536	804065	578	B191306	564
210878	552	211109	537	804068	579	B191307	564
210897	534	211110	537	804069	579	B191308	564
210898	535	211113	550	804070	579	B191325	560
210899	535	211114	550	804073	579	B191326	560
210901	535	211117	556	804075	580	B191327	560
210902	536	211118	556	804076	580	B191328	560
210903	536	211119	555	804077	580	B191329	560
210904	536	211120	365	804078	580	B191330	560
210905	558	211122	555	804081	581	B191380	499
210909	540	211123	473, 556	804085	581	B191382	499
210910	535	211124	554	804086	581	B191383	499

## ACCESSORIES

O. E. M. names and numbers are used for reference purposes only.

HC-CARGO	Page	HC-CARGO	Page	HC-CARGO	Page	HC-CARGO	Page
B191384	499						
B191385	499						
B191386	499						
B191387	499						
B191446	507						
B191447	507						
B191448	507						
B191449	507						
B191450	507						
B191451	507						
B191452	507						
B191453	507						
B191478	562						
B191494	499						
B191513	564						
B191514	560						
B191523	507						
B191525	508						
B191526	508						
B191533	561						
B191574	507						
B191582	562						
B191643	561						
B191651	560						
B191792	560						
B191867	560						
B191944	497						
B191945	497						
B191946	497						
B191947	497						
B191948	497						
B191949	497						
B192009	497						
B192010	497						
B192093	505						
B192291	507						
B192292	507						
B192446	507						
B192519	560						
B192569	561						
B192572	562						
B192881	507						
B230731	562						
H4360	63						
H5360	63						
RT1000	237						
RT1003	237						
RT1005	237						
RT2002	237						
RT2006	237						
RT2016	237						

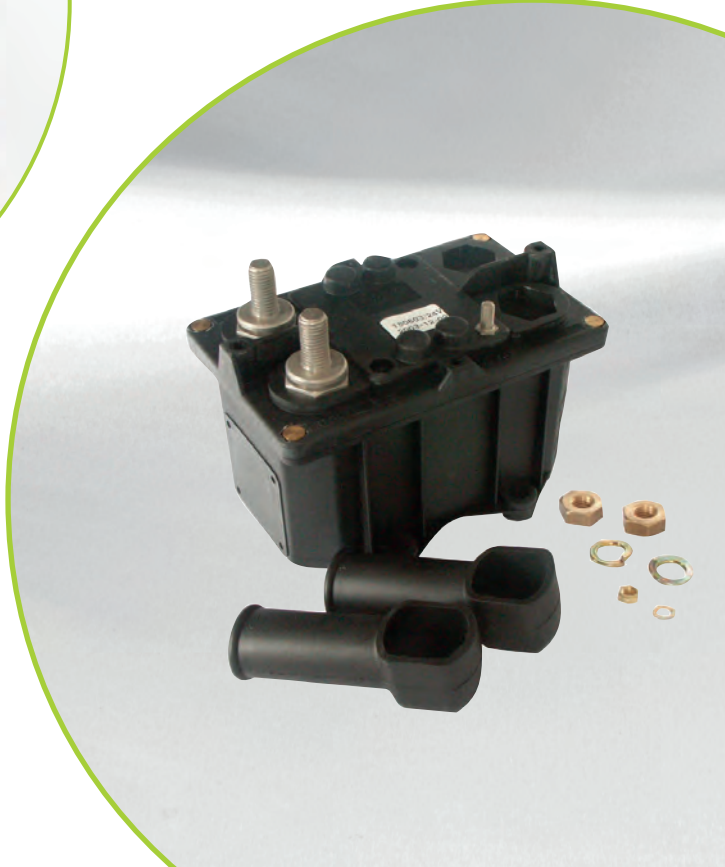

HC-CARGO is represented worldwide.  
Please find more on [www.hc-cargo.com](http://www.hc-cargo.com)  
or call +45 76 14 33 00

**DENMARK**

Tel. 76 14 33 22 · Fax 76 14 32 30  
[sales.dk@hc-cargo.com](mailto:sales.dk@hc-cargo.com)

**GERMANY**

Tel. 02739 403040 · Fax 02739 4030420  
[cargo@cargo-de.com](mailto:cargo@cargo-de.com)

**AUSTRIA**

Tel. 0810 202105 · Fax 0810 202106  
[cargo@cargo-de.com](mailto:cargo@cargo-de.com)

**UNITED KINGDOM**

Tel. 0115 928 0086 · Fax 0115 928 0033  
[cargo@cargo-uk.com](mailto:cargo@cargo-uk.com)

**BENELUX**

**NETHERLANDS** Tel. 076 5019700  
**BELGIUM** Tel. 03-6053128  
Fax 0031 (0) 76 5019007  
[cargo@cargo-nl.com](mailto:cargo@cargo-nl.com)

**SWEDEN**

Tel. 019-27 88 00 · Fax 019 -27 88 70  
[cargo@cargo-se.com](mailto:cargo@cargo-se.com)

**IBERIA**

Tel. +34 91 327 9324  
[cargo@hc-cargo.es](mailto:cargo@hc-cargo.es)

**FRANCE**

Tel. 02 38 49 66 66 · Fax 02 38 49 66 67  
[cargo@cargo-fr.com](mailto:cargo@cargo-fr.com)

**ITALY**

Tel. 051 499 8989 · Fax 051 499 8990  
[cargo@hccargo-it.com](mailto:cargo@hccargo-it.com)

**POLAND**

Tel. 61 8400940  
[cargo@cargo-pl.com](mailto:cargo@cargo-pl.com)

**All Other Countries**

Tel. + 45 76 14 33 00 · Fax + 45 76 14 33 33  
[hc-cargo@hc-cargo.com](mailto:hc-cargo@hc-cargo.com)

Your HC-CARGO contact:

For your nearest HC-CARGO dealer  
and full program overview visit  
[www.hc-cargo.com](http://www.hc-cargo.com)



Your Expert in Parts

