

Indice dei particolari sciolti

Index of spare parts

Классификация запасных частей



Paraoli

Seals
Сальники



guida introduttiva alla codifica

directory overview краткое описание и классификация

pag. 20-21/42



in ordine di codice

sorted by code сортировка по коду

pag. 22-48/42



in ordine di Øint.

sorted by int.Ø сортировка по размеру

pag. 49-75/42



in ordine di disegno

sorted by drawing сортировка по типу

pag. 76-104/42



Paraoli per scatole guida meccaniche

Seals for mechanic steering boxes
Сальники для рулевых агрегатов без гидроусилителя

pag. 105/42



O-ring a sezione tonda

O-rings (round section)
Резиновые кольца круглого сечения



in ordine di codice

sorted by code сортировка по коду

pag. 106-110/42



in ordine di Øint.

sorted by int.Ø сортировка по размеру

pag. 111-115/42



O-ring a sezione quadra e quadring

O-rings (square section) and X-Rings
Резиновые кольца квадратного и X-образного сечения



pag. 116-117/42



Sfere in acciaio

Steel balls
Стальные шары



pag. 118-121/42



Tappi e cappucci

Taps and caps

Пробки и заглушки



11093

Tappi non filettati

Unthreaded plugs

Полупрозрачные заглушки без резьбы

pag. **122**/42



11335

Tappi speciali filettati economy

Special economy threaded plugs

Специальные экономные резьбовые заглушки

pag. **122**/42



11334

Tappi filettati a tenuta speciale e super special

Threaded plugs with special and super special tightness

Особогерметичные резьбовые заглушки

pag. **122-123**/42



11336

Cappucci di protezione per pignone e tirante

Pinion and tie rods protection caps

Удлиненные полупрозрачные заглушки без резьбы

pag. **123**/42



11558

Cappucci di protezione a fungo

Mushroom-shaped protection caps

Грибообразные колпачки

pag. **124**/42



11678

Sottotappi in gomma

Underplugs in rubber

Заглушки из резины

pag. **124**/42



11339

Tappi per kit cambio

Plugs for gear kits

Заглушки для рулевых редукторов

pag. **124**/42



11338

Piatti di supporto

Support plates

Опорные пластины

pag. **124**/42



Cuscinetti, ghiera di blocco e molle di torsione

Bearings, threaded rings and torsion springs

Подшипники и стопорные кольца распределителей



11397

Cuscinetti a rullini

Needle roller bearings

Игольчатые подшипники

pag. 125/42



11398

Cuscinetti a sfere

Radial ball bearings

Шариковые подшипники

pag. 126/42



11399

Cuscinetti a tenuta assiale

Axial bearings

Конические упорно-радиальные подшипники

pag. 126/42



Ghiera di blocco fermo cuscinetto

Stopping threaded rings for bearings

Фиксатор гайки подшипника

pag. 127/42



11097

Cuscinetti generici per idroguida e pompe

Generic bearings for power steering and pumps

Подшипники для агрегатов рулевого управления с гидроусилителем и насосов

pag. 127/42



11098

Molle di torsione pignone in acciaio speciale

Pignion torsion springs in special steel

Специальные стопорные кольца распределителей

pag. 127/42



Camicie di modifica per distributori

Liners to modify distributors without drilling

Гильзы для распределительной части корпуса рулевой рейки



11332

pag. 128/42



Fascette

Rings

Хомуты



11323

Fascette con aggancio rapido in P.A. (dis.1)

Quick fastening rings in P.A.

Многоразовые хомуты

pag. 128/42

Indice dei particolari sciolti

Index of spare parts

Классификация запасных частей

B



11324

Fascette con aggancio rapido in acciaio inox (dis.2)

Quick fastening rings in stainless steel
Металлические хомуты одноразового использования

pag. 129/42

B



11327

Fascette a molla in acciaio (dis.3)

Spring rings in steel
Металлические хомуты с пружинящей фиксацией

pag. 129/42

B



11328

Fascette con bloccaggio a vite in acciaio inox (dis.4)

Screw fastening ring in stainless steel
Металлические хомуты с винтовым зажимом

pag. 130/42

B



11104

Fascette in P.A. (dis.5)

Rings in P.A.
Одноразовые пластиковые хомуты

pag. 130/42

B



11105

Fascette in metallo (dis.6)

Metallic rings
Металлические хомуты одноразового использования

pag. 130/42

P

Guarnizioni per tenuta corpi idro, scatole meccaniche e pompe

Gaskets for power steering bodies, mechanic steering boxes and pumps
Уплотнения для агрегатов рулевого управления с гидроусилителем, редукторов без гидроусилителя и насосов

pag. 131-136/42

U

Rondelle, bulloni, dadi, viti

Shims, bolts, nuts, screws
Шайбы, болты, гайки, винты

U



11107

Rondelle di tenuta

Keeping shims
Шайбы

pag. 137/42

U



11347

Viti con inserti in P.A.

Screws with inserts in P.A.
Винты с уплотнениями

pag. 137/42

U



11331

Uscite olio

Oil exits
Сливные пробки

pag. 138/42

Indice dei particolari sciolti

Index of spare parts

Классификация запасных частей

U



11108

Rondelle USIT

USIT shims
Шайбы с резиновой вставкой

pag. 138/42

U



11679

Rondelle USIT con interno rinforzato

USIT shims with strenghtened interior
Шайбы с внутренним усилением

pag. 138/42

U



11419

Bulloni e dadi per pompe

Lock bolts and nuts
Фиксирующие болты и гайки

pag. 139/42

U



11641

Niples

Niples
Переходники

pag. 139/42

M

Segmenti in P.T.F.E.

P.T.F.E. piston rings
Тефлоновые кольца



11343



11342



11344



in ordine di codice

sorted by code сортировка по коду

pag. 140-145/42



in ordine di Øint.

sorted by int.Ø сортировка по размеру

pag. 146-151/42



in ordine di disegno

sorted by drawing сортировка по типу

pag. 152-158/42

N

Seger

Segers
Стопорные кольца

N



11196

Seger dis. 1

Стопорное кольцо, тип 1

pag. 158/42

N



11600

Seger dis. 2

Стопорное кольцо, тип 2

pag. 158/42

N



11601

Seger dis. 3

Стопорное кольцо, тип 3

pag. 159/42

Indice dei particolari sciolti

Index of spare parts

Классификация запасных частей

N



11602

Seger dis. 4

Стопорное кольцо, тип 4

pag. 159/42

N



11603

Seger dis. 5

Стопорное кольцо, тип 5

pag. 160/42

N

Seger dis. 6

Стопорное кольцо, тип 6

pag. 160/42



Boccole di scorrimento per idroguida

Creep bushings for power steering

Уплотнительные втулки для агрегатов рулевого управления

L

Plastica per produzione di boccole su misura

Special plastic to develop custom bushing

Специальный пластик для изготовления втулок

pag. 161/42

L



11187

Boccole porta-paraolio (dis.1)

Seal-keeping bushings

Опорные втулки

pag. 161/42

L



11188

Boccole-Rondelle (dis.2)

Bushings-Washers

Втулки-шайбы

pag. 162/42

L



11189

Boccole e pistoni spingi-asta a mezzaluna (dis.3)

Rod-pulling bushings and pistons

Фолье-вставки бокового поджима

pag. 163-164/42

L



11190

Boccole-Bronzine (dis.4)

Rod bushings

Бронзовые втулки

pag. 164/42

L



11191

Boccole classiche (dis.5)

Classic bushings

Классические уплотнительные втулки

pag. 164-165/42

L



11599

Boccole-Pattini spingi-asta (dis.8)

Rod-pushing skates

Фолье-вставки к рулевым рейкам, имеющим угловой поджим штока

pag. 166/42

Indice dei particolari sciolti

Index of spare parts

Классификация запасных частей



Boccole di scorrimento per scatole guida meccaniche

Creep bushings for mechanic steering boxes

Втулки скольжения к агрегатам рулевого управления без гидроусилителя



Boccole per cremagliere (dis.6)

Rack bushings
Распорные втулки

pag. 166-167/42



Boccole con o-ring (dis.7)

Bushings with o-rings
Втулки, уплотняющиеся резиновыми кольцами

pag. 167/42



Altre boccole

Other bushings
Втулки иного типа

pag. 168/42



Silentblock

Silentblocks
Сайлентблоки



pag. 169/42



Braccetti e tiranti

Arms and ropes
Рулевые тяги



pag. 169/42



Pistoni completi e molle a tazza

Complete pistons and tray springs

Комплекты поршней и пружинящих колец



Pistoni completi

Complete pistons
Комплекты поршней

pag. 170/42



Molle a tazza

Tray springs
Пружинящие кольца

pag. 170/42

Indice dei particolari sciolti

Index of spare parts

Классификация запасных частей



Tamponi

Plugs

Защитные уплотнения



11390

pag. 171/42



Alberi stelo pistone e cremagliere

Rods for piston and racks

Штоки гидроцилиндров и рулевых реек



11195

Alberi stelo pistone

Rods for piston

Штоки гидроцилиндров

pag. 171/42



11253

Cremagliere

Racks

Штоки рулевых реек

pag. 172/42



Tappi distributore

Caps for rotary valve

Гайки боковых поджимов



11285

pag. 173/42



Filtri

Filters

Фильтры

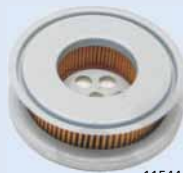

11544



11545

pag. 173/42



Componenti per pompe meccaniche

Components for mechanic steering pumps

Компоненты для механических насосов гидроусилителя



Kit parti interne pompa

Internal component kits for pump

Комплект внутренних частей насоса

pag. 174/42

Indice dei particolari sciolti

Index of spare parts

Классификация запасных частей

T



11114

Alberi steli

Piston rods
Валы насосов гидросилителя

pag. 174/42

T



11115

Bronzine

Bushes for pumps
Втулки скольжения насосов гидросилителя

pag. 174/42

T



11415

Piatti di spinta e di pressione

Thrust and pressure plates
Уплотнительные пластины рабочей части насоса

pag. 175-177/42

T



11118

Regolatori di flusso

Flux limiters
Штуцеры с калиброванным отверстием

pag. 177/42

T



11119

Rotori pompa pistone e camicia

Piston rotor and liner
Роторы, рабочие камеры и пластины насосов гидросилителя

pag. 178-179/42

T



11120

Valvole per pompa

Pump valves
Клапаны насосов гидросилителя

pag. 179/42

T



11389

Vaschette porta-olio in plastica

Plastic oil tanks
Пластиковые бачки

pag. 180/42

T



11400

Pulegge per pompa e supporti

Pump pulleys and supports
Приводные шкивы и ступицы насосов гидросилителя

pag. 181/42

T



11665

Fondelli motore elettrico

Bottom plates for electric engine
Опорные пластины электродвигателей насосов гидросилителя с электроприводом

pag. 181/42



Componenti per pompe elettriche

Components for electric steering pumps

Компоненты для насосов гидроусилителя с электроприводом



11123

Piastre principali e schede elettroniche

Main plates and electronic devices

Щеточные узлы

pag. 182/42



11125

Spazzole

Brushes

Щетки

pag. 183/42



11126

Molle spingi-spazzola

Brush-pushing springs

Пружины для щеток

pag. 183/42



11127

Cavetti connettori per piastra

Connectors for electric plate

Разъемы для щеточного узла

pag. 183/42



11128

Giunti

Electric pump joints

Электрические соединения насосов гидроусилителя с электроприводом

pag. 184/42



11666

Motori per pompe elettriche

Electric pump engines

Электродвигатели насосов гидроусилителя с электроприводом

pag. 184/42



11618

Indotti per pompe elettriche

Rotors for electric pumps

Роторы для насосов гидроусилителя с электроприводом

pag. 185/42



11848

Coperchi per motori guide elettriche

Covers for EPS engines

Защитные крышки

pag. 185/42



Pompe elettriche complete (estratto dall'elenco dei kit)

Complete electric pumps (taken from complete kit list)

Насосы гидроусилителя с электроприводом и комплектующие к ним

pag. 186-191/42



Componenti per scatole guida elettriche

Electric steering box components

Компоненты к агрегатам рулевого управления с электроприводом



Introduzione alla tecnologia

Directory introduction
Введение в технологию

pag. 192/42



Relè sostitutivi per guide elettriche

Spare relays for electric steering boxes
Реле для агрегатов рулевого управления с электроприводом

pag. 192/42



Guaine e spinotti

Sheaths and plugs
Разъемы

pag. 193/42



Sensori di coppia con cavo

Torque sensors with cable
Датчики крутящего момента с кабелем

pag. 193/42



Sensori di coppia con banda piatta e fili crimpati

Torque sensors with flat belt and crimped cables
Датчики крутящего момента со шлейфом

pag. 194/42



Motori per guide elettriche

EPS engines
Электродвигатели для агрегатов рулевого управления с электроприводом

pag. 194/42



Accessori per guide elettriche

EPS accessories
Иные компоненты для агрегатов рулевого управления с электроприводом

pag. 195/42

Indice dei kit idroguida

Index of kits for power steering

Ремонтные комплекты для рулевого управления

10X ALFA-ROMEO pag. **197-198**/42

11X AUDI-VOLKSWAGEN SKODA pag. **198-203**/42

➔ **Scatole guida meccaniche**

Mechanical steering boxes

Механические рулевые редукторы

13X BMW pag. **203-207**/42

61X CHEVROLET (ex Daewoo) pag. **207**/42

19X DAIHATSU pag. **207-208**/42

21X FERRARI pag. **208**/42

22X FIAT e veicoli commerciali pag. **208-212**/42

➔ **Scatole guida meccaniche**

Mechanical steering boxes

Механические рулевые редукторы

23X FORD-MAZDA pag. **212-219**/42

➔ **ASTE**

Rods

Рабочие детали

➔ **Scatole guida meccaniche**

Mechanical steering boxes

Механические рулевые редукторы

59X HOLDEN pag. **220**/42

25X HONDA pag. **220-222**/42

26X HYUNDAI pag. **222-223**/42

27X ISUZU pag. **223**/42

28X JAGUAR pag. **223-224**/42

15X JEEP PONTIAC-CHEVROLET pag. **224-227**/42

12X KIA pag. **227-228**/42

30X LADA pag. **228**/42

32X LANCIA-AUTOBIANCHI pag. **228-230**/42

36X MASERATI pag. **230**/42

38X MERCEDES-BENZ pag. **230-232**/42

39X MITSUBISHI pag. **232-234**/42

41X NISSAN pag. **234-238**/42

42X OPEL-VAUXHALL pag. **238-241**/42

16X PEUGEOT-CITROËN pag. **241-245**/42

➔ **Martinetti idraulici**

Hydraulic jacks

Гидроцилиндры к рулевым рейкам



11132

45X PORSCHE pag. **246**/42

46X RENAULT pag. **246-250**/42

47X ROLLS-ROYCE pag. **250**/42

48X ROVER-LAND ROVER pag. **250-252**/42

49X SAAB pag. **252-253**/42

57X SEAT pag. **253-254**/42

60X SSANGYONG pag. **254**/42

51X SUBARU pag. **254-255**/42

52X SUZUKI pag. **255-256**/42

53X TALBOT pag. **256**/42

54X TATA pag. **256**/42

55X TOYOTA pag. **256-261**/42

58X VOLVO pag. **261-262**/42

80X Trattori pag. **263**/42

Tractors

Тракторы

81X Camion-veicoli pesanti pag. **263-269**/42

Trucks-Heavy vehicles

Грузовые транспортные средства

Classificazione codici kit

Kit indexing rules

Классификация ремкомплектов

01X001 ... 01X599

Kit idroguida

Kit for power steering

Ремкомплект для рулевого управления с гидроусилителем

01X600 ... 01X699

Kit pompa

Pump Kit

Ремкомплект насоса

01X700 ... 01X799

Cuffie

Steering rack boots

Сайлентблоки

01X800 ... 01X899

Pompe nuove

New pumps

Новые насосы

01X900 ... 01X999

Martinetti, Aste, Scatole guida meccaniche

Jacks, Rods, Mechanical steering boxes

Различные

запчасти к механическим рулевым механизмам

Готовый усилитель руля с электроприводом

01XE900 ... 01XE999

Guide elettriche complete

Complete EPS

Note aggiuntive

Additional remarks

Дополнительные примечания

Qualora si desiderino kit composti solamente da paraoli, si aggiunga in fase di ordinazione la lettera "A" al codice kit associato.

If you wish to order kits just with seals, please just add letter "A" to kit code into your order inquiry.

Если вы желаете заказать точный ремкомплект, пожалуйста, отправьте письмо с номером агрегата.

Indice delle attrezzature

Index of tools and overhaul equipment

Инструменты и оборудование для ремонта

Z



11064

Attrezzature usa e getta per montaggio paraoli "SOS Oil Seals"

Universal disposable assembling tools for seals "SOS Oil Seals"

Эластичная одноразовая пленка для монтажа штока рулевой рейки

pag. 270/42

Z



11136

Immettitori paraoli pignone in acciaio inox

Injectors in stainless steel for pinion seals

Металлический защитный наконечник

pag. 270/42

Z



11858

Immettitori paraoli cremagliera in plastica

Injectors in plastic for rack seals

Пластиковые защитные наконечники

pag. 271/42

Z



11133

Attrezzature montaggio paraoli in acciaio inox

Universal assembling tools in stainless steel for seals

Комплект приспособлений для монтажа сальников

pag. 272/42

Z



11058

Maschi d'acciaio super-rapido

Quick steel screw-taps

Режущий инструмент

pag. 273/42

Z

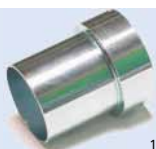

11138

Attrezzature universali montaggio anelli P.T.F.E.

Assembling tools for rings in P.T.F.E.

Приспособление для монтажа тефлоновых колец

pag. 273-274/42

Z



11074

Ganci per pannelli inox

Hooks for panels in stainless steel

Крючки для инструмента

pag. 275/42

Z



11139

Estrattori per paraoli cremagliera

Rack removers for seals

Приспособления для демонтажа внутренних сальников гидроцилиндра рулевой рейки

pag. 276/42

Z



11578

Estrattori per paraoli distributore

Seal removers for pinion

Приспособление для демонтажа внутренних сальников распределителя рулевой рейки

pag. 276/42

Z



11140

Estrattori per pulegge pompa

Remover for pump pulleys

Комплект приспособлений для монтажа и демонтажа приводных шкивов и ступиц насосов усилителя

pag. 277/42

Indice delle attrezzature

Index of tools and overhaul equipment

Инструменты и оборудование для ремонта

Z

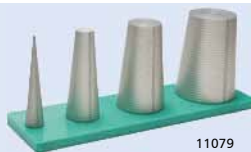

11079

Misuratori conici per o-ring e segmenti in P.T.F.E.

Conical measurers for o-rings and piston rings in P.T.F.E.
Набор мерильных конусов

pag. 278/42

Z



11141

Attrezzature a valigetta per prova pressione

Portable carrying cases for pressure test
Приспособление для диагностики системы гидроусилителя руля на автомобиле

pag. 278/42

Z



11136

Morse pneumatiche universali

Universal pneumatic vices
Универсальные пневматические тиски (пневмозахват)

pag. 279/42

Z



11081

Tavoli inox

Work bench in stainless steel
Рабочий стол механика

pag. 279/42

Z



11142

Chiavi di montaggio e smontaggio

Assembling and disassembling keys
Ключи и приспособления для монтажа и демонтажа

pag. 280/42

Z

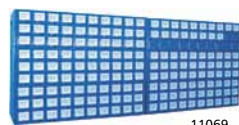

11069

Cassettiere modello "Stand-by"

"Stand-by" storage system
Контейнеры для хранения комплектующих

pag. 281/42

Z



11423

Calamite

Magnets
Магниты

pag. 282/42

Z



11143

Torsiometri

Torquemeters
Измеритель крутящего момента (динамометр)

pag. 282/42

Z



11145

Attrezzature prova di tenute

Equipments for keeping test
Прибор для тестирования рулевых реек при помощи воздуха

pag. 283/42

Z



11144

Attrezzature prova di sforzo

Equipments for effort test
Пнеumoцилиндр со станиной

pag. 284/42

Z



11424

Manicotti per inserimento seger

Assembling tools for segers
Комплект для монтажа стопорных колец

pag. 285/42

Indice delle attrezzature

Index of tools and overhaul equipment

Инструменты и оборудование для ремонта

Z



11065

Kit di attrezzi per la riparazione "Seal Toolkit"

Kit for reparation and overhauling "Seal Toolkit"

Комплект для монтажа и демонтажа резиновых и тефлоновых колец

pag. 286/42

Z



11292

Bordatori per pistoni

Flanging discs for piston mounting

Приспособление для монтажа поршня гидроцилиндра

pag. 287/42

Z



11846

Attrezzature piega-tubi

Tube-folding equipment

Приспособление для изготовления трубок высокого давления

pag. 287/42

Z



11476

Lampade e ricambi

Lamps and spare parts

Фонарик

pag. 288/42

Z



11554

Attrezzature a cannocchiale

Spyglass tool

Оптическое оборудование

pag. 288/42

Z



11651

Attrezzatura a cannocchiale con telecamera

Spyglass tool with camera

Видеозонд с камерой

pag. 289/42

Z



11650

Kit di registrazione e monitoraggio senza fili

Wireless recording and monitoring tool

Беспроводная камера с возможностью видеозаписи

pag. 289/42

Z



11855

Penne elettriche per marcatura su metallo

Electric pens to engrave metals

Электрические ручки для маркировки на металле

pag. 290/42

Z



11784

Strumenti di diagnosi per automezzi

Diagnosis tools for vehicles

Диагностические инструменты для автомобиля

pag. 290/42

Z



11784

Centratori universali per sensori di coppia

Universal centering devices for torque sensors

Приспособление для центрирования датчика положения руля

pag. 291/42

Z



11852

Banchi prova per sterzi elettrici a colonna «Vinci»

Test bench for EPS columns «Vinci»

Диагностические стенды для рулевых колонок с электроприводом

pag. 292/42



Guida al corretto assemblaggio delle pompe elettriche

How to properly assemble electric pumps
Правила сборки насосов гидроусилителя с электроприводом



pag. **293-295**/42



Sistema di smontaggio e montaggio idroguidate con parte dentatura cremagliera più grande della parte cromata

Assembling and disassembling system for power steering units having a greater diameter in the toothed part of the rack than the chromium-plated part
Инструкция монтажа и демонтажа поршней рулевых реек, у которых диаметр зубчатой части штока превышает посадочный диаметр сальника



pag. **295-298**/42



Kit di modifica schede elettroniche Mercedes Classe A

Kit to overhaul electronic device of Mercedes Class A
Комплект для ремонта электронных устройств от Mercedes Class A



pag. **299**/42



Estintori istantanei Fire Antigen

Instant extinguishers Fire Antigen
Мгновенный огнетушитель



pag. **300-301**/42



Condizioni generali di vendita

General terms of sale
Общие условия продажи

pag. **302-306**/42



10952

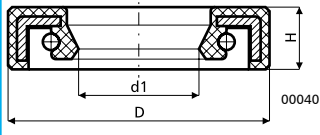

Disegno Drawing **0**



10953

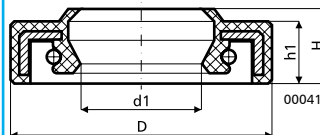

Disegno Drawing **1**



10954

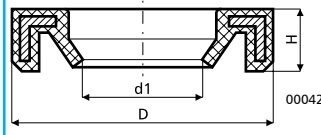

Disegno Drawing **2**



10955

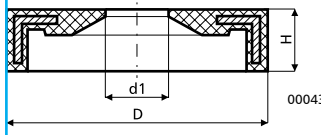

Disegno Drawing **3**



10960

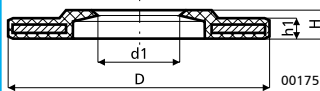

Disegno Drawing **8**



10961

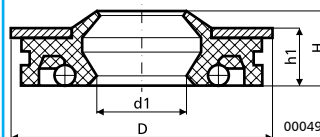

Disegno Drawing **9**



10962

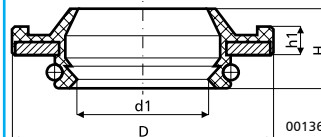

Disegno Drawing **10**



10963

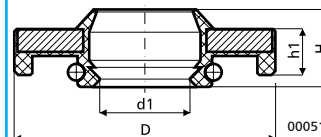

Disegno Drawing **11**

- A** ACCIAIO ESTERNO *External steel*
- G** TUTTO GOMMA *All rubber*
- M** 1 MOLLA INCLUSA *One springs included*
- M2** 2 MOLLE INCLUSE *Two springs included*
- P** PARAPOLVERE *Antidust*

- Металлическая внешняя сторона*
- Полностью резиновый*
- Одна рабочая кромка*
- Две рабочие кромки*
- Защитная кромка*

ITALIANO - Sistema di classificazione ORPAV

Il sistema di classificazione ORPAV consente di identificare rapidamente gli articoli in base ai dati tecnici in proprio possesso. Nelle figure sopra, caratterizzate dalla banda laterale di colore **GIALLO**, è possibile individuare i particolari richiesti in base al loro aspetto esteriore; le foto e i disegni tecnici ne facilitano il riconoscimento. Nella sezione contraddistinta dal colore **AZZURRO** (pagg. 22/48), i paraoli sono disposti in ordine di codice.

Nell'area di colore **ARANCIONE** (pagg. 49/75), i paraoli sono ordinati per Ø interno, molto utile nei casi in cui si conoscono le misure necessarie, ma non i codici articolo associati. Infine, nell'ultima parte con la banda **VERDE** (pagg. 76/104), gli articoli sono raccolti secondo il loro disegno tecnico. Il disegno di ciascun paraolio è corredato dalle abbreviazioni descritte in questa introduzione; esse contribuiscono ad identificare più precisamente l'articolo e le relative caratteristiche tecniche.

Esempio: paraolio disegno 10 con parapolvere e 2 molle

$$10 + P + M2 = 10PM2$$

ENGLISH - ORPAV classification system

ORPAV classification system allows to quickly identify articles starting from any technical information you may have in each context. In the figures above, coloured at page sides with **YELLOW**, it is possible to recognize the requested spare parts directly looking at their shape; photos and technical drawings can help you in this process. In the **BLUE**-coloured section (pages 22/48), seals are sorted by code; therefore, it is recommended to adopt it when you may want to obtain technical data having part numbers. The **ORANGE** area (pages 49/75) has seals ordered by diameters; thus, it is particularly useful when you know physical dimensions, and you need to find related codes. Finally, in the last part with **GREEN** belt (pages 76/104), articles are collected by their technical drawing. Seal drawings also describe some technical specifications, which are different in each article. Such remarks are expressed by special abbreviations, described herein above.

Example: seal drawing 10 with antidust and 2 springs

$$10 + P + M2 = 10PM2$$

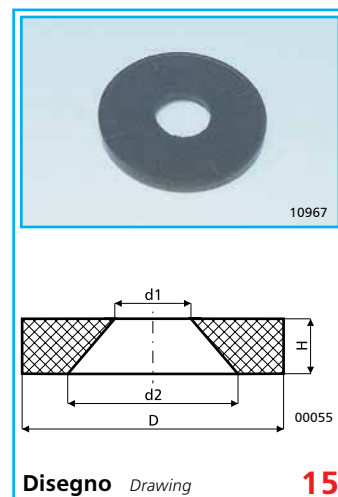
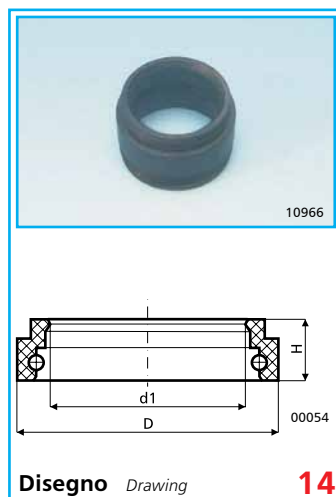
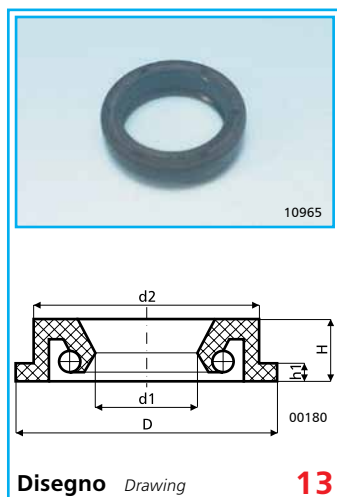
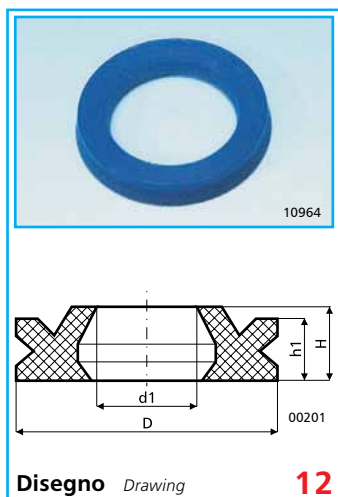
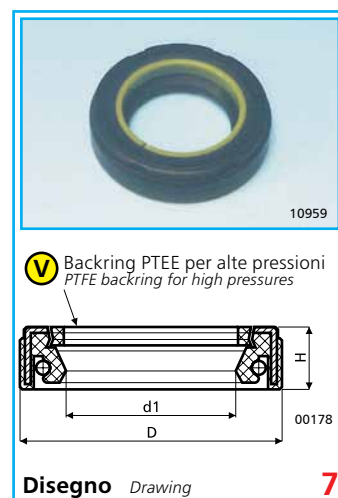
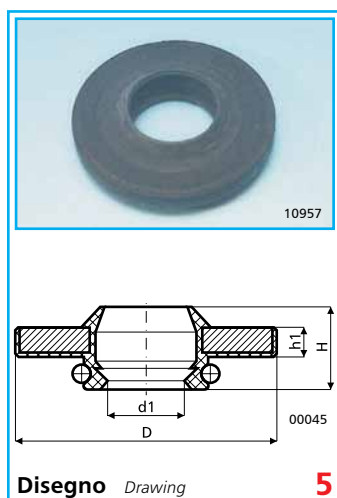

V Varianti dei disegni 6 e 7
 Variants for drawings #6 and #7
 Варианты строения сальников типа 6 и 7

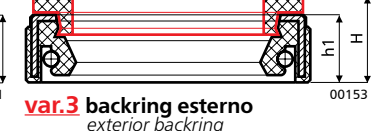
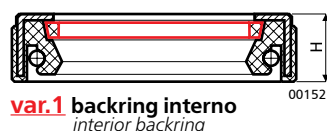

РУССКИЙ - Система классификации ORPAV

ORPAV - система классификации, которая позволяет быстро и точно определить артикул сальника, резинового и тефлонового кольца, имея под рукой любую техническую информацию.

На страницах, отмеченных **ЖЕЛТЫМ** цветом размещены фотографии и чертежи сальников, которые помогут определить необходимый Вам тип.

На страницах **СИНЕГО** цвета сальники, резиновые и тефлоновые кольца отсортированы по внутреннему номеру Emmetec.

В разделах **ОРАНЖЕВОГО** цвета артикулы (сальники, резиновые и тефлоновые кольца) отсортированы по размерам.

Разделы каталога **ЗЕЛЕНОГО** цвета позволяют находить артикулы (сальники, резиновые и тефлоновые кольца) по типам, что ускоряет процесс поиска.

Технические характеристики артикула отображаются специальными сокращениями, например:

$$10 + P + M2 = 10PM2,$$

где

10 - тип сальника

P - пылезащитная кромка (пыльник)

M2 - двусторонний тип (две рабочие кромки)

INFORMAZIONE TIP REKOMENDACII

I paraoli minorati sono identificati con la lettera finale «X»
Esempio F-00024: dimensioni normali - F-00024X: minorato
Reduced seals are identified with final letter «X»
Example F-00024: regular sizes - F-00024X: reduced seal
Сальники, обозначенные буквой «X», являются аналогами стандартных сальников с уменьшенным внутренним диаметром
Например: F-00024 - стандартный F-00024X - с уменьшенным внутренним диаметром

in ordine di codice

sorted by code
сортировка по коду

Codice Code Код	Min Ord Мин. коли- чество заказа	Dis. Drawing Тип сальника	d1	d2	D	h1	H	Uso Use in Приме- нение	Marca Brand Произво- дитель агрегата	Tipo auto Vehicle type Тип авто	Note Remarks Примечания
			Размеры								
F-00009	2	1PM	25,00		35,00	6,90	7,00	DIS	TRW		
F-00010	2	2	25,00		35,00		5,50	DIS	TRW	Fiat 131	
F-00011	2	1PM	19,00		34,60	6,20	9,20	DIS	TRW	Fiat Tipo, Croma, Thema, Sierra	
F-00012	2	7V2	23,00		34,40		6,35	CRE	TRW	Fiat Tipo, Regata, Golf	
F-00013	2	3	14,60		35,00		4,90	DIS	TRW		parapolvere
F-00014	2	7V2	24,97		37,54		6,35	CRE	TRW	Fiat Croma - Thema	standard
F-00015	2	6V2	24,97	37,80	41,30	3,20	7,40	CRE	TRW	Fiat Croma - Thema	standard
F-00016	2	6V2	23,00	34,50	40,00	3,20	7,50	CRE	TRW	Fiat Tipo I. Serie	
F-00017	2	7V2	30,00		42,50		6,50	CRE	TRW	Fiat Ducato-Iveco Daily	standard
F-00018	2	6V2	23,00	34,20	38,00	3,20	8,00	CRE	TRW	Fiat Tipo, Regata, Golf	standard
F-00019	2	0M	23,00		29,75		4,50	DIS	TRW		viton
F-00020	2	1PM	20,60		30,70	4,57	6,00	DIS	TRW	Granada	viton
F-00021	2	6V2	30,00	42,50	49,20	3,40	10,90	CRE	TRW	Ducato,Iveco,Daily	originale/genuine
F-00022	2	7V2	28,00		39,64		6,35	CRE	TRW	Bmw Z3,Citroen	standard
F-00023	2	6V2	25,00	37,80	41,60	3,40	7,70	CRE	TRW	Lancia Thema, Fiat Croma,Volvo	originale/genuine alta temperature
F-00024	2	7V2	23,00		34,50		6,50	CRE	TRW	Fiat Tipo, Regata, Golf	originale/genuine
• F-00024X	2	7V1	22,50		34,50		7,00	CRE		Fiat Tipo, Regata, VW Golf	minorato
F-00025	2	0M	26,00		35,00		7,00	CRE	ZF	Bmw-Alfa 33	originale/genuine
F-00026	2	0M	28,00		38,00		7,00	CRE	ZF	VW, Bmw 3, Audi	originale/genuine
F-00027	2	0M	22,00		31,00		6,50	CRE	ZF	Porsche	originale/genuine
F-00028	2	0M	24,00		33,00		7,00	CRE	ZF	Volvo	originale/genuine
F-00029	2	6V2	30,00	42,50	49,20	3,40	10,90	CRE	TRW	Iveco, Ducato, Daily	standard
F-00030	2	1PM	19,05		34,60	4,40	5,90	DIS	TRW	Regata, Golf, Peugeot 205	
• F-00030X	2	1PM	18,50		34,60	4,40	5,90	DIS	TRW	Regata, Golf, Peugeot 205	minorato
F-00031	2	0M	25,00		38,00		7,00	CRE	ZF	Audi	originale/genuine
F-00032	2	0	23,30		29,70		4,00	DIS	TRW	Sierra, Thema, Ducato	standard
F-00033	2	7V2	30,00		42,50		6,50	CRE	TRW	Ducato	originale/genuine
F-00034	2	6V2	23,00	34,20	40,00	3,20	7,50	CRE	TRW	Fiat Tipo I serie	originale/genuine
F-00035	2	6V2	23,00	34,20	38,00	3,20	8,00	CRE	TRW	Fiat Tipo, Regata, Golf	originale/genuine
F-00036	2	0	23,30		29,70		4,00	DIS	TRW	Sierra, Thema, Ducato	originale/genuine
F-00037	2	1PM	19,00		34,60	6,20	9,20	DIS	TRW	Fiat Tipo, Croma, Thema, Ford, Volvo	originale/genuine
F-00038	2	7V2	24,97		37,54		6,35	CRE	TRW	Thema, Croma, Mondeo, Fiesta, Chrysler, Nissan, Mazda	originale/genuine

CRE	Cremagliera	Rack	Гидроцилиндр
DIS	Distributore	Pignon	Распределитель
PIS	Pistone	Piston	Поршень
POM	Pompa	Pump	Насос
SCA	Scatola	Vox	Корпус редуктора



Codice Code Код	Min Ord Мин. количество заказа	Dis. Drawing Тип сальника	d1	d2	D	h1	H	Uso Use in Применение	Marca Brand Производитель агрегата	Tipo auto Vehicle type Тип авто	Note Remarks Примечания
			Размеры								
• F-00038X	2	7V1	24,50		37,54		6,50	CRE	TRW	Thema, Croma, Mondeo, Fiesta, Chrysler, Nissan, Mazda	minorato
F-00039	2	8	19,00		34,60	4,30	6,30	DIS	TRW	Golf	viton
F-00040	2	8	19,00		34,60	4,30	6,30	DIS	TRW	Golf	standard
F-00041	2	0M	28,00		36,60		9,00	CRE	TRW	Alfa 155	originale/genuine
F-00042	2	3	14,60		35,00		4,90	DIS	TRW	Volvo	originale/genuine parapolvere
F-00043	2	4	11,00		35,00	5,00	9,00	DIS	TRW	Fiat Tipo	originale/genuine parapolvere
F-00044	2	4	13,00		35,00	4,40	6,50	DIS	TRW	Lancia Thema II Serie	originale/genuine parapolvere
F-00045	2	0M	28,00		44,00		6,00	DIS	Smi-Koyo	Renault	
F-00046	2	1PM	30,00		43,00	8,00	9,50	DIS	ZF	Mercedes 190	originale/genuine
F-00047	2	0M	26,00		37,00		7,00	DIS	ZF	Audi, Alfa	originale/genuine
F-00048	2	0M	24,00		37,10		7,00	DIS CRE	ZF	Bmw	originale/genuine
F-00049	2	12	28,50		35,50		4,00	DIS		Jaguar J40	
F-00050	2	12	22,00		31,00		4,50	DIS		Rover 3,4 Bulloni	
F-00051	2	1PM	18,00		30,00	7,00	8,00	DIS	ZF	Audi-Bmw	
F-00052	2	1PM	16,00		28,00	6,90	7,00	POM	ZF	Audi,Alfa	
F-00053	2	1PM	22,00		35,10		7,00	DIS			standard
F-00054	2	1PM	20,00		30,00	7,00	8,00	DIS	ZF		originale/genuine
F-00055	2	0M	30,00		47,00		6,00	DIS			
F-00056	2	0M	15,00		26,00		7,00	POM			viton
F-00057	2	7V2	28,00		39,60		6,50	CRE	TRW	Alfa 156,Scudo,Galaxy	originale/genuine
F-00058	2	1PM	20,00		32,00	5,00	5,50	DIS	ZF	Citroen BX, Xantia	
F-00059	2	1PM	27,80		40,00	5,50	6,50	DIS	ZF	Peugeot 505	
F-00060	2	8	29,00		44,60	3,00	3,90	DIS		Rover 3,4 bulloni	
F-00061	2	1PM	22,00		32,00	7,00	7,50	POM	ZF	Volvo	
F-00062	2	0M	30,00		40,00		7,00	CRE	ZF	F.Transit	originale/genuine
F-00063	2	1PM	20,00		30,00	5,00	6,00	DIS	ZF	Renault, Scorpio, Peugeot, Toyota	
F-00064	2	0M	25,00		33,00		6,00	DIS			
F-00065	2	0M	27,00		37,00		7,00	DIS			
F-00066	2	0	14,30		22,00		4,00	DIS		Rover	
F-00067	2	3	19,05		35,00		3,50	DIS		Peugeot 806, 205 ultimo tipo	parapolvere
F-00068	2	1PM	15,00		22,00	4,50	5,20	DIS			
F-00069	2	1PM	22,20		32,00	5,00	6,00	DIS		Peugeot 505 azzurro	
F-00070	2	7V2	25,00		38,20		7,20	CRE		Renault	originale/genuine
F-00071	2	7V2	25,00		37,00		7,00	CRE		Renault	originale/genuine
F-00072	2	6V3	25,00	33,00	37,50	6,70	8,00	CRE		Renault	originale/genuine
F-00073	2	1PM	29,40		47,00	6,00	7,00	DIS		Citroen,Peugeot, Xantia	originale/genuine
• F-00073M	2	1PM	29,40		47,00	6,00	7,00	DIS		Citroen,Peugeot, Xantia	Distributore sup.
F-00074	2	0M	10,00		20,00		7,00	CRE	ZF	Opel Calibra	originale/genuine
F-00075	2	9M	29,40		46,80	5,80	7,00	DIS		Peugeot 505, Renault	originale/genuine
F-00076	2	9	28,40		46,80	5,80	6,50	DIS		Peugeot, Renault, Renault18	originale/genuine
F-00077	2	4A	24,00		37,00	14,50	20,00	CRE		Renault, Espace	originale/genuine
F-00078	2	0M	24,00		36,00		7,00	CRE		Renault, Espace	originale/genuine

**Paraoli**Seals
Сальники**in ordine di codice**sorted by code
сортировка по коду

CRE	Cremagliera	Rack	Гидроцилиндр
DIS	Distributore	Pignon	Распределитель
PIS	Pistone	Piston	Поршень
POM	Pompa	Pump	Насос
SCA	Scatola	Box	Корпус редуктора

Codice Code Код	Min Ord Мин. коли- чество заказа	Dis. Drawing Тип сальника	d1	d2	D	h1	H	Uso Use in Приме- нение	Marca Brand Произво- дитель агрегата	Tipo auto Vehicle type Тип авто	Note Remarks Примечания
F-00079	2	7V2	23,00		48,60		7,50	CRE		Nevada, Renault	originale/genuine
F-00080	2	1PM	18,00		30,10	5,50	6,00	DIS		Renault	
F-00081	2	0M	28,50		43,00		6,50	DIS	TRW	Renault, Clio	originale/genuine
F-00082	2	4	23,40		29,80	1,70	4,50	DIS	TRW	Volvo	originale/genuine
F-00082A	2	4	23,40		29,80	1,70	4,50	DIS	TRW	Volvo	
F-00083	2	12	22,00		31,00		4,00	DIS		Renault	
F-00084	2	8	20,00		33,00	1,60	2,00	DIS		Bendix	parapolvere
F-00085	2	12	28,00		38,00		5,00	DIS		Renault	
F-00086	2	4	23,40		30,00	4,00	6,70	DIS	TRW	Golf	viton
F-00087	2	1PM	19,05		34,60	4,40	5,90	DIS		Peugeot 205 U.T., Vw Golf.	originale/genuine
F-00088	2	0M	28,00		37,00		5,00	DIS	ZF	Skoda Octavia - Audi A3-Bmw-Vw-	
F-00089	2	1PM	24,00		33,00	5,00	6,00	DIS	ZF	A 3, Golf, Octavia	
F-00090	2	7V2	24,00		39,20		8,50	CRE	ZF	Opel Vectra, Renault VW	con back ring esterno
F-00090X	2	7V1	23,50		39,20		8,50	CRE		Opel Vectra, Renault, VW	minorato
F-00091	2	4	31,75		38,10	3,00	5,00	DIS	TRW	Rover 820	
F-00092	2	4A	34,00		47,00	5,00	12,00	DIS	TRW	Rover 820	
F-00093	2	7V2	25,00		37,20		8,50	CRE	Smi-Koyo	Renault Laguna Safrane	
F-00094	2	7V2	25,00		39,60		8,50	CRE	Smi-Koyo	Renault Laguna Safrane	
F-00095	2	7V2	24,00		37,10		8,00	CRE	Smi-Koyo	Renault Laguna Safrane, VW	
F-00096	2	1PM	25,00		38,10	7,00	8,00	DIS	Smi-Koyo	Toyota	
F-00097	2	0M	23,00		34,10		6,50	DIS		Toyota Corolla	
F-00098	2	7V2	22,00		32,10		7,00	CRE	Smi-Koyo	Toyota	
F-00099	2	1PMA	24,00		43,00		8,50	POM	Smi-Koyo	Toyota Landcruiser	
F-00100	2	1PM	20,00		40,00		6,30	DIS	Saginaw	Saab	
F-00101	2	4	27,00		37,00	3,50	7,00	DIS	Saginaw	Opel Vectra, Corsa	
F-00102	2	7V1PM	12,00		27,00		10,00	CRE	Saginaw	Opel	con P.T.F.E. interno
F-00103	2	7V2	32,00		44,50		6,50	CRE	TRW	Mercedes Vito Sprinter	originale/genuine
F-00103X	2	7V1	31,50		44,50		6,50	CRE	TRW	Mercedes Vito Sprinter	rigato esternamente
F-00104	2	3	20,00		44,00		3,50	DIS	TRW	Mercedes Vito Sprinter	parapolvere
F-00105	2	spec.			28,30	5,00	8,00	DIS	TRW		distributore inf. - tappo
F-00106	2	7V2	25,00		40,20		7,20	CRE		Megane, Traffic	originale/genuine
F-00107	2	6V3	25,00	35,00	40,00	1,70	10,00	CRE		Renault Megane, Traffic	originale/genuine
F-00108	2	1PM	20,00		42,50	3,80	5,00	DIS	TRW	Alfa 166, 156	
F-00109	2	1PM	20,00		42,50	7,00	8,00	DIS	TRW	Mercedes, Mazda	
F-00110	2	1PM	19,00		30,10	5,00	6,00	DIS		Nissan, Renault	
F-00111	2	1PM	19,00		30,00	6,40	7,00	DIS		Nissan	
F-00112	2	7V2G	29,00		37,00		8,00	CRE		Jaguar	
F-00113	2	9	28,00		47,00	4,20	5,00	DIS		Renault 205 ultimo tipo	
F-00114	2	1PM	19,00		32,00	6,00	7,00	DIS		Toyota, Mitsubishi, Nissan	
F-00115	2	12	32,00		45,00		10,50	DIS		Bendix, Transit	
F-00116	2	12	40,00		55,00		10,00	DIS		Bendix, Transit	

INFORMAZIONE TIP РЕКОМЕНДАЦИИ

I paraoli minorati sono identificati con la lettera finale «X»
Esempio F-00024: dimensioni normali - F-00024X: minorato
Reduced seals are identified with final letter «X»
Example F-00024: regular sizes - F-00024X: reduced seal
Сальники, обозначенные буквой «X», являются аналогами стандартных сальников с уменьшенным внутренним диаметром
Например: F-00024 - стандартный F-00024X - с уменьшенным внутренним диаметром



Codice Code Код	Min Ord Мин. коли- чество заказа	Dis. Drawing Тип сальника	d1	d2	D	h1	H	Uso Use in Приме- нение	Marca Brand Произво- дитель агрегата	Tipo auto Vehicle type Тип авто	Note Remarks Примечания
F-00117	2	1PM	18,00		32,00		7,00	DIS		Bendix, Transit	
F-00118	2	0M	23,35		29,75		4,50	DIS	TRW	Bmw Z3, Mazda	(speciale) ultimo tipo
F-00119	2	4	22,00		35,00	4,30	7,00	DIS	TRW		con o-ring di tenuta
F-00120	2	7V3	25,00		42,50	10,00	12,50	CRE	Saginaw	Opel Vectra	
F-00121	2	7V2	24,00		37,20		8,50	CRE	ZF	A3, Octavia VW PSA	
F-00121X	2	7V1	23,50		37,20		8,50	CRE		A3, Octavia VW PSA	minorato
F-00122	2	0MA	17,00		36,00		6,60	POM	Saginaw		alte temperature righe SX rotazione DX
F-00123	2	7V3	22,00		39,40	10,00	12,60	CRE	Saginaw		
F-00124	2	0M	26,00		37,00		7,10	CRE	ZF	Audi A4, A6	
F-00125	2	6V3	22,00		31,50	4,70	7,80	CRE	Saginaw		
F-00126	2	7V3	25,00		38,00	10,00	12,50	CRE		Saab 900	
F-00127	2	0M	22,00		34,00		7,50	DIS	ZF		
F-00128	2	7V1	27,70		39,00		8,50	CRE	Smi-Koyo	Audi A4, A6	
F-00129	2	7V3	25,00		39,30	10,00	12,70	CRE		Opel Vectra I serie, Saab 9000	
F-00130	2	4	23,40		30,00	4,00	6,70	DIS	TRW	Golf	originale/ genuine viton-alte temperature
F-00131	2	13	25,60		33,40	5,50	8,60	DIS	TRW	Veicoli pesanti	
F-00132	2	0M	28,00		37,10		4,60	DIS		Mercedes	
F-00133	2	7V1	27,70		38,10		8,50	CRE	Smi-Koyo	Audi A4, A6	
F-00134	2	0M	28,00		37,00		4,50	DIS	TRW	Skoda Octavia - Audi A3	distributore inf.
F-00135	2	6V2	25,00		35,00	3,20	6,50	CRE	Saginaw	Vectra-Fiat Fiorino-Bravo-Brava	
F-00136	2	1PM	18,70		35,00	7,00	8,00	DIS		Mitsubishi	
F-00137	2	6V2	25,00	34,60	38,00	4,30	7,60	CRE	TRW		
F-00138	2	1PM	19,90		39,90		6,50	DIS	Saginaw	Fiat Bravo, Brava	originale/genuine
F-00139	2	7V2	28,00		40,20		8,00	CRE	ZF	Audi A8	
F-00140	2	1PM	19,00		37,00	6,50	9,00	DIS	Koyo	Mitsubishi, Toyota, Audi A4	
F-00141	2	1PM	25,70		35,50	7,00	8,00	DIS	Koyo	Audi A4	
F-00142	2	0M	28,00		38,00		7,00	DIS	ZF	Bmw - Mercedes	
F-00143	2	1PMA	19,05		33,40	8,00	8,00	POM	ZF	R9-R19-Porsche-Bmw-Volkswagen	righe SX rotazione DX tiraggio maggiorato
F-00144	2	1PM	19,05		33,33	8,00	8,50	POM	ZF	Bmw-Volkswagen-Porsche	
F-00145	2	1PMA	19,05		33,40	8,00	8,00	POM	Saginaw	Bmw, Laguna, Fiat Tipo	righe SX rotazione DX alte temperature (viton)
F-00146	2	0MA	19,05		36,00		7,00	POM	Saginaw	Granada, Volvo, Fiat Tipo	righe SX rotazione DX
F-00147	2	1PM	20,00		30,00		7,00	POM		Land Rover, Daimler, Montego, Maestro	
F-00148	2	0M2	17,00		28,00		8,00	POM		Volvo, Ducato	
F-00149	2	1PMA	16,00		30,00		6,50	POM		Ford Mondeo	righe SX rotazione DX
F-00150	2	0MA	19,05		31,75		6,30	POM		Capri, Lotus, Rover	
F-00151	2	1PMA	17,00		32,00	7,20	7,20	POM		Nissan, Mitsubishi	

**Paraoli**Seals
Сальники**in ordine di codice**sorted by code
сортировка по коду

CRE	Cremagliera	Rack	Гидроцилиндр
DIS	Distributore	Pignon	Распределитель
PIS	Pistone	Piston	Поршень
POM	Pompa	Pump	Насос
SCA	Scatola	Box	Корпус редуктора

Codice Code Код	Min Ord Мин. коли- чество заказа	Dis. Drawing Тип сальника	d1	d2	D	h1	H	Uso Use in Приме- нение	Marca Brand Произво- дитель агрегата	Tipo auto Vehicle type Тип авто	Note Remarks Примечания
F-00152	2	1PM	18,00		30,00	7,00	7,00	POM	ZF	Nissan, Mazda	
F-00153	2	0M2	20,00		35,00		8,00	POM	ZF	Bmw, Ducato	
F-00154	2	1PM	17,00		32,00		8,00	POM		Nissan	
F-00155	2	1PM	15,00		25,00	5,00	5,20	POM		Honda	
F-00156	2	1PM	16,00		30,00	7,00	7,00	POM		Honda	righe DX rotazione SX
F-00157	2	1PMA	17,00		31,00	7,00	7,00	POM		Nissan	
F-00158	2	0MA	19,05		36,00		7,00	POM	Saginaw		righe DX rotazione SX
F-00159	2	0M2	20,00		40,00		8,00	POM			alte temperature
F-00160	2	1PM	19,05		33,33		7,90	POM		Bmw, Porsche, Mercedes	originale/genuine
F-00161	2	1PM	20,00		34,10	7,00	7,00	POM		Rover 600	
F-00162	2	1PM	15,00		24,00	7,00	7,00	POM		Rover 200 – Hoborn Eaton	
F-00163	2	0MA	19,05		36,00		6,60	POM	Saginaw	Chrysler, Concord, Dodge	righe SX rotazione DX alte temperature
F-00164	2	1PA	18,00		32,00		8,00	POM		Isuzu	
F-00165	2	1PMA	17,00		34,00		8,00	POM		Lexus GS 300, Camry 6 CYL 92,93	
F-00166	2	1PM	20,00		36,00		7,00	POM			
F-00167	2	1PMA	19,05		31,75	6,50	6,60	POM			
F-00168	2	0M	20,68		41,20		6,30	DIS		Ford Mondeo, Fiesta	distributore sup. esterno
F-00169	2	0M	28,00		37,70		5,00	DIS		Ford Mondeo, Fiesta	distributore inf.
F-00170	2	3A	18,00		42,00		4,00	DIS		Ford Mondeo, Fiesta	parapolvere
F-00171	2	7V1	24,00		42,50		13,00	CRE		Hyundai, Lantra	
F-00172	2	1PM	28,00		40,00	7,00	8,00	DIS	ZF	Bmw	
F-00173	2	0A	32,00		42,00		6,50	DIS		Mitsubishi	
F-00174	2	0A	35,00		47,00		7,50	DIS		Mitsubishi	
F-00175	2	0A	30,20		42,00		6,00	DIS		Mitsubishi	
F-00176	2	2	32,00		40,00		7,00	DIS		Isuzu, Trooper	
F-00177	2	1PM	22,20		35,00		7,00	DIS		Isuzu, Frontera, Trooper	
F-00178	2	7V1PM	12,00		27,00	9,00	10,00	CRE	Saginaw	Opel Calibra	
F-00179	2	1PM	16,70		28,00		6,00	DIS		Honda	
F-00180	2	1PM	15,00		35,50	5,50	6,00	DIS		Honda, Rover	
F-00181	2	1PM	17,00		35,00		8,00	DIS			
F-00182	2	1PM	18,00		28,00	5,00	6,00	DIS	ZF	Audi	
F-00183	2	1PM	18,00		30,00	7,00	8,00	DIS	ZF	Nissan	
F-00184	2	1PM	19,00		38,00	7,00	8,00	DIS		Toyota Corolla	
F-00185	2	1PM	18,00		34,00	7,50	12,50	DIS			
F-00186	2	1PM	20,00		40,00		6,00	DIS	Saginaw	Fiorino, Opel Vectra 96, Sintra	alte temperature
F-00187	2	1PM	19,00		32,20	7,00	8,00	DIS		Toyota	
F-00188	2	2	19,00		35,00		3,00	DIS		Peugeot 205 U.T.	parapolvere
F-00189	2	1PM	18,80		30,00	5,00	6,00	DIS		Nissan	
F-00190	2	12	29,00		45,00		5,00	DIS		Rover 3,4 Bulloni	
F-00191	2	3	20,00		44,00		4,50	DIS	TRW	VW Sharan	parapolvere
F-00192	2	0M	22,00		32,10		5,00	DIS		Rover 4 Bulloni	
F-00193	2	1PM	22,00		32,00	5,00	6,00	DIS		Peugeot 505 Alta temperatura	
F-00194	2	1PM	23,00		35,00	6,50	7,00	DIS		Mitsubishi, Toyota	

INFORMAZIONE TIP РЕКОМЕНДАЦИИ

I paraoli minorati sono identificati con la lettera finale «X»
Esempio F-00024: dimensioni normali - F-00024X: minorato
Reduced seals are identified with final letter «X»
Example F-00024: regular sizes - F-00024X: reduced seal
Сальники, обозначенные буквой «X», являются аналогами стандартных сальников с уменьшенным внутренним диаметром
Например: F-00024 - стандартный F-00024X - с уменьшенным внутренним диаметром



Codice Code Код	Min Ord Мин. колич- ество заказа	Dis. Drawing Тип сальника	d1	d2	D	h1	H	Uso Use in Приме- нение	Marca Brand Произво- дитель агрегата	Tipo auto Vehicle type Тип авто	Note Remarks Примечания
F-00195	2	0M	23,00		38,10		6,80	DIS		Mitsubishi, Hyundai Atos	
F-00196	2	0M	25,00		34,00		7,00	DIS	ZF	Calibra, Mercedes	
F-00197	2	12	32,00		44,50		7,00	DIS		Rover 3,4,6 Bulloni	
F-00198	2	7V2	24,00		36,00		7,00	CRE		Nissan	
F-00199	2	0M	25,00		35,00		7,00	DIS		Toyota	
F-00200	2	1PM	25,00		42,00	6,50	7,00	DIS		Nissan	
F-00201	2	1PM	19,00		27,00		5,00	DIS		Rover 6 Bulloni	
F-00202	2	12	32,00	44,50	46,00		5,00	DIS		Rover 3,4 Bulloni	originale/genuine
F-00203	2	12	32,00	44,60	46,20		6,40	DIS		Rover 3,4 Bulloni	originale/genuine in poliuretano azzurro
F-00204	2	0M	28,00		41,00		6,50	DIS		Toyota	
F-00205	2	0M	31,00		44,00		6,50	DIS		Toyota	
F-00206	2	0M	26,00		38,20		6,50	DIS		Toyota-Mitsubishi	
F-00207	2	2	32,00		40,00		5,00	CRE		Toyota Land Cruiser	
F-00208	2	0M	30,00		43,00		6,50	CRE		Toyota Land Cruiser	
F-00209	2	0M	30,00		41,00		6,50	CRE		Toyota Supra	
F-00210	2	12	31,00		39,00		5,00	DIS		Mitsubishi Shougun, Suzuki Vitara	
F-00211	2	12	32,00		40,00		5,00	DIS		Isuzu, Frontera, Trooper	
F-00212	2	0M	30,00		38,00		5,00	DIS		Toyota Space Cruiser	
F-00213	2	0M	32,00		42,00		5,00	DIS		Toyota	
F-00214	2	12	32,00	44,70	46,30		7,00	DIS		Rover 3,4 Bulloni	in poliuretano azzurro parapolvere
F-00215	2	3	15,00		42,00		3,50	DIS			
F-00216	2	7V2	20,00		34,20		9,00	CRE		Isuzu	
F-00217	2	7V2	20,00		32,10		8,50	CRE			
F-00218	2	7V2G	21,00		29,50		6,00	CRE		Honda	con interno in P.A.
F-00219	2	7V2	22,00		35,20		8,50	CRE		Toyota con teflon eterno	
F-00220	2	7V2	22,00		36,60		8,00	CRE		Toyota	
F-00221	2	7V2	22,00		38,40		8,00	CRE		Nissan	
F-00222	2	7V2	22,00		38,30		8,00	CRE		Toyota Tercel	
F-00223	2	7V2	23,00		37,20		9,00	CRE		Subaru, Isuzu	
F-00224	2	7V2	23,00		40,20		9,00	CRE		Subaru	
F-00225	2	7V2	23,00		41,20		9,00	CRE		Subaru	
F-00226	2	7V2	24,00		36,60		8,50	CRE		Mitsubishi, Renault, Hyundai	originale/genuine
F-00227	2	7V2	24,00		37,60		8,50	CRE		Subaru	originale/genuine
F-00228	2	7V1	24,00		40,00		7,00	CRE		Nissan	
F-00229	2	7V2	24,00		38,30		8,50	CRE		Toyota	
F-00230	2	7V2	24,00		40,20		8,00	CRE		Toyota	
F-00231	2	7V1	24,00		41,00		8,50	CRE		Toyota Corolla	
F-00232	2	7V2	24,00		42,10		8,50	CRE		Mitsubishi	
F-00233	2	7V2	24,00		42,00		9,00	CRE		Toyota	
F-00234	2	7V2	24,00		43,10		7,00	CRE		Nissan	
F-00235	2	7V2	24,00		45,00		7,00	CRE		Nissan	
F-00236	2	7V2	24,00		34,10		7,00	CRE		Nissan	
F-00237	2	7V2	24,00		36,30		8,00	CRE		Toyota	

**Paraoli**Seals
Сальники**in ordine di codice**sorted by code
сортировка по коду**CRE**
DIS
PIS
POM
SCACremagliera
Distributore
Pistone
Pompa
ScatolaRack
Pignon
Piston
Pump
BoxГидроцилиндр
Распределитель
Поршень
Насос
Корпус редуктора

Codice Code Код	Min Ord Мин. коли- чество заказа	Dis. Drawing Тип сальника	d1	d2	D	h1	H	Uso Use in Приме- нение	Marca Brand Произво- дитель агрегата	Tipo auto Vehicle type Тип авто	Note Remarks Примечания
F-00238	2	7V1	24,00		38,20		12,50	CRE		Mitsubishi, Volvo V4-V70	
F-00239	2	7V1	24,00		35,30		12,00	CRE		Mitsubishi	
F-00240	2	7V1	24,00		40,00		8,50	CRE		Nissan	
F-00241	2	7V2	25,00		43,00		9,00	CRE		Ford Mazda	
F-00242	2	7V2	25,00		48,20		10,00	CRE		Ford Mazda	
F-00243	2	7V2	25,00		37,50		7,00	CRE		Ford Mazda	
F-00244	2	7V2	25,00		38,00		9,00	CRE		Nissan	
F-00245	2	7V2	25,00		35,00		8,00	CRE		Nissan	
F-00245M	2	7V1	25,00		35,00		8,00	CRE		Nissan	
F-00246	2	7V3	25,00		39,50	10,00	12,50	CRE		Fiorino, Vectra 96	
F-00247	2	7V2	25,50		44,20		8,50	CRE		Toyota Camry	
F-00248	2	7V2	25,50		37,70		8,00	CRE		Toyota	
F-00249	2	7V2	25,50		39,20		8,00	CRE			
F-00250	2	7V2	25,50		39,90		8,00	CRE		Toyota	
F-00251	2	7V2	25,50		38,70		8,50	CRE		Toyota	
F-00252	2	7V2	25,50		39,30		8,50	CRE		Toyota	
F-00253	2	7V2	25,50		41,30		8,00	CRE		Toyota	
F-00254	2	7V2	25,50		42,10		9,00	CRE		Toyota	
F-00255	2	7V2	25,50		42,70		8,00	CRE		Toyota	
F-00256	2	7V2G	26,00		35,00		6,00	CRE		Honda	
F-00257	2	7V2	26,00		43,00		12,50	CRE		Mitsubishi	
F-00258	2	7V2	26,00		41,20		12,50	CRE		Mitsubishi	
F-00259	2	7V2	26,00		45,10		7,00	CRE		Nissan	
F-00260	2	7V2	26,50		41,40		8,50	CRE		Toyota	
F-00261	2	7V2	26,00		38,10		8,50	CRE		Mitsubishi	
F-00262	2	7V2	26,00		41,10		8,50	CRE		Mitsubishi	
F-00263	2	7V2	26,50		44,20		8,00	CRE		Toyota Lexus IS 300	
F-00264	2	7V2	26,50		44,10		8,50	CRE		Toyota	
F-00265	2	7V1	27,00		41,20		8,50	CRE		Toyota	
F-00266	2	7V1	27,00		43,20		8,50	CRE		Toyota	
F-00267	2	7V1	27,00		44,20		8,50	CRE		Toyota	
F-00268	2	7V2	27,70		42,00		12,50	CRE		Mitsubishi	
F-00269	2	7V2	28,00		41,20		8,00	CRE		Kia Carnival	
F-00270	2	7V2	27,70		42,00		8,50	CRE		Mitsubishi	
F-00271	2	7V2	30,00		42,30		8,00	CRE		Toyota	
F-00272	2	7V2	30,00		45,70		8,50	CRE		Toyota, Celica 4WD	
F-00273	2	7V2	30,00		46,20		8,00	CRE		Toyota	
F-00274	2	7V2	30,00		47,00		9,00	CRE		Toyota	
F-00275	2	7V1	32,00		49,00		8,50	CRE			
F-00276	2	7V1	32,00		46,10		8,50	CRE			
F-00277	2	7V2	36,00		50,50		9,00	CRE			
F-00278	2	12	23,00		30,00		5,00	DIS		Subaru	
F-00279	2	1PM	15,00		36,00	5,50	9,50	DIS		Honda	
F-00280	2	7V2	22,00		34,00		8,50	CRE		Toyota	
F-00281	2	7V2	25,00		38,00		8,50	CRE		Volvo	
F-00282	2	7V2	25,00		45,20		8,00	CRE		Nissan	
F-00283	2	7V3	22,00		35,30	10,00	15,50	CRE		Opel Corsa	
F-00284	2	6V2	22,00		32,00	4,00	6,00	CRE		Opel Corsa	
F-00285	2	7V2G	24,00		34,00		6,00	CRE		Honda	
F-00286	2	7V1	28,00		46,00		12,50	CRE		Mitsubishi	

INFORMAZIONE TIP РЕКОМЕНДАЦИИ

I paraoli minorati sono identificati con la lettera finale «X»
Esempio F-00024: dimensioni normali - F-00024X: minorato
Reduced seals are identified with final letter «X»
Example F-00024: regular sizes - F-00024X: reduced seal
Сальники, обозначенные буквой «X», являются аналогами стандартных сальников с уменьшенным внутренним диаметром
Например: F-00024 - стандартный F-00024X - с уменьшенным внутренним диаметром



Codice Code Код	Min Ord Мин. колич- ество заказа	Dis. Drawing Тип сальника	d1	d2	D	h1	H	Uso Use in Приме- нение	Marca Brand Произво- дитель агрегата	Tipo auto Vehicle type Тип авто	Note Remarks Примечания
F-00287	2	7V2	24,00		36,50		12,00	CRE		Mitsubishi	
F-00288	2	7V2	25,00		41,00		8,50	CRE		Volvo	
F-00289	2	7V2	31,00		43,70		6,30	CRE		Ford Explorer	
F-00290	2	6V2	31,00	43,70	48,00	4,00	8,30	CRE		Ford Explorer	
F-00291	2	7V1	24,00		41,00		12,50	CRE		Mitsubishi	
F-00292	2	7V2	23,00		41,20		8,00	CRE		Mazda	
F-00293	2	7V2	25,00		43,00		7,50	CRE		Mazda	
F-00294	2	7V3G	25,00		33,00	5,00	5,50	CRE		Subaru	
F-00295	2	0M	24,00		36,00		7,00	DIS		Subaru	
F-00296	2	4	23,30		30,00	4,00	6,00	DIS	TRW	Ford	
F-00297	2	1PM	20,00		30,00	4,90	6,10	DIS		Mazda	alta pressione
F-00298	2	12	29,00		37,50		6,00	DIS		Subaru	
F-00299	2	3	15,00		41,50		5,70	DIS		Ford	parapolvere
F-00300	2	1PM	15,00		24,00	7,00	7,00	DIS		Audi	distributore inf.
F-00301	2	0M	25,00		34,00		5,00	DIS		Ford	
F-00302	2	0M	25,00		39,00		9,00	CRE			
F-00303	2	1PM	26,00		35,50	6,00	6,50	DIS		Subaru	
F-00304	2	0M	22,00		35,00		6,50	DIS		A & A	
F-00305	2	8A	22,20		42,80		14,70	DIS	TRW		
F-00306	2	8	18,00		32,20	6,20	8,20	DIS		Subaru	
F-00307	2	3A	19,00		26,50		4,00	DIS		Subaru	
F-00308	2	1PM	19,00		42,00	6,50	8,00	DIS		Mazda RX7	
F-00309	2	1PM	26,00		35,00	6,00	6,50	DIS		Mazda	
F-00310	2	8	16,00		42,30	5,00	9,00	DIS		Mazda	parapolvere
F-00311	2	1PM	25,00		34,00	6,00	6,50	DIS		Mazda	
F-00312	2	0M	25,00		34,00		5,00	DIS	ZF	Saab 900,9000 Toyota Carina	
F-00313	2	1PM	19,00		28,00	5,00	6,00	DIS	ZF	Volkswagen	
F-00314	2	1PM	34,00		44,40		6,00	DIS		Mazda,Ford	
F-00315	2	1PM	19,00		30,00	7,00	8,00	DIS		Volvo	
F-00316	2	12	36,00		45,00		3,70	DIS		Jaguar J16,XJ12	
F-00317	2	8	19,00		40,00		2,50	DIS		Sintra	parapolvere
F-00318	2	12	27,70		36,00		5,00	DIS		Mazda	
F-00319	2	0M	28,00		37,20		5,00	DIS	ZF	Audi A4	
F-00320	2	7V3G	30,00		38,00	3,50	5,50	DIS		Jaguar Adwest	P.T.F.E. + paraolio
F-00321	2	12	25,00		35,00		6,00	CRE		Mazda	
F-00322	2	12	22,00		32,00		6,50	CRE		Mazda	
F-00323	2	0	19,00		28,50		5,50	DIS		Isuzu, Subaru	
F-00324	2	7V3G	25,00		32,00	3,70	5,50	CRE		Lotus	P.T.F.E. + paraolio
F-00325	2	0M	22,00		32,10		7,00	CRE	ZF	Ford Sierra	
F-00326	2	1PM	20,55		31,97		6,35	CRE		Rolls Royce	
F-00327	2	7V2G	21,10		29,50		6,00	CRE		Honda	con interno P.T.F.E.
F-00328	2	7V2G	21,00		30,00		5,00	CRE		Honda	P.A.
F-00329	2	12	21,10		30,00		5,25	CRE		Honda	in poliuretano
F-00330	2	7V2G	21,00		30,00		5,00	CRE		Honda	
F-00331	2	0M	26,00		37,00		5,00	CRE	ZF	Jaguar	
F-00332	2	0M	24,00		33,00		5,00	DIS	ZF	Volkswage,Opel	
F-00333	2	0M	22,00		35,00		7,00	DIS	ZF	Porsche	
F-00334	2	12	25,00		37,70		9,30	CRE		Austin 1800,2200	
F-00335	2	spec.	20,00		35,00		4,00	DIS		Wiper Jaguar J40	
F-00336	2	12	29,00		37,00		5,00	DIS		Suzuki Vitara	

**Paraoli**Seals
Сальники**in ordine di codice**sorted by code
сортировка по коду

CRE	Cremagliera	Rack	Гидроцилиндр
DIS	Distributore	Pignon	Распределитель
PIS	Pistone	Piston	Поршень
POM	Pompa	Pump	Насос
SCA	Scatola	Box	Корпус редуктора

Codice Code Код	Min Ord Мин. коли- чество заказа	Dis. Drawing Тип сальника	d1	d2	D	h1	H	Uso Use in Приме- нение	Marca Brand Произво- дитель агрегата	Tipo auto Vehicle type Тип авто	Note Remarks Примечания
			Размеры								
F-00337	2	12	36,00		46,00		6,00	DIS		Mitsubishi Shougun	
F-00338	2	spec.	22,00		40,00		4,00	DIS		Wiper Rover 4 Bulloni	
F-00339	2	4	26,00		35,00	4,00	8,00	DIS		Saab 900,9000	
F-00340	2	8	16,00		40,00		2,50	DIS		Saab, Opel Corsa	parapolvere
F-00341	2	12	28,00		42,00		7,00	CRE		Triumph, Jaguar	
F-00342	2	7V2G	28,50		45,00		9,00	CRE		Jaguar XJ6	
F-00343	2	7V2	28,50		44,50		10,00	CRE		Rover, Jaguar	
F-00344	2	12	22,20		33,20		4,00	DIS		Jaguar Granada	
F-00345	2	8	22,00		33,20	1,60	3,00	DIS		Rover 3,4 Bulloni	
F-00346	2	12	28,00		38,30		4,00	DIS		Jaguar, Granada	
F-00347	2	0M	19,00		31,80		6,30	DIS		SDI Burman	
F-00348	2	12	24,00		34,00		4,00	DIS		Jaguar, Granada MKI	
F-00349	2	12	22,50		29,00		3,60	DIS		Stag	in gomma
F-00350	2	12	26,00		32,50		3,60	DIS		Granada	
F-00351	2	12	34,00		40,00		3,60	DIS		Jaguar, Rover	
F-00352	2	12	34,00		44,50		4,30	DIS		Alpine Solara	
F-00353	2	0M	25,00		37,00		6,70	DIS		Burman	
F-00354	2	1P	26,50		43,20	9,20	11,70	CRE		A E A M X 2	
F-00355	2	1PM	10,00		20,00		7,00	CRE			
F-00356	2	0M2	17,00		30,00		7,00	POM			alte temperature
F-00357	2	1PM	32,00		45,00		7,00	DIS			
F-00358	2	0M	29,00		43,00		7,00	DIS	ZF	Citroen XM,Xara, Alfa 159,	
F-00359	2	1PM	23,30		37,00		7,30	DIS		Citroen XM,Xara	
F-00360	2	7V1	24,00		36,50		7,50	CRE		Peugeot, Renault	originale/genuine
F-00361	2	0M	27,50		37,00		6,90	DIS		Rolls Royce	
F-00362	2	9	23,00		38,00	5,00	7,00	DIS	TRW	Trattori movimento terra	
F-00363	2	12	23,00		29,50	5,00	7,00	DIS	TRW	Trattori movimento terra	con P.T.F.E.
F-00364	2	1PM	11,75		22,00	7,00	10,00	POM		Cherokee	
F-00365	2	1PM	16,00		26,00	5,20	6,20	POM		Audi,Bmw	trattori LUK righe SX rotazione DX
F-00366	2	1PM	19,00		32,00	6,90	7,00	POM	ZF	Vito,Trova way	
F-00367	2	0M	27,00		36,00		5,50	DIS		Mercedes Vito	
F-00368	2	1PM	19,05		34,70	6,20	7,50	DIS	TRW	Opel Astra, Focus, Polo	originale/genuine
F-00369	2	6V2	25,00	37,80	41,50	3,30	7,50	CRE	TRW	Mondeo, Fiesta (I serie)	originale/genuine
F-00370	2	3	19,05		35,00		3,40	DIS		F.Megane	parapolvere
F-00371	2	7V2	26,00		38,20		8,60	CRE	ZF	Peugeot 406	
F-00372	2	7V1PM	14,00		27,00	9,00	10,00	CRE	Saginaw	Opel Vectra B, GM	alte temperature (con teflon interno)
F-00373	2	7V2	26,00		38,00		12,00	CRE		Mitsubishi	
F-00374	2	7V1	30,00		50,00		8,50	CRE		Nissan	
F-00375	2	7V1	27,70		45,00		8,50	CRE	Smi-Koyo	Renault Espace	
F-00376	2	7V1	26,00		45,00		8,50	CRE		Nissan Skiline	
F-00377	2	7V1	25,00		44,00		9,00	CRE		Nissan Skiline	
F-00378	2	7V3	28,00		38,00	7,00	9,00	CRE	ZF	Passat,A4	
F-00379	2	7V1	25,50		41,00		10,00	CRE		Toyota Celica	
F-00380	2	7V2	26,00		40,00		8,50	CRE		Renault Safrane	
F-00381	2	7V2	22,00		35,00		8,00	CRE		Suzuki Swift	
F-00382	2	3	19,00		59,50		7,00	DIS		Jaguar	coperchio pignone
F-00383	2	0M	36,00		44,00		5,00	CRE		Toyota	

INFORMAZIONE TIP РЕКОМЕНДАЦИИ

I paraoli minorati sono identificati con la lettera finale «X»
Esempio F-00024: dimensioni normali - F-00024X: minorato
Reduced seals are identified with final letter «X»
Example F-00024: regular sizes - F-00024X: reduced seal
Сальники, обозначенные буквой «X», являются аналогами стандартных сальников с уменьшенным внутренним диаметром
Например: F-00024 - стандартный F-00024X - с уменьшенным внутренним диаметром



Codice Code Код	Min Ord Мин. коли- чество заказа	Dis. Drawing Тип сальника	d1	d2	D	h1	H	Uso Use in Приме- нение	Marca Brand Произво- дитель агрегата	Tipo auto Vehicle type Тип авто	Note Remarks Примечания
F-00384	2	2	19,00		25,50		3,00	DIS			
● F-00384M	2	2	19,00		25,50		3,30	DIS			
F-00385	2	1PM	35,00		50,00	8,00	10,00	DIS		Mercedes	
F-00386	2	0M	6,35		19,00		5,00	DIS		Renault, Peugeot	
F-00387	2	0M	24,00		38,00		7,00	DIS		Volvo	
F-00388	2	1PM	17,90		35,50	8,20	10,00	DIS		Renault, Peugeot	
F-00389	2	1PM	26,00		37,00	7,00	8,00	DIS	ZF		
F-00390	2	1PM	20,00		35,00	6,00	7,00	POM		Alfa 155 ,Cherokee, Astra	standard
F-00391	2	1PM	20,00		35,00	6,00	7,00	POM		Alfa 155 ,Cherokee, Astra	alte temperature
F-00392	2	2	24,50		31,00		4,50	DIS	TRW	Ford	distributore inf.
F-00393	2	12	22,00		31,00		5,00	CRE		Suzuki Swift-Subaru	
F-00394	2	0M	28,00		38,50		5,00	DIS		Suzuki Swift	
F-00395	2	1PM	18,75		30,00	5,00	6,00	DIS		Suzuki Swift	
F-00396	2	7V2	23,00		34,55		6,50	CRE	TRW	Golf, Ford, VW	originale/genuine America
F-00397	2	7V2	24,00		39,00	8,50	16,50	CRE	ZF	Golf, Octavia, Skoda Felicia	
● F-00397X	2	7V1	23,50		39,00	8,50	16,50	CRE	ZF	Golf, Octavia, Scoda Felicia	
F-00398	2	7V2	35,00		50,00		8,00	CRE		Toyota Land Cruiser	
F-00399	2	7V2	25,50		38,80		8,00	CRE		Toyota Land Cruiser	
F-00400	2	7V1	26,00		46,00		8,00	CRE		Honda Prelude	
F-00401	2	7V1	26,00		42,50		8,50	CRE		Mitsubishi	
F-00402	2	7V2	23,00		38,20		9,00	CRE		Suzuki Baleno, Mazda MX5	
F-00403	2	1PM	19,00		32,00	6,00	7,00	DIS		Toyota Pik up e 4x4	
F-00404	2	0	28,00		38,20		6,50	DIS		Bmw, Opel	
F-00405	2	0M2	30,00		42,00		7,00	POM		Mercedes BMW LUK	
F-00406	2	6V2	25,00		35,20	3,70	6,50	CRE	Saginaw	Fiat Fiorino-Opel Vectra	
F-00407	2	7V1	24,00		42,00		8,00	CRE	Saginaw	Honda	
F-00408	2	0M	27,00		38,00		5,50	DIS		Honda	
F-00409	2	7V2	28,00		38,00		15,00	CRE	ZF	Audi A6,A8	
F-00410	2	1PM	23,40		37,30	8,00	8,20	DIS		Citroen XM	
F-00411	2	7V2	25,00		42,00		8,00	CRE		Mazda	
F-00412	2	12	25,00		35,40		6,30	CRE		Mazda	
F-00413	2	1PM	20,00		32,00		8,00	POM		Mazda	
F-00414	2	1PM	17,00		30,00		7,00	POM		Mazda	
F-00415	2	1PA	15,00		24,00	4,50	7,00	POM		Rover	
F-00416	2	0MA	18,00		36,00		6,80	POM	Saginaw		alte temperature righe SX rotazione DX
F-00417	2	7V2	30,00		42,80		6,30	CRE	TRW	Fiat Ducato – Iveco Daily	originale/genuine maggiorato
F-00418	2	1PM	19,00		32,00		7,00	POM	ZF	Opel, Skoda, VW	viton
F-00419	2	8	17,00		40,00	4,60	6,50	DIS			
F-00420	2	1PM	20,00		42,50		4,80	DIS	TRW	Alfa 156	
F-00421	2	1PMA	19,05		33,30		8,00	POM			
F-00422	2	0M	25,00		34,00		7,00	CRE		Mercedes	
F-00423	2	7V2	25,00		36,00		8,50	CRE		Mercedes	
F-00424	2	1PM	35,00		47,00	7,00	8,50	DIS		Mercedes SLE	
F-00425	2	0M	22,00		32,00		5,50	DIS		Rover 4 Bulloni	

**Paraoli**Seals
Сальники**in ordine di codice**sorted by code
сортировка по коду**CRE
DIS
PIS
POM
SCA**Cremagliera
Distributore
Pistone
Pompa
ScatolaRack
Pignone
Piston
Pump
BoxГидроцилиндр
Распределитель
Поршень
Насос
Корпус редуктора

Codice Code Код	Min Ord Мин. коли- чество заказа	Dis. Drawing Тип сальника	d1	d2	D	h1	H	Uso Use in Приме- нение	Marca Brand Произво- дитель агрегата	Tipo auto Vehicle type Тип авто	Note Remarks Примечания
F-00426	2	7V1	24,00		42,00		8,00	CRE		Honda	
F-00427	2	1PMA	17,00		31,00	8,00	8,00	POM			
F-00428	2	0	28,60		38,00		6,00	DIS		Nissan King Kab	
F-00429	2	2	20,00		26,00		3,00	DIS	ZF		
F-00430	2	0	32,00		45,10		6,50	DIS		Range Rover 93	
F-00431	2	0M	28,50		43,00		6,50	DIS		Renault Clio	originale/genuine
F-00432	2	1PMA	15,00		28,00	6,20	6,30	POM	ZF	Opel Vectra-Alfa 159	
F-00433	2	0M	28,60		37,60		5,10	DIS			
F-00434	2	1PM	28,00		40,00	6,00	7,00	DIS			
F-00435	2	1PM	29,40		46,80	6,30	7,00	DIS		Peugeot	
F-00436	2	8	19,05		37,30	6,00	8,00	DIS		Renault Peugeot	
F-00437	2	12	38,00		53,00	7,20	9,50	DIS			
F-00438	2	3G	16,00		46,00		9,00	DIS		Alfa 33,Alfa 75	parapolvere
F-00439	2	1PM	15,00		24,00		6,00	POM		Rover	
F-00440	2	6V2	23,00		32,90	6,00	8,00	CRE	TRW	Skoda,VW Polo- UT	
F-00441	2	6V2	23,00	34,30	38,00	3,20	8,00	CRE	TRW	VW Golf	originale/genuine America
F-00442	2	1PM	21,00		33,00	8,00	10,00	DIS		Mercedes	
F-00443	2	1PM	27,00		38,10	5,50	7,50	DIS		TAS 75,85	
F-00444	2	7V2	32,00		44,50		8,50	CRE		Mercedes	
F-00445	2	7V3	24,00		37,10	15,00	17,00	CRE		Saab 9-5	con segmento P.T.F.E. esterno
F-00446	2	1PM	32,00		44,00	8,50	10,00	DIS		Mercedes	
F-00447	2	7V1	26,00		42,70		8,00	CRE		Lexus	
F-00448	2	7V2	25,00		38,00		6,30	CRE	TRW	Rover 75	
F-00449	2	1PM	20,00		42,50	9,00	10,00	DIS		Mercedes	
F-00450	2	7V2	30,00		48,10		8,00	CRE		Toyota Hi ace	
F-00451	2	7V1	35,00		56,00		8,00	CRE		Toyota Land Cruiser	
F-00452	2	1PMA	35,00		47,00	8,00	10,00	DIS		Mitsubishi	
F-00453	2	1PM	20,60		32,00	6,00	7,00	DIS		MK2 Land Rover - Discovery	
F-00454	2	12	35,00		47,00		6,50	DIS		Mitsubishi, Nissan, Hyundai Terracan	pignone
F-00455	2	1PM	32,00		42,00	7,00	9,00	DIS		Kia, Daiatshu	
F-00456	2	0	30,00		38,00		7,00	DIS		Mazda	
F-00457	2	12	28,00		36,00		5,50	DIS		Stag	
F-00458	2	1PM	30,00		42,00	7,00	8,00	DIS		Lexus	
F-00459	2	1PM	19,00		29,00	7,00	8,00	DIS		Toyota Yaris	
F-00459M	2	1PM	19,00		29,00	7,00	8,00	DIS		Toyota Yaris	
F-00460	2	1A	18,00		34,00	17,00	20,00	DIS		Mazda	pignone con metallo
F-00461	2	1PA	16,00		34,00	36,00	38,00	DIS		Ford Mazda 626 323	pignone con metallo
F-00462	2	0M2	19,00		29,00		7,00	POM			
F-00463	2	1PA	15,88		31,70		6,35	POM	Saginaw		
F-00464	2	1PMA	18,00		34,00	7,90	8,00	POM		Voyager	
F-00465	2	0AM2	17,00		32,00		8,00	POM		Toyota Land Cruiser 8,92	
F-00466	2	8A	11,75	22,13	29,80	1,90	12,65	POM		Jeep Cherokee	
F-00467	2	6V2	25,00	37,80	41,80	3,30	7,50	CRE		Ford Mondeo – Fiesta (ultimo tipo)	originale/genuine
F-00467X	2	6V1	24,50	37,80	41,80	3,30	7,50	CRE		Ford Mondeo – Fiesta (ultimo tipo)	

INFORMAZIONE TIP РЕКОМЕНДАЦИИ

I paraoli minorati sono identificati con la lettera finale «X»
Esempio F-00024: dimensioni normali - F-00024X: minorato
Reduced seals are identified with final letter «X»
Example F-00024: regular sizes - F-00024X: reduced seal
Сальники, обозначенные буквой «X», являются аналогами стандартных сальников с уменьшенным внутренним диаметром
Например: F-00024 - стандартный F-00024X - с уменьшенным внутренним диаметром



Codice Code Код	Min Ord Мин. коли- чество заказа	Dis. Drawing Тип сальника	d1	d2	D	h1	H	Uso Use in Приме- нение	Marca Brand Произво- дитель агрегата	Tipo auto Vehicle type Тип авто	Note Remarks Примечания
F-00468	2	12	39,00		49,00		6,40	CRE		Jeep Cherokee ultimo tipo	
F-00469	2	0M	32,00		44,50		5,50	CRE		Cherokee ultimo tipo	
F-00470	2	12	32,00		42,00		8,00	CRE			
F-00471	2	1PM	50,00		70,00		10,00	DIS		Veicoli pesanti	
F-00472	2	3	16,00		24,00	2,50	3,50	DIS	TRW	HFB 70	parapolvere
F-00473	2	1PM	17,00		30,00		7,00	POM		Mazda	
F-00474	2	7V1	24,00		39,10		8,50	CRE		Bmw - Mini	con back ring interno
• F-00474X	2	7V1	23,50		39,20		8,50	CRE		Opel Vectra, Renault, VW	minorato
F-00475	2	7V1	26,00		43,00		8,50	CRE		Nissan	
• F-00475X	2	7V1	25,50		43,00		8,50	CRE		Alfa 159	minorato
F-00476	2	7V2A	24,00		36,00		17,70	CRE		Peugeot 206	
F-00477	2	1PM	56,00		70,00	9,00	11,00	DIS		Mercedes LS7	distributore sup.
F-00478	2	1PM	28,00		40,00	8,00	10,50	DIS		Mercedes LS7 LS8 LS3	
F-00479	2	0M	28,00		38,00		7,00	CRE		Mercedes	
F-00480	2	0M	8,00		16,00		7,00	POM		Renault	
F-00481	2	0M	10,00		19,00		7,00	POM		Renault	
F-00482	2	12	32,00		45,00		8,00	DIS		Rover 3,4 Bulloni	
F-00483	2	0M	26,00		35,00		7,00	CRE	ZF	Alfa 33-Toyota Carina	originale/genuine
F-00484	2	1PM	19,00		29,00	4,40	6,30	DIS		Nissan Almera-Primera	
F-00485	2	6V2	25,00	37,80	41,24	4,40	7,30	CRE	TRW	Volvo ultimo tipo mondeo 2003	
F-00486	2	6V2	30,00	42,50	49,00	3,40	10,90	CRE	TRW	Ducato,Daily	maggiorato
F-00487	2	0M	28,00		37,70		5,00	DIS		Mondeo - Fiesta	
F-00488	2	6V2	25,00	38,70	45,00	6,00	10,00	CRE	TRW	Chrysler Voyager	
F-00489	2	12	25,00		34,00		5,00	CRE		Honda - Suzuki Gran Vitara	originale/genuine
F-00490	2	0M	26,00		37,00		7,00	CRE	ZF	Bmw	originale/genuine
F-00491	2	12	52,00		66,00		5,50	DIS		Mercedes LS6	albero uscita
F-00492	2	7V2	28,00		39,10		15,00	CRE	ZF	VW Transporter T5,Audi A4, Tuareg,Q7,Cayenne,	
F-00493	2	1PM	20,70		41,50	6,00	8,00	DIS		Ford Fiesta ultimo tipo,Fusion	originale/genuine alte temperature
F-00494	2	7V2	22,00		35,50		7,90	CRE		Ford Fiesta ultimo tipo,Fusion	
• F-00494X	2	7V1	21,50		35,50		7,50	CRE		Ford Fiesta ultimo tipo,Fusion	minorato
F-00495	2	0M	28,50		37,80		5,00	DIS		Ford Fiesta ultimo tipo	
F-00496	2	1PM	24,00		36,00	7,00	8,00	DIS		Nissan	
F-00497	2	4	22,00		34,50	7,00	12,00	CRE		Ford Fiesta ultimo tipo	con P.T.F.E.
• F-00497X	2	4	21,50		34,50	8,00	13,00	CRE		Ford Fiesta ultimo tipo	minorato con PTFE
F-00498	2	6V2	25,00	35,00	38,50	4,30	8,00	CRE	TRW	Porsche Boxter	
F-00499	2	7V2	23,00		38,20		8,00	CRE		Mazda MX5	
F-00500	2	0M	25,00		35,80		6,80	DIS		Toyota	
F-00501	2	7V1	26,00		44,20		8,60	CRE		Mitsubishi Galant	
F-00502	2	0M2	20,00		35,00		8,00	POM		Fiat Ducato	alte temperature
F-00503	2	1PM	17,46		28,58	5,80	6,30	POM		veicoli commerciali	
F-00504	2	0AM2	19,05		31,75		7,80	POM		veicoli commerciali	
F-00505	2	0M2	17,00		28,80		8,00	POM		veicoli commerciali	
F-00506	2	0M2	17,00		28,00		8,00	POM		veicoli commerciali	originale/genuine

**Paraoli**Seals
Сальники**in ordine di codice**sorted by code
сортировка по коду

CRE	Cremagliera	Rack	Гидроцилиндр
DIS	Distributore	Pignon	Распределитель
PIS	Pistone	Piston	Поршень
POM	Pompa	Pump	Насос
SCA	Scatola	Box	Корпус редуктора

Codice Code Код	Min Ord Мин. коли- чество заказа	Dis. Drawing Тип сальника	d1	d2	D	h1	H	Uso Use in Приме- нение	Marca Brand Произво- дитель агрегата	Tipo auto Vehicle type Тип авто	Note Remarks Примечания
F-00507	2	1PM	30,00		40,00		7,00	POM		veicoli commerciali	
F-00508	2	0M2	20,00		30,00		8,00	POM		veicoli commerciali	alte temperature
F-00509	2	0M2	25,00		35,00		7,00	POM		veicoli commerciali	
F-00510	2	0AM2	17,00		28,00		6,50	POM		veicoli commerciali	originale/genuine
F-00511	2	1PM	20,00		42,00		7,00	POM		veicoli commerciali	alte temperature
F-00512	2	7V1	22,00		38,20		8,00	CRE		Toyota Yaris	
F-00513	2	7V1A	22,00		38,50		8,00	CRE		Toyota Yaris	
F-00514	2	7V1	25,70		41,50		8,70	CRE		Toyota Celica 1999	
F-00515	2	7V2	24,00		41,10		8,50	CRE	ZF	Jaguar X TYPE	
F-00516	2	1PM	20,50		34,20	7,00	7,50	DIS		Toyota Celica	righe dx e sx
F-00517	2	1PM	18,00		30,00	7,00	8,00	DIS	ZF	Audi	
F-00518	2	7V2	25,00		43,00		8,00	CRE		Suzuki Gran Vitara	
F-00519	2	4PM	18,00		25,50	4,00	6,50	DIS		veicoli commerciali	
F-00520	2	4PM	26,00		34,00	4,50	7,70	DIS	ZF	veicoli commerciali	
F-00521	2	0	30,00		40,00		6,50	CRE		veicoli commerciali	alta pressione
F-00522	2	7V2	28,00		48,20		8,50	CRE		Mazda	
F-00523	2	6V3	14,00	30,50	38,40	5,00	11,00	CRE		Chrysler 300 M	
F-00524	2	7V1	25,50		39,50		8,50	CRE		Toyota Celica 1999	
F-00525	2	1PM	25,40		38,10		6,35	DIS		Daf Veicolo commer- ciale	
F-00526	2	1PM	22,30		32,20	5,40	6,50	DIS		Suzuki Baleno	
F-00527	2	7V1	25,00		38,50		10,00	CRE		Chrysler neon	
F-00528	2	1PM	22,23		35,15		9,50	DIS		veicoli commerciali	
F-00529	2	1A	19,05		33,33		8,00	POM		Mercedes	righe SX rotazione DX
F-00530	2	0M	25,00		36,00		5,00	DIS		Nissan Sanny,240SX,300ZX	
F-00531	2	1PM	20,60		41,30	6,50	8,00	DIS	TRW	Ford Fusion	alte temperature
F-00532	2	3G	16,50		55,00	7,50	9,00	DIS	ZF	Toyota Carina	parapolvere
F-00533	2	1PM	19,05		30,00	7,00	8,00	POM	LUK	Mercedes	righe SX rotazione DX
F-00534	2	7V2	25,00		41,50		7,50	CRE	TRW	Ford Mondeo ultimo tipo,Focus,	
F-00535	2	6V2	26,00	38,00	40,00	8,50	17,70	CRE		Citroen C5	
F-00536	2	8	19,05		35,00	6,00	8,00	DIS		Renault Master,Vauxhall Movano	
F-00537	2	7V3	30,00		42,10	15,00	17,00	CRE	ZF	Ducato, BMW Servo- tronic X5	con teflon esterno
F-00538	2	0AM2	17,00		28,00		6,50	POM			alte temperature
F-00539	2	7V2	30,00		42,00		8,00	CRE		Bmw X5	
F-00540	2	7V1	27,70		42,50		8,50	CRE		Mitsubishi Colt, Evo	
F-00541	2	7V2	26,00		38,10		8,00	CRE		Mercedes classe "C"	
F-00542	2	7V2	26,00		43,10		8,00	CRE		Mercedes classe "C"	
F-00543	2	7V1	24,00		38,20		8,50	CRE		Toyota Corolla	
F-00544	2	7V1	26,00		44,30		8,50	CRE		Honda	
F-00545	2	7V2	26,00		38,30		8,50	CRE		Honda	
F-00546	2	7V2	28,00		40,00		6,50	CRE	TRW	Porsche Boxster, Free- lander	
F-00547	2	7V2	21,00		34,00		9,00	CRE		Subaru Justy	
F-00548	2	1PM	28,00		40,00	5,50	7,50	DIS		Mercedes LS4	
F-00549	2	0M	52,00		66,00		5,50	DIS		Mercedes LS4	
F-00550	2	0A	52,00		68,00		6,00	DIS		Mercedes LS4	con righe interne

INFORMAZIONE TIP РЕКОМЕНДАЦИИ

I paraoli minorati sono identificati con la lettera finale «X»
Esempio F-00024: dimensioni normali - F-00024X: minorato
Reduced seals are identified with final letter «X»
Example F-00024: regular sizes - F-00024X: reduced seal
Сальники, обозначенные буквой «X», являются аналогами стандартных сальников с уменьшенным внутренним диаметром
Например: F-00024 - стандартный F-00024X - с уменьшенным внутренним диаметром



Codice Code Код	Min Ord Мин. колич- чество заказа	Dis. Drawing Тип сальника	d1	d2	D	h1	H	Uso Use in Приме- нение	Marca Brand Произво- дитель агрегата	Tipo auto Vehicle type Тип авто	Note Remarks Примечания
F-00551	2	7V2	45,00		59,00		5,50	DIS		Mercedes LS4	
F-00552	2	1PMA	38,00		50,00	8,00	9,50	DIS		Nissan Patrol GQ	
F-00553	2	12	38,00		47,70		6,50	DIS		Nissan Patrol GQ	a settore
F-00554	2	0M2	21,00		32,00		7,00	POM	LUK	Luk, Vichers	
F-00555	2	1PMA	16,00		30,00		6,25	POM		Ford Tempo	righe DX rotazione SX
F-00556	2	1PM	17,00		29,90		7,00	POM		Kayaba	righe SX rotazione DX
F-00557	2	3	18,50		43,00		4,50	DIS	TRW	VW Lupo,Skoda Octavia,eat Ibiza	parapolvere
F-00558	2	1PM	20,00		30,20	5,00	6,00	DIS		Mercedes, Toyota	
F-00559	2	7V2	56,00		70,00		5,50	DIS		Mercedes LS7	originale/genuine
F-00560	2	7V1	32,00		50,00		8,50	CRE		Mitsubishi Pajero	
F-00561	2	1PM	19,05		34,60	6,20	7,50	DIS	TRW	Opel Astra, Focus	
F-00562	2	1PM	20,00		35,60	6,00	7,70	DIS		Jeep Grand Cherokee	
F-00563	2	2G	45,00		60,50		6,30	DIS		Bendix, Transit	materiale speciale
F-00564	2	12	40,00		55,50		6,30	DIS		Bendix, Transit	materiale speciale
F-00565	2	0AM2	15,00		24,12		7,00	POM			
F-00566	2	8	17,00		43,00	3,30	3,80	DIS	TRW		
F-00567	2	1PM	32,00		44,60		10,00	DIS		Mitsubishi	
F-00568	2	0M	32,00		44,60		8,00	DIS		Mitsubishi, Cherokee	
F-00569	2	7V3	32,00		44,70	5,00	6,50	DIS		Jeep	
F-00570	2	2	40,00		55,00		9,50	DIS		Bendix	
F-00571	2	2	45,00		60,00		10,00	DIS		Bendix	
F-00572	2	2	50,00		65,00		10,00	DIS		Bendix	
F-00573	2	2	55,00		70,00		12,30	DIS		Bendix	
F-00574	2	1PM	10,00		21,00	7,00	7,30	POM	LUK	Luk	da abbinare a F-00575
F-00575	2	1PM	10,00		22,00	7,00	8,00	POM	LUK	Luk	da abbinare a F-00574
F-00576	2	1PM	20,60		35,63	6,30	7,50	DIS		Dodge	
F-00577	2	3	32,00		45,00		3,70	DIS		Jeep	parapolvere
F-00578	2	1PMA	16,00		35,00		13,00	POM		Opel Vectra-Motore Cavalier	alte temperature
F-00579	2	7V2	41,00		54,00		8,00	CRE		Pajero, Camion	
F-00580	2	8	41,00		54,00	1,30	3,50	SCA		Pajero, Camion	parapolvere
F-00581	2	7V1	32,00		52,40		10,00	CRE		Dodge	
F-00582	2	7V2	31,00		47,80		7,50	CRE		Ford Explorer	
F-00583	2	7V1A	26,00		41,40		8,50	CRE		Lexus	
F-00584	2	7V3	28,00		38,00	15,00	17,00	CRE	ZF	Ducato,Daily	
F-00585	2	7V3	30,00		49,70	10,00	13,00	CRE		GMC Chevy Trailblazer	
F-00586	2	1PMA	17,00		29,00		8,00	POM		Toyota Corolla	
F-00587	2	7V2	31,00		43,00		7,00	CRE	ZF	Bmw Serie 7	
F-00588	2	7V2	31,00		43,00		15,00	CRE	ZF	Bmw Serie 7	
F-00589	2	7V2	28,00		38,00		7,00	CRE		Audi A4	
F-00590	2	0M	23,30		37,50		5,50	DIS		Kia Rio	con inserto metallico inserto
F-00591	2	12	32,00		44,50		6,20	DIS		Tata	
F-00592	2	7V1	26,00		41,20		8,50	CRE		Geo Tracker	
F-00593	2	7V2	30,00		42,80		8,00	CRE		M,B 100,140 Minibus Main	
F-00594	2	0M	29,00		40,00		7,00	CRE		Modifica Transit rettificato	

CRE	Cremagliera	<i>Rack</i>	<i>Гидроцилиндр</i>
DIS	Distributore	<i>Pignon</i>	<i>Распределитель</i>
PIS	Pistone	<i>Piston</i>	<i>Поршень</i>
POM	Pompa	<i>Pump</i>	<i>Насос</i>
SCA	Scatola	<i>Box</i>	<i>Корпус редуктора</i>

Codice Code Код	Min Ord Мин. коли- чество заказа	Dis. Drawing Тип сальника	d1	d2	D	h1	H	Uso Use in Приме- нение	Marca Brand Произво- дитель агрегата	Tipo auto Vehicle type Тип авто	Note Remarks Примечания
F-00595	2	0A	32,00		45,00		4,50	DIS		Tata	
F-00596	2	0M	20,00		32,00		5,00	DIS		Tata	
F-00597	2	1PMA	15,00		28,00		7,00	POM		Subaru	
F-00598	2	0M2	25,00		35,00		8,00	POM			
F-00599	2	7V1	24,00		43,00		8,50	CRE		Nissan	
F-00600	2	1PM	19,00		32,00	6,00	7,00	DIS		Toyota-Mitsubishi	originale/genuine
F-00601	2	6V2MA	24,00	36,00	37,00	8,50	17,70	CRE		Peugeot 206	
F-00602	2	1PMA	19,00		31,90		8,00	POM			
F-00603	2	7V2	28,30		41,50		8,00	CRE			
F-00604	2	6V2	25,00	38,60	44,70		12,40	CRE			
F-00605	2	1PM	21,00		33,00	8,00	9,50	DIS		Mercedes	
F-00606	2	1PM	17,00		29,00	6,30	6,50	POM		Mitsubishi	
F-00607	2	1PM	19,05		30,20	5,00	7,30	DIS		Nissan	
F-00608	2	1PM2	11,75		22,00	6,00	8,50	POM		Cherokee, Voyager Diesel engine	originale/genuine
F-00609	2	1PM	20,00		35,00		7,00	DIS		Isuzu Trooper, Vauxall Montery	
F-00610	2	1PM	22,00		35,00		7,00	DIS		Nissan	
F-00611	2	0M	27,00		41,00		5,50	DIS		Honda	
F-00612	2	7V1	24,00		38,00		8,00	CRE		Honda CRV	
F-00613	2	6V2	25,00	33,00	37,50	6,00	7,00	CRE		Renault	originale/genuine replacement
F-00614	2	1PM	20,20		32,00		8,00	POM		Honda Accura	rotazione DX
F-00615	2	1PMA	25,00		35,00	6,80	8,00	POM	ZF		
F-00616	2	12	43,00		60,00		6,00	PIS	ZF	Iveco, Scania	tenuta pistone
F-00617	2	1PA	28,00		38,00	5,00	8,00	SCA		Iveco, Scania	parapolvere pistone
F-00618	2	1PA	32,00		45,00	7,00	10,00	SCA		Iveco, Scania	parapolvere pistone speciale
F-00619	2	1PM	19,00		30,00		6,50	POM			
F-00620	2	12	28,00		36,00		8,00	PIS		Camion-Veicoli commerciali, Iveco- Scania	pistone idraulico
F-00621	2	12	32,00		2,00		8,00	PIS		Camion-Veicoli commerciali, Iveco- Scania	pistone
F-00622	2	7V2	30,00		54,70		8,00	CRE		Mercedes Sprinter	
F-00623	2	12	32,00		45,00		10,50	DIS		Bendix, Transit	
F-00624	2	7V1	27,70		46,10		12,90	CRE	Koyo	Mitsubishi	
F-00625	2	3G	14,00	50,00	53,00	10,00	10,00	DIS			parapolvere
F-00626	2	3G	14,00	45,00	48,00	8,20	13,00	DIS			parapolvere
F-00627	2	1PM	18,00		34,60	6,20	7,50	DIS		Ford, Opel Astra, Ford Focus	minorato per pignoni rettificati
F-00628	2	12	40,00		55,00		11,00	DIS		veicoli commerciali	autocarri
F-00629	2	12	30,00		38,00		8,00	DIS		veicoli commerciali	autocarri
F-00630	2	12	46,00		56,00		10,00	DIS		veicoli commerciali	autocarri
F-00631	2	0M2	25,00		35,00		8,00	POM			
F-00632	2	1PM	18,00		30,10	5,50	6,00	DIS		Renault	alta temperatura
F-00633	2	0M	28,50		43,00		6,50	DIS		Renault Clio	
F-00634	2	12	70,00		85,00		12,00	PIS		Camion-veicoli pesanti	paraolio autolivellante
F-00635	2	12	70,00		78,00	4,00	7,00	PIS		veicoli commerciali	paraolio autolivellante
F-00636	2	8	83,00		90,00		6,10	SCA		veicoli commerciali	paraolio autolivellante
F-00637	2	8	83,00		90,00		6,10	SCA		veicoli commerciali	

INFORMAZIONE TIP РЕКОМЕНДАЦИИ

I paraoli minorati sono identificati con la lettera finale «X»
Esempio F-00024: dimensioni normali - F-00024X: minorato
Reduced seals are identified with final letter «X»
Example F-00024: regular sizes - F-00024X: reduced seal
Сальники, обозначенные буквой «X», являются аналогами стандартных сальников с уменьшенным внутренним диаметром
Например: F-00024 - стандартный F-00024X - с уменьшенным внутренним диаметром



Codice Code Код	Min Ord Мин. коли- чество заказа	Dis. Drawing Тип сальника	d1	d2	D	h1	H	Uso Use in Приме- нение	Marca Brand Произво- дитель агрегата	Tipo auto Vehicle type Тип авто	Note Remarks Примечания
F-00638	2	12	38,00		51,00		8,00	PIS		Land Rover Discovery MK2	
F-00639	2	7V2	52,00		66,00		5,50	CRE		Autocarro Mercedes	
F-00640	2	1PM	20,00		35,00	6,00	7,00	POM		Alfa 155, Cherokee, Astra	standard
F-00641	2	0MA	19,05		36,00		7,00	POM		Granada-Volvo-Tipo	righe SX rotazione DX
F-00642	2	6V2	23,00	34,30	38,20	5,00	8,20	CRE		Mazda	
F-00643	2	0M2	20,00		40,00		8,00	POM			alte temperature
F-00644	2	7V1PM	32,00		47,50	10,00	12,00	CRE		Cherokee ultimo tipo	
F-00645	2	3G	20,00		55,00	7,50	9,00	DIS		Bmw-Mini	parapolvere
F-00646	2	12	26,00		35,30		7,00	CRE			
F-00647	2	0M	38,00		52,60		6,40	DIS		Dodge RAM	
F-00648	2	1PM	18,00		30,00	7,00	7,50	DIS	ZF	Audi	
F-00649	2	12	25,00		39,00		6,50	DIS		Rolls Royce	
F-00650	2	1PM	9,00		19,05		7,30	POM	ZF	Bmw E46,316,318	fino a 120 bar
F-00651	2	7V1	24,00		35,20		8,50	CRE		Seat Ibiza Polo Lupo Felicia SMI	
F-00652	2	7V1	24,00		37,20		8,50	CRE		Seat Ibiza Polo Lupo Felicia SMI	
F-00653	2	7V2	25,00		37,90		6,50	CRE	TRW	Fiat Doblo	
F-00654	2	8	18,90		51,40	4,50	6,70	DIS	TRW	Fiat Doblo	parapolvere
F-00655	2	7V2	36,00		48,10		6,70	CRE		Mercedes	
F-00656	2	2	22,17		28,54		3,20	DIS	TRW		
F-00657	2	1PM	18,70		35,00	7,00	7,50	DIS		Mitsubishi	originale/genuine
F-00658	2	7V3	25,00		39,50	10,00	12,50	CRE	Saginaw	Fiat Fiorino, Opel Vectra "96.	alte temperature
F-00659	2	1PM	19,50		41,30	6,50	8,50	DIS	TRW	Ford Fusion	per albero minorato distributore (alte temperature)
F-00660	2	0	35,00		47,30		7,00	DIS		Tata Safari	
F-00661	2	7V3	25,00		42,60	10,00	12,50	CRE	Saginaw	Opel Vectra	
F-00662	2	7V2	28,00		39,98		6,35	CRE		Porsche Boxster, Freelander	
F-00663	2	1PM	20,00		30,00	5,00	6,00	DIS	ZF	Renault, Scorpio, Peugeot, Toyota	originale/genuine
F-00664	2	0M	35,00		45,00		7,00	DIS		Euroclass	
F-00665	2	1PM	35,00		45,00		7,00	DIS		Euroclass	
F-00666	2	1PM	20,00		30,00	7,00	8,00	DIS			
F-00667	2	0M	20,68		41,20		6,30	DIS		Mondeo, Fiesta	originale/genuine distributore sup.
F-00668	2	7V1	24,00		40,10		9,50	CRE		Honda Civic	
F-00669	2	7V1	25,00		41,10		9,50	CRE		Mazda 6	con labbro parapolvere
F-00670	2	7V1	22,00		35,30		8,60	CRE		Toyota Yaris	con P.T.F.E. interno
F-00671	2	7V1	27,00		46,10		9,50	CRE		Mazda Premacy	con labbro parapolvere
F-00672	2	7V1	22,00		38,40		8,60	CRE		Toyota Yaris	con PTFE interno
F-00673	2	0M	29,00		43,10		7,00	DIS		Hyundai, Lantra	originale/genuine
F-00674	2	0	38,00		50,90		5,00	DIS		Veicolo commerciale	parapolvere
F-00675	2	0M	26,00		37,00		6,30	DIS	TRW	Porsche E 911	
F-00676	2	12	32,00		41,50		6,50	DIS		Veicolo commerciale	

CRE	Cremagliera	<i>Rack</i>	<i>Гидроцилиндр</i>
DIS	Distributore	<i>Pignon</i>	<i>Распределитель</i>
PIS	Pistone	<i>Piston</i>	<i>Поршень</i>
POM	Pompa	<i>Pump</i>	<i>Насос</i>
SCA	Scatola	<i>Box</i>	<i>Корпус редуктора</i>

Codice Code Код	Min Ord Мин. коли- чество заказа	Dis. Drawing Тип сальника	d1	d2	D	h1	H	Uso Use in Приме- нение	Marca Brand Произво- дитель агрегата	Tipo auto Vehicle type Тип авто	Note Remarks Примечания
F-00677	2	1PMA	19,05		34,80	4,40	5,90	DIS	TRW	Golf	America
F-00678	2	6V2	32,00	44,10	46,80	12,90	18,70	CRE		Land Rover L30-MK3	
F-00679	2	0M	22,00		30,00		4,50	DIS		Rover 3,4 Bulloni	con tenuta esterna da Ø32,4
F-00680	2	1PM	22,00		32,00	5,00	6,00	DIS		Peugeot	originale/genuine distributore sup.
F-00681	2	1PM	20,00		30,00	5,00	5,20	DIS			originale/genuine distributore inf.
F-00682	2	0M	28,00		37,20		5,80	DIS		Bentley Arnage btm pinion seal	
F-00683	2	7V1	26,70		44,20		8,00	CRE		Toyota Lexus IS 300	
F-00684	2	7V2A	27,20		41,40		7,80	CRE		Sheppard	per albero Ø27
F-00685	2	12	35,00		42,00		3,70	DIS		Jaguar, Rover	
F-00686	2	0MA	16,00		36,00		6,60	POM			alte temperature righe SX rotazione DX (minorato)
F-00687	2	0MA	17,00		36,00		6,60	POM	Saginaw		
F-00688	2	1PM	19,05		34,60	4,40	5,90	DIS	TRW	Golf	originale/genuine alte temperature (America) righe SX rotazione DX
F-00689	2	1PMA	16,00		30,00		6,50	POM		Ford Mondeo	
F-00690	2	1PM	22,00		32,00		7,00	DIS			
F-00691	2	6V2	28,00		37,70	5,50	8,00	CRE	TRW	Ferrari	
F-00692	2	1PM	40,00		52,00	8,00	11,00	DIS		Mercedes	Distributore superiore, (BLU)
F-00693	2	0A	26,00		35,00		11,00	DIS		Daf	
F-00694	2	7V1A	26,00		39,80		8,40	CRE		Celica	originale/genuine
F-00695	2	7V1	26,00		41,80		8,50	CRE		Celica	
F-00696	2	0M	25,00		35,10		6,00	DIS		Celica	righe DX e SX
F-00697	2	7V1PM	27,70		44,10	13,00	14,00	CRE	Mando	Hyundai Sonata	
F-00697A	2	2	27,70		38,30		4,00	CRE		Hyundai Sonata	raschiatore Ø27,7 da abbinare al paraolio F-00697 -F- 00798
F-00698	2	7V1	27,70		40,10		8,50	CRE		Hyundai Sonata	
F-00699	2	3A	18,00		35,70		3,90	DIS			parapolvere
F-00700	2	12	28,00		37,50		7,80	PIS		Autocarro	per pistone 3° asse autocarro
F-00701	2	12	52,00		60,00		6,00	PIS		Autocarro	per pistone 3° asse autocarro
F-00702	2	1PM	11,00		25,00	6,40	6,40	POM	Koyo	Touareg	abbinare al paraolio F-00703
F-00703	2	0M2	20,00		34,00		8,00	POM	Koyo	Isuzu - Touareg- Mit-subishi-Kayaba	abbinare al paraolio F-00702
F-00704	2	7V1	30,00		42,00		15,00	CRE	ZF	Ducato - Bmw Servo-tronic X5	
F-00705	2	7V2	24,00		37,10		15,00	CRE	ZF		con P.T.F.E.
F-00706	2	6V3	28,00	43,00	47,70	5,00	11,70	CRE		Nissan Quest, Mercury Villager 93-94	
F-00707	2	0M	16,00		24,00		6,00	POM			
F-00708	2	4PM	22,00		32,00	5,20	8,00	DIS		Mercedes	
F-00709	2	7V1	28,00		43,00		9,00	CRE		Mitsubishi Evo X	
F-00710	2	4	28,50		38,00	3,50	8,00	DIS			
F-00711	2	0M	24,40		35,00		6,00	DIS			

INFORMAZIONE TIP РЕКОМЕНДАЦИИ

I paraoli minorati sono identificati con la lettera finale «X»
Esempio F-00024: dimensioni normali - F-00024X: minorato
Reduced seals are identified with final letter «X»
Example F-00024: regular sizes - F-00024X: reduced seal
Сальники, обозначенные буквой «X», являются аналогами стандартных сальников с уменьшенным внутренним диаметром
Например: F-00024 - стандартный F-00024X - с уменьшенным внутренним диаметром



Codice Code Код	Min Ord Мин. коли- чество заказа	Dis. Drawing Тип сальника	d1	d2	D	h1	H	Uso Use in Приме- нение	Marca Brand Произво- дитель агрегата	Tipo auto Vehicle type Тип авто	Note Remarks Примечания
F-00712	2	7V1	24,00		44,30		9,50	CRE			
F-00713	2	7V2	25,00		37,10		9,00	CRE			
F-00714	2	7V1	25,00		43,20		9,00	CRE			
F-00715	2	2	38,00		51,00		5,00	DIS		Land Rover	
F-00716	2	7V1	24,00		38,20		7,00	CRE		Saab 9.35	
F-00717	2	7V2	24,00		39,50		7,00	CRE		Saab 9,35	
F-00718	2	7V1	30,00		50,00		10,00	CRE		Mercedes Vito	
F-00719	2	7V1	30,00		47,00		8,50	CRE		Mercedes Vito	
F-00720	2	0M	20,68		41,20		6,30	DIS		Ford Mondeo, Fiesta	originale/genuine distributore sup.
F-00721	2	1PM	25,00		37,00	6,00	6,50	DIS	ZF-LUK		
F-00722	2	2	38,00		51,00		5,00	DIS		Land Rover U.T. UK	originale/genuine distributore inf. - tappo distributore inf.
F-00723	2	spec.			22,00		5,50	DIS	ZF		
F-00724	2	4	25,00		35,20	3,50	7,60	DIS			
F-00725	2	7V3	30,00		45,50	10,00	12,70	CRE			
F-00726	2	7V2	12,00		38,20		10,00	CRE			
F-00727	2	6V2	30,00		40,00	4,00	6,50	CRE			
F-00728	2	1PA	20,00		41,00		6,50	DIS		Mondeo Ultimo tipo	
F-00729	2	7V1	28,00		47,90		10,00	CRE	TRW		
F-00730	2	0	24,50		31,00		4,50	DIS		Ford	distributore inf.
F-00731	2	0M2	25,00		40,00		8,00	POM	ZF		doppia molla
F-00732	2	1PM	14,00		23,00		7,00	POM		Mercedes CK 500	
F-00733	2	1PM	14,00		24,00		7,00	POM		Mercedes CK 500	
F-00734	2	4A	27,70		39,60	13,50	17,20	CRE	Smi-Koyo	Peugeot 407	con PTFE interno
F-00735	2	7V1	27,70		39,60		20,25	CRE	Smi-Koyo	Peugeot 407	
F-00736	2	0M2	20,00		36,00		8,00	POM		Mazda	doppio labbro nuovo mod. maggiorato, rigato esternamente originale/genuine
F-00737	2	7V2	32,00		44,60		6,50	CRE	TRW	Mercedes Vito Sprinter, Ducato U.T.	
F-00738	2	6V2	24,00	35,20	39,00	9,00	13,90	CRE		VW PQ35	
F-00739	2	6V1	23,00		32,50	5,50	7,50	CRE	TRW	Skoda, VW Polo U.T.	
F-00740	2	1PM	19,00		30,00	5,50	6,00	DIS		Nissan, Renault	originale/genuine
F-00741	2	1PMA	18,00		32,10	8,00	8,50	POM			
F-00742	2	0M	32,70		42,70		6,70	DIS		Toyota Landcruiser J 120	
F-00743	2	7V1	28,00		41,20		8,00	CRE		Kia Karnival II	
F-00744	2	1PMA	15,00		28,10	6,20	6,30	POM	ZF	Opel Vectra	alte temperature
F-00745	2	7V1	32,00		52,20		10,00	CRE		Dodge Ram Serie 1500	
F-00746	2	0	22,00	28,50	28,50	4,00	4,00	DIS			distributore inf. distributore inf. - con inserto metallico inserito distributore sup. originale/genuine
F-00747	2	0M	28,00		42,00		6,00	DIS		Mitsubishi Diamante	
F-00748	2	1PM	22,20		31,90	6,00	7,50	DIS		Mitsubishi Diamante	
F-00749	2	7V1	28,00		40,10		8,00	CRE		Mitsubishi Diamante	
F-00750	2	7V1	28,00		46,20		9,00	CRE		Mitsubishi Diamante	
F-00751	2	7V1PM	27,70		46,00	9,00	10,00	CRE	Mando	Hyundai Tucson	
F-00752	2	7V2	28,00		46,00		8,50	CRE			
F-00753	2	1PM	30,00		42,00	8,00	8,00	DIS			distributore sup.
F-00754	2	7V2A	28,00		39,00		15,00	CRE	ZF		
F-00755	2	7V2	30,00		50,00		10,00	CRE			
F-00756	2	7V2	30,00		47,00		8,50	CRE			

**Paraoli**Seals
Сальники**in ordine di codice**sorted by code
сортировка по коду**CRE**
DIS
PIS
POM
SCACremagliera
Distributore
Pistone
Pompa
ScatolaRack
Pignon
Piston
Pump
BoxГидроцилиндр
Распределитель
Поршень
Насос
Корпус редуктора

Codice Code Код	Min Ord Мин. коли- чество заказа	Dis. Drawing Тип сальника	d1	d2	D	h1	H	Uso Use in Приме- нение	Marca Brand Произво- дитель агрегата	Tipo auto Vehicle type Тип авто	Note Remarks Примечания
F-00757	2	0M	35,00		58,00		10,00	DIS		Mazda	
F-00758	2	0M	23,35		29,80		4,50	DIS	TRW	Bmw Z3, Mazda	distributore inf. alta temperatura
F-00759	2	1PM	22,20		32,00	5,00	6,00	DIS		Peugeot 505, Citroen	originale/genuine
F-00759M	2	1PM	22,20		32,00	5,00	6,00	DIS		Peugeot 505, Citroen	
F-00760	2	1PM	15,00		25,00		5,50	POM	LUK	Bmw LUK	
F-00761	2	1PM	20,00		42,30	7,00	9,30	DIS	TRW	Mazda	distributore sup. originale/genuine
F-00762	2	6V2	30,00	42,50	49,50	3,40	10,90	CRE	TRW	Ducato, Iveco, Daily	distributore sup. originale/genuine alte temperature
F-00763	2	7V2	23,50		33,60		6,00	CRE			
F-00764	2	6V2	24,97	37,80	41,30	3,00	7,40	CRE	TRW	Fiat Croma-Thema	originale/genuine
F-00765	2	7V1	27,70		38,00		7,50	CRE		Renault	originale/genuine alte temperature
F-00766	2	7V1	27,70		45,00		7,50	CRE		Renault	originale/genuine alte temperature
F-00767	2	1PM	15,00		25,00	7,00	7,00	DIS		Toyota starlet	distributore sup.
F-00768	2	1PM	18,00		32,00	4,30	7,00	DIS		Renault Traffic	distributore sup.
F-00769	2	1PM	19,00		30,00	7,00	7,00	DIS		Ford Transit	distributore sup.
F-00770	2	0	14,00		22,00		4,00	DIS		Mini	distributore inf.
F-00771	2	1PM	18,00		30,00	7,00	7,00	DIS	ZF	Ford Transit	distributore sup.
F-00772	2	1P	17,00		40,00	4,60	6,20	DIS		Vauxhall Nova	parapolvere distributore sup.
F-00773	2	1P	15,00		22,00	4,00	4,00	DIS		Ford Sierra	parapolvere distributore sup.
F-00774	2	0M	19,00		32,00		8,00	DIS		MGB	distributore inf.
F-00775	2	1PM	17,00		25,00	4,00	4,00	DIS		Vauxhall Cavalier, Astra	distributore sup.
F-00776	2	0M	15,00		30,00		7,00	DIS		TVR	distributore inf.
F-00777	2	0	14,20		24,40		5,00	DIS		Burman (taxi)	distributore inf.
F-00778	2	0M2	21,00		35,00		8,00	POM			
F-00779	2	1PM	19,00		32,00	6,00	7,00	DIS		Hyundai Atos	originale/genuine
F-00780	2	7V1	26,00		45,50		8,50	CRE		Mercedes	
F-00781	2	1PM	18,00		30,00	5,50	6,00	DIS		Renault	originale/genuine
F-00782	2	1PM	18,00		30,00	6,00	6,50	DIS			originale/genuine
F-00783	2	7V1	24,00		35,10		8,50	CRE		Seat Ibiza Polo Lupo Felicia SMI	originale/genuine
F-00784	2	1PM	52,00		85,00	9,50	14,43				
F-00785	2	1PMA	28,00		40,00	7,60	7,60	DIS			
F-00786	2	1PM	29,00		39,00	5,50	6,00	DIS		Nissan	
F-00787	2	1PM	17,00		35,00	7,00	7,00	DIS			distributore sup.
F-00788	2	0M	25,00		47,00		7,00	DIS			distributore inf.
F-00789	2	1PM	8,00		18,00	7,00	7,00	POM			
F-00790	2	0M	12,00		24,00		6,00	DIS			distributore inf.
F-00791	2	1PM	12,00		24,00	7,00	7,50	DIS			distributore sup.
F-00792	2	1PM	14,00		24,00	7,00	7,50	DIS			distributore sup.
F-00793	2	1PM	32,00		45,00	7,00	7,50	DIS			originale/genuine
F-00794	2	0M2	15,00		24,00		7,00	POM			
F-00795	2	0	28,00		35,00		4,00	DIS			
F-00796	2	7V1	22,00		34,20		8,00	CRE		Daihatsu	
F-00797	2	7V1	22,00		38,40		8,00	CRE		Daihatsu	
F-00798	2	7V1	27,70		42,00		13,00	CRE			da abbinare al raschiatore F- 00697A

INFORMAZIONE TIP РЕКОМЕНДАЦИИ

I paraoli minorati sono identificati con la lettera finale «X»
Esempio F-00024: dimensioni normali - F-00024X: minorato
Reduced seals are identified with final letter «X»
Example F-00024: regular sizes - F-00024X: reduced seal
Сальники, обозначенные буквой «X», являются аналогами стандартных сальников с уменьшенным внутренним диаметром
Например: F-00024 - стандартный F-00024X - с уменьшенным внутренним диаметром



Codice Code Код	Min Ord Мин. коли- чество заказа	Dis. Drawing Тип сальника	d1	d2	D	h1	H	Uso Use in Приме- нение	Marca Brand Произво- дитель агрегата	Tipo auto Vehicle type Тип авто	Note Remarks Примечания
F-00799	2	1PM	18,75		37,50	5,50	8,00	DIS		Honda Civic	
F-00800	2	7V1	30,00		44,20		8,50	CRE		Toyota Tacoma	
F-00801	2	7V1	30,00		48,20		8,50	CRE		Toyota Tacoma	
F-00802	2	6V2	32,00	38,00	42,00	4,00	6,30	CRE		Chevy	
F-00803	2	7V3	32,00		47,50	10,00	12,70	CRE		Chevy	
F-00804	2	7V2	41,00		57,50		9,00	CRE		Ford	
F-00805	2	3	41,00		58,00		3,60	DIS		Ford	parapolvere
F-00806	2	7V1PM	22,00		35,00	9,00	10,00	CRE	Mando	Hyundai Atos 2001	
F-00807	2	7V1PM	22,00		38,20	13,00	14,00	CRE	Mando	Hyundai Atos 2001	
F-00807A	2	2	22,00		33,80		4,00	CRE		Hyundai Atos-	raschiatore Ø22 da abbinare al paraolio F-00807
F-00808	2	7V1PM	25,00		45,10	10,00	11,50	CRE		Dodge Caravan	
F-00809	2	7V1PM	27,70		40,00	9,00	10,00	CRE	Mando	Hyundai Santa Fe	
F-00810	2	7V1PM	27,70		48,00	9,00	10,00	CRE	Mando	Hyundai Santa Fe	
F-00811	2	0MA	27,00		38,00		6,50	DIS		Nissan Maxima-Almera Tino	Nissan Maxima - Nissan Altima '04-'06, Almera Tino
F-00812	2	7V1PM	26,00		38,10	9,00	10,00	CRE	Mando	Hyundai Elantra,Lantra	
F-00813	2	7V1PM	26,00		44,10	9,00	10,00	CRE	Mando	Hyundai Elantra,Lantra	
F-00814	2	7V1	28,00		41,00		8,00	CRE		Kia Sedona 2005	originale/genuine
F-00815	2	8	20,50		46,00	3,30	5,00	DIS		Ford C-Max	parapolvere
F-00816	2	7V1	28,00		44,80		9,00	CRE	TRW	Pontiac GTO 2004	originale/genuine
F-00817	2	0M	27,75		37,30		6,50	DIS		Pontiac GTO 2004	distributore inf.
F-00818	2	7V1	24,00		42,60		8,50	CRE	TRW	Honda Accord V6 2003,05	
F-00819	2	0M2	25,00		40,00		8,00	POM	ZF		doppia molla alta temperatura
F-00820	2	1PM	23,50		32,50	5,00	5,30	DIS		Nissan Pathfinder,Navara	distributore inf.
F-00821	2	7V1	27,00		40,20		8,50	CRE		Toyota Camry	
F-00822	2	12	35,00		50,00		10,00			Omai Falcon	
F-00823	2	0M	24,00		37,00		5,00	DIS		Bmw	distributore inf. BMW
F-00824	2	7V2	25,00		44,70		8,40	CRE		Lincoln	
F-00825	2	7V1	27,00		46,20		8,50	CRE		Toyota Highlander	
F-00826	2	7V1	26,00		50,00		8,50	CRE		Nissan Murano	
F-00827	2	7V1	32,00		53,00		8,50	CRE		Nissan Infiniti	Cremagliera Nissan Infiniti
F-00828	2	12	35,00		50,00		9,00				
F-00829	2	7V1	24,00		38,10		7,00	CRE		Saab 9.3	originale/genuine
F-00830	2	7V1	24,00		37,10		8,50	CRE		Seat Ibiza Polo Lupo Felicia SMI	originale/genuine
F-00831	2	7V1	24,00		35,20		8,50	CRE		Mitsubishi	originale/genuine
F-00832	2	7V1	26,00		45,10		8,50	CRE		Nissan	originale/genuine
F-00833	2	7V1	24,00		36,60		8,50	CRE		Hyundai	
F-00834	2	1PM	22,22		40,60	6,00	7,50	DIS	TRW		right DX E SX
F-00835	2	1PMA	28,00		38,40		7,50	DIS		Suzuki-Mazda 3	originale/genuine
F-00836	2	0MA	28,00		43,00		10,00	POM		Fiat Iveco Vaz-Lada	standard
F-00837	2	1PM	23,50		32,70	5,00	5,35	DIS		Nissan	originale/genuine
F-00838	2	7V3	27,00		45,50	10,00	12,70	CRE		Chevrolet	originale/genuine

**Paraoli**Seals
Сальники**in ordine di codice**sorted by code
сортировка по коду

CRE	Cremagliera	Rack	Гидроцилиндр
DIS	Distributore	Pignon	Распределитель
PIS	Pistone	Piston	Поршень
POM	Pompa	Pump	Насос
SCA	Scatola	Box	Корпус редуктора

Codice Code Код	Min Ord Мин. коли- чество заказа	Dis. Drawing Тип сальника	d1	d2	D	h1	H	Uso Use in Приме- нение	Marca Brand Произво- дитель агрегата	Tipo auto Vehicle type Тип авто	Note Remarks Примечания
F-00839	2	7V2	27,00		40,10		6,80	CRE		Chevrolet	originale/genuine
F-00840	2	1PM	20,00		34,10	6,00	7,00	DIS	Mando	Jeep	
F-00841	2	7V1PM	30,00		48,10	9,00	10,00	CRE	Mando	Jeep	
F-00842	2	7V2	28,00		40,60		7,50	CRE		Ford	
F-00843	2	7V2	28,00		44,60		7,50	CRE		Ford	
F-00844	2	7V1	25,00		37,70		8,00	CRE		Kia	originale/genuine
F-00845	2	7V3	25,00		43,10	10,00	12,60	CRE		Chevrolet Malibu, Pontiac, Saturn	
F-00846	2	7V2	25,00		43,00		10,00	CRE		Chevrolet Malibu, Pontiac, Saturn	
F-00847	2	7V1PM	27,70		44,10	9,00	10,00	CRE	Smi-Koyo	Hyundai Sonata	
F-00848	2	3G	15,00		52,00		7,00			Renault Master	parapolvere
F-00849	2	1PM	19,00		34,70	6,30	7,00	DIS		Kia	distributore originale/genuine
F-00850	2	0M	30,00		43,00		6,00	DIS		Dodge	distributore inferiore originale/genuine
F-00851	2	12	19,00		31,00		5,00			Peugeot	
F-00852	2	1PM	10,00		21,00	7,00	7,30	POM	LUK	Luk	abbinare a F-00853
F-00853	2	1PM	10,00		22,00	7,00	8,00	POM	LUK	LUK	abbinare a F-00852
F-00854	2	4PM	26,00		34,00	6,70	7,70		ZF		originale/genuine
F-00855	2	1PMA	18,00		30,00	7,00	7,00	DIS			originale/genuine
F-00856	2	7V1PM	35,00		47,00	7,30	8,30			Jeep Wrangler	
F-00857	2	7V1	32,00		56,00		9,00	CRE		Nissan	
F-00858	2	0M	17,00		40,00		7,00				standard
F-00859	2	4	26,50		37,00	3,50	7,00	DIS	Saginaw	Opel Antara, costruzione Corea	
F-00860	2	7V1PM	25,00		45,10	10,00	11,50	CRE		Dodge Caravan	
F-00861	2	1P	15,00		22,00	4,00	4,50	DIS			originale/genuine
F-00862	2	1P	17,00		30,50	4,00	4,50	DIS			originale/genuine
F-00863	2	1P	19,00		26,00	4,00	4,50	DIS			originale/genuine
F-00864	2	3	17,00		43,00		3,50	DIS			originale/genuine
F-00865	2	0	23,00		29,70		4,00	DIS		Sierra, Thema, Ducato	originale/genuine
F-00866	2	12	32,00		42,00		7,00	CRE			
F-00867	2	0M2	22,00		40,30		7,00	POM		Bosch	pompa Bosch
F-00868	2	1PM	19,05		34,60	6,30	9,00	DIS		Fiat Tipo, Croma, Thema, Ford, Volvo	originale/genuine alta temperatura
F-00869	2	7V1	28,00		44,00		7,50	CRE		Ford S.Max	
F-00870	2	1PM	12,00		22,00	6,00	6,50	POM			originale/genuine
F-00871	2	7V1PM	27,70		42,10	9,00	10,00	CRE	Mando	Santa Fè	
F-00872	2	7V1PM	27,70		46,00	13,00	14,00	CRE	Mando	Santa Fè	
F-00873	2	12	38,00		48,00		8,00			Scania	
F-00874	2	1PM	8,00		22,00	7,00	7,50	POM		Mercedes Classe "A"	sotto piastra Mercedes classe A -
F-00875	2	1PM	17,45		28,58		6,30	POM			
F-00876	2	12	31,70	47,80	47,80		8,50			Nissan Fusu	in gomma forma ad U
F-00877	2	7V2	27,00		41,20		8,50	CRE		Toyota	
F-00878	2	7V2	24,00		41,20		8,50	CRE		Toyota Corolla	
F-00879	2	1PMA	18,00		31,80		6,30	POM		Ford Taurus	Righe SX rotazione DX
F-00880	2	7V1	32,00		44,50		8,50	CRE		Mercedes	

INFORMAZIONE TIP РЕКОМЕНДАЦИИ

I paraoli minorati sono identificati con la lettera finale «X»
Esempio F-00024: dimensioni normali - F-00024X: minorato
Reduced seals are identified with final letter «X»
Example F-00024: regular sizes - F-00024X: reduced seal
Сальники, обозначенные буквой «X», являются аналогами стандартных сальников с уменьшенным внутренним диаметром
Например: F-00024 - стандартный F-00024X - с уменьшенным внутренним диаметром



Codice Code Код	Min Ord Мин. коли- чество заказа	Dis. Drawing Тип сальника	d1	d2	D	h1	H	Uso Use in Приме- нение	Marca Brand Произво- дитель агрегата	Tipo auto Vehicle type Тип авто	Note Remarks Примечания
● F-00881	2	7V1	26,00		46,00		8,50	CRE		Fiat Scudo U.T.	
● F-00882	2	12	20,00		32,00		7,50			Cherokee	
● F-00883	2	1PM	18,00		32,00	6,00	6,00				Righe SX rotazione DX
● F-00884	2	1PM	20,00		30,10	7,00	7,50				
● F-00885	2	12	10,00		16,00		4,00				
● F-00886	2	1PM	19,00		37,00	6,50	9,00	DIS		Mitsubishi, Toyota, Audi A4	
● F-00887	2	1PM	20,00		30,00	5,00	5,20	DIS			originale/genuine
● F-00888	2	0M	24,40		35,00		6,00	DIS			
● F-00889	2	0M	22,00		35,00		6,50	DIS		A&A	originale/genuine
● F-00890	2	1PM	22,00		32,00	5,00	6,00	DIS		Peugeot	originale/genuine
● F-00891	2	0MA	20,00		32,00		5,00	DIS		Tata	originale/genuine
● F-00892	2	0	38,00		50,90		5,00	DIS		Veicolo commerciale	Parapolvere
● F-00893	2	0M	22,00		30,00		4,50	DIS		Rover 3,4 Bulloni	con tenuta esterna da Ø32,4
● F-00894	2	1PMA	16,00		30,00	6,30	6,50	POM		Ford Mondeo	originale/genuine- righe SX rotazione DX
● F-00895	2	1PMA	19,05		34,80	4,40	5,90	DIS	TRW	Golf	originale/genuine
● F-00896	2	1PM	15,00		35,50	5,50	6,00	DIS		Honda, Rover	originale/genuine
● F-00897	2	1P	15,00		22,00	4,00	4,00	DIS		Ford Sierra	parapolvere dis- tributore sup.
● F-00898	2	1PM	22,23		35,15	9,50	9,50	DIS		veicoli commerciali	originale/genuine
● F-00899	2	7V1PM	27,70		44,10	13,00	14,00	CRE	Mando	Hyundai Sonata	originale/genuine
● F-00899A	2	2	27,70		40,00		3,80	CRE		Hyundai Sonata	raschiatore Ø27,7 da abbinare al paraolio F-00899
● F-00900	2	7V1PM	27,70		40,20	9,00	10,00	CRE	Mando	Hyundai Santa Fe	originale/genuine
● F-00901	2	7V2	22,80		33,50		6,00	CRE	TRW	Kirby	
● F-00902	2	7V1	32,00		50,00		9,00	CRE		LDV Maxus	originale/genuine
● F-00903	2	0M	31,75		41,30		6,50	DIS	TRW	Kirby	Distributore inf. originale/genuine
● F-00904	2	1PM	19,00		27,20	5,00	5,00	DIS		Tata	Distributore superiore, originale/genuine
● F-00905	2	12	31,75		44,45		6,35	DIS		Rover	Distributore Rover
● F-00906	2	12	38,10		50,80		7,90				
● F-00907	2	0M	28,00		37,30		6,50	DIS		Pontiac GTO 2004	distributore inf. originale/genuine
● F-00908	2	0M	33,50		46,10		7,30	DIS		Ford, Limusine	
● F-00909	2	1PM	8,00		16,00	7,00	7,00	POM		Mercedes Classe A	Mercedes Classe A
● F-00910	2	7V1	31,00		52,00		8,00	CRE		Ford Expedition	Ford Expedition, F150
● F-00911	2	6V2	24,97	37,80	41,30	3,30	7,50	CRE	TRW	Dodge, Jeep 2007-08	originale/genuine
● F-00912	2	0M2	21,00		35,00		7,00	POM			Pompa LUK
● F-00913	2	12	31,75		41,25		6,35				
● F-00914	2	7V1	27,70		42,00		8,50	CRE		Mitsubishi	originale/genuine
● F-00915	2	1PM	19,05		37,00	6,50	7,50	DIS		Saang Yong Musso	
● F-00916	2	0M	23,00		35,00		6,50	DIS		Ssangyong	
● F-00917	2	7V1	24,00		41,20		8,50	CRE		Opel Astra H	
● F-00918	2	1PM	22,00		40,00		7,00	POM		Umm Jabata	
● F-00919	2	7V2	24,00		44,00	1,60	20,50	CRE	ZF	Audi Q5/ B8/ A6	

**Paraoli**Seals
Сальники**in ordine di codice**sorted by code
сортировка по коду

CRE	Cremagliera	Rack	Гидроцилиндр
DIS	Distributore	Pignon	Распределитель
PIS	Pistone	Piston	Поршень
POM	Pompa	Pump	Насос
SCA	Scatola	Box	Корпус редуктора

Codice Code Код	Min Ord Мин. коли- чество заказа	Dis. Drawing Тип сальника	d1	d2	D	h1	H	Uso Use in Приме- нение	Marca Brand Произво- дитель агрегата	Tipo auto Vehicle type Тип авто	Note Remarks Примечания
● F-00920	2	0M2	20,00		40,00		8,00	POM	LUK	Luk	Luk
● F-00921	2	1P	18,50		40,00	5,00	5,00			Mazda 3	parapolvere Mazda
● F-00922	2	7V1	26,70		44,20		8,50	CRE		Lexus	
● F-00923	2	7V1	26,00		38,10		8,50	CRE		Mitsubishi Galant	
● F-00924	2	0	18,00		24,00		3,00	DIS			Distributore inferiore
● F-00925	2	1PM	40,00		52,00	8,00	11,00	DIS		Mercedes	Distributore superiore, (NERO)
● F-00926	2	7V1	23,00		41,20		8,50	CRE		Subaru	Cremagliera Subaru Forester
● F-00927	2	1PM	24,00		32,50	5,40	5,45	DIS		Nissan Murano	
● F-00928	2	1PM	15,00		24,00	6,00	6,20	DIS		Ford Transit	distributore superiore
● F-00929	2	12	22,00		31,00		5,50	CRE		Honda	
● F-00930	2	7V1	26,00		47,00		8,50	CRE		Nissan Serena,N. Murano 3.6 v6 2005	Nissan Serena,N. Murano 3.6 v6 2005
● F-00931	2	7V1	27,00		47,00		9,00	CRE		Nissan Avensis	Cremagliera Nissan Avensis
● F-00932	2	7V2	31,00		44,60		8,50	CRE			Cremagliera
● F-00933	2	7V2	23,50		37,00		8,50	DIS			
● F-00934	2	7V1	26,00		42,00		8,00	CRE		Subaru Legacy	Cremagliera Subaru Legacy
● F-00935	2	7V1	25,00		40,00		9,00	CRE		Nissan Almera Classic 2006	Cremagliera Nissan Almera Classic
● F-00936	2	7V2	23,00		33,50		6,00	CRE		Ford	
● F-00937	2	1PM	27,50		38,00	5,00	5,20	DIS		Nissan Infinity G35	Nissan Infinity G35
● F-00938	2	1PM	22,00		32,30	5,00	5,20	DIS		Subaru Forester	Distributore superiore
● F-00939	2	7V1	35,00		53,00		8,50	CRE		Lexus RX 470	Cremagliera Lexus RX 470
● F-00940	2	7V1	27,70		44,00		8,00	CRE		Hyundai Sonata 5	Cremagliera Hyundai Sonata 5
● F-00941	2	7V1	24,00		50,00		9,00	CRE		Nissan Murano	originale/genuine
● F-00942	2	0MA	7,76		21,00		6,00				
● F-00943	2	6V2	28,00		40,00	4,00	6,00	CRE		Mitsubishi Diamante	Mitsubishi Diamante
● F-00944	2	1PMA	28,00		35,00		5,00			F.Transit	
● F-00945	2	12	20,00		31,00		5,00			VW Transporter	parapolvere VW Transporter
● F-00946	2	1PM	16,00		26,00		7,00	POM			
● F-00947	2	1PM	16,00		27,00		7,00	POM			
● F-00948	2	7V1PM	22,00		35,10	9,00	10,00	CRE	Mando	Hyundai Atos 2001	originale/genuine
● F-00949	2	7V1PM	22,00		38,20	13,00	14,00	CRE	Mando	Hyundai Atos 2001	originale/genuine
● F-00950	2	7V1PM	27,70		42,10	9,00	10,00	CRE	Mando	Santa Fè	originale/genuine
● F-00951	2	7V1PM	27,70		46,10	13,00	14,00	CRE	Mando	Santa Fè	originale/genuine
● F-00952	2	7V1	26,00		43,00		8,00	CRE		Nissan	
● F-00953	2	1PM	10,00		22,00	6,00	6,50	POM		Mini	
● F-00954	2	1PMA	28,00		39,50	8,00	8,00	DIS			
● F-00955	2	12	49,00		62,00		3,50	DIS			
● F-00956	2	3A	31,00		46,70		3,90	DIS		Ford	parapolvere
● F-00957	2	8	32,00		46,10		5,80	DIS		Ford,Lincoln,Mercury	
● F-00958	2	1PM	10,00		22,00		6,00	POM			alta temperatura
● F-00959	2	1PM	18,00		32,00	6,00	7,00	DIS			originale/genuine, alta temperatura

Gli articoli identificati con l'iniziale «CT» (codice temporaneo) sono attualmente in fase di test e prossimi all'introduzione definitiva nel mercato.

Items whose code starts with «CT» (temporary code) are currently being tested and they are candidate to be introduced in the market soon.
Пункты, обозначенные аббревиатурой «СТ» (временный код), в данный момент проходят испытания и будут представлены на рынок в ближайшее время.



Codice Code Код	Min Ord Мин. коли- чество заказа	Dis. Drawing Тип сальника	d1	d2	D	h1	H	Uso Use in Приме- нение	Marca Brand Произво- дитель агрегата	Tipo auto Vehicle type Тип авто	Note Remarks Примечания
● F-00960	2	7V1	27,70		42,00		8,50	CRE		Mitsubishi	
● F-00961	2	7V1	28,00		42,00		8,50	CRE			
● F-00962	2	7V1	27,70		42,20		7,50	CRE	Koyo	Renault, Nissan	
● F-00963	2	1PM	9,00		22,00		7,00	POM		Mercedes o Volvo	Pompa ZF
● F-00964	2	1PM	9,00		23,00	7,00	8,00	POM	ZF	Mercedes o Volvo	Pompa ZF
● F-00965	2	7V1PM	24,00		42,50	9,00	10,00	CRE		Hyundai Jeez/Accent 2000-05	
● F-00966	2	7V1PM	24,00		36,50	9,00	10,00	CRE		Hyundai Jeez/Accent 2000-05	
● F-00967	2	0MA	17,00		28,70		6,50	POM			
● F-00968	2	1PMA	16,00		25,50	8,00	9,00	DIS			
● F-00969	2	0M2	22,00		35,00		7,00				
● F-00970	2	7V1	27,70		50,10		9,00			Hyundai 2006 Kia Carnival	
● F-00971	2	0M	20,00		27,00		4,76	DIS			
● F-00972	2	7V1	40,00		55,00	8,50	9,00	CRE		Nissan Cabstar TAS 20 /30 m616 /617	
● F-00973	2	7V1PM	32,00		47,50	10,00	12,00	CRE		Cherokee ultimo tipo	Genuin
● F-00974	2	7V2G	35,00		46,50		7,10	CRE		Isuzu	P.T.F.E. + paraolio
● F-00975	2	7V2G	40,00		51,20		7,30	CRE		Isuzu	P.T.F.E. + paraolio
● F-00976	2	1PM	16,90		27,00	5,00	6,00	POM			
● F-00977	2	7V1PM	57,00		74,70	9,00	9,50			TAS 75/80	originale/genuine
● F-00978	2	1PM	20,00		30,00	5,00	6,00	DIS		Mercedes, Toyota	Genuin
● F-00979	2	0M	28,00		37,00		5,00	DIS	ZF	Audi A4	Genuin
● F-00980	2	0M	29,00		43,00		7,00	DIS	ZF	Citroen XM,Xara, Alfa 159,	Genuin
● F-00981	2	0M	28,00		38,00		7,00	CRE	ZF	VW, Bmw 3, Audi	originale/genuine
● F-00982	2	4PM	18,00		25,50	6,50	7,00		ZF	veicoli commerciali	Genuin
● F-00983	2	7V1	24,00		40,20		8,00	CRE		Toyota	
● F-00984	2	0M	35,00		46,10		7,30	DIS			
● F-00985	2	0M	27,75		37,30		6,50	DIS		Pontiac GTO 2004	distributore inf.
● F-00986	2	7V1	27,00		46,00		8,00	CRE		Opel Antara	originale/genuine
● F-00987	2	1PM	52,00		65,00	9,00	11,00	DIS		Mercedes	Distributore superiore, (BLU)
● F-00988	2	7V1	35,00		53,00		8,50	CRE		Lexus RX 470	Lexus RX 470, genuin
● F-00989	2	0	32,00		42,00		5,00	DIS			Genuin
● F-00990	2	7V1	26,00		47,10		8,60	CRE		Nissan Serena,N. Murano 3.6 v6 2005	Genuin
● F-00991	2	0MA	10,00		22,00		6,00	POM	ZF		
● F-00992	2	12	40,00		50,00		8,00	DIS		veicoli commerciali	Eurostar
● F-00993	2	1PM	19,00		30,00	5,00	5,50	DIS			originale/genuine
● F-00994	2	7V2	26,00		44,10		10,00	CRE			
● F-00995	2	3G	23,00		54,00		8,00			TAS 75	parapolvere
● F-00996	2	7V1PM	27,70		50,20	9,00	10,00			Hyundai 2006, Kia Sedoma,Karnival	Hyundai 2006, Kia Sedoma,Karnival
● F-00997	2	1PM	20,00		44,50	3,80	5,00	DIS	TRW		Maggiorato esternamente sulla parte esterna
● F-00998	2	0M	15,00		24,00		7,00				
● F-00999	2	12	35,00		48,00		7,00	DIS			
● F-01000	2	1PM	11,75	22,00	22,00	7,00	10,00	POM		Cherokee	originale-genuine Cherokee

**Paraoli**Seals
Сальники**in ordine di codice**sorted by code
сортировка по коду

CRE	Cremagliera	Rack	Гидроцилиндр
DIS	Distributore	Pignon	Распределитель
PIS	Pistone	Piston	Поршень
POM	Pompa	Pump	Насос
SCA	Scatola	Box	Корпус редуктора

Codice Code Код	Min Ord Мин. коли- чество заказа	Dis. Drawing Тип сальника	d1	d2	D	h1	H	Uso Use in Приме- нение	Marca Brand Произво- дитель агрегата	Tipo auto Vehicle type Тип авто	Note Remarks Примечания
• F-01001	2	12	32,00		40,00		5,00	DIS			
• F-01002	2	0M	32,00		43,00		5,00	DIS			
• F-01003	2	7V2	32,00		45,65		6,90	CRE		Chevrolet Tahoe	
• F-01004	2	1PM	20,00		34,10	6,00	7,00	DIS	Mando	Jeep	originale-genuine
• F-01005	2	7V1PM	30,00		48,10	9,00	10,00	CRE	Mando	Jeep	originale-genuine
• CT20594	2		35,00		50,00		7,00				
• CT20597	2	12	57,10		75,50		6,50	DIS		TAS 75	
• CT20599	2	1PM	57,10		70,00	5,00	6,00	DIS		TAS 75	
• CT20600	2	1P	57,10		74,50	3,90	5,00	DIS		TAS 75	
• CT20602	2	1PM	30,00		64,00	5,00	6,00	DIS		TAS 75/80	Genuine
• CT20609	2	1PM	57,10		70,00	5,00	6,00	DIS	TRW	TAS 75	
• CT20614	2	2	57,10		74,50		2,85		TRW	TAS 75	
• CT20617	2	7V1	32,00		47,00		8,50	CRE		Mitsubishi Pajero	
• CT20618	2	0M	19,05		28,90		4,76				
• CT20622	2	7V1	30,00		48,20		8,00	CRE		Toyota Hi ace	
• CT20624	2	7V2	60,00		74,00		5,50	CRE		Mercedes	
• CT20759	2	0M2	18,00		32,00		8,00	POM			Pompa
• CT20897	2	0MA	28,60		40,00		5,00	DIS		Nissan King Kab	
• CT20945	2	1PM	21,00		33,00	5,50	7,00	DIS		Jeep Wrangler	distributore sup.
• CT20947	2	3P	35,00		48,00	3,00	3,80			Jeep Wrangler	
• CT20953	2	7V2	26,00		43,00		8,50	CRE	ZF	Alfa 159	Cremagliera ZF
• CT21268	2	1PM	15,00		24,00		7,00				
• CT21990	2	7V2	28,00		44,00		7,20	CRE		F. S-Max	originale/genuine
• CT21992	2	0M	28,00		37,60		6,20	DIS		S-Max anno2006	Distributore inferiore
• CT21996	2	0M	20,60		41,00		6,50	DIS		S-Max anno 2006	Distributore inferiore
• CT22007	2	1PM	11,75		22,00	6,00	6,50	POM		Voyager	originale/genuine
• CT22028	2	0M	52,00		68,00		8,00	DIS		Mercedes LS4	Mercedes LS4
• CT22029	2	12	45,00		60,00		5,60			Mercedes LS4	Mercedes LS4
• CT22030	2	12	52,00		67,00		5,60			Mercedes LS4	Mercedes LS4
• CT22349	2	12	55,00		71,40		5,60			Mercedes LS8	Mercedes LS8
• CT22383	2	8	16,50		41,50	3,50	5,00	DIS		S-Max	parapolvere S-Max
• CT22447	2	1PM	8,00		20,00	5,30	6,00				pompa Mercedes elettrica
• CT22504	2	0M	24,00		38,00		6,50			Nissan Altima 2007	Nissan Altima 2007
• CT22527	2	7V2	26,00		46,00		8,50	CRE		Fiat Scudo 2007	Fiat Scudo 2007
• CT22605	2	6V1	22,50	34,30	38,00	3,20	8,00	CRE		VW Golf	Vw Golf (minorato)
• CT22684	2	12	40,00		56,00		6,00			TAS 20	
• CT22685	2	1PM	40,00		51,00	5,00	6,00	DIS		TAS 20	
• CT22702	2	8	25,00		40,80	1,30	4,00			HFB70 DAF, Scania	Raschiatore
• CT22703	2	8	57,00		70,80	1,30	4,00			HFB70 DAF, Scania	Raschiatore
• CT22704	2	3G	22,00		45,50	1,30	4,50			HFB70 DAF, Scania	parapolvere
• CT22718	2	7V1PM	27,70		40,20	9,00	10,00	CRE			
• CT22720	2	7V1	25,00		43,00		9,00	CRE			
• CT22722	2	12	75,00		89,60		4,50	PIS			per tenuta pistone
• CT22724	2	12	36,00		47,50		7,00	PIS			
• CT22760	2	1PM	19,00		29,00	7,00	7,90				
• CT22784	2		22,00		35,30		8,50	POM		Toyota	Pompa Toyota
• CT22809	2	12	40,00	44,60	50,00		11,00	DIS			originale/genuine in poliuretano blu

Gli articoli identificati con l'iniziale «CT» (codice temporaneo) sono attualmente in fase di test e prossimi all'introduzione definitiva nel mercato.

*Items whose code starts with «CT» (temporary code) are currently being tested and they are candidate to be introduced in the market soon.
Пункты, обозначенные аббревиатурой «CT» (временный код), в данный момент проходят испытания и будут представлены на рынок в ближайшее время.*



Codice Code Код	Min Ord Мин. коли- чество заказа	Dis. Drawing Тип сальника	d1	d2	D	h1	H	Uso Use in Приме- нение	Marca Brand Произво- дитель агрегата	Tipo auto Vehicle type Тип авто	Note Remarks Примечания
• CT22936	2		26,00		28,30	5,50	8,50	DIS	TRW	Alfa 166	distributore inf. - tappo Alfa 166
• CT22937	2		30,00		32,20	5,50	13,00	DIS	TRW	Punto, Multipla, Y	distributore inf.- tappo Punto, Multipla, Y
• CT22938	2		38,00		40,30	6,50	16,00	DIS	TRW	Ducato	distributore inf. - tappo Ducato
• CT22939	2		30,00	32,30	38,30	2,00	16,00	DIS	TRW	doblo	distr inf. - tappo con ribordatura doblo
• CT22979	2		50,00		72,00		9,00				Volvo
• CT22980	2		50,00		73,00		11,00				Volvo
• CT23020	2		24,00		35,00		11,30	CRE		VW PQ 35 Gen III	VW PQ 35 Gen III
• CT23043	2	12	25,40		38,10		6,50	CRE		Rolls Royce	
• CT23056	2	7V1PM	24,00		38,50	9,00	10,00	CRE	Mando	Hyundai Matrix, Jazz	
• CT23156	2		40,00		62,00		8,00				motore Smart
• CT23157	2		80,00		100,00		9,00				motore Smart
• CT23207	2	12	27,00		35,00		5,00			Nissan Skyline	
• CT23278	2	7V2	23,00		34,60		6,35	CRE		Golf Brasile	originale/genuine
• CT23279	2	0MA	22,00		35,20		8,00			Golf brasilie	originale/genuine
• CT23280	2	7V2	24,00		36,50		7,50	CRE		Renault Clio II	originale/genuine
• CT23341	2	1PMA	18,00		34,10	8,00	8,20	POM		Dodge	
• CT23413	2	1PM	32,00		47,00		10,00			Volswagen	Volswagen
• CT23446	2	7V2	25,00		43,20		9,00	CRE			originale/genuine
• CT23447	2	0M	25,50		42,10		6,40	DIS			
• CT23448	2	7V1	26,00		48,20		9,50	CRE			
• CT23450	2	1PMA	19,05		28,60	4,70	5,00				
• CT23451	2	12	23,00		32,00		5,00				
• CT23454	2	2	27,70		42,00		4,00	CRE			Raschiatore
• CT23574	2		70,00		81,50		6,00				
• CT23718	2	0A	32,00		42,00		4,00			Nissan Patrol	
• CT23955	2	0MA	28,60		41,30		12,80	CRE		Amc Pacer 1978	
• CT23956	2	0M	20,20		38,00		7,20	DIS		Amc Pacer 1978	
• CT23958	2	12	28,50		35,50		3,90			Amc Pacer 1978	
• CT24017	2	0A	12,00		22,30		6,65	POM		Pompa Cummins	Pompa Cummins
• CT24018	2	0A	12,00		23,00		6,50	POM		Pompa Cummins	Pompa Cummins
• CT24058	2	6V1	25,00	37,70	41,24	5,80	10,00	CRE		Chrysler 2007, Sebring 2008	originale/guein
• CT24107	2	7V2A	30,00	42,10	44,40		15,00	CRE		Bmw X3	Originale/genuine
• CT24108	2	0M	28,00		38,20		7,00	DIS	ZF	Bmw 3	originale/genuine
• CT24110	2	1PM	20,00		30,00	5,00	6,00	DIS		Bmw X3	Originale/genuine
• CT24115	2	1PM	18,00		30,00	6,80	6,80	POM			alta temperatura, righe SX rotazione DX
• CT24136	2	1PMA	19,05		33,40	8,00	8,00	POM	ZF	R9-R19-Porsche-Bmw- Volkswagen	righe SX rotazione DX tiraggio maggiorato
• CT24618	2	7V1PM	32,00		54,00	9,00	10,00	CRE		BUIK	Genuin
• CT24645	2	0	35,91		46,10		7,20				
• CT24682	2	0MA	29,90		47,00		8,00				Genuin, righe SX,rotazione DX
• CT24732	2	0MA	55,00		72,00		7,00	DIS		Mercedes	

Paraoli

Seals
Сальники

in ordine di codice

sorted by code
сортировка по коду

CRE	Cremagliera	Rack	Гидроцилиндр
DIS	Distributore	Pignon	Распределитель
PIS	Pistone	Piston	Поршень
POM	Pompa	Pump	Насос
SCA	Scatola	Box	Корпус редуктора

Codice Code Код	Min Ord Мин. коли- чество заказа	Dis. Drawing Тип сальника	d1	d2	D	h1	H	Uso Use in Приме- нение	Marca Brand Произво- дитель агрегата	Tipo auto Vehicle type Тип авто	Note Remarks Примечания
			Размеры								
● CT24733	2	1PM	55,00		72,00	8,00	8,50	DIS		Mercedes	
● CT24734	2	1PM	55,00		72,00	8,00	8,50	DIS		Mercedes	Alte temperature
● CT24755	2	12	28,00		38,00		5,00	DIS			
● CT24851	2	1PM	47,00		59,00	8,00	10,50	DIS		Mercedes LS3	
● CT24867	2	1PM	54,00		72,00		10,00			Mercedes	Paraolio motore righe SX, rotazione DX
● CT24868	2	1PM	56,00		69,00		10,00			Mercedes	Paraolio motore righe DX, rotazione SX
● CT24869	2	1PM	32,00		47,00		10,00			Mercedes	Paraolio motore, Mercedes
● CT24893	2	12	44,00		54,00		6,70			Renault Shepard piccola	Renault Shepard piccola
● CT24903	2	3	57,13		74,57		3,60		TRW	TAS 80	TAS 80
● CT24904	2	8	57,13		74,57		2,90		TRW	TAS 80	TAS 80
● CT24908	2	1PA	57,10		70,00	6,00	6,00	DIS		TAS 80	TAS 80
● CT25164	2	7V3	32,00		55,00		14,50	CRE		Chevrolet Tahoe	
● CT25175	2		65,00		85,00		10,00				
● CT25176	2		85,00		130,00		10,00				
● CT25189	2	12	15,50		20,90		4,30	POM	Saginaw		Pompa saginaw
● CT25190	2	12	10,00		14,50		2,70	POM		Honda Civic	Valvola pompa Honda Civic
● CT25191	2	7V2	31,00		52,00		7,60	CRE			
● CT25192	2	6	31,00		51,60	6,60	11,00	CRE			
● CT25196	2	12	36,00		44,00		6,00	DIS			

INFORMAZIONE TIP REKOMENDACII

I paraoli minorati sono identificati con la lettera finale «X»
Esempio F-00024: dimensioni normali - F-00024X: minorato
Reduced seals are identified with final letter «X»
Example F-00024: regular sizes - F-00024X: reduced seal
Сальники, обозначенные буквой «X», являются аналогами стандартных сальников с уменьшенным внутренним диаметром
Например: F-00024 - стандартный F-00024X - с уменьшенным внутренним диаметром

in ordine di Øint.

sorted by int.Ø
сортировка по размеру

Codice Code Код	Min Ord Мин. коли- чество заказа	Dis. Drawing Тип сальника	d1	d2	D	h1	H	Uso Use in Приме- нение	Marca Brand Произво- дитель агрегата	Tipo auto Vehicle type Тип авто	Note Remarks Примечания
			Размеры								
F-00723	2	spec.			22,00		5,50	DIS	ZF		distributore inf. - tappo
F-00105	2	spec.			28,30	5,00	8,00	DIS	TRW		distributore inf. - tappo
F-00386	2	OM	6,35		19,00		5,00	DIS		Renault, Peugeot	
F-00942	2	OMA	7,76		21,00		6,00				
F-00480	2	OM	8,00		16,00		7,00	POM		Renault	
F-00909	2	1PM	8,00		16,00	7,00	7,00	POM		Mercedes Classe A	Mercedes Classe A
F-00789	2	1PM	8,00		18,00	7,00	7,00	POM			
CT22447	2	1PM	8,00		20,00	5,30	6,00				pompa Mercedes elettrica
F-00874	2	1PM	8,00		22,00	7,00	7,50	POM		Mercedes Classe "A"	sotto piastra Mercedes classe A - fino a 120 bar
F-00650	2	1PM	9,00		19,05		7,30	POM	ZF	Bmw E46,316,318	Pompa ZF
F-00963	2	1PM	9,00		22,00		7,00	POM		Mercedes o Volvo	Pompa ZF
F-00964	2	1PM	9,00		23,00	7,00	8,00	POM	ZF	Mercedes o Volvo	Pompa ZF
CT25190	2	12	10,00		14,50		2,70	POM		Honda Civic	Valvola pompa Honda Civic
F-00885	2	12	10,00		16,00		4,00				
F-00481	2	OM	10,00		19,00		7,00	POM		Renault	
F-00074	2	OM	10,00		20,00		7,00	CRE	ZF	Opel Calibra	originale/genuine
F-00355	2	1PM	10,00		20,00		7,00	CRE			
F-00574	2	1PM	10,00		21,00	7,00	7,30	POM	LUK	Luk	abbinare a F-00575
F-00852	2	1PM	10,00		21,00	7,00	7,30	POM	LUK	Luk	abbinare a F-00853
F-00958	2	1PM	10,00		22,00		6,00	POM			alta temperatura
F-00991	2	OMA	10,00		22,00		6,00	POM	ZF		
F-00953	2	1PM	10,00		22,00	6,00	6,50	POM		Mini	
F-00575	2	1PM	10,00		22,00	7,00	8,00	POM	LUK	Luk	abbinare a F-00574
F-00853	2	1PM	10,00		22,00	7,00	8,00	POM	LUK	LUK	abbinare a F-00852
F-00702	2	1PM	11,00		25,00	6,40	6,40	POM	Koyo	Touareg	abbinare a F-00703
F-00043	2	4	11,00		35,00	5,00	9,00	DIS	TRW	Fiat Tipo	originale/genuine parapolvere
CT22007	2	1PM	11,75		22,00	6,00	6,50	POM		Voyager	originale/genuine
F-00608	2	1PM2	11,75		22,00	6,00	8,50	POM		Cherokee, Vojager Diesel engine	originale/genuine
F-00364	2	1PM	11,75		22,00	7,00	10,00	POM		Cherokee	
F-01000	2	1PM	11,75	22,00	22,00	7,00	10,00	POM		Cherokee	originale-genuine Cherokee
F-00466	2	8A	11,75	22,13	29,80	1,90	12,65	POM		Jeep Cherokee	
F-00870	2	1PM	12,00		22,00	6,00	6,50	POM			originale/genuine
CT24017	2	0A	12,00		22,30		6,65	POM		Pompa Cummins	Pompa Cummins
CT24018	2	0A	12,00		23,00		6,50	POM		Pompa Cummins	Pompa Cummins
F-00790	2	OM	12,00		24,00		6,00	DIS			distributore inf.
F-00791	2	1PM	12,00		24,00	7,00	7,50	DIS			distributore sup.
F-00102	2	7V1PM	12,00		27,00		10,00	CRE	Saginaw	Opel	con PTFE interno
F-00178	2	7V1PM	12,00		27,00	9,00	10,00	CRE	Saginaw	Opel Calibra	
F-00726	2	7V2	12,00		38,20		10,00	CRE			

**Paraoli**Seals
Сальники**in ordine di Øint.**sorted by int.Ø
сортировка по размеру

CRE	Cremagliera	Rack	Гидроцилиндр
DIS	Distributore	Pignon	Распределитель
PIS	Pistone	Piston	Поршень
POM	Pompa	Pump	Насос
SCA	Scatola	Box	Корпус редуктора

Codice Code Код	Min Ord Мин. коли- чество заказа	Dis. Drawing Тип сальника	d1	d2	D	h1	H	Uso Use in Приме- нение	Marca Brand Произво- дитель агрегата	Tipo auto Vehicle type Тип авто	Note Remarks Примечания
			Размеры								
F-00044	2	4	13,00		35,00	4,40	6,50	DIS	TRW	Lancia Thema II Serie	originale/genuine parapolvere
F-00770	2	0	14,00		22,00		4,00	DIS		Mini	distributore inf.
F-00732	2	1PM	14,00		23,00		7,00	POM		Mercedes CK 500	
F-00733	2	1PM	14,00		24,00		7,00	POM		Mercedes CK 500	
F-00792	2	1PM	14,00		24,00	7,00	7,50	DIS			distributore sup. alte temperature
F-00372	2	7V1PM	14,00		27,00	9,00	10,00	CRE	Saginaw	Opel Vectra B, GM	(con teflon interno)
F-00523	2	6V3	14,00	30,50	38,40	5,00	11,00	CRE		Chrysler 300 M	
F-00626	2	3G	14,00	45,00	48,00	8,20	13,00	DIS			parapolvere
F-00625	2	3G	14,00	50,00	53,00	10,00	10,00	DIS			parapolvere
F-00777	2	0	14,20		24,40		5,00	DIS		Burman (taxi)	distributore inf.
F-00066	2	0	14,30		22,00		4,00	DIS		Rover	
F-00013	2	3	14,60		35,00		4,90	DIS	TRW		parapolvere
F-00042	2	3	14,60		35,00		4,90	DIS	TRW	Volvo	originale/genuine parapolvere
F-00773	2	1P	15,00		22,00	4,00	4,00	DIS		Ford Sierra	parapolvere distributore sup.
F-00897	2	1P	15,00		22,00	4,00	4,00	DIS		Ford Sierra	parapolvere distributore sup.
F-00861	2	1P	15,00		22,00	4,00	4,50	DIS			originale/genuine
F-00068	2	1PM	15,00		22,00	4,50	5,20	DIS			
F-00439	2	1PM	15,00		24,00		6,00	POM		Rover	
F-00928	2	1PM	15,00		24,00	6,00	6,20	DIS		Ford Transit	distributore superiore
CT21268	2	1PM	15,00		24,00		7,00				
F-00794	2	0M2	15,00		24,00		7,00	POM			
F-00998	2	0M	15,00		24,00		7,00				
F-00415	2	1PA	15,00		24,00	4,50	7,00	POM		Rover	
F-00162	2	1PM	15,00		24,00	7,00	7,00	POM		Rover 200 – Hoborn Eaton	
F-00300	2	1PM	15,00		24,00	7,00	7,00	DIS		Audi	distributore inf.
F-00565	2	0AM2	15,00		24,12		7,00	POM			
F-00155	2	1PM	15,00		25,00	5,00	5,20	POM		Honda	
F-00760	2	1PM	15,00		25,00		5,50	POM	LUK	Bmw LUK	
F-00767	2	1PM	15,00		25,00	7,00	7,00	DIS		Toyota starlet	distributore sup.
F-00056	2	0M	15,00		26,00		7,00	POM			viton
F-00432	2	1PMA	15,00		28,00	6,20	6,30	POM	ZF	Opel Vectra-Alfa 159	
F-00597	2	1PMA	15,00		28,00		7,00	POM		Subaru	
F-00744	2	1PMA	15,00		28,10	6,20	6,30	POM	ZF	Opel Vectra	alte temperature
F-00776	2	0M	15,00		30,00		7,00	DIS		TVR	distributore inf.
F-00180	2	1PM	15,00		35,50	5,50	6,00	DIS		Honda, Rover	
F-00896	2	1PM	15,00		35,50	5,50	6,00	DIS		Honda, Rover	originale/genuine
F-00279	2	1PM	15,00		36,00	5,50	9,50	DIS		Honda	
F-00299	2	3	15,00		41,50		5,70	DIS		Ford	parapolvere
F-00215	2	3	15,00		42,00		3,50	DIS			parapolvere
F-00848	2	3G	15,00		52,00		7,00			Renault Master	parapolvere
CT25189	2	12	15,50		20,90		4,30	POM	Saginaw		Pompa saginaw
F-00463	2	1PA	15,88		31,70		6,35	POM	Saginaw		
F-00472	2	3	16,00		24,00	2,50	3,50	DIS	TRW	HFB 70	parapolvere
F-00707	2	0M	16,00		24,00		6,00	POM			
F-00968	2	1PMA	16,00		25,50	8,00	9,00	DIS			

Gli articoli identificati con l'iniziale «CT» (codice temporaneo) sono attualmente in fase di test e prossimi all'introduzione definitiva nel mercato.

Items whose code starts with «CT» (temporary code) are currently being tested and they are candidate to be introduced in the market soon.
Пункты, обозначенные аббревиатурой «СТ» (временный код), в данный момент проходят испытания и будут представлены на рынок в ближайшее время.



Codice Code Код	Min Ord Мин. коли- чество заказа	Dis. Drawing Тип сальника	d1	d2	D	h1	H	Uso Use in Приме- нение	Marca Brand Произво- дитель агрегата	Tipo auto Vehicle type Тип авто	Note Remarks Примечания
F-00365	2	1PM	16,00		26,00	5,20	6,20	POM		Audi,Bmw	trattori LUK righe SX rotazione DX
• F-00946	2	1PM	16,00		26,00		7,00	POM			
• F-00947	2	1PM	16,00		27,00		7,00	POM			
F-00052	2	1PM	16,00		28,00	6,90	7,00	POM	ZF	Audi,Alfa	
F-00555	2	1PMA	16,00		30,00		6,25	POM		Ford Tempo	righe DX rotazione SX
F-00149	2	1PMA	16,00		30,00		6,50	POM		Ford Mondeo	righe SX rotazione DX
F-00689	2	1PMA	16,00		30,00		6,50	POM		Ford Mondeo	righe SX rotazione DX
F-00894	2	1PMA	16,00		30,00	6,30	6,50	POM		Ford Mondeo	originale/genuine- righe SX rotazione DX
F-00156	2	1PM	16,00		30,00	7,00	7,00	POM		Honda	righe DX rotazione SX
F-00461	2	1PA	16,00		34,00	36,00	38,00	DIS		Ford Mazda 626 323	pignone con metallo
F-00578	2	1PMA	16,00		35,00		13,00	POM		Opel Vectra-Motore Cavalier	alte temperature
F-00686	2	0MA	16,00		36,00		6,60	POM			alte temperature righe SX rotazione DX (minorato)
F-00340	2	8	16,00		40,00		2,50	DIS		Saab, Opel Corsa	parapolvere
F-00310	2	8	16,00		42,30	5,00	9,00	DIS		Mazda	parapolvere
F-00438	2	3G	16,00		46,00		9,00	DIS		Alfa 33,Alfa 75	parapolvere
• CT22383	2	8	16,50		41,50	3,50	5,00	DIS		S-Max	parapolvere S-Max
F-00532	2	3G	16,50		55,00	7,50	9,00	DIS	ZF	Toyota Carina	parapolvere
F-00179	2	1PM	16,70		28,00		6,00	DIS		Honda	
• F-00976	2	1PM	16,90		27,00	5,00	6,00	POM			
F-00775	2	1PM	17,00		25,00	4,00	4,00	DIS		Vauxhall Cavalier,Astra	distributore sup.
F-00510	2	0AM2	17,00		28,00		6,50	POM		veicoli commerciali	originale/genuine
F-00538	2	0AM2	17,00		28,00		6,50	POM			alte temperature
F-00148	2	0M2	17,00		28,00		8,00	POM		Volvo,Ducato	
F-00506	2	0M2	17,00		28,00		8,00	POM		veicoli commerciali	originale/genuine
• F-00967	2	0MA	17,00		28,70		6,50	POM			
F-00505	2	0M2	17,00		28,80		8,00	POM		veicoli commerciali	
F-00606	2	1PM	17,00		29,00	6,30	6,50	POM		Mitsubishi	
F-00586	2	1PMA	17,00		29,00		8,00	POM		Toyota Corolla	
F-00556	2	1PM	17,00		29,90		7,00	POM		Kayaba	righe SX rotazione DX
F-00356	2	0M2	17,00		30,00		7,00	POM			alte temperature
F-00414	2	1PM	17,00		30,00		7,00	POM		Mazda	
F-00473	2	1PM	17,00		30,00		7,00	POM		Mazda	
F-00862	2	1P	17,00		30,50	4,00	4,50	DIS			originale/genuine
F-00157	2	1PMA	17,00		31,00	7,00	7,00	POM		Nissan	
F-00427	2	1PMA	17,00		31,00	8,00	8,00	POM			
F-00151	2	1PMA	17,00		32,00	7,20	7,20	POM		Nissan,Mitsubishi	
F-00154	2	1PM	17,00		32,00		8,00	POM		Nissan	
F-00465	2	0AM2	17,00		32,00		8,00	POM		Toyota Land Cruiser 8,92	
F-00165	2	1PMA	17,00		34,00		8,00	POM		Lexus GS 300, Camry 6 CYL 92,93	

**Paraoli**Seals
Сальники**in ordine di Øint.**sorted by int.Ø
сортировка по размеру

CRE	Cremagliera	Rack	Гидроцилиндр
DIS	Distributore	Pignon	Распределитель
PIS	Pistone	Piston	Поршень
POM	Pompa	Pump	Насос
SCA	Scatola	Box	Корпус редуктора

Codice Code Код	Min Ord Мин. коли- чество заказа	Dis. Drawing Тип сальника	d1	d2	D	h1	H	Uso Use in Приме- нение	Marca Brand Произво- дитель агрегата	Tipo auto Vehicle type Тип авто	Note Remarks Примечания
			Размеры								
F-00787	2	1PM	17,00		35,00	7,00	7,00	DIS			distributore sup.
F-00181	2	1PM	17,00		35,00		8,00	DIS			
F-00122	2	0MA	17,00		36,00		6,60	POM	Saginaw		alte temperature righe SX rotazione DX
F-00687	2	0MA	17,00		36,00		6,60	POM	Saginaw		
F-00772	2	1P	17,00		40,00	4,60	6,20	DIS		Vauxhall Nova	parapolvere distributore sup.
F-00419	2	8	17,00		40,00	4,60	6,50	DIS			
F-00858	2	0M	17,00		40,00		7,00				standard
F-00864	2	3	17,00		43,00		3,50	DIS			originale/genuine
F-00566	2	8	17,00		43,00	3,30	3,80	DIS	TRW		
F-00875	2	1PM	17,45		28,58		6,30	POM			
F-00503	2	1PM	17,46		28,58	5,80	6,30	POM		veicoli commerciali	
F-00388	2	1PM	17,90		35,50	8,20	10,00	DIS		Renault, Peugeot	
F-00924	2	0	18,00		24,00		3,00	DIS			Distributore inferiore
F-00519	2	4PM	18,00		25,50	4,00	6,50	DIS		veicoli commerciali	
F-00982	2	4PM	18,00		25,50	6,50	7,00		ZF	veicoli commerciali	Genuin
F-00182	2	1PM	18,00		28,00	5,00	6,00	DIS	ZF	Audi	
F-00781	2	1PM	18,00		30,00	5,50	6,00	DIS		Renault	originale/genuine
F-00782	2	1PM	18,00		30,00	6,00	6,50	DIS			originale/genuine alta temperatura, righe SX rotazione DX
CT24115	2	1PM	18,00		30,00	6,80	6,80	POM			
F-00152	2	1PM	18,00		30,00	7,00	7,00	POM	ZF	Nissan, Mazda	
F-00771	2	1PM	18,00		30,00	7,00	7,00	DIS	ZF	Ford Transit	distributore sup.
F-00855	2	1PMA	18,00		30,00	7,00	7,00	DIS			originale/genuine
F-00648	2	1PM	18,00		30,00	7,00	7,50	DIS	ZF	Audi	
F-00051	2	1PM	18,00		30,00	7,00	8,00	DIS	ZF	Audi-Bmw	
F-00183	2	1PM	18,00		30,00	7,00	8,00	DIS	ZF	Nissan	
F-00517	2	1PM	18,00		30,00	7,00	8,00	DIS	ZF	Audi	
F-00080	2	1PM	18,00		30,10	5,50	6,00	DIS		Renault	
F-00632	2	1PM	18,00		30,10	5,50	6,00	DIS		Renault	
F-00879	2	1PMA	18,00		31,80		6,30	POM		Ford Taurus	alta temperatura Righe SX rotazione DX
F-00883	2	1PM	18,00		32,00	6,00	6,00				Righe SX rotazione DX
F-00117	2	1PM	18,00		32,00		7,00	DIS		Bendix, Transit	
F-00768	2	1PM	18,00		32,00	4,30	7,00	DIS		Renault Traffic	distributore sup.
F-00959	2	1PM	18,00		32,00	6,00	7,00	DIS			originale/genuine, alta temperatura Pompa
CT20759	2	0M2	18,00		32,00		8,00	POM			
F-00164	2	1PA	18,00		32,00		8,00	POM		Isuzu	
F-00741	2	1PMA	18,00		32,10	8,00	8,50	POM			
F-00306	2	8	18,00		32,20	6,20	8,20	DIS		Subaru	
F-00464	2	1PMA	18,00		34,00	7,90	8,00	POM		Voyager	
F-00185	2	1PM	18,00		34,00	7,50	12,50	DIS			
F-00460	2	1A	18,00		34,00	17,00	20,00	DIS		Mazda	pignone con metallo
CT23341	2	1PMA	18,00		34,10	8,00	8,20	POM		Dodge	
F-00627	2	1PM	18,00		34,60	6,20	7,50	DIS		Ford, Opel Astra, Ford Focus	minorato per pignoni rettificati
F-00699	2	3A	18,00		35,70		3,90	DIS			parapolvere

INFORMAZIONE TIP РЕКОМЕНДАЦИИ

I paraoli minorati sono identificati con la lettera finale «X»
Esempio F-00024: dimensioni normali - F-00024X: minorato
Reduced seals are identified with final letter «X»
Example F-00024: regular sizes - F-00024X: reduced seal
Сальники, обозначенные буквой «X», являются аналогами стандартных сальников с уменьшенным внутренним диаметром
Например: F-00024 - стандартный F-00024X - с уменьшенным внутренним диаметром



Codice Code Код	Min Ord Мин. коли- чество заказа	Dis. Drawing Тип сальника	d1	d2	D	h1	H	Uso Use in Приме- нение	Marca Brand Произво- дитель агрегата	Tipo auto Vehicle type Тип авто	Note Remarks Примечания
F-00416	2	0MA	18,00		36,00		6,80	POM	Saginaw		alte temperature righe SX rotazione DX
F-00170	2	3A	18,00		42,00		4,00	DIS		Ford Mondeo, Fiesta	parapolvere
• F-00030X	2	1PM	18,50		34,60	4,40	5,90	DIS	TRW	Regata, Golf, Peugeot 205	minorato
• F-00921	2	1P	18,50		40,00	5,00	5,00			Mazda 3	parapolvere Mazda
F-00557	2	3	18,50		43,00		4,50	DIS	TRW	VW Lupo, Skoda Octavia, Fiat Ibiza	parapolvere
F-00657	2	1PM	18,70		35,00	7,00	7,50	DIS		Mitsubishi	originale/genuine
F-00136	2	1PM	18,70		35,00	7,00	8,00	DIS		Mitsubishi	
F-00395	2	1PM	18,75		30,00	5,00	6,00	DIS		Suzuki Swift	
F-00799	2	1PM	18,75		37,50	5,50	8,00	DIS		Honda Civic	
F-00189	2	1PM	18,80		30,00	5,00	6,00	DIS		Nissan	
F-00654	2	8	18,90		51,40	4,50	6,70	DIS	TRW	Fiat Doblo	parapolvere
F-00384	2	2	19,00		25,50		3,00	DIS			
• F-00384M	2	2	19,00		25,50		3,30	DIS			
F-00863	2	1P	19,00		26,00	4,00	4,50	DIS			originale/genuine
F-00307	2	3A	19,00		26,50		4,00	DIS		Subaru	
F-00201	2	1PM	19,00		27,00		5,00	DIS		Rover 6 Bulloni	
• F-00904	2	1PM	19,00		27,20	5,00	5,00	DIS		Tata	Distributore superiore, originale/genuine
F-00313	2	1PM	19,00		28,00	5,00	6,00	DIS	ZF	Volkswagen	
F-00323	2	0	19,00		28,50		5,50	DIS		Isuzu, Subaru	
F-00484	2	1PM	19,00		29,00	4,40	6,30	DIS		Nissan Almera-Primer	
F-00462	2	0M2	19,00		29,00		7,00	POM			
• CT22760	2	1PM	19,00		29,00	7,00	7,90				Paraoli dis.1 Ø19x29 H7/7,9
F-00459	2	1PM	19,00		29,00	7,00	8,00	DIS		Toyota Yaris	
• F-00459M	2	1PM	19,00		29,00	7,00	8,00	DIS		Toyota Yaris	
• F-00993	2	1PM	19,00		30,00	5,00	5,50	DIS			originale/genuine
F-00740	2	1PM	19,00		30,00	5,50	6,00	DIS		Nissan, Renault	originale/genuine
F-00619	2	1PM	19,00		30,00		6,50	POM			speciale
F-00111	2	1PM	19,00		30,00	6,40	7,00	DIS		Nissan	
F-00769	2	1PM	19,00		30,00	7,00	7,00	DIS		Ford Transit	distributore sup.
F-00315	2	1PM	19,00		30,00	7,00	8,00	DIS		Volvo	
F-00110	2	1PM	19,00		30,10	5,00	6,00	DIS		Nissan, Renault	
F-00851	2	12	19,00		31,00		5,00			Peugeot	
F-00347	2	0M	19,00		31,80		6,30	DIS		SDI Burman	
F-00602	2	1PMA	19,00		31,90		8,00	POM			
F-00418	2	1PM	19,00		32,00		7,00	POM	ZF	Opel, Skoda, VW	viton
F-00114	2	1PM	19,00		32,00	6,00	7,00	DIS		Toyota, Mitsubishi, Nissan	
F-00403	2	1PM	19,00		32,00	6,00	7,00	DIS		Toyota Pik up e 4x4	
F-00600	2	1PM	19,00		32,00	6,00	7,00	DIS		Toyota-Mitsubishi	originale/genuine
F-00779	2	1PM	19,00		32,00	6,00	7,00	DIS		Hyundai Atos	originale/genuine
F-00366	2	1PM	19,00		32,00	6,90	7,00	POM	ZF	Vito, Trova way	
F-00774	2	0M	19,00		32,00		8,00	DIS		MGB	distributore inf.



Paraoli
Seals
Сальники

in ordine di Øint.
sorted by int.Ø
сортировка по размеру

CRE	Cremagliera	Rack	Гидроцилиндр
DIS	Distributore	Pignon	Распределитель
PIS	Pistone	Piston	Поршень
POM	Pompa	Pump	Насос
SCA	Scatola	Box	Корпус редуктора

Codice Code Код	Min Ord Мин. коли- чество заказа	Dis. Drawing Тип сальника	d1	d2	D	h1	H	Uso Use in Приме- нение	Marca Brand Произво- дитель агрегата	Tipo auto Vehicle type Тип авто	Note Remarks Примечания
F-00187	2	1PM	19,00		32,20	7,00	8,00	DIS		Toyota	
F-00039	2	8	19,00		34,60	4,30	6,30	DIS	TRW	Golf	viton
F-00040	2	8	19,00		34,60	4,30	6,30	DIS	TRW	Golf	standard
F-00011	2	1PM	19,00		34,60	6,20	9,20	DIS	TRW	Fiat Tipo, Croma, Thema, Sierra	
F-00037	2	1PM	19,00		34,60	6,20	9,20	DIS	TRW	Fiat Tipo, Croma, Thema, Ford, Volvo	originale/genuine
F-00849	2	1PM	19,00		34,70	6,30	7,00	DIS		Kia	distributore originale/genuine
F-00188	2	2	19,00		35,00		3,00	DIS		Peugeot 205 U.T.	parapolvere
F-00140	2	1PM	19,00		37,00	6,50	9,00	DIS	Koyo	Mitsubishi, Toyota ,Audi A4	
F-00886	2	1PM	19,00		37,00	6,50	9,00	DIS		Mitsubishi, Toyota, Audi A4	
F-00184	2	1PM	19,00		38,00	7,00	8,00	DIS		Toyota Corolla	
F-00317	2	8	19,00		40,00		2,50	DIS		Sintra	parapolvere
F-00308	2	1PM	19,00		42,00	6,50	8,00	DIS		Mazda RX7	
F-00382	2	3	19,00		59,50		7,00	DIS		Jaguar	coperchio pignone
CT23450	2	1PMA	19,05		28,60	4,70	5,00				
CT20618	2	0M	19,05		28,90		4,76				
F-00533	2	1PM	19,05		30,00	7,00	8,00	POM	LUK	Mercedes	righe SX rotazione DX
F-00607	2	1PM	19,05		30,20	5,00	7,30	DIS		Nissan	
F-00150	2	0MA	19,05		31,75		6,30	POM		Capri, Lotus, Rover	
F-00167	2	1PMA	19,05		31,75	6,50	6,60	POM			
F-00504	2	0AM2	19,05		31,75		7,80	POM		veicoli commerciali	
F-00421	2	1PMA	19,05		33,30		8,00	POM			
F-00160	2	1PM	19,05		33,33		7,90	POM		Bmw, Porsche, Mercedes	originale/genuine
F-00529	2	1A	19,05		33,33		8,00	POM		Mercedes	righe SX rotazione DX
F-00144	2	1PM	19,05		33,33	8,00	8,50	POM	ZF	Bmw-Volkswagen- Por- sche	
CT24136	2	1PMA	19,05		33,40	8,00	8,00	POM	ZF	R9-R19-Porsche-Bmw- Volkswagen	righe SX rotazione DX tiraggio maggiorato
F-00143	2	1PMA	19,05		33,40	8,00	8,00	POM	ZF	R9-R19-Porsche-Bmw- Volkswagen	righe SX rotazione DX tiraggio maggiorato
F-00145	2	1PMA	19,05		33,40	8,00	8,00	POM	Saginaw	Bmw, Laguna ,Fiat Tipo	righe SX rotazione DX alte temperature (viton)
F-00030	2	1PM	19,05		34,60	4,40	5,90	DIS	TRW	Regata, Golf, Peugeot 205	
F-00087	2	1PM	19,05		34,60	4,40	5,90	DIS		Peugeot 205 U.T., Vw Golf.	originale/genuine
F-00688	2	1PM	19,05		34,60	4,40	5,90	DIS	TRW	Golf	originale/genuine alte temperature (America)
F-00561	2	1PM	19,05		34,60	6,20	7,50	DIS	TRW	Opel Astra, Focus	
F-00868	2	1PM	19,05		34,60	6,30	9,00	DIS		Fiat Tipo, Croma, Thema, Ford, Volvo	originale/genuine alta temperatura
F-00368	2	1PM	19,05		34,70	6,20	7,50	DIS	TRW	Opel Astra, Focus, Polo	originale/genuine
F-00677	2	1PMA	19,05		34,80	4,40	5,90	DIS	TRW	Golf	America

Gli articoli identificati con l'iniziale «CT» (codice temporaneo) sono attualmente in fase di test e prossimi all'introduzione definitiva nel mercato.

Items whose code starts with «CT» (temporary code) are currently being tested and they are candidate to be introduced in the market soon.
Пункты, обозначенные аббревиатурой «CT» (временный код), в данный момент проходят испытания и будут представлены на рынок в ближайшее время.



Codice Code Код	Min Ord Мин. коли- чество заказа	Dis. Drawing Тип сальника	d1	d2	D	h1	H	Uso Use in Приме- нение	Marca Brand Произво- дителя агрегата	Tipo auto Vehicle type Тип авто	Note Remarks Примечания
F-00895	2	1PMA	19,05		34,80	4,40	5,90	DIS	TRW	Golf	originale/genuine
F-00370	2	3	19,05		35,00		3,40	DIS		F.Megane	parapolvere
F-00067	2	3	19,05		35,00		3,50	DIS		Peugeot 806, 205 ultimo tipo	parapolvere
F-00536	2	8	19,05		35,00	6,00	8,00	DIS		Renault Master, Vaux- hall Movano	
F-00163	2	0MA	19,05		36,00		6,60	POM	Saginaw	Chrysler, Concord, Dodge	righe SX rotazione DX alte temperature
F-00146	2	0MA	19,05		36,00		7,00	POM	Saginaw	Granada, Volvo, Fiat Tipo	righe SX rotazione DX
F-00158	2	0MA	19,05		36,00		7,00	POM	Saginaw		righe DX rotazione SX
F-00641	2	0MA	19,05		36,00		7,00	POM		Granada-Volvo-Tipo	righe SX rotazione DX
F-00915	2	1PM	19,05		37,00	6,50	7,50	DIS		Saang Yong Musso	
F-00436	2	8	19,05		37,30	6,00	8,00	DIS		Renault Peugeot	
F-00659	2	1PM	19,50		41,30	6,50	8,50	DIS	TRW	Ford Fusion	per albero minorato distributore (alte temperature)
F-00138	2	1PM	19,90		39,90		6,50	DIS	Saginaw	Fiat Bravo, Brava	originale/genuine
F-00429	2	2	20,00		26,00		3,00	DIS	ZF		
F-00971	2	0M	20,00		27,00		4,76	DIS			
F-00681	2	1PM	20,00		30,00	5,00	5,20	DIS			originale/genuine
F-00887	2	1PM	20,00		30,00	5,00	5,20	DIS			originale/genuine
CT24110	2	1PM	20,00		30,00	5,00	6,00	DIS		Bmw X3	Originale/genuine
F-00063	2	1PM	20,00		30,00	5,00	6,00	DIS	ZF	Renault, Scorpio, Peugeot, Toyota	
F-00663	2	1PM	20,00		30,00	5,00	6,00	DIS	ZF	Renault, Scorpio, Peugeot, Toyota	originale/genuine
F-00978	2	1PM	20,00		30,00	5,00	6,00	DIS		Mercedes, Toyota	Genuin
F-00297	2	1PM	20,00		30,00	4,90	6,10	DIS		Mazda	alta pressione
F-00147	2	1PM	20,00		30,00		7,00	POM		Land Rover, Daimler, Montego, Maestro	
F-00508	2	0M2	20,00		30,00		8,00	POM		veicoli commerciali	alte temperature
F-00054	2	1PM	20,00		30,00	7,00	8,00	DIS	ZF		originale/genuine
F-00666	2	1PM	20,00		30,00	7,00	8,00	DIS			
F-00884	2	1PM	20,00		30,10	7,00	7,50				
F-00558	2	1PM	20,00		30,20	5,00	6,00	DIS		Mercedes, Toyota	
F-00945	2	12	20,00		31,00		5,00			VW Transporter	parapolvere VW Transporter
F-00596	2	0M	20,00		32,00		5,00	DIS		Tata	
F-00891	2	0MA	20,00		32,00		5,00	DIS		Tata	originale/genuine
F-00058	2	1PM	20,00		32,00	5,00	5,50	DIS	ZF	Citroen BX, Xantia	
F-00882	2	12	20,00		32,00		7,50			Cherokee	
F-00413	2	1PM	20,00		32,00		8,00	POM		Mazda	
F-00217	2	7V2	20,00		32,10		8,50	CRE			
F-00084	2	8	20,00		33,00	1,60	2,00	DIS		Bendix	parapolvere
F-00703	2	0M2	20,00		34,00		8,00	POM	Koyo	Isuzu - Touareg- Mitsubishi-Kayaba	abbinare al paraolio F-00702
F-00840	2	1PM	20,00		34,10	6,00	7,00	DIS	Mando	Jeep	
F-01004	2	1PM	20,00		34,10	6,00	7,00	DIS	Mando	Jeep	originale-genuine
F-00161	2	1PM	20,00		34,10	7,00	7,00	POM		Rover 600	

CRE	Cremagliera	Rack	Гидроцилиндр
DIS	Distributore	Pignon	Распределитель
PIS	Pistone	Piston	Поршень
POM	Pompa	Pump	Насос
SCA	Scatola	Box	Корпус редуктора

Codice Code Код	Min Ord Мин. коли- чество заказа	Dis. Drawing Тип сальника	d1	d2	D	h1	H	Uso Use in Приме- нение	Marca Brand Произво- дитель агрегата	Tipo auto Vehicle type Тип авто	Note Remarks Примечания
F-00216	2	7V2	20,00		34,20		9,00	CRE		Isuzu	
F-00335	2	spec.	20,00		35,00		4,00	DIS		Wiper Jaguar J40	
F-00609	2	1PM	20,00		35,00		7,00	DIS		Isuzu Trooper, Vauxall Monterey	
F-00390	2	1PM	20,00		35,00	6,00	7,00	POM		Alfa 155 ,Cherokee, Astra	standard
F-00391	2	1PM	20,00		35,00	6,00	7,00	POM		Alfa 155 ,Cherokee, Astra	alte temperature
F-00640	2	1PM	20,00		35,00	6,00	7,00	POM		Alfa 155,Cherokee,Astra	standard
F-00153	2	0M2	20,00		35,00		8,00	POM	ZF	Bmw, Ducato	
F-00502	2	0M2	20,00		35,00		8,00	POM		Fiat Ducato	alte temperature
F-00562	2	1PM	20,00		35,60	6,00	7,70	DIS		Jeep Grand Cherokee	
F-00166	2	1PM	20,00		36,00		7,00	POM			
F-00736	2	0M2	20,00		36,00		8,00	POM		Mazda	doppio labbro
F-00186	2	1PM	20,00		40,00		6,00	DIS	Saginaw	Fiorino, Opel Vectra 96, Sintra	alte temperature
F-00100	2	1PM	20,00		40,00		6,30	DIS	Saginaw	Saab	
F-00159	2	0M2	20,00		40,00		8,00	POM			alte temperature
F-00643	2	0M2	20,00		40,00		8,00	POM			alte temperature
F-00920	2	0M2	20,00		40,00		8,00	POM	LUK	Luk	Luk
F-00728	2	1PA	20,00		41,00		6,50	DIS		Mondeo Ultimo tipo	
F-00511	2	1PM	20,00		42,00		7,00	POM		veicoli commerciali	alte temperature
F-00761	2	1PM	20,00		42,30	7,00	9,30	DIS	TRW	Mazda	distributore sup.
F-00420	2	1PM	20,00		42,50		4,80	DIS	TRW	Alfa 156	
F-00108	2	1PM	20,00		42,50	3,80	5,00	DIS	TRW	Alfa 166,156	
F-00109	2	1PM	20,00		42,50	7,00	8,00	DIS	TRW	Mercedes, Mazda	
F-00449	2	1PM	20,00		42,50	9,00	10,00	DIS		Mercedes	
F-00104	2	3	20,00		44,00		3,50	DIS	TRW	Mercedes Vito Sprinter	parapolvere
F-00191	2	3	20,00		44,00		4,50	DIS	TRW	VW Sharan	parapolvere
F-00997	2	1PM	20,00		44,50	3,80	5,00	DIS	TRW		Maggiorato esternamente sulla parte esterna
F-00645	2	3G	20,00		55,00	7,50	9,00	DIS		Bmw-Mini	parapolvere
F-00614	2	1PM	20,20		32,00		8,00	POM		Honda Accura	rotazione DX
CT23956	2	0M	20,20		38,00		7,20	DIS		Amc Pacer 1978	
F-00516	2	1PM	20,50		34,20	7,00	7,50	DIS		Toyota Celica	righe dx e sx
F-00815	2	8	20,50		46,00	3,30	5,00	DIS		Ford C-Max	parapolvere
F-00326	2	1PM	20,55		31,97		6,35	CRE		Rolls Royce	
F-00020	2	1PM	20,60		30,70	4,57	6,00	DIS	TRW	Granada	viton
F-00453	2	1PM	20,60		32,00	6,00	7,00	DIS		MK2 Land Rover - Discovery	
F-00576	2	1PM	20,60		35,63	6,30	7,50	DIS		Dodge	
CT21996	2	0M	20,60		41,00		6,50	DIS		S-Max anno 2006	Distributore inferiore
F-00531	2	1PM	20,60		41,30	6,50	8,00	DIS	TRW	Ford Fusion	alte temperature
F-00168	2	0M	20,68		41,20		6,30	DIS		Ford Mondeo, Fiesta	distributore sup. esterno
F-00667	2	0M	20,68		41,20		6,30	DIS		Mondeo, Fiesta	originale/genuine distributore sup.
F-00720	2	0M	20,68		41,20		6,30	DIS		Ford Mondeo, Fiesta	originale/genuine distributore sup.

INFORMAZIONE TIP РЕКОМЕНДАЦИИ

I paraoli minorati sono identificati con la lettera finale «X»
Esempio F-00024: dimensioni normali - F-00024X: minorato
Reduced seals are identified with final letter «X»
Example F-00024: regular sizes - F-00024X: reduced seal
Сальники, обозначенные буквой «X», являются аналогами стандартных сальников с уменьшенным внутренним диаметром
Например: F-00024 - стандартный F-00024X - с уменьшенным внутренним диаметром



Codice Code Код	Min Ord Мин. коли- чество заказа	Dis. Drawing Тип сальника	d1	d2	D	h1	H	Uso Use in Приме- нение	Marca Brand Произво- дитель агрегата	Tipo auto Vehicle type Тип авто	Note Remarks Примечания
F-00493	2	1PM	20,70		41,50	6,00	8,00	DIS		Ford Fiesta ultimo tipo,Fusion	originale/genuine alte temperature
F-00218	2	7V2G	21,00		29,50		6,00	CRE		Honda	con interno in P.A.
F-00328	2	7V2G	21,00		30,00		5,00	CRE		Honda	P.A.
F-00330	2	7V2G	21,00		30,00		5,00	CRE		Honda	
F-00554	2	0M2	21,00		32,00		7,00	POM	LUK	Luk, Vichers	
CT20945	2	1PM	21,00		33,00	5,50	7,00	DIS		Jeep Wrangler	distributore sup.
F-00605	2	1PM	21,00		33,00	8,00	9,50	DIS		Mercedes	
F-00442	2	1PM	21,00		33,00	8,00	10,00	DIS		Mercedes	
F-00547	2	7V2	21,00		34,00		9,00	CRE		Subaru Justy	
F-00912	2	0M2	21,00		35,00		7,00	POM			Pompa LUK
F-00778	2	0M2	21,00		35,00		8,00	POM			
F-00327	2	7V2G	21,10		29,50		6,00	CRE		Honda	con interno PTFE
F-00329	2	12	21,10		30,00		5,25	CRE		Honda	in poliuretano minorato con P.T.F.E.
F-00497X	2	4	21,50		34,50	8,00	13,00	CRE		Ford Fiesta ultimo tipo	minorato
F-00494X	2	7V1	21,50		35,50		7,50	CRE		Ford Fiesta ultimo tipo,Fusion	con tenuta esterna da Ø32,4
F-00679	2	0M	22,00		30,00		4,50	DIS		Rover 3,4 Bulloni	con tenuta esterna da Ø32,4
F-00893	2	0M	22,00		30,00		4,50	DIS		Rover 3,4 Bulloni	con tenuta esterna da Ø32,4
F-00083	2	12	22,00		31,00		4,00			Renault	
F-00050	2	12	22,00		31,00		4,50	DIS		Rover 3,4 Bulloni	
F-00393	2	12	22,00		31,00		5,00	CRE		Suzuki Swift-Subaru	
F-00929	2	12	22,00		31,00		5,50	CRE		Honda	
F-00027	2	0M	22,00		31,00		6,50	CRE	ZF	Porsche	originale/genuine
F-00125	2	6V3	22,00		31,50	4,70	7,80	CRE	Saginaw		
F-00425	2	0M	22,00		32,00		5,50	DIS		Rover 4 Bulloni	
F-00284	2	6V2	22,00		32,00	4,00	6,00	CRE		Opel Corsa	
F-00193	2	1PM	22,00		32,00	5,00	6,00	DIS		Peugeot 505 Alta temperatura	
F-00680	2	1PM	22,00		32,00	5,00	6,00	DIS		Peugeot	originale/genuine distributore sup.
F-00890	2	1PM	22,00		32,00	5,00	6,00	DIS		Peugeot	originale/genuine
F-00322	2	12	22,00		32,00		6,50	CRE		Mazda	
F-00690	2	1PM	22,00		32,00		7,00	DIS			
F-00061	2	1PM	22,00		32,00	7,00	7,50	POM	ZF	Volvo	
F-00708	2	4PM	22,00		32,00	5,20	8,00	DIS		Mercedes	
F-00192	2	0M	22,00		32,10		5,00	DIS		Rover 4 Bulloni	
F-00098	2	7V2	22,00		32,10		7,00	CRE	Smi-Koyo	Toyota	
F-00325	2	0M	22,00		32,10		7,00	CRE	ZF	Ford Sierra	
F-00938	2	1PM	22,00		32,30	5,00	5,20	DIS		Subaru Forester	Distributore superiore
F-00345	2	8	22,00		33,20	1,60	3,00	DIS		Rover 3,4 Bulloni	
F-00807A	2	2	22,00		33,80		4,00	CRE		Hyundai Atos-	raschiatore Ø22 da abbinare al paraolio F-00807
F-00127	2	0M	22,00		34,00		7,50	DIS	ZF		
F-00280	2	7V2	22,00		34,00		8,50	CRE		Toyota	
F-00796	2	7V1	22,00		34,20		8,00	CRE		Daihatsu	
F-00497	2	4	22,00		34,50	7,00	12,00	CRE		Ford Fiesta ultimo tipo	con P.T.F.E.

CRE	Cremagliera	Rack	Гидроцилиндр
DIS	Distributore	Pignon	Распределитель
PIS	Pistone	Piston	Поршень
POM	Pompa	Pump	Насос
SCA	Scatola	Box	Корпус редуктора

Codice Code Код	Min Ord Мин. коли- чество заказа	Dis. Drawing Тип сальника	d1	d2	D	h1	H	Uso Use in Приме- нение	Marca Brand Произво- дитель агрегата	Tipo auto Vehicle type Тип авто	Note Remarks Примечания
F-00304	2	0M	22,00		35,00		6,50	DIS		A & A	
F-00889	2	0M	22,00		35,00		6,50	DIS		A&A	originale/genuine
F-00333	2	0M	22,00		35,00		7,00	DIS	ZF	Porsche	
F-00610	2	1PM	22,00		35,00		7,00	DIS		Nissan	
F-00969	2	0M2	22,00		35,00		7,00				
F-00119	2	4	22,00		35,00	4,30	7,00	DIS	TRW		con o-ring di tenuta
F-00381	2	7V2	22,00		35,00		8,00	CRE		Suzuki Swift	
F-00806	2	7V1PM	22,00		35,00	9,00	10,00	CRE	Mando	Hyundai Atos 2001	
F-00053	2	1PM	22,00		35,10		7,00	DIS			standard
F-00948	2	7V1PM	22,00		35,10	9,00	10,00	CRE	Mando	Hyundai Atos 2001	originale/genuine
CT23279	2	0MA	22,00		35,20		8,00			Golf brasilie	originale/genuine
F-00219	2	7V2	22,00		35,20		8,50	CRE		Toyota	con PTFE eterno
CT22784	2		22,00		35,30		8,50	POM		Toyota	Pompa Toyota
F-00670	2	7V1	22,00		35,30		8,60	CRE		Toyota Yaris	con PTFE interno
F-00283	2	7V3	22,00		35,30	10,00	15,50	CRE		Opel Corsa	
F-00494	2	7V2	22,00		35,50		7,90	CRE		Ford Fiesta ultimo tipo,Fusion	
F-00220	2	7V2	22,00		36,60		8,00	CRE		Toyota	
F-00512	2	7V1	22,00		38,20		8,00	CRE		Toyota Yaris	
F-00807	2	7V1PM	22,00		38,20	13,00	14,00	CRE	Mando	Hyundai Atos 2001	
F-00949	2	7V1PM	22,00		38,20	13,00	14,00	CRE	Mando	Hyundai Atos 2001	originale/genuine
F-00222	2	7V2	22,00		38,30		8,00	CRE		Toyota Tercel	
F-00221	2	7V2	22,00		38,40		8,00	CRE		Nissan	
F-00797	2	7V1	22,00		38,40		8,00	CRE		Daihatsu	
F-00672	2	7V1	22,00		38,40		8,60	CRE		Toyota Yaris	con PTFE interno
F-00513	2	7V1A	22,00		38,50		8,00	CRE		Toyota Yaris	
F-00123	2	7V3	22,00		39,40	10,00	12,60	CRE	Saginaw		
F-00338	2	spec.	22,00		40,00		4,00	DIS		Wiper Rover 4 Bulloni	
F-00918	2	1PM	22,00		40,00		7,00	POM		Umm Jabata	
F-00867	2	0M2	22,00		40,30		7,00	POM		Bosch	pompa Bosch
CT22704	2	3G	22,00		45,50	1,30	4,50			HFB70 DAF, Scania	parapolvere
F-00746	2	0	22,00	28,50	28,50	4,00	4,00	DIS			distributore inf.
F-00656	2	2	22,17		28,54		3,20	DIS	TRW		
F-00748	2	1PM	22,20		31,90	6,00	7,50	DIS		Mitsubishi Diamante	distributore sup.
F-00069	2	1PM	22,20		32,00	5,00	6,00	DIS		Peugeot 505 azzurro	
F-00759	2	1PM	22,20		32,00	5,00	6,00	DIS		Peugeot 505, Citroen	originale/genuine
F-00759M	2	1PM	22,20		32,00	5,00	6,00	DIS		Peugeot 505, Citroen	
F-00344	2	12	22,20		33,20		4,00	DIS		Jaguar Granada	
F-00177	2	1PM	22,20		35,00		7,00	DIS		Isuzu, Frontera, Trooper	
F-00305	2	8A	22,20		42,80		14,70	DIS	TRW		
F-00834	2	1PM	22,22		40,60	6,00	7,50	DIS	TRW		right DX E SX
F-00528	2	1PM	22,23		35,15		9,50	DIS		veicoli commerciali	
F-00898	2	1PM	22,23		35,15	9,50	9,50	DIS		veicoli commerciali	originale/genuine
F-00526	2	1PM	22,30		32,20	5,40	6,50	DIS		Suzuki Baleno	
F-00349	2	12	22,50		29,00		3,60	DIS		Stag	in gomma
F-00024X	2	7V1	22,50		34,50		7,00	CRE		Fiat Tipo, Regata, VW Golf	minorato
CT22605	2	6V1	22,50	34,30	38,00	3,20	8,00	CRE		VW Golf	Paraolio cremagliera Vw Golf (minorato)

Gli articoli identificati con l'iniziale «CT» (codice temporaneo) sono attualmente in fase di test e prossimi all'introduzione definitiva nel mercato.

*Items whose code starts with «CT» (temporary code) are currently being tested and they are candidate to be introduced in the market soon.
Пункты, обозначенные аббревиатурой «CT» (временный код), в данный момент проходят испытания и будут представлены на рынок в ближайшее время.*



Codice Code Код	Min Ord Мин. коли- чество заказа	Dis. Drawing Тип сальника	d1	d2	D	h1	H	Uso Use in Приме- нение	Marca Brand Произво- дитель агрегата	Tipo auto Vehicle type Тип авто	Note Remarks Примечания
• F-00901	2	7V2	22,80		33,50		6,00	CRE	TRW	Kirby	
F-00363	2	12	23,00		29,50	5,00	7,00	DIS	TRW	Trattori movimento terra	con P.T.F.E.
F-00865	2	0	23,00		29,70		4,00	DIS		Sierra, Thema, Ducato	originale/genuine
F-00019	2	0M	23,00		29,75		4,50	DIS	TRW		viton
F-00278	2	12	23,00		30,00		5,00	DIS		Subaru	
• CT23451	2	12	23,00		32,00		5,00				
F-00739	2	6V1	23,00		32,50	5,50	7,50	CRE	TRW	Skoda, VW Polo U.T.	
F-00440	2	6V2	23,00		32,90	6,00	8,00	CRE	TRW	Skoda, VW Polo- UT	
• F-00936	2	7V2	23,00		33,50		6,00	CRE		Ford	
F-00097	2	0M	23,00		34,10		6,50	DIS		Toyota Corolla	
F-00012	2	7V2	23,00		34,40		6,35	CRE	TRW	Fiat Tipo, Regata, Golf	
F-00024	2	7V2	23,00		34,50		6,50	CRE	TRW	Fiat Tipo, Regata, Golf	originale/genuine
F-00396	2	7V2	23,00		34,55		6,50	CRE	TRW	Golf, Ford, VW	originale/genuine America
• CT23278	2	7V2	23,00		34,60		6,35	CRE		Golf Brasile	originale/genuine
• F-00916	2	0M	23,00		35,00		6,50	DIS		Ssangyong	
F-00194	2	1PM	23,00		35,00	6,50	7,00	DIS		Mitsubishi, Toyota	
F-00223	2	7V2	23,00		37,20		9,00	CRE		Subaru, Isuzu	
F-00362	2	9	23,00		38,00	5,00	7,00	DIS	TRW	Trattori movimento terra	
F-00195	2	0M	23,00		38,10		6,80	DIS		Mitsubishi, Hyundai Atos	
F-00499	2	7V2	23,00		38,20		8,00	CRE		Mazda MX5	
F-00402	2	7V2	23,00		38,20		9,00	CRE		Suzuki Baleno, Mazda MX5	
F-00224	2	7V2	23,00		40,20		9,00	CRE		Subaru	
F-00292	2	7V2	23,00		41,20		8,00	CRE		Mazda	
• F-00926	2	7V1	23,00		41,20		8,50	CRE		Subaru	Cremagliera Subaru Forester
F-00225	2	7V2	23,00		41,20		9,00	CRE		Subaru	
F-00079	2	7V2	23,00		48,60		7,50	CRE		Nevada, Renault	originale/genuine
F-00995	2	3G	23,00		54,00		8,00			TAS 75	parapolvere
F-00018	2	6V2	23,00	34,20	38,00	3,20	8,00	CRE	TRW	Fiat Tipo, Regata, Golf	standard
F-00035	2	6V2	23,00	34,20	38,00	3,20	8,00	CRE	TRW	Fiat Tipo, Regata, Golf	originale/genuine
F-00034	2	6V2	23,00	34,20	40,00	3,20	7,50	CRE	TRW	Fiat Tipo I serie	originale/genuine
F-00441	2	6V2	23,00	34,30	38,00	3,20	8,00	CRE	TRW	VW Golf	originale/genuine America
F-00642	2	6V2	23,00	34,30	38,20	5,00	8,20	CRE		Mazda	
F-00016	2	6V2	23,00	34,50	40,00	3,20	7,50	CRE	TRW	Fiat Tipo I. Serie	
F-00032	2	0	23,30		29,70		4,00	DIS	TRW	Sierra, Thema, Ducato	standard
F-00036	2	0	23,30		29,70		4,00	DIS	TRW	Sierra, Thema, Ducato	originale/genuine
F-00296	2	4	23,30		30,00	4,00	6,00	DIS	TRW	Ford	
F-00359	2	1PM	23,30		37,00		7,30	DIS		Citroen XM, Xara	
F-00590	2	0M	23,30		37,50		5,50	DIS		Kia Rio	con inserto metallico inserito (speciale) ultimo tipo
F-00118	2	0M	23,35		29,75		4,50	DIS	TRW	Bmw Z3, Mazda	distributore inf. alta temperatura
F-00758	2	0M	23,35		29,80		4,50	DIS	TRW	Bmw Z3, Mazda	

**Paraoli**Seals
Сальники**in ordine di Øint.**sorted by int.Ø
сортировка по размеру

CRE	Cremagliera	Rack	Гидроцилиндр
DIS	Distributore	Pignon	Распределитель
PIS	Pistone	Piston	Поршень
POM	Pompa	Pump	Насос
SCA	Scatola	Box	Корпус редуктора

Codice Code Код	Min Ord Мин. коли- чество заказа	Dis. Drawing Тип сальника	d1	d2	D	h1	H	Uso Use in Приме- нение	Marca Brand Произво- дитель агрегата	Tipo auto Vehicle type Тип авто	Note Remarks Примечания
			Размеры								
F-00082	2	4	23,40		29,80	1,70	4,50	DIS	TRW	Volvo	originale/genuine
F-00082A	2	4	23,40		29,80	1,70	4,50	DIS	TRW	Volvo	
F-00086	2	4	23,40		30,00	4,00	6,70	DIS	TRW	Golf	viton
F-00130	2	4	23,40		30,00	4,00	6,70	DIS	TRW	Golf	originale/genuine viton-alte temperature
F-00410	2	1PM	23,40		37,30	8,00	8,20	DIS		Citroen XM	
F-00820	2	1PM	23,50		32,50	5,00	5,30	DIS		Nissan Pathfinder,Navara	distributore inf.
F-00837	2	1PM	23,50		32,70	5,00	5,35	DIS		Nissan	originale/genuine
F-00763	2	7V2	23,50		33,60		6,00	CRE			
F-00933	2	7V2	23,50		37,00		8,50	DIS			
F-00121X	2	7V1	23,50		37,20		8,50	CRE		A3,Octavia VW PSA	minorato
F-00397X	2	7V1	23,50		39,00	8,50	16,50	CRE	ZF	Golf, Octavia, Scoda Felicia	
F-00090X	2	7V1	23,50		39,20		8,50	CRE		Opel Vectra, Renault, VW	minorato
F-00474X	2	7V1	23,50		39,20		8,50	CRE		Opel Vectra, Renault, VW	minorato
F-00927	2	1PM	24,00		32,50	5,40	5,45	DIS		Nissan Murano	
F-00332	2	0M	24,00		33,00		5,00	DIS	ZF	Volkswage,Opel	
F-00089	2	1PM	24,00		33,00	5,00	6,00	DIS	ZF	A 3,Golf, Octavia	
F-00028	2	0M	24,00		33,00		7,00	CRE	ZF	Volvo	originale/genuine
F-00348	2	12	24,00		34,00		4,00	DIS		Jaguar, Granada MKI	
F-00285	2	7V2G	24,00		34,00		6,00	CRE		Honda	
F-00236	2	7V2	24,00		34,10		7,00	CRE		Nissan	
CT23020	2		24,00		35,00		11,30	CRE		VW PQ 35 Gen III	VW PQ 35 Gen III
F-00783	2	7V1	24,00		35,10		8,50	CRE		Seat Ibiza Polo Lupo Felicia SMI	originale/genuine
F-00651	2	7V1	24,00		35,20		8,50	CRE		Seat Ibiza Polo Lupo Felicia SMI	
F-00831	2	7V1	24,00		35,20		8,50	CRE		Mitsubishi	originale/genuine
F-00239	2	7V1	24,00		35,30		12,00	CRE		Mitsubishi	
F-00078	2	0M	24,00		36,00		7,00	CRE		Renault, Espace	originale/genuine
F-00198	2	7V2	24,00		36,00		7,00	CRE		Nissan	
F-00295	2	0M	24,00		36,00		7,00	DIS		Subaru	
F-00496	2	1PM	24,00		36,00	7,00	8,00	DIS		Nissan	
F-00476	2	7V2A	24,00		36,00		17,70	CRE		Peugeot 206	
F-00237	2	7V2	24,00		36,30		8,00	CRE		Toyota	
CT23280	2	7V2	24,00		36,50		7,50	CRE		Renault Clio II	originale/genuine
F-00360	2	7V1	24,00		36,50		7,50	CRE		Peugeot, Renault	originale/genuine
F-00966	2	7V1PM	24,00		36,50	9,00	10,00	CRE		Hyundai Jeez/Accent 2000-05	
F-00287	2	7V2	24,00		36,50		12,00	CRE		Mitsubishi	
F-00226	2	7V2	24,00		36,60		8,50	CRE		Mitsubishi, Renault, Hyundai	originale/genuin
F-00833	2	7V1	24,00		36,60		8,50	CRE		Hyundai	
F-00823	2	0M	24,00		37,00		5,00	DIS		Bmw	distributore inf. BMW
F-00077	2	4A	24,00		37,00	14,50	20,00	CRE		Renault, Espace	originale/genuine
F-00048	2	0M	24,00		37,10		7,00	DIS CRE	ZF	Bmw	originale/genuine
F-00095	2	7V2	24,00		37,10		8,00	CRE	Smi-Koyo	Renault Laguna Safrane, VW	

INFORMAZIONE TIP РЕКОМЕНДАЦИИ

I paraoli minorati sono identificati con la lettera finale «X»
Esempio F-00024: dimensioni normali - F-00024X: minorato
Reduced seals are identified with final letter «X»
Example F-00024: regular sizes - F-00024X: reduced seal
Сальники, обозначенные буквой «X», являются аналогами стандартных сальников с уменьшенным внутренним диаметром
Например: F-00024 - стандартный F-00024X - с уменьшенным внутренним диаметром



Codice Code Код	Min Ord Мин. коли- чество заказа	Dis. Drawing Тип сальника	d1	d2	D	h1	H	Uso Use in Приме- нение	Marca Brand Произво- дитель агрегата	Tipo auto Vehicle type Тип авто	Note Remarks Примечания
F-00830	2	7V1	24,00		37,10		8,50	CRE		Seat Ibiza Polo Lupo Felicia SMI	originale/genuine
F-00705	2	7V2	24,00		37,10		15,00	CRE	ZF		con P.T.F.E.
F-00445	2	7V3	24,00		37,10	15,00	17,00	CRE		Saab 9-5	con segmento P.T.F.E. esterno
F-00121	2	7V2	24,00		37,20		8,50	CRE	ZF	A3, Octavia VW PSA	
F-00652	2	7V1	24,00		37,20		8,50	CRE		Seat Ibiza Polo Lupo Felicia SMI	
F-00227	2	7V2	24,00		37,60		8,50	CRE		Subaru	originale/genuine
● CT22504	2	0M	24,00		38,00		6,50			Nissan Altima 2007	
F-00387	2	0M	24,00		38,00		7,00	DIS		Volvo	
F-00612	2	7V1	24,00		38,00		8,00	CRE		Honda CRV	
F-00829	2	7V1	24,00		38,10		7,00	CRE		Saab 9.3	originale/genuine
F-00716	2	7V1	24,00		38,20		7,00	CRE		Saab 9.35	
F-00543	2	7V1	24,00		38,20		8,50	CRE		Toyota Corolla	
F-00238	2	7V1	24,00		38,20		12,50	CRE		Mitsubishi, Volvo V4-V70	
F-00229	2	7V2	24,00		38,30		8,50	CRE		Toyota	
● CT23056	2	7V1PM	24,00		38,50	9,00	10,00	CRE	Mando	Hyundai Matrix, Jazz	
F-00397	2	7V2	24,00		39,00	8,50	16,50	CRE	ZF	Golf, Octavia, Skoda Felicia	
F-00474	2	7V1	24,00		39,10		8,50	CRE		Bmw - Mini	con back ring interno con back ring esterno
F-00090	2	7V2	24,00		39,20		8,50	CRE	ZF	Opel Vectra, Renault VW	
F-00717	2	7V2	24,00		39,50		7,00	CRE		Saab 9,35	
F-00228	2	7V1	24,00		40,00		7,00	CRE		Nissan	
F-00240	2	7V1	24,00		40,00		8,50	CRE		Nissan	
F-00668	2	7V1	24,00		40,10		9,50	CRE		Honda Civic	
F-00230	2	7V2	24,00		40,20		8,00	CRE		Toyota	
● F-00983	2	7V1	24,00		40,20		8,00	CRE		Toyota	
F-00231	2	7V1	24,00		41,00		8,50	CRE		Toyota Corolla	
F-00291	2	7V1	24,00		41,00		12,50	CRE		Mitsubishi	
F-00515	2	7V2	24,00		41,10		8,50	CRE	ZF	Jaguar X TYPE	
● F-00878	2	7V2	24,00		41,20		8,50	CRE		Toyota Corolla	
● F-00917	2	7V1	24,00		41,20		8,50	CRE		Opel Astra H	
F-00407	2	7V1	24,00		42,00		8,00	CRE	Saginaw	Honda	
F-00426	2	7V1	24,00		42,00		8,00	CRE		Honda	
F-00233	2	7V2	24,00		42,00		9,00	CRE		Toyota	
F-00232	2	7V2	24,00		42,10		8,50	CRE		Mitsubishi	
F-00965	2	7V1PM	24,00		42,50	9,00	10,00	CRE		Hyundai Jeez/Accent 2000-05	
F-00171	2	7V1	24,00		42,50		13,00	CRE		Hyundai, Lantra	
F-00818	2	7V1	24,00		42,60		8,50	CRE	TRW	Honda Accord V6 2003,05	
F-00099	2	1PMA	24,00		43,00		8,50	POM	Smi-Koyo	Toyota Landcruiser	
F-00599	2	7V1	24,00		43,00		8,50	CRE		Nissan	
F-00234	2	7V2	24,00		43,10		7,00	CRE		Nissan	
● F-00919	2	7V2	24,00		44,00	1,60	20,50	CRE	ZF	Audi Q5/ B8/ A6	
F-00712	2	7V1	24,00		44,30		9,50	CRE			
F-00235	2	7V2	24,00		45,00		7,00	CRE		Nissan	
● F-00941	2	7V1	24,00		50,00		9,00	CRE		Nissan Murano	originale/genuine
F-00738	2	6V2	24,00	35,20	39,00	9,00	13,90	CRE		VW PQ35	originale/genuine

**Paraoli**Seals
Сальники**in ordine di Øint.**sorted by int.Ø
сортировка по размеру

CRE	Cremagliera	Rack	Гидроцилиндр
DIS	Distributore	Pignon	Распределитель
PIS	Pistone	Piston	Поршень
POM	Pompa	Pump	Насос
SCA	Scatola	Box	Корпус редуктора

Codice Code Код	Min Ord Мин. коли- чество заказа	Dis. Drawing Тип сальника	d1	d2	D	h1	H	Uso Use in Приме- нение	Marca Brand Произво- дитель агрегата	Tipo auto Vehicle type Тип авто	Note Remarks Примечания
			Размеры								
F-00601	2	6V2MA	24,00	36,00	37,00	8,50	17,70	CRE		Peugeot 206	
F-00711	2	0M	24,40		35,00		6,00	DIS			
F-00888	2	0M	24,40		35,00		6,00	DIS			
F-00392	2	2	24,50		31,00		4,50	DIS	TRW	Ford	distributore inf.
F-00730	2	0	24,50		31,00		4,50	DIS		Ford	distributore inf.
• F-00038X	2	7V1	24,50		37,54		6,50	CRE	TRW	Thema, Croma, Mondeo, Fiesta, Chrysler, Nissan, Mazda	minorato
• F-00467X	2	6V1	24,50	37,80	41,80	3,30	7,50	CRE		Ford Mondeo - Fiesta(ultimo tipo)	
F-00014	2	7V2	24,97		37,54		6,35	CRE	TRW	Fiat Croma - Thema	standard
F-00038	2	7V2	24,97		37,54		6,35	CRE	TRW	Thema, Croma, Mondeo, Fiesta, Chrysler, Nissan, Mazda	originale/genuine
F-00764	2	6V2	24,97	37,80	41,30	3,00	7,40	CRE	TRW	Fiat Croma-Thema	originale/genuine
F-00015	2	6V2	24,97	37,80	41,30	3,20	7,40	CRE	TRW	Fiat Croma - Thema	standard
• F-00911	2	6V2	24,97	37,80	41,30	3,30	7,50	CRE	TRW	Dodge, Jeep 2007-08	originale/genuine
F-00324	2	7V3G	25,00		32,00	3,70	5,50	CRE		Lotus	P.T.F.E. + paraolio
F-00294	2	7V3G	25,00		33,00	5,00	5,50	CRE		Subaru	
F-00064	2	0M	25,00		33,00		6,00	DIS			
F-00301	2	0M	25,00		34,00		5,00	DIS		Ford	
F-00312	2	0M	25,00		34,00		5,00	DIS	ZF	Saab 900,9000 Toyota Carina	
F-00489	2	12	25,00		34,00		5,00	CRE		Honda - Suzuki Gran Vitara	originale/genuine
F-00311	2	1PM	25,00		34,00	6,00	6,50	DIS		Mazda	
F-00196	2	0M	25,00		34,00		7,00	DIS	ZF	Calibra,Mercedes	
F-00422	2	0M	25,00		34,00		7,00	CRE		Mercedes	
F-00010	2	2	25,00		35,00		5,50	DIS	TRW	Fiat 131	
F-00321	2	12	25,00		35,00		6,00	CRE		Mazda	
F-00135	2	6V2	25,00		35,00	3,20	6,50	CRE	Saginaw	Vectra-Fiat Fiorino-Bravo-Brava	
F-00199	2	0M	25,00		35,00		7,00	DIS		Toyota	
F-00509	2	0M2	25,00		35,00		7,00	POM		veicoli commerciali	
F-00009	2	1PM	25,00		35,00	6,90	7,00	DIS	TRW		
F-00245	2	7V2	25,00		35,00		8,00	CRE		Nissan	
• F-00245M	2	7V1	25,00		35,00		8,00	CRE		Nissan	
F-00598	2	0M2	25,00		35,00		8,00	POM			
F-00631	2	0M2	25,00		35,00		8,00	POM			
F-00615	2	1PMA	25,00		35,00	6,80	8,00	POM	ZF		
F-00696	2	0M	25,00		35,10		6,00	DIS		Celica	righe DX e SX
F-00406	2	6V2	25,00		35,20	3,70	6,50	CRE	Saginaw	Fiat Fiorino-Opel Vectra	
F-00724	2	4	25,00		35,20	3,50	7,60	DIS			distributore inf.
F-00412	2	12	25,00		35,40		6,30	CRE		Mazda	
F-00500	2	0M	25,00		35,80		6,80	DIS		Toyota	
F-00530	2	0M	25,00		36,00		5,00	DIS		Nissan Sanny, 240SX,300ZX	
F-00423	2	7V2	25,00		36,00		8,50	CRE		Mercedes	
F-00721	2	1PM	25,00		37,00	6,00	6,50	DIS	ZF-LUK		
F-00353	2	0M	25,00		37,00		6,70	DIS		Burman	
F-00071	2	7V2	25,00		37,00		7,00	CRE		Renault	originale/genuine

Gli articoli identificati con l'iniziale «CT» (codice temporaneo) sono attualmente in fase di test e prossimi all'introduzione definitiva nel mercato.

Items whose code starts with «CT» (temporary code) are currently being tested and they are candidate to be introduced in the market soon.
Пункты, обозначенные аббревиатурой «CT» (временный код), в данный момент проходят испытания и будут представлены на рынок в ближайшее время.



Codice Code Код	Min Ord Мин. коли- чество заказа	Dis. Drawing Тип сальника	d1	d2	D	h1	H	Uso Use in Приме- нение	Marca Brand Произво- дитель агрегата	Tipo auto Vehicle type Тип авто	Note Remarks Примечания
F-00713	2	7V2	25,00		37,10		9,00	CRE			
F-00093	2	7V2	25,00		37,20		8,50	CRE	Smi-Koyo	Renault Laguna Safrane	
F-00243	2	7V2	25,00		37,50		7,00	CRE		Ford Mazda	
F-00844	2	7V1	25,00		37,70		8,00	CRE		Kia	originale/genuine
F-00334	2	12	25,00		37,70		9,30	CRE		Austin 1800,2200	
F-00653	2	7V2	25,00		37,90		6,50	CRE	TRW	Fiat Doblo	
F-00448	2	7V2	25,00		38,00		6,30	CRE	TRW	Rover 75	
F-00031	2	0M	25,00		38,00		7,00	CRE	ZF	Audi	originale/genuine
F-00281	2	7V2	25,00		38,00		8,50	CRE		Volvo	
F-00244	2	7V2	25,00		38,00		9,00	CRE		Nissan	
F-00126	2	7V3	25,00		38,00	10,00	12,50	CRE		Saab 900	
F-00096	2	1PM	25,00		38,10	7,00	8,00	DIS	Smi-Koyo	Toyota	
F-00070	2	7V2	25,00		38,20		7,20	CRE		Renault	originale/genuine
F-00527	2	7V1	25,00		38,50		10,00	CRE		Chrysler neon	
F-00649	2	12	25,00		39,00		6,50	DIS		Rolls Royce	
F-00302	2	0M	25,00		39,00		9,00	CRE			
F-00129	2	7V3	25,00		39,30	10,00	12,70	CRE		Opel Vectra I serie,Saab 9000	
F-00246	2	7V3	25,00		39,50	10,00	12,50	CRE		Fiorino, Vectra 96	
F-00658	2	7V3	25,00		39,50	10,00	12,50	CRE	Saginaw	Fiat Fiorino, Opel Vectra "96.	alte temperature
F-00094	2	7V2	25,00		39,60		8,50	CRE	Smi-Koyo	Renault Laguna Safrane	
F-00731	2	0M2	25,00		40,00		8,00	POM	ZF		doppia molla
F-00819	2	0M2	25,00		40,00		8,00	POM	ZF		doppia molla alta temperatura
• F-00935	2	7V1	25,00		40,00		9,00	CRE		Nissan Almera Classic 2006	Cremagliera Nissan Almera Classic
F-00106	2	7V2	25,00		40,20		7,20	CRE		Megane, Traffic	originale/genuine
• CT22702	2	8	25,00		40,80	1,30	4,00			HFB70 DAF, Scania	Raschiatore
F-00288	2	7V2	25,00		41,00		8,50	CRE		Volvo	
F-00669	2	7V1	25,00		41,10		9,50	CRE		Mazda 6	con labbro parapolvere
F-00534	2	7V2	25,00		41,50		7,50	CRE	TRW	Ford Mondeo ultimo tipo,Focus,	
F-00200	2	1PM	25,00		42,00	6,50	7,00	DIS		Nissan	
F-00411	2	7V2	25,00		42,00		8,00	CRE		Mazda	
F-00120	2	7V3	25,00		42,50	10,00	12,50	CRE	Saginaw	Opel Vectra	
F-00661	2	7V3	25,00		42,60	10,00	12,50	CRE	Saginaw	Opel Vectra	
F-00293	2	7V2	25,00		43,00		7,50	CRE		Mazda	
F-00518	2	7V2	25,00		43,00		8,00	CRE		Suzuki Gran Vitara	
• CT22720	2	7V1	25,00		43,00		9,00	CRE			
F-00241	2	7V2	25,00		43,00		9,00	CRE		Ford Mazda	
F-00846	2	7V2	25,00		43,00		10,00	CRE		Chevrolet Malibu, Pontiac, Saturn	
F-00845	2	7V3	25,00		43,10	10,00	12,60	CRE		Chevrolet Malibu, Pontiac, Saturn	
• CT23446	2	7V2	25,00		43,20		9,00	CRE			originale/genuine
F-00714	2	7V1	25,00		43,20		9,00	CRE			
F-00377	2	7V1	25,00		44,00		9,00	CRE		Nissan Skiline	
F-00824	2	7V2	25,00		44,70		8,40	CRE		Lincoln	
F-00808	2	7V1PM	25,00		45,10	10,00	11,50	CRE		Dodge Caravan	
F-00860	2	7V1PM	25,00		45,10	10,00	11,50	CRE		Dodge Caravan	

CRE	Cremagliera	Rack	Гидроцилиндр
DIS	Distributore	Pignon	Распределитель
PIS	Pistone	Piston	Поршень
POM	Pompa	Pump	Насос
SCA	Scatola	Box	Корпус редуктора

Codice Code Код	Min Ord Мин. коли- чество заказа	Dis. Drawing Тип сальника	d1	d2	D	h1	H	Uso Use in Приме- нение	Marca Brand Произво- дитель агрегата	Tipo auto Vehicle type Тип авто	Note Remarks Примечания
			Размеры								
F-00282	2	7V2	25,00		45,20		8,00	CRE		Nissan	
F-00788	2	0M	25,00		47,00		7,00	DIS			distributore inf.
F-00242	2	7V2	25,00		48,20		10,00	CRE		Ford Mazda	
F-00613	2	6V2	25,00	33,00	37,50	6,00	7,00	CRE		Renault	originale/genuine replacement
F-00072	2	6V3	25,00	33,00	37,50	6,70	8,00	CRE		Renault	originale/genuine
F-00137	2	6V2	25,00	34,60	38,00	4,30	7,60	CRE	TRW		
F-00498	2	6V2	25,00	35,00	38,50	4,30	8,00	CRE	TRW	Porsche Boxter	
F-00107	2	6V3	25,00	35,00	40,00	1,70	10,00	CRE		Renault Megane, Traffic	originale/genuine
● CT24058	2	6V1	25,00	37,70	41,24	5,80	10,00	CRE		Chrysler 2007, Sebring2008	originale/genuin
F-00485	2	6V2	25,00	37,80	41,24	4,40	7,30	CRE	TRW	Volvo ultimo tipo mondeo 2003	
F-00369	2	6V2	25,00	37,80	41,50	3,30	7,50	CRE	TRW	Mondeo, Fiesta (I serie)	originale/genuine
F-00023	2	6V2	25,00	37,80	41,60	3,40	7,70	CRE	TRW	Lancia Thema, Fiat Croma, Volvo	originale/genuine alta temperatura
F-00467	2	6V2	25,00	37,80	41,80	3,30	7,50	CRE		Ford Mondeo – Fiesta (ultimo tipo)	originale/genuine
F-00604	2	6V2	25,00	38,60	44,70		12,40	CRE			
F-00488	2	6V2	25,00	38,70	45,00	6,00	10,00	CRE	TRW	Chrysler Voyager	
F-00525	2	1PM	25,40		38,10		6,35	DIS		Daf Veicolo commerciale	
● CT23043	2	12	25,40		38,10		6,50	CRE		Rolls Royce	
F-00248	2	7V2	25,50		37,70		8,00	CRE		Toyota	
F-00251	2	7V2	25,50		38,70		8,50	CRE		Toyota	
F-00399	2	7V2	25,50		38,80		8,00	CRE		Toyota Land Cruiser	
F-00249	2	7V2	25,50		39,20		8,00	CRE			
F-00252	2	7V2	25,50		39,30		8,50	CRE		Toyota	
F-00524	2	7V1	25,50		39,50		8,50	CRE		Toyota Celica 1999	
F-00250	2	7V2	25,50		39,90		8,00	CRE		Toyota	
F-00379	2	7V1	25,50		41,00		10,00	CRE		Toyota Celica	
F-00253	2	7V2	25,50		41,30		8,00	CRE		Toyota	
● CT23447	2	0M	25,50		42,10		6,40	DIS			
F-00254	2	7V2	25,50		42,10		9,00	CRE		Toyota	
F-00255	2	7V2	25,50		42,70		8,00	CRE		Toyota	
● F-00475X	2	7V1	25,50		43,00		8,50	CRE		Alfa 159	minorato
F-00247	2	7V2	25,50		44,20		8,50	CRE		Toyota Camry	
F-00131	2	13	25,60		33,40	5,50	8,60	DIS	TRW	Veicoli pesanti	
F-00141	2	1PM	25,70		35,50	7,00	8,00	DIS	Koyo	Audi A4	
F-00514	2	7V1	25,70		41,50		8,70	CRE		Toyota Celica 1999	
● CT22936	2		26,00		28,30	5,50	8,50	DIS	TRW	Alfa 166	distributore inf. - tappo Alfa 166
F-00350	2	12	26,00		32,50		3,60	DIS		Granada	
F-00520	2	4PM	26,00		34,00	4,50	7,70	DIS	ZF	veicoli commerciali	
F-00854	2	4PM	26,00		34,00	6,70	7,70		ZF		originale/genuine
F-00256	2	7V2G	26,00		35,00		6,00	CRE		Honda	
F-00309	2	1PM	26,00		35,00	6,00	6,50	DIS		Mazda	
F-00025	2	0M	26,00		35,00		7,00	CRE	ZF	Bmw-Alfa 33	originale/genuine
F-00483	2	0M	26,00		35,00		7,00	CRE	ZF	Alfa 33 - Toyota Carina	originale/genuine
F-00339	2	4	26,00		35,00	4,00	8,00	DIS		Saab 900,9000	
F-00693	2	0A	26,00		35,00		11,00	DIS		Daf	

INFORMAZIONE TIP РЕКОМЕНДАЦИИ

I paraoli minorati sono identificati con la lettera finale «X»
Esempio F-00024: dimensioni normali - F-00024X: minorato
Reduced seals are identified with final letter «X»
Example F-00024: regular sizes - F-00024X: reduced seal
Сальники, обозначенные буквой «X», являются аналогами стандартных сальников с уменьшенным внутренним диаметром
Например: F-00024 - стандартный F-00024X - с уменьшенным внутренним диаметром



Codice Code Код	Min Ord Мин. коли- чество заказа	Dis. Drawing Тип сальника	d1	d2	D	h1	H	Uso Use in Приме- нение	Marca Brand Произво- дитель агрегата	Tipo auto Vehicle type Тип авто	Note Remarks Примечания
F-00646	2	12	26,00		35,30		7,00	CRE			
F-00303	2	1PM	26,00		35,50	6,00	6,50	DIS		Subaru	
F-00331	2	0M	26,00		37,00		5,00	CRE	ZF	Jaguar	
F-00675	2	0M	26,00		37,00		6,30	DIS	TRW	Porsche E 911	
F-00047	2	0M	26,00		37,00		7,00	DIS	ZF	Audi, Alfa	originale/genuine
F-00490	2	0M	26,00		37,00		7,00	CRE	ZF	Bmw	originale/genuine
F-00124	2	0M	26,00		37,00		7,10	CRE	ZF	Audi A4, A6	
F-00389	2	1PM	26,00		37,00	7,00	8,00	DIS	ZF		
F-00373	2	7V2	26,00		38,00		12,00	CRE		Mitsubishi	
F-00541	2	7V2	26,00		38,10		8,00	CRE		Mercedes classe "C"	
F-00261	2	7V2	26,00		38,10		8,50	CRE		Mitsubishi	
F-00923	2	7V1	26,00		38,10		8,50	CRE		Mitsubishi Galant	
F-00812	2	7V1PM	26,00		38,10	9,00	10,00	CRE	Mando	Hyundai Elantra, Lantra	
F-00206	2	0M	26,00		38,20		6,50	DIS		Toyota-Mitsubishi	
F-00371	2	7V2	26,00		38,20		8,60	CRE	ZF	Peugeot 406	
F-00545	2	7V2	26,00		38,30		8,50	CRE		Honda	
F-00694	2	7V1A	26,00		39,80		8,40	CRE		Celica	originale/genuine
F-00380	2	7V2	26,00		40,00		8,50	CRE		Renault Safrane	
F-00262	2	7V2	26,00		41,10		8,50	CRE		Mitsubishi	
F-00592	2	7V1	26,00		41,20		8,50	CRE		Geo Tracker	
F-00258	2	7V2	26,00		41,20		12,50	CRE		Mitsubishi	
F-00583	2	7V1A	26,00		41,40		8,50	CRE		Lexus	
F-00695	2	7V1	26,00		41,80		8,50	CRE		Celica	
F-00934	2	7V1	26,00		42,00		8,00	CRE		Subaru Legacy	Cremagliera Subaru Legacy
F-00401	2	7V1	26,00		42,50		8,50	CRE		Mitsubishi	
F-00447	2	7V1	26,00		42,70		8,00	CRE		Lexus	
F-00952	2	7V1	26,00		43,00		8,00	CRE		Nissan	
CT20953	2	7V2	26,00		43,00		8,50	CRE	ZF	Alfa 159	Cremagliera ZF
F-00475	2	7V1	26,00		43,00		8,50	CRE		Nissan	
F-00257	2	7V2	26,00		43,00		12,50	CRE		Mitsubishi	
F-00542	2	7V2	26,00		43,10		8,00	CRE		Mercedes classe "C"	
F-00994	2	7V2	26,00		44,10		10,00	CRE			
F-00813	2	7V1PM	26,00		44,10	9,00	10,00	CRE	Mando	Hyundai Elantra, Lantra	
F-00501	2	7V1	26,00		44,20		8,60	CRE		Mitsubishi Galant	
F-00544	2	7V1	26,00		44,30		8,50	CRE		Honda	
F-00376	2	7V1	26,00		45,00		8,50	CRE		Nissan Skiline	
F-00259	2	7V2	26,00		45,10		7,00	CRE		Nissan	
F-00832	2	7V1	26,00		45,10		8,50	CRE		Nissan	originale/genuine
F-00780	2	7V1	26,00		45,50		8,50	CRE		Mercedes	
F-00400	2	7V1	26,00		46,00		8,00	CRE		Honda Prelude	
CT22527	2	7V2	26,00		46,00		8,50	CRE		Fiat Scudo 2007	Fiat Scudo 2007
F-00881	2	7V1	26,00		46,00		8,50	CRE		Fiat Scudo U.T.	
F-00930	2	7V1	26,00		47,00		8,50	CRE		Nissan Serena, N. Murano 3.6 v6 2005	
F-00990	2	7V1	26,00		47,10		8,60	CRE		Nissan Serena, N. Murano 3.6 v6 2005	Genuin
CT23448	2	7V1	26,00		48,20		9,50	CRE			
F-00826	2	7V1	26,00		50,00		8,50	CRE		Nissan Murano	
F-00535	2	6V2	26,00	38,00	40,00	8,50	17,70	CRE		Citroen C5	

CRE	Cremagliera	Rack	Гидроцилиндр
DIS	Distributore	Pignon	Распределитель
PIS	Pistone	Piston	Поршень
POM	Pompa	Pump	Насос
SCA	Scatola	Box	Корпус редуктора

Codice Code Код	Min Ord Мин. коли- чество заказа	Dis. Drawing Тип сальника	d1	d2	D	h1	H	Uso Use in Приме- нение	Marca Brand Произво- дитель агрегата	Tipo auto Vehicle type Тип авто	Note Remarks Примечания
F-00859	2	4	26,50		37,00	3,50	7,00	DIS	Saginaw	Opel Antara, costruzione Corea	
F-00260	2	7V2	26,50		41,40		8,50	CRE		Toyota	
F-00354	2	1P	26,50		43,20	9,20	11,70	CRE		A E A M X 2	
F-00264	2	7V2	26,50		44,10		8,50	CRE		Toyota	
F-00263	2	7V2	26,50		44,20		8,00	CRE		Toyota Lexus IS 300	
F-00683	2	7V1	26,70		44,20		8,00	CRE		Toyota Lexus IS 300	
F-00922	2	7V1	26,70		44,20		8,50	CRE		Lexus	
CT23207	2	12	27,00		35,00		5,00			Nissan Skyline	
F-00367	2	0M	27,00		36,00		5,50	DIS		Mercedes Vito	
F-00065	2	0M	27,00		37,00		7,00	DIS			
F-00101	2	4	27,00		37,00	3,50	7,00	DIS	Saginaw	Opel Vectra, Corsa	
F-00408	2	0M	27,00		38,00		5,50	DIS		Honda	
F-00811	2	0MA	27,00		38,00		6,50	DIS		Nissan Maxima - Nissan Altima '04-'06, Almera Tino	
F-00443	2	1PM	27,00		38,10	5,50	7,50	DIS		TAS 75,85	
F-00839	2	7V2	27,00		40,10		6,80	CRE		Chevrolet	originale/genuine
F-00821	2	7V1	27,00		40,20		8,50	CRE		Toyota Camry	
F-00611	2	0M	27,00		41,00		5,50	DIS		Honda	
F-00265	2	7V1	27,00		41,20		8,50	CRE		Toyota	
F-00877	2	7V2	27,00		41,20		8,50	CRE		Toyota	
F-00266	2	7V1	27,00		43,20		8,50	CRE		Toyota	
F-00267	2	7V1	27,00		44,20		8,50	CRE		Toyota	
F-00838	2	7V3	27,00		45,50	10,00	12,70	CRE		Chevrolet	originale/genuine
F-00986	2	7V1	27,00		46,00		8,00	CRE		Opel Antara	originale/genuine
F-00671	2	7V1	27,00		46,10		9,50	CRE		Mazda Premacy	con labbro parapolvere
F-00825	2	7V1	27,00		46,20		8,50	CRE		Toyota Highlander	
F-00931	2	7V1	27,00		47,00		9,00	CRE		Nissan Avensis	Cremagliera Nissan Avensis
F-00684	2	7V2A	27,20		41,40		7,80	CRE		Sheppard	per albero Ø27
F-00361	2	0M	27,50		37,00		6,90	DIS		Rolls Royce	
F-00937	2	1PM	27,50		38,00	5,00	5,20	DIS		Nissan Infinity G35	Nissan Infinity G35
F-00318	2	12	27,70		36,00		5,00	DIS		Mazda	
F-00765	2	7V1	27,70		38,00		7,50	CRE		Renault	originale/genuine alte temperature
F-00133	2	7V1	27,70		38,10		8,50	CRE	Smi-Koyo	Audi A4,A6	
F-00697A	2	2	27,70		38,30		4,00	CRE		Hyundai Sonata	raschiatore Ø27,7 da abbinare al paraolio F-00697 -F- 00798
F-00128	2	7V1	27,70		39,00		8,50	CRE	Smi-Koyo	Audi A4,A6	
F-00734	2	4A	27,70		39,60	13,50	17,20	CRE	Smi-Koyo	Peugeot 407	con PTFE interno
F-00735	2	7V1	27,70		39,60		20,25	CRE	Smi-Koyo	Peugeot 407	
F-00899A	2	2	27,70		40,00		3,80	CRE		Hyundai Sonata	raschiatore Ø27,7 da abbinare al paraolio F-00899
F-00809	2	7V1PM	27,70		40,00	9,00	10,00	CRE	Mando	Hyundai Santa Fe	
F-00698	2	7V1	27,70		40,10		8,50	CRE		Hyundai Sonata	
CT22718	2	7V1PM	27,70		40,20	9,00	10,00	CRE			

ATTENZIONE! WARNING! ВНИМАНИЕ!

Gli articoli identificati con l'iniziale «CT» (codice temporaneo) sono attualmente in fase di test e prossimi all'introduzione definitiva nel mercato.

Items whose code starts with «CT» (temporary code) are currently being tested and they are candidate to be introduced in the market soon.
Пункты, обозначенные аббревиатурой «СТ» (временный код), в данный момент проходят испытания и будут представлены на рынок в ближайшее время.



Codice Code Код	Min Ord Мин. количество заказа	Dis. Drawing Тип сальника	d1	d2	D	h1	H	Uso Use in Приме-нение	Marca Brand Произво-дитель агрегата	Tipo auto Vehicle type Тип авто	Note Remarks Примечания
• F-00900	2	7V1PM	27,70		40,20	9,00	10,00	CRE	Mando	Hyundai Santa Fe	originale/genuine
• CT23454	2	2	27,70		42,00		4,00	CRE			Raschiatore
• F-00270	2	7V2	27,70		42,00		8,50	CRE		Mitsubishi	
• F-00914	2	7V1	27,70		42,00		8,50	CRE		Mitsubishi	originale/genuine
• F-00960	2	7V1	27,70		42,00		8,50	CRE		Mitsubishi	
• F-00268	2	7V2	27,70		42,00		12,50	CRE		Mitsubishi	
• F-00798	2	7V1	27,70		42,00		13,00	CRE			da abbinare al raschiatore F-00697A
• F-00871	2	7V1PM	27,70		42,10	9,00	10,00	CRE	Mando	Santa Fè	
• F-00950	2	7V1PM	27,70		42,10	9,00	10,00	CRE	Mando	Santa Fè	originale/genuine
• F-00962	2	7V1	27,70		42,20		7,50	CRE	Koyo	Renault, Nissan	
• F-00540	2	7V1	27,70		42,50		8,50	CRE		Mitsubishi Colt, Evo	
• F-00940	2	7V1	27,70		44,00		8,00	CRE		Hyundai Sonata 5	Cremagliera Hyundai Sonata 5
• F-00847	2	7V1PM	27,70		44,10	9,00	10,00	CRE	Smi-Koyo	Hyundai Sonata	
• F-00697	2	7V1PM	27,70		44,10	13,00	14,00	CRE	Mando	Hyundai Sonata	
• F-00899	2	7V1PM	27,70		44,10	13,00	14,00	CRE	Mando	Hyundai Sonata	originale/genuine
• F-00766	2	7V1	27,70		45,00		7,50	CRE		Renault	originale/genuine alte temperature
• F-00375	2	7V1	27,70		45,00		8,50	CRE	Smi-Koyo	Renault Espace	
• F-00751	2	7V1PM	27,70		46,00	9,00	10,00	CRE	Mando	Hyundai Tucson	
• F-00872	2	7V1PM	27,70		46,00	13,00	14,00	CRE	Mando	Santa Fè	
• F-00624	2	7V1	27,70		46,10		12,90	CRE	Koyo	Mitsubishi	
• F-00951	2	7V1PM	27,70		46,10	13,00	14,00	CRE	Mando	Santa Fè	originale/genuine
• F-00810	2	7V1PM	27,70		48,00	9,00	10,00	CRE	Mando	Hyundai Santa Fe	
• F-00970	2	7V1	27,70		50,10		9,00			Hyundai 2006 Kia Carnival	
• F-00996	2	7V1PM	27,70		50,20	9,00	10,00			Hyundai 2006, Kia Sedoma, Karnival	Hyundai 2006, Kia Sedoma, Karnival
• F-00817	2	0M	27,75		37,30		6,50	DIS		Pontiac GTO 2004	distributore inf.
• F-00985	2	0M	27,75		37,30		6,50	DIS		Pontiac GTO 2004	distributore inf.
• F-00059	2	1PM	27,80		40,00	5,50	6,50	DIS	ZF	Peugeot 505	
• F-00795	2	0	28,00		35,00		4,00	DIS			
• F-00944	2	1PMA	28,00		35,00		5,00			F.Transit	
• F-00457	2	12	28,00		36,00		5,50	DIS		Stag	
• F-00620	2	12	28,00		36,00		8,00	PIS		Camion-Veicoli commerciali, Iveco- Scania	pistone idraulico
• F-00041	2	0M	28,00		36,60		9,00	CRE	TRW	Alfa 155	originale/genuine
• F-00134	2	0M	28,00		37,00		4,50	DIS	TRW	Skoda Octavia – Audi A3	distributore inf.
• F-00088	2	0M	28,00		37,00		5,00	DIS	ZF	Skoda Octavia – Audi A3-Bmw-Vw-	
• F-00979	2	0M	28,00		37,00		5,00	DIS	ZF	Audi A4	Genuin
• F-00132	2	0M	28,00		37,10		4,60	DIS		Mercedes	
• F-00319	2	0M	28,00		37,20		5,00	DIS	ZF	Audi A4	
• F-00682	2	0M	28,00		37,20		5,80	DIS		Bentley Arnage btm pinion seal	originale/genuine distributore inf.
• F-00907	2	0M	28,00		37,30		6,50	DIS		Pontiac GTO 2004	originale/genuin

**Paraoli**Seals
Сальники**in ordine di Øint.**sorted by int.Ø
сортировка по размеру

CRE	Cremagliera	Rack	Гидроцилиндр
DIS	Distributore	Pignon	Распределитель
PIS	Pistone	Piston	Поршень
POM	Pompa	Pump	Насос
SCA	Scatola	Box	Корпус редуктора

Codice Code Код	Min Ord Мин. коли- чество заказа	Dis. Drawing Тип сальника	d1	d2	D	h1	H	Uso Use in Приме- нение	Marca Brand Произво- дитель агрегата	Tipo auto Vehicle type Тип авто	Note Remarks Примечания
F-00700	2	12	28,00		37,50		7,80	PIS		Autocarro	per pistone 3° asse autocarro
• CT21992	2	0M	28,00		37,60		6,20	DIS		S-Max anno2006	Distributore inferiore
F-00169	2	0M	28,00		37,70		5,00	DIS		Ford Mondeo, Fiesta	distributore inf.
F-00487	2	0M	28,00		37,70		5,00	DIS		Mondeo - Fiesta	
F-00691	2	6V2	28,00		37,70	5,50	8,00	CRE	TRW	Ferrari	
• CT24755	2	12	28,00		38,00		5,00	DIS			
F-00085	2	12	28,00		38,00		5,00	DIS		Renault	
F-00026	2	0M	28,00		38,00		7,00	CRE	ZF	VW, Bmw 3, Audi	originale/genuine
F-00142	2	0M	28,00		38,00		7,00	DIS	ZF	Bmw - Mercedes	
F-00479	2	0M	28,00		38,00		7,00	CRE		Mercedes	
F-00589	2	7V2	28,00		38,00		7,00	CRE		Audi A4	
• F-00981	2	0M	28,00		38,00		7,00	CRE	ZF	VW, Bmw 3, Audi	originale/genuine
F-00617	2	1PA	28,00		38,00	5,00	8,00	SCA		Iveco, Scania	parapolvere pistone
F-00378	2	7V3	28,00		38,00	7,00	9,00	CRE	ZF	Passat,A4	
F-00409	2	7V2	28,00		38,00		15,00	CRE	ZF	Audi A6,A8	
F-00584	2	7V3	28,00		38,00	15,00	17,00	CRE	ZF	Ducato,Daily	
F-00404	2	0	28,00		38,20		6,50	DIS		Bmw,Opel	
• CT24108	2	0M	28,00		38,20		7,00	DIS	ZF	Bmw 3	originale/genuine
F-00346	2	12	28,00		38,30		4,00	DIS		Jaguar, Granada	
F-00835	2	1PMA	28,00		38,40		7,50	DIS		Suzuki-Mazda 3	originale/genuine
F-00394	2	0M	28,00		38,50		5,00	DIS		Suzuki Swift	
F-00754	2	7V2A	28,00		39,00		15,00	CRE	ZF		
F-00492	2	7V2	28,00		39,10		15,00	CRE	ZF	VW Transporter T5,Audi A4, Tuareg,Q7,Cayenne,	
• F-00954	2	1PMA	28,00		39,50	8,00	8,00	DIS			
F-00057	2	7V2	28,00		39,60		6,50	CRE	TRW	Alfa 156,Scudo,Galaxy	originale/genuine
F-00022	2	7V2	28,00		39,64		6,35	CRE	TRW	Bmw Z3,Citroen	standard
F-00662	2	7V2	28,00		39,98		6,35	CRE		Porsche Boxster, Freelander	
• F-00943	2	6V2	28,00		40,00	4,00	6,00	CRE		Mitsubishi Diamante	Mitsubishi Diamante
F-00546	2	7V2	28,00		40,00		6,50	CRE	TRW	Porsche Boxster, Freelander	
F-00434	2	1PM	28,00		40,00	6,00	7,00	DIS			
F-00548	2	1PM	28,00		40,00	5,50	7,50	DIS		Mercedes LS4	
F-00785	2	1PMA	28,00		40,00	7,60	7,60	DIS			
F-00172	2	1PM	28,00		40,00	7,00	8,00	DIS	ZF	Bmw	
F-00478	2	1PM	28,00		40,00	8,00	10,50	DIS		Mercedes LS7 LS8 LS3	
F-00749	2	7V1	28,00		40,10		8,00	CRE		Mitsubishi Diamante	originale/genuine
F-00139	2	7V2	28,00		40,20		8,00	CRE	ZF	Audi A8	
F-00842	2	7V2	28,00		40,60		7,50	CRE		Ford	
F-00204	2	0M	28,00		41,00		6,50	DIS		Toyota	
F-00814	2	7V1	28,00		41,00		8,00	CRE		Kia Sedona 2005	originale/genuine
F-00269	2	7V2	28,00		41,20		8,00	CRE		Kia Carnival	
F-00743	2	7V1	28,00		41,20		8,00	CRE		Kia Karnival II	
F-00747	2	0M	28,00		42,00		6,00	DIS		Mitsubishi Diamante	distributore inf. - con inserto metallico inserto

INFORMAZIONE TIP РЕКОМЕНДАЦИИ

I paraoli minorati sono identificati con la lettera finale «X»
Esempio F-00024: dimensioni normali - F-00024X: minorato
Reduced seals are identified with final letter «X»
Example F-00024: regular sizes - F-00024X: reduced seal
Сальники, обозначенные буквой «X», являются аналогами стандартных сальников с уменьшенным внутренним диаметром
Например: F-00024 - стандартный F-00024X - с уменьшенным внутренним диаметром



Codice Code Код	Min Ord Мин. коли- чество заказа	Dis. Drawing Тип сальника	d1	d2	D	h1	H	Uso Use in Приме- нение	Marca Brand Произво- дитель агрегата	Tipo auto Vehicle type Тип авто	Note Remarks Примечания
F-00341	2	12	28,00		42,00		7,00	CRE		Triumph, Jaguar	
● F-00961	2	7V1	28,00		42,00		8,50	CRE			
F-00709	2	7V1	28,00		43,00		9,00	CRE		Mitsubishi Evo X	
F-00836	2	0MA	28,00		43,00		10,00	POM		Fiat Iveco Vaz-Lada	standard
F-00045	2	0M	28,00		44,00		6,00	DIS	Smi-Koyo	Renault	
● CT21990	2	7V2	28,00		44,00		7,20	CRE		F. S-Max	originale/genuine
● F-00869	2	7V1	28,00		44,00		7,50	CRE		Ford S.Max	
F-00843	2	7V2	28,00		44,60		7,50	CRE		Ford	
F-00816	2	7V1	28,00		44,80		9,00	CRE	TRW	Pontiac GTO 2004	originale/genuine
F-00752	2	7V2	28,00		46,00		8,50	CRE			
F-00286	2	7V1	28,00		46,00		12,50	CRE		Mitsubishi	
F-00750	2	7V1	28,00		46,20		9,00	CRE		Mitsubishi Diamante	
F-00113	2	9	28,00		47,00	4,20	5,00	DIS		Renault 205 ultimo tipo	
F-00729	2	7V1	28,00		47,90		10,00	CRE	TRW		
F-00522	2	7V2	28,00		48,20		8,50	CRE		Mazda	
F-00706	2	6V3	28,00	43,00	47,70	5,00	11,70	CRE		Nissan Quest, Mercury Villager 93-94	
F-00603	2	7V2	28,30		41,50		8,00	CRE			
F-00076	2	9	28,40		46,80	5,80	6,50	DIS		Peugeot, Renault, Renault18	originale/genuine
● CT23958	2	12	28,50		35,50		3,90			Amc Pacer 1978	
F-00049	2	12	28,50		35,50		4,00	DIS		Jaguar J40	
F-00495	2	0M	28,50		37,80		5,00	DIS		Ford Fiesta ultimo tipo	
F-00710	2	4	28,50		38,00	3,50	8,00	DIS			
F-00081	2	0M	28,50		43,00		6,50	DIS	TRW	Renault, Clio	originale/genuine
F-00431	2	0M	28,50		43,00		6,50	DIS		Renault Clio	originale/genuine
F-00633	2	0M	28,50		43,00		6,50	DIS		Renault Clio	
F-00343	2	7V2	28,50		44,50		10,00	CRE		Rover, Jaguar	
F-00342	2	7V2G	28,50		45,00		9,00	CRE		Jaguar XJ6	
F-00433	2	0M	28,60		37,60		5,10	DIS			
F-00428	2	0	28,60		38,00		6,00	DIS		Nissan King Kab	
CT20897	2	0MA	28,60		40,00		5,00	DIS		Nissan King Kab	
● CT23955	2	0MA	28,60		41,30		12,80	CRE		Amc Pacer 1978	
F-00336	2	12	29,00		37,00		5,00	DIS		Suzuki Vitara	
F-00112	2	7V2G	29,00		37,00		8,00	CRE		Jaguar	
F-00298	2	12	29,00		37,50		6,00	DIS		Subaru	
F-00786	2	1PM	29,00		39,00	5,50	6,00	DIS		Nissan	
F-00594	2	0M	29,00		40,00		7,00	CRE		Modifica Transit rettificato	
F-00358	2	0M	29,00		43,00		7,00	DIS	ZF	Citroen XM,Xara, Alfa 159,	
● F-00980	2	0M	29,00		43,00		7,00	DIS	ZF	Citroen XM,Xara, Alfa 159,	Genuin
F-00673	2	0M	29,00		43,10		7,00	DIS		Hyundai, Lantra	originale/genuine
F-00060	2	8	29,00		44,60	3,00	3,90	DIS		Rover 3,4 bulloni	
F-00190	2	12	29,00		45,00		5,00	DIS		Rover 3,4 Bulloni	
F-00075	2	9M	29,40		46,80	5,80	7,00	DIS		Peugeot 505, Renault	originale/genuine
F-00435	2	1PM	29,40		46,80	6,30	7,00	DIS		Peugeot	

**Paraoli**Seals
Сальники**in ordine di Øint.**sorted by int.Ø
сортировка по размеру

CRE	Cremagliera	Rack	Гидроцилиндр
DIS	Distributore	Pignon	Распределитель
PIS	Pistone	Piston	Поршень
POM	Pompa	Pump	Насос
SCA	Scatola	Box	Корпус редуктора

Codice Code Код	Min Ord Мин. коли- чество заказа	Dis. Drawing Тип сальника	d1	d2	D	h1	H	Uso Use in Приме- нение	Marca Brand Произво- дитель агрегата	Tipo auto Vehicle type Тип авто	Note Remarks Примечания
F-00073	2	1PM	29,40		47,00	6,00	7,00	DIS		Citroen, Peugeot, Xantia	originale/genuine
• F-00073M	2	1PM	29,40		47,00	6,00	7,00	DIS		Citroen, Peugeot, Xantia	Distributore sup.
• CT24682	2	0MA	29,90		47,00		8,00				Genuin, righe SX, rotazione DX distributore inf.
• CT22937	2		30,00		32,20	5,50	13,00	DIS	TRW	Punto, Multipla, Y	- tappo Punto, Multipla, Y
F-00212	2	0M	30,00		38,00		5,00	DIS		Toyota Space Cruiser	
F-00320	2	7V3G	30,00		38,00	3,50	5,50	DIS		Jaguar Adwest	P.T.F.E. + paraolio
F-00456	2	0	30,00		38,00		7,00	DIS		Mazda	
F-00629	2	12	30,00		38,00		8,00	DIS		veicoli commerciali	autocarri
F-00521	2	0	30,00		40,00		6,50	CRE		veicoli commerciali	alta pressione
F-00727	2	6V2	30,00		40,00	4,00	6,50	CRE			
F-00062	2	0M	30,00		40,00		7,00	CRE	ZF	F.Transit	originale/genuine
F-00507	2	1PM	30,00		40,00		7,00	POM		veicoli commerciali	
F-00209	2	0M	30,00		41,00		6,50	CRE		Toyota Supra	
F-00405	2	0M2	30,00		42,00		7,00	POM		Mercedes BMW LUK	
F-00539	2	7V2	30,00		42,00		8,00	CRE		Bmw X5	
F-00458	2	1PM	30,00		42,00	7,00	8,00	DIS		Lexus	
F-00753	2	1PM	30,00		42,00	8,00	8,00	DIS			distributore sup.
F-00704	2	7V1	30,00		42,00		15,00	CRE	ZF	Ducato – Bmw Servotronic X5	
F-00537	2	7V3	30,00		42,10	15,00	17,00	CRE	ZF	Ducato, BMW Servotronic X5	con teflon esterno
F-00271	2	7V2	30,00		42,30		8,00	CRE		Toyota	
F-00017	2	7V2	30,00		42,50		6,50	CRE	TRW	Fiat Ducato – Iveco Daily	standard
F-00033	2	7V2	30,00		42,50		6,50	CRE	TRW	Ducato	originale/genuine
F-00417	2	7V2	30,00		42,80		6,30	CRE	TRW	Fiat Ducato – Iveco Daily	originale/genuine maggiorato
F-00593	2	7V2	30,00		42,80		8,00	CRE		M, B 100, 140 Minibus Main	
F-00850	2	0M	30,00		43,00		6,00	DIS		Dodge	distributore inferiore originale/genuin
F-00208	2	0M	30,00		43,00		6,50	CRE		Toyota Land Cruiser	
F-00046	2	1PM	30,00		43,00	8,00	9,50	DIS	ZF	Mercedes 190	originale/genuine
F-00800	2	7V1	30,00		44,20		8,50	CRE		Toyota Tacoma	
F-00725	2	7V3	30,00		45,50	10,00	12,70	CRE			
F-00272	2	7V2	30,00		45,70		8,50	CRE		Toyota, Celica 4WD	
F-00273	2	7V2	30,00		46,20		8,00	CRE		Toyota	
F-00055	2	0M	30,00		47,00		6,00	DIS			
F-00719	2	7V1	30,00		47,00		8,50	CRE		Mercedes Vito	
F-00756	2	7V2	30,00		47,00		8,50	CRE			
F-00274	2	7V2	30,00		47,00		9,00	CRE		Toyota	
F-00450	2	7V2	30,00		48,10		8,00	CRE		Toyota Hi ace	
F-00841	2	7V1PM	30,00		48,10	9,00	10,00	CRE	Mando	Jeep	
• F-01005	2	7V1PM	30,00		48,10	9,00	10,00	CRE	Mando	Jeep	originale-genuine
CT20622	2	7V1	30,00		48,20		8,00	CRE		Toyota Hi ace	
F-00801	2	7V1	30,00		48,20		8,50	CRE		Toyota Tacoma	
F-00585	2	7V3	30,00		49,70	10,00	13,00	CRE		GMC Chevy Trailblazer	

Gli articoli identificati con l'iniziale «CT» (codice temporaneo) sono attualmente in fase di test e prossimi all'introduzione definitiva nel mercato.

Items whose code starts with «CT» (temporary code) are currently being tested and they are candidate to be introduced in the market soon.
Пункты, обозначенные аббревиатурой «CT» (временный код), в данный момент проходят испытания и будут представлены на рынок в ближайшее время.



Codice Code Код	Min Ord Мин. коли- чество заказа	Dis. Drawing Тип сальника	d1	d2	D	h1	H	Uso Use in Приме- нение	Marca Brand Произво- дитель агрегата	Tipo auto Vehicle type Тип авто	Note Remarks Примечания
F-00374	2	7V1	30,00		50,00		8,50	CRE		Nissan	
F-00718	2	7V1	30,00		50,00		10,00	CRE		Mercedes Vito	
F-00755	2	7V2	30,00		50,00		10,00	CRE			
F-00622	2	7V2	30,00		54,70		8,00	CRE		Mercedes Sprinter	
CT20602	2	1PM	30,00		64,00	5,00	6,00	DIS		TAS 75/80	Genuin
• CT22939	2		30,00	32,30	38,30	2,00	16,00	DIS	TRW	doblo	distr inf. - tappo con ribordatura doblo
• CT24107	2	7V2A	30,00	42,10	44,40		15,00	CRE		Bmw X3	Originale/genuine Bmw X3
F-00486	2	6V2	30,00	42,50	49,00	3,40	10,90	CRE	TRW	Ducato, Daily	maggiorato
F-00021	2	6V2	30,00	42,50	49,20	3,40	10,90	CRE	TRW	Ducato, Iveco, Daily	originale/genuine
F-00029	2	6V2	30,00	42,50	49,20	3,40	10,90	CRE	TRW	Iveco, Ducato, Daily	standard
F-00762	2	6V2	30,00	42,50	49,50	3,40	10,90	CRE	TRW	Ducato, Iveco, Daily	originale/genuine alte temperature
F-00175	2	0A	30,20		42,00		6,00	DIS		Mitsubishi	
F-00210	2	12	31,00		39,00		5,00	DIS		Mitsubishi Shougun, Suzuki Vitara	
F-00587	2	7V2	31,00		43,00		7,00	CRE	ZF	Bmw Serie 7	
F-00588	2	7V2	31,00		43,00		15,00	CRE	ZF	Bmw Serie 7	
F-00289	2	7V2	31,00		43,70		6,30	CRE		Ford Explorer	
F-00205	2	0M	31,00		44,00		6,50	DIS		Toyota	
• F-00932	2	7V2	31,00		44,60		8,50	CRE			Cremagliera
• F-00956	2	3A	31,00		46,70		3,90	DIS		Ford	parapolvere
• F-00582	2	7V2	31,00		47,80		7,50	CRE		Ford Explorer	
• CT25192	2	6	31,00		51,60	6,60	11,00	CRE			
• CT25191	2	7V2	31,00		52,00		7,60	CRE			
• F-00910	2	7V1	31,00		52,00		8,00	CRE		Ford Expedition	Ford Expedition, F150
F-00290	2	6V2	31,00	43,70	48,00	4,00	8,30	CRE		Ford Explorer	
• F-00103X	2	7V1	31,50		44,50		6,50	CRE	TRW	Mercedes Vito Sprinter	rigato esternamente in gomma forma ad U
• F-00876	2	12	31,70	47,80	47,80		8,50			Nissan Fusu	
F-00091	2	4	31,75		38,10	3,00	5,00	DIS	TRW	Rover 820	
• F-00913	2	12	31,75		41,25		6,35				
• F-00903	2	0M	31,75		41,30		6,50	DIS	TRW	Kirby	Distributore inf. originale/genuine
• F-00905	2	12	31,75		44,45		6,35	DIS		Rover	Distributore Rover
• F-01001	2	12	32,00		40,00		5,00	DIS			
F-00207	2	2	32,00		40,00		5,00	CRE		Toyota Land Cruiser	
F-00211	2	12	32,00		40,00		5,00	DIS		Isuzu, Frontera, Trooper	
F-00176	2	2	32,00		40,00		7,00	DIS		Isuzu, Trooper	
F-00676	2	12	32,00		41,50		6,50	DIS		Veicolo commerciale	
• CT23718	2	0A	32,00		42,00		4,00			Nissan Patrol	
F-00213	2	0M	32,00		42,00		5,00	DIS		Toyota	
• F-00989	2	0	32,00		42,00		5,00	DIS			Genuin
F-00173	2	0A	32,00		42,00		6,50	DIS		Mitsubishi	
F-00866	2	12	32,00		42,00		7,00	CRE			
F-00470	2	12	32,00		42,00		8,00	CRE			
F-00621	2	12	32,00		42,00		8,00	PIS		Camion-Veicoli com- merciali, Iveco- Scania	pistone

**Paraoli**Seals
Сальники**in ordine di Øint.**sorted by int.Ø
сортировка по размеру

CRE	Cremagliera	Rack	Гидроцилиндр
DIS	Distributore	Pignon	Распределитель
PIS	Pistone	Piston	Поршень
POM	Pompa	Pump	Насос
SCA	Scatola	Box	Корпус редуктора

Codice Code Код	Min Ord Мин. коли- чество заказа	Dis. Drawing Тип сальника	d1	d2	D	h1	H	Uso Use in Приме- нение	Marca Brand Произво- дитель агрегата	Tipo auto Vehicle type Тип авто	Note Remarks Примечания
F-00455	2	1PM	32,00		42,00	7,00	9,00	DIS		Kia, Daiatshu	
● F-01002	2	0M	32,00		43,00		5,00	DIS			
F-00446	2	1PM	32,00		44,00	8,50	10,00	DIS		Mercedes	
F-00469	2	0M	32,00		44,50		5,50	CRE		Cherokee ultimo tipo	
F-00591	2	12	32,00		44,50		6,20	DIS		Tata	
F-00103	2	7V2	32,00		44,50		6,50	CRE	TRW	Mercedes Vito Sprinter	originale/genuine rigato esternamente
F-00197	2	12	32,00		44,50		7,00	DIS		Rover 3,4,6 Bulloni	
F-00444	2	7V2	32,00		44,50		8,50	CRE		Mercedes	
● F-00880	2	7V1	32,00		44,50		8,50	CRE		Mercedes	
F-00737	2	7V2	32,00		44,60		6,50	CRE	TRW	Mercedes Vito Sprinter, Ducato U.T.	nuovo mod. maggiorato, rigato esternamente
F-00568	2	0M	32,00		44,60		8,00	DIS		Mitsubishi, Cherokee	
F-00567	2	1PM	32,00		44,60		10,00	DIS		Mitsubishi	
F-00569	2	7V3	32,00		44,70	5,00	6,50	DIS		Jeep	
F-00577	2	3	32,00		45,00		3,70	DIS		Jeep	parapolvere
F-00595	2	0A	32,00		45,00		4,50	DIS		Tata	
F-00357	2	1PM	32,00		45,00		7,00	DIS			
F-00793	2	1PM	32,00		45,00	7,00	7,50	DIS			originale/genuine
F-00482	2	12	32,00		45,00		8,00	DIS		Rover 3,4 Bulloni	
F-00618	2	1PA	32,00		45,00	7,00	10,00	SCA		Iveco, Scania	parapolvere pistone
F-00115	2	12	32,00		45,00		10,50	DIS		Bendix, Transit	
F-00623	2	12	32,00		45,00		10,50	DIS		Bendix, Transit	
F-00430	2	0	32,00		45,10		6,50	DIS		Range Rover 93	
● F-01003	2	7V2	32,00		45,65		6,90	CRE		Chevrolet Tahoe	Chevrolet Tahoe
● F-00957	2	8	32,00		46,10		5,80	DIS		Ford, Lincoln, Mercury	
F-00276	2	7V1	32,00		46,10		8,50	CRE			
CT20617	2	7V1	32,00		47,00		8,50	CRE		Mitsubishi Pajero	
● CT23413	2	1PM	32,00		47,00		10,00			Volkswagen	Volkswagen
● CT24869	2	1PM	32,00		47,00		10,00			Mercedes	Paraolio motore, Mercedes
F-00644	2	7V1PM	32,00		47,50	10,00	12,00	CRE		Cherokee ultimo tipo	
● F-00973	2	7V1PM	32,00		47,50	10,00	12,00	CRE		Cherokee ultimo tipo	Genuin
F-00803	2	7V3	32,00		47,50	10,00	12,70	CRE		Chevy	
F-00275	2	7V1	32,00		49,00		8,50	CRE			
F-00560	2	7V1	32,00		50,00		8,50	CRE		Mitsubishi Pajero	
● F-00902	2	7V1	32,00		50,00		9,00	CRE		LDV Maxus	originale/genuine
F-00745	2	7V1	32,00		52,20		10,00	CRE		Dodge Ram Serie 1500	
F-00581	2	7V1	32,00		52,40		10,00	CRE		Dodge	
F-00827	2	7V1	32,00		53,00		8,50	CRE		Nissan Infiniti	Cremagliera Nissan Infiniti
● CT24618	2	7V1PM	32,00		54,00	9,00	10,00	CRE		BUIK	Genuin
● CT25164	2	7V3	32,00		55,00		14,50	CRE		Chevrolet Tahoe	Chevrolet Tahoe
F-00857	2	7V1	32,00		56,00		9,00	CRE		Nissan	
F-00802	2	6V2	32,00	38,00	42,00	4,00	6,30	CRE		Chevy	
F-00678	2	6V2	32,00	44,10	46,80	12,90	18,70	CRE		Land Rover L30-MK3	
F-00202	2	12	32,00	44,50	46,00		5,00	DIS		Rover 3,4 Bulloni	originale/genuine

INFORMAZIONE TIP РЕКОМЕНДАЦИИ

I paraoli minorati sono identificati con la lettera finale «X»
Esempio F-00024: dimensioni normali - F-00024X: minorato
Reduced seals are identified with final letter «X»
Example F-00024: regular sizes - F-00024X: reduced seal
Сальники, обозначенные буквой «X», являются аналогами стандартных сальников с уменьшенным внутренним диаметром
Например: F-00024 - стандартный F-00024X - с уменьшенным внутренним диаметром



Codice Code Код	Min Ord Мин. коли- чество заказа	Dis. Drawing Тип сальника	d1	d2	D	h1	H	Uso Use in Приме- нение	Marca Brand Произво- дитель агрегата	Tipo auto Vehicle type Тип авто	Note Remarks Примечания
F-00203	2	12	32,00	44,60	46,20		6,40	DIS		Rover 3,4 Bulloni	originale/genuine in poliuretano azzurro
F-00214	2	12	32,00	44,70	46,30		7,00	DIS		Rover 3,4 Bulloni	in poliuretano azzurro
F-00742	2	0M	32,70		42,70		6,70	DIS		Toyota Landcruiser J 120	
● F-00908	2	0M	33,50		46,10		7,30	DIS		Ford, Limusine	
F-00351	2	12	34,00		40,00		3,60	DIS		Jaguar, Rover	
F-00314	2	1PM	34,00		44,40		6,00	DIS		Mazda, Ford	
F-00352	2	12	34,00		44,50		4,30	DIS		Alpine Solara	
F-00092	2	4A	34,00		47,00	5,00	12,00	DIS	TRW	Rover 820	
F-00685	2	12	35,00		42,00		3,70	DIS		Jaguar, Rover	
F-00664	2	0M	35,00		45,00		7,00	DIS		Euroclass	
F-00665	2	1PM	35,00		45,00		7,00	DIS		Euroclass	
● F-00984	2	0M	35,00		46,10		7,30	DIS			
● F-00974	2	7V2G	35,00		46,50		7,10	CRE		Isuzu	P.T.FE. + paraolio
F-00454	2	12	35,00		47,00		6,50	DIS		Mitsubishi, Nissan, Hyundai Terracan,	pignone
F-00174	2	0A	35,00		47,00		7,50	DIS		Mitsubishi	
F-00856	2	7V1PM	35,00		47,00	7,30	8,30			Jeep Wrangler	
F-00424	2	1PM	35,00		47,00	7,00	8,50	DIS		Mercedes SLE	
F-00452	2	1PMA	35,00		47,00	8,00	10,00	DIS		Mitsubishi	
F-00660	2	0	35,00		47,30		7,00	DIS		Tata Safari	
CT20947	2	3P	35,00		48,00	3,00	3,80			Jeep Wrangler	
● F-00999	2	12	35,00		48,00		7,00	DIS			
CT20594	2		35,00		50,00		7,00				
F-00398	2	7V2	35,00		50,00		8,00	CRE		Toyota Land Cruiser	
F-00828	2	12	35,00		50,00		9,00				
F-00822	2	12	35,00		50,00		10,00			Omai Falcon	
F-00385	2	1PM	35,00		50,00	8,00	10,00	DIS		Mercedes	
● F-00939	2	7V1	35,00		53,00		8,50	CRE		Lexus RX 470	Cremagliera Lexus RX 470
● F-00988	2	7V1	35,00		53,00		8,50	CRE		Lexus RX 470	Lexus RX 470, genuin
F-00451	2	7V1	35,00		56,00		8,00	CRE		Toyota Land Cruiser	
F-00757	2	0M	35,00		58,00		10,00	DIS		Mazda	
● CT24645	2	0	35,91		46,10		7,20				
F-00383	2	0M	36,00		44,00		5,00	CRE		Toyota	
● CT25196	2	12	36,00		44,00		6,00	DIS			
F-00316	2	12	36,00		45,00		3,70	DIS		Jaguar J16, XJ12	
F-00337	2	12	36,00		46,00		6,00	DIS		Mitsubishi Shougun	
● CT22724	2	12	36,00		47,50		7,00	PIS			
F-00655	2	7V2	36,00		48,10		6,70	CRE		Mercedes	
F-00277	2	7V2	36,00		50,50		9,00	CRE			
● CT22938	2		38,00		40,30	6,50	16,00	DIS	TRW	Ducato	distributore inf. - tappo Ducato a settore
F-00553	2	12	38,00		47,70		6,50	DIS		Nissan Patrol GQ	
● F-00873	2	12	38,00		48,00		8,00			Scania	
F-00552	2	1PMA	38,00		50,00	8,00	9,50	DIS		Nissan Patrol GQ	
F-00674	2	0	38,00		50,90		5,00	DIS		Veicolo commerciale	parapolvere
F-00892	2	0	38,00		50,90		5,00	DIS		Veicolo commerciale	Parapolvere
F-00715	2	2	38,00		51,00		5,00	DIS		Land Rover	

**Paraoli**Seals
Сальники**in ordine di Øint.**sorted by int.Ø
сортировка по размеру

CRE	Cremagliera	Rack	Гидроцилиндр
DIS	Distributore	Pignon	Распределитель
PIS	Pistone	Piston	Поршень
POM	Pompa	Pump	Насос
SCA	Scatola	Box	Корпус редуктора

Codice Code Код	Min Ord Мин. коли- чество заказа	Dis. Drawing Тип сальника	d1	d2	D	h1	H	Uso Use in Приме- нение	Marca Brand Произво- дитель агрегата	Tipo auto Vehicle type Тип авто	Note Remarks Примечания
F-00722	2	2	38,00		51,00		5,00	DIS		Land Rover U.T. UK	originale/genuine
F-00638	2	12	38,00		51,00		8,00	PIS		Land Rover Discovery MK2	
F-00647	2	0M	38,00		52,60		6,40	DIS		Dodge RAM	
F-00437	2	12	38,00		53,00	7,20	9,50	DIS			
F-00906	2	12	38,10		50,80		7,90				
F-00468	2	12	39,00		49,00		6,40	CRE		Jeep Cherokee ultimo tipo	
F-00992	2	12	40,00		50,00		8,00	DIS		veicoli commerciali	Eurostar
CT22685	2	1PM	40,00		51,00	5,00	6,00	DIS		TAS 20	
F-00975	2	7V2G	40,00		51,20		7,30	CRE		Isuzu	P.T.F.E. + paraolio
F-00692	2	1PM	40,00		52,00	8,00	11,00	DIS		Mercedes	Distributore superiore, (BLU)
F-00925	2	1PM	40,00		52,00	8,00	11,00	DIS		Mercedes	Distributore superiore, (NERO)
F-00972	2	7V1	40,00		55,00	8,50	9,00	CRE		Nissan Cabstar TAS 20 /30 m616 /617	
F-00570	2	2	40,00		55,00		9,50	DIS		Bendix	
F-00116	2	12	40,00		55,00		10,00	DIS		Bendix, Transit	
F-00628	2	12	40,00		55,00		11,00	DIS		veicoli commerciali	autocarri
F-00564	2	12	40,00		55,50		6,30	DIS		Bendix, Transit	materiale speciale
CT22684	2	12	40,00		56,00		6,00			TAS 20	
CT23156	2		40,00		62,00		8,00				motore Smart
CT22809	2	12	40,00	44,60	50,00		11,00	DIS			originale/genuine in poliuretano blu
F-00580	2	8	41,00		54,00	1,30	3,50	SCA		Pajero, Camion	parapolvere
F-00579	2	7V2	41,00		54,00		8,00	CRE		Pajero, Camion	
F-00804	2	7V2	41,00		57,50		9,00	CRE		Ford	
F-00805	2	3	41,00		58,00		3,60	DIS		Ford	parapolvere
F-00616	2	12	43,00		60,00		6,00	PIS	ZF	Iveco, Scania	tenuta pistone
CT24893	2	12	44,00		54,00		6,70			Renault Shepard piccola	Renault Shepard piccola
F-00551	2	7V2	45,00		59,00		5,50	DIS		Mercedes LS4	
CT22029	2	12	45,00		60,00		5,60			Mercedes LS4	Mercedes LS4
F-00571	2	2	45,00		60,00		10,00	DIS		Bendix	
F-00563	2	2G	45,00		60,50		6,30	DIS		Bendix, Transit	materiale speciale
F-00630	2	12	46,00		56,00		10,00	DIS		veicoli commerciali	autocarri
CT24851	2	1PM	47,00		59,00	8,00	10,50	DIS		Mercedes LS3	
F-00955	2	12	49,00		62,00		3,50	DIS			
F-00572	2	2	50,00		65,00		10,00	DIS		Bendix	
F-00471	2	1PM	50,00		70,00		10,00	DIS		Veicoli pesanti	
CT22979	2		50,00		72,00		9,00				Volvo
CT22980	2		50,00		73,00		11,00				Volvo
F-00701	2	12	52,00		60,00		6,00	PIS		Autocarro	per pistone 3° asse autocarro
F-00987	2	1PM	52,00		65,00	9,00	11,00	DIS		Mercedes	Distributore superiore, (BLU)
F-00491	2	12	52,00		66,00		5,50	DIS		Mercedes LS6	albero uscita
F-00549	2	0M	52,00		66,00		5,50	DIS		Mercedes LS4	
F-00639	2	7V2	52,00		66,00		5,50	CRE		Autocarro Mercedes	
CT22030	2	12	52,00		67,00		5,60			Mercedes LS4	Mercedes LS4
F-00550	2	0A	52,00		68,00		6,00	DIS		Mercedes LS4	con righe interne
CT22028	2	0M	52,00		68,00		8,00	DIS		Mercedes LS4	Mercedes LS4

Gli articoli identificati con l'iniziale «CT» (codice temporaneo) sono attualmente in fase di test e prossimi all'introduzione definitiva nel mercato.

*Items whose code starts with «CT» (temporary code) are currently being tested and they are candidate to be introduced in the market soon.
Пункты, обозначенные аббревиатурой «CT» (временный код), в данный момент проходят испытания и будут представлены на рынок в ближайшее время.*



Codice Code Код	Min Ord Мин. коли- чество заказа	Dis. Drawing Тип сальника	d1	d2	D	h1	H	Uso Use in Приме- нение	Marca Brand Произво- дитель агрегата	Tipo auto Vehicle type Тип авто	Note Remarks Примечания
F-00784	2	1PM	52,00		85,00	9,50	14,43				
• CT24867	2	1PM	54,00		72,00		10,00			Mercedes	Paraolio motore righe SX, rotazione DX
F-00573	2	2	55,00		70,00		12,30	DIS		Bendix	
• CT22349	2	12	55,00		71,40		5,60			Mercedes LS8	Mercedes LS8
• CT24732	2	0MA	55,00		72,00		7,00	DIS		Mercedes	
• CT24733	2	1PM	55,00		72,00	8,00	8,50	DIS		Mercedes	
• CT24734	2	1PM	55,00		72,00	8,00	8,50	DIS		Mercedes	Alte temperature
• CT24868	2	1PM	56,00		69,00		10,00			Mercedes	Paraolio motore righe DX, rotazione SX
F-00559	2	7V2	56,00		70,00		5,50	DIS		Mercedes LS7	originale/genuine
F-00477	2	1PM	56,00		70,00	9,00	11,00	DIS		Mercedes LS7	distributore sup.
• CT22703	2	8	57,00		70,80	1,30	4,00			HFB70 DAF, Scania	Raschiatore
F-00977	2	7V1PM	57,00		74,70	9,00	9,50			TAS 75/80	originale/genuine
CT20599	2	1PM	57,10		70,00	5,00	6,00	DIS		TAS 75	
CT20609	2	1PM	57,10		70,00	5,00	6,00	DIS	TRW	TAS 75	
• CT24908	2	1PA	57,10		70,00	6,00	6,00	DIS		TAS 80	TAS 80
CT20614	2	2	57,10		74,50		2,85		TRW	TAS 75	
CT20600	2	1P	57,10		74,50	3,90	5,00	DIS		TAS 75	
CT20597	2	12	57,10		75,50		6,50	DIS		TAS 75	
• CT24904	2	8	57,13		74,57		2,90		TRW	TAS 80	TAS 80
• CT24903	2	3	57,13		74,57		3,60		TRW	TAS 80	TAS 80
CT20624	2	7V2	60,00		74,00		5,50	CRE		Mercedes	
• CT25175	0		65,00		85,00		10,00				Paraoli Ø65x85 H10
F-00635	2	12	70,00		78,00	4,00	7,00	PIS		veicoli commerciali	paraolio autolivellante
• CT23574	2		70,00		81,50		6,00				
F-00634	2	12	70,00		85,00		12,00	PIS		Camion-veicoli pesanti	paraolio autolivellante
• CT22722	2	12	75,00		89,60		4,50	PIS			per tenuta pistone
• CT23157	2		80,00		100,00		9,00				motore Smart
F-00636	2	8	83,00		90,00		6,10	SCA		veicoli commerciali	paraolio autolivellante
F-00637	2	8	83,00		90,00		6,10	SCA		veicoli commerciali	
• CT25176	0		85,00		130,00		10,00				



0

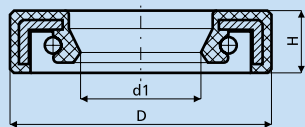

00040



10952

in ordine di disegno

sorted by drawing
сортировка по типу

Codice Code Код	Min Ord Мин. коли- чество заказа	Dis. Drawing Тип сальника	d1	d2	D	h1	H	Usa Use in Приме- нение	Marca Brand Произво- дитель агрегата	Tipo auto Vehicle type Тип авто	Note Remarks Примечания
F-00386	2	0M	6,35		19,00		5,00	DIS		Renault, Peugeot	
• F-00942	2	0MA	7,76		21,00		6,00				
F-00480	2	0M	8,00		16,00		7,00	POM		Renault	
F-00481	2	0M	10,00		19,00		7,00	POM		Renault	
F-00074	2	0M	10,00		20,00		7,00	CRE	ZF	Opel Calibra	originale/genuine
• F-00991	2	0MA	10,00		22,00		6,00	POM	ZF		
• CT24017	2	0A	12,00		22,30		6,65	POM		Pompa Cummins	Pompa Cummins
• CT24018	2	0A	12,00		23,00		6,50	POM		Pompa Cummins	Pompa Cummins
F-00790	2	0M	12,00		24,00		6,00	DIS			distributore inf.
F-00770	2	0	14,00		22,00		4,00	DIS		Mini	distributore inf.
F-00777	2	0	14,20		24,40		5,00	DIS		Burman (taxi)	distributore inf.
F-00066	2	0	14,30		22,00		4,00	DIS		Rover	
F-00794	2	0M2	15,00		24,00		7,00	POM			
F-00565	2	0AM2	15,00		24,12		7,00	POM			
F-00056	2	0M	15,00		26,00		7,00	POM			viton
F-00776	2	0M	15,00		30,00		7,00	DIS		TVR	distributore inf.
F-00707	2	0M	16,00		24,00		6,00	POM			
F-00686	2	0MA	16,00		36,00		6,60	POM			alte temperature righe SX rotazione DX (minorato)
F-00510	2	0AM2	17,00		28,00		6,50	POM		veicoli commerciali	originale/genuine
F-00538	2	0AM2	17,00		28,00		6,50	POM			alte temperature
F-00148	2	0M2	17,00		28,00		8,00	POM		Volvo, Ducato	
F-00506	2	0M2	17,00		28,00		8,00	POM		veicoli commerciali	originale/genuine
• F-00967	2	0MA	17,00		28,70		6,50	POM			
F-00505	2	0M2	17,00		28,80		8,00	POM		veicoli commerciali	
F-00356	2	0M2	17,00		30,00		7,00	POM			alte temperature
F-00465	2	0AM2	17,00		32,00		8,00	POM		Toyota Land Cruiser 8,92	
F-00122	2	0MA	17,00		36,00		6,60	POM	Saginaw		alte temperature righe SX rotazione DX
F-00687	2	0MA	17,00		36,00		6,60	POM	Saginaw		
F-00858	2	0M	17,00		40,00		7,00				standard
• F-00924	2	0	18,00		24,00		3,00	DIS			Distributore inferiore
CT20759	2	0M2	18,00		32,00		8,00	POM			Pompa
F-00416	2	0MA	18,00		36,00		6,80	POM	Saginaw		alte temperature righe SX rotazione DX
F-00323	2	0	19,00		28,50		5,50	DIS		Isuzu, Subaru	
F-00462	2	0M2	19,00		29,00		7,00	POM			
F-00347	2	0M	19,00		31,80		6,30	DIS		SDI Burman	

CRE	Cremagliera	Rack	Гидроцилиндр
DIS	Distributore	Pignon	Распределитель
PIS	Pistone	Piston	Поршень
POM	Pompa	Pump	Насос
SCA	Scatola	Box	Корпус редуктора



Codice Code Код	Min Ord Мин. колич- ество заказа	Dis. Drawing Тип сальника	d1	d2	D	h1	H	Uso Use in Приме- нение	Marca Brand Произво- дитель агрегата	Tipo auto Vehicle type Тип авто	Note Remarks Примечания
			Размеры								
F-00774	2	0M	19,00		32,00		8,00	DIS		MGB	distributore inf.
CT20618	2	0M	19,05		28,90		4,76				
F-00150	2	0MA	19,05		31,75		6,30	POM		Capri, Lotus, Rover	
F-00504	2	0AM2	19,05		31,75		7,80	POM		veicoli commerciali	
F-00163	2	0MA	19,05		36,00		6,60	POM	Saginaw	Chrysler, Concord, Dodge	righe SX rotazione DX alte temperature
F-00146	2	0MA	19,05		36,00		7,00	POM	Saginaw	Granada, Volvo, Fiat Tipo	righe SX rotazione DX
F-00158	2	0MA	19,05		36,00		7,00	POM	Saginaw		righe DX rotazione SX
F-00641	2	0MA	19,05		36,00		7,00	POM		Granada-Volvo-Tipo	righe SX rotazione DX
F-00971	2	0M	20,00		27,00		4,76	DIS			
F-00508	2	0M2	20,00		30,00		8,00	POM		veicoli commerciali	alte temperature
F-00596	2	0M	20,00		32,00		5,00	DIS		Tata	
F-00891	2	0MA	20,00		32,00		5,00	DIS		Tata	originale/genuine
F-00703	2	0M2	20,00		34,00		8,00	POM	Koyo	Isuzu - Touareg- Mitsubishi-Kayaba	abbinare al paraolio F-00702
F-00153	2	0M2	20,00		35,00		8,00	POM	ZF	Bmw, Ducato	
F-00502	2	0M2	20,00		35,00		8,00	POM		Fiat Ducato	alte temperature
F-00736	2	0M2	20,00		36,00		8,00	POM		Mazda	doppio labbro
F-00159	2	0M2	20,00		40,00		8,00	POM			alte temperature
F-00643	2	0M2	20,00		40,00		8,00	POM			alte temperature
F-00920	2	0M2	20,00		40,00		8,00	POM	LUK	Luk	Luk
CT23956	2	0M	20,20		38,00		7,20	DIS		Amc Pacer 1978	
CT21996	2	0M	20,60		41,00		6,50	DIS		S-Max anno 2006	Distributore inferiore
F-00168	2	0M	20,68		41,20		6,30	DIS		Ford Mondeo, Fiesta	distributore sup. esterno
F-00667	2	0M	20,68		41,20		6,30	DIS		Mondeo, Fiesta	originale/genuine distributore sup.
F-00720	2	0M	20,68		41,20		6,30	DIS		Ford Mondeo, Fiesta	originale/genuine distributore sup.
F-00554	2	0M2	21,00		32,00		7,00	POM	LUK	Luk, Vichers	
F-00912	2	0M2	21,00		35,00		7,00	POM			Pompa LUK
F-00778	2	0M2	21,00		35,00		8,00	POM			
F-00679	2	0M	22,00		30,00		4,50	DIS		Rover 3,4 Bulloni	con tenuta esterna da Ø32,4
F-00893	2	0M	22,00		30,00		4,50	DIS		Rover 3,4 Bulloni	con tenuta esterna da Ø32,4
F-00027	2	0M	22,00		31,00		6,50	CRE	ZF	Porsche	originale/genuine
F-00425	2	0M	22,00		32,00		5,50	DIS		Rover 4 Bulloni	
F-00192	2	0M	22,00		32,10		5,00	DIS		Rover 4 Bulloni	
F-00325	2	0M	22,00		32,10		7,00	CRE	ZF	Ford Sierra	
F-00127	2	0M	22,00		34,00		7,50	DIS	ZF		
F-00304	2	0M	22,00		35,00		6,50	DIS		A & A	
F-00889	2	0M	22,00		35,00		6,50	DIS		A&A	originale/genuine
F-00333	2	0M	22,00		35,00		7,00	DIS	ZF	Porsche	
F-00969	2	0M2	22,00		35,00		7,00				
CT23279	2	0MA	22,00		35,20		8,00			Golf brasilie	originale/genuine
F-00867	2	0M2	22,00		40,30		7,00	POM		Bosch	pompa Bosch
F-00746	2	0	22,00	28,50	28,50	4,00	4,00	DIS			distributore inf.
F-00865	2	0	23,00		29,70		4,00	DIS		Sierra, Thema, Ducato	originale/genuine

**Paraoli**Seals
Сальники**in ordine di disegno**sorted by drawing
сортировка по туну

CRE	Cremagliera	Rack	Гидроцилиндр
DIS	Distributore	Pignon	Распределитель
PIS	Pistone	Piston	Поршень
POM	Pompa	Pump	Насос
SCA	Scatola	Box	Корпус редуктора

Codice Code Код	Min Ord Мин. коли- чество заказа	Dis. Drawing Тип сальника	d1	d2	D	h1	H	Uso Use in Приме- нение	Marca Brand Произво- дитель агрегата	Tipo auto Vehicle type Тип авто	Note Remarks Примечания
F-00019	2	0M	23,00		29,75		4,50	DIS	TRW		viton
● CT23451	2	12	23,00		32,00		5,00				
F-00097	2	0M	23,00		34,10		6,50	DIS		Toyota Corolla	
● F-00916	2	0M	23,00		35,00		6,50	DIS		Ssangyong	
F-00195	2	0M	23,00		38,10		6,80	DIS		Mitsubishi, Hyundai	
F-00032	2	0	23,30		29,70		4,00	DIS	TRW	Sierra, Thema, Ducato	standard
F-00036	2	0	23,30		29,70		4,00	DIS	TRW	Sierra, Thema, Ducato	originale/genuine
F-00590	2	0M	23,30		37,50		5,50	DIS		Kia Rio	con inserto
F-00118	2	0M	23,35		29,75		4,50	DIS	TRW	Bmw Z3, Mazda	metallico inserito
F-00758	2	0M	23,35		29,80		4,50	DIS	TRW	Bmw Z3, Mazda	(speciale) ultimo
F-00332	2	0M	24,00		33,00		5,00	DIS	ZF	Volkswage, Opel	tipo
F-00028	2	0M	24,00		33,00		7,00	CRE	ZF	Volvo	distributore inf. alta
F-00078	2	0M	24,00		36,00		7,00	CRE		Renault, Espace	temperatura
F-00295	2	0M	24,00		36,00		7,00	DIS		Subaru	originale/genuine
F-00823	2	0M	24,00		37,00		5,00	DIS		Bmw	originale/genuine
F-00048	2	0M	24,00		37,10		7,00	DIS CRE	ZF	Bmw	distributore inf. BMW
● CT22504	2	0M	24,00		38,00		6,50			Nissan Altima 2007	
F-00387	2	0M	24,00		38,00		7,00	DIS		Volvo	
F-00711	2	0M	24,40		35,00		6,00	DIS			
F-00888	2	0M	24,40		35,00		6,00	DIS			
F-00730	2	0	24,50		31,00		4,50	DIS		Ford	distributore inf.
F-00064	2	0M	25,00		33,00		6,00	DIS			
F-00301	2	0M	25,00		34,00		5,00	DIS		Ford	
F-00312	2	0M	25,00		34,00		5,00	DIS	ZF	Saab 900,9000 Toyota	
F-00196	2	0M	25,00		34,00		7,00	DIS	ZF	Carina	
F-00422	2	0M	25,00		34,00		7,00	CRE		Calibra, Mercedes	
F-00199	2	0M	25,00		35,00		7,00	DIS		Mercedes	
F-00509	2	0M2	25,00		35,00		7,00	POM		Toyota	
F-00598	2	0M2	25,00		35,00		8,00	POM		veicoli commerciali	
F-00631	2	0M2	25,00		35,00		8,00	POM			
F-00696	2	0M	25,00		35,10		6,00	DIS		Celica	righe DX e SX
F-00500	2	0M	25,00		35,80		6,80	DIS		Toyota	
F-00530	2	0M	25,00		36,00		5,00	DIS		Nissan	
F-00353	2	0M	25,00		37,00		6,70	DIS		Sanny,240SX,300ZX	
F-00031	2	0M	25,00		38,00		7,00	CRE	ZF	Burman	
F-00302	2	0M	25,00		39,00		9,00	CRE		Audi	originale/genuine
F-00731	2	0M2	25,00		40,00		8,00	POM	ZF		doppia molla
F-00819	2	0M2	25,00		40,00		8,00	POM	ZF		doppia molla alta
F-00788	2	0M	25,00		47,00		7,00	DIS			temperatura
● CT23447	2	0M	25,50		42,10		6,40	DIS			distributore inf.
F-00025	2	0M	26,00		35,00		7,00	CRE	ZF	Bmw-Alfa 33	originale/genuine
F-00483	2	0M	26,00		35,00		7,00	CRE	ZF	Alfa 33 - Toyota Carina	originale/genuine
F-00693	2	0A	26,00		35,00		11,00	DIS		Daf	

INFORMAZIONE TIP РЕКОМЕНДАЦИИ

I paraoli minorati sono identificati con la lettera finale «X»
Esempio F-00024: dimensioni normali - F-00024X: minorato
Reduced seals are identified with final letter «X»
Example F-00024: regular sizes - F-00024X: reduced seal
Сальники, обозначенные буквой «X», являются аналогами стандартных сальников с уменьшенным внутренним диаметром
Например: F-00024 - стандартный F-00024X - с уменьшенным внутренним диаметром



Codice Code Код	Min Ord Мин. коли- чество заказа	Dis. Drawing Тип сальника	d1	d2	D	h1	H	Uso Use in Приме- нение	Marca Brand Произво- дитель агрегата	Tipo auto Vehicle type Тип авто	Note Remarks Примечания
			Размеры								
F-00331	2	0M	26,00		37,00		5,00	CRE	ZF	Jaguar	
F-00675	2	0M	26,00		37,00		6,30	DIS	TRW	Porsche E 911	
F-00047	2	0M	26,00		37,00		7,00	DIS	ZF	Audi, Alfa	originale/genuine
F-00490	2	0M	26,00		37,00		7,00	CRE	ZF	Bmw	originale/genuine
F-00124	2	0M	26,00		37,00		7,10	CRE	ZF	Audi A4,A6	
F-00206	2	0M	26,00		38,20		6,50	DIS		Toyota-Mitsubishi	
F-00367	2	0M	27,00		36,00		5,50	DIS		Mercedes Vito	
F-00065	2	0M	27,00		37,00		7,00	DIS			
F-00408	2	0M	27,00		38,00		5,50	DIS		Honda	
F-00811	2	0MA	27,00		38,00		6,50	DIS		Nissan Maxima - Nissan Altima '04-'06, Almera Tino	
F-00611	2	0M	27,00		41,00		5,50	DIS		Honda	
F-00361	2	0M	27,50		37,00		6,90	DIS		Rolls Royce	
F-00817	2	0M	27,75		37,30		6,50	DIS		Pontiac GTO 2004	distributore inf.
F-00985	2	0M	27,75		37,30		6,50	DIS		Pontiac GTO 2004	distributore inf.
F-00795	2	0	28,00		35,00		4,00	DIS			
F-00041	2	0M	28,00		36,60		9,00	CRE	TRW	Alfa 155	originale/genuine
F-00134	2	0M	28,00		37,00		4,50	DIS	TRW	Skoda Octavia – Audi A3	distributore inf.
F-00088	2	0M	28,00		37,00		5,00	DIS	ZF	Skoda Octavia – Audi A3-Bmw-Vw-	
F-00979	2	0M	28,00		37,00		5,00	DIS	ZF	Audi A4	Genuin
F-00132	2	0M	28,00		37,10		4,60	DIS		Mercedes	
F-00319	2	0M	28,00		37,20		5,00	DIS	ZF	Audi A4	
F-00682	2	0M	28,00		37,20		5,80	DIS		Bentley Arnage btm pinion seal	originale/genuine distributore inf.
F-00907	2	0M	28,00		37,30		6,50	DIS		Pontiac GTO 2004	distributore inf. originale/genuin
CT21992	2	0M	28,00		37,60		6,20	DIS		S-Max anno2006	Distributore inferiore
F-00169	2	0M	28,00		37,70		5,00	DIS		Ford Mondeo, Fiesta	distributore inf.
F-00487	2	0M	28,00		37,70		5,00	DIS		Mondeo - Fiesta	
F-00026	2	0M	28,00		38,00		7,00	CRE	ZF	VW, Bmw 3, Audi	originale/genuine
F-00142	2	0M	28,00		38,00		7,00	DIS	ZF	Bmw - Mercedes	
F-00479	2	0M	28,00		38,00		7,00	CRE		Mercedes	
F-00981	2	0M	28,00		38,00		7,00	CRE	ZF	VW, Bmw 3, Audi	originale/genuine
F-00404	2	0	28,00		38,20		6,50	DIS		Bmw, Opel	
CT24108	2	0M	28,00		38,20		7,00	DIS	ZF	Bmw 3	originale/genuine
F-00394	2	0M	28,00		38,50		5,00	DIS		Suzuki Swift	
F-00204	2	0M	28,00		41,00		6,50	DIS		Toyota	
F-00747	2	0M	28,00		42,00		6,00	DIS		Mitsubishi Diamante	distributore inf. - con inserto metallico inserto standard
F-00836	2	0MA	28,00		43,00		10,00	POM		Fiat Iveco Vaz-Lada	
F-00045	2	0M	28,00		44,00		6,00	DIS	Smi-Koyo	Renault	
F-00495	2	0M	28,50		37,80		5,00	DIS		Ford Fiesta ultimo tipo	
F-00081	2	0M	28,50		43,00		6,50	DIS	TRW	Renault, Clio	originale/genuine
F-00431	2	0M	28,50		43,00		6,50	DIS		Renault Clio	originale/genuine
F-00633	2	0M	28,50		43,00		6,50	DIS		Renault Clio	
F-00433	2	0M	28,60		37,60		5,10	DIS			
F-00428	2	0	28,60		38,00		6,00	DIS		Nissan King Kab	

CRE	Cremagliera	Rack	Гидроцилиндр
DIS	Distributore	Pignon	Распределитель
PIS	Pistone	Piston	Поршень
POM	Pompa	Pump	Насос
SCA	Scatola	Box	Корпус редуктора

Codice Code Код	Min Ord Мин. коли- чество заказа	Dis. Drawing Тип сальника	d1	d2	D	h1	H	Uso Use in Приме- нение	Marca Brand Произво- дитель агрегата	Tipo auto Vehicle type Тип авто	Note Remarks Примечания
			Размеры								
CT20897	2	OMA	28,60		40,00		5,00	DIS		Nissan King Kab	
• CT23955	2	OMA	28,60		41,30		12,80	CRE		Amc Pacer 1978	
F-00594	2	OM	29,00		40,00		7,00	CRE		Modifica Transit rettificato	
F-00358	2	OM	29,00		43,00		7,00	DIS	ZF	Citroen XM,Xara, Alfa 159,	
• F-00980	2	OM	29,00		43,00		7,00	DIS	ZF	Citroen XM,Xara, Alfa 159,	Genuin
F-00673	2	OM	29,00		43,10		7,00	DIS		Hyundai, Lantra	originale/genuine
• CT24682	2	OMA	29,90		47,00		8,00				Genuin, righe SX,rotazione DX
F-00212	2	OM	30,00		38,00		5,00	DIS		Toyota Space Cruiser	
F-00456	2	0	30,00		38,00		7,00	DIS		Mazda	
F-00521	2	0	30,00		40,00		6,50	CRE		veicoli commerciali	alta pressione
F-00062	2	OM	30,00		40,00		7,00	CRE	ZF	F.Transit	originale/genuine
F-00209	2	OM	30,00		41,00		6,50	CRE		Toyota Supra	
F-00405	2	OM2	30,00		42,00		7,00	POM		Mercedes BMW LUK	
F-00850	2	OM	30,00		43,00		6,00	DIS		Dodge	distributore inferiore originale/ genuin
F-00208	2	OM	30,00		43,00		6,50	CRE		Toyota Land Cruiser	
F-00055	2	OM	30,00		47,00		6,00	DIS			
F-00175	2	OA	30,20		42,00		6,00	DIS		Mitsubishi	
F-00205	2	OM	31,00		44,00		6,50	DIS		Toyota	
• F-00903	2	OM	31,75		41,30		6,50	DIS	TRW	Kirby	Distributore inf. originale/genuine
• CT23718	2	OA	32,00		42,00		4,00			Nissan Patrol	
F-00213	2	OM	32,00		42,00		5,00	DIS		Toyota	
• F-00989	2	0	32,00		42,00		5,00	DIS			Genuin
F-00173	2	OA	32,00		42,00		6,50	DIS		Mitsubishi	
• F-01002	2	OM	32,00		43,00		5,00	DIS			
F-00469	2	OM	32,00		44,50		5,50	CRE		Cherokee ultimo tipo	
F-00568	2	OM	32,00		44,60		8,00	DIS		Mitsubishi, Cherokee	
F-00595	2	OA	32,00		45,00		4,50	DIS		Tata	
F-00430	2	0	32,00		45,10		6,50	DIS		Range Rover 93	
F-00742	2	OM	32,70		42,70		6,70	DIS		Toyota Landcruiser J 120	
• F-00908	2	OM	33,50		46,10		7,30	DIS		Ford, Limusine	
F-00664	2	OM	35,00		45,00		7,00	DIS		Euroclass	
• F-00984	2	OM	35,00		46,10		7,30	DIS			
F-00174	2	OA	35,00		47,00		7,50	DIS		Mitsubishi	
F-00660	2	0	35,00		47,30		7,00	DIS		Tata Safari	
F-00757	2	OM	35,00		58,00		10,00	DIS		Mazda	
• CT24645	0	0	35,91		46,10		7,20				
F-00383	2	OM	36,00		44,00		5,00	CRE		Toyota	
F-00674	2	0	38,00		50,90		5,00	DIS		Veicolo commerciale	parapolvere
F-00892	2	0	38,00		50,90		5,00	DIS		Veicolo commerciale	Parapolvere
F-00647	2	OM	38,00		52,60		6,40	DIS		Dodge RAM	
F-00549	2	OM	52,00		66,00		5,50	DIS		Mercedes LS4	
F-00550	2	OA	52,00		68,00		6,00	DIS		Mercedes LS4	con righe interne
• CT22028	2	OM	52,00		68,00		8,00	DIS		Mercedes LS4	Mercedes LS4
• CT24732	2	OMA	55,00		72,00		7,00	DIS		Mercedes	

Gli articoli identificati con l'iniziale «CT» (codice temporaneo) sono attualmente in fase di test e prossimi all'introduzione definitiva nel mercato.

Items whose code starts with «CT» (temporary code) are currently being tested and they are candidate to be introduced in the market soon.
Пункты, обозначенные аббревиатурой «СТ» (временный код), в данный момент проходят испытания и будут представлены на рынок в ближайшее время.

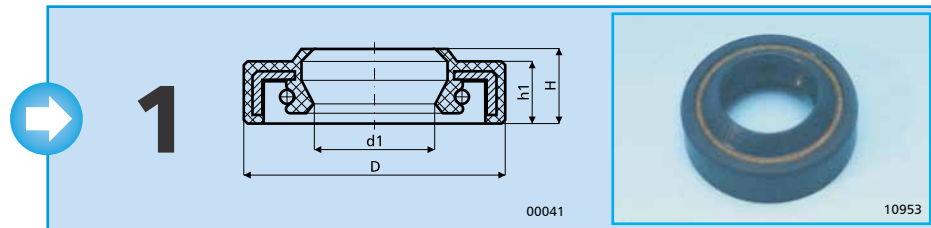

Codice Code Код	Min Ord Мин. количество заказа	Dis. Drawing Тип сальника	d1	d2	D	h1	H	Uso Use in Применение	Marca Brand Производитель агрегата	Tipo auto Vehicle type Тип авто	Note Remarks Примечания
F-00909	2	1PM	8,00		16,00	7,00	7,00	POM		Mercedes Classe A	Mercedes Classe A
F-00789	2	1PM	8,00		18,00	7,00	7,00	POM			
CT22447	2	1PM	8,00		20,00	5,30	6,00				pompa Mercedes elettrica
F-00874	2	1PM	8,00		22,00	7,00	7,50	POM		Mercedes Classe "A"	sotto piastra Mercedes classe A -
F-00650	2	1PM	9,00		19,05		7,30	POM	ZF	Bmw E46,316,318	fino a 120 bar
F-00963	2	1PM	9,00		22,00		7,00	POM		Mercedes o Volvo	Pompa ZF
F-00964	2	1PM	9,00		23,00	7,00	8,00	POM	ZF	Mercedes o Volvo	Pompa ZF
F-00355	2	1PM	10,00		20,00		7,00	CRE			
F-00574	2	1PM	10,00		21,00	7,00	7,30	POM	LUK	Luk	abbinare a F-00575
F-00852	2	1PM	10,00		21,00	7,00	7,30	POM	LUK	Luk	abbinare a F-00853
F-00958	2	1PM	10,00		22,00		6,00	POM			alta temperatura
F-00953	2	1PM	10,00		22,00	6,00	6,50	POM		Mini	
F-00575	2	1PM	10,00		22,00	7,00	8,00	POM	LUK	Luk	abbinare a F-00574
F-00853	2	1PM	10,00		22,00	7,00	8,00	POM	LUK	LUK	abbinare a F-00852
F-00702	2	1PM	11,00		25,00	6,40	6,40	POM	Koyo	Touareg	abbinare al paraolio F-00703
CT22007	2	1PM	11,75		22,00	6,00	6,50	POM		Voyager	originale/genuine
F-00608	2	1PM2	11,75		22,00	6,00	8,50	POM		Cherokee, Voyager Diesel engine	originale/genuine
F-00364	2	1PM	11,75		22,00	7,00	10,00	POM		Cherokee	
F-01000	2	1PM	11,75	22,00	22,00	7,00	10,00	POM		Cherokee	originale-genuine Cherokee
F-00870	2	1PM	12,00		22,00	6,00	6,50	POM			originale/genuine distributore sup.
F-00791	2	1PM	12,00		24,00	7,00	7,50	DIS			
F-00732	2	1PM	14,00		23,00		7,00	POM		Mercedes CK 500	
F-00733	2	1PM	14,00		24,00		7,00	POM		Mercedes CK 500	
F-00792	2	1PM	14,00		24,00	7,00	7,50	DIS			distributore sup.
F-00773	2	1P	15,00		22,00	4,00	4,00	DIS		Ford Sierra	parapolvere distributore sup.
F-00897	2	1P	15,00		22,00	4,00	4,00	DIS		Ford Sierra	parapolvere distributore sup.
F-00861	2	1P	15,00		22,00	4,00	4,50	DIS			originale/genuine
F-00068	2	1PM	15,00		22,00	4,50	5,20	DIS			
F-00439	2	1PM	15,00		24,00		6,00	POM		Rover	
F-00928	2	1PM	15,00		24,00	6,00	6,20	DIS		Ford Transit	distributore superiore
CT21268	2	1PM	15,00		24,00		7,00				
F-00998	2	0M	15,00		24,00		7,00				
F-00415	2	1PA	15,00		24,00	4,50	7,00	POM		Rover	
F-00162	2	1PM	15,00		24,00	7,00	7,00	POM		Rover 200 – Hoborn Eaton	
F-00300	2	1PM	15,00		24,00	7,00	7,00	DIS		Audi	distributore inf.
F-00155	2	1PM	15,00		25,00	5,00	5,20	POM		Honda	

Codice Code Код	Min Ord Мин. коли- чество заказа	Dis. Drawing Тип сальника	d1	d2	D	h1	H	Uso Use in Приме- нение	Marca Brand Произво- дитель агрегата	Tipo auto Vehicle type Тип авто	Note Remarks Примечания
F-00760	2	1PM	15,00		25,00		5,50	POM	LUK	Bmw LUK	
F-00767	2	1PM	15,00		25,00	7,00	7,00	DIS		Toyota starlet	distributore sup.
F-00432	2	1PMA	15,00		28,00	6,20	6,30	POM	ZF	Opel Vectra-Alfa 159	
F-00597	2	1PMA	15,00		28,00		7,00	POM		Subaru	
F-00744	2	1PMA	15,00		28,10	6,20	6,30	POM	ZF	Opel Vectra	alte temperature
F-00180	2	1PM	15,00		35,50	5,50	6,00	DIS		Honda, Rover	
F-00896	2	1PM	15,00		35,50	5,50	6,00	DIS		Honda, Rover	originale/genuine
F-00279	2	1PM	15,00		36,00	5,50	9,50	DIS		Honda	
F-00463	2	1PA	15,88		31,70		6,35	POM	Saginaw		
F-00968	2	1PMA	16,00		25,50	8,00	9,00	DIS			
F-00365	2	1PM	16,00		26,00	5,20	6,20	POM		Audi,Bmw	trattori LUK righe SX rotazione DX
F-00946	2	1PM	16,00		26,00		7,00	POM			
F-00947	2	1PM	16,00		27,00		7,00	POM			
F-00052	2	1PM	16,00		28,00	6,90	7,00	POM	ZF	Audi,Alfa	
F-00555	2	1PMA	16,00		30,00		6,25	POM		Ford Tempo	righe DX rotazione SX
F-00149	2	1PMA	16,00		30,00		6,50	POM		Ford Mondeo	righe SX rotazione DX
F-00689	2	1PMA	16,00		30,00		6,50	POM		Ford Mondeo	righe SX rotazione DX
F-00894	2	1PMA	16,00		30,00	6,30	6,50	POM		Ford Mondeo	originale/genuine- righe SX rotazione DX
F-00156	2	1PM	16,00		30,00	7,00	7,00	POM		Honda	righe DX rotazione SX
F-00461	2	1PA	16,00		34,00	36,00	38,00	DIS		Ford Mazda 626 323	pignone con metallo
F-00578	2	1PMA	16,00		35,00		13,00	POM		Opel Vectra-Motore Cavalier	alte temperature
F-00179	2	1PM	16,70		28,00		6,00	DIS		Honda	
F-00976	2	1PM	16,90		27,00	5,00	6,00	POM			
F-00775	2	1PM	17,00		25,00	4,00	4,00	DIS		Vauxhall Cavalier,Astra	distributore sup.
F-00606	2	1PM	17,00		29,00	6,30	6,50	POM		Mitsubishi	
F-00586	2	1PMA	17,00		29,00		8,00	POM		Toyota Corolla	
F-00556	2	1PM	17,00		29,90		7,00	POM		Kayaba	righe SX rotazione DX
F-00414	2	1PM	17,00		30,00		7,00	POM		Mazda	
F-00473	2	1PM	17,00		30,00		7,00	POM		Mazda	
F-00862	2	1P	17,00		30,50	4,00	4,50	DIS			originale/genuine
F-00157	2	1PMA	17,00		31,00	7,00	7,00	POM		Nissan	
F-00427	2	1PMA	17,00		31,00	8,00	8,00	POM			
F-00151	2	1PMA	17,00		32,00	7,20	7,20	POM		Nissan,Mitsubishi	
F-00154	2	1PM	17,00		32,00		8,00	POM		Nissan	
F-00165	2	1PMA	17,00		34,00		8,00	POM		Lexus GS 300, Camry 6 CYL 92,93	
F-00787	2	1PM	17,00		35,00	7,00	7,00	DIS			distributore sup.
F-00181	2	1PM	17,00		35,00		8,00	DIS			
F-00772	2	1P	17,00		40,00	4,60	6,20	DIS		Vauxhall Nova	parapolvere distributore sup.
F-00875	2	1PM	17,45		28,58		6,30	POM			
F-00503	2	1PM	17,46		28,58	5,80	6,30	POM		veicoli commerciali	
F-00388	2	1PM	17,90		35,50	8,20	10,00	DIS		Renault, Peugeot	

INFORMAZIONE TIP РЕКОМЕНДАЦИИ

I paraoli minorati sono identificati con la lettera finale «X»
Esempio F-00024: dimensioni normali - F-00024X: minorato
Reduced seals are identified with final letter «X»
Example F-00024: regular sizes - F-00024X: reduced seal
Сальники, обозначенные буквой «X», являются аналогами стандартных сальников с уменьшенным внутренним диаметром
Например: F-00024 - стандартный F-00024X - с уменьшенным внутренним диаметром



Codice Code Код	Min Ord Мин. коли- чество заказа	Dis. Drawing Тип сальника	d1	d2	D	h1	H	Uso Use in Приме- нение	Marca Brand Произво- дитель агрегата	Tipo auto Vehicle type Тип авто	Note Remarks Примечания
F-00182	2	1PM	18,00		28,00	5,00	6,00	DIS	ZF	Audi	
F-00781	2	1PM	18,00		30,00	5,50	6,00	DIS		Renault	originale/genuine
F-00782	2	1PM	18,00		30,00	6,00	6,50	DIS			originale/genuine
● CT24115	2	1PM	18,00		30,00	6,80	6,80	POM			alta temperatura, righe SX rotazione DX
F-00152	2	1PM	18,00		30,00	7,00	7,00	POM	ZF	Nissan, Mazda	
F-00771	2	1PM	18,00		30,00	7,00	7,00	DIS	ZF	Ford Transit	distributore sup.
F-00855	2	1PMA	18,00		30,00	7,00	7,00	DIS			originale/genuine
F-00648	2	1PM	18,00		30,00	7,00	7,50	DIS	ZF	Audi	
F-00051	2	1PM	18,00		30,00	7,00	8,00	DIS	ZF	Audi-Bmw	
F-00183	2	1PM	18,00		30,00	7,00	8,00	DIS	ZF	Nissan	
F-00517	2	1PM	18,00		30,00	7,00	8,00	DIS	ZF	Audi	
F-00080	2	1PM	18,00		30,10	5,50	6,00	DIS		Renault	
F-00632	2	1PM	18,00		30,10	5,50	6,00	DIS		Renault	alta temperatura
● F-00879	2	1PMA	18,00		31,80		6,30	POM		Ford Taurus	Righe SX rotazione DX
● F-00883	2	1PM	18,00		32,00	6,00	6,00				Righe SX rotazione DX
F-00117	2	1PM	18,00		32,00		7,00	DIS		Bendix, Transit	
F-00768	2	1PM	18,00		32,00	4,30	7,00	DIS		Renault Traffic	distributore sup.
● F-00959	2	1PM	18,00		32,00	6,00	7,00	DIS			originale/genuine, alta temperatura
F-00164	2	1PA	18,00		32,00		8,00	POM		Isuzu	
F-00741	2	1PMA	18,00		32,10	8,00	8,50	POM			
F-00464	2	1PMA	18,00		34,00	7,90	8,00	POM		Voyager	
F-00185	2	1PM	18,00		34,00	7,50	12,50	DIS			
F-00460	2	1A	18,00		34,00	17,00	20,00	DIS		Mazda	pignone con metallo
● CT23341	2	1PMA	18,00		34,10	8,00	8,20	POM		Dodge	
F-00627	2	1PM	18,00		34,60	6,20	7,50	DIS		Ford, Opel Astra, Ford Focus	minorato per pignoni rettificati
● F-00030X	2	1PM	18,50		34,60	4,40	5,90	DIS	TRW	Regata, Golf, Peugeot 205	minorato
● F-00921	2	1P	18,50		40,00	5,00	5,00			Mazda 3	parapolvere Mazda
F-00657	2	1PM	18,70		35,00	7,00	7,50	DIS		Mitsubishi	originale/genuine
F-00136	2	1PM	18,70		35,00	7,00	8,00	DIS		Mitsubishi	
F-00395	2	1PM	18,75		30,00	5,00	6,00	DIS		Suzuki Swift	
F-00799	2	1PM	18,75		37,50	5,50	8,00	DIS		Honda Civic	
F-00189	2	1PM	18,80		30,00	5,00	6,00	DIS		Nissan	
F-00863	2	1P	19,00		26,00	4,00	4,50	DIS			originale/genuine
F-00201	2	1PM	19,00		27,00		5,00	DIS		Rover 6 Bulloni	
● F-00904	2	1PM	19,00		27,20	5,00	5,00	DIS		Tata	distrib. superiore, originale/genuine
F-00313	2	1PM	19,00		28,00	5,00	6,00	DIS	ZF	Volkswagen	
F-00484	2	1PM	19,00		29,00	4,40	6,30	DIS		Nissan Almera-Primera	
● CT22760	2	1PM	19,00		29,00	7,00	7,90				
F-00459	2	1PM	19,00		29,00	7,00	8,00	DIS		Toyota Yaris	
● F-00459M	2	1PM	19,00		29,00	7,00	8,00	DIS		Toyota Yaris	
● F-00993	2	1PM	19,00		30,00	5,00	5,50	DIS			originale/genuine
F-00740	2	1PM	19,00		30,00	5,50	6,00	DIS		Nissan, Renault	originale/genuine
F-00619	2	1PM	19,00		30,00		6,50	POM			speciale



Paraoli
Seals
Сальники

in ordine di disegno
sorted by drawing
сортировка по муну

CRE	Cremagliera	Rack	Гидроцилиндр
DIS	Distributore	Pignon	Распределитель
PIS	Pistone	Piston	Поршень
POM	Pompa	Pump	Насос
SCA	Scatola	Box	Корпус редуктора

Codice Code Код	Min Ord Мин. коли- чество заказа	Dis. Drawing Тип сальника	d1	d2	D	h1	H	Uso Use in Приме- нение	Marca Brand Произво- дитель агрегата	Tipo auto Vehicle type Тип авто	Note Remarks Примечания
F-00111	2	1PM	19,00		30,00	6,40	7,00	DIS		Nissan	
F-00769	2	1PM	19,00		30,00	7,00	7,00	DIS		Ford Transit	distributore sup.
F-00315	2	1PM	19,00		30,00	7,00	8,00	DIS		Volvo	
F-00110	2	1PM	19,00		30,10	5,00	6,00	DIS		Nissan, Renault	
F-00602	2	1PMA	19,00		31,90		8,00	POM			
F-00418	2	1PM	19,00		32,00		7,00	POM	ZF	Opel, Skoda, VW	viton
F-00114	2	1PM	19,00		32,00	6,00	7,00	DIS		Toyota, Mitsubishi, Nissan	
F-00403	2	1PM	19,00		32,00	6,00	7,00	DIS		Toyota Pik up e 4x4	
F-00600	2	1PM	19,00		32,00	6,00	7,00	DIS		Toyota-Mitsubishi	originale/genuine
F-00779	2	1PM	19,00		32,00	6,00	7,00	DIS		Hyundai Atos	originale/genuine
F-00366	2	1PM	19,00		32,00	6,90	7,00	POM	ZF	Vito, Trova way	
F-00187	2	1PM	19,00		32,20	7,00	8,00	DIS		Toyota	
F-00011	2	1PM	19,00		34,60	6,20	9,20	DIS	TRW	Fiat Tipo, Croma, Thema, Sierra	
F-00037	2	1PM	19,00		34,60	6,20	9,20	DIS	TRW	Fiat Tipo, Croma, Thema, Ford, Volvo	originale/genuine
F-00849	2	1PM	19,00		34,70	6,30	7,00	DIS		Kia	distributore originale/genuine
F-00140	2	1PM	19,00		37,00	6,50	9,00	DIS	Koyo	Mitsubishi, Toyota, Audi A4	
F-00886	2	1PM	19,00		37,00	6,50	9,00	DIS		Mitsubishi, Toyota, Audi A4	
F-00184	2	1PM	19,00		38,00	7,00	8,00	DIS		Toyota Corolla	
F-00308	2	1PM	19,00		42,00	6,50	8,00	DIS		Mazda RX7	
CT23450	2	1PMA	19,05		28,60	4,70	5,00				
F-00533	2	1PM	19,05		30,00	7,00	8,00	POM	LUK	Mercedes	righe SX rotazione DX
F-00607	2	1PM	19,05		30,20	5,00	7,30	DIS		Nissan	
F-00167	2	1PMA	19,05		31,75	6,50	6,60	POM			
F-00421	2	1PMA	19,05		33,30		8,00	POM			
F-00160	2	1PM	19,05		33,33		7,90	POM		Bmw, Porsche, Mercedes	originale/genuine
F-00529	2	1A	19,05		33,33		8,00	POM		Mercedes	righe SX rotazione DX
F-00144	2	1PM	19,05		33,33	8,00	8,50	POM	ZF	Bmw-Volkswagen-Porsche	
CT24136	2	1PMA	19,05		33,40	8,00	8,00	POM	ZF	R9-R19-Porsche-Bmw-Volkswagen	righe SX rotazione DX tiraggio maggiorato
F-00143	2	1PMA	19,05		33,40	8,00	8,00	POM	ZF	R9-R19-Porsche-Bmw-Volkswagen	righe SX rotazione DX tiraggio maggiorato
F-00145	2	1PMA	19,05		33,40	8,00	8,00	POM	Saginaw	Bmw, Laguna, Fiat Tipo	righe SX rotazione DX alte temperature (viton)
F-00030	2	1PM	19,05		34,60	4,40	5,90	DIS	TRW	Regata, Golf, Peugeot 205	
F-00087	2	1PM	19,05		34,60	4,40	5,90	DIS		Peugeot 205 U.T., Vw Golf.	originale/genuine
F-00688	2	1PM	19,05		34,60	4,40	5,90	DIS	TRW	Golf	originale/genuine alte temperature (America)
F-00561	2	1PM	19,05		34,60	6,20	7,50	DIS	TRW	Opel Astra, Focus	

ATTENZIONE! WARNING! ВНИМАНИЕ!

Gli articoli identificati con l'iniziale «CT» (codice temporaneo) sono attualmente in fase di test e prossimi all'introduzione definitiva nel mercato.

Items whose code starts with «CT» (temporary code) are currently being tested and they are candidate to be introduced in the market soon.
Пункты, обозначенные аббревиатурой «СТ» (временный код), в данный момент проходят испытания и будут представлены на рынок в ближайшее время.



Codice Code Код	Min Ord Мин. коли- чество заказа	Dis. Drawing Тип сальника	d1	d2	D	h1	H	Uso Use in Приме- нение	Marca Brand Произво- дителя агрегата	Tipo auto Vehicle type Тип авто	Note Remarks Примечания
● F-00868	2	1PM	19,05		34,60	6,30	9,00	DIS		Fiat Tipo, Croma, Thema, Ford, Volvo	originale/genuine alta temperatura
F-00368	2	1PM	19,05		34,70	6,20	7,50	DIS	TRW	Opel Astra, Focus, Polo	originale/genuine
F-00677	2	1PMA	19,05		34,80	4,40	5,90	DIS	TRW	Golf	America
F-00895	2	1PMA	19,05		34,80	4,40	5,90	DIS	TRW	Golf	originale/genuine
● F-00915	2	1PM	19,05		37,00	6,50	7,50	DIS		Saang Yong Musso	
F-00659	2	1PM	19,50		41,30	6,50	8,50	DIS	TRW	Ford Fusion	per albero minorato distributore (alte temperature)
F-00138	2	1PM	19,90		39,90		6,50	DIS	Saginaw	Fiat Bravo, Brava	originale/genuine
F-00681	2	1PM	20,00		30,00	5,00	5,20	DIS			originale/genuine
F-00887	2	1PM	20,00		30,00	5,00	5,20	DIS			originale/genuine
● CT24110	2	1PM	20,00		30,00	5,00	6,00	DIS		Bmw X3	Originale/genuine
F-00063	2	1PM	20,00		30,00	5,00	6,00	DIS	ZF	Renault, Scorpio, Peugeot, Toyota	
F-00663	2	1PM	20,00		30,00	5,00	6,00	DIS	ZF	Renault, Scorpio, Peugeot, Toyota	originale/genuine
● F-00978	2	1PM	20,00		30,00	5,00	6,00	DIS		Mercedes, Toyota	Genuin
F-00297	2	1PM	20,00		30,00	4,90	6,10	DIS		Mazda	alta pressione
F-00147	2	1PM	20,00		30,00		7,00	POM		Land Rover, Daimler, Montego, Maestro	
F-00054	2	1PM	20,00		30,00	7,00	8,00	DIS	ZF		originale/genuine
F-00666	2	1PM	20,00		30,00	7,00	8,00	DIS			
● F-00884	2	1PM	20,00		30,10	7,00	7,50				
F-00558	2	1PM	20,00		30,20	5,00	6,00	DIS		Mercedes, Toyota	
F-00058	2	1PM	20,00		32,00	5,00	5,50	DIS	ZF	Citroen BX, Xantia	
F-00413	2	1PM	20,00		32,00		8,00	POM		Mazda	
F-00840	2	1PM	20,00		34,10	6,00	7,00	DIS	Mando	Jeep	
● F-01004	2	1PM	20,00		34,10	6,00	7,00	DIS	Mando	Jeep	originale-genuine
F-00161	2	1PM	20,00		34,10	7,00	7,00	POM		Rover 600	
F-00609	2	1PM	20,00		35,00		7,00	DIS		Isuzu Trooper, Vauxall Montery	
F-00390	2	1PM	20,00		35,00	6,00	7,00	POM		Alfa 155 ,Cherokee, Astra	standard
F-00391	2	1PM	20,00		35,00	6,00	7,00	POM		Alfa 155 ,Cherokee, Astra	alte temperature
F-00640	2	1PM	20,00		35,00	6,00	7,00	POM		Alfa 155,Cherokee,Astra	standard
F-00562	2	1PM	20,00		35,60	6,00	7,70	DIS		Jeep Grand Cherokee	
F-00166	2	1PM	20,00		36,00		7,00	POM			
F-00186	2	1PM	20,00		40,00		6,00	DIS	Saginaw	Fiorino, Opel Vectra 96, Sintra	alte temperature
F-00100	2	1PM	20,00		40,00		6,30	DIS	Saginaw	Saab	
F-00728	2	1PA	20,00		41,00		6,50	DIS		Mondeo Ultimo tipo	
F-00511	2	1PM	20,00		42,00		7,00	POM		veicoli commerciali	alte temperature
F-00761	2	1PM	20,00		42,30	7,00	9,30	DIS	TRW	Mazda	distributore sup.
F-00420	2	1PM	20,00		42,50		4,80	DIS	TRW	Alfa 156	
F-00108	2	1PM	20,00		42,50	3,80	5,00	DIS	TRW	Alfa 166,156	
F-00109	2	1PM	20,00		42,50	7,00	8,00	DIS	TRW	Mercedes, Mazda	
F-00449	2	1PM	20,00		42,50	9,00	10,00	DIS		Mercedes	
● F-00997	2	1PM	20,00		44,50	3,80	5,00	DIS	TRW		Maggiorato esternamente sulla parte esterna

CRE	Cremagliera	Rack	Гидроцилиндр
DIS	Distributore	Pignon	Распределитель
PIS	Pistone	Piston	Поршень
POM	Pompa	Pump	Насос
SCA	Scatola	Box	Корпус редуктора

Codice Code Код	Min Ord Мин. колич- ество заказа	Dis. Drawing Тип сальника	d1	d2	D	h1	H	Uso Use in Приме- нение	Marca Brand Произво- дитель агрегата	Tipo auto Vehicle type Тип авто	Note Remarks Примечания
			Размеры								
F-00614	2	1PM	20,20		32,00		8,00	POM		Honda Accura	rotazione DX
F-00516	2	1PM	20,50		34,20	7,00	7,50	DIS		Toyota Celica	righe dx e sx
F-00326	2	1PM	20,55		31,97		6,35	CRE		Rolls Royce	
F-00020	2	1PM	20,60		30,70	4,57	6,00	DIS	TRW	Granada	viton
F-00453	2	1PM	20,60		32,00	6,00	7,00	DIS		MK2 Land Rover - Discovery	
F-00576	2	1PM	20,60		35,63	6,30	7,50	DIS		Dodge	
F-00531	2	1PM	20,60		41,30	6,50	8,00	DIS	TRW	Ford Fusion	alte temperature
F-00493	2	1PM	20,70		41,50	6,00	8,00	DIS		Ford Fiesta ultimo tipo,Fusion	originale/genuine alte temperature
CT20945	2	1PM	21,00		33,00	5,50	7,00	DIS		Jeep Wrangler	distributore sup.
F-00605	2	1PM	21,00		33,00	8,00	9,50	DIS		Mercedes	
F-00442	2	1PM	21,00		33,00	8,00	10,00	DIS		Mercedes	
F-00193	2	1PM	22,00		32,00	5,00	6,00	DIS		Peugeot 505 Alta temperatura	
F-00680	2	1PM	22,00		32,00	5,00	6,00	DIS		Peugeot	originale/genuine distributore sup.
F-00890	2	1PM	22,00		32,00	5,00	6,00	DIS		Peugeot	originale/genuine
F-00690	2	1PM	22,00		32,00		7,00	DIS			
F-00061	2	1PM	22,00		32,00	7,00	7,50	POM	ZF	Volvo	
F-00938	2	1PM	22,00		32,30	5,00	5,20	DIS		Subaru Forester	Distributore superiore
F-00610	2	1PM	22,00		35,00		7,00	DIS		Nissan	
F-00053	2	1PM	22,00		35,10		7,00	DIS			standard
F-00918	2	1PM	22,00		40,00		7,00	POM		Umm Jabata	
F-00748	2	1PM	22,20		31,90	6,00	7,50	DIS		Mitsubishi Diamante	distributore sup.
F-00069	2	1PM	22,20		32,00	5,00	6,00	DIS		Peugeot 505 azzurro	
F-00759	2	1PM	22,20		32,00	5,00	6,00	DIS		Peugeot 505, Citroen	originale/genuine
F-00759M	2	1PM	22,20		32,00	5,00	6,00	DIS		Peugeot 505, Citroen	
F-00177	2	1PM	22,20		35,00		7,00	DIS		Isuzu, Frontera, Trooper	
F-00834	2	1PM	22,22		40,60	6,00	7,50	DIS	TRW		right DX E SX
F-00528	2	1PM	22,23		35,15		9,50	DIS		veicoli commerciali	
F-00898	2	1PM	22,23		35,15	9,50	9,50	DIS		veicoli commerciali	originale/genuine
F-00526	2	1PM	22,30		32,20	5,40	6,50	DIS		Suzuki Baleno	
F-00194	2	1PM	23,00		35,00	6,50	7,00	DIS		Mitsubishi, Toyota	
F-00359	2	1PM	23,30		37,00		7,30	DIS		Citroen XM,Xara	
F-00410	2	1PM	23,40		37,30	8,00	8,20	DIS		Citroen XM	
F-00820	2	1PM	23,50		32,50	5,00	5,30	DIS		Nissan Pathfinder,Navara	distributore inf.
F-00837	2	1PM	23,50		32,70	5,00	5,35	DIS		Nissan	originale/genuine
F-00927	2	1PM	24,00		32,50	5,40	5,45	DIS		Nissan Murano	
F-00089	2	1PM	24,00		33,00	5,00	6,00	DIS	ZF	A 3,Golf, Octavia	
F-00496	2	1PM	24,00		36,00	7,00	8,00	DIS		Nissan	
F-00099	2	1PMA	24,00		43,00		8,50	POM	Smi-Koyo	Toyota Landcruiser	
F-00311	2	1PM	25,00		34,00	6,00	6,50	DIS		Mazda	
F-00009	2	1PM	25,00		35,00	6,90	7,00	DIS	TRW		
F-00615	2	1PMA	25,00		35,00	6,80	8,00	POM	ZF		
F-00721	2	1PM	25,00		37,00	6,00	6,50	DIS	ZF-LUK		
F-00096	2	1PM	25,00		38,10	7,00	8,00	DIS	Smi-Koyo	Toyota	
F-00200	2	1PM	25,00		42,00	6,50	7,00	DIS		Nissan	

INFORMAZIONE TIP РЕКОМЕНДАЦИИ

I paraoli minorati sono identificati con la lettera finale «X»
Esempio F-00024: dimensioni normali - F-00024X: minorato
Reduced seals are identified with final letter «X»
Example F-00024: regular sizes - F-00024X: reduced seal
Сальники, обозначенные буквой «X», являются аналогами стандартных сальников с уменьшенным внутренним диаметром
Например: F-00024 - стандартный F-00024X - с уменьшенным внутренним диаметром



Codice Code Код	Min Ord Мин. коли- чество заказа	Dis. Drawing Тип сальника	d1	d2	D	h1	H	Uso Use in Приме- нение	Marca Brand Произво- дитель агрегата	Tipo auto Vehicle type Тип авто	Note Remarks Примечания
F-00525	2	1PM	25,40		38,10		6,35	DIS		Daf Veicolo commerciale	
F-00141	2	1PM	25,70		35,50	7,00	8,00	DIS	Koyo	Audi A4	
F-00309	2	1PM	26,00		35,00	6,00	6,50	DIS		Mazda	
F-00303	2	1PM	26,00		35,50	6,00	6,50	DIS		Subaru	
F-00389	2	1PM	26,00		37,00	7,00	8,00	DIS	ZF		
F-00354	2	1P	26,50		43,20	9,20	11,70	CRE		A E A M X 2	
F-00443	2	1PM	27,00		38,10	5,50	7,50	DIS		TAS 75,85	
F-00937	2	1PM	27,50		38,00	5,00	5,20	DIS		Nissan Infinity G35	Nissan Infinity G35
F-00059	2	1PM	27,80		40,00	5,50	6,50	DIS	ZF	Peugeot 505	
F-00944	2	1PMA	28,00		35,00		5,00			F.Transit	
F-00617	2	1PA	28,00		38,00	5,00	8,00	SCA		Iveco, Scania	parapolvere pistone
F-00835	2	1PMA	28,00		38,40		7,50	DIS		Suzuki-Mazda 3	originale/genuine
F-00954	2	1PMA	28,00		39,50	8,00	8,00	DIS			
F-00434	2	1PM	28,00		40,00	6,00	7,00	DIS			
F-00548	2	1PM	28,00		40,00	5,50	7,50	DIS		Mercedes LS4	
F-00785	2	1PMA	28,00		40,00	7,60	7,60	DIS			
F-00172	2	1PM	28,00		40,00	7,00	8,00	DIS	ZF	Bmw	
F-00478	2	1PM	28,00		40,00	8,00	10,50	DIS		Mercedes LS7 LS8 LS3	
F-00786	2	1PM	29,00		39,00	5,50	6,00	DIS		Nissan	
F-00435	2	1PM	29,40		46,80	6,30	7,00	DIS		Peugeot	
F-00073	2	1PM	29,40		47,00	6,00	7,00	DIS		Citroen, Peugeot, Xantia	originale/genuine
F-00073M	2	1PM	29,40		47,00	6,00	7,00	DIS		Citroen, Peugeot, Xantia	Distributore sup.
F-00507	2	1PM	30,00		40,00		7,00	POM		veicoli commerciali	
F-00458	2	1PM	30,00		42,00	7,00	8,00	DIS		Lexus	
F-00753	2	1PM	30,00		42,00	8,00	8,00	DIS			distributore sup.
F-00046	2	1PM	30,00		43,00	8,00	9,50	DIS	ZF	Mercedes 190	originale/genuine
CT20602	2	1PM	30,00		64,00	5,00	6,00	DIS		TAS 75/80	Genuin
F-00455	2	1PM	32,00		42,00	7,00	9,00	DIS		Kia, Daiatshu	
F-00446	2	1PM	32,00		44,00	8,50	10,00	DIS		Mercedes	
F-00567	2	1PM	32,00		44,60		10,00	DIS		Mitsubishi	
F-00357	2	1PM	32,00		45,00		7,00	DIS			
F-00793	2	1PM	32,00		45,00	7,00	7,50	DIS			originale/genuine
F-00618	2	1PA	32,00		45,00	7,00	10,00	SCA		Iveco, Scania	parapolvere pistone
CT23413	2	1PM	32,00		47,00		10,00			Volswagen	Volswagen
CT24869	2	1PM	32,00		47,00		10,00			Mercedes	Paraolio motore, Mercedes
F-00314	2	1PM	34,00		44,40		6,00	DIS		Mazda, Ford	
F-00665	2	1PM	35,00		45,00		7,00	DIS		Euroclass	
F-00424	2	1PM	35,00		47,00	7,00	8,50	DIS		Mercedes SLE	
F-00452	2	1PMA	35,00		47,00	8,00	10,00	DIS		Mitsubishi	
F-00385	2	1PM	35,00		50,00	8,00	10,00	DIS		Mercedes	
F-00552	2	1PMA	38,00		50,00	8,00	9,50	DIS		Nissan Patrol GQ	
CT22685	2	1PM	40,00		51,00	5,00	6,00	DIS		TAS 20	
F-00692	2	1PM	40,00		52,00	8,00	11,00	DIS		Mercedes	Distributore superiore, (BLU)
F-00925	2	1PM	40,00		52,00	8,00	11,00	DIS		Mercedes	Distributore superiore, (NERO)

CRE	Cremagliera	Rack	Гидроцилиндр
DIS	Distributore	Pignon	Распределитель
PIS	Pistone	Piston	Поршень
POM	Pompa	Pump	Насос
SCA	Scatola	Box	Корпус редуктора

Codice Code Код	Min Ord Мин. коли- чество заказа	Dis. Drawing Тип сальника	d1	d2	D	h1	H	Uso Use in Приме- нение	Marca Brand Произво- дитель агрегата	Tipo auto Vehicle type Тип авто	Note Remarks Примечания
			Размеры								
● CT24851	2	1PM	47,00		59,00	8,00	10,50	DIS		Mercedes LS3	
F-00471	2	1PM	50,00		70,00		10,00	DIS		Veicoli pesanti	
● F-00987	2	1PM	52,00		65,00	9,00	11,00	DIS		Mercedes	Distributore superiore, (BLU)
F-00784	2	1PM	52,00		85,00	9,50	14,43				
● CT24867	2	1PM	54,00		72,00		10,00			Mercedes	Paraolio motore righe SX, rotazione DX
● CT24733	2	1PM	55,00		72,00	8,00	8,50	DIS		Mercedes	
● CT24734	2	1PM	55,00		72,00	8,00	8,50	DIS		Mercedes	Alte temperature
● CT24868	2	1PM	56,00		69,00		10,00			Mercedes	Paraolio motore righe DX, rotazione SX
F-00477	2	1PM	56,00		70,00	9,00	11,00	DIS		Mercedes LS7	distributore sup.
CT20599	2	1PM	57,10		70,00	5,00	6,00	DIS		TAS 75	
CT20609	2	1PM	57,10		70,00	5,00	6,00	DIS	TRW	TAS 75	
● CT24908	2	1PA	57,10		70,00	6,00	6,00	DIS		TAS 80	TAS 80
CT20600	2	1P	57,10		74,50	3,90	5,00	DIS		TAS 75	

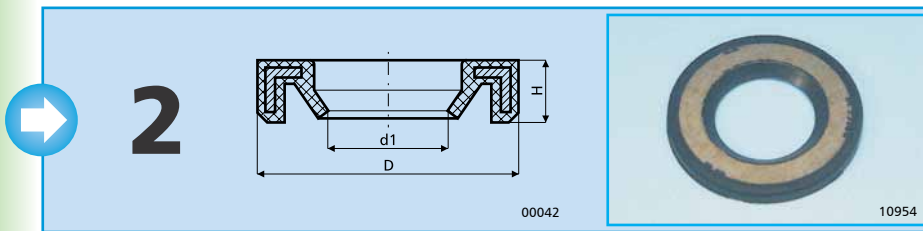

Codice Code Код	Min Ord Мин. коли- чество заказа	Dis. Drawing Тип сальника	d1	d2	D	h1	H	Uso Use in Приме- нение	Marca Brand Произво- дитель агрегата	Tipo auto Vehicle type Тип авто	Note Remarks Примечания
			Размеры								
F-00384	2	2	19,00		25,50		3,00	DIS			
● F-00384M	2	2	19,00		25,50		3,30	DIS			
F-00188	2	2	19,00		35,00		3,00	DIS		Peugeot 205 U.T.	parapolvere
F-00429	2	2	20,00		26,00		3,00	DIS	ZF		
● F-00807A	2	2	22,00		33,80		4,00	CRE		Hyundai Atos-	raschiatore Ø22 da abbinare al paraolio F-00807
F-00656	2	2	22,17		28,54		3,20	DIS	TRW		
F-00392	2	2	24,50		31,00		4,50	DIS	TRW	Ford	distributore inf.
F-00010	2	2	25,00		35,00		5,50	DIS	TRW	Fiat 131	
F-00697A	2	2	27,70		38,30		4,00	CRE		Hyundai Sonata	raschiatore Ø27,7 da abbinare al paraolio F-00697 -F- 00798
● F-00899A	2	2	27,70		40,00		3,80	CRE		Hyundai Sonata	raschiatore Ø27,7 da abbinare al paraolio F-00899
● CT23454	2	2	27,70		42,00		4,00	CRE			Raschiatore
F-00207	2	2	32,00		40,00		5,00	CRE		Toyota Land Cruiser	
F-00176	2	2	32,00		40,00		7,00	DIS		Isuzu, Trooper	
F-00715	2	2	38,00		51,00		5,00	DIS		Land Rover	
F-00722	2	2	38,00		51,00		5,00	DIS		Land Rover U.T. UK	originale/genuine

Gli articoli identificati con l'iniziale «CT» (codice temporaneo) sono attualmente in fase di test e prossimi all'introduzione definitiva nel mercato.

Items whose code starts with «CT» (temporary code) are currently being tested and they are candidate to be introduced in the market soon.
Пункты, обозначенные аббревиатурой «СТ» (временный код), в данный момент проходят испытания и будут представлены на рынок в ближайшее время.

Codice Code Код	Min Ord Мин. коли- чество заказа	Dis. Drawing Тип сальника	d1	d2	D	h1	H	Uso Use in Приме- нение	Marca Brand Произво- дитель агрегата	Tipo auto Vehicle type Тип авто	Note Remarks Примечания
			Размеры								
F-00570	2	2	40,00		55,00		9,50	DIS		Bendix	
F-00571	2	2	45,00		60,00		10,00	DIS		Bendix	
F-00563	2	2G	45,00		60,50		6,30	DIS		Bendix, Transit	materiale speciale
F-00572	2	2	50,00		65,00		10,00	DIS		Bendix	
F-00573	2	2	55,00		70,00		12,30	DIS		Bendix	
CT20614	2	2	57,10		74,50		2,85		TRW	TAS 75	

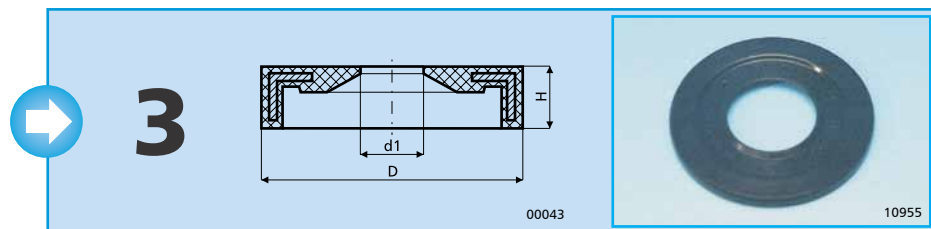

Codice Code Код	Min Ord Мин. коли- чество заказа	Dis. Drawing Тип сальника	d1	d2	D	h1	H	Uso Use in Приме- нение	Marca Brand Произво- дитель агрегата	Tipo auto Vehicle type Тип авто	Note Remarks Примечания
			Размеры								
F-00626	2	3G	14,00	45,00	48,00	8,20	13,00	DIS			parapolvere
F-00625	2	3G	14,00	50,00	53,00	10,00	10,00	DIS			parapolvere
F-00013	2	3	14,60		35,00		4,90	DIS	TRW		parapolvere
F-00042	2	3	14,60		35,00		4,90	DIS	TRW	Volvo	originale/genuine parapolvere
F-00299	2	3	15,00		41,50		5,70	DIS		Ford	parapolvere
F-00215	2	3	15,00		42,00		3,50	DIS			parapolvere
F-00848	2	3G	15,00		52,00		7,00			Renault Master	parapolvere
F-00472	2	3	16,00		24,00	2,50	3,50	DIS	TRW	HFB 70	parapolvere
F-00438	2	3G	16,00		46,00		9,00	DIS		Alfa 33,Alfa 75	parapolvere
F-00532	2	3G	16,50		55,00	7,50	9,00	DIS	ZF	Toyota Carina	parapolvere
F-00864	2	3	17,00		43,00		3,50	DIS			originale/genuine
F-00699	2	3A	18,00		35,70		3,90	DIS			parapolvere
F-00170	2	3A	18,00		42,00		4,00	DIS		Ford Mondeo, Fiesta	parapolvere
F-00557	2	3	18,50		43,00		4,50	DIS	TRW	VW Lupo,Skoda Octavia,eat Ibiza	parapolvere
F-00307	2	3A	19,00		26,50		4,00	DIS		Subaru	
F-00382	2	3	19,00		59,50		7,00	DIS		Jaguar	coperchio pignone
F-00370	2	3	19,05		35,00		3,40	DIS		F.Megane	parapolvere
F-00067	2	3	19,05		35,00		3,50	DIS		Peugeot 806, 205 ultimo tipo	parapolvere
F-00104	2	3	20,00		44,00		3,50	DIS	TRW	Mercedes Vito Sprinter	parapolvere
F-00191	2	3	20,00		44,00		4,50	DIS	TRW	VW Sharan	parapolvere
F-00645	2	3G	20,00		55,00	7,50	9,00	DIS		Bmw-Mini	parapolvere
CT22704	2	3G	22,00		45,50	1,30	4,50			HFB70 DAF, Scania	parapolvere
F-00995	2	3G	23,00		54,00		8,00			TAS 75	parapolvere
F-00956	2	3A	31,00		46,70		3,90	DIS		Ford	parapolvere
F-00577	2	3	32,00		45,00		3,70	DIS		Jeep	parapolvere
CT20947	2	3P	35,00		48,00	3,00	3,80			Jeep Wrangler	
F-00805	2	3	41,00		58,00		3,60	DIS		Ford	parapolvere
CT24903	2	3	57,13		74,57		3,60		TRW	TAS 80	TAS 80

CRE	Crema­glie­ra	Rack	Гидроцилиндр
DIS	Distributore	Pignon	Распределитель
PIS	Pistone	Piston	Поршень
POM	Pompa	Pump	Насос
SCA	Scatola	Box	Корпус редуктора

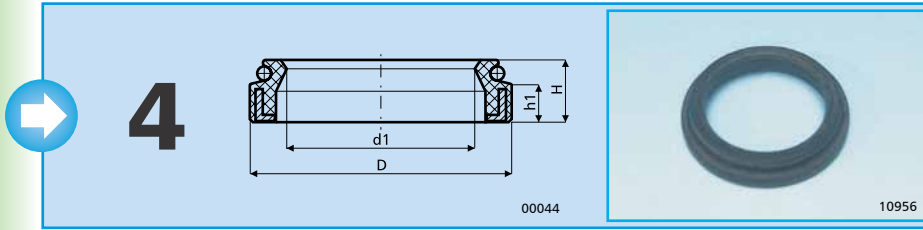

Codice Code Код	Min Ord Мин. количество заказа	Dis. Drawing Тип сальника	d1	d2	D	h1	H	Uso Use in Приме­нение	Marca Brand Произ­водитель агрегата	Tipo auto Vehicle type Тип авто	Note Remarks Примечания
			Размеры								
F-00043	2	4	11,00		35,00	5,00	9,00	DIS	TRW	Fiat Tipo	originale/genuine parapolvere
F-00044	2	4	13,00		35,00	4,40	6,50	DIS	TRW	Lancia Thema II Serie	originale/genuine parapolvere
F-00519	2	4PM	18,00		25,50	4,00	6,50	DIS		veicoli commerciali	
F-00982	2	4PM	18,00		25,50	6,50	7,00		ZF	veicoli commerciali	Genuin
F-00497X	2	4	21,50		34,50	8,00	13,00	CRE		Ford Fiesta ultimo tipo	minorato con PTFE
F-00708	2	4PM	22,00		32,00	5,20	8,00	DIS		Mercedes	
F-00497	2	4	22,00		34,50	7,00	12,00	CRE		Ford Fiesta ultimo tipo	con P.T.F.E. con o-ring di tenuta
F-00119	2	4	22,00		35,00	4,30	7,00	DIS	TRW		
F-00296	2	4	23,30		30,00	4,00	6,00	DIS	TRW	Ford	
F-00082	2	4	23,40		29,80	1,70	4,50	DIS	TRW	Volvo	originale/genuine
F-00082A	2	4	23,40		29,80	1,70	4,50	DIS	TRW	Volvo	
F-00086	2	4	23,40		30,00	4,00	6,70	DIS	TRW	Golf	viton
F-00130	2	4	23,40		30,00	4,00	6,70	DIS	TRW	Golf	originale/genuine viton-alte temperature
F-00077	2	4A	24,00		37,00	14,50	20,00	CRE		Renault, Espace	originale/genuine distributore inf.
F-00724	2	4	25,00		35,20	3,50	7,60	DIS			
F-00520	2	4PM	26,00		34,00	4,50	7,70	DIS	ZF	veicoli commerciali	
F-00854	2	4PM	26,00		34,00	6,70	7,70		ZF		originale/genuine
F-00339	2	4	26,00		35,00	4,00	8,00	DIS		Saab 900,9000	
F-00859	2	4	26,50		37,00	3,50	7,00	DIS	Saginaw	Opel Antara, costruzione Corea	
F-00101	2	4	27,00		37,00	3,50	7,00	DIS	Saginaw	Opel Vectra, Corsa	
F-00734	2	4A	27,70		39,60	13,50	17,20	CRE	Smi-Koyo	Peugeot 407	con PTFE interno
F-00710	2	4	28,50		38,00	3,50	8,00	DIS			
F-00091	2	4	31,75		38,10	3,00	5,00	DIS	TRW	Rover 820	
F-00092	2	4A	34,00		47,00	5,00	12,00	DIS	TRW	Rover 820	

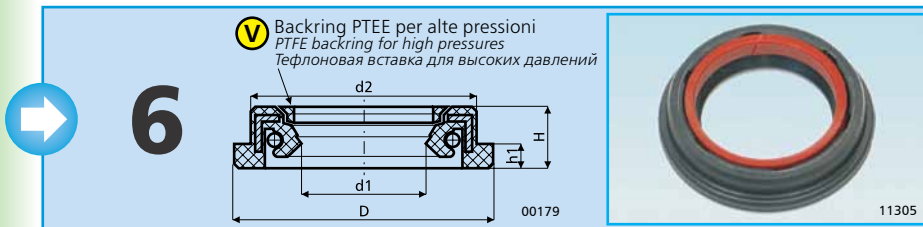

Codice Code Код	Min Ord Мин. количество заказа	Dis. Drawing Тип сальника	d1	d2	D	h1	H	Uso Use in Приме­нение	Marca Brand Произ­водитель агрегата	Tipo auto Vehicle type Тип авто	Note Remarks Примечания
			Размеры								
F-00523	2	6V3	14,00	30,50	38,40	5,00	11,00	CRE		Chrysler 300 M	
F-00125	2	6V3	22,00		31,50	4,70	7,80	CRE	Saginaw		

INFORMAZIONE TIP РЕКОМЕНДАЦИИ

I paraoli minorati sono identificati con la lettera finale «X»
Esempio F-00024: dimensioni normali - F-00024X: minorato
Reduced seals are identified with final letter «X»
Example F-00024: regular sizes - F-00024X: reduced seal
Сальники, обозначенные буквой «X», являются аналогами стандартных сальников с уменьшенным внутренним диаметром
Например: F-00024 - стандартный F-00024X - с уменьшенным внутренним диаметром



Codice Code Код	Min Ord Мин. коли- чество заказа	Dis. Drawing Тип сальника	d1	d2	D	h1	H	Uso Use in Приме- нение	Marca Brand Произво- дитель агрегата	Tipo auto Vehicle type Тип авто	Note Remarks Примечания
F-00284	2	6V2	22,00		32,00	4,00	6,00	CRE		Opel Corsa	
• CT22605	2	6V1	22,50	34,30	38,00	3,20	8,00	CRE		VW Golf	Paraolio cremagliera Vw Golf (minorato)
F-00739	2	6V1	23,00		32,50	5,50	7,50	CRE	TRW	Skoda, VW Polo U.T.	
F-00440	2	6V2	23,00		32,90	6,00	8,00	CRE	TRW	Skoda, VW Polo- UT	
F-00018	2	6V2	23,00	34,20	38,00	3,20	8,00	CRE	TRW	Fiat Tipo, Regata, Golf	standard
F-00035	2	6V2	23,00	34,20	38,00	3,20	8,00	CRE	TRW	Fiat Tipo, Regata, Golf	originale/genuine
F-00441	2	6V2	23,00	34,30	38,00	3,20	8,00	CRE	TRW	VW Golf	originale/genuine America
F-00642	2	6V2	23,00	34,30	38,20	5,00	8,20	CRE		Mazda	
F-00016	2	6V2	23,00	34,50	40,00	3,20	7,50	CRE	TRW	Fiat Tipo I. Serie	
F-00034	2	6V2	23,00	34,20	40,00	3,20	7,50	CRE	TRW	Fiat Tipo I serie	originale/genuine
F-00601	2	6V2MA	24,00	36,00	37,00	8,50	17,70	CRE		Peugeot 206	
F-00738	2	6V2	24,00	35,20	39,00	9,00	13,90	CRE		VW PQ35	originale/genuine
• F-00467X	2	6V1	24,50	37,80	41,80	3,30	7,50	CRE		Ford Mondeo – Fiesta (ultimo tipo)	
F-00015	2	6V2	24,97	37,80	41,30	3,20	7,40	CRE	TRW	Fiat Croma - Thema	standard
F-00764	2	6V2	24,97	37,80	41,30	3,00	7,40	CRE	TRW	Fiat Croma-Thema	originale/genuine
• F-00911	2	6V2	24,97	37,80	41,30	3,30	7,50	CRE	TRW	Dodge, Jeep 2007-'08	originale/genuine
F-00135	2	6V2	25,00		35,00	3,20	6,50	CRE	Saginaw	Vectra-Fiat Fiorino-Bravo-Brava	
F-00406	2	6V2	25,00		35,20	3,70	6,50	CRE	Saginaw	Fiat Fiorino-Opel Vectra	
F-00613	2	6V2	25,00	33,00	37,50	6,00	7,00	CRE		Renault	originale/genuine replacement
F-00072	2	6V3	25,00	33,00	37,50	6,70	8,00	CRE		Renault	originale/genuine
F-00137	2	6V2	25,00	34,60	38,00	4,30	7,60	CRE	TRW		
F-00498	2	6V2	25,00	35,00	38,50	4,30	8,00	CRE	TRW	Porsche Boxter	
F-00107	2	6V3	25,00	35,00	40,00	1,70	10,00	CRE		Renault Megane, Traffic	originale/genuine
F-00485	2	6V2	25,00	37,80	41,24	4,40	7,30	CRE	TRW	Volvo ultimo tipo mondeo 2003	
• CT24058	2	6V1	25,00	37,70	41,24	5,80	10,00	CRE		Chrysler 2007, Sebring 2008	originale/genuine
F-00369	2	6V2	25,00	37,80	41,50	3,30	7,50	CRE	TRW	Mondeo, Fiesta (I serie)	originale/genuine
F-00023	2	6V2	25,00	37,80	41,60	3,40	7,70	CRE	TRW	Lancia Thema, Fiat Croma, Volvo	originale/genuine alta temperatura
F-00467	2	6V2	25,00	37,80	41,80	3,30	7,50	CRE		Ford Mondeo – Fiesta (ultimo tipo)	originale/genuine
F-00604	2	6V2	25,00	38,60	44,70		12,40	CRE			
F-00488	2	6V2	25,00	38,70	45,00	6,00	10,00	CRE	TRW	Chrysler Voyager	
F-00535	2	6V2	26,00	38,00	40,00	8,50	17,70	CRE		Citroen C5	
F-00691	2	6V2	28,00		37,70	5,50	8,00	CRE	TRW	Ferrari	
• F-00943	2	6V2	28,00		40,00	4,00	6,00	CRE		Mitsubishi Diamante	Mitsubishi Diamante
F-00706	2	6V3	28,00	43,00	47,70	5,00	11,70	CRE		Nissan Quest, Mercury Villager 93-94	
F-00727	2	6V2	30,00		40,00	4,00	6,50	CRE			
F-00486	2	6V2	30,00	42,50	49,00	3,40	10,90	CRE	TRW	Ducato, Daily	maggiorato
F-00021	2	6V2	30,00	42,50	49,20	3,40	10,90	CRE	TRW	Ducato, Iveco, Daily	originale/genuine
F-00029	2	6V2	30,00	42,50	49,20	3,40	10,90	CRE	TRW	Iveco, Ducato, Daily	standard
F-00762	2	6V2	30,00	42,50	49,50	3,40	10,90	CRE	TRW	Ducato, Iveco, Daily	originale/genuine alte temperature
F-00290	2	6V2	31,00	43,70	48,00	4,00	8,30	CRE		Ford Explorer	

CRE	Cremagliera	Rack	Гидроцилиндр
DIS	Distributore	Pignon	Распределитель
PIS	Pistone	Piston	Поршень
POM	Pompa	Pump	Насос
SCA	Scatola	Box	Корпус редуктора

Codice Code Код	Min Ord Мин. колич- ество заказа	Dis. Drawing Тип сальника	d1	d2	D	h1	H	Uso Use in Приме- нение	Marca Brand Произво- дитель агрегата	Tipo auto Vehicle type Тип авто	Note Remarks Примечания
			Размеры								
CT25192	2	6	31,00		51,60	6,60	11,00	CRE			
F-00802	2	6V2	32,00	38,00	42,00	4,00	6,30	CRE		Chevy	
F-00678	2	6V2	32,00	44,10	46,80	12,90	18,70	CRE		Land Rover L30-MK3	

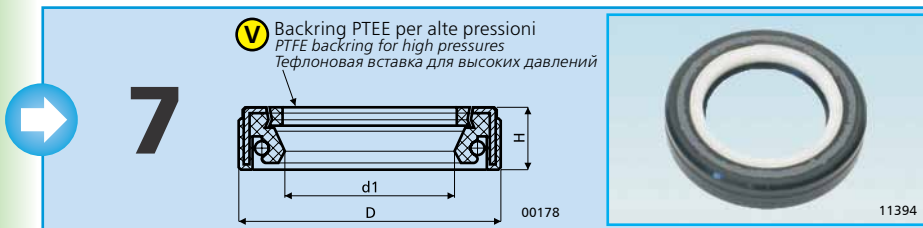

Codice Code Код	Min Ord Мин. колич- ество заказа	Dis. Drawing Тип сальника	d1	d2	D	h1	H	Uso Use in Приме- нение	Marca Brand Произво- дитель агрегата	Tipo auto Vehicle type Тип авто	Note Remarks Примечания
			Размеры								
F-00102	2	7V1PM	12,00		27,00		10,00	CRE	Saginaw	Opel	con PTFE interno
F-00178	2	7V1PM	12,00		27,00	9,00	10,00	CRE	Saginaw	Opel Calibra	
F-00726	2	7V2	12,00		38,20		10,00	CRE			
F-00372	2	7V1PM	14,00		27,00	9,00	10,00	CRE	Saginaw	Opel Vectra B, GM	alte temperature (con PTFE interno)
F-00217	2	7V2	20,00		32,10		8,50	CRE		Isuzu	
F-00216	2	7V2	20,00		34,20		9,00	CRE		Honda	con interno in P.A.
F-00218	2	7V2G	21,00		29,50		6,00	CRE		Honda	P.A.
F-00328	2	7V2G	21,00		30,00		5,00	CRE		Honda	
F-00330	2	7V2G	21,00		30,00		5,00	CRE		Subaru Justy	
F-00547	2	7V2	21,00		34,00		9,00	CRE		Honda	con interno PTFE
F-00327	2	7V2G	21,10		29,50		6,00	CRE		Ford Fiesta ultimo tipo,Fusion	minorato
F-00494X	2	7V1	21,50		35,50		7,50	CRE		Toyota	
F-00098	2	7V2	22,00		32,10		7,00	CRE	Smi-Koyo	Toyota	
F-00280	2	7V2	22,00		34,00		8,50	CRE		Daihatsu	
F-00796	2	7V1	22,00		34,20		8,00	CRE		Suzuki Swift	
F-00381	2	7V2	22,00		35,00		8,00	CRE		Hyundai Atos 2001	
F-00806	2	7V1PM	22,00		35,00	9,00	10,00	CRE	Mando	Hyundai Atos 2001	originale/genuine
F-00948	2	7V1PM	22,00		35,10	9,00	10,00	CRE	Mando	Toyota	con PTFE esterno
F-00219	2	7V2	22,00		35,20		8,50	CRE		Toyota Yaris	con PTFE interno
F-00670	2	7V1	22,00		35,30		8,60	CRE		Opel Corsa	
F-00283	2	7V3	22,00		35,30	10,00	15,50	CRE		Ford Fiesta ultimo tipo,Fusion	
F-00494	2	7V2	22,00		35,50		7,90	CRE		Toyota	
F-00220	2	7V2	22,00		36,60		8,00	CRE		Toyota Yaris	
F-00512	2	7V1	22,00		38,20		8,00	CRE		Hyundai Atos 2001	
F-00807	2	7V1PM	22,00		38,20	13,00	14,00	CRE	Mando	Hyundai Atos 2001	originale/genuine
F-00949	2	7V1PM	22,00		38,20	13,00	14,00	CRE	Mando	Toyota Tercel	
F-00222	2	7V2	22,00		38,30		8,00	CRE		Nissan	
F-00221	2	7V2	22,00		38,40		8,00	CRE		Daihatsu	
F-00797	2	7V1	22,00		38,40		8,00	CRE		Toyota Yaris	con PTFE interno
F-00672	2	7V1	22,00		38,40		8,60	CRE		Toyota Yaris	
F-00513	2	7V1A	22,00		38,50		8,00	CRE		Toyota Yaris	
F-00123	2	7V3	22,00		39,40	10,00	12,60	CRE	Saginaw		

ATTENZIONE! WARNING! ВНИМАНИЕ!

Gli articoli identificati con l'iniziale «CT» (codice temporaneo) sono attualmente in fase di test e prossimi all'introduzione definitiva nel mercato.

*Items whose code starts with «CT» (temporary code) are currently being tested and they are candidate to be introduced in the market soon.
Пункты, обозначенные аббревиатурой «СТ» (временный код), в данный момент проходят испытания и будут представлены на рынок в ближайшее время.*



Codice Code Код	Min Ord Мин. коли- чество заказа	Dis. Drawing Тип сальника	d1	d2	D	h1	H	Uso Use in Приме- нение	Marca Brand Произво- дитель агрегата	Tipo auto Vehicle type Тип авто	Note Remarks Примечания
			Размеры								
● F-00024X	2	7V1	22,50		34,50		7,00	CRE		Fiat Tipo, Regata, VW Golf	minorato
● F-00901	2	7V2	22,80		33,50		6,00	CRE	TRW	Kirby	
● F-00936	2	7V2	23,00		33,50		6,00	CRE		Ford	
F-00012	2	7V2	23,00		34,40		6,35	CRE	TRW	Fiat Tipo, Regata, Golf	
F-00024	2	7V2	23,00		34,50		6,50	CRE	TRW	Fiat Tipo, Regata, Golf	originale/genuine
F-00396	2	7V2	23,00		34,55		6,50	CRE	TRW	Golf, Ford, VW	originale/genuine America
● CT23278	2	7V2	23,00		34,60		6,35	CRE		Golf Brasile	originale/genuine
F-00223	2	7V2	23,00		37,20		9,00	CRE		Subaru, Isuzu	
F-00499	2	7V2	23,00		38,20		8,00	CRE		Mazda MX5	
F-00402	2	7V2	23,00		38,20		9,00	CRE		Suzuki Baleno, Mazda MX5	
F-00224	2	7V2	23,00		40,20		9,00	CRE		Subaru	
F-00292	2	7V2	23,00		41,20		8,00	CRE		Mazda	
● F-00926	2	7V1	23,00		41,20		8,50	CRE		Subaru Forester	
F-00225	2	7V2	23,00		41,20		9,00	CRE		Subaru	
F-00079	2	7V2	23,00		48,60		7,50	CRE		Nevada, Renault	originale/genuine
F-00763	2	7V2	23,50		33,60		6,00	CRE			
● F-00933	2	7V2	23,50		37,00		8,50	DIS			
● F-00121X	2	7V1	23,50		37,20		8,50	CRE		A3, Octavia VW PSA	minorato
● F-00397X	2	7V1	23,50		39,00	8,50	16,50	CRE	ZF	Golf, Octavia, Scoda Felicia	
● F-00090X	2	7V1	23,50		39,20		8,50	CRE		Opel Vectra, Renault, VW	minorato
● F-00474X	2	7V1	23,50		39,20		8,50	CRE		Opel Vectra, Renault, VW	minorato
F-00285	2	7V2G	24,00		34,00		6,00	CRE		Honda	
F-00236	2	7V2	24,00		34,10		7,00	CRE		Nissan	
F-00783	2	7V1	24,00		35,10		8,50	CRE		Seat Ibiza Polo Lupo Felicia SMI	originale/genuine
F-00651	2	7V1	24,00		35,20		8,50	CRE		Seat Ibiza Polo Lupo Felicia SMI	
F-00831	2	7V1	24,00		35,20		8,50	CRE		Mitsubishi	originale/genuine
F-00239	2	7V1	24,00		35,30		12,00	CRE		Mitsubishi	
F-00198	2	7V2	24,00		36,00		7,00	CRE		Nissan	
F-00476	2	7V2A	24,00		36,00		17,70	CRE		Peugeot 206	
F-00237	2	7V2	24,00		36,30		8,00	CRE		Toyota	
● CT23280	2	7V2	24,00		36,50		7,50	CRE		Renault Clio II	originale/genuine
F-00360	2	7V1	24,00		36,50		7,50	CRE		Peugeot, Renault	originale/genuine
F-00966	2	7V1PM	24,00		36,50	9,00	10,00	CRE		Hyundai Jeez/Accent 2000-05	
F-00287	2	7V2	24,00		36,50		12,00	CRE		Mitsubishi	
F-00226	2	7V2	24,00		36,60		8,50	CRE		Mitsubishi, Renault, Hyundai	originale/genuine
F-00833	2	7V1	24,00		36,60		8,50	CRE		Hyundai	
F-00095	2	7V2	24,00		37,10		8,00	CRE	Smi-Koyo	Renault Laguna Safrane, VW	
F-00830	2	7V1	24,00		37,10		8,50	CRE		Seat Ibiza Polo Lupo Felicia SMI	originale/genuine
F-00705	2	7V2	24,00		37,10		15,00	CRE	ZF		con P.T.F.E.

CRE	Cremagliera	Rack	Гидроцилиндр
DIS	Distributore	Pignon	Распределитель
PIS	Pistone	Piston	Поршень
POM	Pompa	Pump	Насос
SCA	Scatola	Box	Корпус редуктора

Codice Code Код	Min Ord Мин. коли- чество заказа	Dis. Drawing Тип сальника	d1	d2	D	h1	H	Uso Use in Приме- нение	Marca Brand Произво- дитель агрегата	Tipo auto Vehicle type Тип авто	Note Remarks Примечания
F-00445	2	7V3	24,00		37,10	15,00	17,00	CRE		Saab 9-5	con segmento P.T.F.E. esterno
F-00121	2	7V2	24,00		37,20		8,50	CRE	ZF	A3, Octavia VW PSA	
F-00652	2	7V1	24,00		37,20		8,50	CRE		Seat Ibiza Polo Lupo Felicia SMI	
F-00227	2	7V2	24,00		37,60		8,50	CRE		Subaru	originale/genuin
F-00612	2	7V1	24,00		38,00		8,00	CRE		Honda CRV	
F-00829	2	7V1	24,00		38,10		7,00	CRE		Saab 9.3	originale/genuine
F-00716	2	7V1	24,00		38,20		7,00	CRE		Saab 9.35	
F-00543	2	7V1	24,00		38,20		8,50	CRE		Toyota Corolla	
F-00238	2	7V1	24,00		38,20		12,50	CRE		Mitsubishi, Volvo V4-V70	
F-00229	2	7V2	24,00		38,30		8,50	CRE		Toyota	
• CT23056	2	7V1PM	24,00		38,50	9,00	10,00	CRE	Mando	Hyundai Matrix, Jazz	
F-00397	2	7V2	24,00		39,00	8,50	16,50	CRE	ZF	Golf, Octavia, Skoda Felicia	
F-00474	2	7V1	24,00		39,10		8,50	CRE		Bmw - Mini	con back ring interno
F-00090	2	7V2	24,00		39,20		8,50	CRE	ZF	Opel Vectra, Renault VW	con back ring esterno
F-00717	2	7V2	24,00		39,50		7,00	CRE		Saab 9,35	
F-00228	2	7V1	24,00		40,00		7,00	CRE		Nissan	
F-00240	2	7V1	24,00		40,00		8,50	CRE		Nissan	
F-00668	2	7V1	24,00		40,10		9,50	CRE		Honda Civic	
F-00230	2	7V2	24,00		40,20		8,00	CRE		Toyota	
• F-00983	2	7V1	24,00		40,20		8,00	CRE		Toyota	
F-00231	2	7V1	24,00		41,00		8,50	CRE		Toyota Corolla	
F-00291	2	7V1	24,00		41,00		12,50	CRE		Mitsubishi	
F-00515	2	7V2	24,00		41,10		8,50	CRE	ZF	Jaguar X TYPE	
• F-00878	2	7V2	24,00		41,20		8,50	CRE		Toyota Corolla	
• F-00917	2	7V1	24,00		41,20		8,50	CRE		Opel Astra H	
F-00407	2	7V1	24,00		42,00		8,00	CRE	Saginaw	Honda	
F-00426	2	7V1	24,00		42,00		8,00	CRE		Honda	
F-00233	2	7V2	24,00		42,00		9,00	CRE		Toyota	
F-00232	2	7V2	24,00		42,10		8,50	CRE		Mitsubishi	
F-00965	2	7V1PM	24,00		42,50	9,00	10,00	CRE		Hyundai Jeez/Accent 2000-05	
F-00171	2	7V1	24,00		42,50		13,00	CRE		Hyundai, Lantra	
F-00818	2	7V1	24,00		42,60		8,50	CRE	TRW	Honda Accord V6 2003,05	
F-00599	2	7V1	24,00		43,00		8,50	CRE		Nissan	
F-00234	2	7V2	24,00		43,10		7,00	CRE		Nissan	
• F-00919	2	7V2	24,00		44,00	1,60	20,50	CRE	ZF	Audi Q5/ B8/ A6	
F-00712	2	7V1	24,00		44,30		9,50	CRE			
F-00235	2	7V2	24,00		45,00		7,00	CRE		Nissan	
• F-00941	2	7V1	24,00		50,00		9,00	CRE		Nissan Murano	originale/genuin
• F-00038X	2	7V1	24,50		37,54		6,50	CRE	TRW	Thema, Croma, Mondeo, Fiesta, Chrysler, Nissan, Mazda	minorato
F-00014	2	7V2	24,97		37,54		6,35	CRE	TRW	Fiat Croma - Thema	standard

INFORMAZIONE TIP РЕКОМЕНДАЦИИ

I paraoli minorati sono identificati con la lettera finale «X»
Esempio F-00024: dimensioni normali - F-00024X: minorato
Reduced seals are identified with final letter «X»
Example F-00024: regular sizes - F-00024X: reduced seal
Сальники, обозначенные буквой «X», являются аналогами стандартных сальников с уменьшенным внутренним диаметром
Например: F-00024 - стандартный F-00024X - с уменьшенным внутренним диаметром



Codice Code Код	Min Ord Мин. коли- чество заказа	Dis. Drawing Тип сальника	d1	d2	D	h1	H	Uso Use in Приме- нение	Marca Brand Произво- дитель агрегата	Tipo auto Vehicle type Тип авто	Note Remarks Примечания
F-00038	2	7V2	24,97		37,54		6,35	CRE	TRW	Thema, Croma, Mondeo, Fiesta, Chrysler, Nissan, Mazda	originale/genuine
F-00324	2	7V3G	25,00		32,00	3,70	5,50	CRE		Lotus	P.T.F.E. + paraolio
F-00294	2	7V3G	25,00		33,00	5,00	5,50	CRE		Subaru	
F-00245	2	7V2	25,00		35,00		8,00	CRE		Nissan	
● F-00245M	2	7V1	25,00		35,00		8,00	CRE		Nissan	
F-00423	2	7V2	25,00		36,00		8,50	CRE		Mercedes	
F-00071	2	7V2	25,00		37,00		7,00	CRE		Renault	originale/genuine
F-00713	2	7V2	25,00		37,10		9,00	CRE			
F-00093	2	7V2	25,00		37,20		8,50	CRE	Smi-Koyo	Renault Laguna Safrane	
F-00243	2	7V2	25,00		37,50		7,00	CRE		Ford Mazda	
F-00844	2	7V1	25,00		37,70		8,00	CRE		Kia	originale/genuine
F-00653	2	7V2	25,00		37,90		6,50	CRE	TRW	Fiat Doblo	
F-00448	2	7V2	25,00		38,00		6,30	CRE	TRW	Rover 75	
F-00281	2	7V2	25,00		38,00		8,50	CRE		Volvo	
F-00244	2	7V2	25,00		38,00		9,00	CRE		Nissan	
F-00126	2	7V3	25,00		38,00	10,00	12,50	CRE		Saab 900	
F-00070	2	7V2	25,00		38,20		7,20	CRE		Renault	originale/genuine
F-00527	2	7V1	25,00		38,50		10,00	CRE		Chrysler neon	
F-00129	2	7V3	25,00		39,30	10,00	12,70	CRE		Opel Vectra I serie, Saab 9000	
F-00246	2	7V3	25,00		39,50	10,00	12,50	CRE		Fiorino, Vectra 96	
F-00658	2	7V3	25,00		39,50	10,00	12,50	CRE	Saginaw	Fiat Fiorino, Opel Vectra "96.	alte temperature
F-00094	2	7V2	25,00		39,60		8,50	CRE	Smi-Koyo	Renault Laguna Safrane	
● F-00935	2	7V1	25,00		40,00		9,00	CRE		Nissan Almera Classic 2006	Cremagliera Nissan Almera Classic
F-00106	2	7V2	25,00		40,20		7,20	CRE		Megane, Traffic	originale/genuine
F-00288	2	7V2	25,00		41,00		8,50	CRE		Volvo	
F-00669	2	7V1	25,00		41,10		9,50	CRE		Mazda 6	con labbro parapolvere
F-00534	2	7V2	25,00		41,50		7,50	CRE	TRW	Ford Mondeo ultimo tipo, Focus, Mazda	
F-00411	2	7V2	25,00		42,00		8,00	CRE			
F-00120	2	7V3	25,00		42,50	10,00	12,50	CRE	Saginaw	Opel Vectra	
F-00661	2	7V3	25,00		42,60	10,00	12,50	CRE	Saginaw	Opel Vectra	
F-00293	2	7V2	25,00		43,00		7,50	CRE		Mazda	
F-00518	2	7V2	25,00		43,00		8,00	CRE		Suzuki Gran Vitara	
● CT22720	2	7V1	25,00		43,00		9,00	CRE			
F-00241	2	7V2	25,00		43,00		9,00	CRE		Ford Mazda	
F-00846	2	7V2	25,00		43,00		10,00	CRE		Chevrolet Malibu, Pontiac, Saturn	
F-00845	2	7V3	25,00		43,10	10,00	12,60	CRE		Chevrolet Malibu, Pontiac, Saturn	
● CT23446	2	7V2	25,00		43,20		9,00	CRE			originale/genuine
F-00714	2	7V1	25,00		43,20		9,00	CRE			
F-00377	2	7V1	25,00		44,00		9,00	CRE		Nissan Skiline	
F-00824	2	7V2	25,00		44,70		8,40	CRE		Lincoln	
F-00808	2	7V1PM	25,00		45,10	10,00	11,50	CRE		Dodge Caravan	
F-00860	2	7V1PM	25,00		45,10	10,00	11,50	CRE		Dodge Caravan	

CRE	Cremagliera	Rack	Гидроцилиндр
DIS	Distributore	Pignon	Распределитель
PIS	Pistone	Piston	Поршень
POM	Pompa	Pump	Насос
SCA	Scatola	Box	Корпус редуктора

Codice Code Код	Min Ord Мин. колич- ество заказа	Dis. Drawing Тип сальника	d1	d2	D	h1	H	Uso Use in Приме- нение	Marca Brand Произво- дитель агрегата	Tipo auto Vehicle type Тип авто	Note Remarks Примечания
			Размеры								
F-00282	2	7V2	25,00		45,20		8,00	CRE		Nissan	
F-00242	2	7V2	25,00		48,20		10,00	CRE		Ford Mazda	
F-00248	2	7V2	25,50		37,70		8,00	CRE		Toyota	
F-00251	2	7V2	25,50		38,70		8,50	CRE		Toyota	
F-00399	2	7V2	25,50		38,80		8,00	CRE		Toyota Land Cruiser	
F-00249	2	7V2	25,50		39,20		8,00	CRE			
F-00252	2	7V2	25,50		39,30		8,50	CRE		Toyota	
F-00524	2	7V1	25,50		39,50		8,50	CRE		Toyota Celica 1999	
F-00250	2	7V2	25,50		39,90		8,00	CRE		Toyota	
F-00379	2	7V1	25,50		41,00		10,00	CRE		Toyota Celica	
F-00253	2	7V2	25,50		41,30		8,00	CRE		Toyota	
F-00254	2	7V2	25,50		42,10		9,00	CRE		Toyota	
F-00255	2	7V2	25,50		42,70		8,00	CRE		Toyota	
F-00475X	2	7V1	25,50		43,00		8,50	CRE		Alfa 159	minorato
F-00247	2	7V2	25,50		44,20		8,50	CRE		Toyota Camry	
F-00514	2	7V1	25,70		41,50		8,70	CRE		Toyota Celica 1999	
F-00256	2	7V2G	26,00		35,00		6,00	CRE		Honda	
F-00373	2	7V2	26,00		38,00		12,00	CRE		Mitsubishi	
F-00541	2	7V2	26,00		38,10		8,00	CRE		Mercedes classe C"	
F-00261	2	7V2	26,00		38,10		8,50	CRE		Mitsubishi	
F-00923	2	7V1	26,00		38,10		8,50	CRE		Mitsubishi Galant	
F-00812	2	7V1PM	26,00		38,10	9,00	10,00	CRE	Mando	Hyundai Elantra, Lantra	
F-00371	2	7V2	26,00		38,20		8,60	CRE	ZF	Peugeot 406	
F-00545	2	7V2	26,00		38,30		8,50	CRE		Honda	
F-00694	2	7V1A	26,00		39,80		8,40	CRE		Celica	originale/genuine
F-00380	2	7V2	26,00		40,00		8,50	CRE		Renault Safrane	
F-00262	2	7V2	26,00		41,10		8,50	CRE		Mitsubishi	
F-00592	2	7V1	26,00		41,20		8,50	CRE		Geo Tracker	
F-00258	2	7V2	26,00		41,20		12,50	CRE		Mitsubishi	
F-00583	2	7V1A	26,00		41,40		8,50	CRE		Lexus	
F-00695	2	7V1	26,00		41,80		8,50	CRE		Celica	
F-00934	2	7V1	26,00		42,00		8,00	CRE		Subaru Legacy	
F-00401	2	7V1	26,00		42,50		8,50	CRE		Mitsubishi	
F-00447	2	7V1	26,00		42,70		8,00	CRE		Lexus	
F-00952	2	7V1	26,00		43,00		8,00	CRE		Nissan	
CT20953	2	7V2	26,00		43,00		8,50	CRE	ZF	Alfa 159	Cremagliera ZF
F-00475	2	7V1	26,00		43,00		8,50	CRE		Nissan	
F-00257	2	7V2	26,00		43,00		12,50	CRE		Mitsubishi	
F-00542	2	7V2	26,00		43,10		8,00	CRE		Mercedes classe "C"	
F-00813	2	7V1PM	26,00		44,10	9,00	10,00	CRE	Mando	Hyundai Elantra, Lantra	
F-00994	2	7V2	26,00		44,10		10,00	CRE			
F-00501	2	7V1	26,00		44,20		8,60	CRE		Mitsubishi Galant	
F-00544	2	7V1	26,00		44,30		8,50	CRE		Honda	
F-00376	2	7V1	26,00		45,00		8,50	CRE		Nissan Skiline	
F-00259	2	7V2	26,00		45,10		7,00	CRE		Nissan	
F-00832	2	7V1	26,00		45,10		8,50	CRE		Nissan	originale/genuine
F-00780	2	7V1	26,00		45,50		8,50	CRE		Mercedes	
F-00400	2	7V1	26,00		46,00		8,00	CRE		Honda Prelude	
CT22527	2	7V2	26,00		46,00		8,50	CRE		Fiat Scudo 2007	Fiat Scudo 2007
F-00881	2	7V1	26,00		46,00		8,50	CRE		Fiat Scudo U.T.	

ATTENZIONE! WARNING! ВНИМАНИЕ!

Gli articoli identificati con l'iniziale «CT» (codice temporaneo) sono attualmente in fase di test e prossimi all'introduzione definitiva nel mercato.

*Items whose code starts with «CT» (temporary code) are currently being tested and they are candidate to be introduced in the market soon.
Пункты, обозначенные аббревиатурой «СТ» (временный код), в данный момент проходят испытания и будут представлены на рынок в ближайшее время.*



Codice Code Код	Min Ord Мин. коли- чество заказа	Dis. Drawing Тип сальника	d1	d2	D	h1	H	Uso Use in Приме- нение	Marca Brand Произво- дитель агрегата	Tipo auto Vehicle type Тип авто	Note Remarks Примечания
			Размеры								
● F-00930	2	7V1	26,00		47,00		8,50	CRE		Nissan Serena,N. Murano 3.6 v6 2005	
● F-00990	2	7V1	26,00		47,10		8,60	CRE		Nissan Serena,N. Murano 3.6 v6 2005	Genuin
● CT23448	2	7V1	26,00		48,20		9,50	CRE			
● F-00826	2	7V1	26,00		50,00		8,50	CRE		Nissan Murano	
● F-00260	2	7V2	26,50		41,40		8,50	CRE		Toyota	
● F-00264	2	7V2	26,50		44,10		8,50	CRE		Toyota	
● F-00263	2	7V2	26,50		44,20		8,00	CRE		Toyota Lexus IS 300	
● F-00683	2	7V1	26,70		44,20		8,00	CRE		Toyota Lexus IS 300	
● F-00922	2	7V1	26,70		44,20		8,50	CRE		Lexus	
● F-00839	2	7V2	27,00		40,10		6,80	CRE		Chevrolet	originale/genuine
● F-00821	2	7V1	27,00		40,20		8,50	CRE		Toyota Camry	
● F-00265	2	7V1	27,00		41,20		8,50	CRE		Toyota	
● F-00877	2	7V2	27,00		41,20		8,50	CRE		Toyota	
● F-00266	2	7V1	27,00		43,20		8,50	CRE		Toyota	
● F-00267	2	7V1	27,00		44,20		8,50	CRE		Toyota	
● F-00838	2	7V3	27,00		45,50	10,00	12,70	CRE		Chevrolet	originale/genuine
● F-00986	2	7V1	27,00		46,00		8,00	CRE		Opel Antara	originale/genuine
● F-00671	2	7V1	27,00		46,10		9,50	CRE		Mazda Premacy	con labbro parapolvere
● F-00825	2	7V1	27,00		46,20		8,50	CRE		Toyota Highlander	
● F-00931	2	7V1	27,00		47,00		9,00	CRE		Nissan Avensis	Cremagliera Nissan Avensis
● F-00684	2	7V2A	27,20		41,40		7,80	CRE		Sheppard	per albero Ø27
● F-00765	2	7V1	27,70		38,00		7,50	CRE		Renault	originale/genuine alte temperature
● F-00133	2	7V1	27,70		38,10		8,50	CRE	Smi-Koyo	Audi A4,A6	
● F-00128	2	7V1	27,70		39,00		8,50	CRE	Smi-Koyo	Audi A4,A6	
● F-00735	2	7V1	27,70		39,60		20,25	CRE	Smi-Koyo	Peugeot 407	
● F-00809	2	7V1PM	27,70		40,00	9,00	10,00	CRE	Mando	Hyundai Santa Fe	
● F-00698	2	7V1	27,70		40,10		8,50	CRE		Hyundai Sonata	
● CT22718	2	7V1PM	27,70		40,20	9,00	10,00	CRE			
● F-00900	2	7V1PM	27,70		40,20	9,00	10,00	CRE	Mando	Hyundai Santa Fe	originale/genuine
● F-00270	2	7V2	27,70		42,00		8,50	CRE		Mitsubishi	
● F-00914	2	7V1	27,70		42,00		8,50	CRE		Mitsubishi	originale/genuine
● F-00960	2	7V1	27,70		42,00		8,50	CRE		Mitsubishi	
● F-00268	2	7V2	27,70		42,00		12,50	CRE		Mitsubishi	
● F-00798	2	7V1	27,70		42,00		13,00	CRE			da abbinare al raschiatore F- 00697A
● F-00871	2	7V1PM	27,70		42,10	9,00	10,00	CRE	Mando	Santa Fè	
● F-00950	2	7V1PM	27,70		42,10	9,00	10,00	CRE	Mando	Santa Fè	originale/genuine
● F-00962	2	7V1	27,70		42,20		7,50	CRE	Koyo	Renault, Nissan	
● F-00540	2	7V1	27,70		42,50		8,50	CRE		Mitsubishi Colt, Evo	
● F-00940	2	7V1	27,70		44,00		8,00	CRE		Hyundai Sonata 5	Cremagliera Hyun- dai Sonata 5
● F-00847	2	7V1PM	27,70		44,10	9,00	10,00	CRE	Smi-Koyo	Hyundai Sonata	
● F-00697	2	7V1PM	27,70		44,10	13,00	14,00	CRE	Mando	Hyundai Sonata	
● F-00899	2	7V1PM	27,70		44,10	13,00	14,00	CRE	Mando	Hyundai Sonata	originale/genuine
● F-00766	2	7V1	27,70		45,00		7,50	CRE		Renault	originale/genuine alte temperature
● F-00375	2	7V1	27,70		45,00		8,50	CRE	Smi-Koyo	Renault Espace	

CRE	Cremagliera	<i>Rack</i>	<i>Гидроцилиндр</i>
DIS	Distributore	<i>Pignon</i>	<i>Распределитель</i>
PIS	Pistone	<i>Piston</i>	<i>Поршень</i>
POM	Pompa	<i>Pump</i>	<i>Насос</i>
SCA	Scatola	<i>Box</i>	<i>Корпус редуктора</i>

Codice Code Код	Min Ord Мин. коли- чество заказа	Dis. Drawing Тип сальника	d1	d2	D	h1	H	Uso Use in Приме- нение	Marca Brand Произво- дитель агрегата	Tipo auto Vehicle type Тип авто	Note Remarks Примечания
			Размеры								
F-00751	2	7V1PM	27,70		46,00	9,00	10,00	CRE	Mando	Hyundai Tucson	
F-00872	2	7V1PM	27,70		46,00	13,00	14,00	CRE	Mando	Santa Fè	
F-00624	2	7V1	27,70		46,10		12,90	CRE	Koyo	Mitsubishi	
F-00951	2	7V1PM	27,70		46,10	13,00	14,00	CRE	Mando	Santa Fè	originale/genuine
F-00810	2	7V1PM	27,70		48,00	9,00	10,00	CRE	Mando	Hyundai Santa Fe	
F-00970	2	7V1	27,70		50,10		9,00			Hyundai 2006 Kia Carnival	
F-00996	2	7V1PM	27,70		50,20	9,00	10,00			Hyundai 2006, Kia Sedoma, Karnival	Hyundai 2006, Kia Sedoma, Karnival
F-00589	2	7V2	28,00		38,00		7,00	CRE		Audi A4	
F-00378	2	7V3	28,00		38,00	7,00	9,00	CRE	ZF	Passat, A4	
F-00409	2	7V2	28,00		38,00		15,00	CRE	ZF	Audi A6, A8	
F-00584	2	7V3	28,00		38,00	15,00	17,00	CRE	ZF	Ducato, Daily	
F-00754	2	7V2A	28,00		39,00		15,00	CRE	ZF		
F-00492	2	7V2	28,00		39,10		15,00	CRE	ZF	VW Transporter T5, Audi A4, Tuareg, Q7, Cayenne,	
F-00057	2	7V2	28,00		39,60		6,50	CRE	TRW	Alfa 156, Scudo, Galaxy	originale/genuine
F-00022	2	7V2	28,00		39,64		6,35	CRE	TRW	Bmw Z3, Citroen	standard
F-00662	2	7V2	28,00		39,98		6,35	CRE		Porsche Boxster, Freelander	
F-00546	2	7V2	28,00		40,00		6,50	CRE	TRW	Porsche Boxster, Freelander	
F-00749	2	7V1	28,00		40,10		8,00	CRE		Mitsubishi Diamante	originale/genuine
F-00139	2	7V2	28,00		40,20		8,00	CRE	ZF	Audi A8	
F-00842	2	7V2	28,00		40,60		7,50	CRE		Ford	
F-00814	2	7V1	28,00		41,00		8,00	CRE		Kia Sedona 2005	originale/genuine
F-00269	2	7V2	28,00		41,20		8,00	CRE		Kia Carnival	
F-00743	2	7V1	28,00		41,20		8,00	CRE		Kia Karnival II	
F-00961	2	7V1	28,00		42,00		8,50	CRE			
F-00709	2	7V1	28,00		43,00		9,00	CRE		Mitsubishi Evo X	
CT21990	2	7V2	28,00		44,00		7,20	CRE		F. S-Max	originale/genuine
F-00869	2	7V1	28,00		44,00		7,50	CRE		Ford S.Max	
F-00843	2	7V2	28,00		44,60		7,50	CRE		Ford	
F-00816	2	7V1	28,00		44,80		9,00	CRE	TRW	Pontiac GTO 2004	originale/genuine
F-00752	2	7V2	28,00		46,00		8,50	CRE			
F-00286	2	7V1	28,00		46,00		12,50	CRE		Mitsubishi	
F-00750	2	7V1	28,00		46,20		9,00	CRE		Mitsubishi Diamante	
F-00729	2	7V1	28,00		47,90		10,00	CRE	TRW		
F-00522	2	7V2	28,00		48,20		8,50	CRE		Mazda	
F-00603	2	7V2	28,30		41,50		8,00	CRE			
F-00343	2	7V2	28,50		44,50		10,00	CRE		Rover, Jaguar	
F-00342	2	7V2G	28,50		45,00		9,00	CRE		Jaguar XJ6	
F-00112	2	7V2G	29,00		37,00		8,00	CRE		Jaguar	
F-00320	2	7V3G	30,00		38,00	3,50	5,50	DIS		Jaguar Adwest	P.T.F.E. + paraolio
F-00539	2	7V2	30,00		42,00		8,00	CRE		Bmw X5	
F-00704	2	7V1	30,00		42,00		15,00	CRE	ZF	Ducato - Bmw Servotronic X5	
F-00537	2	7V3	30,00		42,10	15,00	17,00	CRE	ZF	Ducato, BMW Servotronic X5	con teflon esterno
F-00271	2	7V2	30,00		42,30		8,00	CRE		Toyota	

INFORMAZIONE TIP РЕКОМЕНДАЦИИ

I paraoli minorati sono identificati con la lettera finale «X»
Esempio F-00024: dimensioni normali - F-00024X: minorato
Reduced seals are identified with final letter «X»
Example F-00024: regular sizes - F-00024X: reduced seal
Сальники, обозначенные буквой «X», являются аналогами стандартных сальников с уменьшенным внутренним диаметром
Например: F-00024 - стандартный F-00024X - с уменьшенным внутренним диаметром



Codice Code Код	Min Ord Мин. коли- чество заказа	Dis. Drawing Тип сальника	d1	d2	D	h1	H	Uso Use in Приме- нение	Marca Brand Произво- дитель агрегата	Tipo auto Vehicle type Тип авто	Note Remarks Примечания
F-00017	2	7V2	30,00		42,50		6,50	CRE	TRW	Fiat Ducato – Iveco Daily	standard
F-00033	2	7V2	30,00		42,50		6,50	CRE	TRW	Ducato	originale/genuine
F-00417	2	7V2	30,00		42,80		6,30	CRE	TRW	Fiat Ducato – Iveco Daily	originale/genuine maggiorato
F-00593	2	7V2	30,00		42,80		8,00	CRE		M,B 100,140 Minibus Main	
F-00800	2	7V1	30,00		44,20		8,50	CRE		Toyota Tacoma	
CT24107	2	7V2A	30,00	42,10	44,40		15,00	CRE		Bmw X3	Originale/genuine
F-00725	2	7V3	30,00		45,50	10,00	12,70	CRE			
F-00272	2	7V2	30,00		45,70		8,50	CRE		Toyota,Celica 4WD	
F-00273	2	7V2	30,00		46,20		8,00	CRE		Toyota	
F-00719	2	7V1	30,00		47,00		8,50	CRE		Mercedes Vito	
F-00756	2	7V2	30,00		47,00		8,50	CRE			
F-00274	2	7V2	30,00		47,00		9,00	CRE		Toyota	
F-00450	2	7V2	30,00		48,10		8,00	CRE		Toyota Hi ace	
F-00841	2	7V1PM	30,00		48,10	9,00	10,00	CRE	Mando	Jeep	
F-01005	2	7V1PM	30,00		48,10	9,00	10,00	CRE	Mando	Jeep	originale-genuine
CT20622	2	7V1	30,00		48,20		8,00	CRE		Toyota Hi ace	
F-00801	2	7V1	30,00		48,20		8,50	CRE		Toyota Tacoma	
F-00585	2	7V3	30,00		49,70	10,00	13,00	CRE		GMC Chevy Trailblazer	
F-00374	2	7V1	30,00		50,00		8,50	CRE		Nissan	
F-00718	2	7V1	30,00		50,00		10,00	CRE		Mercedes Vito	
F-00755	2	7V2	30,00		50,00		10,00	CRE			
F-00622	2	7V2	30,00		54,70		8,00	CRE		Mercedes Sprinter	
F-00587	2	7V2	31,00		43,00		7,00	CRE	ZF	Bmw Serie 7	
F-00588	2	7V2	31,00		43,00		15,00	CRE	ZF	Bmw Serie 7	
F-00289	2	7V2	31,00		43,70		6,30	CRE		Ford Explorer	
F-00932	2	7V2	31,00		44,60		8,50	CRE			Cremagliera
F-00582	2	7V2	31,00		47,80		7,50	CRE		Ford Explorer	
CT25191	2	7V2	31,00		52,00		7,60	CRE			
F-00910	2	7V1	31,00		52,00		8,00	CRE		Ford Expedition	Ford Expedition, F150
F-00103X	2	7V1	31,50		44,50		6,50	CRE	TRW	Mercedes Vito Sprinter	rigato esternamente originale/genuine
F-00103	2	7V2	32,00		44,50		6,50	CRE	TRW	Mercedes Vito Sprinter	rigato esternamente
F-00444	2	7V2	32,00		44,50		8,50	CRE		Mercedes	
F-00880	2	7V1	32,00		44,50		8,50	CRE		Mercedes	
F-00737	2	7V2	32,00		44,60		6,50	CRE	TRW	Mercedes Vito Sprinter, Ducato U.T.	nuovo mod. maggiorato, rigato esternamente
F-00569	2	7V3	32,00		44,70	5,00	6,50	DIS		Jeep	
F-01003	2	7V2	32,00		45,65		6,90	CRE		Chevrolet Tahoe	Chevrolet Tahoe
F-00276	2	7V1	32,00		46,10		8,50	CRE			
CT20617	2	7V1	32,00		47,00		8,50	CRE		Mitsubishi Pajero	
F-00644	2	7V1PM	32,00		47,50	10,00	12,00	CRE		Cherokee ultimo tipo	
F-00973	2	7V1PM	32,00		47,50	10,00	12,00	CRE		Cherokee ultimo tipo	Genuin
F-00803	2	7V3	32,00		47,50	10,00	12,70	CRE		Chevy	
F-00275	2	7V1	32,00		49,00		8,50	CRE			
F-00560	2	7V1	32,00		50,00		8,50	CRE		Mitsubishi Pajero	
F-00902	2	7V1	32,00		50,00		9,00	CRE		LDV Maxus	originale/genuine

CRE	Cremagliera	Rack	Гидроцилиндр
DIS	Distributore	Pignon	Распределитель
PIS	Pistone	Piston	Поршень
POM	Pompa	Pump	Насос
SCA	Scatola	Box	Корпус редуктора

Codice Code Код	Min Ord Мин. количество заказа	Dis. Drawing Тип сальника	d1	d2	D	h1	H	Uso Use in Применение	Marca Brand Производитель агрегата	Tipo auto Vehicle type Тип авто	Note Remarks Примечания
			Размеры								
F-00745	2	7V1	32,00		52,20		10,00	CRE		Dodge Ram Serie 1500	
F-00581	2	7V1	32,00		52,40		10,00	CRE		Dodge	
F-00827	2	7V1	32,00		53,00		8,50	CRE		Nissan Infiniti	
• CT24618	2	7V1PM	32,00		54,00	9,00	10,00	CRE		BUICK	Genuin
• CT25164	2	7V3	32,00		55,00		14,50	CRE		Chevrolet Tahoe	Chevrolet Tahoe
F-00857	2	7V1	32,00		56,00		9,00	CRE		Nissan	
• F-00974	2	7V2G	35,00		46,50		7,10	CRE		Isuzu	P.T.F.E. + paraolio
F-00856	2	7V1PM	35,00		47,00	7,30	8,30			Jeep Wrangler	
F-00398	2	7V2	35,00		50,00		8,00	CRE		Toyota Land Cruiser	
• F-00939	2	7V1	35,00		53,00		8,50	CRE		Lexus RX 470	
• F-00988	2	7V1	35,00		53,00		8,50	CRE		Lexus RX 470	originale/genuine
F-00451	2	7V1	35,00		56,00		8,00	CRE		Toyota Land Cruiser	
F-00655	2	7V2	36,00		48,10		6,70	CRE		Mercedes	
F-00277	2	7V2	36,00		50,50		9,00	CRE			
• F-00975	2	7V2G	40,00		51,20		7,30	CRE		Isuzu	P.T.F.E. + paraolio
• F-00972	2	7V1	40,00		55,00	8,50	9,00	CRE		Nissan Cabstar TAS 20 /30 m616 /617	
F-00579	2	7V2	41,00		54,00		8,00	CRE		Pajero, Camion	
F-00804	2	7V2	41,00		57,50		9,00	CRE		Ford	
F-00551	2	7V2	45,00		59,00		5,50	DIS		Mercedes LS4	
F-00639	2	7V2	52,00		66,00		5,50	CRE		Autocarro Mercedes	
F-00559	2	7V2	56,00		70,00		5,50	DIS		Mercedes LS7	originale/genuine
F-00977	2	7V1PM	57,00		74,70	9,00	9,50			TAS 75/80	originale/genuine
CT20624	2	7V2	60,00		74,00		5,50	CRE		Mercedes	

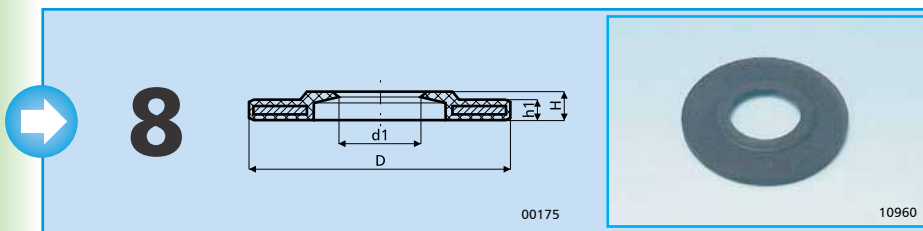

Codice Code Код	Min Ord Мин. количество заказа	Dis. Drawing Тип сальника	d1	d2	D	h1	H	Uso Use in Применение	Marca Brand Производитель агрегата	Tipo auto Vehicle type Тип авто	Note Remarks Примечания
			Размеры								
F-00466	2	8A	11,75	22,13	29,80	1,90	12,65	POM		Jeep Cherokee	
F-00340	2	8	16,00		40,00		2,50	DIS		Saab, Opel Corsa	parapolvere
F-00310	2	8	16,00		42,30	5,00	9,00	DIS		Mazda	parapolvere
• CT22383	2	8	16,50		41,50	3,50	5,00	DIS		S-Max	parapolvere S-Max
F-00419	2	8	17,00		40,00	4,60	6,50	DIS			
F-00566	2	8	17,00		43,00	3,30	3,80	DIS	TRW		
F-00306	2	8	18,00		32,20	6,20	8,20	DIS		Subaru	
F-00654	2	8	18,90		51,40	4,50	6,70	DIS	TRW	Fiat Doblo	parapolvere
F-00039	2	8	19,00		34,60	4,30	6,30	DIS	TRW	Golf	viton
F-00040	2	8	19,00		34,60	4,30	6,30	DIS	TRW	Golf	standard
F-00317	2	8	19,00		40,00		2,50	DIS		Sintra	parapolvere
F-00536	2	8	19,05		35,00	6,00	8,00	DIS		Renault Master, Vauxhall Movano	
F-00436	2	8	19,05		37,30	6,00	8,00	DIS		Renault Peugeot	

Gli articoli identificati con l'iniziale «CT» (codice temporaneo) sono attualmente in fase di test e prossimi all'introduzione definitiva nel mercato.

Items whose code starts with «CT» (temporary code) are currently being tested and they are candidate to be introduced in the market soon.
Пункты, обозначенные аббревиатурой «CT» (временный код), в данный момент проходят испытания и будут представлены на рынок в ближайшее время.

Codice Code Код	Min Ord Мин. количество заказа	Dis. Drawing Тип сальника	d1	d2	D	h1	H	Uso Use in Приме-нение	Marca Brand Производитель агрегата	Tipo auto Vehicle type Тип авто	Note Remarks Примечания
			Размеры								
F-00084	2	8	20,00		33,00	1,60	2,00	DIS		Bendix	parapolvere
F-00815	2	8	20,50		46,00	3,30	5,00	DIS		Ford C-Max	parapolvere
F-00345	2	8	22,00		33,20	1,60	3,00	DIS		Rover 3,4 Bulloni	
F-00305	2	8A	22,20		42,80		14,70	DIS	TRW		
CT22702	2	8	25,00		40,80	1,30	4,00			HFB70 DAF, Scania	Raschiatore
F-00060	2	8	29,00		44,60	3,00	3,90	DIS		Rover 3,4 bulloni	
F-00957	2	8	32,00		46,10		5,80	DIS		Ford, Lincoln, Mercury	
F-00580	2	8	41,00		54,00	1,30	3,50	SCA		Pajero, Camion	parapolvere
CT22703	2	8	57,00		70,80	1,30	4,00			HFB70 DAF, Scania	Raschiatore
CT24904	2	8	57,13		74,57		2,90		TRW	TAS 80	TAS 80
F-00636	2	8	83,00		90,00		6,10	SCA		veicoli commerciali	paraolio autolivellante
F-00637	2	8	83,00		90,00		6,10	SCA		veicoli commerciali	

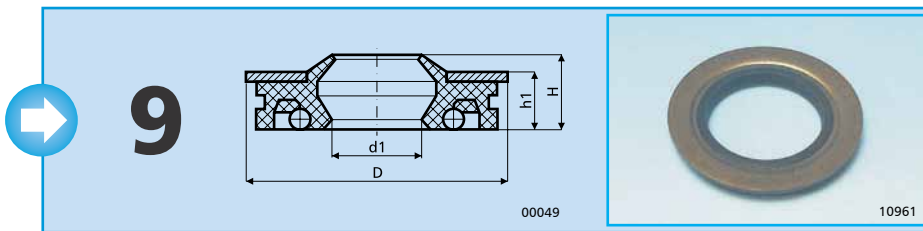

Codice Code Код	Min Ord Мин. количество заказа	Dis. Drawing Тип сальника	d1	d2	D	h1	H	Uso Use in Приме-нение	Marca Brand Производитель агрегата	Tipo auto Vehicle type Тип авто	Note Remarks Примечания
			Размеры								
F-00362	2	9	23,00		38,00	5,00	7,00	DIS	TRW	Trattori movimento terra	
F-00113	2	9	28,00		47,00	4,20	5,00	DIS		Renault 205 ultimo tipo	
F-00076	2	9	28,40		46,80	5,80	6,50	DIS		Peugeot, Renault, Renault18	originale/genuine
F-00075	2	9M	29,40		46,80	5,80	7,00	DIS		Peugeot 505, Renault	originale/genuine

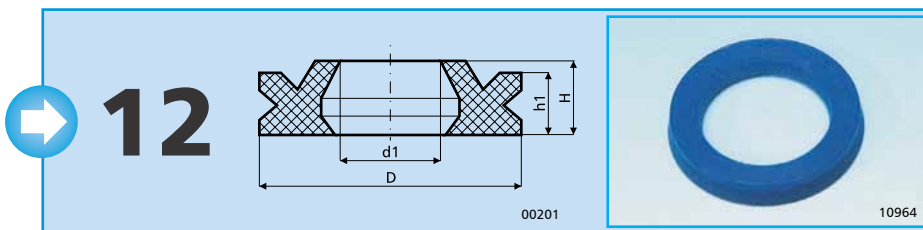

Codice Code Код	Min Ord Мин. количество заказа	Dis. Drawing Тип сальника	d1	d2	D	h1	H	Uso Use in Приме-нение	Marca Brand Производитель агрегата	Tipo auto Vehicle type Тип авто	Note Remarks Примечания
			Размеры								
CT25190	2	12	10,00		14,50		2,70	POM		Honda Civic	Valvola pompa
F-00885	2	12	10,00		16,00		4,00				
CT25189	2	12	15,50		20,90		4,30	POM	Saginaw		Pompa saginaw
F-00851	2	12	19,00		31,00		5,00			Peugeot	
F-00945	2	12	20,00		31,00		5,00			VW Transporter	parapolvere

CRE	Cremagliera	Rack	Гидроцилиндр
DIS	Distributore	Pignon	Распределитель
PIS	Pistone	Piston	Поршень
POM	Pompa	Pump	Насос
SCA	Scatola	Box	Корпус редуктора

Codice Code Код	Min Ord Мин. коли- чество заказа	Dis. Drawing Тип сальника	d1	d2	D	h1	H	Uso Use in Приме- нение	Marca Brand Произво- дитель агрегата	Tipo auto Vehicle type Тип авто	Note Remarks Примечания
			Размеры								
● F-00882	2	12	20,00		32,00		7,50			Cherokee	
F-00329	2	12	21,10		30,00		5,25	CRE		Honda	in poliuretano
F-00083	2	12	22,00		31,00		4,00	DIS		Renault	
F-00050	2	12	22,00		31,00		4,50	DIS		Rover 3,4 Bulloni	
F-00393	2	12	22,00		31,00		5,00	CRE		Suzuki Swift-Subaru	
● F-00929	2	12	22,00		31,00		5,50	CRE		Honda	
F-00322	2	12	22,00		32,00		6,50	CRE		Mazda	
F-00344	2	12	22,20		33,20		4,00	DIS		Jaguar Granada	
F-00349	2	12	22,50		29,00		3,60	DIS		Stag	in gomma
F-00363	2	12	23,00		29,50	5,00	7,00	DIS	TRW	Trattori movimento terra	con P.T.F.E.
F-00278	2	12	23,00		30,00		5,00	DIS		Subaru	
F-00348	2	12	24,00		34,00		4,00	DIS		Jaguar, Granada MKI	
F-00489	2	12	25,00		34,00		5,00	CRE		Honda - Suzuki Gran Vitara	originale/genuine
F-00321	2	12	25,00		35,00		6,00	CRE		Mazda	
F-00412	2	12	25,00		35,40		6,30	CRE		Mazda	
F-00334	2	12	25,00		37,70		9,30	CRE		Austin 1800,2200	
F-00649	2	12	25,00		39,00		6,50	DIS		Rolls Royce	
● CT23043	2	12	25,40		38,10		6,50	CRE		Rolls Royce	
F-00350	2	12	26,00		32,50		3,60	DIS		Granada	
F-00646	2	12	26,00		35,30		7,00	CRE			
● CT23207	2	12	27,00		35,00		5,00			Nissan Skyline	
F-00318	2	12	27,70		36,00		5,00	DIS		Mazda	
F-00457	2	12	28,00		36,00		5,50	DIS		Stag	
F-00620	2	12	28,00		36,00		8,00	PIS		Camion-Veicoli commerciali, Iveco-Scania	pistone idraulico
F-00700	2	12	28,00		37,50		7,80	PIS		Autocarro	per pistone 3° asse autocarro
● CT24755	2	12	28,00		38,00		5,00	DIS			
F-00085	2	12	28,00		38,00		5,00	DIS		Renault	
F-00346	2	12	28,00		38,30		4,00	DIS		Jaguar, Granada	
F-00341	2	12	28,00		42,00		7,00	CRE		Triumph, Jaguar	
● CT23958	2	12	28,50		35,50		3,90			Amc Pacer 1978	
F-00049	2	12	28,50		35,50		4,00	DIS		Jaguar J40	
F-00336	2	12	29,00		37,00		5,00	DIS		Suzuki Vitara	
F-00298	2	12	29,00		37,50		6,00	DIS		Subaru	
F-00190	2	12	29,00		45,00		5,00	DIS		Rover 3,4 Bulloni	
F-00629	2	12	30,00		38,00		8,00	DIS		veicoli commerciali	autocarri
F-00210	2	12	31,00		39,00		5,00	DIS		Mitsubishi Shougun, Suzuki Vitara	
● F-00876	2	12	31,70	47,80	47,80		8,50			Nissan Fusu	in gomma forma ad U
● F-00913	2	12	31,75		41,25		6,35				
● F-00905	2	12	31,75		44,45		6,35	DIS		Rover	Distributore Rover
● F-01001	2	12	32,00		40,00		5,00	DIS			
F-00211	2	12	32,00		40,00		5,00	DIS		Isuzu, Frontera, Trooper	
F-00676	2	12	32,00		41,50		6,50	DIS		Veicolo commerciale	
F-00866	2	12	32,00		42,00		7,00	CRE			
F-00470	2	12	32,00		42,00		8,00	CRE			

INFORMAZIONE TIP РЕКОМЕНДАЦИИ

I paraoli minorati sono identificati con la lettera finale «X»
Esempio F-00024: dimensioni normali - F-00024X: minorato
Reduced seals are identified with final letter «X»
Example F-00024: regular sizes - F-00024X: reduced seal
Сальники, обозначенные буквой «X», являются аналогами стандартных сальников с уменьшенным внутренним диаметром
Например: F-00024 - стандартный F-00024X - с уменьшенным внутренним диаметром



Codice Code Код	Min Ord Мин. коли- чество заказа	Dis. Drawing Тип сальника	d1	d2	D	h1	H	Uso Use in Приме- нение	Marca Brand Произво- дитель агрегата	Tipo auto Vehicle type Тип авто	Note Remarks Примечания
			Размеры								
F-00621	2	12	32,00		42,00		8,00	PIS		Camion-Veicoli commerciali, Iveco-Scania	pistone
F-00591	2	12	32,00		44,50		6,20	DIS		Tata	
F-00197	2	12	32,00		44,50		7,00	DIS		Rover 3,4,6 Bulloni	
F-00482	2	12	32,00		45,00		8,00	DIS		Rover 3,4 Bulloni	
F-00115	2	12	32,00		45,00		10,50	DIS		Bendix, Transit	
F-00623	2	12	32,00		45,00		10,50	DIS		Bendix, Transit	
F-00202	2	12	32,00	44,50	46,00		5,00	DIS		Rover 3,4 Bulloni	originale/genuine
F-00203	2	12	32,00	44,60	46,20		6,40	DIS		Rover 3,4 Bulloni	originale/genuine in poliuretano azzurro
F-00214	2	12	32,00	44,70	46,30		7,00	DIS		Rover 3,4 Bulloni	in poliuretano azzurro
F-00351	2	12	34,00		40,00		3,60	DIS		Jaguar, Rover	
F-00352	2	12	34,00		44,50		4,30	DIS		Alpine Solara	
F-00685	2	12	35,00		42,00		3,70	DIS		Jaguar, Rover	
F-00454	2	12	35,00		47,00		6,50	DIS		Mitsubishi, Nissan, Hyundai Terracan	pignone
F-00999	2	12	35,00		48,00		7,00	DIS			
F-00828	2	12	35,00		50,00		9,00				
F-00822	2	12	35,00		50,00		10,00			Omai Falcon	
CT25196	2	12	36,00		44,00		6,00	DIS			
F-00316	2	12	36,00		45,00		3,70	DIS		Jaguar J16,XJ12	
F-00337	2	12	36,00		46,00		6,00	DIS		Mitsubishi Shougun	
CT22724	2	12	36,00		47,50		7,00	PIS			
F-00553	2	12	38,00		47,70		6,50	DIS		Nissan Patrol GQ	a settore
F-00873	2	12	38,00		48,00		8,00			Scania	
F-00638	2	12	38,00		51,00		8,00	PIS		Land Rover Discovery MK2	
F-00437	2	12	38,00		53,00	7,20	9,50	DIS			
F-00906	2	12	38,10		50,80		7,90				
F-00468	2	12	39,00		49,00		6,40	CRE		Jeep Cherokee ultimo tipo	
F-00992	2	12	40,00		50,00		8,00	DIS		veicoli commerciali	Eurostar
F-00116	2	12	40,00		55,00		10,00	DIS		Bendix, Transit	
F-00628	2	12	40,00		55,00		11,00	DIS		veicoli commerciali	autocarri
F-00564	2	12	40,00		55,50		6,30	DIS		Bendix, Transit	materiale speciale
CT22684	2	12	40,00		56,00		6,00			TAS 20	
CT22809	2	12	40,00	44,60	50,00		11,00	DIS			originale/genuine in poliuretano blu
F-00616	2	12	43,00		60,00		6,00	PIS	ZF	Iveco, Scania	tenuta pistone
CT24893	2	12	44,00		54,00		6,70			Renault Shepard piccola	Renault Shepard piccola
CT22029	2	12	45,00		60,00		5,60			Mercedes LS4	Mercedes LS4
F-00630	2	12	46,00		56,00		10,00	DIS DIS		veicoli commerciali	autocarri
F-00955	2	12	49,00		62,00		3,50	DIS			
F-00701	2	12	52,00		60,00		6,00	PIS		Autocarro	per pistone 3° asse autocarro
F-00491	2	12	52,00		66,00		5,50	DIS		Mercedes LS6	albero uscita
CT22030	2	12	52,00		67,00		5,60			Mercedes LS4	Mercedes LS4
CT22349	2	12	55,00		71,40		5,60			Mercedes LS8	Mercedes LS8
CT20597	2	12	57,10		75,50		6,50	DIS		TAS 75	
F-00635	2	12	70,00		78,00	4,00	7,00	PIS		veicoli commerciali	paraolio autolivell.

CRE	Creomaglieria	Rack	Гидроцилиндр
DIS	Distributore	Pignon	Распределитель
PIS	Pistone	Piston	Поршень
POM	Pompa	Pump	Насос
SCA	Scatola	Box	Корпус редуктора

Codice Code Код	Min Ord Мин. количество заказа	Dis. Drawing Тип сальника	d1	d2	D	h1	H	Uso Use in Приме- нение	Marca Brand Произво- дитель агрегата	Tipo auto Vehicle type Тип авто	Note Remarks Примечания
			Размеры								
F-00634	2	12	70,00		85,00		12,00	PIS		Camion-veicoli pesanti	paraolio autolivell.
● CT22722	2	12	75,00		89,60		4,50	PIS			per tenuta pistone

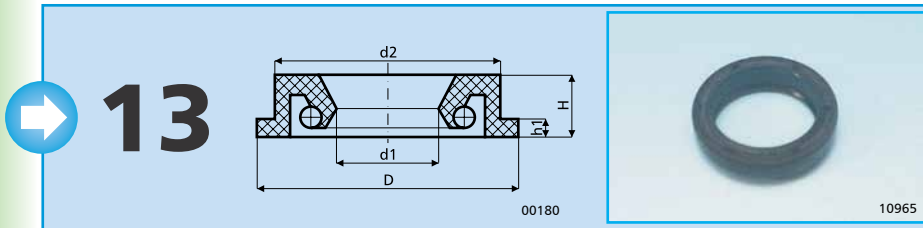

Codice Code Код	Min Ord Мин. количество заказа	Dis. Drawing Тип сальника	d1	d2	D	h1	H	Uso Use in Приме- нение	Marca Brand Произво- дитель агрегата	Tipo auto Vehicle type Тип авто	Note Remarks Примечания
			Размеры								
F-00131	2	13	25,60		33,40	5,50	8,60	DIS	TRW	Veicoli pesanti	

Disegni speciali
Special drawings
Специальный тип сальников

Codice Code Код	Min Ord Мин. количество заказа	Dis. Drawing Тип сальника	d1	d2	D	h1	H	Uso Use in Приме- нение	Marca Brand Произво- дитель агрегата	Tipo auto Vehicle type Тип авто	Note Remarks Примечания
			Размеры								
F-00723	2	spec.			22,00		5,50	DIS	ZF		distributore inf. - tappo
F-00105	2	spec.			28,30	5,00	8,00	DIS	TRW		distributore inf. - tappo
F-00335	2	spec.	20,00		35,00		4,00	DIS		Wiper Jaguar J40	
● CT22784	2		22,00		35,30		8,50	POM		Toyota	Pompa Toyota
F-00338	2	spec.	22,00		40,00		4,00	DIS		Wiper Rover 4 Bulloni	
● CT23020	2		24,00		35,00		11,30	CRE		VW PQ 35 Gen III	VW PQ 35 Gen III
● CT22936	2		26,00		28,30	5,50	8,50	DIS	TRW	Alfa 166	distributore inf. - tappo Alfa 166
● CT22937	2		30,00		32,20	5,50	13,00	DIS	TRW	Punto, Multipla, Y	distributore inf. - tappo Punto, Multipla, Y
● CT22939	2		30,00	32,30	38,30	2,00	16,00	DIS	TRW	doblo	distr inf. - tappo con ribordatura doblo
CT20594	2		35,00		50,00		7,00				
● CT22938	2		38,00		40,30	6,50	16,00	DIS	TRW	Ducato	distributore inf. - tappo Ducato
● CT23156	2		40,00		62,00		8,00				motore Smart
● CT22979	2		50,00		72,00		9,00				Volvo
● CT22980	2		50,00		73,00		11,00				Volvo
● CT25175	0		65,00		85,00		10,00				
● CT23574	2		70,00		81,50		6,00				
● CT23157	2		80,00		100,00		9,00				motore Smart
● CT25176	0		85,00		130,00		10,00				

Gli articoli identificati con l'iniziale «CT» (codice temporaneo) sono attualmente in fase di test e prossimi all'introduzione definitiva nel mercato.

*Items whose code starts with «CT» (temporary code) are currently being tested and they are candidate to be introduced in the market soon.
Пункты, обозначенные аббревиатурой «СТ» (временный код), в данный момент проходят испытания и будут представлены на рынок в ближайшее время.*



F-M

Paraoli per scatole guida meccaniche

Seals for mechanic steering boxes

Сальники для рулевых агрегатов без гидроусилителя

Codice Code Код	Min Ord Мин. коли- чество заказа	Dis. Drawing Тип сальника	d1	d2	D	h1	H	Uso Use in Приме- нение	Tipo auto Vehicle type Тип авто	Note Remarks Примечания
			Размеры							
F-M6006	2	3G	14,00		29,10		11,50	DIS	Burman (Taxi)	parapolvere
F-M6003	2	1P	15,00		28,20	3,00	9,00	DIS	Ford Fiesta, XR2, Sierra	parapolvere pignone Ford Fiesta, XR2, Sierra
F-M6002	2	1P	15,00		28,50	3,00	9,30	DIS	Ford Escort, Cortina, Capri	parapolvere pignone Ford Escort, Cortina, Capri
F-M6004	2	12	16,00		22,00		8,00	DIS	VW GOLF	parapolvere pignone Golf VW
F-M6001	2	1P	17,00		35,00	3,00	8,50	DIS	Ford Granada	parapolvere pignone Ford Granada
F-M6005	2	12	22,00		30,00		7,30	DIS	Alpine	parapolvere pignone R.Alpine

O-ring a sezione tonda

O-rings, round section

Резиновые кольца круглого сечения



Min. ordine 10 pezzi Min. order 10 items Мин. заказ 10 штук

HT per alte temperature
for high temperatures
температуростойкие

VHT per altissime temperature
for very high temperatures
сверхтемпературостойкие

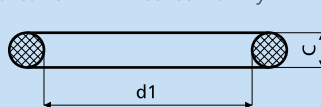

00181



11340

in ordine di codice

sorted by code
сортировка по коду

Codice Code Код	C	d1	Note Remarks Примечания
O-02001	1,68	1,78	HT
O-02002	1,68	2,57	HT
O-02003	1,68	2,90	HT
O-02004	1,68	5,41	HT
O-02005	1,68	6,00	HT
O-02006	1,68	3,69	HT
O-02007	1,68	17,70	HT
O-02007V	1,68	17,70	VHT
O-02008	1,68	4,48	HT
O-02009	1,68	7,66	HT
O-02010	1,68	30,00	HT
O-02011	1,68	31,00	HT
O-02012	1,68	6,75	HT
O-02013	1,68	31,20	HT
O-02014	1,68	8,73	HT
O-02015	1,68	32,00	HT
O-02016	1,68	18,77	HT
O-02017	1,68	28,30	HT
O-02018	1,68	9,25	HT
O-02019	1,68	10,82	HT
O-02020	1,68	33,05	HT
O-02021	1,68	11,11	HT
O-02022	1,68	12,42	HT
O-02022V	1,68	12,42	VHT
O-02023	1,68	14,00	HT
O-02024	1,68	15,60	HT
O-02025	1,68	20,35	HT
O-02026	1,68	21,95	HT
O-02027	1,68	23,52	HT
O-02028	1,68	25,12	HT
O-02029	1,68	26,70	HT
O-02030	1,68	34,65	HT
O-02031	1,68	50,52	HT
O-02031V	1,68	50,52	VHT
O-02032	1,68	53,70	HT
O-02033	1,68	56,87	HT
O-02034	1,68	60,05	HT

Codice Code Код	C	d1	Note Remarks Примечания
O-02035	1,68	66,40	HT
O-02035A	1,68	36,65	HT
O-02036	1,68	69,57	HT
O-02037	1,68	72,75	HT
O-02038	1,68	17,17	VHT
O-02039	1,68	82,27	HT
O-02040	1,68	37,70	HT
O-02041	1,68	63,22	HT
O-02042	1,68	88,62	HT
O-02043	1,68	43,00	HT
O-02044	1,68	94,97	HT
O-02045	1,68	41,00	HT
O-02046	1,68	98,00	HT
O-02047	1,68	101,32	HT
O-02048	1,68	44,00	HT
O-02049	1,68	107,67	HT
O-02050	1,68	114,02	HT
O-02051	1,68	120,37	HT
• O-02052	1,68	61,00	HT
O-02060	1,68	47,50	HT
O-02070	1,68	64,40	HT
O-02076	1,68	75,92	HT
• O-02090	1,80	42,00	HT
O-02101	2,70	5,23	HT
O-02102	2,70	6,02	HT
O-02103	2,70	7,59	HT
O-02104	2,70	9,13	HT
O-02105	2,70	9,19	HT
O-02106	2,70	9,92	HT
O-02107	2,70	10,78	HT
O-02108	2,70	11,91	HT
O-02109	2,70	15,54	HT
O-02110	2,70	4,50	HT
O-02111	2,70	15,88	HT
O-02111V	2,62	15,88	VHT pompa Xantia
O-02112	2,70	17,13	HT
O-02113	2,70	17,86	HT

Codice Code Код	C	d1	Note Remarks Примечания
O-02114	2,62	18,72	HT
O-02114V	2,62	18,72	VHT
O-02115	2,70	12,37	HT
O-02116	2,70	15,00	HT
O-02116A	2,70	15,00	VHT
O-02117	2,70	13,00	HT
O-02118	2,70	20,35	HT
O-02119	2,70	22,50	HT
O-02120	2,70	23,00	HT
O-02121	2,70	13,95	HT
O-02122	2,70	20,63	HT
O-02123	2,70	28,25	HT
O-02124	2,70	29,82	HT
O-02125	2,70	21,89	HT
O-02126	2,70	31,70	HT
O-02127	2,70	23,81	HT
O-02128	2,70	32,99	HT
O-02129	2,70	26,65	HT
O-02130	2,70	34,60	HT
O-02131	2,70	40,95	HT
O-02132	2,70	43,00	HT
O-02133	2,70	47,30	HT
O-02134	2,70	48,89	HT
O-02134V	2,70	48,89	VHT
O-02135	2,70	52,07	HT
O-02135A	2,70	42,52	HT
O-02136	2,70	53,65	HT
O-02137	2,70	55,25	HT
O-02138	2,70	58,42	HT
O-02139	2,70	60,00	HT
O-02140	2,70	36,00	HT
O-02140V	2,62	36,17	VHT
O-02141	2,70	61,60	HT
O-02142	2,70	25,00	HT
O-02143	2,70	37,90	HT
O-02144	2,70	39,50	HT
O-02145	2,70	44,10	HT

HT per alte temperature

for high temperatures

температуростойкие

VHT per altissime temperature

for very high temperatures

сверхтемпературостойкие



Codice Code Код	C	d1	Note
			Remarks Примечания
O-02146	2,70	63,17	HT
O-02147	2,70	64,77	HT
O-02148	2,70	66,35	HT
O-02149	2,70	67,95	HT
O-02150	2,70	46,00	HT
O-02151	2,70	69,52	HT
O-02152	2,70	71,12	HT
O-02153	2,70	72,69	HT
O-02155	2,70	75,87	HT
O-02158	2,70	82,22	HT
O-02160	2,70	57,00	HT
O-02161	2,70	50,44	HT
O-02162	2,70	88,57	HT
O-02163	2,70	94,92	HT
O-02164	2,70	101,27	HT
O-02165	2,70	107,62	HT
O-02166	2,70	113,97	HT
O-02167	2,70	120,32	HT
O-02168	2,70	109,62	Piastra Mini
O-02201	3,60	7,51	HT
O-02202	3,60	9,12	HT
O-02203	3,60	10,69	HT
O-02204	3,60	12,29	HT
O-02205	3,60	13,87	HT
O-02206	3,60	15,47	HT
O-02207	3,60	18,64	HT
O-02208	3,60	20,22	HT
O-02209	3,60	21,82	HT
O-02209V	3,60	21,82	VHT
O-02210	3,60	17,00	HT
O-02211	3,60	26,00	HT
O-02212	3,60	23,40	HT
O-02213	3,53	31,34	HT
O-02214	3,60	32,93	HT
O-02215	3,60	34,30	HT
O-02216	3,60	24,99	HT
O-02217	3,60	26,58	HT
O-02218	3,60	28,17	HT
O-02219	3,60	29,75	HT
O-02220	3,60	36,10	HT
O-02221	3,60	37,69	HT
O-02222	3,60	39,69	HT
O-02223	3,60	40,86	HT

Codice Code Код	C	d1	Note
			Remarks Примечания
O-02224	3,60	41,28	HT
O-02225	3,60	42,86	HT
O-02226	3,60	44,04	HT
O-02227	3,60	44,45	HT
O-02228	3,60	46,04	HT
O-02229	3,60	47,63	HT
O-02230	3,60	47,20	HT
O-02231	3,60	49,21	HT
O-02232	3,60	50,39	HT
O-02233	3,60	52,39	HT
O-02234	3,60	53,57	HT
O-02235	3,60	53,98	HT
O-02236	3,60	55,56	HT
O-02236V	3,60	55,56	VHT
O-02237	3,60	57,15	HT
O-02238	3,60	58,74	HT
O-02239	3,60	59,92	HT
O-02240	3,60	50,80	HT
O-02241	3,60	94,84	HT
O-02242	3,60	56,75	HT
O-02243	3,60	60,33	HT
O-02244	3,60	61,91	HT
O-02245	3,60	63,09	HT
O-02246	3,60	63,50	HT
O-02247	3,60	65,09	HT
O-02248	3,60	66,27	HT
O-02249	3,60	66,68	HT
O-02250	3,60	68,26	HT
O-02251	3,60	69,44	HT
O-02252	3,60	69,85	HT
O-02253	3,60	71,44	HT
O-02254	3,60	72,62	HT
O-02255	3,60	74,61	HT
O-02256	3,60	75,80	HT
O-02257	3,60	78,97	HT
O-02258	3,60	82,14	HT
O-02259	3,60	85,32	HT
O-02259V	3,60	85,32	VHT
O-02260	3,60	73,03	HT
O-02261	3,60	88,50	HT
O-02262	3,60	91,67	HT
O-02263	3,60	98,02	HT
O-02264	3,60	101,20	HT
O-02265	3,60	104,40	HT

Codice Code Код	C	d1	Note
			Remarks Примечания
O-02266	3,60	107,50	HT
O-02267	3,60	110,70	HT
O-02268	3,60	113,90	HT
O-02269	3,60	117,10	HT
O-02270	3,60	120,20	HT
O-02271	3,60	18,00	HT
O-02272	3,60	123,42	HT
O-02273	3,53	32,00	HT
O-02274	3,60	34,00	VHT
● O-02275	3,60	130,00	HT
● O-02276	3,53	205,00	
● O-02277	3,60	48,80	HT
O-02280	5,30	21,82	HT
O-02281	5,05	26,00	HT
O-02282	5,05	27,00	HT
O-02283	5,05	36,00	HT
O-02284	5,05	56,70	HT
O-02285	5,05	33,00	
● O-02286	5,05	35,00	
● O-02287	5,05	32,00	
O-02325	5,30	40,64	HT
O-02326	5,30	34,29	HT
O-02327	5,30	56,52	HT
O-02328	5,30	59,69	HT
O-02329	5,30	62,87	HT
O-02330	5,30	31,10	HT
O-02331	5,30	43,82	
O-02332	5,30	73,00	HT
● O-02333	5,30	85,09	HT
O-02401	7,10	49,00	HT
O-02503	1,05	2,00	HT
O-02505	1,05	3,00	HT
O-02507	1,05	4,00	HT
O-02509	1,05	5,00	HT
O-02511	1,05	6,00	HT
O-02513	1,05	7,00	HT
O-02515	1,05	8,00	HT
O-02517	1,05	9,00	HT
O-02519	1,05	10,00	HT
O-02521	1,05	11,00	HT
O-02523	1,05	12,00	HT
O-02525	1,05	13,00	HT
O-02527	1,05	14,00	HT
O-02529	1,05	15,00	HT



O-ring a sezione tonda

O-ring round section
Резиновые кольца круглого сечения

in ordine di codice

sorted by code
сортировка по коду

Codice Code Код	C	d1	Note
			Remarks Примечания
O-02531	1,05	16,00	HT
O-02533	1,05	17,00	HT
O-02535	1,05	18,00	HT
O-02536	1,05	19,00	HT
O-02538	1,05	20,00	HT
O-02539	1,05	21,00	HT
O-02541	1,05	23,00	HT
O-02542	1,05	24,00	HT
O-02543	1,05	25,00	HT
O-02601	1,55	2,00	HT
O-02602	1,55	2,50	HT
O-02604	1,55	3,50	HT
O-02605	1,55	7,00	HT
O-02606	1,55	4,00	HT
O-02607	1,55	16,00	HT
O-02608	1,55	4,50	HT
O-02609	1,55	19,00	HT
O-02610	1,55	24,00	HT
O-02611	1,55	25,00	HT
O-02612	1,55	27,00	HT
O-02613	1,55	5,00	HT
O-02614	1,55	5,50	HT
O-02615	1,55	6,00	HT
O-02616	1,55	6,50	HT
O-02617	1,55	7,50	HT
O-02618	1,55	8,00	HT
O-02620	1,55	31,00	HT
O-02621	1,55	9,00	HT
O-02622	1,55	9,50	HT
O-02623	1,55	10,00	HT
O-02625	1,55	11,00	HT
O-02626	1,55	11,50	HT
O-02627	1,55	12,00	HT
O-02629	1,55	13,00	HT
O-02630	1,55	40,00	HT
O-02631	1,55	14,00	HT
O-02633	1,55	15,00	HT
O-02635	1,55	17,00	HT
O-02636	1,55	17,50	HT
O-02637	1,55	18,00	HT
O-02639	1,55	19,50	HT
O-02640	1,55	20,00	HT
• O-02640V	1,55	20,00	VHT
O-02642	1,55	21,00	HT

Codice Code Код	C	d1	Note
			Remarks Примечания
O-02644	1,55	22,00	HT
O-02649	1,55	26,00	HT
O-02652	1,55	28,00	HT
O-02654	1,55	29,00	HT
O-02659	1,55	32,00	HT
O-02661	1,55	33,00	HT
O-02662	1,55	34,00	HT
O-02665	1,55	37,00	HT
O-02668	1,55	39,00	HT
O-02672	1,55	42,00	HT
O-02673	1,55	43,00	HT
O-02675	1,55	45,00	HT
O-02676	1,55	46,00	HT
O-02677	1,55	47,00	HT
O-02681	1,55	52,00	HT
O-02682	1,55	53,00	HT
O-02684	1,55	55,00	HT
O-02687	1,55	58,00	HT
O-02692	1,55	63,00	HT
O-02697	1,55	68,00	HT
O-02699	1,55	70,00	HT
O-02701	2,05	8,50	HT
O-02702	2,05	3,00	HT
O-02703	2,05	3,50	HT
O-02704	2,05	4,00	HT
O-02705	2,05	4,50	HT
O-02706	2,05	5,00	HT
O-02707	2,05	5,50	HT
O-02708	2,05	6,00	HT
O-02709	2,05	6,50	HT
O-02710	2,05	7,00	HT
O-02711V	2,05	8,00	VHT
O-02712	2,05	10,00	HT
O-02713	2,05	11,00	HT
O-02713V	2,05	11,00	VHT
O-02714	2,05	17,50	HT
O-02715	2,05	17,00	HT
O-02715V	2,05	17,00	VHT
O-02716	2,05	25,00	HT
O-02717	2,05	26,00	HT
O-02718	2,05	30,00	HT
O-02719	2,05	32,00	HT
O-02720	2,05	35,00	HT
O-02721	2,05	34,00	HT

Codice Code Код	C	d1	Note
			Remarks Примечания
O-02722	2,05	7,50	HT
O-02724	2,05	9,00	HT
O-02726	2,05	10,50	HT
O-02728	2,05	12,00	HT
O-02729	2,05	12,50	HT
O-02730	2,05	36,00	HT
O-02731	2,05	37,00	HT
O-02731V	2,05	37,00	VHT
O-02732	2,05	38,00	HT
O-02733	2,05	13,00	HT
O-02735	2,05	14,00	HT
O-02737	2,05	15,00	HT
• O-02737V	2,05	15,00	VHT
O-02738	2,05	48,00	mescola dura
O-02739	2,05	16,00	HT
O-02739A	2,05	16,00	VHT
O-02739V	2,05	16,00	VHT
O-02741	2,05	18,00	HT
O-02742	2,05	55,00	mescola dura
O-02743	2,05	19,00	HT
O-02745	2,05	43,00	HT
O-02746	2,05	44,00	HT
O-02747	2,05	45,00	HT
O-02748	2,05	46,00	HT
O-02749	2,05	20,00	HT
O-02750	2,05	48,00	HT
O-02752	2,05	52,00	HT
O-02753	2,05	21,00	HT
O-02755	2,05	22,00	HT
O-02756	2,05	22,50	HT
O-02757	2,05	54,00	HT
O-02758	2,05	56,00	HT
O-02759	2,05	23,00	HT
O-02760	2,05	58,00	HT
O-02762	2,05	24,00	HT
O-02766	2,05	27,00	HT
O-02768	2,05	28,00	HT
O-02768V	2,05	28,00	VHT
O-02769	2,05	29,00	HT
O-02770	2,05	68,00	HT
O-02771	2,05	42,00	VHT
O-02771A	2,05	31,00	HT
O-02772	2,05	33,00	HT

HT per alte temperature

for high temperatures

температуростойкие

VHT per altissime temperature

for very high temperatures

сверхтемпературостойкие



Codice Code Код	C	d1	Note
			Remarks Примечания
O-02773	2,05	39,00	HT
O-02773A	2,05	40,00	HT
O-02774	2,05	41,00	HT
O-02774A	2,05	42,00	HT
O-02775	2,05	47,00	HT
O-02775A	2,05	49,00	HT
O-02776	2,05	50,00	HT
O-02777	2,05	53,00	HT
O-02777A	2,05	55,00	HT
O-02778	2,05	57,00	HT
O-02778A	2,05	59,00	HT
O-02779	2,05	60,00	HT
O-02779A	2,05	61,00	HT
O-02780	2,05	62,00	HT
O-02780A	2,05	63,00	HT
O-02781	2,05	64,00	HT
O-02781A	2,05	65,00	HT
O-02782	2,05	66,00	HT
O-02782A	2,05	67,00	HT
• O-02783A	2,05	70,00	HT
O-02783V	2,05	61,00	VHT
O-02784	2,05	71,00	HT
O-02784A	2,05	72,00	HT
O-02785	2,05	73,00	HT
O-02785A	2,05	74,00	HT
O-02786	2,05	75,00	HT
O-02786A	2,05	76,00	HT
O-02787A	2,05	78,00	HT
O-02788A	2,05	80,00	HT
O-02789A	2,05		HT
O-02790	2,05	110,00	HT
O-02791	2,05	83,00	HT
O-02791A	2,05	84,00	HT
O-02793	2,05	90,00	HT
O-02795	2,20	37,50	HT
O-02796A	2,05	100,00	HT
• O-02797	2,20	33,00	Ducato
O-02802	2,45	5,00	HT
O-02805	2,45	7,00	HT
O-02806	2,45	7,50	HT
O-02807	2,45	6,00	HT
O-02809	2,45	9,00	HT
O-02810	2,45	11,00	HT
O-02812	2,45	10,00	HT

Codice Code Код	C	d1	Note
			Remarks Примечания
O-02813	2,45	13,00	VHT
O-02814	2,45	8,00	HT
O-02815	2,45	13,00	HT
O-02816	2,45	15,00	HT
O-02817	2,45	19,00	HT
O-02818	2,45	21,00	HT
O-02820	2,45	25,00	HT
O-02821	2,45	30,00	HT
O-02822	2,45	12,00	HT
O-02823	2,45	12,50	HT
O-02825	2,45	38,00	HT
O-02826	2,45	14,00	HT
O-02828	2,45	16,00	HT
O-02830	2,45	32,00	HT
O-02831	2,45	17,00	HT
O-02832	2,45	33,00	HT
O-02835	2,45	18,00	HT
O-02836	2,45	35,50	HT
O-02837	2,45	49,00	HT
O-02838	2,45	55,00	HT
O-02841	2,45	20,00	HT
O-02844	2,45	22,00	HT
O-02845	2,45	70,00	HT
O-02847	2,45	23,00	HT
O-02849	2,45	24,00	HT
O-02850	2,45	72,00	HT
O-02851A	2,45	26,00	HT
O-02851B	2,45	27,00	HT
O-02852	2,45	27,50	HT
O-02852A	2,45	28,00	HT
O-02852B	2,45	29,00	HT
O-02853A	2,45	31,00	VHT
O-02853B	2,45	31,00	HT
O-02854	2,45	31,60	VHT
O-02854B	2,45	35,00	HT
O-02855	2,45	37,00	HT
O-02855A	2,45	38,00	HT
O-02855B	2,45	37,50	HT
O-02856	2,45	36,00	HT
O-02856B	2,45	40,00	HT
O-02857	2,45		HT
O-02857A	2,45	42,00	HT
O-02858	2,45	44,00	HT
O-02859	2,45	47,00	HT

Codice Code Код	C	d1	Note
			Remarks Примечания
O-02859A	2,45	48,00	HT
O-02859B	2,45	50,00	HT
O-02861A	2,45	56,00	HT
O-02861B	2,45	57,00	HT
O-02862A	2,45	59,00	HT
O-02863A	2,45	62,00	HT
O-02864	2,45	64,00	HT
O-02864A	2,45	65,00	HT
O-02865	2,45	63,00	HT
O-02867	2,45	75,00	HT
O-02867A	2,45	76,00	HT
O-02868	2,45	78,00	HT
O-02869	2,45	80,00	HT
O-02870A	2,45	86,00	HT
O-02871A	2,45	90,00	HT
O-02873	2,45	96,00	HT
O-02873A	2,45	98,00	HT
O-02873B	2,45	100,00	HT
O-02874	2,45	102,00	HT
O-02874A	2,45	103,00	HT
O-02874B	2,45	105,00	HT
O-02875	2,45	107,00	HT
O-02876A	2,45		HT
O-02876B	2,45	114,00	HT
O-02878A	2,45	116,00	HT
O-02878B	2,45	120,00	HT
O-02901V	3,05	53,00	VHT
O-02902	3,53	30,00	HT
O-02903	3,53	40,00	HT
O-02904	3,05	6,00	HT
O-02905	3,05	7,00	HT
O-02906	3,05	8,00	HT
O-02907	3,05	9,00	HT
O-02908	3,05	10,00	HT
O-02910	3,05	24,00	HT
O-02911	3,05	25,00	HT
O-02912	3,05	12,00	HT
O-02913	3,05	13,00	HT
O-02914	3,05	14,00	HT
O-02915	3,05	22,00	HT
O-02916	3,05	15,00	HT
O-02917	3,05	16,00	HT
O-02918	3,05	17,00	HT
O-02918A	3,05	18,00	HT



O-ring a sezione tonda

O-ring round section
Резиновые кольца круглого сечения

in ordine di codice

sorted by code
сортировка по коду

Codice Code Код	C	d1	Note Remarks Примечания
O-02919	3,05	19,00	HT
O-02919A	3,05	20,00	HT
O-02920A	3,05	23,00	HT
O-02921	3,05	26,00	HT
O-02921A	3,05	27,00	HT
O-02922	3,05	28,00	HT
O-02922A	3,05	29,00	HT
O-02923	3,05	32,00	HT
O-02923A	3,05	33,00	HT
O-02924	3,05	34,00	HT
O-02924A	3,05	35,00	HT
O-02925	3,05	36,00	HT
O-02925A	3,05	37,00	HT
O-02925V	3,05	36,00	VHT
O-02926	3,05	38,00	HT
O-02926A	3,05	39,00	HT
O-02927	3,05	40,00	HT
O-02927A	3,05	41,00	HT
O-02928	3,05	42,00	HT
O-02928A	3,05	43,00	HT
O-02928V	3,05	43,00	VHT
O-02929	3,05	30,00	HT
O-02929A	3,05	31,50	HT
O-02930	3,05	31,00	HT
O-02931	3,05	44,00	HT
O-02931A	3,05	45,00	HT
O-02931V	3,00	45,00	VHT
O-02932	3,05	46,00	HT
O-02932A	3,05	47,00	HT
O-02933	3,05	48,00	HT
O-02933A	3,05	49,00	HT
O-02934	3,05	50,00	HT
O-02934A	3,05	40,00	VHT
O-02935	3,05	54,00	HT
O-02936	3,05	52,00	HT
O-02936A	3,05	53,00	HT
O-02936V	3,00	53,00	VHT
O-02937	3,05	55,00	HT
O-02937A	3,05	56,00	HT
O-02938	3,05	57,00	HT
O-02938A	3,05	58,00	HT
O-02939	3,05	59,00	HT
O-02939A	3,05	60,00	HT
O-02940A	3,05	62,00	HT

Codice Code Код	C	d1	Note Remarks Примечания
O-02942	3,05	65,00	HT
O-02942A	3,05	66,00	HT
O-02943A	3,05	68,00	HT
O-02945	3,05	70,00	HT
O-02946	3,05	72,00	HT
O-02946A	3,05	73,00	HT
O-02947	3,05	74,00	HT
O-02947A	3,05	76,00	HT
O-02948A	3,05	78,00	HT
O-02949	3,05	79,00	HT
O-02949A	3,05	80,00	HT
O-02950	3,05	75,00	HT
O-02951A	3,05	82,00	HT
O-02952	3,05	85,00	HT
O-02952A	3,05	84,00	HT
O-02953V	3,05	86,00	VHT
O-02954	3,05	88,00	HT
O-02955	3,05	90,00	HT
O-02957	3,05	94,00	HT
O-02957A	3,05	95,00	HT
O-02958	3,05	96,00	HT
O-02959	3,05	98,00	HT
O-02960	3,05	100,00	HT
O-02961	3,05	102,00	HT
O-02962	3,05	104,00	HT
O-02962A	3,05	105,00	HT
O-02963	3,05	106,00	HT
O-02964	3,05	108,00	HT
O-02965	3,05	86,00	HT
O-02966	3,05	110,00	HT
O-02967	3,05	112,00	HT
O-02967A	3,05		HT
O-02968	3,05	114,00	HT
O-02968A	3,05	115,00	HT
O-02969	3,05	116,00	HT
O-02970	3,05	118,00	HT
O-02971	3,05	120,00	HT
O-02980	3,30	38,00	HT
O-02981	3,20	40,00	HT
O-03001	4,10	10,00	HT
O-03002	4,10	11,00	HT
O-03003	4,10	12,00	HT
O-03004	5,05	27,00	HT
O-03005	5,05	36,00	HT

Codice Code Код	C	d1	Note Remarks Примечания
O-03006	4,10	15,00	HT
O-03007	4,10	16,00	HT
O-03008	4,10	17,00	HT
O-03009	4,10	18,00	HT
O-03010	4,10	22,00	HT
O-03012	4,10	20,00	HT
O-03015	4,10	25,00	HT
O-03017	4,10	27,00	HT
O-03018	4,10	28,00	HT
O-03019	4,10	29,00	HT
O-03020	4,10	24,00	HT
O-03021	4,10	30,00	HT
O-03023	4,10	32,00	HT
O-03024	4,10	33,00	HT
O-03025	4,10	34,00	HT
O-03026	4,10	35,00	HT
O-03027	4,10	36,00	HT
O-03029	4,10	38,00	HT
O-03030	4,10	40,00	HT
O-03032	4,10	42,00	HT
O-03033	4,10	43,00	HT
O-03034	4,10	44,00	HT
O-03035	4,10	45,00	HT
O-03037	4,10	47,00	HT
O-03038	4,10	48,00	HT
O-03039	4,10	49,00	HT
O-03040	4,10	39,00	HT
O-03041	4,10	50,00	HT
O-03042	4,10	64,00	HT
O-03043	4,10	90,00	HT
O-03044	4,10	53,00	HT
O-03045	4,10	54,00	HT
O-03084	4,10	94,00	HT
O-03085	4,50	19,00	HT

O-ring a sezione tonda

O-rings, round section

Резиновые кольца круглого сечения



Min. ordine 10 pezzi Min. order 10 items Мин. заказ 10 штук

HT per alte temperature
for high temperatures
температуростойкие

VHT per altissime temperature
for very high temperatures
сверхтемпературостойкие

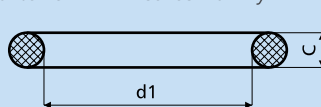

00181



11340

in ordine di corda

sorted by section
сортировка по размеру

Codice Code Код	C	d1	Note Remarks Примечания
	Размеры		
O-02503	1,05	2,00	HT
O-02505	1,05	3,00	HT
O-02507	1,05	4,00	HT
O-02509	1,05	5,00	HT
O-02511	1,05	6,00	HT
O-02513	1,05	7,00	HT
O-02515	1,05	8,00	HT
O-02517	1,05	9,00	HT
O-02519	1,05	10,00	HT
O-02521	1,05	11,00	HT
O-02523	1,05	12,00	HT
O-02525	1,05	13,00	HT
O-02527	1,05	14,00	HT
O-02529	1,05	15,00	HT
O-02531	1,05	16,00	HT
O-02533	1,05	17,00	HT
O-02535	1,05	18,00	HT
O-02536	1,05	19,00	HT
O-02538	1,05	20,00	HT
O-02539	1,05	21,00	HT
O-02541	1,05	23,00	HT
O-02542	1,05	24,00	HT
O-02543	1,05	25,00	HT
O-02601	1,55	2,00	HT
O-02602	1,55	2,50	HT
O-02604	1,55	3,50	HT
O-02606	1,55	4,00	HT
O-02608	1,55	4,50	HT
O-02613	1,55	5,00	HT
O-02614	1,55	5,50	HT
O-02615	1,55	6,00	HT
O-02616	1,55	6,50	HT
O-02605	1,55	7,00	HT
O-02617	1,55	7,50	HT
O-02618	1,55	8,00	HT
O-02621	1,55	9,00	HT
O-02622	1,55	9,50	HT
O-02623	1,55	10,00	HT

Codice Code Код	C	d1	Note Remarks Примечания
	Размеры		
O-02625	1,55	11,00	HT
O-02626	1,55	11,50	HT
O-02627	1,55	12,00	HT
O-02629	1,55	13,00	HT
O-02631	1,55	14,00	HT
O-02633	1,55	15,00	HT
O-02607	1,55	16,00	HT
O-02635	1,55	17,00	HT
O-02636	1,55	17,50	HT
O-02637	1,55	18,00	HT
O-02609	1,55	19,00	HT
O-02639	1,55	19,50	HT
• O-02640V	1,55	20,00	VHT
O-02640	1,55	20,00	HT
O-02642	1,55	21,00	HT
O-02644	1,55	22,00	HT
O-02610	1,55	24,00	HT
O-02611	1,55	25,00	HT
O-02649	1,55	26,00	HT
O-02612	1,55	27,00	HT
O-02652	1,55	28,00	HT
O-02654	1,55	29,00	HT
O-02620	1,55	31,00	HT
O-02659	1,55	32,00	HT
O-02661	1,55	33,00	HT
O-02662	1,55	34,00	HT
O-02665	1,55	37,00	HT
O-02668	1,55	39,00	HT
O-02630	1,55	40,00	HT
O-02672	1,55	42,00	HT
O-02673	1,55	43,00	HT
O-02675	1,55	45,00	HT
O-02676	1,55	46,00	HT
O-02677	1,55	47,00	HT
O-02681	1,55	52,00	HT
O-02682	1,55	53,00	HT
O-02684	1,55	55,00	HT
O-02687	1,55	58,00	HT

Codice Code Код	C	d1	Note Remarks Примечания
	Размеры		
O-02692	1,55	63,00	HT
O-02697	1,55	68,00	HT
O-02699	1,55	70,00	HT
O-02001	1,68	1,78	HT
O-02002	1,68	2,57	HT
O-02003	1,68	2,90	HT
O-02006	1,68	3,69	HT
O-02008	1,68	4,48	HT
O-02004	1,68	5,41	HT
O-02005	1,68	6,00	HT
O-02012	1,68	6,75	HT
O-02009	1,68	7,66	HT
O-02014	1,68	8,73	HT
O-02018	1,68	9,25	HT
O-02019	1,68	10,82	HT
O-02021	1,68	11,11	HT
O-02022V	1,68	12,42	VHT
O-02022	1,68	12,42	HT
O-02023	1,68	14,00	HT
O-02024	1,68	15,60	HT
O-02038	1,68	17,17	VHT
O-02007V	1,68	17,70	VHT
O-02007	1,68	17,70	HT
O-02016	1,68	18,77	HT
O-02025	1,68	20,35	HT
O-02026	1,68	21,95	HT
O-02027	1,68	23,52	HT
O-02028	1,68	25,12	HT
O-02029	1,68	26,70	HT
O-02017	1,68	28,30	HT
O-02010	1,68	30,00	HT
O-02011	1,68	31,00	HT
O-02013	1,68	31,20	HT
O-02015	1,68	32,00	HT
O-02020	1,68	33,05	HT
O-02030	1,68	34,65	HT
O-02035A	1,68	36,65	HT
O-02040	1,68	37,70	HT



O-ring a sezione tonda

O-ring round section
Резиновые кольца круглого сечения

in ordine di corda

sorted by section
сортировка по размеру

Codice Code Код	C	d1	Note Remarks Примечания
O-02045	1,68	41,00	HT
O-02043	1,68	43,00	HT
O-02048	1,68	44,00	HT
O-02060	1,68	47,50	HT
O-02031	1,68	50,52	HT
O-02031V	1,68	50,52	VHT
O-02032	1,68	53,70	HT
O-02033	1,68	56,87	HT
O-02034	1,68	60,05	HT
O-02052	1,68	61,00	HT
O-02041	1,68	63,22	HT
O-02070	1,68	64,40	HT
O-02035	1,68	66,40	HT
O-02036	1,68	69,57	HT
O-02037	1,68	72,75	HT
O-02076	1,68	75,92	HT
O-02039	1,68	82,27	HT
O-02042	1,68	88,62	HT
O-02044	1,68	94,97	HT
O-02046	1,68	98,00	HT
O-02047	1,68	101,32	HT
O-02049	1,68	107,67	HT
O-02050	1,68	114,02	HT
O-02051	1,68	120,37	HT
O-02090	1,80	42,00	HT
O-02789A	2,05		HT
O-02702	2,05	3,00	HT
O-02703	2,05	3,50	HT
O-02704	2,05	4,00	HT
O-02705	2,05	4,50	HT
O-02706	2,05	5,00	HT
O-02707	2,05	5,50	HT
O-02708	2,05	6,00	HT
O-02709	2,05	6,50	HT
O-02710	2,05	7,00	HT
O-02722	2,05	7,50	HT
O-02711V	2,05	8,00	VHT
O-02701	2,05	8,50	HT
O-02724	2,05	9,00	HT
O-02712	2,05	10,00	HT
O-02726	2,05	10,50	HT
O-02713V	2,05	11,00	VHT
O-02713	2,05	11,00	HT
O-02728	2,05	12,00	HT

Codice Code Код	C	d1	Note Remarks Примечания
O-02729	2,05	12,50	HT
O-02733	2,05	13,00	HT
O-02735	2,05	14,00	HT
O-02737	2,05	15,00	HT
O-02737V	2,05	15,00	VHT
O-02739A	2,05	16,00	VHT
O-02739	2,05	16,00	HT
O-02739V	2,05	16,00	VHT
O-02715V	2,05	17,00	VHT
O-02715	2,05	17,00	HT
O-02714	2,05	17,50	HT
O-02741	2,05	18,00	HT
O-02743	2,05	19,00	HT
O-02749	2,05	20,00	HT
O-02753	2,05	21,00	HT
O-02755	2,05	22,00	HT
O-02756	2,05	22,50	HT
O-02759	2,05	23,00	HT
O-02762	2,05	24,00	HT
O-02716	2,05	25,00	HT
O-02717	2,05	26,00	HT
O-02766	2,05	27,00	HT
O-02768V	2,05	28,00	VHT
O-02768	2,05	28,00	HT
O-02769	2,05	29,00	HT
O-02718	2,05	30,00	HT
O-02771A	2,05	31,00	HT
O-02719	2,05	32,00	HT
O-02772	2,05	33,00	HT
O-02721	2,05	34,00	HT
O-02720	2,05	35,00	HT
O-02730	2,05	36,00	HT
O-02731V	2,05	37,00	VHT
O-02731	2,05	37,00	HT
O-02732	2,05	38,00	HT
O-02773	2,05	39,00	HT
O-02773A	2,05	40,00	HT
O-02774	2,05	41,00	HT
O-02774A	2,05	42,00	HT
O-02771	2,05	42,00	VHT
O-02745	2,05	43,00	HT
O-02746	2,05	44,00	HT
O-02747	2,05	45,00	HT
O-02748	2,05	46,00	HT

Codice Code Код	C	d1	Note Remarks Примечания
O-02775	2,05	47,00	HT
O-02738	2,05	48,00	mescola dura
O-02750	2,05	48,00	HT
O-02775A	2,05	49,00	HT
O-02776	2,05	50,00	HT
O-02752	2,05	52,00	HT
O-02777	2,05	53,00	HT
O-02757	2,05	54,00	HT
O-02777A	2,05	55,00	HT
O-02742	2,05	55,00	mescola dura
O-02758	2,05	56,00	HT
O-02778	2,05	57,00	HT
O-02760	2,05	58,00	HT
O-02778A	2,05	59,00	HT
O-02779	2,05	60,00	HT
O-02783V	2,05	61,00	VHT
O-02779A	2,05	61,00	HT
O-02780	2,05	62,00	HT
O-02780A	2,05	63,00	HT
O-02781	2,05	64,00	HT
O-02781A	2,05	65,00	HT
O-02782	2,05	66,00	HT
O-02782A	2,05	67,00	HT
O-02770	2,05	68,00	HT
O-02783A	2,05	70,00	HT
O-02784	2,05	71,00	HT
O-02784A	2,05	72,00	HT
O-02785	2,05	73,00	HT
O-02785A	2,05	74,00	HT
O-02786	2,05	75,00	HT
O-02786A	2,05	76,00	HT
O-02787A	2,05	78,00	HT
O-02788A	2,05	80,00	HT
O-02791	2,05	83,00	HT
O-02791A	2,05	84,00	HT
O-02793	2,05	90,00	HT
O-02796A	2,05	100,00	HT
O-02790	2,05	110,00	HT
O-02797	2,20	33,00	Ducato
O-02795	2,20	37,50	HT
O-02876A	2,45		HT
O-02857	2,45		HT
O-02802	2,45	5,00	HT

Min. ordine 10 pezzi Min. order 10 items Мин. заказ 10 штук

HT per alte temperature

for high temperatures

температуростойкие

VHT per altissime temperature

for very high temperatures

сверхтемпературостойкие



Codice Code Код	C	d1	Note
			Remarks Примечания
O-02807	2,45	6,00	HT
O-02805	2,45	7,00	HT
O-02806	2,45	7,50	HT
O-02814	2,45	8,00	HT
O-02809	2,45	9,00	HT
O-02812	2,45	10,00	HT
O-02810	2,45	11,00	HT
O-02822	2,45	12,00	HT
O-02823	2,45	12,50	HT
O-02815	2,45	13,00	HT
O-02813	2,45	13,00	VHT
O-02826	2,45	14,00	HT
O-02816	2,45	15,00	HT
O-02828	2,45	16,00	HT
O-02831	2,45	17,00	HT
O-02835	2,45	18,00	HT
O-02817	2,45	19,00	HT
O-02841	2,45	20,00	HT
O-02818	2,45	21,00	HT
O-02844	2,45	22,00	HT
O-02847	2,45	23,00	HT
O-02849	2,45	24,00	HT
O-02820	2,45	25,00	HT
O-02851A	2,45	26,00	HT
O-02851B	2,45	27,00	HT
O-02852	2,45	27,50	HT
O-02852A	2,45	28,00	HT
O-02852B	2,45	29,00	HT
O-02821	2,45	30,00	HT
O-02853B	2,45	31,00	HT
O-02853A	2,45	31,00	VHT
O-02854	2,45	31,60	VHT
O-02830	2,45	32,00	HT
O-02832	2,45	33,00	HT
O-02854B	2,45	35,00	HT
O-02836	2,45	35,50	HT
O-02856	2,45	36,00	HT
O-02855	2,45	37,00	HT
O-02855B	2,45	37,50	HT
O-02825	2,45	38,00	HT
O-02855A	2,45	38,00	HT
O-02856B	2,45	40,00	HT
O-02857A	2,45	42,00	HT
O-02858	2,45	44,00	HT

Codice Code Код	C	d1	Note
			Remarks Примечания
O-02859	2,45	47,00	HT
O-02859A	2,45	48,00	HT
O-02837	2,45	49,00	HT
O-02859B	2,45	50,00	HT
O-02838	2,45	55,00	HT
O-02861A	2,45	56,00	HT
O-02861B	2,45	57,00	HT
O-02862A	2,45	59,00	HT
O-02863A	2,45	62,00	HT
O-02865	2,45	63,00	HT
O-02864	2,45	64,00	HT
O-02864A	2,45	65,00	HT
O-02845	2,45	70,00	HT
O-02850	2,45	72,00	HT
O-02867	2,45	75,00	HT
O-02867A	2,45	76,00	HT
O-02868	2,45	78,00	HT
O-02869	2,45	80,00	HT
O-02870A	2,45	86,00	HT
O-02871A	2,45	90,00	HT
O-02873	2,45	96,00	HT
O-02873A	2,45	98,00	HT
O-02873B	2,45	100,00	HT
O-02874	2,45	102,00	HT
O-02874A	2,45	103,00	HT
O-02874B	2,45	105,00	HT
O-02875	2,45	107,00	HT
O-02876B	2,45	114,00	HT
O-02878A	2,45	116,00	HT
O-02878B	2,45	120,00	HT
O-02111V	2,62	15,88	VHT pompa Xantia
O-02114	2,62	18,72	HT
O-02114V	2,62	18,72	VHT
O-02140V	2,62	36,17	VHT
O-02110	2,70	4,50	HT
O-02101	2,70	5,23	HT
O-02102	2,70	6,02	HT
O-02103	2,70	7,59	HT
O-02104	2,70	9,13	HT
O-02105	2,70	9,19	HT
O-02106	2,70	9,92	HT
O-02107	2,70	10,78	HT

Codice Code Код	C	d1	Note
			Remarks Примечания
O-02108	2,70	11,91	HT
O-02115	2,70	12,37	HT
O-02117	2,70	13,00	HT
O-02121	2,70	13,95	HT
O-02116	2,70	15,00	HT
O-02116A	2,70	15,00	VHT
O-02109	2,70	15,54	HT
O-02111	2,70	15,88	HT
O-02112	2,70	17,13	HT
O-02113	2,70	17,86	HT
O-02118	2,70	20,35	HT
O-02122	2,70	20,63	HT
O-02125	2,70	21,89	HT
O-02119	2,70	22,50	HT
O-02120	2,70	23,00	HT
O-02127	2,70	23,81	HT
O-02142	2,70	25,00	HT
O-02129	2,70	26,65	HT
O-02123	2,70	28,25	HT
O-02124	2,70	29,82	HT
O-02126	2,70	31,70	HT
O-02128	2,70	32,99	HT
O-02130	2,70	34,60	HT
O-02140	2,70	36,00	HT
O-02143	2,70	37,90	HT
O-02144	2,70	39,50	HT
O-02131	2,70	40,95	HT
O-02135A	2,70	42,52	HT
O-02132	2,70	43,00	HT
O-02145	2,70	44,10	HT
O-02150	2,70	46,00	HT
O-02133	2,70	47,30	HT
O-02134	2,70	48,89	HT
O-02134V	2,70	48,89	VHT
O-02161	2,70	50,44	HT
O-02135	2,70	52,07	HT
O-02136	2,70	53,65	HT
O-02137	2,70	55,25	HT
O-02160	2,70	57,00	HT
O-02138	2,70	58,42	HT
O-02139	2,70	60,00	HT
O-02141	2,70	61,60	HT
O-02146	2,70	63,17	HT
O-02147	2,70	64,77	HT



O-ring a sezione tonda

O-ring round section
Резиновые кольца круглого сечения

in ordine di corda

sorted by section
сортировка по размеру

Codice Code Код	C	d1	Note Remarks Примечания
O-02148	2,70	66,35	HT
O-02149	2,70	67,95	HT
O-02151	2,70	69,52	HT
O-02152	2,70	71,12	HT
O-02153	2,70	72,69	HT
O-02155	2,70	75,87	HT
O-02158	2,70	82,22	HT
O-02162	2,70	88,57	HT
O-02163	2,70	94,92	HT
O-02164	2,70	101,27	HT
O-02165	2,70	107,62	HT
O-02168	2,70	109,62	Piastra Mini
O-02166	2,70	113,97	HT
O-02167	2,70	120,32	HT
O-02931V	3,00	45,00	VHT
O-02936V	3,00	53,00	VHT
O-02967A	3,05		HT
O-02904	3,05	6,00	HT
O-02905	3,05	7,00	HT
O-02906	3,05	8,00	HT
O-02907	3,05	9,00	HT
O-02908	3,05	10,00	HT
O-02912	3,05	12,00	HT
O-02913	3,05	13,00	HT
O-02914	3,05	14,00	HT
O-02916	3,05	15,00	HT
O-02917	3,05	16,00	HT
O-02918	3,05	17,00	HT
O-02918A	3,05	18,00	HT
O-02919	3,05	19,00	HT
O-02919A	3,05	20,00	HT
O-02915	3,05	22,00	HT
O-02920A	3,05	23,00	HT
O-02910	3,05	24,00	HT
O-02911	3,05	25,00	HT
O-02921	3,05	26,00	HT
O-02921A	3,05	27,00	HT
O-02922	3,05	28,00	HT
O-02922A	3,05	29,00	HT
O-02929	3,05	30,00	HT
O-02930	3,05	31,00	HT
O-02929A	3,05	31,50	HT
O-02923	3,05	32,00	HT

Codice Code Код	C	d1	Note Remarks Примечания
O-02923A	3,05	33,00	HT
O-02924	3,05	34,00	HT
O-02924A	3,05	35,00	HT
O-02925	3,05	36,00	HT
O-02925V	3,05	36,00	VHT
O-02925A	3,05	37,00	HT
O-02926	3,05	38,00	HT
O-02926A	3,05	39,00	HT
O-02934A	3,05	40,00	VHT
O-02927	3,05	40,00	HT
O-02927A	3,05	41,00	HT
O-02928	3,05	42,00	HT
O-02928A	3,05	43,00	HT
O-02928V	3,05	43,00	VHT
O-02931	3,05	44,00	HT
O-02931A	3,05	45,00	HT
O-02932	3,05	46,00	HT
O-02932A	3,05	47,00	HT
O-02933	3,05	48,00	HT
O-02933A	3,05	49,00	HT
O-02934	3,05	50,00	HT
O-02936	3,05	52,00	HT
O-02901V	3,05	53,00	VHT
O-02936A	3,05	53,00	HT
O-02935	3,05	54,00	HT
O-02937	3,05	55,00	HT
O-02937A	3,05	56,00	HT
O-02938	3,05	57,00	HT
O-02938A	3,05	58,00	HT
O-02939	3,05	59,00	HT
O-02939A	3,05	60,00	HT
O-02940A	3,05	62,00	HT
O-02942	3,05	65,00	HT
O-02942A	3,05	66,00	HT
O-02943A	3,05	68,00	HT
O-02945	3,05	70,00	HT
O-02946	3,05	72,00	HT
O-02946A	3,05	73,00	HT
O-02947	3,05	74,00	HT
O-02950	3,05	75,00	HT
O-02947A	3,05	76,00	HT
O-02948A	3,05	78,00	HT
O-02949	3,05	79,00	HT
O-02949A	3,05	80,00	HT

Codice Code Код	C	d1	Note Remarks Примечания
O-02951A	3,05	82,00	HT
O-02952A	3,05	84,00	HT
O-02952	3,05	85,00	HT
O-02965	3,05	86,00	HT
O-02953V	3,05	86,00	VHT
O-02954	3,05	88,00	HT
O-02955	3,05	90,00	HT
O-02957	3,05	94,00	HT
O-02957A	3,05	95,00	HT
O-02958	3,05	96,00	HT
O-02959	3,05	98,00	HT
O-02960	3,05	100,00	HT
O-02961	3,05	102,00	HT
O-02962	3,05	104,00	HT
O-02962A	3,05	105,00	HT
O-02963	3,05	106,00	HT
O-02964	3,05	108,00	HT
O-02966	3,05	110,00	HT
O-02967	3,05	112,00	HT
O-02968	3,05	114,00	HT
O-02968A	3,05	115,00	HT
O-02969	3,05	116,00	HT
O-02970	3,05	118,00	HT
O-02971	3,05	120,00	HT
O-02981	3,20	40,00	HT
O-02980	3,30	38,00	HT
O-02902	3,53	30,00	HT
O-02213	3,53	31,34	HT
O-02273	3,53	32,00	HT
O-02903	3,53	40,00	HT
O-02276	3,53	205,00	
O-02201	3,60	7,51	HT
O-02202	3,60	9,12	HT
O-02203	3,60	10,69	HT
O-02204	3,60	12,29	HT
O-02205	3,60	13,87	HT
O-02206	3,60	15,47	HT
O-02210	3,60	17,00	HT
O-02271	3,60	18,00	HT
O-02207	3,60	18,64	HT
O-02208	3,60	20,22	HT
O-02209V	3,60	21,82	VHT
O-02209	3,60	21,82	HT
O-02212	3,60	23,40	HT

Min. ordine 10 pezzi Min. order 10 items Мин. заказ 10 штук

HT per alte temperature

for high temperatures

температуростойкие

VHT per altissime temperature

for very high temperatures

сверхтемпературостойкие



Codice Code Код	C	d1	Note Remarks Примечания
O-02216	3,60	24,99	HT
O-02211	3,60	26,00	HT
O-02217	3,60	26,58	HT
O-02218	3,60	28,17	HT
O-02219	3,60	29,75	HT
O-02214	3,60	32,93	HT
O-02274	3,60	34,00	VHT
O-02215	3,60	34,30	HT
O-02220	3,60	36,10	HT
O-02221	3,60	37,69	HT
O-02222	3,60	39,69	HT
O-02223	3,60	40,86	HT
O-02224	3,60	41,28	HT
O-02225	3,60	42,86	HT
O-02226	3,60	44,04	HT
O-02227	3,60	44,45	HT
O-02228	3,60	46,04	HT
O-02230	3,60	47,20	HT
O-02229	3,60	47,63	HT
O-02277	3,60	48,80	HT
O-02231	3,60	49,21	HT
O-02232	3,60	50,39	HT
O-02240	3,60	50,80	HT
O-02233	3,60	52,39	HT
O-02234	3,60	53,57	HT
O-02235	3,60	53,98	HT
O-02236	3,60	55,56	HT
O-02236V	3,60	55,56	VHT
O-02242	3,60	56,75	HT
O-02237	3,60	57,15	HT
O-02238	3,60	58,74	HT
O-02239	3,60	59,92	HT
O-02243	3,60	60,33	HT
O-02244	3,60	61,91	HT
O-02245	3,60	63,09	HT
O-02246	3,60	63,50	HT
O-02247	3,60	65,09	HT
O-02248	3,60	66,27	HT
O-02249	3,60	66,68	HT
O-02250	3,60	68,26	HT
O-02251	3,60	69,44	HT
O-02252	3,60	69,85	HT
O-02253	3,60	71,44	HT
O-02254	3,60	72,62	HT

Codice Code Код	C	d1	Note Remarks Примечания
O-02260	3,60	73,03	HT
O-02255	3,60	74,61	HT
O-02256	3,60	75,80	HT
O-02257	3,60	78,97	HT
O-02258	3,60	82,14	HT
O-02259V	3,60	85,32	VHT
O-02259	3,60	85,32	HT
O-02261	3,60	88,50	HT
O-02262	3,60	91,67	HT
O-02241	3,60	94,84	HT
O-02263	3,60	98,02	HT
O-02264	3,60	101,20	HT
O-02265	3,60	104,40	HT
O-02266	3,60	107,50	HT
O-02267	3,60	110,70	HT
O-02268	3,60	113,90	HT
O-02269	3,60	117,10	HT
O-02270	3,60	120,20	HT
O-02272	3,60	123,42	HT
O-02275	3,60	130,00	HT
O-03001	4,10	10,00	HT
O-03002	4,10	11,00	HT
O-03003	4,10	12,00	HT
O-03006	4,10	15,00	HT
O-03007	4,10	16,00	HT
O-03008	4,10	17,00	HT
O-03009	4,10	18,00	HT
O-03012	4,10	20,00	HT
O-03010	4,10	22,00	HT
O-03020	4,10	24,00	HT
O-03015	4,10	25,00	HT
O-03017	4,10	27,00	HT
O-03018	4,10	28,00	HT
O-03019	4,10	29,00	HT
O-03021	4,10	30,00	HT
O-03023	4,10	32,00	HT
O-03024	4,10	33,00	HT
O-03025	4,10	34,00	HT
O-03026	4,10	35,00	HT
O-03027	4,10	36,00	HT
O-03029	4,10	38,00	HT
O-03040	4,10	39,00	HT
O-03030	4,10	40,00	HT
O-03032	4,10	42,00	HT

Codice Code Код	C	d1	Note Remarks Примечания
O-03033	4,10	43,00	HT
O-03034	4,10	44,00	HT
O-03035	4,10	45,00	HT
O-03037	4,10	47,00	HT
O-03038	4,10	48,00	HT
O-03039	4,10	49,00	HT
O-03041	4,10	50,00	HT
O-03044	4,10	53,00	HT
O-03045	4,10	54,00	HT
O-03042	4,10	64,00	HT
O-03043	4,10	90,00	HT
O-03084	4,10	94,00	HT
O-03085	4,50	19,00	HT
O-02281	5,05	26,00	HT
O-03004	5,05	27,00	HT
O-02282	5,05	27,00	HT
O-02287	5,05	32,00	
O-02285	5,05	33,00	
O-02286	5,05	35,00	
O-02283	5,05	36,00	HT
O-03005	5,05	36,00	HT
O-02284	5,05	56,70	HT
O-02280	5,30	21,82	HT
O-02330	5,30	31,10	HT
O-02326	5,30	34,29	HT
O-02325	5,30	40,64	HT
O-02331	5,30	43,82	
O-02327	5,30	56,52	HT
O-02328	5,30	59,69	HT
O-02329	5,30	62,87	HT
O-02332	5,30	73,00	HT
O-02333	5,30	85,09	HT
O-02401	7,10	49,00	HT

O-ring a sezione quadra

O-rings, square section

Резиновые кольца квадратного сечения

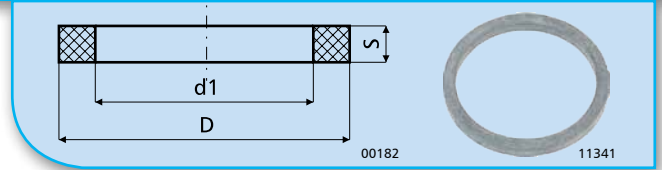

Codice Code Код	Min Ord Мин. коли- чество заказа	S	d1	D	Colore Colour Цвет	Descrizione per utilizzo Use remarks Примечания
● O-07022	10	1,40	11,50	14,20	nero <i>black</i>	Mercedes
● O-07023	10	1,40	13,00	15,80	nero <i>black</i>	Mercedes
● O-07025	10	1,40	14,00	17,00	nero <i>black</i>	Mercedes
● O-07024	10	1,40	16,00	19,00	nero <i>black</i>	Mercedes
O-07000	10	1,75	23,80	27,00	nero <i>black</i>	Land/Range Rover 3/4 Bulloni
O-07008	10	1,80	46,00	51,00	nero <i>black</i>	Trattori e macchine agricole TRW
O-07013	10	2,00	26,70	31,00	nero <i>black</i>	Citroen CX
● O-07020	10	2,30	49,20	54,00	nero <i>black</i>	Jaguar
O-07017	10	2,50	21,50	26,50	nero <i>black</i>	
O-07016	10	2,50	22,00	26,80	nero <i>black</i>	
O-07018	10	2,50	39,20	44,20	nero <i>black</i>	Jaguar
O-07014	10	2,54	26,70	31,70	nero <i>black</i>	Citroen CX
O-07015	10	2,54	35,30	40,80	nero <i>black</i>	Citroen CX
O-07011	10	2,60	24,00	29,00	nero <i>black</i>	Citroen
● O-07019	10	2,60	32,40	37,60	nero <i>black</i>	Jaguar
O-07009	10	2,60	39,20	45,00	nero <i>black</i>	
O-07001	10	2,60	40,40	45,40	nero <i>black</i>	Granada MK III - Pignone-
● O-07021	10	2,60	55,00	60,00	nero <i>black</i>	Jaguar
O-07002	10	2,65	52,00	57,00	rosso mattone <i>brown</i>	Land/Range Rover 3/4 Bulloni
O-07003	10	2,65	56,80	62,40	nero <i>black</i>	Land/Range Rover 3 Bulloni
O-07004	10	3,50	63,00	70,00	nero <i>black</i>	Land/Range Rover 4 Bulloni
O-07005	10	3,50	70,20	76,20	nero <i>black</i>	Land/Range Rover 3 Bulloni
O-07006	10	3,50	73,50	79,50	rosso mattone <i>brown</i>	Land/Range Rover 4 Bulloni
O-07007	10	3,50	90,00	97,10	nero <i>black</i>	Land/Range Rover 3 Bulloni
O-07012	10	3,90	17,60	22,50	nero <i>black</i>	Citroen (conico)
O-07010	10	4,00	20,00	26,50	nero <i>black</i>	Citroen

Quadring

X-rings

Кольца X-образного сечения

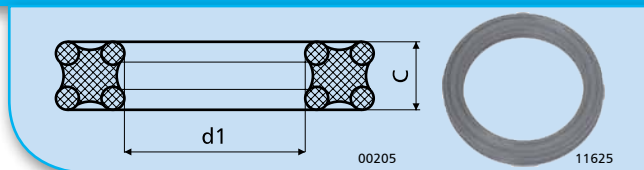

Codice Code Код	Min Ord Мин. коли- чество заказа	C	d1	Descrizione per utilizzo Use remarks Примечания
		Размеры		
O-08006	10	1,83	10,52	
O-08007	10	1,98	11,89	
O-08008	10	2,08	13,46	
• O-08022	10	2,15	42,00	
O-08009	10	2,21	16,36	
O-08010	10	2,46	17,93	
O-08011	10	2,46	19,18	
O-08002	10	2,53	66,80	
O-08012	10	2,62	7,59	
O-08013	10	2,62	9,19	
O-08014	10	2,62	10,77	
O-08015	10	2,62	12,37	
O-08016	10	2,62	13,94	
O-08017	10	2,62	15,54	
O-08018	10	2,62	17,12	
O-08019	10	2,62	18,72	
O-08003	10	2,62	61,60	
• O-08023	10	2,80	11,70	
O-08005	10	2,90	12,60	Pompa
• O-08020	10	3,00	16,80	Pompa
O-08001	10	3,53	20,00	
O-08004	10	3,53	75,79	
• O-08021	10	4,10	67,00	

Sfere in acciaio

Steel balls

Стальные шары

S

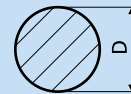

00111

11092

Codice Code Код	Min Ord Мин. коли- чество заказа	D Диаметр	Descrizione per utilizzo Use remarks Примечания
● S-01500	100	1,500	
● S-02018	100	2,018	
S-02023	100	2,023	
S-04001	100	4,001	Auto e fuoristrada
S-05000	100	5,000	Auto e fuoristrada
● S-05100	100	5,100	
● S-05150	100	5,150	
● S-05200	100	5,200	
S-05536	100	5,536	Auto e fuoristrada giapponese
S-05541	100	5,541	Auto e fuoristrada giapponese
S-05546	100	5,546	Auto e fuoristrada giapponese
● S-05552	100	5,552	Auto e fuoristrada giapponese
● S-05554	100	5,554	Auto e fuoristrada giapponese
S-05555	100	5,555	Auto e fuoristrada giapponese
S-05556	100	5,556	Auto e fuoristrada giapponese
S-05557	100	5,557	Auto e fuoristrada giapponese
S-05558	100	5,558	Auto e fuoristrada giapponese
● S-05559	100	5,559	Auto e fuoristrada giapponese
S-05560	100	5,560	Auto e fuoristrada giapponese
● S-05564	100	5,564	Auto e fuoristrada giapponese
S-05565	100	5,565	Auto e fuoristrada giapponese
● S-05569	100	5,569	Auto e fuoristrada giapponese
S-05570	100	5,570	Auto e fuoristrada giapponese
S-05574	100	5,574	Auto e fuoristrada
S-05575	100	5,575	Auto e fuoristrada giapponese
● S-05579	100	5,579	Auto e fuoristrada giapponese
S-05580	100	5,580	Auto e fuoristrada giapponese
S-05585	100	5,585	Auto e fuoristrada giapponese
S-05590	100	5,590	Auto e fuoristrada giapponese
S-05594	100	5,594	Auto e fuoristrada giapponese
S-05598	100	5,598	Auto e fuoristrada giapponese
S-05601	100	5,601	Auto e fuoristrada giapponese
S-05606	100	5,606	Auto e fuoristrada giapponese
S-05610	100	5,610	Auto e fuoristrada giapponese
● S-05620	100	5,620	
● S-05640	100	5,640	
S-05994	100	5,994	Auto e fuoristrada giapponese
S-06351	100	6,351	Auto e fuoristrada giapponese
S-06352	100	6,352	Auto e fuoristrada giapponese
S-06354	100	6,354	Auto e fuoristrada giapponese
S-06356	100	6,356	Auto e fuoristrada giapponese
S-06358	100	6,358	Auto e fuoristrada giapponese

Codice Code Код	Min Ord Мин. коли- чество заказа	D Диаметр	Descrizione per utilizzo Use remarks Примечания
S-06359	100	6,359	Auto e fuoristrada giapponese
● S-06360	100	6,360	
S-06362	100	6,362	Auto e fuoristrada giapponese
S-06365	100	6,365	Auto e fuoristrada giapponese
S-06368	100	6,368	Auto e fuoristrada giapponese
S-06371	100	6,371	Auto e fuoristrada giapponese
S-06374	100	6,374	Auto e fuoristrada giapponese
S-06377	100	6,377	Auto e fuoristrada giapponese
S-06380	100	6,380	Auto e fuoristrada giapponese
S-06384	100	6,384	Auto e fuoristrada giapponese
● S-06900	100	6,900	
● S-06985	100	6,985	
● S-06986	100	6,986	
● S-06987	100	6,987	
● S-06988	100	6,988	
S-06989	100	6,989	Camion ZF / ZF Trucks
S-06990	100	6,990	Camion ZF / ZF Trucks
S-06991	100	6,991	Camion ZF / ZF Trucks
S-06992	100	6,992	Camion ZF / ZF Trucks
S-06993	100	6,993	Camion ZF / ZF Trucks
S-06994	100	6,994	Camion ZF / ZF Trucks
S-06995	100	6,995	Camion ZF / ZF Trucks
S-06996	100	6,996	Camion ZF / ZF Trucks
S-06997	100	6,997	Camion ZF / ZF Trucks
S-06998	100	6,998	Camion ZF / ZF Trucks
S-06999	100	6,999	Camion ZF / ZF Trucks
S-07000	100	7,000	Camion ZF / ZF Trucks
S-07001	100	7,001	Camion ZF / ZF Trucks
S-07002	100	7,002	Camion ZF / ZF Trucks
S-07003	100	7,003	Camion ZF / ZF Trucks
S-07004	100	7,004	Camion ZF / ZF Trucks
S-07005	100	7,005	Camion ZF / ZF Trucks
S-07006	100	7,006	Camion ZF / ZF Trucks
S-07007	100	7,007	Camion ZF / ZF Trucks
S-07008	100	7,008	Camion ZF / ZF Trucks
S-07009	100	7,009	Camion ZF / ZF Trucks
S-07010	100	7,010	Camion ZF / ZF Trucks
S-07011	100	7,011	Camion ZF / ZF Trucks
S-07012	100	7,012	Camion ZF / ZF Trucks
S-07013	100	7,013	Camion ZF / ZF Trucks
S-07014	100	7,014	Camion ZF / ZF Trucks
S-07015	100	7,015	Camion ZF / ZF Trucks

Sfere in acciaio

Steel balls

Стальные шары



Codice Code Код	Min Ord Мин. коли- чество заказа	D Диаметр	Descrizione per utilizzo Use remarks Примечания
S-07016	100	7,016	Camion ZF / ZF Trucks
S-07017	100	7,017	Camion ZF / ZF Trucks
S-07018	100	7,018	Camion ZF / ZF Trucks
S-07020	100	7,020	Camion ZF / ZF Trucks
S-07021	100	7,021	Camion ZF / ZF Trucks
S-07022	100	7,022	Camion ZF / ZF Trucks
S-07023	100	7,023	Camion ZF / ZF Trucks
S-07025	100	7,025	Camion ZF / ZF Trucks
S-07027	100	7,027	Camion ZF / ZF Trucks
S-07030	100	7,030	Camion ZF / ZF Trucks
S-07033	100	7,033	Camion ZF / ZF Trucks
S-07036	100	7,036	Camion ZF / ZF Trucks
S-07040	100	7,040	Camion ZF / ZF Trucks
S-07044	100	7,044	Camion ZF / ZF Trucks
S-07047	100	7,047	Camion ZF / ZF Trucks
S-07050	100	7,050	Camion ZF / ZF Trucks
S-07055	100	7,055	Camion ZF / ZF Trucks
S-07060	100	7,060	Camion ZF / ZF Trucks
S-07065	100	7,065	Camion ZF / ZF Trucks
S-07070	100	7,070	Camion ZF / ZF Trucks
S-07075	100	7,075	Camion ZF / ZF Trucks
S-07080	100	7,080	Camion ZF / ZF Trucks
S-07085	100	7,085	Camion ZF / ZF Trucks
S-07090	100	7,090	Camion ZF / ZF Trucks
S-07095	100	7,095	Camion ZF / ZF Trucks
S-07105	100	7,105	Camion ZF / ZF Trucks
S-07110	100	7,110	Camion ZF / ZF Trucks
S-07115	100	7,115	Camion ZF / ZF Trucks
S-07120	100	7,120	Camion ZF / ZF Trucks
S-07125	100	7,125	Camion ZF / ZF Trucks
S-07132	100	7,132	Camion ZF / ZF Trucks
S-07134	100	7,134	Camion TRW / TRW Trucks
S-07135	100	7,135	
S-07136	100	7,136	Camion TRW / TRW Trucks
S-07137	100	7,137	Camion TRW / TRW Trucks
S-07138	100	7,138	Camion TRW / TRW Trucks
S-07139	100	7,139	Camion TRW / TRW Trucks
S-07140	100	7,140	Jeep Cherokee
S-07141	100	7,141	Jeep Cherokee
S-07142	100	7,142	Jeep Cherokee
S-07143	100	7,143	Jeep Cherokee
S-07144	100	7,144	Jeep Cherokee
S-07145	100	7,145	Jeep Cherokee
S-07146	100	7,146	Jeep Cherokee
S-07147	100	7,147	Jeep Cherokee
S-07148	100	7,148	Jeep Cherokee
S-07149	100	7,149	Jeep Cherokee
S-07150	100	7,150	Jeep Cherokee
S-07151	100	7,151	Jeep Cherokee

Codice Code Код	Min Ord Мин. коли- чество заказа	D Диаметр	Descrizione per utilizzo Use remarks Примечания
S-07152	100	7,152	Jeep Cherokee
S-07153	100	7,153	Jeep Cherokee
S-07154	100	7,154	Jeep Cherokee
S-07155	100	7,155	Jeep Cherokee
S-07156	100	7,156	Jeep Cherokee
S-07157	100	7,157	Jeep Cherokee
S-07158	100	7,158	Jeep Cherokee
S-07159	100	7,159	Jeep Cherokee
S-07160	100	7,160	Jeep Cherokee
S-07164	100	7,164	Jeep Cherokee
S-07165	100	7,165	Jeep Cherokee
S-07169	100	7,169	Jeep Cherokee
S-07170	100	7,170	Jeep Cherokee
S-07174	100	7,174	Jeep Cherokee
S-07175	100	7,175	Jeep Cherokee
S-07180	100	7,180	TRW
S-07185	100	7,185	TRW
S-07189	100	7,189	Auto e fuoristrada
S-07190	100	7,190	TRW
S-07195	100	7,195	TRW
S-07200	100	7,200	TRW
S-07205	100	7,205	TRW
S-07210	100	7,210	TRW
S-07215	100	7,215	TRW
S-07220	100	7,220	TRW
S-07230	100	7,230	TRW
S-07240	100	7,240	TRW
S-07250	100	7,250	TRW
S-07260	100	7,260	TRW
S-07265	100	7,265	TRW
S-07270	100	7,270	TRW
S-07275	100	7,275	TRW
S-07280	100	7,280	TRW
S-07285	100	7,285	TRW
S-07290	100	7,290	TRW
S-07295	100	7,295	TRW
S-07300	100	7,300	TRW
S-07305	100	7,305	TRW
S-07310	100	7,310	TRW
S-07315	100	7,315	TRW
S-07320	100	7,320	TRW
S-07325	100	7,325	TRW
S-07330	100	7,330	TRW
S-07335	100	7,335	TRW
S-07340	100	7,340	TRW
S-07343	100	7,343	TRW
S-07350	100	7,350	TRW
S-07355	100	7,355	TRW
S-07360	100	7,360	TRW



Sfere in acciaio

Steel balls

Стальные шары

Codice Code Код	Min Ord Мин. колич- ество заказа	D Диаметр	Descrizione per utilizzo Use remarks Примечания
S-07365	100	7,365	TRW
S-07370	100	7,370	TRW
S-07375	100	7,375	TRW
S-07380	100	7,380	TRW
S-07385	100	7,385	TRW
S-07390	100	7,390	TRW
S-07395	100	7,395	TRW
S-07400	100	7,400	TRW
S-07405	100	7,405	TRW
S-07415	100	7,415	TRW
S-07425	100	7,425	TRW
S-07435	100	7,435	TRW
S-07445	100	7,445	TRW
S-07450	100	7,450	TRW
S-07455	100	7,455	TRW
S-07465	100	7,465	TRW
S-07475	100	7,475	TRW
S-07485	100	7,485	TRW
S-07495	100	7,495	TRW
S-07500	100	7,500	TRW
S-07505	100	7,505	TRW
• S-07560	100	7,560	
S-07940	100	7,940	Speciali ZF/TRW/Riva Calzoni
S-07945	100	7,945	Speciali ZF/TRW/Riva Calzoni
• S-07947	100	7,947	
• S-07948	100	7,948	
S-07950	100	7,950	Speciali ZF/TRW/Riva Calzoni
• S-07953	100	7,953	
S-07955	100	7,955	Speciali ZF/TRW/Riva Calzoni
• S-07958	100	7,958	
S-07960	100	7,960	Speciali ZF/TRW/Riva Calzoni
S-07965	100	7,965	Speciali ZF/TRW/Riva Calzoni
S-07970	100	7,970	Speciali ZF/TRW/Riva Calzoni
S-07975	100	7,975	Speciali ZF/TRW/Riva Calzoni
S-07980	100	7,980	Speciali ZF/TRW/Riva Calzoni
S-07985	100	7,985	Speciali ZF/TRW/Riva Calzoni
S-07989	100	7,989	ZF
S-07990	100	7,990	ZF
S-07991	100	7,991	ZF
S-07992	100	7,992	ZF
S-07993	100	7,993	ZF
S-07994	100	7,994	ZF
S-07995	100	7,995	ZF
S-07996	100	7,996	ZF
S-07997	100	7,997	ZF
S-07998	100	7,998	ZF
S-07999	100	7,999	ZF
S-08000	100	8,000	ZF
S-08001	100	8,001	ZF

Codice Code Код	Min Ord Мин. колич- ество заказа	D Диаметр	Descrizione per utilizzo Use remarks Примечания
S-08002	100	8,002	ZF
S-08003	100	8,003	ZF
S-08004	100	8,004	ZF
S-08005	100	8,005	ZF
S-08006	100	8,006	ZF
S-08007	100	8,007	ZF
S-08008	100	8,008	ZF
S-08009	100	8,009	ZF
S-08010	100	8,010	ZF
S-08011	100	8,011	ZF
S-08012	100	8,012	ZF
S-08013	100	8,013	ZF
S-08014	100	8,014	ZF
S-08015	100	8,015	ZF
S-08016	100	8,016	auto e fuoristrada
S-08017	100	8,017	ZF
S-08018	100	8,018	ZF
S-08020	100	8,020	ZF
S-08023	100	8,023	ZF
S-08024	100	8,024	ZF
S-08027	100	8,027	ZF
S-08030	100	8,030	ZF
S-08033	100	8,033	ZF
S-08036	100	8,036	ZF
S-08040	100	8,040	ZF
S-08045	100	8,045	ZF
S-08050	100	8,050	ZF
S-08055	100	8,055	ZF
S-08060	100	8,060	ZF
S-08065	100	8,065	ZF
S-08070	100	8,070	ZF
S-08075	100	8,075	ZF
S-08080	100	8,080	ZF
S-08085	100	8,085	ZF
S-08090	100	8,090	ZF
S-08095	100	8,095	ZF
S-08100	100	8,100	ZF
S-08105	100	8,105	ZF
S-08110	100	8,110	ZF
S-08115	100	8,115	ZF
S-08120	100	8,120	ZF
S-08125	100	8,125	Riva Calzoni
S-08130	100	8,130	Riva Calzoni
S-08135	100	8,135	Riva Calzoni
S-08140	100	8,140	Riva Calzoni
S-08145	100	8,145	Riva Calzoni
S-08150	100	8,150	Riva Calzoni
S-08155	100	8,155	Riva Calzoni
S-08160	100	8,160	Riva Calzoni

Sfere in acciaio

Steel balls

Стальные шары



Codice Code Код	Min Ord Мин. коли- чество заказа	D Диаметр	Descrizione per utilizzo Use remarks Примечания
S-08165	100	8,165	Riva Calzoni
S-08170	100	8,170	Riva Calzoni
S-08175	100	8,175	Riva Calzoni
S-08180	100	8,180	Riva Calzoni
S-08185	100	8,185	Riva Calzoni
S-08190	100	8,190	Riva Calzoni
S-08195	100	8,195	Riva Calzoni
S-08200	100	8,200	Riva Calzoni
S-08210	100	8,210	Riva Calzoni
S-08220	100	8,220	Riva Calzoni
S-08230	100	8,230	Riva Calzoni
S-08500	100	8,500	Bendix
• S-08505	100	8,505	
• S-08510	100	8,510	Bendix
• S-08515	100	8,515	
S-08520	100	8,520	Bendix
S-08716	100	8,716	Riva Calzoni
S-08718	100	8,718	Riva Calzoni
S-08720	100	8,720	Riva Calzoni
S-08722	100	8,722	Riva Calzoni
S-08724	100	8,724	Riva Calzoni
S-08726	100	8,726	Riva Calzoni
S-08728	100	8,728	Riva Calzoni
S-08730	100	8,730	Riva Calzoni
S-08732	100	8,732	Riva Calzoni
S-08734	100	8,734	Riva Calzoni
S-08736	100	8,736	Riva Calzoni
S-08738	100	8,738	Riva Calzoni
S-08740	100	8,740	Riva Calzoni
S-08742	100	8,742	Riva Calzoni
S-08744	100	8,744	Riva Calzoni
S-08746	100	8,746	Riva Calzoni
S-08748	100	8,748	Riva Calzoni
S-08750	100	8,750	Riva Calzoni
S-08985	100	8,985	Speciali ZF/TRW/Riva Calzoni
S-08987	100	8,987	Speciali ZF/TRW/Riva Calzoni
S-08989	100	8,989	Speciali ZF/TRW/Riva Calzoni
S-08990	100	8,990	Speciali ZF/TRW/Riva Calzoni
S-08991	100	8,991	Speciali ZF/TRW/Riva Calzoni
S-08992	100	8,992	Speciali ZF/TRW/Riva Calzoni
S-08993	100	8,993	Speciali ZF/TRW/Riva Calzoni
S-08994	100	8,994	Speciali ZF/TRW/Riva Calzoni
S-08995	100	8,995	Speciali ZF/TRW/Riva Calzoni
S-08996	100	8,996	Speciali ZF/TRW/Riva Calzoni
S-08997	100	8,997	Speciali ZF/TRW/Riva Calzoni
S-08998	100	8,998	Speciali ZF/TRW/Riva Calzoni
S-08999	100	8,999	Speciali ZF/TRW/Riva Calzoni
S-09000	100	9,000	Speciali ZF/TRW/Riva Calzoni
S-09001	100	9,001	Speciali ZF/TRW/Riva Calzoni

Codice Code Код	Min Ord Мин. коли- чество заказа	D Диаметр	Descrizione per utilizzo Use remarks Примечания
S-09002	100	9,002	Speciali ZF/TRW/Riva Calzoni
S-09003	100	9,003	Speciali ZF/TRW/Riva Calzoni
S-09004	100	9,004	Speciali ZF/TRW/Riva Calzoni
S-09005	100	9,005	Speciali ZF/TRW/Riva Calzoni
S-09006	100	9,006	Speciali ZF/TRW/Riva Calzoni
S-09007	100	9,007	Speciali ZF/TRW/Riva Calzoni
S-09008	100	9,008	Speciali ZF/TRW/Riva Calzoni
S-09009	100	9,009	Speciali ZF/TRW/Riva Calzoni
S-09010	100	9,010	Speciali ZF/TRW/Riva Calzoni
S-09011	100	9,011	Speciali ZF/TRW/Riva Calzoni
S-09012	100	9,012	Speciali ZF/TRW/Riva Calzoni
S-09013	100	9,013	Speciali ZF/TRW/Riva Calzoni
S-09014	100	9,014	Speciali ZF/TRW/Riva Calzoni
S-09015	100	9,015	Speciali ZF/TRW/Riva Calzoni
S-09018	100	9,018	Speciali ZF/TRW/Riva Calzoni
S-09021	100	9,021	Speciali ZF/TRW/Riva Calzoni
S-09022	100	9,022	Speciali ZF/TRW/Riva Calzoni
S-09024	100	9,024	Speciali ZF/TRW/Riva Calzoni
S-09027	100	9,027	Speciali ZF/TRW/Riva Calzoni
S-09030	100	9,030	Speciali ZF/TRW/Riva Calzoni
S-09033	100	9,033	Speciali ZF/TRW/Riva Calzoni
• S-09522	100	9,522	
S-09525	100	9,525	Speciali ZF/TRW/Riva Calzoni
S-09700	100	9,700	Speciali ZF/TRW/Riva Calzoni
S-09800	100	9,800	Speciali ZF/TRW/Riva Calzoni
S-09900	100	9,900	Speciali ZF/TRW/Riva Calzoni
S-09920	100	9,920	Auto e fuoristrada
S-09922	100	9,922	Auto e fuoristrada
S-09992	100	9,992	Speciali ZF/TRW/Riva Calzoni
S-10000	100	10,000	Speciali ZF/TRW/Riva Calzoni
S-10002	100	10,002	Speciali ZF/TRW/Riva Calzoni
S-10004	100	10,004	Speciali ZF/TRW/Riva Calzoni
S-10100	100	10,100	Speciali ZF/TRW/Riva Calzoni

Tappi e cappucci

Taps and caps

Пробки и заглушки



Tappi non filettati

Unthreaded plugs

Полупрозрачные заглушки без резьбы

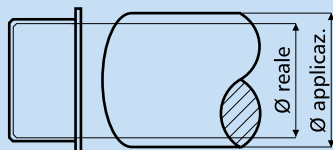

00203



11093

Codice Code Код	Min Ord Мин. количество заказа	Ø	Ø	Utilizzo Use remarks Примечания
		reale	applicaz.	
		Диаметр		
D-02010	200	7,50	8,00	filetti interni idro e pompe
D-02012	200	9,00	10,00	filetti interni idro e pompe
D-02014	200	10,50	12,00	filetti interni idro e pompe
D-02016	200	12,00	12,50	filetti interni idro e pompe
D-02018	200	12,50	14,00	filetti interni idro e pompe
D-02020	200	15,00	16,00	filetti interni idro e pompe
D-02022	200	16,00	17,00	filetti interni idro e pompe
D-02024	200	17,00	18,00	filetti interni idro e pompe

Codice Code Код	Min Ord Мин. количество заказа	Ø	Ø	Utilizzo Use remarks Примечания
		reale	applicaz.	
		Диаметр		
D-02025	200	18,00	18,50	filetti interni idro e pompe
D-02026	200	19,00	20,00	filetti interni idro e pompe
D-02028	200	20,70	22,00	filetti interni idro e pompe
D-02030	200	23,00	24,00	filetti interni idro e pompe
D-02032	100	26,00	27,00	filetti interni idro e pompe
D-02033	100	30,00	31,00	filetti interni idro e pompe
D-02034	100	38,00	39,00	filetti interni idro e pompe
D-02035	10	11,30	12,00	tappo conico di colore rosso Ø9,9/11,3 H10/17

Tappi speciali filettati economy

Special economy threaded plugs

Специальные экономные резьбовые заглушки



11335

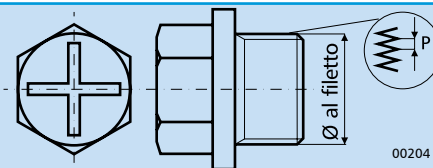

00204

Codice Code Код	Min Ord Мин. количество заказа	Ø	P
		al filetto	
		Размеры	
D-02052	100	8,00	1,00
D-02054	100	10,00	1,00
D-02056	100	12,00	1,50
D-02107	100	12,00	1,00
D-02058	100	12,50	1,50
D-02060	100	14,00	1,50

Codice Code Код	Min Ord Мин. количество заказа	Ø	P
		al filetto	
		Размеры	
D-02062	100	16,00	1,50
D-02064	100	18,00	1,50
D-02066	100	20,00	1,50
D-02068	100	22,00	1,50
D-02070	100	24,00	1,50
D-02072	100	26,00	1,50

Tappi filettati a tenuta speciale

Threaded plugs special tightness

Обособерметичные резьбовые заглушки



11334

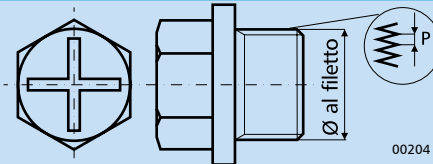

00204

Codice Code Код	Min Ord Мин. количество заказа	Ø	Passo	Testa Shape Форма	Colore Colour Цвет	Da usare con To use with Особенность	Utilizzo Use remarks Примечания
		al filetto					
		Размеры					
D-02200	50	12,00	1,50	Esagonale	Rosso Red	Cacciavite a stella Star screwdriver	filetti interni idro e pompe
D-02201	50	14,00	1,50	Esagonale	Rosso Red	Cacciavite a stella Star screwdriver	filetti interni idro e pompe
D-02202	50	16,00	1,50	Esagonale	Rosso Red	Cacciavite a stella Star screwdriver	filetti interni idro e pompe
D-02203	50	18,00	1,50	Esagonale	Rosso Red	Cacciavite a stella Star screwdriver	filetti interni idro e pompe
D-02204	50	12,00	1,50	Esagonale	Giallo Yellow	Cacciavite fisso Flat screwdriver	filetti interni idro e pompe
D-02205	50	14,00	1,50	Esagonale	Giallo Yellow	Cacciavite fisso Flat screwdriver	filetti interni idro e pompe
D-02206	50	16,00	1,50	Esagonale	Giallo Yellow	Cacciavite fisso Flat screwdriver	filetti interni idro e pompe
D-02207	50	18,00	1,50	Esagonale	Giallo Yellow	Cacciavite fisso Flat screwdriver	filetti interni idro e pompe

Tappi filettati a tenuta super-special

Threaded plugs super special tightness
Особогерметичные резьбовые заглушки



11333

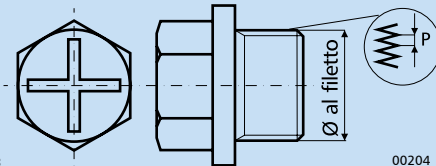

00204

Codice Code Код	Min Ord Мин. коли- чество заказа	Ø	P
		Размеры	
D-02102	100	8,00	1,00
D-02104	100	10,00	1,00
D-02106	100	12,00	1,50
D-02108	100	12,50	1,50
D-02111	100	14,00	1,00
D-02110	100	14,00	1,50

Codice Code Код	Min Ord Мин. коли- чество заказа	Ø	P
		Размеры	
D-02112	100	16,00	1,50
D-02114	100	18,00	1,50
D-02116	100	20,00	1,50
D-02118	100	22,00	1,50
D-02120	100	24,00	1,50
D-02122	100	26,00	1,50

Cappucci di protezione per pignone e tirante

Pignion and tie rods protection caps
Удлиненные полупрозрачные заглушки без резьбы

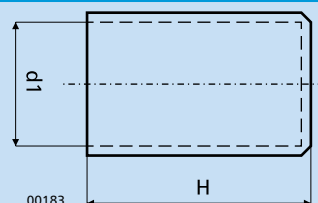

00183



11336

Codice Code Код	Min Ord Мин. коли- чество заказа	d1	H	Colore Colour Цвет	Descrizione per utilizzo Use remarks Примечания
		Размеры			
D-02152	50	12,00	20,00		
D-02170	50	12,00	38,00	rosso red	in plastica morbida - Ford
D-02171	50	13,00	38,00	rosso red	in plastica morbida - Ford
D-02155	50	14,00	20,00		
D-02154	50	14,00	30,00		
D-02169	50	14,30	38,00	nero black	in plastica morbida
D-02168	50	15,50	25,40	nero black	in plastica morbida
D-02157	50	16,00	22,00		
D-02156	50	16,00	40,00		
D-02167	50	17,50	38,00	nero black	in plastica morbida
D-02159	50	18,00	20,00		
D-02158	50	18,00	38,00		
• D-02172	50	19,05	30,16	rosso red	in plastica dura
D-02166	50	20,00	20,00		
D-02165	50	20,00	38,00		



Cappucci di protezione a fungo

Mushroom-shaped protection caps
Грибкообразные колпачки



Codice Code Код	Min Ord Мин. количество заказа	Ø	Ø	Colore Colour Цвет
		min	MAX	
Размеры				
D-02403	50	6,00	12,00	Arancione Orange
D-02400	50	6,00	20,00	Rosso Red
D-02401	50	6,00	20,00	Blu Blue
D-02402	50	6,00	20,00	Giallo Yellow

Codice Code Код	Min Ord Мин. количество заказа	Ø	Ø	Colore Colour Цвет
		min	MAX	
Размеры				
D-02404	50	12,00	16,00	Arancione Orange
D-02405	50	20,00	25,00	Arancione Orange
D-02406	50	32,00	40,00	Arancione Orange
D-02407	50	40,00	50,00	Rosso Red



Sottotappi in gomma

Underplugs in rubber
Заглушки из резины



Codice Code Код	Min Ord Мин. количество заказа	d1	F	Posizione linguetta Tab position Позиция вкладки
		Размеры		
D-02604	10	7,50	M8	orizzontale horizontal
D-02605	10	9,50	M10	orizzontale horizontal
D-02600	10	9,50	M10	verticale vertical
D-02606	10	11,50	M12	orizzontale horizontal
D-02601	10	11,50	M12	verticale vertical
D-02602	10	12,80	M14	verticale vertical
D-02607	10	13,20	M14	orizzontale horizontal
D-02603	10	15,20	M16	verticale vertical
D-02608	10	15,50	M16	orizzontale horizontal
D-02609	10	17,00	M18	orizzontale horizontal



Tappi per kit cambio

Plugs for gear kits
Заглушки для рулевых редукторов



Codice Code Код	Min Ord Мин. количество заказа	Utilizzo Use remarks Примечания
D-02302	50	per kit cambio Mercedes Classe E



Piatti di supporto

Support plates
Опорные пластины



Codice Code Код	Min Ord Мин. количество заказа	Utilizzo Use remarks Примечания
D-02300	2	Piatto di supporto
D-02301	2	Piatto di supporto

Cuscinetti, ghiera di blocco e molle di torsione

Bearings, threaded rings and torsion springs X-rings

Подшипники и стопорные кольца распределителей



Cuscinetti a rullini

Needle roller bearings
Игольчатые подшипники

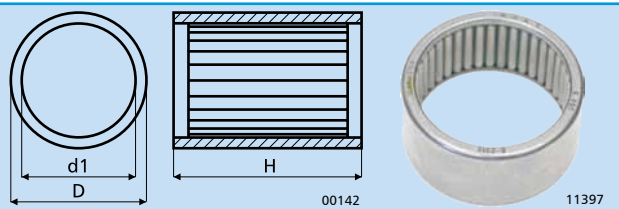

Codice Code Код	Min Ord Мин. коли- чество заказа	d1	D	H	Descrizione per utilizzo Use remarks Примечания
H-07548	2	8,50	19,50	10,50	cuscinetto per pompa elettrica Clio/Peugeot, dimensioni ridotte (vedi * NOTA)
H-07547	2	9,00	19,50	10,50	cuscinetto per pompa elettrica Clio/Peugeot, dimensioni ridotte (vedi * NOTA)
H-07546	2	9,50	19,50	10,50	cuscinetto per pompa elettrica Clio/Peugeot, dimensioni ridotte (vedi * NOTA)
H-07544	2	10,00	19,50	10,55	cuscinetto per pompa elettrica Clio/Peugeot, dimensioni originali (vedi * NOTA)
• H-07562	2	11,00	17,00	12,00	Cuscinetti a rullini Ø11x17 H12 per Porsche 944
H-07535	2	12,00	18,00	12,00	distributore Alfa159 a spilli, aperto
H-07554	2	12,00	18,00	12,00	VW Golf MKIV, chiuso
H-07553	2	13,00	19,00	12,00	distributore BMW
H-07512	2	14,00	20,00	29,00	pignone Jaguar J40
• H-07559	2	19,05	34,30	6,30	Cuscinetto F.Ducato
H-07539	2	20,00	26,00	10,00	Saginaw 800
H-07537	2	20,90	38,60	6,70	distributore Ford
• H-07564	2	25,00	34,00	5,90	
H-07526	2	26,00	36,00	6,00	Man ZF
H-07540	2	28,60	35,00	25,40	Saginaw 600
H-07538	2	31,75	41,30	31,70	Saginaw 800
H-07501	2	31,80	38,10	9,60	Rover 820
H-07523	2	32,00	38,00	19,00	Rang Rover 4/6 Bolt u.t. (BASSI)
H-07517	2	32,00	38,00	20,00	Rang Rover 4/6 Bolt u.t.
H-07543	2	32,00	38,00	25,30	Saginaw
H-07516	2	32,00	38,00	31,70	Rang Rover 4/6 Bolt u.t.
H-07522	2	32,00	38,00	31,70	Rang Rover 4/6 Bolt u.t. (ALTI)
H-07520	2	45,00	61,00	21,00	Mercedes LS4
H-07529	2	45,00	61,00	21,00	Mercedes LS4
• H-07560	2	51,00	65,00	31,70	Sheppard M100 a settore
H-07527	2	52,00	72,00	20,40	Mercedes LS6
H-07528	2	56,00	78,00	21,40	Mercedes LS8
H-07530	2	56,00	80,00	29,30	Mercedes LS6
H-07531	2	56,00	80,00	29,30	Mercedes LS6
H-07532	2	56,00	80,00	29,30	Mercedes LS8

* **NOTA:** Questi 3 cuscinetti sono stati creati per risolvere in maniera definitiva le problematiche dei rotori interni. Quando il cuscinetto è rovinato, è rovinata anche la sede dell'albero del rotore, che risulta conica. Per risolvere tale problema è necessario ridurre il Ø eliminando le righe esterne che creano rumori e ingrippature. I diametri alternativi sono:

Ø9,50, codice H-07546

Ø9,00, codice H-07547

Ø8,50, codice H-07548

Qualora invece l'albero si presenti in condizioni ottimali, è sufficiente sostituire il cuscinetto utilizzando il Ø10, codice H-07535.

* **NOTE:** These 3 bearings have been produced to definitively solve the problems occurring with the internal rotors. When the bearing is damaged, the rotor shaft place is damaged too: it's scratched and conical. To solve this problem you have to reduce the Ø, cancelling the external lines which cause noise and seizing-up. Alternative diameters are

Ø9,50, code H-07546

Ø9,00, code H-07547

Ø8,50, code H-07548

If the shaft is in optimal conditions, you can no doubt only change the bearing, using the one with Ø10 code H-07535.

ПРИМЕЧАНИЕ: Эти три подшипника изготовлены для окончательного решения проблем, возникающих валами роторов.

Альтернативные диаметры:

Ø9,5, код H-07546

Ø9,0, код H-07547

Ø8,5, код H-07548

Если вал в номинальном размере, то можно использовать подшипник с Ø10, код H-07544.

Cuscinetti a sfere

Radial ball bearings

Шариковые подшипники

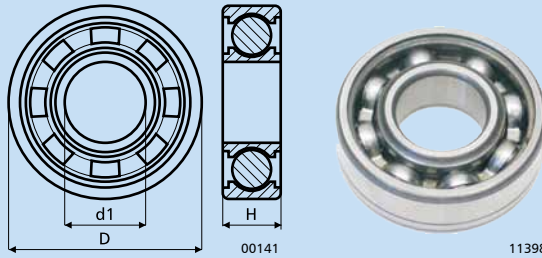

00141

11398

Codice Code Код	Min Ord Мин. коли- чество заказа	d1	D	H	Descrizione per utilizzo Use remarks Примечания
		Размеры			
H-07552	2	10,00	26,00	8,00	pompa elettrica Kangoo / Motore sterzo elettr. Punto, Grande Punto, 500, Panda, Lancia Y, Alfa Mito, Opel Corsa D
• H-07552M	2	10,00	26,00	8,00	pompa elettrica Kangoo / Motore sterzo elettr. Punto, Grande Punto, 500, Panda, Lancia Y, Alfa Mito, Opel Corsa D
H-07536	2	10,00	30,00	8,00	Pignone basso - Chrysler
• H-07557	2	10,00	30,00	9,00	cuscinetto sup. piantone Opel Corsa B/C per vite senza fine
H-07556	2	12,00	28,00	8,00	a sfera Mini
H-07550	2	12,00	32,00	10,00	Vauxhall Cavalier
• H-07558	2	12,00	32,00	10,00	cuscinetto inferiore piantone Opel Corsa B/C per vite senza fine
• H-07563	2	12,70	28,60	8,00	
H-07549	2	15,00	32,00	9,00	Triumph
H-07534	2	15,00	35,00	11,00	
H-07500	2	15,00	38,00	12,00	Pompa Honda
H-07551	2	15,80	39,60	11,00	H6,8/11 Ford Granada
H-07555	2	17,00	35,00	10,00	a sfere
H-07502	2	17,00	40,00	12,00	
• H-07561	2	25,00	47,00	8,00	idroguida Renault Scenic
H-07545	2	45,60	63,50	5,50	scatola guida TRW

Cuscinetti a tenuta assiale

Axial bearings

Конические упорно-радиальные подшипники

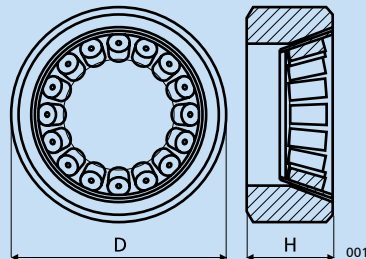

00143

11399

Codice Code Код	Min Ord Мин. коли- чество заказа	D	H	Descrizione per utilizzo Use remarks Примечания
		Размеры		
H-07505	2	38,10	7,70	Ford-Transit-Opel-Chevrolet-Volkswagen-
H-07504	2	40,50	11,10	Land Rover-Santana-Rover
H-07515	2	50,00	20,00	
H-07514	2	55,50	12,00	
H-07533	2	55,70	13,40	Vite LT35
H-07513	2	62,00	12,00	
H-07510	2	69,90	23,30	Avia-Ebro-Fiat-Man Pegaso-Sava-Volvo-

Cuscinetti, ghiera di blocco e molle di torsione

Bearings, threaded rings and torsion springs

Подшипники и стопорные кольца распределителей



Ghiere di blocco fermo cuscinetto

Stopping threaded rings for bearings

Фиксатор гайки подшипника

Codice Code Код	Min Ord Мин. количество заказа	d1			D	H	Descrizione per utilizzo Use remarks Примечания
		Размеры					
● H-04000	2	85,00	105,00	11,00			ghiera blocco fermo cuscinetto per veicoli pesanti Man TGA

Cuscinetti generici per idroguida e pompe

Generic bearings for power steering and pumps

Подшипники для агрегатов рулевого управления с гидроусилителем и насосов



11097

Codice Code Код	Min Ord Мин. количество заказа	d1			D	h1	H	Descrizione per utilizzo Use remarks Примечания
		Размеры						
H-07503	2	30,20	52,00				13,70	Seat/Ebro
H-07541	2	31,20	45,00	2,40			4,00	Distributore superiore (da abbinare a H-07542)
H-07542	2	32,20	44,70				2,00	Rondella da abbinare al cuscinetto H-07541
H-07507	2	33,60	49,20				19,00	Lancia-Mercedes-Volvo-Ebro-Sava-Ford-
H-07508	2	34,20	44,50				9,50	Lancia-Mercedes-Volvo-Ebro-Saab-Ford-
H-07509	2	36,60	49,20				11,50	Dodge-International O.M.-Peugeot-Volvo-
H-07511	2	37,20	55,50				8,80	O.M. 50
H-07506	2	38,40	57,10				17,10	International O.M.-Peugeot-Volvo-
H-07518	2	52,00	72,00				20,40	Mercedes LS6
H-07519	2	56,00	78,00				21,40	Mercedes LS8
H-07521	2	56,00	80,00				29,30	Mercedes LS4
H-07524	2		20,10				5,00	Rover 820
H-07525	2		20,10				7,00	Rover 820

Molle di torsione pignone in acciaio speciale

Pignon torsion springs in special steel

Специальные стопорные кольца распределителей

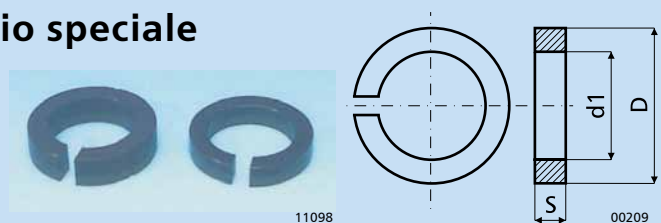

11098

00209

Codice Code Код	Min Ord Мин. количество заказа	d1			D	H	Descrizione per utilizzo Use remarks Примечания	
		Размеры						
H-01900	2	20,10	29,40				5,00	Rover 820
H-01901	2	20,10	29,40				7,00	Rover 820
● H-01902	2		6,50				28,00	Mercedes LS3 (filo 1,6)
● H-01903	2		4,80				14,00	Nissan Patrolv (filo 1)

Camicie di modifica per distributori senza forature

Liners to modify distributors without drilling

Гильзы для распределительной части корпуса рулевой рейки

R

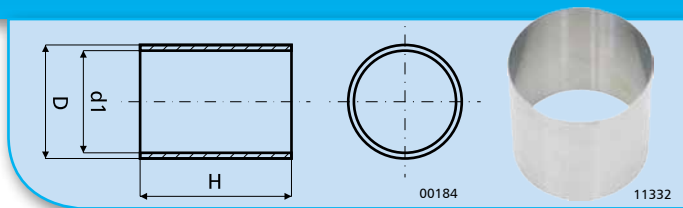

Codice Code Код	Min Ord Мин. коли- чество заказа	d1	D	H	Descrizione per utilizzo Use remarks Примечания
		Размеры			
R-08007	2	30,15	31,50	36,50	
R-08002	2	30,15	31,70	36,50	Volvo 240/260/740/760 - VW Golf-Sierra-Montego
R-08014	2	38,10	38,95	37,00	per distributori senza forature Ø38,1 x 38,95 H 37
R-08004	2	38,10	38,95	48,80	Bmw 325i (ZF)
R-08012	2	38,10	38,95	56,50	Ford Transit/Volvo/Bmw (ZF)
R-08005	2	38,10	38,99	48,77	Volvo 740/760 (ZF)
R-08008	2	37,49 / 37,57	39,36	57,15	
R-08011	2	37,49 / 37,57	39,36	57,15	
R-08001	2	37,72 / 37,80	39,44	41,90	Jaguar XJ40
R-08000	2	37,49 / 37,57	39,44	60,96	Saab 900 / 9000
R-08010	2	38,15	39,75	49,60	Con scarico interno Ø38,6 H7
R-08006	2	38,02	39,76	40,64	Ford Mondeo / Contour -
R-08003	2	38,23	39,76	51,74	Bmw 318i/325i -Volvo 240/260 (Pignone rimovibile)
R-08015	2	38,20	39,80	51,80	modifica forata (1 foro da Ø10,2+3 fori da Ø5)
R-08009	2	38,61 / 38,71	40,15	50,80	
R-08013	2	41,27	44,45	57,15	Ford Granada MkIII

Fascette

Rings

Хомуты

B

Fascette con aggancio rapido in P.A. (dis. 1)

Quick fastening rings in P.A.
Многоразовые хомуты



11323

Codice Code Код	Min Ord Мин. коли- чество заказа	Apert. min	Apert. MAX
		Размеры	
B-08400	2	8,70	10,00
B-08401	2	12,00	13,70
B-08402	2	13,70	15,30
B-08403	2	15,00	16,80

Codice Code Код	Min Ord Мин. коли- чество заказа	Apert. min	Apert. MAX
		Размеры	
B-08404	2	16,80	18,40
• B-08405	2	21,00	22,80
• B-08406	2	23,00	24,80

Fascette con aggancio rapido in acciaio inox (dis.2)

Quick fastening rings in stainless steel
Металлические хомуты одноразового использования



11324

Codice Code Код	Min Ord Мин. коли- чество заказа	Apert. min	Apert. MAX	H
		Размеры		
B-08500	2	24,00	31,00	7,00
B-08550	2	26,00	26,00	7,00
B-08551	2	27,50	29,50	7,00
B-08552	2	28,00	31,00	7,00
B-08553	2	30,00	33,00	7,00
B-08549	2	31,00	38,00	7,00
B-08549A	2	31,00	38,00	9,00
B-08554	2	32,00	35,00	7,00
B-08555	2	34,00	37,00	7,00
B-08556	2	35,00	39,00	7,00
B-08557	2	40,00	44,00	7,00
B-08501	2	46,00	50,00	7,00
B-08504	2	49,00	56,00	7,00
B-08558	2	51,00	55,00	7,00
B-08502	2	51,50	56,00	7,00
B-08503	2	51,50	56,00	7,00
B-08506	2	52,00	56,00	7,00
B-08508	2	57,50	62,00	7,00
B-08507	2	59,00	59,00	7,00
B-08560	2	61,50	65,00	7,00
B-08510	2	63,50	68,00	7,00
B-08512	2	63,50	68,00	7,00

Codice Code Код	Min Ord Мин. коли- чество заказа	Apert. min	Apert. MAX	H
		Размеры		
B-08561A	2	66,00	70,00	9,00
B-08561	2	66,00	72,00	7,00
B-08562A	2	70,00	74,00	9,00
B-08562	2	72,00	74,00	7,00
B-08563	2	74,00	78,00	7,00
B-08563A	2	74,00	78,00	9,00
B-08513	2	75,50	75,50	7,00
B-08514	2	75,50	75,50	7,00
B-08564	2	79,00	82,00	7,00
B-08564A	2	79,00	82,00	9,00
B-08515	2	81,50	81,50	7,00
B-08566	2	83,00	87,00	7,00
B-08567	2	84,00	88,00	7,00
B-08567A	2	84,00	88,00	9,00
B-08568A	2	88,00	92,00	9,00
B-08569	2	89,50	94,00	7,00
B-08574A	2	92,00	96,00	9,00
B-08570A	2	93,00	97,00	9,00
B-08571	2	95,00	99,00	7,00
B-08572	2	100,00	103,00	7,00
B-08573	2	102,00	105,00	7,00

Fascette a molla in acciaio (dis.3)

Spring rings in steel
Металлические хомуты с пружинящей фиксацией



Типо
Type **A**

11325



Типо
Type **B**

11326

Codice Code Код	Min Ord Мин. коли- чество заказа	Apert. min	Apert. MAX	H
		Размеры		
• B-08602	2	A	8,00	5,00
• B-08603	2	A	8,30	5,50
• B-08604	2	A	9,00	5,50
• B-08605	2	A	10,50	6,00
• B-08606	2	A	12,40	7,00
• B-08607	2	A	14,00	7,00

Codice Code Код	Min Ord Мин. коли- чество заказа	Apert. min	Apert. MAX	H
		Размеры		
• B-08608	2	A	16,00	8,00
• B-08600	2	A	16,00	8,00
• B-08609	2	A	17,70	9,00
• B-08610	2	A	18,50	9,50
• B-08611	2	A	20,00	9,50
B-08601	2	B	23,00	

Fascette con bloccaggio a vite in acciaio inox (dis.4)

Quick fastening rings in stainless steel
Металлические хомуты с винтовым зажимом



11328

Codice Code Код	Min Ord Мин. количество заказа	Apert. min	Apert. MAX
		Размеры	
B-08700	2	11,00	14,00
B-08701	2	15,00	17,00
B-08702	2	18,00	20,00
B-08703	2	20,00	23,00
B-08704	2	24,00	28,00
B-08705	2	29,00	33,00
B-08706	2	33,00	37,00

Codice Code Код	Min Ord Мин. количество заказа	Apert. min	Apert. MAX
		Размеры	
B-08707	2	35,00	39,00
B-08708	2	39,00	43,00
B-08709	2	43,00	47,00
B-08710	2	47,00	51,00
B-08711	2	49,00	53,00
B-08712	2	50,00	54,00

Fascette in P.A. (dis.5)

Rings in P.A.
Одноразовые пластиковые хомуты

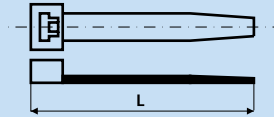

00118



11104

Codice Code Код	Min Ord Мин. количество заказа	L Длина	Note Remarks Примечания
B-08800	2	200,00	nero black
B-08800A	2	200,00	nero black
B-08802	2	200,00	blu blue
B-08804	2	200,00	verde green
B-08806	2	200,00	rosso red
B-08808	2	200,00	giallo yellow

Codice Code Код	Min Ord Мин. количество заказа	L Длина	Note Remarks Примечания
B-08801	2	360,00	nero black
B-08803	2	390,00	blu blue
B-08805	2	390,00	verde green
B-08807	2	390,00	rosso red
B-08809	2	390,00	giallo yellow

Codice Code Код	Min Ord Мин. количество заказа	L Длина	Note Remarks Примечания
 B-08851	2	150,00	nero - per cavi sensori elettrici black - for electric sensor cables

Fascette in metallo (dis.6)

Metallic rings
Металлические хомуты одноразового использования



11105

Codice Code Код	Min Ord Мин. количество заказа	L Длина	Descrizione utilizzo Use remarks Примечания
B-08900	2	203,00	
B-08901	2	360,00	

Guarnizioni per tenuta corpi idro, scatole meccaniche e pompe

for power steering bodies, mechanic steering boxes and pumps

Уплотнения для агрегатов рулевого управления с гидроусилителем, редукторов без гидроусилителя и насосов











P

	Codice Code Код	Min Ord Мин. коли- чество заказа	Tipologia Тип	Materiale Материал	Ø fori	S	Descrizione per utilizzo Use remarks Примечания
					holes Ø		
 11152	P-03100	2	10 fori 10 holes	metallo/gomma metal/rubber		1,05	Mercedes LS8 vecchia versione - Idro a settore
 11153	P-03101	2	8 fori 8 holes	metallo/gomma metal/rubber		1,10	TAS 85 - Idro a settore
 11154	P-03102	2	4 fori 4 holes	metallo/gomma metal/rubber		0,50	Box Jeep - Idro a settore
 11155	P-03103	2	7 fori 7 holes	poliammide speciale special P.A.		0,14	Pompe Rover
 11155	P-03104	2	7 fori 7 holes	poliammide speciale special P.A.		0,28	Pompe Rover
 11155	P-03105	2	7 fori 7 holes	poliammide speciale special P.A.		0,38	Pompe Rover
 11156	P-03106	2	3 fori 3 holes	carta motore gasket paper		0,50	Jaguar/Rover SDI - Idro a cremagliera guarnizione distributore
 11157	P-03107	2	a clessidra hourglass	gomma rubber		3,40	Pompe ZF
 11158	P-03108	2	a clessidra hourglass	poliammide speciale special P.A.		1,70	Pompe ZF
 11159	P-03109	2	7 fori 7 holes	al fluorurato		0,70	Pompe Rover (Genuine)

Guarnizioni per tenuta corpi idro, scatole meccaniche e pompe

Gaskets for power steering bodies, mechanic steering boxes and pumps

Уплотнения для агрегатов рулевого управления с гидроусилителем, редукторов без гидроусилителя и насосов











	Codice Code Код	Min Ord Мин. коли- чество заказа	Tipologia Тип	Materiale Материал	Ø fori holes Ø	S	Descrizione per utilizzo Use remarks Примечания
					Размеры		
 11160	P-03110	2	speciale special	gomma rubber		1,45	Pompe Honda
 11161	P-03111	2	speciale special	gomma rubber		1,45	Pompe Honda
 11162	P-03112	2	speciale special	gomma rubber		1,45	Pompe Honda
 11163	P-03113	2	speciale special	gomma rubber		1,35	Pompe Honda
 11164	P-03114	2	tonda rounded	carta motore gasket paper		1,45	Pompe Rover (Øint. 31,50; Ø est. 45,40)
 11165	P-03115	2	5 fori 5 holes	metallo/gomma metal/rubber	4 fori Ø8,6 + 1 foro Ø11,3	1,00	Pompa Mitsubishi
 11166	P-03116	2	4 fori 4 holes	metallo/gomma metal/rubber		1,00	Pompa Mitsubishi
 11167	P-03117	2	5 fori 5 holes	metallo/gomma metal/rubber		1,00	Pompa Mazda
 11168	P-03118	2	8 fori 8 holes	metallo/gomma metal/rubber		1,00	Gear box Mercedes W126
 11169	P-03119	2	7 fori 7 holes	metallo/gomma metal/rubber		1,08	Pompa NISSAN
 11170	P-03120	2	4 fori 4 holes	metallo/gomma metal/rubber		1,00	Pompa Vauxall Monterey, Isuzu Trooper

Guarnizioni per tenuta corpi idro, scatole meccaniche e pompe

Gaskets for power steering bodies, mechanic steering boxes and pumps

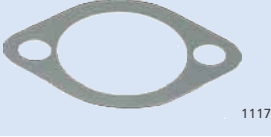
Уплотнения для агрегатов рулевого управления с гидроусилителем, редукторов без гидроусилителя и насосов

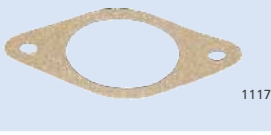

	Codice Code Код	Min Ord Мин. коли- чество заказа	Tipologia Тип	Materiale Материал	Ø fori holes Ø	S	Descrizione per utilizzo Use remarks Примечания
					Размеры		
	P-03121	2	5 fori 5 holes	metallo/gomma metal/rubber	4 fori Ø10,3 + 1 foro Ø11,2	1,00	Pompa Ford, Mazda
	P-03122	2	a pera pear-shaped	gomma speciale special rubber		1,85	Pompa Mazda, Suzuki
	P-03123	2	a pera con lati diritti pear-shaped (straight sides)	gomma speciale special rubber		1,90	Pompa Mazda, Suzuki, Mitsubishi, Audi, Vw Golf.
	P-03124	2	2 fori 2 holes	carta motore gasket paper		0,20	Guarnizioni distributore TRW
	P-03125	2	2 fori 2 holes	carta motore gasket paper		0,48	Guarnizioni distributore TRW
	P-03126	2	2 fori 2 holes	carta motore gasket paper		0,25	Guarnizioni distributore TRW, Ford Escort, Cortina
	P-03127	2	2 fori 2 holes	acciaio steel		0,25	Guarnizioni in acciaio distributore TRW
	P-03128	2	2 fori 2 holes	acciaio steel		0,58	Guarnizioni in acciaio distributore TRW
	P-03129	2	2 fori 2 holes	sughero speciale special cork		1,05	Distributore Renault Megane
	P-03130	2	3 fori 3 holes	sughero speciale special cork		1,55	Distributore Rover 200-400
	P-03131	2	2 fori 2 holes	carta motore gasket paper		0,30	Distributore TRW

Guarnizioni per tenuta corpi idro, scatole meccaniche e pompe

Gaskets for power steering bodies, mechanic steering boxes and pumps

Уплотнения для агрегатов рулевого управления с гидроусилителем, редукторов без гидроусилителя и насосов









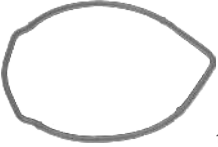

	Codice Code Код	Min Ord Мин. коли- чество заказа	Tipologia Тип	Materiale Материал	Ø fori	S	Descrizione per utilizzo Use remarks Примечания
					holes Ø		
	P-03132	2	2 fori 2 holes	carta motore gasket paper		0,50	Distributore TRW
	P-03133	2	2 fori 2 holes	carta motore gasket paper		1,00	Distributore TRW
	P-03134	2	2 fori 2 holes	carta motore gasket paper		0,30	Distributore TRW
	P-03135	2	2 fori 2 holes	carta motore gasket paper		0,30	Distributore TRW
	P-03136	2	forma speciale special shape	gomma/PTFE rubber/PTFE		2,80	Pompa Merced's LUK E Vikers
	P-03137	2	forma speciale special shape	metallo/gomma 018N metal/rubber 018N		1,45	Pompa Rover Hobourn/Eaton
	P-03137A	2	forma speciale special shape	metallo/gomma 018N metal/rubber 018N		1,45	Pompa Rover Hobourn/Eaton
	P-03138	2	9 fori 9 holes	carta motore gasket paper		1,20	Modello Rover, p5, Mk3, 3 – litro 1962/1964
	P-03139	2	2 fori 2 holes	carta motore gasket paper	9,00	0,20	Guarnizioni distributore TRW MGB
	P-03140	2	2 fori 2 holes	carta motore gasket paper	8,00	0,70	Guarnizioni distributore TRW, Ford Escort, Fiesta
	P-03141	2	3 fori 3 holes	carta motore gasket paper	8,00	0,25	Guarnizioni distributore TRW, Ford Granada, Bedford CF

Guarnizioni per tenuta corpi idro, scatole meccaniche e pompe

Gaskets for power steering bodies, mechanic steering boxes and pumps

Уплотнения для агрегатов рулевого управления с гидроусилителем, редукторов без гидроусилителя и насосов









	Codice Code Код	Min Ord Мин. коли- чество заказа	Tipologia Тип	Materiale Материал	Ø fori holes Ø	S	Descrizione per utilizzo Use remarks Примечания
					Размеры		
 11611	P-03142	2	2 fori 2 holes	carta motore gasket paper	9,00	0,80	Guarnizioni distributore TRW,MGB
 11612	P-03143	2		gomma speciale special rubber			Pompa Toyota Corolla 1.8 2002,T. Avensis 2.0 T25 2003
 11613	P-03144	2	forma a cuore (gobba grande) heart-shaped (big hump)	gomma NBR+zytel rubber NBR+zytel		1,65	Mercedes Classe A
 11613	P-03144H	2	forma a cuore (gobba grande) heart-shaped (big hump)	gomma HNBR+zytel rubber HNBR+zytel		1,65	Mercedes Classe A
 11661	P-03145	2	doppio arco double-arch	gomma speciale HNBR 019 special rubber HNBR+zytel		3,00	Pompa Skoda Fabia a doppio arco in gomma speciale
 11662	P-03146	2	forma a cuore (gobba piccola) heart-shaped (small hump)	gomma NBR+zytel rubber NBR+zytel		1,65	Mercedes Classe A
 11662	P-03146H	2	forma a cuore (gobba piccola) heart-shaped (small hump)	gomma HNBR+zytel rubber HNBR+zytel		1,65	Mercedes Classe A
 11672	P-03147	2		gomma speciale special rubber			Guarnizione piccola in gomma, Honda Acura
 11673	P-03148	2		gomma speciale special rubber			Guarnizione grande in gomma, Honda Acura
 11794	P-03149	2		gomma speciale special rubber			Pompa Toyota, Dodge Caliber, Jeep Patriot, anno 2007-08
 11795	P-03150	2		gomma speciale special rubber			Honda Acura

Guarnizioni per tenuta corpi idro, scatole meccaniche e pompe

Gaskets for power steering bodies, mechanic steering boxes and pumps

Уплотнения для агрегатов рулевого управления с гидроусилителем, редукторов без гидроусилителя и насосов

	Codice Code Код	Min Ord Мин. коли- чество заказа	Tipologia Тип	Materiale Материал	Ø fori	S	Descrizione per utilizzo Use remarks Примечания
					holes Ø		
 11796	P-03151	2	2 fori 2 holes	carta motore gasket paper		0,80	Guarnizioni distributore Rover 75
 11797	P-03152	2	2 fori 2 holes	sughero speciale special cork		2,30	
	P-03153	2	3 fori 3 holes	carta motore gasket paper		0,70	Guarnizione x kit di riparazione Ford Transit
 11798	P-03154	2		gomma rubber		2,00	Guarnizione tonda in gomma
 11799	P-03155	2	a stella star-shaped	acciaio steel		0,30	Base chiusura con tenuta, lamelle con punte piegate, x pompa Peugeot
 11799	P-03156	2	a stella star-shaped	acciaio steel		0,40	Base chiusura con tenuta, lamelle con punte piegate, x pompa Peugeot
 11799	P-03157	2	a stella star-shaped	acciaio steel		0,50	Base chiusura con tenuta, lamelle con punte piegate, x pompa Peugeot
 11800	P-03158	2	a stella star-shaped	acciaio steel		0,40	Base chiusura con tenuta, lamelle con tondi, x pompa Peugeot

Rondelle, bulloni, dadi, viti

Shims, bolts, nuts, screws

Шайбы, болты, гайки, винты



Rondelle di tenuta

Keeping shims
Шайбы

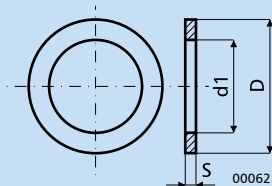

11107

Codice Code Код	Min Ord Мин. количество заказа	d1	D	S	Note Remarks Примечания
U-02300	10	8,25	11,40	1,00	rame copper
U-02301	10	8,25	11,40	1,50	rame copper
U-02302	10	10,20	14,00	0,50	rame copper
U-02303	10	10,20	14,00	1,00	rame copper
U-02304	10	10,20	14,00	1,50	rame copper
U-02305	10	10,20	14,00	2,00	rame copper
U-02306	10	10,20	14,00	2,50	rame copper
U-02307	10	12,20	18,00	0,50	rame copper
U-02308	10	12,20	18,00	1,00	rame copper
U-02309	10	12,20	18,00	1,50	rame copper
U-02310	10	12,20	18,00	2,00	rame copper
U-02311	10	12,20	18,00	2,50	rame copper
U-02312	10	14,20	18,00	0,50	rame copper
U-02313	10	14,20	18,00	1,00	rame copper
U-02314	10	14,20	18,00	1,50	rame copper
U-02315	10	14,20	18,00	2,00	rame copper
U-02316	10	14,20	18,00	2,50	rame copper
U-02317	10	16,20	20,00	0,50	rame copper
U-02318	10	16,20	20,00	1,00	rame copper
U-02319	10	16,20	20,00	1,50	rame copper
U-02320	10	16,20	20,00	2,00	rame copper
U-02321	10	16,20	20,00	2,50	rame copper
U-02354	10	16,90	23,90	4,10	acciaio steel abbinare a L-10100
U-02322	10	18,20	24,00	0,50	rame copper
U-02323	10	18,20	24,00	1,00	rame copper
U-02324	10	18,20	24,00	1,50	rame copper
U-02325	10	18,20	24,00	2,00	rame copper
U-02326	10	18,20	24,00	2,50	rame copper
U-02327	10	20,20	24,00	0,50	rame copper
U-02328	10	20,20	24,00	1,00	rame copper

Codice Code Код	Min Ord Мин. количество заказа	d1	D	S	Note Remarks Примечания
U-02329	10	20,20	24,00	1,50	rame copper
U-02330	10	20,20	24,00	2,00	rame copper
U-02331	10	20,20	24,00	2,50	rame copper
U-02332	10	22,20	28,00	0,50	rame copper
U-02333	10	22,20	28,00	1,00	rame copper
U-02334	10	22,20	28,00	1,50	rame copper
U-02335	10	22,20	28,00	2,00	rame copper
U-02336	10	22,20	28,00	2,50	rame copper
U-02350	10	23,80	29,00	1,00	alluminio aluminium
U-02337	10	24,30	29,00	0,50	rame copper
U-02338	10	24,30	29,00	1,00	rame copper
U-02339	10	24,30	29,00	1,50	rame copper
U-02340	10	24,30	29,00	2,00	rame copper
U-02341	10	24,30	29,00	2,50	rame copper
• U-02360	10	25,15	38,80	2,34	acciaio steel - ZF
• U-02361	10	25,15	38,80	2,65	acciaio steel - ZF
• U-02357	10	25,15	38,90	2,52	acciaio steel - ZF
• U-02356	10	25,15	38,90	2,54	acciaio steel - ZF
• U-02358	10	25,15	38,90	2,56	acciaio steel - ZF
• U-02359	10	25,15	38,90	2,58	acciaio steel - ZF
U-02342	10	26,30	30,00	0,50	rame copper
U-02343	10	26,30	30,00	1,00	rame copper
U-02344	10	26,30	30,00	1,50	rame copper
U-02345	10	26,30	30,00	2,00	rame copper
U-02346	10	26,30	30,00	2,50	rame copper
U-02351	10	28,80	35,00	1,00	alluminio aluminium
• U-02355	10	32,00	44,20	2,30	acciaio steel - Jeep
U-02352	10	41,00	48,80	1,10	alluminio aluminium
U-02353	10	48,50	57,80	1,00	alluminio aluminium

Viti con inserti in P.A.

Screws with inserts in P.A.
Винты с уплотнениями



11347

Codice Code Код	Min Ord Мин. количество заказа	Descrizione utilizzo Use remarks Примечания
U-03650	2	vite filettata con inserti in P.A.
U-03653	10	vite di fissaggio per piastra Mini, con taglio a stella



Uscite olio

Oil exits
Сливные пробки



11331

Codice Code Код	Min Ord Мин. коли- чество заказа	d1	D	H	Descrizione per utilizzo Use remarks Примечания
		Размеры			
U-03651	2	7,00	11,00	9,80	larga (3 bulloni) - Land Rover/Range Rover
U-03652	2	6,30	9,40	8,10	piccola (3 bulloni) - Land Rover/Range Rover



Rondelle USIT

USIT shims
Шайбы с резиновой вставкой

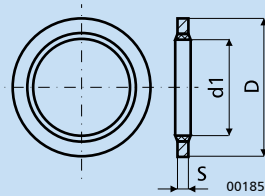

00185



11108

Codice Code Код	d1	D	S
	Размеры		
U-02420	5,20	8,40	1,00
U-02421	6,90	13,20	1,30
U-02422	8,30	13,40	1,30
U-02400	8,50	13,40	1,00
U-02423	8,70	14,20	1,30
U-02424	10,35	16,00	2,00
U-02440	10,70	16,00	1,50
U-02401	10,70	18,00	1,50
U-02425	11,20	18,40	2,10
U-02426	11,70	19,10	2,10
U-02441	12,70	18,00	1,50
U-02402	12,70	20,00	1,50

Codice Code Код	d1	D	S
	Размеры		
U-02427	13,70	20,60	2,10
U-02442	14,70	22,00	1,50
U-02428	14,90	22,30	2,10
U-02429	15,90	22,30	2,10
U-02430	16,50	25,50	2,10
U-02403	16,70	24,00	1,50
U-02431	17,30	23,90	2,10
U-02432	18,20	25,40	2,50
U-02404	18,70	26,00	1,50
U-02433	19,70	27,00	2,50
U-02405	20,70	28,00	1,50
U-02434	21,50	28,70	2,50

Codice Code Код	d1	D	S
	Размеры		
U-02406	22,50	28,00	1,50
U-02443	22,70	30,00	2,00
U-02435	23,50	31,80	2,50
U-02436	24,30	33,30	2,50
U-02407	24,70	32,00	2,00
U-02408	26,70	35,00	2,00
U-02437	27,00	35,00	2,50
U-02438	27,80	38,70	2,50
U-02409	28,70	37,00	2,00
U-02439	30,80	38,20	2,50
U-02444	34,00	42,80	2,30



Rondelle USIT con interno rinforzato

USIT shims with strenghtened interior
Шайбы с внутренним усилением



11679

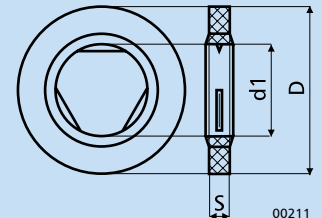

00211

Codice Code Код	Min Ord Мин. коли- чество заказа	d1	D	S	Filetto
		Размеры			
U-02500	10	3,10	8,00	1,00	M4
U-02501	10	4,00	9,00	1,00	M5
U-02502	10	4,80	10,00	1,00	M6
U-02503	10	6,40	14,00	1,50	M8
U-02504	10	8,10	17,00	1,50	M10
U-02505	10	9,80	19,00	1,50	M12

Codice Code Код	Min Ord Мин. коли- чество заказа	d1	D	S	Filetto
		Размеры			
U-02507	10	13,50	24,00	2,50	M16
U-02508	10	14,80	27,00	2,50	M18
U-02509	10	16,80	30,00	2,50	M20
U-02510	10	18,80	32,00	2,50	M22
U-02511	10	20,20	36,00	3,00	M24





Rondelle, bulloni, dadi, viti

Shims, bolts, nuts, screws
Шайбы, болты, гайки, винты



Bulloni e dadi per pompe

Lock bolts and nuts
Фиксирующие болты и гайки

	Codice Code Код	Min Ord Мин. колич- ество заказа	d1	d2	D	h1	H	P	Descrizione per utilizzo Use remarks Примечания
 11402	U-03600	2	10,70	22,70	22,70	3,00	10,00	1,50	Rover 4/6 Bolt M12
 11403	U-03601	2	20,00	28,00	28,00	4,00	16,00	1,50	Bullone tappo pignone Mondeo
	U-03602	2	8,70	18,00	24,00	4,70	12,70	1,50	Bullone tappo pignone, testa esagonale
 11838	U-03603	2	8,50		15,00		9,00	1,50	Dado M10 Ø8,5x1,5 H9 CH15 autobloccante
 11840	U-03604	2	6,70	12,80	16,70	1,90	9,30	1,50	M8
 11841	U-03605	2	12,00		19,00		8,00	1,25	Dado M12 Ø12x1,25 H8 CH19 autobloccante

Niples

Niples
Переходники

	Codice Code Код	Min Ord Мин. колич- ество заказа	Descrizione per utilizzo Use remarks Примечания
 11641	U-03630	2	<p>Niples - entrata Ø14x1,5 - uscita Ø14x1,5 H21</p> <p>Questo particolare si usa per spostare attacco idro per facilitare il montaggio del tubo da parte del meccanico. Esempio: i fori ravvicinati entrata e uscita sul distributore non permettono al meccanico di bloccare bene i tubi di mandata e ritorno non avendo chiavi speciali che permettono questo lavoro. Essendo lo spazio ravvicinato si crea un contatto e si può rovinare il filetto interno del distributore in alluminio con grossi problemi di garanzia. Noi abbiamo creato un niples con varie misure entrata e uscita.</p> <p><i>This component is used to move the power steering fastening and ease the tube assembling process for the mechanic. e.g. the input/output holes are very close on the distributor so it's difficult for the mechanic to fasten properly tubes of turn without having special keys. Due to this small space there is a contact that damages the internal thread of the aluminium distributor with big damages of guarantee. We created a niples with different input and output sizes.</i></p> <p><i>Этот компонент используется для облегчения процесса монтажа и демонтажа агрегатов рулевого управления, а также позволяет предотвратить повреждение резьбы в агрегатах рулевого управления.</i></p>

Segmenti in P.T.F.E.

P.T.F.E. piston rings

Тефлоновые кольца



CRE Cremagliera Rack Гидроцилиндр
DIS Distributore Pignon Распределитель
PIS Pistone Piston Поршень



in ordine di codice

sorted by code
сортировка по коду

Codice Code Код	Min Ord Мин. количество заказа	Dis. Тип	d1	D	S	Ø stelo	Uso Use in Применение	Descrizione per utilizzo Use remarks Примечания
			Размеры					
M-01300	2	1	31,60	34,40	2,00		CRE	
M-01301	2	1	35,60	38,20	2,00		DIS	Alfa
M-01302	2	1	28,90	31,50	2,00			ZF
M-01303	2	1	45,20	49,50	2,25		CRE	Ducato I serie
M-01304	2	1	34,30	38,30	2,00		DIS	Alfa 75 ZF
M-01305	2	1	26,50	30,50	2,00		CRE	Alfa
M-01306	2	1	38,00	42,00	2,00		CRE	Mondeo / ZF (Bianco)
M-01306A	2	1	38,00	42,00	2,00		CRE	Mondeo (azzurro)
M-01306B	2	1	38,00	42,00	2,00		CRE	Ford Mondeo ZF (nero)
M-01307	2	2	22,20	25,50	2,70	22,00	CRE	Alfa 75 I serie
M-01308	2	2	21,30	24,30	3,00	22,00		o-ring Ø23,6 C2,6 - Alfa 75, Porsche (autolivellante)
M-01309	2	2	21,20	29,50	19,50	22,00	CRE	mod. centrale con o-ring in viton - Porsche-Alfa 75 1°serie con mol.x stelo da Ø22
M-01310	2	2	21,20	29,50	19,50	22,00	CRE	mod. centrale con o-ring alta pressione - Alfa 75 1°serie con mol.x stelo da Ø22
M-01311	2	1	30,20	32,60	2,00			
M-01312	2	1	24,80	28,00	2,00			
M-01313	2	1	27,20	30,70	2,00		DIS	Sierra -Scorpio-Volvo-TRW
M-01314	2	1	35,00	39,00	2,00		CRE	Fiat Tipo, VW Golf
M-01315	2	2	22,40	25,60	3,00	23,00		Alfa 75 2a serie-Porsche (autolivellante)
M-01316	2	2	22,30	30,70	13,50	23,00	CRE	mod. centrale - Alfa 75 con o-ring x stelo da Ø23
M-01317	2	2	23,00	31,60	13,80	23,00	CRE	Alfa 75 2°serie + o-ring in viton x stelo da Ø23
M-01318	2	2	21,50	25,10	3,00	22,00		Thema (autolivellante)
M-01319	2	1	36,60	41,10	2,25		CRE	Rover, Volvo
M-01320	2	2	23,20	26,50	2,70	23,00	CRE	Alfa 75 2°serie x stelo Ø23
M-01321	2	2	17,60	21,30	3,00	18,00		BMW (autolivellante)
M-01322	2	2	16,50	20,50	3,00	17,00		BMW (autolivellante)
M-01323	2	2	24,40	28,00	3,00	25,00		Alpine Solara/Audi 80 (autolivellante)
M-01324	2	2	9,50	13,10	3,00	10,00		Audi 100 (autolivellante)
M-01325	2	2	21,60	25,00	2,90	22,00		Audi 80/VW (autolivellante)
M-01326	2	2	28,00	31,50	2,90	28,00		Jaguar (autolivellante)
M-01327	2	2	19,20	23,20	3,00	20,00		BMW (autolivellante) - con oring O-02853B 31 -corda 2,45
M-01328	2	1	36,40	40,40	2,00		CRE	Fiat TIPO - tappo largo
M-01329	2	1	32,50	37,50	2,30		CRE	Clio / Peugeot
M-01330	2	1	47,30	51,40	2,10		DIS	Bendix
M-01331	2	1	38,10	42,60	2,00		CRE	Lancia Thema
M-01332	2	1	36,80	41,20	2,30		CRE	Thema I Serie rover - Volvo - Granada - MK II e III Serie
M-01333	2	1	39,80	42,80	2,45		CRE	Lancia K
M-01334	2	1	33,80	38,30	2,10		DIS	Austin 1800/2200
M-01335	2	1	45,10	49,60	2,00		CRE	Ducato II Serie
M-01336	2	1	26,60	30,40	2,00		DIS	Citroen-Peugeot
M-01338	2	1	28,40	31,00	1,90		DIS	Cavalier
M-01339	2	1	32,85	38,10	2,20		CRE	Peugeot -Peugeot
M-01340	2	1	18,10	25,00	3,44		CRE	
M-01341	2	1	20,40	24,80	2,00		CRE	Peugeot

**CRE
DIS
PIS**Cremagliera
Distributore
PistoneRack
Pignon
PistonГидроцилиндр
Распределитель
Поршень

Codice Code Код	Min Ord Мин. коли- чество заказа	Dis. Тип	d1	D	S	Ø stelo	Uso Use in Приме- нение	Descrizione per utilizzo Use remarks Примечания
			Размеры					
M-01342	2	1	30,90	34,90	2,30		CRE	Peugeot
M-01343	2	1	24,00	28,00	2,30			Rover SDI
M-01344	2	2	20,10	27,70	3,50	21,00		Granada MK2 e 3 serie x stelo da Ø21
M-01345	2	1	35,20	40,00	2,30		CRE	Peugeot
M-01346	2	1	32,90	37,90	2,20			Jaguar Adwest-Rover 3/4 bolt
M-01347	2	1	34,00	39,20	2,30		CRE	Saab
M-01348	2	1	26,60	31,80	1,95			Sierra -Scorpio-VOLVO
M-01349	2	1	37,00	43,00	1,90			Granada MK III S.
M-01350	2	1	32,50	39,10	2,20			XJ40
M-01351	2	1	29,00	33,00	2,50		CRE	Cavalier Saginaw
M-01352	2	1	35,80	40,60	2,40		CRE	Saab
M-01353	2	1	36,80	42,20	1,90			Granada MK III S.
M-01354	2	1	26,80	31,20	1,90			Sierra -Scorpio-Volvo
M-01355	2	1	35,90	39,00	2,00			Bmw
M-01356	2	2	25,60	28,30	2,90	26,50		Passat/Audi A4 VW (autolivellante)
M-01357	2	1	37,00	42,80	3,00		CRE	SD1 MKII (A&A)
M-01358	2	1	37,10	41,30	1,90		CRE	Granada MK III
M-01359	2	2	29,10	32,80	2,90	29,50		I/D - XJ40 (autolivellante)
M-01360	2	1	40,10	44,30	2,70			Jaguar XJ6 I e II Serie
M-01361	2	3					CRE	Mercedes Vito/Sprinter (segm aperto)
M-01362	2	1	49,00	53,40	2,25		CRE	Mercedes Vito e Sprinter
M-01363	2	1	39,90	44,00	3,00			44 MM O/D - Rover SD1 Burman
M-01364	2	1	40,30	44,30	2,65		CRE	1.75" O/D - Jaguar XJ6-II E III Serie Adwest
M-01365	2	1	41,60	44,20	3,00			1.75" O/D - Princess/SD1/ XJ6
M-01366	2	1	66,40	70,00	3,20			2,760" O/D - Land/Range Rover Pistone 4 bull.
M-01367	2	1	73,00	76,60	3,20			3.015" O/D - Land/Range Rover Pistone 3 bull.
M-01368	2	1	65,30	70,50	3,90			Land,Range Rover(6bolt)
M-01369	2	2	37,80	40,20	4,40		CRE	Bmw
M-01370	2	1	35,70	38,50	2,00		DIS	Fiesta,Mondeo
M-01371	2	1	34,40	38,10	2,25		DIS	Cavalier Saab Saginaw
M-01372	2	2	19,40	23,00	3,00	20,00		Alpine Solara - Jaguar J40 (autolivellante)
M-01373	2	1	63,30	66,10	2,50		CRE	Bendix
M-01374	2	1	78,00	80,60	2,50		CRE	Bendix
M-01375	2	1	40,80	46,40	2,00		CRE	BMW Z3
M-01376	2	1	33,10	36,10	1,90		DIS	Toyota,Mitsubishi,Peugeot Ø44
M-01377	2	1	32,80	36,20	2,00		DIS	Hyundai
M-01378	2	1	39,20	42,70	2,00		CRE	Hyundai
M-01379	2	1	6,80	10,00	1,80		DIS	Fiesta/Mondeo
M-01380	2	1	14,10	16,70	1,15			F.Fiesta/Mondeo
M-01381	2	1	18,20	20,20	4,30			Citroen
M-01382	2	1	23,70	25,50	2,60		DIS	Citroen
M-01383	2	1	23,80	25,50	1,10		CRE	Citroen
M-01384	2	1	19,70	21,30	2,00		CRE	Ford Mazda
M-01385	2	1	36,40	40,00	2,50		CRE	Audi - Passat KOJO
M-01386	2	1	32,80	36,60	2,50		CRE	Opel corsa
M-01387	2	1	26,70	30,70	12,20		CRE	Opel Corsa
M-01388	2	1	38,80	44,50	2,00		CRE	Ford Galaxy-VW Sharan
M-01389	2	2	15,00	19,00	3,00	15,75		Mercedes (autolivellante)
M-01390	2	2	23,40	27,00	3,00	24,00		Mercedes W123 (autolivellante)
M-01391	2	1	35,00	38,70	1,90			
M-01392	2	2	31,00	39,40	4,00	32,00		Mercedes 560SL (autolivellante)



Segmenti in P.T.F.E.

P.T.F.E. piston rings
Тефлоновые кольца

in ordine di codice

sorted by code
сортировка по коду

Codice Code Код	Min Ord Мин. коли- чество заказа	Dis. Тип	d1	D	S	Ø stelo	Uso Use in Приме- нение	Descrizione per utilizzo Use remarks Примечания
			Размеры					
M-01393	2	1	66,40	70,00	2,30		PIS	Mitsubishi L200
M-01394	2	1	34,50	37,50	1,90		DIS	Peugeot Laguna (KOJO)
M-01395	2	1	43,70	48,30	3,00			TAS 86
M-01396	2	1	63,30	67,30	2,00			TAS 86
M-01397	2	1	107,50	111,50	2,25			TAS 86
M-01398	2	1	36,60	40,20	2,50		CRE	Fiat Fiorino SAGINAW
M-01399	2	1	34,70	37,50	4,50		CRE	Alfa 33
M-01400	2	1	34,50	38,30	1,85		CRE	
M-01401	2	1	25,65	37,75	5,25		CRE	Astra TRW
M-01402	2	1	21,12	24,40	1,60		DIS	VW - Audi- Octavia
M-01403	2	2	15,50	19,40	2,90	16,00		per stelo Ø16 (autolivellante)
M-01404	2	2	13,50	17,40	2,90	14,00		Moto per stelo Ø14 (autolivellante)
M-01405	2	1	25,80	27,20	3,00		CRE	Citroen CX
M-01406	2	1	35,10	36,70	3,06		CRE	Citroen CX
M-01407	2	2	42,50	45,00	4,40		CRE	Bmw
M-01408	2	2	31,30	37,00	4,00	32,00		Iveco (autolivellante)
M-01409	2	1	66,90	71,10	6,90			
M-01410	2	1	42,30	45,00	2,00		CRE	Mercedes 250
M-01411	2	1	35,80	38,10	2,00		DIS	Mercedes 250
M-01412	2	1	38,70	43,50	2,50		CRE	Citroen Jumpy
M-01413	2	1	29,10	32,00	2,20		CRE	Mercedes LS8 old version
M-01414	2	1	36,90	39,60	2,80		CRE	LS8 old version
M-01415	2	1	47,40	50,00	2,31		CRE	LS8 old version
M-01416	2	1	69,80	74,70	2,25		DIS	LS8 (1°revisione)
M-01417	2	1	110,00	115,50	2,80		CRE	LS8 old version
M-01418	2	1	41,00	45,00	3,00		CRE	
M-01419	2	1	34,00	38,00	3,00			
M-01420	2	1	37,50	41,90	3,00		CRE	Honda CRV
M-01421	2	1	33,10	36,10	1,80		DIS	Honda CRV
M-01422	2	1	47,20	50,30	2,40		CRE	Toyota Landcruiser
M-01423	2	1	41,45	44,75	2,20		CRE	Mitsubishi
M-01424	2	1	35,80	38,10	2,00		DIS	Mercedes
M-01425	2	2	31,60	36,00	2,00	32,00		Mercedes 5000/560SL (autolivellante)
M-01426	2	3					CRE	XJ40
M-01427	2	3					CRE	
M-01428	2	3						Jaguar
M-01429	2	1	103,00	112,00	4,80			scatola a settore
M-01430	2	1	35,80	38,10	2,00		DIS	Daily '05-Audi A4 ZF
M-01431	2	1	38,00	40,60	2,00		CRE	Daily 05-Audi A4 ZF
M-01432	2	1	37,90	40,40	2,00			
M-01433	2	1	45,80	48,40	2,00		CRE	Volkswagen transporter ZF
M-01434	2	1	44,35	47,35	3,85		CRE	Volkswagen,Transporter
M-01435	2	1	32,10	35,90	2,00		PIS	pistone Ø35,9 - Ford Fusion/Fiesta U.Tipo
M-01436	2	1	42,60	45,20	2,05		PIS	pistone Ø45 - Mercedes classe S
M-01437	2	1	47,50	51,00	2,35		PIS	pistone Ø50 - Mercedes classe S
M-01438	2	2	34,80	38,00	3,70			Rover a settore
M-01439	2	1	24,90	27,50	2,02		CRE	Audi 80/90 ZF
M-01440	2	1	26,90	29,20	2,00		CRE	Audi 80/90 ZF
M-01441	2	2	45,30	49,00	1,70		CRE	Audi 80/90 ZF
M-01442	2	1	45,60	48,20	2,00		CRE	Ford transit ZF
M-01443	2	1	44,50	48,10	1,95		CRE	Ford transit ZF

**CRE
DIS
PIS**Cremagliera
Distributore
PistoneRack
Pignon
PistonГидроцилиндр
Распределитель
Поршень

Codice Code Код	Min Ord Мин. коли- чество заказа	Dis. Тип	d1	D	S	Ø stelo	Use in Prime- niente	Descrizione per utilizzo Use remarks Примечания
			Размеры					
M-01444	2	2	46,20	48,70	4,50		CRE	Ford Transit ZF
M-01445	2	2	10,50	12,90	2,00	11,00		Alfa 156 Servotronic (autolivellante)
M-01446	2	2	33,00	35,80	2,50	36,00	DIS	Integrato con F-00318 Mazda 6 626 crem.Ø36
M-01447	2	1	32,00	36,00	9,80		PIS	Mazda 6/626
M-01448	2	1	26,90	30,60	1,90		DIS	Mazda 6/626
M-01449	2	1	33,00	36,00	1,50		PIS	Mazda 6/626
M-01450	2	1	47,00	51,00	2,60		CRE	Mazda 6/626 (cre. Ø36)
M-01451	2	1	35,00	37,60	2,00		CRE	Audi A4/VW Passat
M-01452	2	1	25,10	26,60	2,00		CRE	Audi A4 /VW Passat
M-01453	2	1	20,80	24,10	1,75		DIS	
M-01454	2	1	36,60	39,20	2,00		CRE	
M-01455	2	1	35,20	38,80	2,56		CRE	Peugeot 206
M-01456	2	1	80,20	85,20	1,00		CRE	Pompa ZF
M-01457	2	1	79,00	84,00	1,00		CRE	Pompa ZF
M-01458	2	1	41,00	43,50	2,00		CRE	Ford 43,5X2
M-01459	2	1	48,00	54,00	1,50			veicoli commerciali-per kit camion ammortizzatore autolivellante Ø70
M-01460	2	1	84,00	90,00	1,50			veicoli commerciali-per kit camion ammortizzatore autolivellante Ø70
M-01461	2	1	84,00	89,00	15,00			veicoli commerciali-per kit camion ammortizzatore autolivellante Ø70
M-01462	2	1	68,30	73,30	9,50			veicoli commerciali-per kit camion ammortizzatore autolivellante Ø70
M-01463	2	1	35,80	39,20	2,00		DIS	ZF Golf MK IV 1997
M-01464	2	1	35,50	38,50	2,10		DIS	Ford Fiesta/Fusion
M-01465	2	1	22,20	35,00	0,40			veicoli commerciali-rondella PTFE autolivellante per autocarro
M-01466	2	1	30,90	33,70	3,40			veicoli commerciali-Mercedes benz.LK-1924/46
M-01467	2	1	34,30	41,90	3,40		DIS	Mercedes benz.LK-1924/46
M-01468	2	1	40,60	43,20	2,00		CRE	Peugeot 406 servotronic
M-01469	2	1	19,10	20,70	2,00		CRE	Peugeot 406 servotronic
M-01470	2	1	25,20	26,70	2,00		CRE	Peugeot 406 servotronic
M-01471	2	1	34,00	37,50	2,60		CRE	Vw golf
M-01472	2	1	36,00	38,20	2,08		DIS	Ford Granada/Scorpio
M-01473	2	1	27,70	31,30	4,00		CRE	Kit riparazione ZF Scania/ Iveco
M-01474	2	1	66,00	70,00	5,90		DIS	per kit cilindro ZF Iveco
M-01475	2	1	27,40	32,80	3,95			per kit zf Scania /Iveco
M-01476	2	1	58,10	61,50	2,30		CRE	Suzuki Vitara SE 416
M-01477	2	1	56,90	60,20	2,00		CRE	Suzuki Vitara SE 416
M-01478	2	1	52,10	55,40	1,95		CRE	Suzuki Vitara SE 416
M-01479	2	1	35,00	38,10	2,25		CRE	Suzuki Vitara SE 416
M-01480	2	1	41,00	43,50	2,50		CRE	Suzuki / Space Wagon
M-01481	2	1	33,50	36,10	2,40			Subaru/Suzuki
M-01482	2	1	35,70	38,30	2,30		CRE	Mercedes classe A
M-01483	2	1	48,80	52,30	2,00		CRE	Mercedes
M-01484	2	1	8,20	11,20	2,30		DIS	Ford Focus
M-01485	2	1	36,90	39,50	2,25		CRE	Saab 9.5 2004/05 (x pistone K-00005)
M-01486	2	1	45,80	48,30	2,00		CRE	Mercedes Vito (X pistone Ø30x48)
M-01487	2	1	42,80	46,30	2,02		CRE	Eurovan diesel
M-01488	2	1	35,80	38,20	4,00			Toyota Landcruiser
M-01489	2	1	29,90	32,90	2,20			Toyota Landcruiser
M-01490	2	1	75,90	78,80	2,50			Toyota Landcruiser
M-01491	2	1	31,40	35,40	5,00			Toyota Landcruiser



Segmenti in P.T.F.E.

P.T.F.E. piston rings
Тefлоновые кольца

in ordine di codice

sorted by code
сортировка по коду

Codice Code Код	Min Ord Мин. коли- чество заказа	Dis. Тип	d1	D	S	Ø stelo	Uso Use in Приме- нение	Descrizione per utilizzo Use remarks Примечания
			Размеры					
M-01492	2	1	66,60	69,60	2,25			Toyota Landcruiser
M-01493	2	1	18,60	20,20	1,95		DIS	Jaguar Servotronic
M-01494	2	1	51,20	54,70	2,50		CRE	Mercedes Nuovo Sprinter Ø30
M-01495	2	1	35,70	40,10	3,05			Honda Civic
M-01496	2	1	51,00	55,00	2,10			Honda Civic
M-01497	2	1	69,80	74,70	2,25		DIS	LS8 (2°revisione)
M-01498	2	1	40,70	44,00	2,10		CRE	Hyundai Sonata
M-01499	2	1	40,50	44,10	2,50		CRE	Mitsubishi Eclipse
M-01500	2	1	61,00	64,60	2,30			Mitsubishi Pajero
M-01501	2	1	29,50	32,10	2,00			Alfa 75 II serie
M-01502	2	1	32,10	37,10	2,25			
M-01503	2	1	34,40	38,40	2,45			
M-01504	2	1	31,10	35,10	1,90			
M-01505	2	2	26,50	30,50	3,00	27,00		Alfa cambio Selespeed (autolivellante)
M-01506	2	1	34,90	38,10	1,90		DIS	Peugeot 206 ZF
M-01507	2	1	35,60	38,40	1,95		CRE	Peugeot 206 ZF
M-01508	2	1	18,00	24,20	2,90			Alfa Cambio Selespeed
M-01509	2	1	34,70	37,50	2,95			Mercedes LS2 Jeep
M-01510	2	1	26,80	29,10	2,30			Mercedes LS2 Jeep
M-01511	2	1	20,80	23,80	2,25			Mercedes LS2 /Jeep
M-01512	2	1	87,20	89,80	3,30			Mercedes LS2 Jeep
M-01513	2	1	45,50	50,40	2,50		CRE	Ford Transit
M-01514	2	1	36,80	40,60	1,95		CRE	Matiz
M-01515	2	1	43,90	48,50	2,80		CRE	Opel Movano
M-01516	2	1	44,00	48,00	2,85			
M-01517	2	1	44,20	48,00	2,85			
M-01518	2	1	44,20	51,70	2,20			
M-01519	2	1	64,00	68,60	2,00			
M-01520	2	1	59,80	64,60	1,90			LS4
M-01521	2	1	55,60	60,60	1,90			LS4
M-01522	2	1	30,50	32,50	1,80			LS4
M-01523	2	1	102,00	105,20	2,70			LS4
M-01524	2	2	21,15	25,00	3,00	21,75		autolivellante
M-01525	2	1	26,60	30,70	2,00			
M-01526	2	2	42,80	48,00	3,90	43,50		Mercedes (autolivellante)
M-01527	2	1	19,40	22,00	2,00			Audi 100
M-01528	2	1	25,50	28,10	1,98			Audi 100
M-01529	2	1	41,70	45,30	2,00			Peugeot 607,Citroen C5
M-01530	2	1	33,70	38,30	2,50		CRE	R. Laguna,Megane,Scenic
M-01531	2	2	37,60	40,20	4,40		CRE	
M-01532	2	1	46,50	50,20	1,90		CRE	Kia Sedona
M-01533	2	1	36,60	40,20	2,80		CRE	Peugeot 407
M-01534	2	1	101,40	105,00	2,20			TAS 75
M-01535	2	2	30,00	37,00	2,20			
M-01536	2	1	32,20	35,00	2,40			Mercedes
M-01537	2	1	67,80	71,20	2,80			Mercedes
M-01538	2	1	40,60	44,00	2,00		CRE	Alfa 159 ZF
M-01539	2	1	31,90	36,50	2,00			Bmw 316 E 30
M-01540	2	1	38,00	40,60	2,60		CRE	
M-01541	2	1	35,40	40,10	2,50		CRE	Vectra C
M-01542	2	1	42,80	46,80	2,50		CRE	Toyota Highlander

**CRE
DIS
PIS**Cremagliera
Distributore
PistoneRack
Pignon
PistonГидроцилиндр
Распределитель
Поршень

Codice Code Код	Min Ord Мин. коли- чество заказа	Dis. Тип	d1	D	S	Ø stelo	Uso Use in Приме- нение	Descrizione per utilizzo Use remarks Примечания
			Размеры					
M-01543	2	1	41,70	46,40	2,30		CRE	Renault Master, Espace
M-01544	2	1	37,00	41,40	2,40		CRE	Opel Vectra C
M-01545	2	1	47,20	50,60	2,10		CRE	Mercedes Vito
M-01546	2	3					CRE	Mercedes (aperto)
M-01547	2	1	41,80	45,30	1,95		CRE	BMW
M-01548	2	1	41,20	45,10	1,95		CRE	Ford Taurus,S-Max
M-01549	2	1	39,10	42,90	2,00		CRE	Nissan Altima, Eclipse/Talon, Mazda 626
M-01550	2	1	42,50	46,10	2,00		CRE	Hyundai Santa Fe
M-01551	2	1	50,20	52,40	1,95			Lexus LS400
M-01552	2	1	46,90	50,30	3,50			
M-01553	2	1	51,80	54,90	3,40			
M-01554	2	1	67,90	71,90	1,50			
M-01555	2	1	56,20	70,20	6,70			Kit segmenti in PTFE dis.1 Ø56,2x70,2 S6,7
M-01556	2	1	45,80	50,80	4,00			Lada Niva 4/4 tacche
M-01557	2	1	49,80	54,60	2,70		CRE	Iveco C13, C15
M-01558	2	1	7,10	9,50	2,50			
M-01559	2	1	38,70	42,20	2,00		CRE	Toyota Avensis - Ford C-Max
M-01560	2	1	36,90	40,20	1,95		CRE	Focus
M-01561	2	1	10,70	13,50	3,25		DIS	Ducato
M-01562	2	1	47,30	52,30	2,35		CRE	Ducato
M-01563	2	1	50,00	52,20	2,00			Nissan Patrol
M-01564	2	1	39,20	42,90	2,50		CRE	Audi, Suzuki
M-01565	2	1	81,20	84,60	3,45			
M-01566	2	1	44,30	49,10	2,55		CRE	Ford Transit U.T
M-01567	2	1	44,50	48,00	2,50		CRE	Chevrolet Colorado, Jeep Liberty
M-01568	2	1	34,20	37,80	2,20		DIS	Cavalier Saab Saginaw
M-01569	2	1	35,80	38,80	2,00		CRE	
M-01570	2	1	42,60	47,60	1,95		CRE	
M-01571	2	1	39,60	43,10	2,50		CRE	
M-01572	2	1	34,40	38,20	1,85			
M-01573	2	1	40,00	45,10	1,80		CRE	
M-01574	2	1	65,00	69,50	1,40			
M-01575	2	1	47,00	50,40	2,20		CRE	
M-01576	2	1	33,80	36,80	1,95		DIS	
M-01577	2	1	43,80	47,80	2,00			
M-01578	2	1	40,30	45,20	3,10			
M-01579	2	1	107,50	111,50	1,95			TAS 80
M-01580	2	1	24,50	26,40	2,50			Fascia in teflon 8098
M-01581	2	2	39,50	45,40	4,00	40,30		autolivellante x albero Ø 40,3
M-01582	2	1	26,30	29,10	1,98		PIS	Audi 80/90 ZF
M-01583	2	1	41,80	46,20	3,00			
M-01584	2	1	11,20	14,10	1,50		DIS	Mercedes
M-01585	10	1	12,80	15,70	1,40			Mercedes
M-01586	10	1	15,90	18,70	1,40			Mercedes
M-01587	2	1	42,20	45,80	1,80		CRE	GMC, Chevrolet

Segmenti in P.T.F.E.

P.T.F.E. piston rings

Тефлоновые кольца



CRE Cremagliera Rack Гидроцилиндр
DIS Distributore Pignon Распределитель
PIS Pistone Piston Поршень



in ordine di Øest

sorted by ext.Ø
 сортировка по размеру

Codice Code Код	Min Ord Мин. коли- чество заказа	Dis. Тип	d1	D	S	Ø stelo	Uso Use in Приме- нение	Descrizione per utilizzo Use remarks Примечания
			Размеры					
M-01558	2	1	7,10	9,50	2,50			
M-01379	2	1	6,80	10,00	1,80		DIS	Fiesta/Mondeo
M-01484	2	1	8,20	11,20	2,30		DIS	Ford Focus
M-01445	2	2	10,50	12,90	2,00	11,00		Alfa 156 Servotronic (autolivellante)
M-01324	2	2	9,50	13,10	3,00	10,00		Audi 100 (autolivellante)
• M-01561	2	1	10,70	13,50	3,25		DIS	Ducato
• M-01584	2	1	11,20	14,10	1,50		DIS	Mercedes
• M-01585	10	1	12,80	15,70	1,40			Mercedes
M-01380	2	1	14,10	16,70	1,15			F.Fiesta/Mondeo
M-01404	2	2	13,50	17,40	2,90	14,00		Moto per stelo Ø14 (autolivellante)
• M-01586	10	1	15,90	18,70	1,40			Mercedes
M-01389	2	2	15,00	19,00	3,00	15,75		Mercedes (autolivellante)
M-01403	2	2	15,50	19,40	2,90	16,00		per stelo Ø16 (autolivellante)
M-01493	2	1	18,60	20,20	1,95		DIS	Jaguar Servotronic
M-01381	2	1	18,20	20,20	4,30			Citroen
M-01322	2	2	16,50	20,50	3,00	17,00		BMW (autolivellante)
M-01469	2	1	19,10	20,70	2,00		CRE	Peugeot 406 servotronic
M-01384	2	1	19,70	21,30	2,00		CRE	Ford Mazda
M-01321	2	2	17,60	21,30	3,00	18,00		BMW (autolivellante)
M-01527	2	1	19,40	22,00	2,00			Audi 100
M-01372	2	2	19,40	23,00	3,00	20,00		Alpine Solara - Jaguar J40 (autolivellante)
M-01327	2	2	19,20	23,20	3,00	20,00		BMW (autolivellante)
M-01511	2	1	20,80	23,80	2,25			Mercedes LS2 /Jeep
M-01453	2	1	20,80	24,10	1,75		DIS	
M-01508	2	1	18,00	24,20	2,90	Alfa Cambio Selespeed		BMW (autolivellante)
M-01308	2	2	21,30	24,30	3,00	22,00		o-ring Ø23,6 C2,6 - Alfa 75, Porsche (autolivellante)
M-01402	2	1	21,12	24,40	1,60		DIS	VW - Audi- Octavia
M-01341	2	1	20,40	24,80	2,00		CRE	Peugeot
M-01325	2	2	21,60	25,00	2,90	22,00		Audi 80/VW (autolivellante)
M-01524	2	2	21,15	25,00	3,00	21,75		autolivellante
M-01340	2	1	18,10	25,00	3,44		CRE	
M-01318	2	2	21,50	25,10	3,00	22,00		Thema (autolivellante)
M-01383	2	1	23,80	25,50	1,10		CRE	Citroen
M-01382	2	1	23,70	25,50	2,60		DIS	Citroen
M-01307	2	2	22,20	25,50	2,70	22,00	CRE	Alfa 75 I serie
M-01315	2	2	22,40	25,60	3,00	23,00		Alfa 75 2a serie-Porsche (autolivellante)
• M-01580	2	1	24,50	26,40	2,50			Fascia in teflon 8098
M-01320	2	2	23,20	26,50	2,70	23,00	CRE	Alfa 75 2ªserie x stelo Ø23
M-01452	2	1	25,10	26,60	2,00		CRE	Audi A4 /VW Passat
M-01470	2	1	25,20	26,70	2,00		CRE	Peugeot 406 servotronic
M-01390	2	2	23,40	27,00	3,00	24,00		Mercedes W123 (autolivellante)
M-01405	2	1	25,80	27,20	3,00		CRE	Citroen CX
M-01439	2	1	24,90	27,50	2,02		CRE	Audi 80/90 ZF
M-01344	2	2	20,10	27,70	3,50	21,00		Granada MK2 e 3 serie x stelo da Ø21
M-01312	2	1	24,80	28,00	2,00			

CRE
DIS
PISCremagliera
Distributore
PistoneRack
Pignon
PistonГидроцилиндр
Распределитель
Поршень

Codice Code Код	Min Ord Мин. коли- чество заказа	Dis. Тип	d1	D	S	Ø stelo	Uso Use in Приме- нение	Descrizione per utilizzo Use remarks Примечания
			Размеры					
M-01343	2	1	24,00	28,00	2,30			Rover SDI
M-01323	2	2	24,40	28,00	3,00	25,00		Alpine Solara/Audi 80 (autolivellante)
M-01528	2	1	25,50	28,10	1,98			Audi 100
M-01356	2	2	25,60	28,30	2,90	26,50		Passat/Audi A4 VW (autolivellante)
M-01582	2	1	26,30	29,10	1,98		PIS	Audi 80/90 ZF
M-01510	2	1	26,80	29,10	2,30			Mercedes LS2 Jeep
M-01440	2	1	26,90	29,20	2,00		CRE	Audi 80/90 ZF
M-01309	2	2	21,20	29,50	19,50	22,00	CRE	mod. centrale con o-ring in viton - Porsche-Alfa 75 1°serie con mol.x stelo da Ø22
M-01310	2	2	21,20	29,50	19,50	22,00	CRE	mod. centrale con o-ring alta pressione - Alfa 75 1°serie con mol.x stelo da Ø22
M-01336	2	1	26,60	30,40	2,00		DIS	Citroen-Peugeot
M-01305	2	1	26,50	30,50	2,00		CRE	Alfa
M-01505	2	2	26,50	30,50	3,00	27,00		Alfa cambio Selespeed (autolivellante)
M-01448	2	1	26,90	30,60	1,90		DIS	Mazda 6/626
M-01313	2	1	27,20	30,70	2,00		DIS	Sierra -Scorpio-Volvo-TRW
M-01525	2	1	26,60	30,70	2,00			
M-01387	2	1	26,70	30,70	12,20		CRE	Opel Corsa
M-01316	2	2	22,30	30,70	13,50	23,00	CRE	mod. centrale - Alfa 75 con o-ring x stelo da Ø23
M-01338	2	1	28,40	31,00	1,90		DIS	Cavalier
M-01354	2	1	26,80	31,20	1,90			Sierra -Scorpio-Volvo
M-01473	2	1	27,70	31,30	4,00		CRE	Kit riparazione ZF Scania/ Iveco
M-01302	2	1	28,90	31,50	2,00			ZF
M-01326	2	2	28,00	31,50	2,90	28,00		Jaguar (autolivellante) - con oring o-02853B 31 -corda 2,45
M-01317	2	2	23,00	31,60	13,80	23,00	CRE	Alfa 75 2°serie + o-ring in viton x stelo da Ø23
M-01348	2	1	26,60	31,80	1,95			Sierra -Scorpio-VOLVO
M-01413	2	1	29,10	32,00	2,20		CRE	Mercedes LS8 old version
M-01501	2	1	29,50	32,10	2,00			Alfa 75 II serie
M-01522	2	1	30,50	32,50	1,80			LS4
M-01311	2	1	30,20	32,60	2,00			
M-01359	2	2	29,10	32,80	2,90	29,50		I/D - XJ40 (autolivellante)
M-01475	2	1	27,40	32,80	3,95			per kit zf Scania /Iveco
M-01489	2	1	29,90	32,90	2,20			Toyota Landcruiser
M-01351	2	1	29,00	33,00	2,50		CRE	Cavalier Saginaw
M-01466	2	1	30,90	33,70	3,40			veicoli commerciali-Mercedes benz.LK-1924/46
M-01300	2	1	31,60	34,40	2,00		CRE	
M-01342	2	1	30,90	34,90	2,30		CRE	Peugeot
M-01465	2	1	22,20	35,00	0,40			veicoli commerciali-rondella PTFE autolivellante per autocarro
M-01536	2	1	32,20	35,00	2,40			Mercedes
M-01504	2	1	31,10	35,10	1,90			
M-01491	2	1	31,40	35,40	5,00			Toyota Landcruiser
M-01446	2	2	33,00	35,80	2,50	36,00	DIS	Integrato con F-00318 Mazda 6 626 crem.Ø36
M-01435	2	1	32,10	35,90	2,00		PIS	pistone Ø35,9 - Ford Fusion/Fiesta U.Tipo
M-01449	2	1	33,00	36,00	1,50		PIS	Mazda 6/626
M-01425	2	2	31,60	36,00	2,00	32,00		Mercedes 5000/560SL (autolivellante)
M-01447	2	1	32,00	36,00	9,80		PIS	Mazda 6/626
M-01421	2	1	33,10	36,10	1,80		DIS	Honda CRV
M-01376	2	1	33,10	36,10	1,90		DIS	Toyota,Mitsubishi,Peugeot Ø44
M-01481	2	1	33,50	36,10	2,40			Subaru/Suzuki
M-01377	2	1	32,80	36,20	2,00		DIS	Hyundai
M-01539	2	1	31,90	36,50	2,00			Bmw 316 E 30
M-01386	2	1	32,80	36,60	2,50		CRE	Opel corsa

Codice Code Код	Min Ord Мин. коли- чество заказа	Dis. Тип	d1	D	S	Ø stelo	Uso Use in Приме- нение	Descrizione per utilizzo Use remarks Примечания
			Размеры					
M-01406	2	1	35,10	36,70	3,06		CRE	Citroen CX
M-01576	2	1	33,80	36,80	1,95		DIS	
M-01535	2	2	30,00	37,00	2,20			
M-01408	2	2	31,30	37,00	4,00	32,00		Iveco (autolivellante)
M-01502	2	1	32,10	37,10	2,25			
M-01394	2	1	34,50	37,50	1,90		DIS	Peugeot Laguna (KOJO)
M-01329	2	1	32,50	37,50	2,30		CRE	Clio / Peugeot
M-01471	2	1	34,00	37,50	2,60		CRE	Vw golf
M-01509	2	1	34,70	37,50	2,95			Mercedes LS2 Jeep
M-01399	2	1	34,70	37,50	4,50		CRE	Alfa 33
M-01451	2	1	35,00	37,60	2,00		CRE	Audi A4/VW Passat
M-01401	2	1	25,65	37,75	5,25		CRE	Astra TRW
M-01568	2	1	34,20	37,80	2,20		DIS	Cavalier Saab Saginaw
M-01346	2	1	32,90	37,90	2,20			Jaguar Adwest-Rover 3/4 bolt
M-01419	2	1	34,00	38,00	3,00			
M-01438	2	2	34,80	38,00	3,70			Rover a settore
M-01506	2	1	34,90	38,10	1,90		DIS	Peugeot 206 ZF
M-01411	2	1	35,80	38,10	2,00		DIS	Mercedes 250
M-01430	2	1	35,80	38,10	2,00		DIS	Daily '05-Audi A4 ZF
M-01424	2	1	35,80	38,10	2,00		DIS	Mercedes
M-01339	2	1	32,85	38,10	2,20		CRE	Peugeot -Peugeot
M-01479	2	1	35,00	38,10	2,25		CRE	Suzuki Vitara SE 416
M-01371	2	1	34,40	38,10	2,25		DIS	Cavalier Saab Saginaw
M-01572	2	1	34,40	38,20	1,85			
M-01301	2	1	35,60	38,20	2,00		DIS	Alfa
M-01472	2	1	36,00	38,20	2,08		DIS	Ford Granada/Scorpio
M-01488	2	1	35,80	38,20	4,00			Toyota Landcruiser
M-01400	2	1	34,50	38,30	1,85		CRE	
M-01304	2	1	34,30	38,30	2,00		DIS	Alfa 75 ZF
M-01334	2	1	33,80	38,30	2,10		DIS	Austin 1800/2200
M-01482	2	1	35,70	38,30	2,30		CRE	Mercedes classe A
M-01530	2	1	33,70	38,30	2,50		CRE	R. Laguna, Megane, Scenic
M-01507	2	1	35,60	38,40	1,95		CRE	Peugeot 206 ZF
M-01503	2	1	34,40	38,40	2,45			
M-01370	2	1	35,70	38,50	2,00		DIS	Fiesta, Mondeo
M-01464	2	1	35,50	38,50	2,10		DIS	Ford Fiesta/Fusion
M-01391	2	1	35,00	38,70	1,90			
M-01569	2	1	35,80	38,80	2,00		CRE	
M-01455	2	1	35,20	38,80	2,56		CRE	Peugeot 206
M-01314	2	1	35,00	39,00	2,00		CRE	Fiat Tipo, VW Golf
M-01355	2	1	35,90	39,00	2,00			Bmw
M-01350	2	1	32,50	39,10	2,20			XJ40
M-01454	2	1	36,60	39,20	2,00		CRE	
M-01463	2	1	35,80	39,20	2,00		DIS	ZF Golf MK IV 1997
M-01347	2	1	34,00	39,20	2,30		CRE	Saab
M-01392	2	2	31,00	39,40	4,00	32,00		Mercedes 560SL (autolivellante)
M-01485	2	1	36,90	39,50	2,25		CRE	Saab 9.5 2004/05 (x pistone K-00005)
M-01414	2	1	36,90	39,60	2,80		CRE	LS8 old version
M-01345	2	1	35,20	40,00	2,30		CRE	Peugeot
M-01385	2	1	36,40	40,00	2,50		CRE	Audi - Passat KOJO
M-01541	2	1	35,40	40,10	2,50		CRE	Vectra C

**CRE
DIS
PIS**Cremagliera
Distributore
PistoneRack
Pignon
PistonГидроцилиндр
Распределитель
Поршень

Codice Code Код	Min Ord Мин. коли- чество заказа	Dis. Тип	d1	D	S	Ø stelo	Uso Use in Приме- нение	Descrizione per utilizzo Use remarks Примечания
			Размеры					
M-01495	2	1	35,70	40,10	3,05			Honda Civic
● M-01560	2	1	36,90	40,20	1,95		CRE	Focus
M-01398	2	1	36,60	40,20	2,50		CRE	Fiat Fiorino SAGINAW
M-01533	2	1	36,60	40,20	2,80		CRE	Peugeot 407
M-01531	2	2	37,60	40,20	4,40		CRE	
M-01369	2	2	37,80	40,20	4,40		CRE	Bmw
M-01328	2	1	36,40	40,40	2,00		CRE	Fiat TIPO - tappo largo
M-01432	2	1	37,90	40,40	2,00			
M-01514	2	1	36,80	40,60	1,95		CRE	Matiz
M-01431	2	1	38,00	40,60	2,00		CRE	Daily 05-Audi A4 ZF
M-01352	2	1	35,80	40,60	2,40		CRE	Saab
M-01540	2	1	38,00	40,60	2,60		CRE	
M-01319	2	1	36,60	41,10	2,25		CRE	Rover, Volvo
M-01332	2	1	36,80	41,20	2,30		CRE	Thema I Serie rover - Volvo - Granada - MK II e III Serie
M-01358	2	1	37,10	41,30	1,90		CRE	Granada MK III
M-01544	2	1	37,00	41,40	2,40		CRE	Opel Vectra C
M-01420	2	1	37,50	41,90	3,00		CRE	Honda CRV
M-01467	2	1	34,30	41,90	3,40		DIS	Mercedes benz.LK-1924/46
M-01306B	2	1	38,00	42,00	2,00		CRE	Ford Mondeo ZF (nero)
M-01306A	2	1	38,00	42,00	2,00		CRE	Mondeo (azzurro)
M-01306	2	1	38,00	42,00	2,00		CRE	Mondeo / ZF (Bianco)
M-01353	2	1	36,80	42,20	1,90			Granada MK III S.
● M-01559	2	1	38,70	42,20	2,00		CRE	Toyota Avensis - Ford C-Max
M-01331	2	1	38,10	42,60	2,00		CRE	Lancia Thema
M-01378	2	1	39,20	42,70	2,00		CRE	Hyundai
M-01333	2	1	39,80	42,80	2,45		CRE	Lancia K
M-01357	2	1	37,00	42,80	3,00		CRE	SD1 MKII (A&A)
● M-01549	2	1	39,10	42,90	2,00		CRE	Nissan Altima, Eclipse/Talon, Mazda 626
● M-01564	2	1	39,20	42,90	2,50		CRE	Audi, Suzuki
M-01349	2	1	37,00	43,00	1,90			Granada MK III S.
● M-01571	2	1	39,60	43,10	2,50		CRE	
M-01468	2	1	40,60	43,20	2,00		CRE	Peugeot 406 servotronic
M-01458	2	1	41,00	43,50	2,00		CRE	Ford 43,5X2
M-01412	2	1	38,70	43,50	2,50		CRE	Citroen Jumpy
M-01480	2	1	41,00	43,50	2,50		CRE	Suzuki / Space Wagon
M-01538	2	1	40,60	44,00	2,00		CRE	Alfa 159 ZF
M-01498	2	1	40,70	44,00	2,10		CRE	Hyundai Sonata
M-01363	2	1	39,90	44,00	3,00			44 MM O/D - Rover SD1 Burman
M-01499	2	1	40,50	44,10	2,50		CRE	Mitsubishi Eclipse
M-01365	2	1	41,60	44,20	3,00			1.75" O/D - Princess/SD1/ XJ6
M-01364	2	1	40,30	44,30	2,65		CRE	1.75" O/D - Jaguar XJ6-II E III Serie Adwest
M-01360	2	1	40,10	44,30	2,70			Jaguar XJ6 I e II Serie
M-01388	2	1	38,80	44,50	2,00		CRE	Ford Galaxy-VW Sharan
M-01423	2	1	41,45	44,75	2,20		CRE	Mitsubishi
M-01410	2	1	42,30	45,00	2,00		CRE	Mercedes 250
M-01418	2	1	41,00	45,00	3,00		CRE	
M-01407	2	2	42,50	45,00	4,40		CRE	Bmw
● M-01573	2	1	40,00	45,10	1,80		CRE	
M-01548	2	1	41,20	45,10	1,95		CRE	Ford Taurus,S-Max
M-01436	2	1	42,60	45,20	2,05		PIS	pistone Ø45 - Mercedes classe S
● M-01578	2	1	40,30	45,20	3,10			

Codice Code Код	Min Ord Мин. колич- ество заказа	Dis. Тип	d1	D	S	∅ stelo	Uso Use in Приме- нение	Descrizione per utilizzo Use remarks Примечания
			Размеры					
• M-01547	2	1	41,80	45,30	1,95		CRE	BMW
M-01529	2	1	41,70	45,30	2,00			Peugeot 607,Citroen C5
• M-01581	2	2	39,50	45,40	4,00	40,30		autolivellante x albero Ø 40,3
• M-01587	2	1	42,20	45,80	1,80		CRE	GMC, Chevrolet
• M-01550	2	1	42,50	46,10	2,00		CRE	Hyundai Santa Fè
• M-01583	2	1	41,80	46,20	3,00			
M-01487	2	1	42,80	46,30	2,02		CRE	Eurovan diesel
M-01375	2	1	40,80	46,40	2,00		CRE	BMW Z3
M-01543	2	1	41,70	46,40	2,30		CRE	Renault Master, Espace
M-01542	2	1	42,80	46,80	2,50		CRE	Toyota Highlander
M-01434	2	1	44,35	47,35	3,85		CRE	Volkswagen,Transporter
• M-01570	2	1	42,60	47,60	1,95		CRE	
• M-01577	2	1	43,80	47,80	2,00			
M-01567	2	1	44,50	48,00	2,50		CRE	Chevrolet Colorado, Jeep Liberty
M-01517	2	1	44,20	48,00	2,85			
M-01516	2	1	44,00	48,00	2,85			
M-01526	2	2	42,80	48,00	3,90	43,50		Mercedes (autolivellante)
M-01443	2	1	44,50	48,10	1,95		CRE	Ford transit ZF
M-01442	2	1	45,60	48,20	2,00		CRE	Ford transit ZF
M-01486	2	1	45,80	48,30	2,00		CRE	Mercedes Vito (X pistone Ø30x48)
M-01395	2	1	43,70	48,30	3,00			TAS 86
M-01433	2	1	45,80	48,40	2,00		CRE	Volkswagen transporter ZF
M-01515	2	1	43,90	48,50	2,80		CRE	Opel Movano
M-01444	2	2	46,20	48,70	4,50		CRE	Ford Transit ZF
M-01441	2	2	45,30	49,00	1,70		CRE	Audi 80/90 ZF
• M-01566	2	1	44,30	49,10	2,55		CRE	Ford Transit U.T
M-01303	2	1	45,20	49,50	2,25		CRE	Ducato I serie
M-01335	2	1	45,10	49,60	2,00		CRE	Ducato II Serie
M-01415	2	1	47,40	50,00	2,31		CRE	LS8 old version
M-01532	2	1	46,50	50,20	1,90		CRE	Kia Sedona
M-01422	2	1	47,20	50,30	2,40		CRE	Toyota Landcruiser
• M-01552	2	1	46,90	50,30	3,50			
• M-01575	2	1	47,00	50,40	2,20		CRE	
M-01513	2	1	45,50	50,40	2,50		CRE	Ford Transit
M-01545	2	1	47,20	50,60	2,10		CRE	Mercedes Vito
• M-01556	2	1	45,80	50,80	4,00			Lada Niva 4/4 tacche
M-01437	2	1	47,50	51,00	2,35		PIS	pistone Ø50 - Mercedes classe S
M-01450	2	1	47,00	51,00	2,60		CRE	Mazda 6/626 (cre. Ø36)
M-01330	2	1	47,30	51,40	2,10		DIS	Bendix
M-01518	2	1	44,20	51,70	2,20			
• M-01563	2	1	50,00	52,20	2,00			Nissan Patrol
M-01483	2	1	48,80	52,30	2,00		CRE	Mercedes
• M-01562	2	1	47,30	52,30	2,35		CRE	Ducato
• M-01551	2	1	50,20	52,40	1,95			Lexus LS400
M-01362	2	1	49,00	53,40	2,25		CRE	Mercedes Vito e Sprinter
M-01459	2	1	48,00	54,00	1,50			veicoli commerciali-per kit camion ammortizzatore autolivellante Ø70
• M-01557	2	1	49,80	54,60	2,70		CRE	Iveco C13, C15
M-01494	2	1	51,20	54,70	2,50		CRE	Mercedes Nuovo Sprinter Ø30
• M-01553	2	1	51,80	54,90	3,40			
M-01496	2	1	51,00	55,00	2,10			Honda Civic
M-01478	2	1	52,10	55,40	1,95		CRE	Suzuki Vitara SE 416

**CRE
DIS
PIS**Cremagliera
Distributore
PistoneRack
Pignon
PistonГидроцилиндр
Распределитель
Поршень

Codice Code Код	Min Ord Мин. коли- чество заказа	Dis. Тип	d1	D	S	Ø stelo	Use in Prime- niente	Descrizione per utilizzo Use remarks Примечания
			Размеры					
M-01477	2	1	56,90	60,20	2,00		CRE	Suzuki Vitara SE 416
M-01521	2	1	55,60	60,60	1,90			LS4
M-01476	2	1	58,10	61,50	2,30		CRE	Suzuki Vitara SE 416
M-01520	2	1	59,80	64,60	1,90			LS4
M-01500	2	1	61,00	64,60	2,30			Mitsubishi Pajero
M-01373	2	1	63,30	66,10	2,50		CRE	Bendix
M-01396	2	1	63,30	67,30	2,00			TAS 86
M-01519	2	1	64,00	68,60	2,00			
• M-01574	2	1	65,00	69,50	1,40			
M-01492	2	1	66,60	69,60	2,25			Toyota Landcruiser
M-01393	2	1	66,40	70,00	2,30		PIS	Mitsubishi L200
M-01366	2	1	66,40	70,00	3,20			2,760" O/D - Land/Range Rover Pistone 4 bull.
M-01474	2	1	66,00	70,00	5,90		DIS	per kit cilindro ZF Iveco
• M-01555	2	1	56,20	70,20	6,70			Kit segmenti in PTFE dis.1 Ø56,2x70,2 S6,7
M-01368	2	1	65,30	70,50	3,90			Land,Range Rover(6bolt)
M-01409	2	1	66,90	71,10	6,90			
M-01537	2	1	67,80	71,20	2,80			Mercedes
• M-01554	2	1	67,90	71,90	1,50			
M-01462	2	1	68,30	73,30	9,50			veicoli commerciali-per kit camion ammortizzatore autolivellante Ø70
M-01416	2	1	69,80	74,70	2,25		DIS	LS8 (1°revisione)
M-01497	2	1	69,80	74,70	2,25		DIS	LS8 (2°revisione)
M-01367	2	1	73,00	76,60	3,20			3.015" O/D - Land/Range Rover Pistone 3 bull.
M-01490	2	1	75,90	78,80	2,50			Toyota Landcruiser
M-01374	2	1	78,00	80,60	2,50		CRE	Bendix
M-01457	2	1	79,00	84,00	1,00		CRE	Pompa ZF
• M-01565	2	1	81,20	84,60	3,45			
M-01456	2	1	80,20	85,20	1,00		CRE	Pompa ZF
M-01461	2	1	84,00	89,00	15,00			veicoli commerciali-per kit camion ammortizzatore autolivellante Ø70
M-01512	2	1	87,20	89,80	3,30		Mer- cedes LS2 Jeep	Audi, Suzuki
M-01460	2	1	84,00	90,00	1,50			veicoli commerciali-per kit camion ammortizzatore autolivellante Ø70
M-01534	2	1	101,40	105,00	2,20			TAS 75
M-01523	2	1	102,00	105,20	2,70			LS4
• M-01579	2	1	107,50	111,50	1,95			TAS 80
M-01397	2	1	107,50	111,50	2,25			TAS 86
M-01429	2	1	103,00	112,00	4,80			scatola a settore
M-01417	2	1	110,00	115,50	2,80		CRE	LS8 old version
M-01361	2	3					CRE	Mercedes Vito/Sprinter (segm aperto)
M-01426	2	3					CRE	XJ40
M-01427	2	3					CRE	Mitsubishi Eclipse
M-01428	2	3						Jaguar
M-01546	2	3					CRE	Mercedes (aperto)

Segmenti in P.T.F.E.

P.T.F.E. piston rings

Тефлоновые кольца

M

in ordine di disegno

sorted by drawing
сортировка по типу

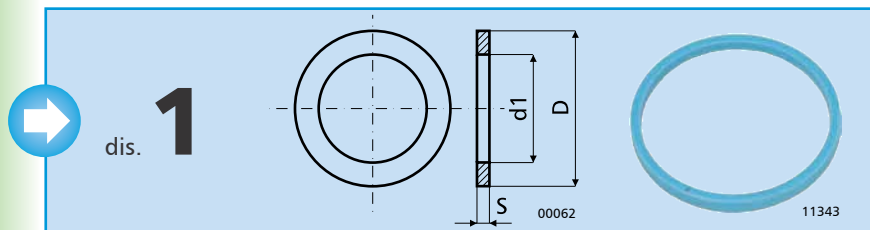

Codice Code Код	Min Ord Мин. количество заказа	Dis. Тип	d1	D	S	Ø stelo	Uso Use in Приме- нение	Descrizione per utilizzo Use remarks Примечания
			Размеры					
M-01558	2	1	7,10	9,50	2,50			
M-01379	2	1	6,80	10,00	1,80		DIS	Fiesta/Mondeo
M-01484	2	1	8,20	11,20	2,30		DIS	Ford Focus
M-01561	2	1	10,70	13,50	3,25		DIS	Ducato
M-01584	2	1	11,20	14,10	1,50		DIS	Mercedes
M-01585	10	1	12,80	15,70	1,40			Mercedes
M-01380	2	1	14,10	16,70	1,15			F.Fiesta/Mondeo
M-01586	10	1	15,90	18,70	1,40			Mercedes
M-01493	2	1	18,60	20,20	1,95		DIS	Jaguar Servotronic
M-01381	2	1	18,20	20,20	4,30			Citroen
M-01469	2	1	19,10	20,70	2,00		CRE	Peugeot 406 servotronic
M-01384	2	1	19,70	21,30	2,00		CRE	Ford Mazda
M-01527	2	1	19,40	22,00	2,00			Audi 100
M-01511	2	1	20,80	23,80	2,25			Mercedes LS2 /Jeep
M-01453	2	1	20,80	24,10	1,75		DIS	
M-01508	2	1	18,00	24,20	2,90			Alfa Cambio Selespeed
M-01402	2	1	21,12	24,40	1,60		DIS	VW - Audi- Octavia
M-01341	2	1	20,40	24,80	2,00		CRE	Peugeot
M-01340	2	1	18,10	25,00	3,44		CRE	
M-01383	2	1	23,80	25,50	1,10		CRE	Citroen
M-01382	2	1	23,70	25,50	2,60		DIS	Citroen
M-01580	2	1	24,50	26,40	2,50			Fascia in teflon 8098
M-01452	2	1	25,10	26,60	2,00		CRE	Audi A4 /VW Passat
M-01470	2	1	25,20	26,70	2,00		CRE	Peugeot 406 servotronic
M-01405	2	1	25,80	27,20	3,00		CRE	Citroen CX
M-01439	2	1	24,90	27,50	2,02		CRE	Audi 80/90 ZF
M-01312	2	1	24,80	28,00	2,00			
M-01343	2	1	24,00	28,00	2,30			Rover SDI
M-01528	2	1	25,50	28,10	1,98			Audi 100
M-01582	2	1	26,30	29,10	1,98		PIS	Audi 80/90 ZF
M-01510	2	1	26,80	29,10	2,30			Mercedes LS2 Jeep
M-01440	2	1	26,90	29,20	2,00		CRE	Audi 80/90 ZF
M-01336	2	1	26,60	30,40	2,00		DIS	Citroen-Peugeot
M-01305	2	1	26,50	30,50	2,00		CRE	Alfa
M-01448	2	1	26,90	30,60	1,90		DIS	Mazda 6/626
M-01525	2	1	26,60	30,70	2,00			
M-01313	2	1	27,20	30,70	2,00		DIS	Sierra -Scorpio-Volvo-TRW
M-01387	2	1	26,70	30,70	12,20		CRE	Opel Corsa
M-01338	2	1	28,40	31,00	1,90		DIS	Cavalier
M-01354	2	1	26,80	31,20	1,90			Sierra -Scorpio-Volvo
M-01473	2	1	27,70	31,30	4,00		CRE	Kit riparazione ZF Scania/ Iveco
M-01302	2	1	28,90	31,50	2,00			ZF

CRE Cremagliera Rack Гидроцилиндр
DIS Distributore Pignon Распределитель
PIS Pistone Piston Поршень



Codice Code Код	Min Ord Мин. коли- чество заказа	Dis. Тип	d1	D	S	Ø stelo	Use in Prime- niente	Descrizione per utilizzo Use remarks Примечания
			Размеры					
M-01348	2	1	26,60	31,80	1,95			Sierra -Scorpio-VOLVO
M-01413	2	1	29,10	32,00	2,20		CRE	Mercedes LS8 old version
M-01501	2	1	29,50	32,10	2,00			Alfa 75 II serie
M-01522	2	1	30,50	32,50	1,80			LS4
M-01311	2	1	30,20	32,60	2,00			
M-01475	2	1	27,40	32,80	3,95			per kit zf Scania /Iveco
M-01489	2	1	29,90	32,90	2,20			Toyota Landcruiser
M-01351	2	1	29,00	33,00	2,50		CRE	Cavalier Saginaw
M-01466	2	1	30,90	33,70	3,40			veicoli commerciali-Mercedes benz.LK-1924/46
M-01300	2	1	31,60	34,40	2,00		CRE	
M-01342	2	1	30,90	34,90	2,30		CRE	Peugeot
M-01465	2	1	22,20	35,00	0,40			veicoli commerciali-rondella PTFE autolivellante per autocarro
M-01536	2	1	32,20	35,00	2,40			Mercedes
M-01504	2	1	31,10	35,10	1,90			
M-01491	2	1	31,40	35,40	5,00			Toyota Landcruiser
M-01435	2	1	32,10	35,90	2,00		PIS	pistone Ø35,9 - Ford Fusion/Fiesta U.Tipo
M-01449	2	1	33,00	36,00	1,50		PIS	Mazda 6/626
M-01447	2	1	32,00	36,00	9,80		PIS	Mazda 6/626
M-01421	2	1	33,10	36,10	1,80		DIS	Honda CRV
M-01376	2	1	33,10	36,10	1,90		DIS	Toyota,Mitsubishi,Peugeot Ø44
M-01481	2	1	33,50	36,10	2,40			Subaru/Suzuki
M-01377	2	1	32,80	36,20	2,00		DIS	Hyundai
M-01539	2	1	31,90	36,50	2,00			Bmw 316 E 30
M-01386	2	1	32,80	36,60	2,50		CRE	Opel corsa
M-01406	2	1	35,10	36,70	3,06		CRE	Citroen CX
M-01576	2	1	33,80	36,80	1,95		DIS	
M-01502	2	1	32,10	37,10	2,25			
M-01394	2	1	34,50	37,50	1,90		DIS	Peugeot Laguna (KOJO)
M-01329	2	1	32,50	37,50	2,30		CRE	Clio / Peugeot
M-01471	2	1	34,00	37,50	2,60		CRE	Vw golf
M-01509	2	1	34,70	37,50	2,95			Mercedes LS2 Jeep
M-01399	2	1	34,70	37,50	4,50		CRE	Alfa 33
M-01451	2	1	35,00	37,60	2,00		CRE	Audi A4/VW Passat
M-01401	2	1	25,65	37,75	5,25		CRE	Astra TRW
M-01568	2	1	34,20	37,80	2,20		DIS	Cavalier Saab Saginaw
M-01346	2	1	32,90	37,90	2,20			Jaguar Adwest-Rover 3/4 bolt
M-01419	2	1	34,00	38,00	3,00			
M-01506	2	1	34,90	38,10	1,90		DIS	Peugeot 206 ZF
M-01424	2	1	35,80	38,10	2,00		DIS	Mercedes
M-01430	2	1	35,80	38,10	2,00		DIS	Daily '05-Audi A4 ZF
M-01411	2	1	35,80	38,10	2,00		DIS	Mercedes 250
M-01339	2	1	32,85	38,10	2,20		CRE	Peugeot -Peugeot
M-01479	2	1	35,00	38,10	2,25		CRE	Suzuki Vitara SE 416
M-01371	2	1	34,40	38,10	2,25		DIS	Cavalier Saab Saginaw
M-01572	2	1	34,40	38,20	1,85			
M-01301	2	1	35,60	38,20	2,00		DIS	Alfa
M-01472	2	1	36,00	38,20	2,08		DIS	Ford Granada/Scorpio
M-01488	2	1	35,80	38,20	4,00			Toyota Landcruiser
M-01400	2	1	34,50	38,30	1,85		CRE	
M-01304	2	1	34,30	38,30	2,00		DIS	Alfa 75 ZF
M-01334	2	1	33,80	38,30	2,10		DIS	Austin 1800/2200
M-01482	2	1	35,70	38,30	2,30		CRE	Mercedes classe A



Segmenti in P.T.F.E.

P.T.F.E. piston rings
Тefлоновые кольца

in ordine di disegno

sorted by drawing
сортировка по муну

Codice Code Код	Min Ord Мин. коли- чество заказа	Dis. Тип	d1	D	S	Ø stelo	Uso Use in Приме- нение	Descrizione per utilizzo Use remarks Примечания
			Размеры					
M-01530	2	1	33,70	38,30	2,50		CRE	R. Laguna, Megane, Scenic
M-01507	2	1	35,60	38,40	1,95		CRE	Peugeot 206 ZF
M-01503	2	1	34,40	38,40	2,45			
M-01370	2	1	35,70	38,50	2,00		DIS	Fiesta, Mondeo
M-01464	2	1	35,50	38,50	2,10		DIS	Ford Fiesta/Fusion
M-01391	2	1	35,00	38,70	1,90			
M-01569	2	1	35,80	38,80	2,00		CRE	
M-01455	2	1	35,20	38,80	2,56		CRE	Peugeot 206
M-01355	2	1	35,90	39,00	2,00			Bmw
M-01314	2	1	35,00	39,00	2,00		CRE	Fiat Tipo, VW Golf
M-01350	2	1	32,50	39,10	2,20			XJ40
M-01463	2	1	35,80	39,20	2,00		DIS	ZF Golf MK IV 1997
M-01454	2	1	36,60	39,20	2,00		CRE	
M-01347	2	1	34,00	39,20	2,30		CRE	Saab
M-01485	2	1	36,90	39,50	2,25		CRE	Saab 9.5 2004/05 (x pistone K-00005)
M-01414	2	1	36,90	39,60	2,80		CRE	LS8 old version
M-01345	2	1	35,20	40,00	2,30		CRE	Peugeot
M-01385	2	1	36,40	40,00	2,50		CRE	Audi - Passat KOJO
M-01541	2	1	35,40	40,10	2,50		CRE	Vectra C
M-01495	2	1	35,70	40,10	3,05			Honda Civic
M-01560	2	1	36,90	40,20	1,95		CRE	Focus
M-01398	2	1	36,60	40,20	2,50		CRE	Fiat Fiorino SAGINAW
M-01533	2	1	36,60	40,20	2,80		CRE	Peugeot 407
M-01328	2	1	36,40	40,40	2,00		CRE	Fiat TIPO - tappo largo
M-01432	2	1	37,90	40,40	2,00			
M-01514	2	1	36,80	40,60	1,95		CRE	Matiz
M-01431	2	1	38,00	40,60	2,00		CRE	Daily 05-Audi A4 ZF
M-01352	2	1	35,80	40,60	2,40		CRE	Saab
M-01540	2	1	38,00	40,60	2,60		CRE	
M-01319	2	1	36,60	41,10	2,25		CRE	Rover, Volvo
M-01332	2	1	36,80	41,20	2,30		CRE	Thema I Serie rover - Volvo - Granada - MK II e III Serie
M-01358	2	1	37,10	41,30	1,90		CRE	Granada MK III
M-01544	2	1	37,00	41,40	2,40		CRE	Opel Vectra C
M-01420	2	1	37,50	41,90	3,00		CRE	Honda CRV
M-01467	2	1	34,30	41,90	3,40		DIS	Mercedes benz.LK-1924/46
M-01306B	2	1	38,00	42,00	2,00		CRE	Ford Mondeo ZF (nero)
M-01306	2	1	38,00	42,00	2,00		CRE	Mondeo / ZF (Bianco)
M-01306A	2	1	38,00	42,00	2,00		CRE	Mondeo (azzurro)
M-01353	2	1	36,80	42,20	1,90			Granada MK III S.
M-01559	2	1	38,70	42,20	2,00		CRE	Toyota Avensis - Ford C-Max
M-01331	2	1	38,10	42,60	2,00		CRE	Lancia Thema
M-01378	2	1	39,20	42,70	2,00		CRE	Hyundai
M-01333	2	1	39,80	42,80	2,45		CRE	Lancia K
M-01357	2	1	37,00	42,80	3,00		CRE	SD1 MKII (A&A)
M-01549	2	1	39,10	42,90	2,00		CRE	Nissan Altima, Eclipse/Talon, Mazda 626
M-01564	2	1	39,20	42,90	2,50		CRE	Audi, Suzuki
M-01349	2	1	37,00	43,00	1,90			Granada MK III S.
M-01571	2	1	39,60	43,10	2,50		CRE	
M-01468	2	1	40,60	43,20	2,00		CRE	Peugeot 406 servotronic
M-01458	2	1	41,00	43,50	2,00		CRE	Ford 43,5X2
M-01412	2	1	38,70	43,50	2,50		CRE	Citroen Jumpy
M-01480	2	1	41,00	43,50	2,50		CRE	Suzuki / Space Wagon

CRE
DIS
PISCremagliera
Distributore
PistoneRack
Pignon
PistonГидроцилиндр
Распределитель
Поршень

Codice Code Код	Min Ord Мин. коли- чество заказа	Dis. Тип	d1	D	S	Ø stelo	Uso Use in Приме- нение	Descrizione per utilizzo Use remarks Примечания
			Размеры					
M-01538	2	1	40,60	44,00	2,00		CRE	Alfa 159 ZF
M-01498	2	1	40,70	44,00	2,10		CRE	Hyundai Sonata
M-01363	2	1	39,90	44,00	3,00			44 MM O/D - Rover SD1 Burman
M-01499	2	1	40,50	44,10	2,50		CRE	Mitsubishi Eclipse
M-01365	2	1	41,60	44,20	3,00			1.75" O/D - Princess/SD1/ XJ6
M-01364	2	1	40,30	44,30	2,65		CRE	1.75" O/D - Jaguar XJ6-II E III Serie Adwest
M-01360	2	1	40,10	44,30	2,70			Jaguar XJ6 I e II Serie
M-01388	2	1	38,80	44,50	2,00		CRE	Ford Galaxy-VW Sharan
M-01423	2	1	41,45	44,75	2,20		CRE	Mitsubishi
M-01410	2	1	42,30	45,00	2,00		CRE	Mercedes 250
M-01418	2	1	41,00	45,00	3,00		CRE	
• M-01573	2	1	40,00	45,10	1,80		CRE	
M-01548	2	1	41,20	45,10	1,95		CRE	Ford Taurus,S-Max
M-01436	2	1	42,60	45,20	2,05		PIS	pistone Ø45 - Mercedes classe S
• M-01578	2	1	40,30	45,20	3,10			
• M-01547	2	1	41,80	45,30	1,95		CRE	BMW
M-01529	2	1	41,70	45,30	2,00			Peugeot 607,Citroen C5
• M-01587	2	1	42,20	45,80	1,80		CRE	GMC, Chevrolet
• M-01550	2	1	42,50	46,10	2,00		CRE	Hyundai Santa Fè
• M-01583	2	1	41,80	46,20	3,00			
M-01487	2	1	42,80	46,30	2,02		CRE	Eurovan diesel
M-01375	2	1	40,80	46,40	2,00		CRE	BMW Z3
M-01543	2	1	41,70	46,40	2,30		CRE	Renault Master, Espace
M-01542	2	1	42,80	46,80	2,50		CRE	Toyota Highlander
M-01434	2	1	44,35	47,35	3,85		CRE	Volkswagen,Transporter
• M-01570	2	1	42,60	47,60	1,95		CRE	
• M-01577	2	1	43,80	47,80	2,00			
M-01567	2	1	44,50	48,00	2,50		CRE	Chevrolet Colorado, Jeep Liberty
M-01517	2	1	44,20	48,00	2,85			
M-01516	2	1	44,00	48,00	2,85			
M-01443	2	1	44,50	48,10	1,95		CRE	Ford transit ZF
M-01442	2	1	45,60	48,20	2,00		CRE	Ford transit ZF
M-01486	2	1	45,80	48,30	2,00		CRE	Mercedes Vito (X pistone Ø30x48)
M-01395	2	1	43,70	48,30	3,00			TAS 86
M-01433	2	1	45,80	48,40	2,00		CRE	Volkswagen transporter ZF
M-01515	2	1	43,90	48,50	2,80		CRE	Opel Movano
• M-01566	2	1	44,30	49,10	2,55		CRE	Ford Transit U.T
M-01303	2	1	45,20	49,50	2,25		CRE	Ducato I serie
M-01335	2	1	45,10	49,60	2,00		CRE	Ducato II Serie
M-01415	2	1	47,40	50,00	2,31		CRE	LS8 old version
M-01532	2	1	46,50	50,20	1,90		CRE	Kia Sedona
M-01422	2	1	47,20	50,30	2,40		CRE	Toyota Landcruiser
• M-01552	2	1	46,90	50,30	3,50			Ford Galaxy-VW Sharan
• M-01575	2	1	47,00	50,40	2,20		CRE	
M-01513	2	1	45,50	50,40	2,50		CRE	Ford Transit
M-01545	2	1	47,20	50,60	2,10		CRE	Mercedes Vito
• M-01556	2	1	45,80	50,80	4,00			Lada Niva 4/4 tacche
M-01437	2	1	47,50	51,00	2,35		PIS	pistone Ø50 - Mercedes classe S
M-01450	2	1	47,00	51,00	2,60		CRE	Mazda 6/626 (cre. Ø36)
M-01330	2	1	47,30	51,40	2,10		DIS	Bendix
M-01518	2	1	44,20	51,70	2,20			
• M-01563	2	1	50,00	52,20	2,00			Nissan Patrol

Codice Code Код	Min Ord Мин. коли- чество заказа	Dis. Тип	d1	D	S	Ø stelo	Uso Use in Приме- нение	Descrizione per utilizzo Use remarks Примечания
			Размеры					
M-01483	2	1	48,80	52,30	2,00		CRE	Mercedes
• M-01562	2	1	47,30	52,30	2,35		CRE	Ducato
• M-01551	2	1	50,20	52,40	1,95			Lexus LS400
M-01362	2	1	49,00	53,40	2,25		CRE	Mercedes Vito e Sprinter
M-01459	2	1	48,00	54,00	1,50			veicoli commerciali-per kit camion ammortizzatore autolivellante Ø70
• M-01557	2	1	49,80	54,60	2,70		CRE	Iveco C13, C15
M-01494	2	1	51,20	54,70	2,50		CRE	Mercedes Nuovo Sprinter Ø30
• M-01553	2	1	51,80	54,90	3,40			Peugeot 206
M-01496	2	1	51,00	55,00	2,10			Honda Civic
M-01478	2	1	52,10	55,40	1,95		CRE	Suzuki Vitara SE 416
M-01477	2	1	56,90	60,20	2,00		CRE	Suzuki Vitara SE 416
M-01521	2	1	55,60	60,60	1,90			LS4
M-01476	2	1	58,10	61,50	2,30		CRE	Suzuki Vitara SE 416
M-01520	2	1	59,80	64,60	1,90			LS4
M-01500	2	1	61,00	64,60	2,30			Mitsubishi Pajero
M-01373	2	1	63,30	66,10	2,50		CRE	Bendix
M-01396	2	1	63,30	67,30	2,00			TAS 86
M-01519	2	1	64,00	68,60	2,00			
• M-01574	2	1	65,00	69,50	1,40			
M-01492	2	1	66,60	69,60	2,25			Toyota Landcruiser
M-01393	2	1	66,40	70,00	2,30		PIS	Mitsubishi L200
M-01366	2	1	66,40	70,00	3,20			2,760" O/D - Land/Range Rover Pistone 4 bull.
M-01474	2	1	66,00	70,00	5,90		DIS	per kit cilindro ZF Iveco
• M-01555	2	1	56,20	70,20	6,70			Kit segmenti in PTFE dis.1 Ø56,2x70,2 S6,7
M-01368	2	1	65,30	70,50	3,90			Land,Range Rover(6bolt)
M-01409	2	1	66,90	71,10	6,90			
M-01537	2	1	67,80	71,20	2,80			Mercedes
• M-01554	2	1	67,90	71,90	1,50			
M-01462	2	1	68,30	73,30	9,50			veicoli commerciali-per kit camion ammortizzatore autolivellante Ø70
M-01416	2	1	69,80	74,70	2,25		DIS	LS8 (1°revisione)
M-01497	2	1	69,80	74,70	2,25		DIS	LS8 (2°revisione)
M-01367	2	1	73,00	76,60	3,20			3.015" O/D - Land/Range Rover Pistone 3 bull.
M-01490	2	1	75,90	78,80	2,50			Toyota Landcruiser
M-01374	2	1	78,00	80,60	2,50		CRE	Bendix
M-01457	2	1	79,00	84,00	1,00		CRE	Pompa ZF
• M-01565	2	1	81,20	84,60	3,45			
M-01456	2	1	80,20	85,20	1,00		CRE	Pompa ZF
M-01461	2	1	84,00	89,00	15,00			veicoli commerciali-per kit camion ammortizzatore autolivellante Ø70
M-01512	2	1	87,20	89,80	3,30			Mercedes LS2 Jeep
M-01460	2	1	84,00	90,00	1,50			veicoli commerciali-per kit camion ammortizzatore autolivellante Ø70
M-01534	2	1	101,40	105,00	2,20			TAS 75
M-01523	2	1	102,00	105,20	2,70			LS4
• M-01579	2	1	107,50	111,50	1,95			TAS 80
M-01397	2	1	107,50	111,50	2,25			TAS 86
M-01429	2	1	103,00	112,00	4,80			scatola a settore
M-01417	2	1	110,00	115,50	2,80		CRE	LS8 old version

CRE	Crema g liera	Rack	Гидроцилиндр
DIS	Distributore	Pignon	Распределитель
PIS	Pistone	Piston	Поршень

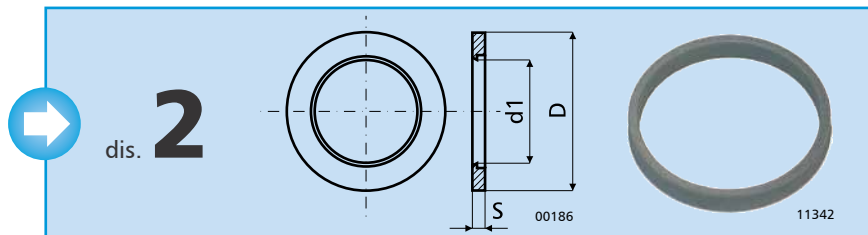

Codice Code Код	Min Ord Мин. коли- чество заказа	Dis. Тип	d1	D	S	Ø stelo	Uso Use in Приме- нение	Descrizione per utilizzo Use remarks Примечания
			Размеры					
M-01445	2	2	10,50	12,90	2,00	11,00		Alfa 156 Servotronic (autolivellante)
M-01324	2	2	9,50	13,10	3,00	10,00		Audi 100 (autolivellante)
M-01404	2	2	13,50	17,40	2,90	14,00		Moto per stelo Ø14 (autolivellante)
M-01389	2	2	15,00	19,00	3,00	15,75		Mercedes (autolivellante)
M-01403	2	2	15,50	19,40	2,90	16,00		per stelo Ø16 (autolivellante)
M-01322	2	2	16,50	20,50	3,00	17,00		BMW (autolivellante)
M-01321	2	2	17,60	21,30	3,00	18,00		BMW (autolivellante)
M-01372	2	2	19,40	23,00	3,00	20,00		Alpine Solara - Jaguar J40 (autolivellante)
M-01327	2	2	19,20	23,20	3,00	20,00		BMW (autolivellante)
M-01308	2	2	21,30	24,30	3,00	22,00		o-ring Ø23,6 C2,6 - Alfa 75, Porsche (autolivellante)
M-01325	2	2	21,60	25,00	2,90	22,00		Audi 80/VW (autolivellante)
M-01524	2	2	21,15	25,00	3,00	21,75		autolivellante
M-01318	2	2	21,50	25,10	3,00	22,00		Thema (autolivellante)
M-01307	2	2	22,20	25,50	2,70	22,00	CRE	Alfa 75 I serie
M-01315	2	2	22,40	25,60	3,00	23,00		Alfa 75 2a serie-Porsche (autolivellante)
M-01320	2	2	23,20	26,50	2,70	23,00	CRE	Alfa 75 2°serie x stelo Ø23
M-01390	2	2	23,40	27,00	3,00	24,00		Mercedes W123 (autolivellante)
M-01344	2	2	20,10	27,70	3,50	21,00		Granada MK2 e 3 serie x stelo da Ø21
M-01323	2	2	24,40	28,00	3,00	25,00		Alpine Solara/Audi 80 (autolivellante)
M-01356	2	2	25,60	28,30	2,90	26,50		Passat/Audi A4 VW (autolivellante)
M-01309	2	2	21,20	29,50	19,50	22,00	CRE	mod. centrale con o-ring in viton - Porsche-Alfa 75 1°serie con mol.x stelo da Ø22
M-01310	2	2	21,20	29,50	19,50	22,00	CRE	mod. centrale con o-ring alta pressione - Alfa 75 1°serie con mol.x stelo da Ø22
M-01505	2	2	26,50	30,50	3,00	27,00		Alfa cambio Selespeed (autolivellante)
M-01316	2	2	22,30	30,70	13,50	23,00	CRE	mod. centrale - Alfa 75 con o-ring x stelo da Ø23
M-01326	2	2	28,00	31,50	2,90	28,00		Jaguar (autolivellante)-con oring o-02853B 31 -corda 2,45
M-01317	2	2	23,00	31,60	13,80	23,00	CRE	Alfa 75 2°serie + o-ring in viton x stelo da Ø23
M-01359	2	2	29,10	32,80	2,90	29,50		I/D - XJ40 (autolivellante)
M-01446	2	2	33,00	35,80	2,50	36,00	DIS	Integrato con F-00318 Mazda 6 626 crem.Ø36
M-01425	2	2	31,60	36,00	2,00	32,00		Mercedes 5000/560SL (autolivellante)
M-01535	2	2	30,00	37,00	2,20			
M-01408	2	2	31,30	37,00	4,00	32,00		Iveco (autolivellante)
M-01438	2	2	34,80	38,00	3,70			Rover a settore
M-01392	2	2	31,00	39,40	4,00	32,00		Mercedes 560SL (autolivellante)
M-01369	2	2	37,80	40,20	4,40		CRE	Bmw
M-01531	2	2	37,60	40,20	4,40		CRE	
M-01407	2	2	42,50	45,00	4,40		CRE	Bmw
M-01581	2	2	39,50	45,40	4,00	40,30		autolivellante x albero Ø 40,3
M-01526	2	2	42,80	48,00	3,90	43,50		Mercedes (autolivellante)
M-01444	2	2	46,20	48,70	4,50		CRE	Ford Transit ZF
M-01441	2	2	45,30	49,00	1,70		CRE	Audi 80/90 ZF



dis. **3**



00127



11344

Codice Code Код	Min Ord Мин. количество заказа	Dis. Тип	L	A	S	Uso Use in Применение	Descrizione per utilizzo Use remarks Примечания
			Размеры				
M-01546	2	3	53,40	2,25	2,20	CRE	Mercedes (aperto)
M-01361	2	3	53,40	2,90	1,60	CRE	Mercedes Vito/Sprinter (segm aperto)
M-01427	2	3	82,50	3,05	3,00	CRE	
M-01428	2	3	93,80	3,05	3,00		Jaguar
M-01426	2	3	98,50	3,05	3,00	CRE	XJ40

Seger

Segers

Стопорные кольца

N



1



11196

Codice Code Код	Min Ord Мин. количество заказа	d1	D	S	Descrizione per utilizzo Use remarks Примечания
		Размеры			
N-02026	10	11,00	14,00	1,00	seger Mini



2



11600

Codice Code Код	Min Ord Мин. количество заказа	d1	D	S	Descrizione per utilizzo Use remarks Примечания
		Размеры			
N-01001	10	30,70	36,50	1,30	
• N-01002	10		37,00	1,30	Seger da interno
• N-01003	10		48,50	1,75	Seger da interno

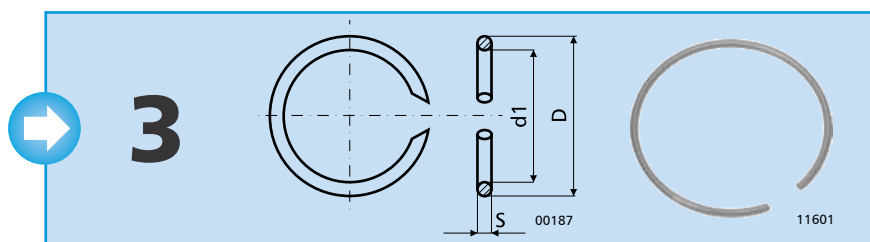

Codice Code Код	Min Ord Мин. количество заказа	d1	D	S	Ø stelo	Descrizione per utilizzo Use remarks Примечания
• N-02028	10			1,80		Segger per boccola porta paraolio filo 1.80 mm, lunghezza 115 mm
• N-02027	10			2,00		Segger per boccola porta paraolio filo 2 mm, lunghezza 145 mm
N-02025	10	10,00	12,00	1,00		per kit pompa Toyota Landcruiser, Suzuki Vitara
N-02003	10	18,00	21,00	1,50	20,00	tenuta pistone
N-02004	10	20,00	23,00	1,50	22,00	tenuta pistone K-00001 Ford Fusion, Fiesta
N-02005	10	21,00	24,00	1,50	23,00	tenuta pistone
N-02006	10	22,00	25,00	1,50	24,00	tenuta pistone
N-02022	10	21,50	25,50	2,00	24,00	tenuta pistone (K-00005) Saab 9-5
N-02007	10	23,00	26,00	1,50	25,00	tenuta pistone K-00007 Ford Mondeo ultimo tipo
N-02008	10	23,00	26,00	1,50	25,70	tenuta pistone
N-02009	10	24,00	27,00	1,50	26,00	tenuta pistone K-00002 Mercedes Class 5, K-00003 Mercedes Class S
N-02010	10	24,00	27,00	1,50	26,70	tenuta pistone
N-02011	10	25,00	28,00	1,50	27,00	tenuta pistone
N-02012	10	25,00	28,00	1,50	27,70	tenuta pistone
N-02013	10	26,00	29,00	1,50	28,00	tenuta pistone
N-02014	10	27,00	30,00	1,50	29,00	tenuta pistone
N-02015	10	28,00	31,00	1,50	30,00	tenuta pistone
N-02023	10	27,50	31,50	2,00	30,00	tenuta pistone K-00004 Mercedes Vito, K-00006 Mercedes,
N-02016	10	30,00	33,00	1,50	32,00	tenuta pistone
N-02017	10	32,00	35,00	1,50	34,00	tenuta pistone
N-02018	10	33,00	36,00	1,50	35,00	tenuta pistone
N-02019	10	34,00	37,00	1,50	36,00	tenuta pistone
N-02020	10	36,00	39,00	1,50	38,00	tenuta pistone
N-02021	10	38,00	41,00	1,50	40,00	tenuta pistone
• N-02029	10	42,50	45,00	2,00		Fermo Boccola Golf 4
N-02002	10		47,50	2,30		Pompe Saginaw
N-02001	10	54,70	59,40	2,30		Pompe Saginaw
N-02024	10	55,80	61,80	3,00		tenuta pistone

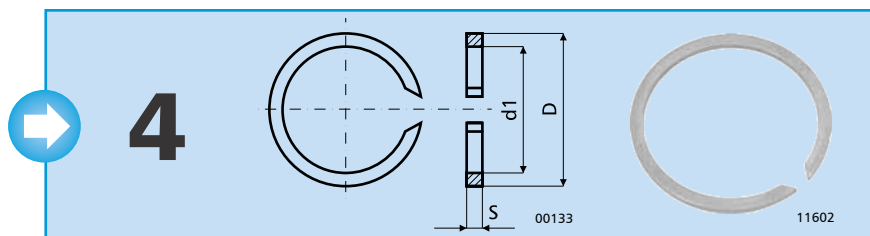



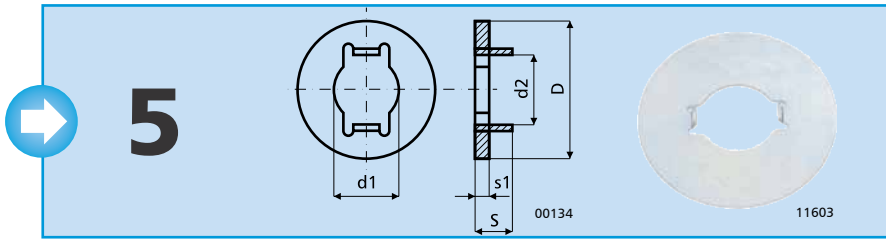

Codice Code Код	Min Ord Мин. количество заказа	d1	D	S	Descrizione per utilizzo Use remarks Примечания
N-04000	10	35,00	40,00	2,00	Eurotech ZF
N-04001	10	36,00	41,00	1,40	Eurotech ZF



Codice Code Код	Min Ord Мин. количество заказа	d1	d2	D	s1	S	Descrizione per utilizzo Use remarks Примечания
		Размеры					
N-03006	10						Honda a cappuccio
N-03005	10	12,20	32,50		3,00		Peugeot-Citroen-Peugeot
N-03002	10	12,40	33,90		3,55		Toyota
N-03003	10	12,40	33,90		3,80		Toyota
N-03010	10	14,20	14,50	37,70	1,00	3,60	Toyota
N-03009	10	14,20	14,50	40,80	1,00	3,60	Toyota
N-03001	10	14,40	36,00			15,40	Toyota
N-03011	10	16,40	18,20	36,10	1,20	4,10	Nissan
N-03008	10	16,50	18,00	37,80	1,20	4,00	Mitsubishi
N-03012	10	16,80	16,50	40,20	1,00	7,60	SDI-MX-1-MX-2
N-03004	10	17,30	36,30		1,00	17,10	Aletta Mazda
N-03013	10	18,00	47,00			1,24	Toyota
N-03007	10	18,50		35,95			



	Codice Code Код	Min Ord Мин. количество заказа	Utilizzo Use remarks Примечания
	N-05001	10	1 aletta Jaguar Triumph stag
	N-05002	10	Gran MX Capri- Cortina
	N-05003	10	Jaguar-Triumph Stag

	Codice Code Код	Min Ord Мин. количество заказа	Utilizzo Use remarks Примечания
	N-05004	10	parte centrale con alette e 2 fori - Saginaw
	N-05005	10	Alternativa all'anello di bloccaggio cuscinetto pignone inferiore (Nissan Maxima 00-03, Altima 02- 06, Infiniti G35 05-06, Infiniti M35 06-07) - cremagliera Koyo

Boccole di scorrimento

Creep bushes

Уплотнительные втулки для агрегатов рулевого управления



Plastica speciale per la produzione di boccole su misura

Special plastic to develop custom bushings

Специальный пластик для изготовления втулок

Codice Code Код	Min Ord (m) Мин. коли- чество заказа (m)	d1 Диаметр
L-10900	3,00	25,00
L-10901	3,00	31,00
L-10902	3,00	37,00
L-10903	3,00	41,00
L-10904	3,00	46,00
L-10909	3,00	50,00
L-10910	3,00	56,00
L-10911	3,00	60,00
L-10912	3,00	65,00
L-10913	3,00	70,00
L-10914	3,00	75,00
L-10915	3,00	80,00

Codice Code Код	Min Ord (m) Мин. коли- чество заказа (m)	d1 Диаметр
L-10916	3,00	85,00
L-10917	3,00	90,00
L-10918	3,00	95,00
L-10919	3,00	100,00
L-10921	3,00	110,00
L-10905	3,00	120,00
L-10922	3,00	120,00
L-10923	3,00	130,00
L-10924	3,00	140,00
L-10906	3,00	150,00
L-10907	3,00	180,00
L-10908	3,00	200,00

Boccole porta-paraolio (dis.1)

Seal-keeping bushes

Опорные втулки

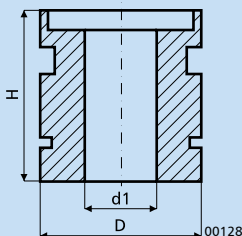

Codice Code Код	Min Ord Мин. коли- чество заказа	d1	D	H	Per paraolio For seals Для сальника	Descrizione per utilizzo Use remarks Примечания
L-10025	2	23,00	38,00	37,00	F-00035 (dis.6)	con foro
L-10003	2	23,00	41,20	34,50	F-00016 (dis.6)	TRW - ALFA 155 + Kit modifica Ø23
L-10005	2	25,00	42,50	34,00	F-00369 (dis.6)	TRW - Alfa 164 L34mm - con foro
L-10007	2	25,00	42,50	34,00	F-00369 (dis.6)	TRW senza foro - Croma L34mm
L-10006	2	25,10	42,50	38,00		Alfa 164 L38mm
L-10008	2	25,10	42,50	38,00		Croma L38mm
L-10001	2	30,00	48,70	41,00	F-00021 (dis.6)	TRW - Ducato + Kit Modifica Ø30
L-10002	2	30,00	48,70	41,00	F-00021 (dis.6)	TRW - Ducato 1° serie + Kit Modifica Ø30



Boccole di scorrimento

Creep bushes

Уплотнительные втулки для агрегатов рулевого управления

Boccole-Rondelle (dis.2)

Bushes-Washers
Втулки-шайбы

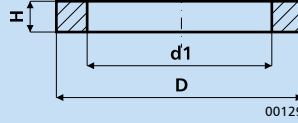

00129

11188

Codice Code Код	Min Ord Мин. коли- чество заказа	d1	D	H	Descrizione per utilizzo Use remarks Примечания
L-10059	2	10,00	20,00	2,36	rondella
L-10038	2	10,10	20,00	2,50	
L-10120	2	14,00	19,00	2,40	Alfa 145/146/156
L-10086	2	15,00	20,00	9,50	boccola Alfa cambio Selespeed (con taglio diritto)
L-10078	2	17,00	42,30	11,10	cappuccio di protezione DIS. Nissan (dentatura interna)
L-10077	2	17,00	62,00	7,50	cappuccio di protezione DIS. Nissan
L-10090	2	18,00	55,20	6,00	cappuccio di protezione(dentatura interna)DISTR.SUP.
L-10085	2	19,00	24,00	9,50	boccola Alfa cambio Selespeed (con taglio diritto)
L-10017	2	19,10	34,20	6,30	
L-10056	2	19,20	34,00	6,00	cuscinetto per distributore TRW con scalino interno
L-10121	2	20,00	43,60		cappuccio di protezione , VW Transporter
L-10079	2	22,00	44,00	6,80	cappuccio di protezione Audi 80/90
L-10094	2	22,20	30,90	2,00	rondella Golf Jetta
L-10093	2	22,20	30,90	3,40	rondella Golf Jetta
L-10052	2	23,00	34,30	4,90	rondella
L-10042	2	24,00	33,00	4,30	rondella Ford Sierra-Ford Scorpio-Volvo 740
L-10045	2	24,00	36,00	4,50	rondella Peugeot 206
L-10053	2	24,00	41,00	4,90	rondella
L-10041	2	24,10	32,50	2,10	rondella Ford Sierra-Ford Scorpio-Volvo 740
L-10065	2	24,50	38,10	4,90	tampone in P.A. per pistone Ø24X39
L-10118	2	25,00	28,00	19,80	Ford Focus, C Max, con taglio a 45°
L-10080	2	25,60	29,60	12,80	boccola di scorrimento SAAB(da chiusa Ø24,5x28,5)
L-10103	2	26,00	30,00	7,30	Boccola Chevrolet Colorado,con taglio a 45°
L-10027	2	26,00	35,00	4,40	
L-10047	2	26,10	42,80	6,10	rondella Mercedes Class
L-10108	2	26,20	38,00	4,40	rondella Peugeot 607
L-10026	2	26,30	34,60	2,00	rondella Toyota Carina
L-10061	2	26,80	30,70	7,40	rondella
L-10087	2	27,00	32,00	4,00	boccola Alfa cambio Selespeed (con taglio diritto)
L-10060	2	28,00	34,95	7,60	rondella
L-10075	2	28,20	37,50	2,00	rondella Audi A6
L-10104	2	28,20	44,70	5,00	boccola Renault Master
L-10131	2	28,50	37,90	5,00	Renault Master
L-10050	2	28,60	39,60	5,00	rondella Alfa 156
L-10073	2	28,80	38,20	3,10	rondella Mercedes Vito
L-10039	2	30,00	39,50	2,00	
L-10066	2	30,10	46,90	5,90	tampone in P.A. per pistone Ø30X48
L-10040	2	30,15	39,50	2,00	rondella cremagliera Ford Transit
L-10064	2	30,50	42,50	5,00	rondella
L-10116	2	32,00	44,00	2,00	rondella Mercedes CL W220
L-10054	2	32,50	36,90	6,00	rondella
L-10110	2	32,60	44,40	4,90	rondella Iveco C13, C15

Boccole di scorrimento

Creep bushes

Уплотнительные втулки для агрегатов рулевого управления



Boccole spingi-asta a mezzaluna (dis.3)

Rod-pulling bushes

Фолье-вставки бокового поджима

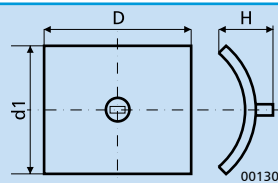

11189

A) Boccole spingi-asta a mezzaluna

Rod-pulling bushes

Фолье-вставки бокового поджима

Codice Code Код	Min Ord Мин. коли- чество заказа	d1	D	H	Ø crem.	Descrizione per utilizzo Use remarks Примечания
• L-10130	2	5,50	38,00	31,00		Boccole spingi-asta x Mercedes Classe A
• L-10129	2	15,50	45,00	35,50		Boccole spingi-asta x Mercedes Classe E U.T, Classe C Ø26
• L-10028/M	2	21,50	24,00	11,50	21,50	Minorata ZF - Golf Corrado
L-10028	2	22,00	24,00	11,50	22,00	ZF - Golf Corrado
• L-10109/M	2	22,70	27,00	16,50	22,50	Minorata, Fiat Marea
• L-10109	2	23,00	27,00	16,50	23,00	Boccola spingi-asta a mezzaluna Fiat Marea
• L-10029/M	2	23,50	25,40	13,00	23,50	Minorata, ZF - Ford Sierra, Lancia Thema - K
L-10029	2	24,00	25,40	13,00	24,00	ZF - Ford Sierra, Lancia Thema - K
• L-10128	2	24,00	34,00	23,50		Boccola spingi-asta Citroen C3
• L-10107/M	2	24,70	30,70	17,10	24,50	Minorata, Alfa 156
• L-10030/M	2	25,00	28,00	16,50	25,50	Minorata, BMW serie 3, Porsche 911 Carrera, Toyota Carina
• L-10107	2	25,00	30,70	17,10	25,00	Boccola spingi-asta a mezzaluna Alfa 156
L-10030	2	25,50	28,00	16,50	26,00	BMW serie 3, Porsche 911 Carrera, Toyota Carina
• L-10031/M	2	26,50	28,00	16,00	25,50	Minorata, Volvo 240-260 ZF, BMW serie 3, Alfa 33, Ford Sierra
L-10031	2	27,00	28,00	16,00	26,00	Volvo 240-260 ZF, BMW serie 3, Alfa 33, Ford Sierra
• L-10032/M	2	27,50	28,00	17,00	27,50	Minorata, VW Transporter,T4, ZF, BMW 325i, VW , BMW serie 5
• L-10089/M	2	27,50	30,00	17,00	23,50	Minorata, Peugeot 206, Golf IV
• L-10119/M	2	27,50	34,40	19,00	25,50	Minorata, Alfa 159
L-10032	2	28,00	28,00	17,00	28,00	VW Transporter ZF, BMW 325i, VW Transporter T4, BMW serie 5,ORIG
L-10032A	2	28,00	28,00	17,00	28,00	VW Transporter ZF, BMW 325i, VW Transporter T4, BMW serie 5
L-10089	2	28,00	30,00	17,00	24,00	Peugeot 206, Golf IV
• L-10127	2	28,00	32,00			Audi A3 Sportback, lato SX
• L-10132	2	28,00	32,00			Audi A3 Sportback, lato DX
• L-10119	2	28,00	34,40	19,00	26,00	Alfa 159
• L-10034/M	2	29,50	32,00	22,00	25,50	Minorata con riga in rilievo sotto - Ford Scorpio ZF - Peugeot 406 - Ferrari 456 GT
L-10034	2	30,00	32,00	22,00	26,00	con riga in rilievo sotto - Ford Scorpio ZF - Peugeot 406 - Ferrari 456 GT
• L-10033/M	2	31,50	31,00	19,00	29,50	Minorata, Ford Transit ZF Opel Vectra Cdi
• L-10035/M	2	31,50	34,00	19,00	27,50	Minorata-Iveco, Daily Turbo ZF
L-10033	2	32,00	31,00	19,00	30,00	Ford Transit ZF Opel Vectra Cdi
L-10035	2	32,00	34,00	19,00	28,00	Iveco Daily Turbo ZF
• L-10125	2	34,50	35,20	20,00	30,00	Ford Transsit U.T
• L-10083/M	2	34,50	37,00	18,00	31,50	Minorata, Range Rover MK3
L-10083	2	35,00	37,00	18,00	32,00	Range Rover MK3



Boccole di scorrimento

Creep bushes

Уплотнительные втулки для агрегатов рулевого управления

B) Pistoni spingi-asta

Rod-pulling pistons

Поршень бокового поджима



11857

Codice Code Код	Min Ord Мин. количество заказа	d1	D	H	Ø crem.	Descrizione per utilizzo Use remarks Примечания
		Размеры				
L-10062	2	20,00	28,20	25,00		(modello B)
L-10063	2	24,00	32,80	28,00		Volvo, Ford - (modello B)

Boccole-Bronzine (dis.4)

Rod bushes

Бронзовые втулки

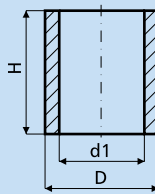

00131



11190

Codice Code Код	Min Ord Мин. количество заказа	d1	D	H	Descrizione per utilizzo Use remarks Примечания
		Размеры			
L-10091	2	17,00	25,20	16,50	modifica x paraolio stelo Ø17 (d2 20,5)
L-10004	2	31,70	35,10	23,10	Rover
L-10000	2	31,75	35,00	28,70	Rover
L-10021	2	31,75	35,75	25,40	
L-10019	2	32,00	36,00	31,70	
L-10020	2	32,00	36,00	44,00	
L-10022	2	44,50	49,30	25,30	

Boccole classiche (dis.5)

Classic bushes

Классические уплотнительные втулки

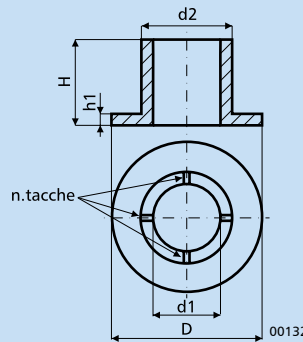

00132



11191

Codice Code Код	Min Ord Мин. количество заказа	d1	d2	D	h1	H	Descrizione per utilizzo Use remarks Примечания
		Размеры					
L-10100	2	15,00	16,80	23,90	1,10	5,20	senza tacche da abbinare a rondella U-02354
L-10023	2	21,00		31,00		11,50	un taglio con 3 innesti
L-10037	2	22,30	24,50	25,50	2,00	9,70	ZF 2/2 tacche - Porsche/Golf Corrado
L-10024	2	23,00	25,00	32,00	12,00	24,00	Skoda Octavia, VW Lupo, A2 2/2 tacche
L-10076	2	23,20	25,20	33,40	2,00	12,00	2/2 tacche
L-10071	2	23,20	25,20	34,50	1,80	23,50	2/2 tacche - Renault Megane Ø23

Boccole di scorrimento

Creep bushes

Уплотнительные втулки для агрегатов рулевого управления



Codice Code Код	Min Ord Мин. коли- чество заказа	d1	d2	D	h1	H	Descrizione per utilizzo Use remarks Примечания
L-10044/M	2	23,20	26,20	36,80	2,50	14,00	4/0 tacche - Peugeot 206
L-10096	2	23,80	26,10	33,00	2,60	14,00	4/0 tacche minorata Golf VW (fresatura solo esterna)
L-10072	2	23,90	26,90	38,40	1,50	17,10	4/0 tacche Saab crem. Ø24
L-10044	2	24,00	26,00	36,60	2,60	14,00	4/0 tacche - Peugeot 206
L-10051	2	24,10	26,00	33,00	2,60	14,00	2/2 tacche - Golf VW (fresatura solo esterna)
L-10043	2	24,10	26,10	27,00	2,00	12,00	Ford Sierra-Volvo 740 - Ford Scorpio - 3/+ 1TAGLIO 90
L-10016	2	24,10	26,10	27,45	2,00	12,00	2/2 tacche
L-10014	2	24,10	26,10	35,00	2,50	13,70	4/0 tacche
L-10099	2	25,00	27,00	37,00	2,00	24,15	2/2 tacche - Lancia kappa Ø25
L-10112	2	25,00	27,20	36,70	1,80	16,80	Boccola Fiat Doblo , crem.Ø25
L-10124	2	25,20	27,20	38,20	2,00	18,20	Boccola Opel Zafira , crem.Ø25
L-10048	2	25,30	27,40	35,30	2,00	15,00	2/2 tacche - Mercedes Classe A
L-10106	2	25,50	27,90	37,20	2,60	14,50	Boccola minorata 4/0 tacche Alfa 159 ZF
L-10115	2	26,00	27,90	37,20	2,60	14,50	4/0 tacche - Alfa 159 ZF
L-10046	2	26,00	29,00	38,00	2,00	15,00	2/2 tacche - Mercedes Classe E
L-10012	2	26,20	28,20	34,50	2,00	15,00	2/2 tacche
L-10067	2	26,20	28,40	37,80	2,80	14,00	2/2 tacche
L-10013	2	26,30	28,30	29,80	1,90	11,70	2/2 tacche
L-10081	2	26,50	28,10	29,40	2,50	19,70	Toyota (taglio a 45°)
L-10126	2	27,40	28,90	30,20	2,50	16,90	kia (taglio a 45°)
L-10058	2	27,40	34,90	36,00	1,30	17,30	4/0 tacche - Alfa 147 - 155 lato sinistro
L-10105	2	27,70	30,00	35,50	2,50	15,40	2/2 tacche - Renault Master
L-10070	2	27,70	30,00	37,50	2,00	14,70	2/2 tacche - Bmw 3 serie/Astra
L-10102	2	27,80	30,00	39,20	2,00	29,70	2/2 tacche - Alfa 156,
L-10011	2	28,00	30,00	37,70	1,80	14,80	2/2 tacche + fresatura sul Ø est.
L-10010	2	28,10	30,10	38,40	2,00	29,70	2/2 tacche
L-10069	2	28,20	30,20	37,70	2,50	15,50	4/0 tacche - Eurovan Diesel
L-10068	2	28,20	30,20	38,70	2,50	15,50	4/0 tacche - Eurovan Diesel
L-10101	2	28,20	30,20	39,30	1,90	20,80	2/2 tacche - BMW E46
L-10049	2	28,30	30,00	35,30	2,00	20,10	2/2 tacche - Alfa 145/146 1994/1996
L-10036	2	28,30	30,30	38,70	2,50	15,30	4/0 tacche - Audi A4 ZF - fresatura Ø est.
L-10133	2	28,40	32,70	33,20	1,40	4,20	Alfa 159
L-10057	2	28,40	34,90	36,00	1,30	17,30	4/0 tacche - Alfa 147-155
L-10055	2	29,20	32,20	39,40	2,00	15,00	Ford Transit minorata - montare su paraolio F-00594
L-10095	2	29,80	32,80	33,80	1,40	4,00	4/0 tacche - Mercedes
L-10074	2	29,80	32,80	48,90	1,50	14,50	2/2 tacche - Mercedes Vito crem. Ø30
L-10088	2	29,80	32,80	53,00	2,00	17,00	2/2 tacche - Mercedes Sprinter
L-10123	2	30,20	32,00	41,60	2,60	15,30	4/0 tacche - Bmw X3
L-10092	2	30,20	32,00	42,00	2,00	29,70	2/2 tacche - Ford Transit crem.. Ø30
L-10009	2	30,20	32,20	39,40	1,90	15,00	2/2 tacche - Ford Transit
L-10122	2	30,70	34,70	35,70	1,40	4,10	4/0 tacche
L-10111	2	32,00		35,00		29,90	Boccola Iveco C13, C15 (taglio a 45°)
L-10015	2	32,10	34,30	44,30	2,00	29,70	2/2 tacche
L-10117	2	32,15	34,10	40,70	1,90	15,00	2/2 tacche - Mercedes CL W220
L-10082	2	32,20	34,20	43,50	2,50	15,50	4/0 tacche - Range Rover MK3
L-10084	2	32,80	36,40	37,60	1,50	4,00	4/0 tacche - Range Rover MK3
L-10018	2	34,00	35,60	37,80	2,60	17,50	Aperto (taglio 45°) - Toyota Landcruiser



Boccole di scorrimento

Creep bushes

Уплотнительные втулки для агрегатов рулевого управления

Boccole-Pattini spingi-asta (dis.8)

Rod-pushing skates

Фолье-вставки к рулевым рейкам, имеющим угловой поджим штока

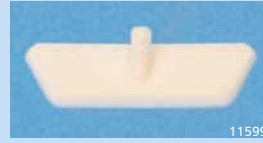

Codice Code Код	Min Ord Мин. количество заказа	Ø cremagliera Размер	Descrizione per utilizzo Use remarks Примечания
L-10113	2	23,00	Pattino spingiasta TRW Ø23, Ford
L-10098	2	24,00	Pattino Saab 9.35, anno 2005, crem.24
L-10097	2	28/30	Coppia di pattini Mercedes classe C 180,200/Vito senza sensori di velocita, crem.Ø28/30
L-10114	2		Pattino x asta crem. Ford Transit ZF

Boccole di scorrimento per scatole guida meccaniche

Creep bushings for mechanic steering boxes

Втулки скольжения к агрегатам рулевого управления без гидроусилителя

Boccole per cremagliere (dis.6)

Rack bushings

Распорные втулки

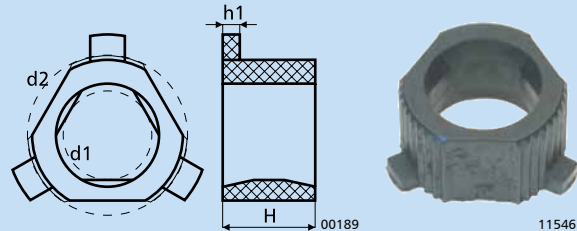

Boccole stampate in produzione Bushings printed in production

Codice Code Код	Min Ord Мин. количество заказа	d1	d2	h1	H	Descrizione per utilizzo Use remarks Примечания
		Размеры				
L-M6020	2	18,00	27,00	5,00	15,40	SOLO per scatole guida meccaniche <i>for mechanic gear boxes ONLY</i> - Fiat 500
L-M6001	2	19,30	31,10	3,80	18,30	SOLO per scatole guida meccaniche <i>for mechanic gear boxes ONLY</i>
L-M6022	2	20,00	30,00	5,00	16,00	da chiusa Ø20/30 H5/16
L-M6004	2	20,20	29,80	4,90	15,40	SOLO per scatole guida meccaniche <i>for mechanic gear boxes ONLY</i>
L-M6006	2	20,30	29,60	3,00	18,60	SOLO per scatole guida meccaniche <i>for mechanic gear boxes ONLY</i> – Fiat 127,128,Uno,Ritmo,Panda
L-M6002	2	20,40	34,60	2,90	17,90	SOLO per scatole guida meccaniche <i>for mechanic gear boxes ONLY</i>
L-M6003	2	20,70	30,00	3,00	18,20	SOLO per scatole guida meccaniche <i>for mechanic gear boxes ONLY</i>
L-M6037	2	20,70	30,00	3,00	18,20	con taglio diritto
L-M6014	2	22,00	32,00	1,80	26,00	Opel Corsa, Vauxhall, Smart
L-M6005	2	24,80	33,50	5,00	15,70	SOLO per scatole guida meccaniche <i>for mechanic gear boxes ONLY</i> – Fiat 131,132,Mirafiori

Boccole di scorrimento per scatole guida meccaniche

Creep bushings for mechanic steering boxes

Втулки скольжения к агрегатам рулевого управления без гидроусилителя



Boccole tornite *Bushings manufactured using lathe* *Заготовки для втулок*

Codice Code Код	Min Ord Мин. колич- ество заказа	d1	d2	h1	H	Descrizione per utilizzo Use remarks Примечания
		Размеры				
• L-M6035T	2	22,00	30,00	3,00	20,00	Chevy Cobalt
• L-M6030T	2	22,00	30,00		25,00	
• L-M6033T	2	22,00	32,00		19,00	
• L-M6031T	2	22,00	32,00		24,50	Fiat 600
• L-M6029T	2	23,00	31,50		23,50	
• L-M6032T	2	24,00	31,40		22,50	
• L-M6036T	2	24,00	31,50		25,50	Toyota Corolla(Chile-Perù)
• L-M6028T	2	24,00	32,00		23,50	Fiat Stilo
• L-M6034T	2	24,00	33,00		22,80	
• L-M6024T	2	24,00	34,30	24,30	33,70	Citroen C3
• L-M6025T	2	24,00	35,00	6,00	25,20	Grande Punto
• L-M6026T	2	25,00	32,70	2,00	26,50	Malibu, Aura
• L-M6027T	2	25,00	34,00		23,50	Fiat Stilo, Grande Punto

Boccole con o-ring (dis.7)

Bushings with o-rings

Втулки, уплотняющиеся резиновыми кольцами

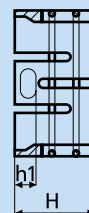
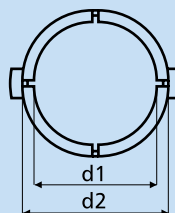

00190

11551

Codice Code Код	Min Ord Мин. колич- ество заказа	d1	d2	d3	D	h1	H	Descrizione per utilizzo Use remarks Примечания
		Размеры						
L-M6009	2	24,00	27,00	32,80	37,50	5,00	18,20	per scatole guide meccaniche <i>for mechanic gear boxes</i> - VW Transporter , BMW 320i, Fiat grande punto
L-M6008	2	24,50	27,50			5,00	18,20	per scatole guide meccaniche <i>for mechanic gear boxes</i> BMW
L-M6019	2	26,00	35,00			5,00	18,00	per scatole guide meccaniche <i>for mechanic gear boxes</i> VW Transporter
L-M6007	2	28,30	30,90			7,00	24,50	per scatole guide meccaniche <i>for mechanic gear boxes</i> Ford Transit
L-M6015	2	29,00	32,80			7,00	25,00	per scatole guide meccaniche <i>for mechanic gear boxes</i> Ford Transit



Boccole di scorrimento per scatole guida meccaniche

Creep bushings for mechanic steering boxes

Втулки скольжения к агрегатам рулевого управления без гидроусилителя



Altre boccole

Other bushings

Втулки иного типа

	Codice Code Код	Min Ord Мин. коли- чество заказа	d1	d2	h1	H	Descrizione per utilizzo Use remarks Примечания
			Размеры				
 11547	L-M6010	2	22,50	30,90		18,80	
 11548	L-M6011	2	22,20	33,50	19,60		VW Golf MK2
 11549	L-M6012	2	22,00	32,50		17,60	Renault 12,14,Peugeot 104,Citroen
 11550	L-M6013	2	17,80	50,00	19,00	23,00	Ford Transit
	L-M6016	2	20,00	30,00	15,40	18,00	Kit boccola scat. mecc. Renault 4, R5, R6 - composto da 1 boccola, 2 guarnizioni in gomma, 2 rondelle, 1 seger
	L-M6017	2	24,00	34,00	15,00	18,00	Kit boccola scat. mecc. R.18, Peugeot 305 e 504 - composto da boccola, n. 2 guarnizioni in gomma, n. 2 Ø24/34 H15,4/18
 11642	L-M6018	2	13,50	17,30	7,00	17,00	Giunto semisferico in plastica per snodo braccetto idroguida
 11663	L-M6021	2	28,60	39,50		15,70	Fiat Ducato
 11549	L-M6023	2	24,00	34,00	14,60	18,00	

Silentblock

Silentblock
Сайлентблоки

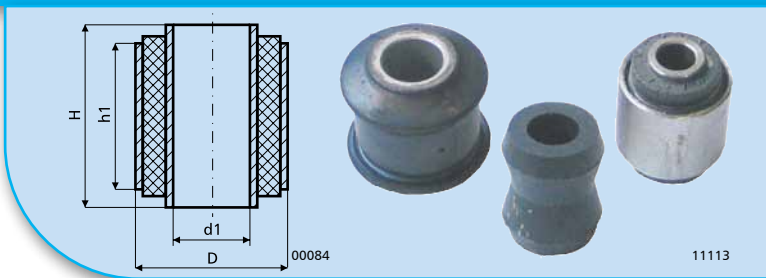



Codice Code Код	Min Ord Мин. коли- чество заказа	d1	d2	D	h1	H	Descrizione per utilizzo Use remarks Примечания
Q-11000	2	8,00		28,70	28,80	41,30	Jaguar
Q-11004	2	8,30	28,30	36,00	9,00	42,20	Jaguar (3pezzi)
Q-11002	2	8,50		28,00	33,00		Vw Transporter T2
Q-11009	2	8,50	26,00	30,00	4,00	33,00	Rubberblock VW Transporter T3 1983-92
Q-11008	2	9,00		28,00	33,00		mod. spec.
Q-11006	2	10,00	27,00	29,00	24,00		Mercedes Vito
Q-11001	2	10,00	22,00	29,50	15,00		kit silentblock Ducato Daily composto da n. 4pz,
Q-11007	2	10,50	22,50	30,00		20,00	kit silentblock Mercedes Sprinter composto da 2 pezzi
Q-11003	2	11,00	25,00	27,00	33,00		Vw Transporter T2 - originale
Q-11010	2	11,00	25,00	27,00	33,00		Vw Transporter T2 economy
Q-11005	2	11,80				65,00	Saab
Q-11011	2	12,50	20,10	23,80	5,50	20,30	Rubberblock 12,5X23,8H20,3 (Distanziatore centr.di rimozione Opel Vectra)
• Q-11013	1	14,00	32,00	44,50	4,00	28,50	Modifica-Kit Silentblock Toyota Landcruiser CYL 4200, 2 mozzi+2 rondelle
• Q-11012	1	16,30	33,30	44,00	3,00	28,00	Modifica-Kit Silentblock Toyota Landcruiser CYL 3000,3 mozzi+1 rondella

Braccetti e tiranti

Arms and ropes
Рулевые тяги



	Codice Code Код	Ø	Ø testina	Fil.	L	Descrizione per utilizzo Use remarks Примечания
•  11842	A-00001					Braccio oscillante Lancia Thesis con parastrappo
•  11836	A-00002					Braccio oscillante Alfa 159

Pistoni completi e molle a tazza

Complete pistons and tray springs

Комплекты поршней и пружинящих колец



Pistoni completi

Complete piston
Комплекты поршней

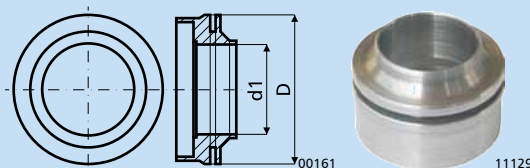

Pistoni con seger Pistons with seger Поршень со стопорным кольцом

Codice Code Код	Ø pist.	Ø crem.	H	O-ring Резиновое кольцо	Segmento Piston ring Поршневое кольцо	Segger Стопорное кольцо	Descrizione per utilizzo Use remarks Примечания
	Размеры						
K-00001	35,00	22,00	20,10	O-02029	M-01435	N-02004	Nuova Ford Fusion, Ford U.T. Europa
K-00001A	35,00	22,00	21,20	O-02029	M-01435	N-02004	Nuova Ford Fusion, Ford U.T. Originale America
K-00005	39,00	24,00	16,00	O-02772	M-01485	N-02022	SAAB 9.35 del 2005
K-00009	39,00	24,00	12,00	O-02020	M-01454	M-02007	Golf IV, per cremagliera G-00035
K-00011	40,20	25,00					Ford Ka, Fiesta, per cremagliera G-00031
K-00007	41,00	25,00	19,80	O-02662	M-01358	N-02007	Ford Mondeo ultimo tipo
K-00010	43,00	26,00	12,00	O-02035A	M-01538	N-02009	Alfa 159, per cremagliera G-00037 con bordatura
K-00003	45,00	26,00	16,30	O-02773	M-01436	N-02009	Mercedes Classe S-pistoni con sede PTFE
K-00004	48,00	30,00	16,00	O-02774A	M-01486	N-02023	Mercedes Vito e Sprinter del 2004
K-00002	50,00	26,00	18,30	O-02745	M-01437	N-02009	Mercedes Classe S-pistoni con sede PTFE
K-00008	50,00	30,00	16,00	O-02745	M-01422	N-02023	Jeep Grand Cherokee 2007
K-00006	54,00	30,00	18,60	O-02775	M-01494	N-02023	Mercedes Sprinter nuovo

Pistoni senza seger Pistons without seger Поршень без стопорного кольца

Codice Code Код	Ø pist.	Ø crem.	H	O-ring Резиновое кольцо	Segmento Piston ring Поршневое кольцо	Descrizione per utilizzo Use remarks Примечания
	Размеры					
K-00009X	39,00	24,00	12,00	O-02020	M-01454	Golf IV, per cremagliera G-00035
K-00011X	40,20	25,00				Ford Ka, Fiesta, per cremagliera G-00031
K-00010X	43,00	26,00	12,00	O-02035A	M-01538	Alfa 159, per cremagliera G-00037

Molle a tazza

Tray springs
Пружинящие кольца





Codice Code Код	Min Ord Мин. колич- ество заказа	d1	D	H	Ø stelo	Descrizione per utilizzo Use remarks Примечания
		Размеры				
K-01001	1	16,30	34,00	1,50	32,00	molla a tazza piccola <i>small</i>
K-01002	1	31,00	63,00	1,80	32,00	molla a tazza grande <i>big</i>

Tamponi

Plugs

Защитные уплотнения

Y

	Codice Code Код	d1	D	H	Materiale Material Материал	Descrizione per utilizzo Use remarks Примечания
		Размеры				
 11193	Y-00001	19,10	36,70	10,10	gomma rubber	tampone esterno Audi
 11194	Y-00002	30,20	50,00	16,50	gomma rubber	parapolvere - Jeep Cherokee

Alberi stelo e cremagliere

Rods and racks

Штоки гидроцилиндров и рулевых реек

G

Alberi stelo pistone

Rods and racks

Штоки гидроцилиндров



00163



11195

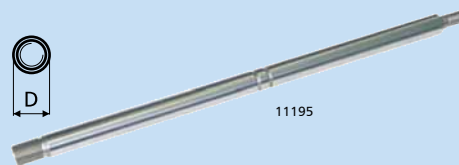

Codice Code Код	D	L	Marca/modello Brand/model Марка авто	Descrizione per utilizzo Use remarks Примечания
	Размеры			
G-00004	28,00	600,50	Iveco	anteriore front
G-00005	28,00	612,00	Scania	anteriore front
G-00001	28,00	681,50	Iveco 183	posteriore rear - ZF
G-00002	28,00	691,50	Scania	posteriore rear - ZF
G-00036	28,00	714,00	Iveco 410 E 42 Eurotrucker	
G-00003	32,00	712,00	Iveco 8347974161	III° Asse Iveco I° serie posteriore



Cremagliere

Racks
Штоки рулевых реек

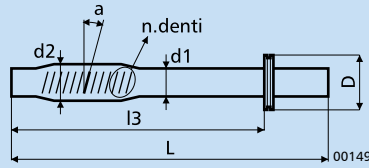

Legenda codici Codes legend Racks
Кодировка штоков рулевых реек

- M** Produzione Emmetec
Manufactured by Emmetec
Произведено Emmetec
- RHD** Guida a destra
Right-hand drive
Для правостороннего рулевого управления

Articoli disponibili a stock Items currently in stock Предметы в настоящее время на складе

Codice Code Код	d1	d2	D	I3	L	n. denti Угол наклона зубьев	Marca/modello Brand/model Марка авто	Note Remarks Примечания
	Размеры							
G-00035	24,00	24,00	38,80	429,00	625,00	29	Audi A3, Golf 4, Skoda Octavia	a = -27,0°
• G-00035M	24,00	24,00	38,80		625,00		A3, Golf 4, Octavia (a -27°)	produzione Emmetec (completa di pistone, PTFE e o-ring)
• G-00035RHD	24,00	24,00	38,80	429,00	625,00	29	Audi A3, Golf 4, Skoda Octavia	a = -27,0° - Guida a destra
• G-00031	25,00	25,00	40,50	397,00	576,00	26	Ford ka, Fiesta	
• G-00031M	25,00	25,00	40,50	397,00	576,00	26	Ford ka, Fiesta	produzione Emmetec
• G-00032M	25,00	25,00	40,50	398,00	576,00	26	Ford KA	produzione Emmetec
• G-00037							Alfa 159	

Articoli in produzione o disponibili su richiesta Items currently in production or available upon request Предметы в настоящее время в производстве или под заказ

Codice Code Код	d1	d2	D	I3	L	n. denti Угол наклона зубьев	Marca/modello Brand/model Марка авто	Note Remarks Примечания
	Размеры							
G-00007	18,00	27,00	44,80	446,00	660,00	21	Mercedes classe E	
G-00018	22,00	28,00		458,00	673,00	28	Ford fiesta 2002	
G-00017	22,00	28,30		457,00	673,00	28	Ford fiesta 2003	
G-00015	22,00	28,60		457,00	673,00	36	Ford fiesta 2003	
• G-00027	23,00	22,00	37,30	422,00	643,00	29	Renault megane	
• G-00027M	23,00	22,00	37,30	422,00	643,00	29	Renault megane	produzione Emmetec
G-00028	23,00	22,00	37,30	422,00	643,00	29	Renault megane	
G-00022	24,00	24,00	37,50	438,00	639,00	25	Renault megane	
G-00030	24,00	24,00	38,70	428,00	625,00	35	Audi TT	
G-00033	24,00	31,30	38,70	403,00	595,00	26	Saab 9.35 anno 2005	
G-00032	25,00	25,00	40,50	398,00	576,00	26	Ford KA	
G-00020	25,00	25,00	40,50	401,00	590,00	26	Ford mondeo	
G-00013	26,00	34,00		427,00	641,00	24	Mercedes classe C	
G-00012	26,00	34,80		426,00	642,00	22		
G-00006	27,70	27,40	39,50	468,00	765,00	36	Audi A4	
G-00009	27,70	27,40	42,50	491,00	808,00	36	Audi A6	
G-00026	28,00	26,90	44,80	465,00	659,00	21	Mercedes classe E	
G-00010	28,00	27,00	44,80	430,00	616,00	23	Bmw serie 5	
• G-00010M	28,00	27,00	44,80	430,00	616,00	23	Bmw serie 5	produzione Emmetec
G-00019	28,00	27,00	44,90	388,00	575,00	26	Bmw serie 3	
G-00021	28,00	27,00	44,90	425,00	616,00	23	Bmw serie 5	
G-00008	28,00	28,00	42,70	496,00	808,00	37	Audi A6 con serv.	
G-00024	30,00	28,50	46,90	446,00	675,00	25	Ford transit	
• G-00024M	30,00	28,50	46,90	446,00	675,00	25	Ford transit	produzione Emmetec
G-00011	30,00	29,00	48,00	499,00	817,00	34	Iveco daily 1AS	
• G-00011M	30,00	29,00	48,00	499,00	817,00	34	Iveco daily 1AS	produzione Emmetec
G-00014	30,00	29,00	48,00	500,00	817,00	34	Iveco daily 2AS	
G-00034	30,00	38,50	47,70	452,00	675,00	22	Mercedes vito 2005	
G-00029	32,00	31,00	47,80	445,00	635,00	21	Mercedes L220	
G-00023	32,00	31,00	47,80	445,00	656,00	21	Mercedes L220	
G-00016	32,00	31,00	52,10	461,00	695,00	30	Mercedes vito 2005	
G-00025	35,00	25,00	49,20	476,00	689,00	32	Mitsubishi land cruiser	
• G-00037M							Alfa 159	

Tappi distributore

Caps for rotary valve
Гайки боковых поджимов

J





Codice Code Код	Min Ord Мин. колич- ество заказа	D	H	P	Descrizione per utilizzo Use remarks Примечания
		Размеры			
● J-00004S	1	32,20	35,20	8,00	Cappuccio in acciaio pignone inferiore Jeep Grand Cherokee 05-06
J-00003	1	33,00	14,00	1,50	in plastica, TRW Ford Escort, Fiesta, Sierra, Metro
● J-00003S	1	33,00	14,00	1,50	in acciaio AVP, TRW Ford Escort, Fiesta, Sierra, Metro
J-00002	1	37,50	12,50	1,50	in plastica, TRW Ford
● J-00002S	1	37,50	12,50	1,50	in acciaio AVP, TRW Ford
J-00001	1	38,00	10,50	1,50	in plastica, TRW Volvo
● J-00001S	1	38,00	10,50	1,50	in acciaio AVP, TRW Volvo

Filtri

Filters
Фильтры

E

	Codice Code Код	Min Ord Мин. колич- ество заказа	d1	D	H	Descrizione per utilizzo Use remarks Примечания
			Размеры			
	E-00001	1	35,00	80,50	25,40	Filtro Mercedes
	E-00002	1	15,00	27,00	5,00	Filtrino MG Midget Morris 1000

Componenti delle pompe meccaniche

Components for mechanic steering pumps

Компоненты для механических насосов гидроусилителя

T

Kit parti interne pompa

Internal components pump kits

Комплект внутренних частей насоса

Codice Code Код	Min Ord Мин. количество заказа	Descrizione per utilizzo Use remarks Примечания
T-03800	1	Kit parti interne pompa CB80 Kit for pump CB80

Alberi steli

Piston rods

Валы насосов гидроусилителя

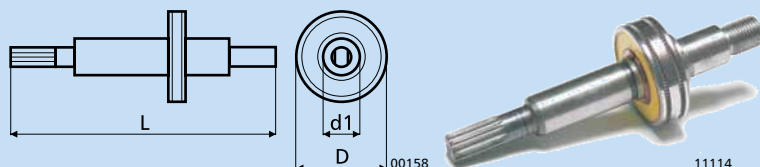

Codice Code Код	Min Ord Мин. количество заказа	D		L	Descrizione per utilizzo Use remarks Примечания
		Размеры			
T-02000	1	16,00	128,00		con cuscinetto
T-02003	1	17,00	98,40		
T-02004	1	17,00	98,50		con cuscinetto - Pompe Saginaw
T-02001	1	19,00	93,20		
T-02002	1	19,00	109,00		

Bronzine

Bushes

Втулки скольжения

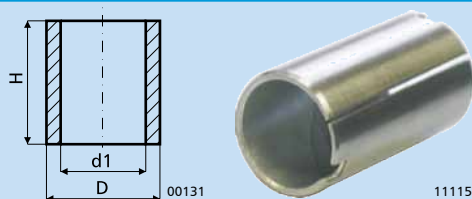

Codice Code Код	d1	D	H	Utilizzo
				Use remarks Примечания
T-03506	7,30	10,00	15,50	pistone chiuso ZF
T-03509	15,00	17,00	20,00	pompe Saginaw
T-03517	15,00	17,00	17,00	pompa Citroen Xantia - originale
T-03510	16,00	18,20	20,00	pompe Audi 5000
T-03508	16,00	19,00	19,00	pompe Saginaw
T-03512	17,00	20,00	20,00	pompe ZF
T-03500	17,00	21,00	41,00	Pompe Saginaw
T-03501	18,70	22,50	42,50	pompe Saginaw
T-03502	19,05	22,50	42,30	pompe Saginaw
T-03503	19,05	22,50	42,70	pompe ZF (genuine)

Codice Code Код	d1	D	H	Utilizzo
				Use remarks Примечания
T-03507	19,05	22,50	38,10	pompe Saginaw
T-03505	20,60	23,00	30,70	pompe ZF
T-03516	20,60	23,50	38,10	pompa bucherellata internamente
T-03518	23,00	26,20	17,50	
T-03504	23,00	27,60	30,80	pompe ZF
T-03511	25,00	28,00	17,00	
T-03513	25,00	28,00	15,00	modifica per Mondeo/Fiesta (cremagliera)
T-03514	25,00	28,00	20,00	modifica per Mondeo/Fiesta (cremagliera)
T-03515	25,20	27,20	15,00	

Componenti delle pompe meccaniche

Components for mechanic steering pumps

Компоненты для механических насосов гидроусилителя



Piatti di spinta e di pressione

Thrust and pressure plates

Уплотнительные пластины рабочей части насоса





	Codice Code Код	d1	D	H	Descrizione per utilizzo Use remarks Примечания
		Размеры			
 11407	T-00500		51,70	14,65	pompe Saginaw
 11408	T-00501		58,65	9,85	pompe Saginaw
 11409	T-00502		70,00	13,50	pompe Saginaw
 11410	T-00503		12,50		pompe ZF Volvo
 11411	T-00504		65,90		pompe ZF Volvo
 11624	T-00505		65,00		pompe ZF
 11412	T-00506		65,00		pompe ZF a clessidra
 11413	T-01500		54,00	13,35	pompa Saginaw Citroen, tappo di pressione esterno



Componenti delle pompe meccaniche

Components for mechanic steering pumps

Компоненты для механических насосов гидроусилителя

	Codice Code Код	d1	D	H	Descrizione per utilizzo Use remarks Примечания
		Размеры			
 11414	T-01501		14,85	7,60	pompa Saginaw Renault
 11415	T-01502		14,90	4,50	pompa Saginaw Opel
 11638	T-01505	14,50	65,00	11,00	Fuso SD14/SD15
 11639	T-01506	14,50	65,00	11,00	Fuso 6D16

	Codice Code Код	d1	D	H	Descrizione per utilizzo Use remarks Примечания
		Размеры			
 11628	T-08507	13,00	70,00	21,50	Renault
 11629	T-08508	14,00	66,00	37,00	Mercedes - Volvo
 11630	T-08509	14,00	64,00	37,00	Mercedes - Volvo
 11631	T-08510	14,50	65,00	24,00	8DC91

Componenti delle pompe meccaniche

Components for mechanic steering pumps

Компоненты для механических насосов гидроусилителя



		Codice Code Код	d1	D	H	Descrizione per utilizzo Use remarks Примечания
			Размеры			
	 11632	T-08511	14,50	65,00	24,00	Nissan
	 11633	T-08512	15,00	64,00	22,00	Nissan
	 11634	T-08513	15,00	64,00	22,00	Nissan
	 11635	T-08514	12,00	66,00	26,00	Volvo
	 11636	T-08515	13,00	66,00	26,00	Volvo
	 1167	T-08516	12,00	54,00	32,50	Citroen

Regolatori di flusso

Flux limiters

Штуцеры с калиброванным отверстием

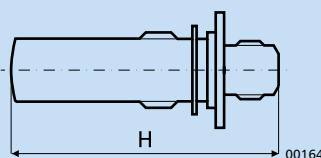

Codice Code Код	H	Descrizione per utilizzo Use remarks Примечания
	Размер	
T-02500	40,80	pompa Saginaw
T-02501	42,50	pompa Saginaw
T-02502	61,20	pompa Saginaw

Rotori pompa pistone e camicia

Piston rotor and liner

Роторы, рабочие камеры и пластины насосов гидроусилителя

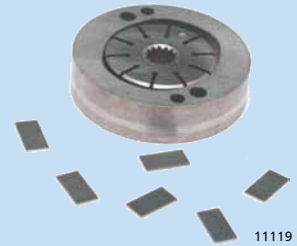
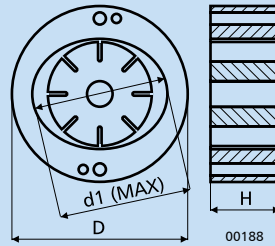

Codice Code Код	Min Ord Мин. количество заказа	d1	D	H	n. U	A	n. V	Descrizione per utilizzo Use remarks Примечания
T-00019	1	11,90	54,00	14,00	6,00	1,60	14,00	Toyota 6HE1
T-00031	1	11,90	54,00	16,00	6,00	1,60	14,00	Toyota 6HH1
T-00035	1	12,40	64,50	16,00	3,00	2,00	14,00	Hino RH700/HO7C
T-00057	1	12,40	64,50	18,00	3,00	1,40	14,00	Volvo
T-00021	1	12,40	64,50	19,50	1,00	2,00	14,00	Mercedes Benz
T-00055	1	12,40	64,50	19,50	3,00	1,40	14,00	Volvo
T-00056	1	12,40	64,50	19,50	1,00	1,40	14,00	Volvo
T-00066	1	12,40	64,50	19,50	1,00	2,00	14,00	Mercedes Benz
T-00053	1	12,40	64,50	23,50	3,00	1,40	14,00	Man
T-00054	1	12,40	64,50	23,50	3,00	1,40	14,00	Man
T-00064	1	12,40	64,50	23,50	2,00	1,40	14,00	Volvo
T-00065	1	12,40	64,50	23,50	1,00	1,40	14,00	Mercedes Benz
T-00058	1	12,40	65,00	16,50	4,00	1,40	14,00	Toyoda
T-00043	1	12,40	68,00	16,00	3,00	2,00	14,00	
T-00074	1	12,50	77,00	22,00	14,00	1,40	23,00	Vikiers
T-00052	1	13,00	63,50	23,50	10,00	1,40	23,00	Scania
T-00061	1	13,00	63,50	23,50	10,00	1,40	23,00	Scania
T-00075	1	13,00	77,00	27,00	14,00	1,40	23,00	Vikiers
T-00076	1	13,40	64,00	12,00	6,00	1,60	18,00	
T-00026	1	13,40	64,00	14,00	6,00	1,60	18,00	
T-00023	1	13,40	64,00	16,00	6,00	1,60	18,00	Hino EH700/HO7C
T-00014	1	13,40	64,00	18,00	12,00	1,60	18,00	Hino
T-00039	1	13,40	64,00	20,00	12,00	1,60	18,00	Hino EK100, EF750
T-00040	1	13,40	64,00	20,00	8,00	1,60	18,00	Hino ZM, PK, EF500, 750
T-00042	1	13,40	64,00	23,00	8,00	1,60	18,00	Nissan RF8 PF6
T-00018	1	13,40	64,00	28,00	8,00	1,60	18,00	Nissan CW520, CW54, RE8
T-00015	1	13,40	64,00	30,00	8,00	1,60	18,00	Nissan
T-00017	1	13,40	64,00	32,00	8,00	1,60	18,00	Nissan
T-00034	1	13,40	68,00	16,00	10,00	1,60	18,00	Hino ED200
T-00025	1	13,40	68,00	20,00	12,00	1,60	18,00	Hino EK100, EF500
T-00022	1	14,40	64,00	23,00	8,00	1,60	10,00	Nissan RF8 PF6
T-00024	1	14,40	64,00	28,00	8,00	1,60	10,00	Nissan CW520, CW54, RE8
T-00016	1	14,40	64,00	30,00	8,00	2,00	10,00	Nissan
T-00027	1	14,40	65,00	12,00	14,00	2,00	10,00	Fuso
T-00051	1	14,40	65,00	12,00	10,00	2,00	10,00	Fuso
T-00032	1	14,40	65,00	14,00	10,00	2,00	10,00	IHWW
T-00050	1	14,40	65,00	14,00	14,00	2,00	10,00	IHWW
T-00037	1	14,40	65,00	15,60	10,00	2,00	10,00	
T-00059	1	14,40	65,00	15,60	14,00	2,00	10,00	
T-00036	1	14,40	65,00	16,00	10,00	2,00	10,00	Fuso 6D15
T-00062	1	14,40	65,00	16,00	14,00	2,00	10,00	Fuso 6D15
T-00028	1	14,40	65,00	18,00	10,00	2,00	10,00	Fuso 6D14, 6D15/CK12, Hyundai, Mitsubishi
T-00048	1	14,40	65,00	18,00	10,00	2,00	10,00	Fuso 6D14, 6D15/CK12, Hyundai, Mitsubishi
T-00030	1	14,40	65,00	21,00	14,00	2,00	10,00	Isuzu, Nissan, Hyundai, Fuso, RD8, CK20, 6D16, Mitsubishi
T-00041	1	14,40	65,00	21,00	10,00	2,00	10,00	Isuzu, Nissan, Hyundai, Fuso, RD8, CK20, 6D16, Mitsubishi

Componenti delle pompe meccaniche

Components for mechanic steering pumps

Компоненты для механических насосов гидроусилителя



Codice Code Код	Min Ord Мин. коли- чество заказа	d1	D	H	n. U	A	n. V	Descrizione per utilizzo Use remarks Примечания
T-00029	1	14,40	65,00	24,00	14,00	2,00	10,00	Isuzu, Nissan, Hyundai, Fuso, Mitsubishi, Isuzu V10, 6BG1, 6QA1, 8DC9
T-00038	1	14,40	65,00	24,00	10,00	2,00	10,00	Isuzu, Nissan, Hyundai, Fuso, Mitsubishi, Isuzu V10, 6BG1, 6QA1, 8DC9
T-00063	1	14,40	65,00	24,00	10,00	2,00	10,00	Isuzu, Nissan, Hyundai, Fuso, Mitsubishi, Isuzu V10, 6BG1, 6QA1, 8DC9
T-00033	1	14,40	65,00	30,00	14,00	2,00	10,00	Isuzu, Nissan, Hyundai, Fuso, Mitsubishi
T-00049	1	14,40	65,00	30,00	10,00	2,00	10,00	Isuzu, Nissan, Hyundai, Fuso, Mitsubishi
T-00060	1	14,40	65,00	32,00	10,00	2,00	10,00	Isuzu, Nissan, Hyundai, Fuso, Mitsubishi
T-00020	1	14,40	68,00	20,00	10,00	1,60	10,00	Hino ED100, ZM
T-00046	1	14,40	77,00	26,00	1,00	1,40	10,00	TD50, SPZ
T-00047	1	15,40	77,00	26,00	1,00	1,40	19,00	
T-00045	1	20,00	92,00	16,00	14,00	1,60	10,00	Nissan PE6
T-00044	1	22,00	92,00	19,00	4,00	1,60	14,00	Nissan PD6
T-00002	1	40,70	53,30	17,80			17,80	pompe Saginaw 1H0422155E
T-00001	1	41,70	53,30	17,80			17,80	pompe Saginaw 1H0422155E
T-00003	1	42,70	53,30	17,80			17,80	pompe Saginaw 1H0422155E
T-00010	1	45,90	58,15	16,50			16,50	pompe Saginaw
T-00004	1	46,90	65,30	16,48			16,48	pompe Saginaw
T-00011	1	47,30	64,65	19,55				pompe ZF
T-00007	1	47,85	58,15	16,50			16,50	pompe Saginaw
T-00008	1	48,40	64,45	23,50			23,50	pompe ZF (Scania)
T-00009	1	48,45	64,45	23,50			23,50	pompe ZF
T-00006	1	48,50	65,00	21,55			21,55	pompe Saginaw
T-00005	1	48,50	65,30	16,50			16,50	pompe Saginaw

Valvole per pompa

Pump valves

Клапаны насосов гидроусилителя

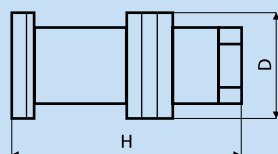

00160

11120

Codice Code Код	D	H	Cod. alesatore Код инструмента	Utilizzo Use remarks Примечания
T-01000	16,00	34,50		
T-01000A	16,10	34,50	Z-09153A	maggiorata
T-01000B	16,20	34,50	Z-09153B	maggiorata
T-01000C	16,30	34,50	Z-09153C	maggiorata
T-01001	17,00	26,40		
T-01001A	17,10	26,40	Z-09154A	maggiorata
T-01001B	17,20	26,40	Z-09154B	maggiorata
T-01001C	17,30	26,40	Z-09154C	maggiorata
T-01002	17,00	29,50		
T-01002A	17,10	29,50	Z-09154A	maggiorata
T-01002B	17,20	29,50	Z-09154B	maggiorata
T-01002C	17,30	29,50	Z-09154C	maggiorata
T-01003	17,00	29,50		
T-01003A	17,10	29,50	Z-09154A	maggiorata
T-01003B	17,20	29,50	Z-09154B	maggiorata
T-01003C	17,30	29,50	Z-09154C	maggiorata

Codice Code Код	D	H	Cod. alesatore Код инструмента	Utilizzo Use remarks Примечания
T-01004	17,00	38,00		pompa ZF
T-01004A	17,10	38,00	Z-09154A	pompa ZF-maggiorata
T-01004B	17,20	38,00	Z-09154B	pompa ZF-maggiorata
T-01004C	17,30	38,00	Z-09154C	pompa ZF-maggiorata
T-01005	17,00	38,00		
T-01005A	17,10	38,00	Z-09154A	pompa ZF-maggiorata
T-01005B	17,20	38,00	Z-09154B	pompa ZF-maggiorata
T-01005C	17,30	38,00	Z-09154C	pompa ZF-maggiorata
T-01006	17,00	43,10		pompa Fiat Ducato, Daily
T-01006A	17,10	43,10	Z-09154A	pompa ZF-maggiorata
T-01006B	17,20	43,10	Z-09154B	pompa ZF-maggiorata
T-01006C	17,30	43,10	Z-09154C	pompa ZF-maggiorata
T-01007	17,00	43,10		
T-01007A	17,10	43,10	Z-09154A	pompa ZF-maggiorata
T-01007B	17,20	43,10	Z-09154B	pompa ZF-maggiorata
T-01007C	17,30	43,10	Z-09154C	pompa ZF-maggiorata



Vaschette porta-olio in plastica

Plastic oil tanks

Пластиковые бачки

	Codice Code Код	Min Ord Мин. коли- чество заказа	Descrizione per utilizzo Use remarks Примечания
 11121	T-03700	1	con una uscita - Pompe Saginaw
 11192	T-03701	1	con doppia uscita, per piastra elettrica Peugeot 106, Saxo, Renault
 11614	T-03702	4	Renault Kangoo e tutti i modelli di Peugeot dal 2004
 11822	T-03704	1	con una uscita - Pompe TRW
 11823	T-03705	1	Tappo in plastica per vaschetta - Pompe TRW
 11824	T-03706	1	Serbatoio in ferro Pompa Luk Mercedes S500/S550/S63 AMG/SL550

Componenti delle pompe meccaniche

Components for mechanic steering pumps

Компоненты для механических насосов гидроусилителя



Pulegge per pompa e supporti

Pump pulleys and supports

Приводные шкивы и ступицы насосов гидроусилителя

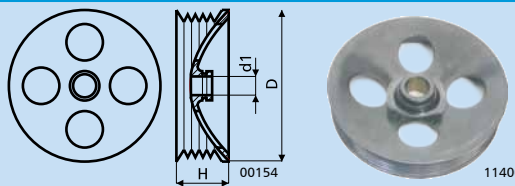

Codice Code Код	Min Ord Мин. колич- чество заказа	d1	D	H	Descrizione per utilizzo Use remarks Примечания
		Размеры			
T-04000	1	19,00	142,50	28,80	Vectra - Filettata esternamente

	Codice Code Код	Ø	Utilizzo Use remarks Примечания
	T-01503	31,60	flangia porta-puleggia esterna - modifica pompa Citroen Xantia 1.9 TD 07/93-0/95 - 2.0 TD 05/93-04/01 2.1 TD 06/97-01/99 - da abbinare alla bronzina T-03509

	Codice Code Код	Ø	Utilizzo Use remarks Примечания
	T-01504	30,00	flangia porta-puleggia esterna

Fondelli motore elettrico

Bottom plates for electric engine

Опорные пластины электродвигателей насосов гидроусилителя с электроприводом

	Codice Code Код	Descrizione per utilizzo Use remarks Примечания
	T-03703	Fondello per Peugeot 106/Saxo/Renault modificato per pompa 1 e 2 serie - abbinare a cuscinetto H-07552

Componenti delle pompe elettriche

Components for electric steering pumps

Компоненты для насосов гидроусилителя с электроприводом



Piastrine principali e schede elettroniche

Main plates and electronic device

Щеточные узлы

	Piastra Plate Щеточный узел	Composizione piastra Plate components Состав щеточного узла	Utilizzo Use remarks Примечания	Motori Engines Двигатель	Indotti Rotors Ротор
	V-04020	spazzole e molle (senza cavo) <i>Brushes and springs (without cable)</i>	Peugeot 106, Saxo, Kangoo (pump code O.E.M.7701470783)	V-04002	T-00012 T-00012A T-00012B
	V-04021	spazzole, molle, cavo e diodo <i>Brushes, springs, cable and diode</i>	Peugeot 106, Saxo, Kangoo (pump code O.E.M.7701470783)	V-04002	T-00012 T-00012A T-00012B
	V-04022	COMPLETA: spazzole, molle, cavo, diodo e connettore <i>COMPLETE: brushes, springs, cable, diode and connector</i>	Peugeot 106, Saxo, Kangoo (pump code O.E.M.7701470783)	V-04002	T-00012 T-00012A T-00012B
	V-04023	COMPLETA: spazzole, molle, cavo e connettore <i>COMPLETE: brushes, springs, cable and connector</i>	Mercedes Classe A		
	V-04024	COMPLETA: raggiera con spazzole e molle <i>COMPLETE: plate with brushes and springs</i>	Raggiera Nuova Mini/ BMW	V-04000	T-00013
	V-04026	COMPLETA <i>COMPLETE</i>	Renault Clio	V-04003	T-00077
	Scheda Device	Composizione scheda Plate components	Utilizzo Use remarks Примечания	Motori Engines Двигатель	Indotti Rotors Ротор
	V-04025	SCHEDA ELETTRONICA COMPLETA di struttura in alluminio e portaspazzola <i>COMPLETE ELECTRONIC DEVICE, including aluminium structure and brush-keeper</i>	Nuova Mini/BMW	V-04000	T-00013
	V-04027	SCHEDA ELETTRONICA COMPLETA <i>COMPLETE ELECTRONIC DEVICE</i>	Mercedes Classe A		
	V-04028	Kit di modifica centralina elettronica <i>Kit to overhaul electronic device</i> IMPORTANTE! Ulteriori dettagli a pag. 299 <i>Further details on page 299</i>	Mercedes Classe A		

Componenti delle pompe elettriche

Components for electric steering pumps

Компоненты для насосов гидроусилителя с электроприводом



Spazzole

Brushes
Щетки

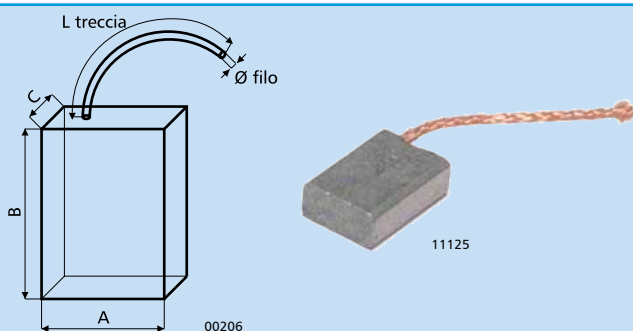

Codice Code Код	A	B	C	L treccia	Ø filo	Posizione filo Расположение провода	Descrizione per utilizzo Use remarks Примечания
	Размеры						
V-03000	12,40	20,70	6,90	60,00	2,50	posteriore rear	
V-03001	12,40	18,00	5,90	35,00	2,50	posteriore rear	
V-03002	12,40	20,20	6,00	35,00	2,50	posteriore rear	originale-genuine per pompe elettriche Peugeot-Saxo
V-03005	12,20	22,00	5,50	30,00	2,30	laterale lateral	originale - genuine per Mercedes Classe A
V-03007	10,80	26,80	6,00	30,00	2,00	laterale lateral	originale - genuine per nuova Mini

Molle spingi-spazzola

Brush-pushing springs
Пружины для щеток



Codice Code Код	Descrizione per utilizzo Use remarks Примечания
V-03003	in acciaio inox - Peugeot, Renault, Saxo
V-03006	in acciaio - Mercedes Classe A
V-03008	in acciaio - Nuova Mini

Cavetti connettori per piastra

Connectors for electric plate
Разъем для щеткодержателя

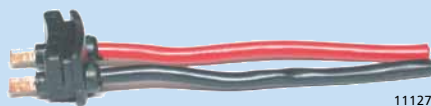

Codice Code Код	Descrizione per utilizzo Use remarks Примечания
V-03004	Peugeot 106-Citroën Saxo-Renault
V-03009	Cavo di connessione completo di connettore per Peugeot 106-Citroën Saxo-Renault
V-03010	Cavo di connessione completo di connettore per Peugeot 106-Citroën Saxo-Renault - ORIGINALE



Componenti delle pompe elettriche

Components for electric steering pumps

Компоненты для насосов гидроусилителя с электроприводом

Giunti

Electric pump joints

Электрические соединения насоса гидроусилителя с электроприводом

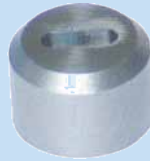





11128

Codice Code Код	Min Ord Мин. количество заказа	Descrizione per utilizzo Use remarks Примечания
V-05010	1	Peugeot 106, A.V.P.
V-05011	1	Peugeot 106 (plastica speciale)
V-05012	2	Rover doppio albero, lato pompa acqua

Motori per pompe elettriche

Electric pump engines

Электродвигатели насосов гидроусилителя с электроприводом

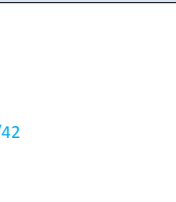
	Codice Code Код	Descrizione per utilizzo Use remarks Примечания	Piastre Plates Щеточный узел	Indotti Rotors Ротор
 11666	V-04000	motore elettrico pompa Mini, senza parte idraulica, composto da V-04025, T-00013, V-04001, O-02168, N-02026	V-04024 V-04025	T-00013
 11667	V-04001	corpo motore elettrico Mini con magneti permanenti	V-04024 V-04025	T-00013
 11675	V-04002	motore Peugeot-Citroen-Renault Kangoo (H 125)	V-04020 V-04021 V-04022	T-00012 T-00012A T-00012B
 11675	V-04002A	motore Peugeot-Citroen-Renault Kangoo (H 125) - non originale	V-04020 V-04021 V-04022	T-00012 T-00012A T-00012B
 11676	V-04003	motore Renault Clio (H 133)	V-04026	T-00077

Componenti delle pompe elettriche

Components for electric steering pumps

Компоненты для насосов гидроусилителя с электроприводом



Indotti per pompe elettriche

Rotors for electric pumps

Роторы для насосов гидроусилителя с электроприводом



11618



Codice Code Код	Min Ord Мин. коли- чество заказа	d1	D	H	Piastr Plates Щеточный узел	Motori Engines Двигатели	Descrizione per utilizzo Use remarks Примечания
T-00012	1	10,00	80,00	125,00	V-04020, V-04021, V-04022	V-04002	Peugeot, Saxo (OM)
T-00012A	1	10,00	80,00	125,00	V-04020, V-04021, V-04022	V-04002	Peugeot, Saxo (non originale)
T-00012B	1	10,00	80,00	125,00	V-04020, V-04021, V-04022	V-04002	Peugeot, Saxo (non originale) completo di cuscinetto
T-00013	1	12,00	91,50	145,00	V-04024, V-04025	V-04000	Mini
T-00077	1	10,00	80,00	133,00	V-04026	V-04003	Renault Clio

Coperchi per motori guide elettriche

Covers for EPS engines

Защитные крышки



11848



Questi coperchi sono particolarmente utili per evitare che umidità ed acqua entrino nel motore, inoltre ne riducono sensibilmente la rumorosità.

These covers are particularly useful to avoid water and humidity to penetrate inside the engine, in addition they contribute to reduce noise considerably.

Codice Code Код	d1	D	H	Utilizzo Use remarks Примечания
V-06001	33,70	36,00	19,20	
V-06002	35,00	37,00	25,50	
V-06003	36,50	40,00	20,50	
V-06004	38,00	40,40	20,90	
V-06005	40,00	42,00	25,50	
V-06006	41,30	43,30	20,30	
V-06007	42,40	44,50	25,50	
V-06008	44,50	47,00	20,90	
V-06009	45,40	47,00	20,90	
V-06010	47,50	50,00	24,50	
V-06011	48,30	51,00	29,70	
V-06012	51,00	53,20	29,00	
V-06013	52,00	56,10	30,70	
V-06014	52,80	56,30	30,80	
V-06015	54,00	56,10	30,90	
V-06016	55,00	58,00	29,70	
V-06017	57,00	58,20	30,00	
V-06018	59,00		30,00	

Codice Code Код	d1	D	H	Utilizzo Use remarks Примечания
V-06019	60,30	62,90	27,70	
V-06020	63,50	67,00	27,70	Opel Agila, Renault Twingo
V-06021	65,00	66,50	27,70	
V-06022	67,00	70,50	35,00	Fiat 600
V-06023	70,00	70,70	35,20	
V-06024	73,00	78,00	28,70	Fiat Punto II serie, Citroen C1, Toyota Yaris
V-06025	75,00	78,50	29,00	Citroen C2, C3, Opel Corsa, Renault Clio '02
V-06026	76,00	78,50	28,70	
V-06027	77,00	80,70	30,50	
V-06028	78,00	80,50	30,50	
V-06029	80,00	81,00	30,80	Nissan Sentra '07
V-06030	82,00	87,00	30,50	Fiat Stilo, Idea, Bravo, Lancia Delta, Nissan Micra
V-06031	83,00	88,00	30,80	Renault Megane
V-06032	85,00	87,70	30,70	
V-06033	88,90	91,20	35,70	
V-06034	90,00	95,00	30,00	Alfa Mito, Fiat 500
V-06035	92,40	95,00	29,50	Opel Corsa D



Pompe elettriche complete (estratto dall'elenco dei kit)

Complete electric pumps (taken from complete kit list)

Насосы гидроусилителя с электроприводом и комплектующие к ним



Pompe elettriche complete (estratto dall'elenco dei kit)

Complete electric pumps (taken from complete kit list)

Насосы гидроусилителя с электроприводом и комплектующие к ним

	Codice Code Код	Codice orig. Genuine Code Оригинальный код	Descrizione per utilizzo Use remarks Примечания	Motori Engines Двигатели	Piastre Plates Щеточный узел	Indotti Rotors Ротор
 11687	11X814	6Q0423155AB, 6Q0423155AE	TRW Seat Cordoba, Ibiza IV, Skoda Fabia, Vw Fox, Polo, Lupo			
 11832	11X815	OE 8Z0423156R	TRW Audi A2 1.4TDI, 1.6 FSI>2005			
 11839	11X817		TRW Seat Cordoba, Ibiza IV, Skoda Fabia, Vw Fox, Polo, Lupo + kit cremagliera			
 11668	13X802	7625955146, 7652955107, 7625955137, 7625955131, 7625477136	ZF Nuova Mini (Mini cooper)	V-04000	V-04025	T-00013
 11688	16X821	9684040180, 9684252580	TRW Citroen C4 2004, C4 Picasso 2006			
 11704	16X822	40079C	HPI Peugeot 106, con serbatoio doppio attacco orizz.			

Pompe elettriche complete (estratto dall'elenco dei kit)

Complete electric pumps (taken from complete kit list)

Насосы гидроусилителя с электроприводом и комплектующие к ним



	Codice Code Код	Codice orig. Genuine Code Оригинальный код	Descrizione per utilizzo Use remarks Примечания	Motori Engines Двигатели	Piastre Plates Щеточный узел	Indotti Rotors Ротор
 11690	16X823	4007CC	HPI Citroen Saxo, con serbatoio doppio attacco vert.			
 11691	16X824	4007ST	HPI Peugeot 307, Citroen C4			
 11825	16X825	4007KM	HPI Peugeot Patner, Citroen Jumpy, Fiat Scudo			
 11692	16X826	4007GC, 4007GE, 4007GH	HPI Peugeot 407			
 11705	16X827	OE 40071E J5090192	HPI Citroen Saxo			
	16X828	OE 9686207180	TRW Citroen, Picasso U.T.			
 11680	16X829	T7-65C OE 9686207080	TRW Peugeot			
 11681	16X830	GEP71C OE 9685418680	TRW, Peugeot			



Pompe elettriche complete (estratto dall'elenco dei kit)

Complete electric pumps (taken from complete kit list)

Насосы гидроусилителя с электроприводом и комплектующие к ним

	Codice Code Код	Codice orig. Genuine Code Оригинальный код	Descrizione per utilizzo Use remarks Примечания	Motori Engines Двигатели	Piastre Plates Щеточный узел	Indotti Rotors Ротор
 11682	16X831	OE 9686207180 GEP58C	TRW , PSA Peugeot, Citroen, Picasso U.T.			
 11683	16X832	OE 9688005080 GEP71C	TRW , PSA Peugeot			
 11684	16X833	OE 4007S3 J5088439+A - 906265480	HPI Citroen C15 Berlingo, con serb. a beccuccio			
 11706	16X834	GEP65C 9685418780	TRW			
 11810	16X835	J5083585 - 4007R2	HPI Peugeot 205 II			
 11833	16X836	OE 4007NX	HPI Peugeot 206 SW 1,6 HDI			
	22X808		Pompa elettoidraulica Fiat Scudo U.T. anno 2007, Jampy, Ulisse			
 11834	22X809		Pompa elettoidraulica nuova Fiat Croma e Ducato I° serie			

Pompe elettriche complete (estratto dall'elenco dei kit)

Complete electric pumps (taken from complete kit list)

Насосы гидроусилителя с электроприводом и комплектующие к ним



	Codice Code Код	Codice orig. Genuine Code Оригинальный код	Descrizione per utilizzo Use remarks Примечания	Motori Engines Двигатели	Piastre Plates Щеточный узел	Indotti Rotors Ротор
 11849	22X810		Pompa elettroidraulica nuova Fiat Cromia e Ducato II° serie			
 11693	23X810	OE 4M513K514CC	TRW Ford Focus-C Max 2003, Focus II			
 11694	23X811	OE 6G913K514AL	TRW Ford Galaxy 2006 2,0 tdcì, Ford C Max 2,0 tdcì			
 11793	23X812	OE YS613K514BF	HPI Ford Fiesta, Fiesta IV, Courier			
 11695	23X813	OE 5N513K514CB-31280369	TRW Ford			
 11812	23X814	OE 6M5Y3K514CC 1475137-1430017-1370305	TRW Ford Focus II, 2.5 ST			
 11813	23X815	4M513K514DA	TRW Ford Focus C-Max / Focus 2 TDCI			
 11831	38X800	290500113	Mercedes Classe A		V-04023	



Pompe elettriche complete (estratto dall'elenco dei kit)

Complete electric pumps (taken from complete kit list)

Насосы гидроусилителя с электроприводом и комплектующие к ним

	Codice Code Код	Codice orig. Genuine Code Оригинальный код	Descrizione per utilizzo Use remarks Примечания	Motori Engines Двигатели	Piastre Plates Щеточный узел	Indotti Rotors Ротор
 11685	38X802	OE A2214600780	TRW Mercedes			
 11686	38X803	OE A2044600580	TRW Mercedes			
 11696	42X807	OE 93172042-93172043 1609125-1609126	All Opel Astra G / Zafira; first generation replaces 948089. Blocco scatola idroguida e pompa, da utilizzarsi quando la pompa di soccorso dell'idroguida versione Delphi o TRW 1a serie è difettosa, GM N°24402621, OPEL N°1289042. Adattatore bipolare o tripolare da utilizzarsi insieme (è un elemento del kit).			
 11697	42X808	OE 5948001-594009	TRW Opel Astra G/Zafira			
 11698	42X809	OE 93172789-93183550 5948007-5948073	TRW Opel Signum/Vectra C			
 11699	42X810	OE 93183575-5948074	TRW Opel Signum/Vectra C			
 11700	42X811	OE 93179568-5948067	TRW Opel Astra H/Zafira, 1.6, 1.8 '05			
	42X812	OE 93172042-1609125	TRW Opel Astra G 1.7 DTI, 2.0 16V, Zafira 2.2 16V, + kit cremag.			
	42X813	OE 93172044-1609127	TRW Opel Astra G, 2.0 16V, 2.0 OPC, Zafira 2.0 OPC 01 > 06.05, + kit cremag.			

Pompe elettriche complete (estratto dall'elenco dei kit)

Complete electric pumps (taken from complete kit list)

Насосы гидроусилителя с электроприводом и комплектующие к ним



	Codice Code Код	Codice orig. Genuine Code Оригинальный код	Descrizione per utilizzo Use remarks Примечания	Motori Engines Двигатели	Piastre Plates Щеточный узел	Indotti Rotors Ротор
 11767	42X814	AD13273784	TRW Opel/GM, Opel Insigna			
 11766	42X815	AB13273782/4	Opel/GM			
 11835	42X816	OE 5948070	ZF Astra H			
 11850	42X817	OE 93183575-5948074	TRW Opel Signum/Vectra C completa di idroguida			
 11701	46X806	OE 7701470783 - 7700421259 - K5084975+C	HPI Renault Clio II e Kangoo; Nissan Almera II (serbatoio: T-03702)	V-04002	V-04022	T-00012 T-00012A
 11702	46X807	OE 7701466770	HPI Renault Clio 1	V-04003	V-04026	T-00077
 11703	46X808	OE 8200718096-8200520790	HPI Renault Kangoo 2005, Volvo S40			

Componenti delle scatole guida elettriche

Electric steering box components



Компоненты к агрегатам рулевого управления с электроприводом



In questa sezione introduciamo i ricambi per le scatole guida elettriche (EPS). I corpi completi sono illustrati esclusivamente per futuro riferimento e **NON sono in vendita come pezzo unico**. Vi invitiamo a contattare il nostro dipartimento tecnico per ulteriori aggiornamenti.

In this directory we introduce the new electric power steering (EPS). Whole steering boxes are published only for reference, **WE DO NOT SELL THEM** as is. We invite you to keep in touch with our technical department for further updates.

В этом разделе представлены агрегаты рулевого управления с электроприводом. Мы занимаемся разработкой технологии по ремонту данных изделий. Технология будет включать, как теоретический курс, так и комплекс оборудования для ремонта и диагностики. Для получения более полной информации свяжитесь с техническим отделом нашей компании.

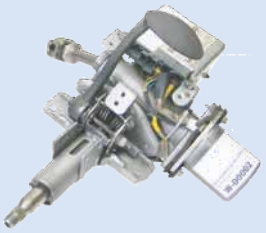
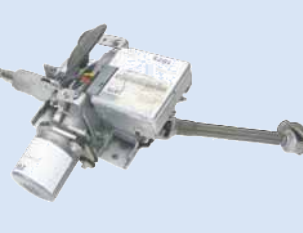
	11620		11621	W-00001	Scatola guida elettrica Fiat Punto I serie (prodotto non vendibile)
	11622		11623		
				W-00002	Scatola guida elettrica Fiat Punto II serie (prodotto non vendibile)

Relè sostitutivi per guide elettriche

Spare relays for electric steering boxes

Реле для агрегатов рулевого управления с электроприводом



11474

Codice Code Код	Min Ord Мин. количество заказа	Applicazione Application Применение	Descrizione per utilizzo Use remarks Примечания
W-01001	1	sinistro <i>left</i>	Relè sx sostitutivo per guide elettriche. Left
• W-01001A	1	sinistro <i>left</i>	Relè economy sx sostitutivo per guide elettriche. Left
W-01002	1	destro <i>right</i>	Relè sostitutivo destro per guide elettriche - TRW - Fiat Punto, Panda, Y10. (right)
• W-01002A	1	destro <i>right</i>	Relè economy dx sostitutivo per guide elettriche. Right - TRW - Fiat Punto, Panda, Y10. (right)
W-01003	1	universale <i>universal</i>	Relè Universale sostitutivo per guide elettriche - TRW - Fiat Punto, Panda, Y10.
• W-01003A	1	universale <i>universal</i>	Relè Universale economy, sostitutivo per guide elettriche. TRW - Fiat Punto, Panda, Y10.
• W-01004	1	universale <i>universal</i>	Relè Universale montato sul motore della Fiat (Stilo)
• W-01004A	1	universale <i>universal</i>	Relè Universale ECONOMY montato sul motore della Fiat (Stilo)
• W-01005	1	universale <i>universal</i>	Relè Universale montato sulla centralina della Fiat (Stilo)
• W-01005A	1	universale <i>universal</i>	Relè Universale ECONOMY montato sulla centralina della Fiat (Stilo)
• W-01006	2		Sensore Hall per piastra elettrica FPunto II° serie
• W-01007	1		Relè per Sterzo TRW - 26x26mm H 25 - 12V - 5 pin
• W-01008	1		Relè montato su centralina Fiat Punto - originale
• W-01008A	1		Relè ECONOMY montato su centralina Fiat Punto - NON originale

Componenti delle scatole guida elettriche

Electric steering box components

Компоненты к агрегатам рулевого управления с электроприводом



Sensori di coppia con cavo

Torque sensors with cable

Датчики крутящего момента с кабелем

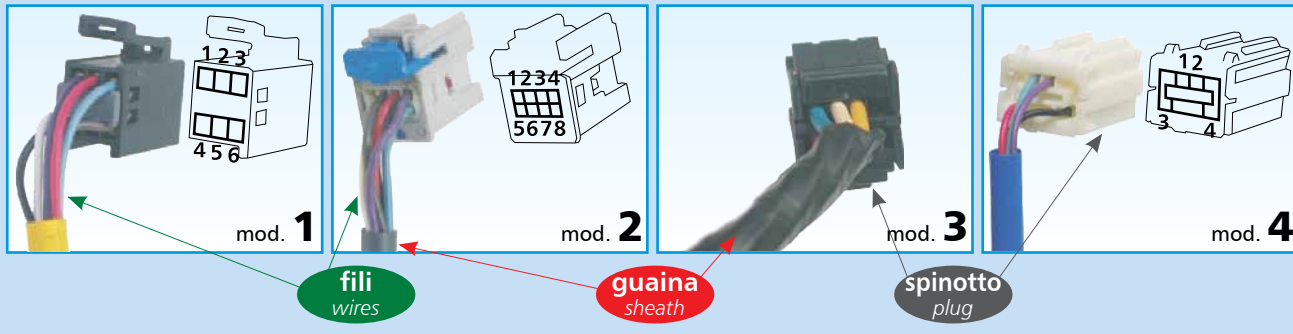
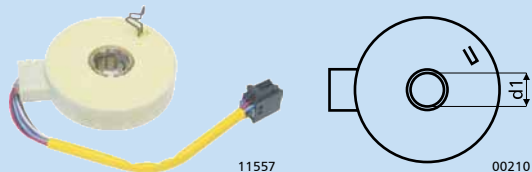

Guaina Sheath Защитная оболочка	Min ord (m) Мин. количество заказа	Colore standard Standard colour Цвет защитной оболочки
• W-03001	1,00	A nero black
• W-03002	1,00	B giallo yellow
• W-03003	1,00	C verde green
• W-03004	1,00	D grigio gray
• W-03005	1,00	E azzurro blue
• W-03006	1,00	F bianco white
• W-03007	1,00	G rosso red
• W-03008	1,00	H arancione orange
• W-03009	1,00	I viola violet

Classificazione fili Wires classification Классификация проводов	
	1 giallo yellow
	2 marrone brown
	3 rosso red
	4 viola violet
	5 bianco white
	6 nero black
	7 azzurro blue
	8 verde green
	9 arancione orange

Spinnotto Plug Разъем	Descrizione Remarks Примечания
• W-04001	Spinnotto mod.2, 8 poli Delphi
• W-04002	Contatto Delphi per spinnotto
• W-04003	Contatto Delphi per spinnotto mod.2
• W-04004	Spinnotto per sensore di coppia mod.4

Codice Code Код	Mod. Модифи- кация	Fili Wires Провода	Guaina Sheath Защитная оболочка	d1	L	Descrizione per utilizzo Use remarks Примечания	Schema dei fili Монтажная схема							
							1	2	3	4	5	6	7	8
W-02001	1	6	B giallo yellow	24,00	265,00	Fiat Punto 2a serie; Fiat Punto vers. 188 1a serie (mod. Ø alberino e cava)	4	3	7	5	6	2		
W-02002	2	7	E azzurro blue	24,00	230,00	Fiat Panda	1	2	3	4		5	6	7
W-02003	2	7	E azzurro blue	24,00	230,00	Lancia Y, Opel Meriva	1	2	3	4		5	6	7
W-02004	2	7	E azzurro blue	24,00	230,00	Fiat Grande Punto 199, Nuova Punto	1	2	3	4		5	6	7
W-02005	2	6	D grigio gray	24,00	360,00	Opel Meriva, Fiat Panda, Lancia Y		2	3	4		5	6	7
W-02006	2	7	H arancio orange	24,00	210,00	Opel Corsa, Ford Ka con ABS/955/M11 Fiat 199/312	1	2	3	4		5	6	7
W-02007	2	6	B giallo yellow	24,00	210,00	Opel Corsa, Ford Ka normale 955/M11 Fiat 199/312		2	3	4		5	6	7
• W-02009	2	6	B giallo yellow	24,00	360,00	Opel Meriva, Opel 4316		2	3	4		5	6	7
• W-02010	2	6	C verde green	24,00	230,00	Fiat Panda, Lancia Y, Fiat 169/843		2	3	4		5	6	7
• W-02011	2	6	B giallo yellow	24,00		Fiat Grande Punto, Fiat 500, Opel Corsa		2	3	4		5	6	7
• W-02015	1	4	B giallo yellow	24,00	260,00	Fiat Punto 2a serie; vers.188 1a serie (mod. Ø alberino e cava) funzione limitata	4	3	7		6			
• W-02016	2	6	F bianco white	24,00	265,00	Fiat 199, Opel 4400		2	3	4		5	6	7
• W-02017	2	6	E azzurro blue	24,00	230,00	Fiat Panda		2	3	4		5	6	7
• W-02019	1	6	B giallo yellow	24,00		Sensore di coppia muletto	4	3	7	5	6	2		
• W-02021	4	6	E azzurro blue	24,00	195,00	Hyundai Accent	7	4	3	6				
• W-02022	2	6	I viola violet	24,00	210,00	Fiat 199	5	2	3	4		5	6	7

Sensori di coppia con banda piatta e fili crimpati

Torque sensors with flat belt and crimped cables
Датчики крутящего момента со шлейфом



Codice Code Код	Fili Wires Провода	d1	L	Descrizione per utilizzo
				Use remarks Примечания
• W-02013	7	24,00		Fiat Grande Punto, Opel Corsa, Alfa Mito (con ABS)
• W-02014	7	24,00		Fiat Grande Punto, Opel Corsa, Alfa Mito (standard)
• W-02018	6	24,00		Nuova Punto, Opel Corsa

Motori per guide elettriche

EPS engines
Электродвигатели для агрегатов рулевого управления с электроприводом



Codice Code Код	Descrizione per utilizzo
	Use remarks Примечания
• W-00500	Motore per EPS Punto 99, modello 6971 completo

Componenti delle scatole guida elettriche

Electric steering box components



Компоненты к агрегатам рулевого управления с электроприводом



Accessori per guide elettriche

EPS accessories

Иные компоненты для агрегатов рулевого управления с электроприводом

	Codice Code Код	Descrizione per utilizzo Use remarks Примечания
 11809	W-05001	fermo per fissare il piantone della Punto posizione diritta
 11821	W-05002	chiave a bussola 1.7/16 per regolazione piantoni elettrici Fiat/Opel
	W-05003	fermo per fissare il piantone della Punto posizione diritta
	W-05005	pasta per trasferimento calore 50ml
	W-05006	pasta per trasferimento calore 35ml
	W-05007	foglio termoconduttivo biadesivo 210x300mm
	W-05008	foglio termoconduttivo biadesivo 50mm a metro

Kit idroguida

Kits for power steering

Ремонтные комплекты для рулевого управления



10X ALFA-ROMEO pag. 197-198/42

11X AUDI-VOLKSWAGEN SKODA pag. 198-203/42



Scatole guida meccaniche

Mechanical steering boxes

Механические рулевые редукторы

13X BMW pag. 203-207/42

61X CHEVROLET (ex Daewoo) pag. 207/42

19X DAIHATSU pag. 207-208/42

21X FERRARI pag. 208/42

22X FIAT e veicoli commerciali pag. 208-212/42



Scatole guida meccaniche

Mechanical steering boxes

Механические рулевые редукторы

23X FORD-MAZDA pag. 212-219/42



ASTE

Rods

Рабочие детали



Scatole guida meccaniche

Mechanical steering boxes

Механические рулевые редукторы



59X HOLDEN pag. 220/42

25X HONDA pag. 220-222/42

26X HYUNDAI pag. 222-223/42

27X ISUZU pag. 223/42

28X JAGUAR pag. 223-224/42

15X JEEP PONTIAC-CHEVROLET pag. 224-227/42

12X KIA pag. 227-228/42

30X LADA pag. 228/42

32X LANCIA-AUTOBIANCHI pag. 228-230/42

36X MASERATI pag. 230/42

38X MERCEDES-BENZ pag. 230-232/42

39X MITSUBISHI pag. 232-234/42

41X NISSAN pag. 234-238/42

42X OPEL-VAUXHALL pag. 238-241/42

16X PEUGEOT-CITROËN pag. 241-245/42



Martinetti idraulici

Hydraulic jacks

Гидроцилиндры к рулевым рейкам



45X PORSCHE pag. 246/42

46X RENAULT pag. 246-250/42

47X ROLLS-ROYCE pag. 250/42

48X ROVER-LAND ROVER pag. 250-252/42

49X SAAB pag. 252-253/42

57X SEAT pag. 253-254/42

60X SSANGYONG pag. 254/42

51X SUBARU pag. 254-255/42

52X SUZUKI pag. 255-256/42

53X TALBOT pag. 256/42

54X TATA pag. 256/42

55X TOYOTA pag. 256-261/42

58X VOLVO pag. 261-262/42

80X Trattori pag. 263/42

Tractors

Тракторы

81X Camion-veicoli pesanti pag. 263-269/42

Trucks-Heavy vehicles

Грузовые транспортные средства

Classificazione codici kit

Kit indexing rules

Классификация ремкомплектов

01X001 ... 01X599

Kit idroguida

Kit for power steering

Ремкомплект для рулевого управления с гидроусилителем

01X600 ... 01X699

Kit pompa

Pump Kit

Ремкомплект насоса

01X700 ... 01X799

Cuffie

Steering rack boots

Сайлентблоки

01X800 ... 01X899

Pompe nuove

New pumps

Новые насосы

01X900 ... 01X999

Martinetti, Aste, Scatole guida meccaniche

Jacks, Rods, Mechanical steering boxes

Различные запчасти к механическим рулевым механизмам

01XE900 ... 01XE999

Guide elettriche complete

Complete EPS

Готовый усилитель руля с электроприводом

Note aggiuntive

Additional remarks

Дополнительные примечания

Qualora si desiderino kit composti solamente da paraoli, si aggiunga in fase di ordinazione la lettera "A" al codice kit associato.

If you wish to order kits just with seals, please just add letter "A" to kit code into your order inquiry.

Если вы желаете заказать точный ремкомплект, пожалуйста, отправьте письмо с номером агрегата.

VOK Kit idroguida Power steering kit Ремкомплект рулевого управления
VOC Kit cremagliera Rack kit Ремкомплект гидроцилиндра
VOD Kit distributore Pignon kit Ремкомплект распределителя
VOP Kit pompa Pump kit Ремкомплект насоса

OCD Cuffia destra Rack boot (right) Правый сайлентблок
 OCS Cuffia sinistra Rack boot (left) Левый сайлентблок
 OCX Cuffie sinistra+destra Rack boot (left+right) Набор сайлентблоков
 OCC Kit cuffie Rack boot kit Ремкомплект сайлентблоков



Alfa Romeo

10X

Codice Code Код	Ref. Приме- нение	Ø crem. rack Ø	Ø distr. pinion Ø	Ø albero shaft Ø	Descrizione per utilizzo Use remarks Примечания	Cod. originale IDROGUIDA Оригинальный номер агрегата	Cod. originale KIT Оригинальный номер ремкомплекта
10X001	VOK	28,00			TRW - Alfa 145,146, attacco 4fori 1994/96, crem. Ø28		
10X002	VOK	28,00			TRW - Alfa 145, 146, 155, GTV Coupè, Fiat Tipo, Dedra, Spider - crem. Ø28	15001021/2 - 15000917/944/874/ 763/815	
10X003	VOK	28,00			TRW - Alfa 155 2.0i, turbo 16V 2,5i V6 1992 crem. Ø28		
10X004	VOK	28,00			TRW - Alfa 145, 146, 155, crem. Ø28	15R00754	
10X005	VOK	23,00			TRW - Alfa 156 1997, 1.6i, 1.8i, 1.9TD, 2.5TD I°serie, crem. Ø23		
10X006	VOK	30,00			TRW - Alfa AR6 10/14 BZ DS. 86, crem.Ø 30		
10X007	VOK	25,00			TRW - Alfa 164 1987, 164 T.benz, TDS c/ammortizz. 1989, crem. Ø25		
10X008	VOK	26,00			ZF - Alfa 75/90 1994 1° serie, crem.Ø26	7830955105/ 7830955107	7830/003
10X009	VOK				ZF - Alfa 75/90 1994	7830955104	7830/004
10X010	VOK	26,00			ZF - Alfa 33 benzina, Alfa 33 TD 1983/90, crem. Ø26	7836955131/ 7836955151/ 7681955164	7836/005
10X011	VOK	23,00			ZF - Alfa 75/90 1994 II serie, Alfa 75/90 V6 1984, crem.Ø23	7830955116/ 7830955121/ 7830955123/ 7830955124	7830/007
10X012	VOK				ZF - Alfa 75 TD 1992	7830955134	7830/009
10X013	VOK				ZF - Alfa Spider '83/89	8052955254; 8052955238	8052/042
10X014	VOK	26,00			ZF - Alfa 6 1977/86 crem.Ø26	7842955114/ 7842955118	7842/020 7842/005
10X015	VOK				ZF - Alfa 75/90 1984	7830955103	7830/002
10X016	VOK	25,00			TRW - Alfa 164 I° serie., 2 paraoli dis.7, crem. Ø25		
10X017	VOK	25,00			TRW - Alfa 164 II° serie, un paraolio dis. 6 e un paraolio dis. 7, crem. Ø25		
10X018	VOK	25,00			TRW - Alfa 164 III° serie, Alfa 166, due paraoli dis. 6, crem. Ø25		
10X019	VOD			19,00	Kit distributore Alfa 164, albero Ø19		
10X020	VOK	28,00			TRW - Alfa 166/156 2° serie, crem. Ø28		
10X021	VOK	28,00			TRW - Alfa 147 2001, Alfa 165-166 III°serie '97-99, Alfa 156, crem. Ø28	15001094/15001133/ 15001134/15001063	
10X022	VOK				TRW - Alfa 166		
10X023	VOD				Alfa 156 servotronic		
10X024	VOK	25,00			TRW - Alfa 164 1987, Thema 84-94, due paraoli dis.6, crem. Ø25		
10X025	VOK	25,00			TRW - Alfa 164 1987, paraoli dis.6 e 7, crem. Ø25		
10X026	VOD				ZF - Alfa Spider a settore		7852/039 - 8052/039
10X027	VOK	26,00			ZF - Alfa 159, paraolio H 8,5 dis. 7V1, crem. Ø26	7832974138	
10X028	VOK	26,00			ZF - Alfa 159, paraolio originale dis. 7V2 H8, crem. Ø26	7832974138	
10X601	VOP				ZF - Alfa 75 1° serie		
10X602	VOP			16,00	ZF - Alfa 75 II° serie, albero Ø16		
10X603	VOP				Alfa 155		



Kit idroguida

Kits for power steering

Ремкомплекты для рулевого управления

Codice Code Код	Ref. Приме- нение	Ø crem. rack Ø	Ø distr. pinion Ø	Ø albero shaft Ø	Descrizione per utilizzo Use remarks Примечания	Cod. originale IDROGUIDA Оригинальный номер агрегата	Cod. originale KIT Оригинальный номер ремкомплекта
10X604	VOP			19,05	ZF - Alfa 33, albero Ø19,05	7681/174	7681/3
10X605	VOP				ZF - Alfa 145/146/156		7613/002
10X700	OCD				cuffia crem. TRW DX Alfa 164 "87 in poi singolo		
10X701	OCS				cuffia crem. TRW SX Alfa 164 7/87 in poi singolo		
10X702	OCX				cuffia crem. TRW sx/dx Alfa 155 3/1992 > singolo		
10X703	OCX				cuffia crem. TRW sx/dx Alfa 33 TD-Alfa 145/146		
10X704	OCX				cuffia crem. TRW sx/dx Alfa 145/146		
10X705	OCD				cuffia crem. TRW DX Alfa 164 V6 con ammortizz.		
10X706	OCX				cuffia crem. ZF - sx/dx centrale Alfa 33 6/1983-1/1990		
10X707	OCX				cuffia crem. ZF - sx/dx Alfa 75/90 1 e 2 serie v1984 > singolo		
10X708	OCX				Kit cuffia crem. TRW SX Alfa 64 V6 con ammortizz. Completo		
10X709	OCX				Kit cuffia crem. TRW Alfa 164 7/87 in poi		
10X710	OCC				Kit cuffia crem. TRW Alfa 164 V6 con ammortizz.		
10X711	OCC				Kit cuffia crem. TRW Alfa 155 3/1992 >		
10X712	OCX				cuffia crem. TRW termoplastico SX/DX Alfa 147 2000-'04, 156 1997-'06, 166 1998, GT		
• 10X713	OCX				cuffia crem. termoplastico SX/DX Alfa Mito dal 2008		
• 10X714	OCX				uffia crem. termoplastico SX/DX Alfa 145/146 1999, 147 2004-'06, 156 Sportwagon, GTV 1996-'05, GT 2005'06		
10X751	OCX				cuffia man. sx/dx Alfa Sud		
10X752	OCX				cuffia man. sx/dx Alfetta 3		
10X753	OCD				cuffia man. DX Alfetta		
10X754	OCS				cuffia man. SX Alfetta		
10X755	OCX				cuffia man. sx/dx Alfetta 79		
10X756	OCC				Kit cuffia man. Alfetta		
• 10X757	OCC				Kit cuffia Alfa 159 1.9-->2.2 Dx-Sx		
• 10X758	OCC				Kit cuffia Alfa 159 2.4-->3.2 Dx-Sx		
• 10X759					Cuffia per Alfa 159		
10X801	PSV				kit pompa vuoto Saginaw Alfa 75/90 TD "86		
• 10XE906					Idroguida elettrica Alfa Mito 2008		

Audi - Volkswagen - Škoda

11X

Codice Code Код	Ref. Приме- нение	Ø crem. rack Ø	Ø distr. pinion Ø	Ø albero shaft Ø	Descrizione per utilizzo Use remarks Примечания	Cod. originale IDROGUIDA Оригинальный номер агрегата	Cod. originale KIT Оригинальный номер ремкомплекта
11X001	VOK	23,00			VW Jetta, Rabbit, Corrado Cam, crem. Ø23		
11X002	VOK	23,00			TRW - VW Passat '88/91 Benzina/Diesel, crem. Ø23		
11X003	VOK	23,00			TRW - Jetta '83/90, Corrado '89, Vw Golf, Passat Rabbit, crem. Ø23		
• 11X003 Light	VOK	23,00			TRW - allegg. Golf, crem. Ø23		
11X004	VOK	30,00			TRW - VW Transporter, Citroen C25, crem. Ø30		
11X005	VOK	28,00			TRW - VW Sharan '95, crem. Ø28		

VOK Kit idroguida Power steering kit Ремкомплект рулевого управления
VOC Kit cremagliera Rack kit Ремкомплект гидроцилиндра
VOD Kit distributore Pignon kit Ремкомплект распределителя
VOP Kit pompa Pump kit Ремкомплект насоса
OCD Cuffia destra Rack boot (right) Правый сайлентблок
OCS Cuffia sinistra Rack boot (left) Левый сайлентблок
OCX Cuffie sinistra+destra Rack boot (left+right) Набор сайлентблоков
OCC Kit cuffie Rack boot kit Ремкомплект сайлентблоков



Codice Code Код	Ref. Приме- нение	Ø crem. rack Ø	Ø distr. pinion Ø	Ø albero shaft Ø	Descrizione per utilizzo Use remarks Примечания	Cod. originale IDROGUIDA Оригинальный номер агрегата	Cod. originale KIT Оригинальный номер ремкомплекта
11X006	VOK	27,70			KOYO-SMI - Audi A4 LH, crem. Ø27,7	SY4 8E1 422066T 0224312 6003840059954	
11X006 Light		27,70			allegg. Koyo- Audi A4 L/H, crem. Ø27,7		
11X007	VOK				ZF - VW Syncro '83/92, Caravelle, Bmw 3° serie	7832955116/122	7832/6
11X008	VOK				ZF - Audi 100, C3 1978	7847 955 105	7847/1
11X009	VOK				ZF - Audi 200, Avant 4 '80/83	7847 955 108	7847/2
11X010	VOK				ZF - Audi 100, Avant 4 "78/82, Avant 4, Audi 100,C3	7847955110/ 7847955112	7847/3 7847/2
11X011	VOK	25,00			ZF - Audi 100-200 '83/94, C3 1982, crem. Ø25	7847955208	7847/4 7847/6
11X011 Light		25,00			ZF - allegg. Audi 100-200 '83/94, C3 1982, crem. Ø25		
11X012	VOK	22,00			ZF - W Golf II, Jetta, Syncro '90/91, crem. Ø22	7830 974 111/ 7830 955 119/ 7830 955 132/ 7830 974 110/ 7830 974 116/ 7830 955 114	7830/5 7830 974 142
11X013	VOK	25,00			ZF - Audi , crem. Ø25 con 5 teflon	7847955210	7847/6
11X014	VOK	25,00			ZF - Audi, crem. Ø25 con 6 teflon	7847955208	7847/8
11X015	VOK	10,00		25,00	ZF - Audi 100/200 '90/94, Audi A6 "94/98, non servotronic, crem. Ø25	7847955229/238/244	7847/9
11X016	VOK	22,00			ZF - VW Golf, Corrado, Jetta '90, VW Vento Golf 3° '91, VW Vento GTI '91, VW Golf III, Cabrio-Vento '91, VW Corrado "89, Golf III, Cabrio, Vento 7/91, VW Golf III, Cabrio,- crem. Ø22	7830985102/ 7830985104/ 7830985105/ 7830974118/ 7830 974 119/ 7830 955 129/ 7830 985 101/ 7830 985 110/ 7830 985 103/ 7830 985115/ 7830974124/ 7830974126/ 7830955127	7830/10
11X017	VOK				ZF - Audi 80, B3 '79, VW Passat B2 1981	7881955101	7881/1
11X018	VOK				ZF - Audi 200 servotronic	7847991502	7847/012, 7847/009
11X019	VOK				ZF - Audi Avant 4 servotronic	7847991507	7847/13 7847/20
11X020	VOK	25,00			ZF - Audi 100 - Avant 4 '90, Audi 200 - Avant 4 "84/91, crem. Ø25	7847955226	7847/14
11X021	VOK				ZF - Audi 80/90, B3 1979, VW Passat B2, Audi "91	7881955118 / 7881955120 / 7881955123	7881/5
11X022	VOK	25,00			ZF - Audi "80/90, Audi B4 "91/96, Audi80 B4 6cil. "92, Nuova Audi 80 "92, crem. 25	7881955309	7881/115
11X022 Light					ZF - allegg. - Audi 80/90		
11X023	VOK	10,00		28,00	ZF - Audi 100, Avant 4 "91 servotronic, Audi V8 "91, crem. Ø10, pignone Ø28	7847991513	7847/20
11X024	VOK				ZF - VW VAN		7832/122
11X025	VOK				ZF - Audi 100/200 "78/83	7847498020 / 7847955101	7847/115
11X026	VOK	28,00			ZF - Audi A4 1994, Passat crem.28	7852974326 7852974365 7852974358	7852/26



Kit idroguida

Kits for power steering

Ремкомплекты для рулевого управления

Codice Code Код	Ref. Приме- нение	Ø crem. rack Ø	Ø distr. pinion Ø	Ø albero shaft Ø	Descrizione per utilizzo Use remarks Примечания	Cod. originale IDROGUIDA Оригинальный номер агрегата	Cod. originale KIT Оригинальный номер ремкомплекта
• 11X026 Light		28,00			ZF - allegg.Audi A4 1994, Passat, crem. Ø28		
11X027	VOK	25,00			ZF - Audi 100 U.T. Avant 4 "91, Audi V8 "89, Early A/6, crem. 25	7847955229/ 7847955238	7847/10
11X028	VOK				ZF - AUDI 80/B3 "79-82/T B2 "81-82, Passat "88, Santana	7881955103/ 111/105/109/ 107/104	7881/2
11X029	VOK				ZF - Audi 80/90, Audi 4 8/"90	811-498-020A / 7881955103	7881/113
11X030	VOK	28,00			ZF - VW Transporter T4 "91, crem. Ø28	7852974200/ 7852974253	7852/14
• 11X030 Light		28,00			allegg. ZF - Transporter T4 "91, crem. Ø28		
11X031	VOK	28,00			ZF - VW Transporter "91 crem. Ø28	7852974205/ 7852974205/ 7852955215/ 7852955230/ 7852955240	7852/5
11X032	VOK	22,00			ZF - Audi 80/90 "79, Audi90 4x4 4cyl, Audi 80-B3-89K "88/90, Audi "90 5 cyl, Passat B2 "79 -92 crem. Ø22	7881955133/ 140/141/150/ 153/155/309/151	7881/6 7881/114
11X033	VOK	28,00			ZF - Audi 8 servotronic, crem. Ø28		7852/40
11X034	VOK	28,00			ZF - VW, Passat, Audi 4, Audi80 "89/92 crem. 28	7881991514	7881/8
11X035	VOK				ZF - Audi VW		8055/20
11X036	VOK	28,00			ZF - Audi, VW crem 28	7320955140	7320/106
11X037	VOK				ZF - Audi VW	7820955107	7820/108
11X038	VOK	28,00			ZF - VW Transporter crem 28	7320955142	7320/106
11X039	VOK	24,00			ZF - Golf IV serie, Ottavia, Audi A3, crem.Ø24	1J1 422 105 DEABD	7891/002
11X040	VOK	24,00			ZF - Audi A3, crem. Ø24		7891/3
11X041	VOK	23,00			TRW - Skoda Felicia, VW Polo "95 crem. Ø23		
11X042	VOK	22,00			ZF - Audi 80/90 crem. Ø22	7881955133	7881/6
11X043	VOK	24,00			ZF - Audi A3 2°serie, crem. Ø24		
11X044	VOK	28,00	28,00		TRW - VW Sharan, crem. Ø28 distrib. Ø28		
11X045	VOK	10,00			ZF - Audi 100 completo con P.T.F.E. + paraolio + boccola acciaio, crem. Ø10	7847640102	
11X046	VOK	27,70			KOYO - Audi A6, crem. Ø27,7		
11X047	VOK				ZF - Audi80/90, B4 6 cyl. "91-92, nuova Audi 80 "92, Audi B4 "93, A4 "90 - A4	7881955301/ 307/7881955308/ 7881955309/ 7881955311	7881/007
11X048	VOK				ZF - Audi A8		7852/58
11X049	VOK	22,00			TRW - Polo Brasile A/ Argent "01, crem. Ø22		
11X050	VOK	23,00			TRW - Polo Brasile"01 crem. Ø 23		
11X051	VOK	23,00			TRW - Skoda Fabia/Felicia, crem. Ø23 con pompa elettrica sensore elettrico pistone Ø36		
11X052	VOK	25,00			ZF - Audi 80/90/4000, A4 "91, crem Ø25	7881955335	7881/010
11X053	VOK	28,00			ZF - Audi A6 "97/99 crem. Ø28		7852/526
11X054	VOK				ZF - Audi TT "98, Leon, Toledo "99/05, A3	7891955129/125/190	7891/501
11X055	VOK				ZF - Audi A8		7852/037
11X056	VOK	24,00			ZF - Golf MK IV "97, Bora Audi A3 "96/05, New Beetle crem. Ø24	7891955125/ 7891955190	7891/5
11X057	VOK	10,00		28,00	Kit idro ZF - Audi 100 "92, A6 "94/97 Servotronic, crem. Ø10, pignone Ø28	7847991525/ 7847991533	7847/020
11X058	VOK	28,00			ZF - Audi A6 "97 LHD servotronic, crem. Ø28	7852974483 7852974649	7852/506
11X059	VOK	23,00			TRW - Skoda Octavia, VW Lupo, A2, crem. Ø23		

VOK Kit idroguida Power steering kit Ремкомплект рулевого управления
VOC Kit cremagliera Rack kit Ремкомплект гидроцилиндра
VOD Kit distributore Pignon kit Ремкомплект распределителя
VOP Kit pompa Pump kit Ремкомплект насоса
 OCD Cuffia destra Rack boot (right) Правый сайлентблок
 OCS Cuffia sinistra Rack boot (left) Левый сайлентблок
 OCX Cuffie sinistra+destra Rack boot (left+right) Набор сайлентблоков
 OCC Kit cuffie Rack boot kit Ремкомплект сайлентблоков



Codice Code Код	Ref. Приме- нение	Ø crem. rack Ø	Ø distr. pinion Ø	Ø albero shaft Ø	Descrizione per utilizzo Use remarks Примечания	Cod. originale IDROGUIDA Оригинальный номер агрегата	Cod. originale KIT Оригинальный номер ремкомплекта
11X060	VOK				ZF - Audi A6 2.4 servotronic "97	7852993178	7852/059
11X061	VOK	30,00			TRW - VW Transporter "98 crem. Ø30		
11X062	VOK	23,00			TRW - VW Jetta "83/90, Corrado, Golf, Rabbit, crem. Ø23		
11X063	VOK	28,00			ZF - Audi A4, B6 1.8T, 1.9TDI, 2.0FSI "00/02 crem. Ø28, senza parte metallica		7852/533
11X064	VOK	28,00			ZF - Audi A4, A6, B2, B5, VW Passat 3 B2 crem. Ø28	7852974682 7852974336	7852/026 7852/513
11X065	VOK	28,00			ZF - Audi A6 servotronic "97, crem. Ø 28	7847911513/ 7847911533	7852/518
11X066	VOK	28,00			ZF - AUDI A6, C5 "97, crem. Ø28		7852/055
11X067	VOK				ZF - AUDI A8, D2 "03		7852/525
11X068	VOK	28,00			ZF - Audi A4, B5 crem. Ø28		7852/519
11X069	VOK	24,00			KOYO - VW Golf Brasile, Skoda, Fabia "00 crem. Ø24	7610484980	
11X070	VOK	28,00			ZF - VW Diesel, T5 Transporter U.T. crem.Ø28	7853955146	
11X071	VOK	26,00			ZF - VW Caravelle -Vanwagon "85, crem Ø 26		7832633006
11X072	VOK	28,00			ZF - Audi A6, A8 servotronic, crem. Ø28	7852993130	7852/030
11X073	VOK	28,00			ZF - Passat B6, B3 U.T crem.Ø28	7852974722/ 7852974695	7852/532 7852/533
11X074	VOK				ZF - Audi A4 "00/03 servotronic, crem. Ø28		7852/541
11X075	VOK	28,00			ZF - Audi A8, A6 servotronic "94/02, crem. Ø28	7852993201 7852993210	7852/516 7852/039
11X076	VOK	27,70			KOYO SMI - Audi A6 "97/01, 1.8 TDI, crem. Ø27,7		
11X077	VOK	28,00			ZF - Audi A8 non servotronic "95/02, crem. Ø 28	7852974517	7852/523
11X078	VOK	28,00			ZF - VW LT 4x4 1983, paraolio pignone Dis. 0M Ø32, crem Ø28	8055955116	8055/12
11X079	VOK	28,00			ZF - Audi A4, Audi A6 "98, crem. Ø 28	7852974440 7852974649	7852/526
11X080	VOK	28,00			ZF - Tuareg, Cayenne, Q7 "02 - VW Tuareg, ZF - VW Tuareg, Cayenne, Q7 "02, crem. Ø28, non servotronic		
11X081	VOK	23,00			TRW - Skoda Felicia, Fabia "00, crem. Ø23		
11X082	VOK	23,00			TRW - con sensore elettrico - Polo, Seat Ibiza"02, crem. Ø23 pistone Ø36		
11X083	VOK				TRW - VW Golf, Generation II-III "94/99		
• 11X084	VOK	23,00			TRW - VW Golf 2&3 Brasile, VW Pointer Mexico, crem. Ø23		
• 11X085	VOK	28,00			ZF - VW T5 Transporter LHD-RHD, crem.Ø28	7853633502	
• 11X086	VOK	28,00			ZF - Audi A6 QUATTRO SERVOTRONIC "99-05, crem. Ø 28		7852/520
• 11X087	VOK	28,00			ZF - Audi A6 SERVOTRONIC, crem. Ø 28		
• 11X088	VOK	28,00			ZF - VW Tuareg, Cayenne, Q7 "02, crem. Ø28, servotronic	7852993367/ 7852993470	
• 11X089	VOK	28,00			ZF - Audi A4, B6 1.8T, 1.9TDI, 2.0FSI "00/02 crem. Ø28, ORIG. con parte metallica		7852/533
11X599	VOK				Kit completo parte metallica Audi 100	7847133101	
11X601	VOP			16,00	ZF - Audi 100/5000 "84, albero Ø16		8601/007
11X602	VOP				Audi 80 "91	8691955153	8691/6
11X603	VOP			19,05	VW transporter,albero Ø19,05		
11X604	VOP				4000 "80/87, Audi 5000 (100) "80/83		
11X605	VOP				4000 "79/88, Audi 5000 (100)79/84		
11X606	VOP				Audi 5000 (100)76/79 Universale		



Kit idroguida

Kits for power steering

Ремкомплекты для рулевого управления

Codice Code Код	Ref. Приме- нение	Ø crem. rack Ø	Ø distr. pinion Ø	Ø albero shaft Ø	Descrizione per utilizzo Use remarks Примечания	Cod. originale IDROGUIDA Оригинальный номер агрегата	Cod. originale KIT Оригинальный номер ремкомплекта
11X607	VOP			17,00	Saginaw - Golf tipo CB,		
11X608	VOP			19,05	VW Golf 4ª serie Kayaba,		
11X609	VOP			17,00	Audi A3 mod. Kayaba,		
11X610	VOP			17,00	VW Jetta/A4 mod. Kayaba, albero Ø17		
• 11X611	VOP				kit pompa Volkswagen T5 2.5 TDI, Kayaba		
11X701	OCX				cuffia VW Jetta Rabit (America)		
11X702	OCX				cuffia crem. (TRW) idro Audi 90-4 82-		
11X703	OCX				cuffia crem. (TRW) idro Audi 100-100 Avant 76-94		
11X704	OCX				cuffia crem. (TRW) idro Audi 100 Avant 4 84-94		
11X705	OCX				cuffia crem. (TRW) idro Audi A6 Avant 4 94-		
11X706	OCX				cuffia crem. (TRW) idro Audi 200 Avant 79-90		
11X707	OCX				cuffia crem. (TRW) idro Audi A8 Avant 88-		
11X708	OCX				cuffia crem. (TRW) idro Audi COUPE' 4 80-		
11X709	OCX				cuffia crem. (TRW) idro Corrado 88- / Golf 87- / Jetta 87-/Passat 88-		
11X710	OCX				cuffia crem. (TRW) manuale- Deby -79 / POLO -79		
11X711	OCX				cuffia crem. (TRW) manuale Deby -79 79- / POLO -79 79- chiuso		
11X712	OCX				cuffia crem. (TRW) manuale Deby 79- / POLO 79-		
11X713	OCS				cuffia crem. (TRW) manuale SX. Golf 74-87 / Jetta 74- 87/Scirocco 74-		
11X714	OCD				cuffia crem. (TRW) manuale DX. Golf 74-87 / Jetta 74- 87/Scirocco 74-		
11X715	OCX				cuffia crem. (TRW) manuale Scirocco 86-89		
11X716	OCD				cuffia crem. (TRW) manuale SX. Caddy 82-		
11X717	OCS				cuffia crem. (TRW) manuale DX. Caddy 82-		
11X718	OCX				cuffia crem. (TRW) manuale Vw Transporter 86-P859		
11X719	OCX				cuffia crem. idro Audi A8		
11X720	OCD				cuffia crem. idro DX, ZF - Audi A4		
11X721	OCS				cuffia crem. idro SX, ZF - Audi A4		
11X722	OCX				cuffia crem. idro Charan 95 in poi		
11X723	OCX				cuffia crem. idro Polo 94 in poi DX/SX		
11X724	OCX				cuffia crem. idro Vento 92 in poi DX/SX		
11X725	OCX				cuffia crem. idro Vento		
11X726	OCC				cuffia crem. Idro .ZF - DX/SX - Audi A4 (completo)		
11X757	OCC				Kit cuffie man. Audi 50		
11X758	OCC				Kit cuffie man. Audi 50		
11X759	OCC				Kit cuffie man. VW Deby		
11X760	OCC				Kit cuffie man. VW Deby		
11X761	OCC				Kit cuffie man. VW Golf-Jetta		
11X762	OCC				Kit cuffie man. Caddy-Pick Up		
11X763	OCS				cuffia man. SX VW Deby		
11X764					cuffia Audi A8 modello 4E1 - Audi A4 modello 8E1		
11X765					cuffia Audi A4 modello 8E1		
• 11X766	OCX				cuffia idro SX/DX Transporter T4,1990, 2.5TDI e 2.8 VR6 ANNO 2000		
• 11X767	OCX				cuffia idro SX/DX Transporter T4,1998, 2.5TDI e 2.8 VR6 ANNO 1996		

VOK Kit idroguida Power steering kit Ремкомплект рулевого управления
VOC Kit cremagliera Rack kit Ремкомплект гидроцилиндра
VOD Kit distributore Pignon kit Ремкомплект распределителя
VOP Kit pompa Pump kit Ремкомплект насоса
 OCD Cuffia destra Rack boot (right) Правый сайлентблок
 OCS Cuffia sinistra Rack boot (left) Левый сайлентблок
 OCX Cuffie sinistra+destra Rack boot (left+right) Набор сайлентблоков
 OCC Kit cuffie Rack boot kit Ремкомплект сайлентблоков



Codice Code Код	Ref. Приме- нение	Ø crem. rack Ø	Ø distr. pinion Ø	Ø albero shaft Ø	Descrizione per utilizzo Use remarks Примечания	Cod. originale IDROGUIDA Оригинальный номер агрегата	Cod. originale KIT Оригинальный номер ремкомплекта
• 11X768	OCX				cuffia idro sx/dx Audi A6,A8,Volkswagen		
• 11X769	OCX				Cuffia idro SX/DX termoplastico Audi A4,1994-'98, S4, S4 Cabrio, A6 Avant 1998-'01		
• 11X770	OCS				Cuffia idro SX termoplastico Audi, A4, A6		
• 11X771	OCX				Cuffia idro SX/DX termoplastico Audi A3, TT, Golf IV, Skoda-Octavia, New Beetle		
• 11X772	OCX				cuffia idro termoplastico DX/SX Hyundai H100-H150-H200, Satellite		
• 11X773	OCS				Cuffia idro SX termoplastico Audi A4, A4 Quattro		
• 11X774	OCD				Cuffia idro DX termoplastico Audi A4, A4 Quattro		
• 11X775	OCX				Cuffia idro DX/SX termoplastico New Beetle 1999 in poi, Golf IV Berlina 1997-'04		
• 11X776	OCX				Cuffia idro DX/SX termoplastico Passat Berlina,2000-'05, W8, Audi S4 1999-'01, S6 Berlina		
• 11X777	OCX				Cuffia idro DX/SX termoplastico Audi A8, S8 dal 2002, Volkswagen Phaeton		
• 11X778	OCX				Cuffia idro DX/SX termoplastico Skoda Fabia dal 2007		
• 11X779	OCX				Cuffia idro DX/SX termoplastico Audi Q7 dal 2006 in poi		
• 11X780	OCX				Cuffia idro DX/SX termoplastico Transporter V ,dal 2003 in poi		
• 11X781	OCX				Cuffia idro DX/SX termoplastico Jetta III, Eos dal 2005, Golf V Variant 2007-'08, Berlina dal '03, Audi S3 dal '06, TT Coupè 06-'07		
• 11X782	OCX				Cuffia idro DX/SX termoplastico Audi A4 Berlina/Avant, A5 Coupè dal 2007, S5, Q5 dal 2009		
• 11X800				19,00	Pompa Saginaw Golf, corpo in ghisa, MOD.CB, albero Ø19, 3 fori		
• 11X804							
• 11X814					TRW Pompa elettrica Seat Cordoba, Ibiza IV, Skoda Fabia, Vw Fox, Polo, Lupo	OE 6Q0423155AB - 6Q0423155AE	
• 11X815					TRW Pompa elettrica Audi A2 1.4TDI, 1.6 FSI>2005+	OE 8Z0423156R	
• 11X816					Idroguida Cremagliera Golf V		
• 11X817					TRW Pompa elettrica Seat Cordoba, Ibiza IV, Skoda Fabia, Vw Fox, Polo, Lupo + kit cremagliera		
• 11X900					Scatola guida meccanica Maggiolino prima serie (1973/1980)		
• 11X901					Scatola guida meccanica Maggiolone prima serie		
• 11XE900					Idroguida elettrica-Volkswagen Golf 5		

BMW

13X

Codice Code Код	Ref. Приме- нение	Ø crem. rack Ø	Ø distr. pinion Ø	Ø albero shaft Ø	Descrizione per utilizzo Use remarks Примечания	Cod. originale IDROGUIDA Оригинальный номер агрегата	Cod. originale KIT Оригинальный номер ремкомплекта
13X001	VOK	28,00			Kit idro TRW - BMW Z3, crem. Ø28		
13X002	VOK				Kit idro BMW 730iM30, 730il, 735i, 735il, 750i, 750il '89	8054991101;108;107	8054/001



Kit idroguida

Kits for power steering

Ремкомплекты для рулевого управления

Codice Code Код	Ref. Приме- нение	Ø crem. rack Ø	Ø distr. pinion Ø	Ø albero shaft Ø	Descrizione per utilizzo Use remarks Примечания	Cod. originale IDROGUIDA Оригинальный номер агрегата	Cod. originale KIT Оригинальный номер ремкомплекта
13X003	VOK	26,00			ZF - Bmw serie 3 E21 1975/83 crem. Ø26	7842955112; 7842955114; 7842955118	7842/002
13X004	VOK	26,00			ZF - BMW 316 E30 "82/86, Bmw 316, 316S, 318i, 320iS, 320i, 323i, 325 "83/86/88, Cabrio, 325iC 11/86, crem. Ø26	7832955109; 7832955123; 7832955130	7832/005 7832/007
13X005	VOK	28,00			ZF - BMW 316, 318 "90, 325i "91, crem. Ø28	7852955227	7852/006 7852/010
13X006	VOK	26,00			ZF - BMW 325iX serie 3 "90, Touring, crem. Ø26	7832955127	7832/005
13X007	VOK	26,00			ZF - BMW serie 3 E30 all. "86/92 (corpo alluminio) crem. Ø26	7832985102 7832955105/ 7832985103/ 7832985109/ 7832 955 128/ 7832 955 139/ 7832 955 145/ 7832 955 146/ 7832 955 152/ 7832 955 156/ 7832 955 158/ 7832 955 163/ 7832 955 167/ 7832 985 104	7832/008
13X007 Light		26,00			ZF - BMW III serie E30 1986/92		
13X008	VOK				ZF - BMW M3, M3C "90	7832955133	7832/009
13X009	VOK	28,00			ZF - BMW E36, 316i, 318i, 325i, crem. Ø28	7832985112 7852955213	7852/010 7852/036
13X009 Light		28,00			ZF - allegg. Bmw E36 316i-318i-325i, crem. Ø28		
13X010	VOK				ZF - BMW 730i, M30, 730il, 735i, 735i l "89/90, 750i, 750il"89/90, 850i, 850Ci "90, Touring M5	8054991115 8054991116- /122/117/119/120/130	8054/011
13X011	VOK	28,00			ZF - BMW 525ix, 525ix, Touring "88, crem. Ø26	7852955223	7852/007
13X012	VOK				ZF - BMW	8052955150 8052955170	8052/013
13X013	VOK				ZF - BMW	8053995110	8053/005
13X014	VOK				ZF - BMW 730iM60, 730il, 740i, 740il	8054955226	8054/016
13X015	VOD			28,00	ZF - BMW 635CSi, M635CSi , 89, albero Ø28	8054991105	8054/007
13X016	VOK				ZF - BMW 728i, 728iS, 732i, 735i, 735iK, 745i "79/86	8051955101 8051955104/ 8051955103 8051991110, 8051991 112/8051 991 101	8051/001
13X017	VOK				ZF - BMW 530i, M30, 535i 9/89, 520iM 20, 525iM20, 524TD 90/89	8051955114 8051955 120/ 8051 955 122/ 8051 955 126/ 8051 955 128	8051/007
13X018	VOK				ZF - BMW 520i, M20, 525i, M25, 524TD, 9/89, BMW 530iM30, 535i/ ZF BMW 520iM50, 525iM50, 525TD/TDS, ZF Touring: 518iM40, 518iM43, 520i, 525i, 525TD/TDS	7852 955 229	8051/009
13X019	VOK				ZF - BMW 325 TD 90,		7852/8
13X020	VOK				ZF - BMW 850ie, 850ci 1990, BMW 850CSi "90,	8054991134, 8054 991 141	8054/022

VOK Kit idroguida Power steering kit Ремкомплект рулевого управления
VOC Kit cremagliera Rack kit Ремкомплект гидроцилиндра
VOD Kit distributore Pignon kit Ремкомплект распределителя
VOP Kit pompa Pump kit Ремкомплект насоса
OCD Cuffia destra Rack boot (right) Правый сайлентблок
OCS Cuffia sinistra Rack boot (left) Левый сайлентблок
OCX Cuffie sinistra+destra Rack boot (left+right) Набор сайлентблоков
OCC Kit cuffie Rack boot kit Ремкомплект сайлентблоков



Codice Code Код	Ref. Приме- нение	Ø crem. rack Ø	Ø distr. pinion Ø	Ø albero shaft Ø	Descrizione per utilizzo Use remarks Примечания	Cod. originale IDROGUIDA Оригинальный номер агрегата	Cod. originale KIT Оригинальный номер ремкомплекта
13X021	VOK				ZF - BMW 730, 735i "86, BMW 730iM30, 730il, 735i, 735il, 9/89, BMW 730, 735 "89, BMW M5, B36 "89,	8054955203, 8054 955 218/ 8054 955 216/ 8054 955 242/ 8054 955 240/ 8054 955 222	8054/004 8054/003
13X022	VOK				ZF - BMW 730i M60, 730il, 740i, 740il	8054991126	8054/020
13X023	VOK				ZF - BMW 628CSi, 630CSi, 633, 635CSi "5/82 e "6/87,518, 518i, 520i, 525E, 524TD, 525i, 528i	8052955213, 8052955225/ 8052955206 8054955214, 8054955238/ 8054955236	8052/032
13X024	VOK				ZF - BMW M5B36, M5B38 "89, Touring M5	8054955207	8054/013
13X025	VOK				ZF - BMW 520i	8052955207	8052/034
13X026	VOD			28,00	ZF - BMW 635 "86/87, albero Ø28	8054955205	8054/005
13X027	VOK	24,00			ZF - BMW servotronic, crem. Ø24	7842955111	7840/050
13X028	VOK				ZF - BMW serie 5	8051995111	8051/011
13X029	VOK				ZF - BMW	8051955115, 8051955123 /8051955127	8051/013
13X030	VOK				ZF - BMW 628CSi, 630CS, 633CSi, 635CSi "05/82,518, 518i, 520/4e6, 520i, 525, 528, 528i, M535i serie 5	8052955172 8052955187	8052/028
13X031	VOK				ZF - BMW serie 7	8051955102	8051/003
13X032	VOK				ZF - BMW 1.5, 1.8, 2.0	7316955177	7316/120
13X033	VOK				ZF - BMW "90	7810955116 7810955107	
13X034	VOK				ZF - BMW 316, 318, 320 "90	7810955107	7810/104
13X035	VOK	28,00			ZF - BMW, Jaguar XJS "85, 96, crem. Ø28	7852955272/ 7852974221, 223	7852/011
13X036	VOK	28,00			ZF - BMW, Jaguar JX40 "93, crem. Ø28	7852974230, 233	7852/019
13X037	VOK				ZF - BMW	7820900177	7820/104
13X038	VOK				ZF - BMW	7820955143	7820/116
13X039	VOK				ZF - BMW		8055/007
13X040	VOK	28,00			ZF - BMW E39 5 serie 6CIL. "95, crem. Ø26		7852/048
13X041	VOK	30,00			ZF - BMW X5 servotronic E53 LH 2003, crem. Ø30	7852974553	7852/538 7852/539
13X042	VOK				ZF - BMW serie 7	8075991107	8075/002
13X043	VOK				ZF - BMW 535i/540i & touring 1"6/97	8074955301	8074/001
13X044	VOK	28,00			ZF - BMW serie 3 E46 1998, crem. Ø28	7852974651	7852/053 7852/514
13X045	VOK	28,00			ZF - BMW E39, 520i, 523i, 525TDS, 528i, 525d, serie 5 "98 servotronic, crem. Ø28	7852991165/ 7852993223 / 7852991175 / 7852501553	7852/051
13X046	VOK				ZF - BMW 740i	8054991126	8054/020
13X047	VOK				ZF - BMW E34 serie 5		8054/016
13X048	VOK	28,00			ZF - BMW serie 5 E39 "95/97, crem. Ø28	7852991165	7852/044
13X049	VOK	28,00			ZF - BMW serie 5 E39, no servotronic, crem. Ø28		7852/048
13X050	VOK	28,00			ZF - BMW serie 5 E39, 520i, 523i, 525TDS, 528 "98, servotronic, crem. Ø28	7852955305	7852/049
13X051	VOK				ZF - BMW serie 7	8054955204	8054/004
13X052	VOK				ZF - BMW 740i		8075/001
13X053	VOK	28,00			TRW - BMW E46/Z3 "98, crem. Ø28		



Kit idroguida

Kits for power steering

Ремкомплекты для рулевого управления

Codice Code Код	Ref. Приме- нение	Ø crem. rack Ø	Ø distr. pinion Ø	Ø albero shaft Ø	Descrizione per utilizzo Use remarks Примечания	Cod. originale IDROGUIDA Оригинальный номер агрегата	Cod. originale KIT Оригинальный номер ремкомплекта
13X054	VOK	30,00			ZF - BMW X5 2000, crem. Ø30	7852974553 7852974879	7852/538 7852/533
13X054A	VOK	30,00			ZF - Allegerito BMW serie 5 (X5), crem. Ø30		
13X055	VOK	28,00			ZF - BMW E39 5°serie 6CIL LHD '95/03, crem. Ø28		7852/036
13X056	VOK	24,00			ZF - BMW Mini One 2001, crem. Ø24	7891974233/ 198/236/250	7891/503
13X057	VOK	31,00			ZF - BMW serie 7 E65, crem. Ø31	7852993269/ 403/661/731	7852/537
13X058	VOK				ZF - BMW serie 7 E38	8075955301/2	8075/002
13X059	VOK				ZF - BMW serie 7 E38	8075955303	8075/004
13X060	VOK	28,00			ZF - BMW serie 3 E36 '91/98, crem. Ø28	7852955306	7852/008 7852/060
13X061					ZF - BMW E60 serie 5 520 i	7852993587	7852/555
13X062	VOK	27,70			ZF - BMW serie 3 E36, (KOJO), crem. Ø27,7	7852955306	KOJO
13X063	VOK	28,00			ZF - BMW E39 senza soffietti serie 5 U.T., crem. Ø28	7852955278	
13X064	VOK	28,00			ZF - BMW 5 serie E60 servotronic dal 2003, crem. Ø28	7853974103 7852993583	7852/556
13X065	VOK	28,00			ZF - BMW serie 3, con tappo copri pignone alto, crem. Ø28		7852/008
13X066	VOK	30,00			BMW X3, crem. Ø30, con parte metallica	7852993149- 7853974330	7852/560
• 13X066M	VOK	30,00			BMW X3, crem. Ø30, senza parte metallica	7852993149- 7853974330	7852/560
• 13X067	VOK	24,00			ZF - Mini Cooper 2002-'06, crem. Ø24		
13X601	VOP				Kit pompa ZF BMW serie 3		7671/006
13X602	VOP			20,00	ZF - BMW serie 7		7672/017
13X603	VOP			19,05	Kit pompa BMW, albero Ø19,05		
• 13X603 Light				19,05	pompa allegg. BMW, albero Ø19,05		
13X604	VOP				Kit pompa BMW	7672955144 7672955210	
13X605	VOP			15,00	Kit pompa LUK BMW E46		
• 13X606					Kit pompa ZF BMW 330 anno 1998	7697974102	
• 13X607					pompa LUK BMW, doppio attacco		
13X701	OCX				Cuffia crem. Idro sx/dx (TRW) idro BMW		
13X702	OCX				Cuffia crem. idro DX BMW E21 77/83 con steer dumper		
13X703	OCX				Cuffia crem. idro SX BMW E21 77/83 con steer dumper		
13X704	OCX				Cuffia crem. idro DX/SX BMW E21 77/83 con power steer		
13X705	OCX				Cuffia crem. idro DX BMW E30 87/94 con steer dumper		
13X706	OCX				Cuffia crem. idro SX BMW E30 87/94 con steer dumper		
13X707	OCX				Cuffia crem. idro SX BMW E30 87/94 con power steer		
13X708	OCX				Cuffia crem. idro DX BMW 316/318/320		
13X709	OCX				Cuffia crem. idro SX BMW 316/318/320		
13X711	OCX				Kit cuffia crem. idro BMW E21 77/83 con steer dumper (COMPLETO)		
13X712	OCX				Kit cuffia crem. idro BMW E30 87/94 con steer dumper (COMPLETO)		

VOK Kit idroguida *Power steering kit* Ремкомплект рулевого управления
VOC Kit cremagliera *Rack kit* Ремкомплект гидроцилиндра
VOD Kit distributore *Pignon kit* Ремкомплект распределителя
VOP Kit pompa *Pump kit* Ремкомплект насоса
 OCD Cuffia destra *Rack boot (right)* Правый сайлентблок
 OCS Cuffia sinistra *Rack boot (left)* Левый сайлентблок
 OCX Cuffie sinistra+destra *Rack boot (left+right)* Набор сайлентблоков
 OCC Kit cuffie *Rack boot kit* Ремкомплект сайлентблоков



Codice Code Код	Ref. Применение	Ø crem. rack Ø	Ø distr. pinion Ø	Ø albero shaft Ø	Descrizione per utilizzo Use remarks Примечания	Cod. originale IDROGUIDA Оригинальный номер агрегата	Cod. originale KIT Оригинальный номер ремкомплекта
		Dimensioni					
13X713	OCX				Kit cuffia crem. idro BMW 316/320 (completo)		
• 13X714	OCX				cuffia crem. idro termoplastico DX/SX BMW		
• 13X715	OCX				cuffia crem. idro termoplastico DX/SX BMW X5 E70 dal 2006		
13X751	OCX				Cuffia man. SX/DX BMW 315/316		
• 13X752	OCX				Cuffia idro SX/DX BMW 3 serie E46		
• 13X753	OCX				Cuffia idro SX/DX BMW 3 serie E46, BMW Z4		
• 13X754	OCX				Cuffia idro SX/DX BMW 3 serie E46		
• 13X755	OCX				Cuffia idro termoplastico SX/DX, BMW X5 E52		
• 13X756	OCX				cuffia idro termoplastico SX/DX, Mini 2001-'06, Mini Cabrio 2004-'06		
• 13X757	OCX				cuffia idro termoplastico SX/DX Bmw serie 5 Berlina E60, dal 2003 in poi, Touring		
• 13X758	OCX				cuffia idro termoplastico SX/DX Bmw serie 1 Berlina 2004-'07, serie 3 2005-'08, serie 3 Touring 2006-'07		
13X801					Pompe non, genuine BMW		
13X802	ZF				Pompa elettrica completa Nuova Mini (Mini cooper)	7625955146 / 7652955107 / 7625955137 / 7625955131	7625477136

Chevrolet (ex Daewoo)

61X

Codice Code Код	Ref. Применение	Ø crem. rack Ø	Ø distr. pinion Ø	Ø albero shaft Ø	Descrizione per utilizzo Use remarks Примечания	Cod. originale IDROGUIDA Оригинальный номер агрегата	Cod. originale KIT Оригинальный номер ремкомплекта
		Dimensioni					
61X001	VOK	25,00			Kit idro Daewoo Nubira, crem. Ø25		
61X002	VOK	23,00			Kit idro Daewoo Matiz '99, crem. Ø23		
61X751	OCX				Cuffia man. SX/DX Daewoo Nexia		
• 61X752	OCX				Cuffia idro termoplastico SX/DX Chevrolet Evanda dal 2005, Epica dal 2006		
• 61X753	OCX				Cuffia idro termoplastico SX/DX Daewoo Kalos 1997-'04		

Daihatsu

19X

Codice Code Код	Ref. Применение	Ø crem. rack Ø	Ø distr. pinion Ø	Ø albero shaft Ø	Descrizione per utilizzo Use remarks Примечания	Cod. originale IDROGUIDA Оригинальный номер агрегата	Cod. originale KIT Оригинальный номер ремкомплекта
		Dimensioni					
19X001	VOK	22,00			Daihatsu Applause, crem. Ø22		
19X701	OCX				Cuffia crem. idro Mira 660 3/90>, Mira 660 KWD 8/94> - 550 CUORE		
19X702	OCX				Cuffia crem. idro Mira 8 DAL '94		
19X703	OCX				Cuffia crem. idro 1000 Charade, Mira 660		
19X704	OCX				Cuffia crem. idro 1000 Charade, Mira 660		
• 19X705	OCX				Cuffia crem. idro termoplastico, SX/DX Daihatsu Sirion 1997		
• 19X706	OCX				Cuffia crem. idro termoplastico, SX/DX Daihatsu Sirion, Terion 2000		
• 19X707	OCX				Cuffia crem. idro termoplastico DX/SX, Daihatsu Charade V-IV 1997 in poi		



Kit idroguida

Kits for power steering

Ремкомплекты для рулевого управления

Codice Code Код	Ref. Приме- нение	Ø crem. rack Ø	Ø distr. pinion Ø	Ø albero shaft Ø	Descrizione per utilizzo Use remarks Примечания	Cod. originale IDROGUIDA Оригинальный номер агрегата	Cod. originale KIT Оригинальный номер ремкомплекта
		Размеры					
• 19X708	OCX				Cuffia idro termoplastico DX/SX, Daihatsu Charade III 1987-'93, Charade V 1993-'97		
• 19X709	OCX				Cuffia idro termoplastico DX/SX, Daihatsu Applause I 1989-97, II 1997 in poi		
• 19X710	OCX				Cuffia idro DX/SX, Daihatsu Cuore 2003-'05, Sirion 2004-'08, Materia 2006-'08		
19X751					Cuffia man. DX Daihatsu		
19X752					Cuffia man. SX Daihatsu		
19X753					Cuffia man. DX Daihatsu		
19X754					Cuffia man. SX Daihatsu		
19X755					Cuffia man. DX Daihatsu		
19X763	OCC				Kit cuffia man. Daihatsu		
19X764	OCC				Kit cuffia man. Daihatsu		
19X765	OCC				Kit cuffia man. Daihatsu		
19X766	OCC				Kit cuffia man. Daihatsu		
19X767	OCC				Kit cuffia man. Daihatsu		
19X768	OCC				Kit cuffia man. Daihatsu		

Ferrari

21X

Codice Code Код	Ref. Приме- нение	Ø crem. rack Ø	Ø distr. pinion Ø	Ø albero shaft Ø	Descrizione per utilizzo Use remarks Примечания	Cod. originale IDROGUIDA Оригинальный номер агрегата	Cod. originale KIT Оригинальный номер ремкомплекта
		Размеры					
21X001	VOK				ZF - Ferrari 456 GT 1993/02 Servotronic	7832993103	7832/012

Fiat (auto veicoli commerciali)

22X

Codice Code Код	Ref. Приме- нение	Ø crem. rack Ø	Ø distr. pinion Ø	Ø albero shaft Ø	Descrizione per utilizzo Use remarks Примечания	Cod. originale IDROGUIDA Оригинальный номер агрегата	Cod. originale KIT Оригинальный номер ремкомплекта
		Размеры					
22X001	VOD				TRW - Tipo, Tempra, Punto, Regata con un paraolio dis.1PM Øi 19 e un paraolio dis.4 Øi 23,4		
22X002	VOD				TRW - Regata ,Nuova Ritmo TD 1993 con un paraolio dis.1PM Øi 20,6 e un paraolio dis.2 Øi 25		
22X003	VOD				TRW - Croma		
22X004	VOD				TRW -		
22X005	VOK	25,00			TRW - 131 diesel 2,5 - 2.0 super, Panorama "81 crem. Ø25		10321
22X006	VOK	23,00			TRW -Ypsilon 1985/95, Punto, Tipo, Tempra 89, crem. Ø23		
22X007	VOK	23,00			Argenta, 132 "72/85, Bravo "95/02, Tempra, Tipo "88/95, crem. Ø23	15000783/ 785/15001000/ 15001022/ 15000891/ 15000758	
• 22X007 Light		23,00			allegg.Fiat Argenta 132 72-85, Bravo 95-02, Tempra, crem. Ø23		
22X008	VOK	25,00			TRW - Croma tutti i tipi 11/"85 - 2 paraoli, crem. Ø23		
22X009	VOK	23,00			Punto GT, Dedra "90, Tempra, crem. Ø23		
22X010	VOK	23,00			TRW - Marea 1.6, 1.8, 2.0i TD, 2.4, 125 BN Berlina, Weekend "96, crem. Ø23		

VOK Kit idroguida Power steering kit Ремкомплект рулевого управления
VOC Kit cremagliera Rack kit Ремкомплект гидроцилиндра
VOD Kit distributore Pignon kit Ремкомплект распределителя
VOP Kit pompa Pump kit Ремкомплект насоса
 OCD Cuffia destra Rack boot (right) Правый сайлентблок
 OCS Cuffia sinistra Rack boot (left) Левый сайлентблок
 OCX Cuffie sinistra+destra Rack boot (left+right) Набор сайлентблоков
 OCC Kit cuffie Rack boot kit Ремкомплект сайлентблоков



Codice Code Код	Ref. Приме- нение	Ø crem. rack Ø	Ø distr. pinion Ø	Ø albero shaft Ø	Descrizione per utilizzo Use remarks Примечания	Cod. originale IDROGUIDA Оригинальный номер агрегата	Cod. originale KIT Оригинальный номер ремкомплекта
22X011	VOK	23,00			TRW - Bravo, Brava "95, crem. Ø23		
22X012	VOK	23,00			TRW - Tipo, crem. Ø23		
22X013	VOK				ZF - 131 Mirafiori "78-80	7840955109/ 101/104/105/110	7840/1
22X014	VOK				ZF - Campagnola benz/diesel	8055955107/110 - 8055955115	8055/3
22X015	VOK				ZF -	8052955183	8052/20
22X016	VOK				ZF - 132	8052974101	8052/22
22X017	VOK				ZF - 132 Argenta "81/85 benzina/diesel	8052974101/ 8052974103/ 8052974105/ 8052955208	8052/36
22X018	VOK	25,00			TRW - Cromia 2°serie ,1 par. dis.6,1 dis.7, crem. Ø25		
22X019	VOK	25,00			TRW - Cromia 3°serie, 2 paraoli dis.6, crem. Ø25		
22X020	VOK	25,00			Saginaw - Bravo, Brava 100 16V, 115 16V, 155 16V "86, crem. Ø25		
22X021	VOK				ZF -	7816955105	7816/2
22X022	VOK				ZF - Campagnola	7330955114	7330/101
22X023	VOK	25,00			Saginaw - Fiorino '94 U.T, Vectra 96-'02, alta temp., crem. Ø25		
22X023 Light		25,00			allegg. Saginaw Fiorino 1994 U.T,Vectra 1996-'02, crem. Ø25		
22X024	VOK	25,00			Saginaw - Fiorino "94 normale 1°serie, crem. Ø25		
22X025	VOK	28,00			TRW - Scudo, crem. Ø28		
22X026	VOK	30,00			TRW - Ducato "90, crem. Ø30		
22X027	VOK	30,00			Ducato Maxi 1,6 benz/diesel.4x4 diesel TD. "90/94, crem. Ø30		
22X028	VOK	30,00			TRW - nuovo Ducato Restyling "94/99, crem. Ø30		
22X029	VOK	30,00			TRW - Daily Grinta T.T., 40,10 4x4 45,10, 49,10 turbo/59, 12 turbo Interc. "89, crem. Ø30		
22X030	VOK	30,00			TRW - Daily "96 3510, crem. Ø30		3510
22X030 Light		30,00			allegg. TRW Daily 1996, crem. Ø30		
22X031	VOK	28,00			ZF - Daily,4x4, crem. Ø28	7852955200	7852/1
22X032	VOK	28,00			TRW - Ulisse 2/91 2.0 turbo, 1.9 TD, 2.1 12V TD 6/94, crem. Ø28		
22X033	VOK	30,00			ZF - Iveco, crem. Ø30	7852974549	7852/15
22X034	VOK	23,00			TRW - Palio "98 -"02, crem. Ø23		
22X034 Light		23,00			allegg. Fiat Palio 1998-'02		
22X035	VOK	25,00			KIT IDRO TRW FIAT 131 crem ø25		
22X036	VOK				ZF - Iveco Magnum		7852/001
22X037	VOK	28,00			ZF - Daily U.Tipo, crem. Ø28		7852/26
22X038	VOK	28,00			ZF - Daily City C11-C13-C15, crem. Ø28	7852974431	7852/507
22X039	VOK				Kit revisione scatola guida OM 50 ZF	7340955134	7340120134
22X040	VOK	25,00			Saginaw - Fiorino "89/98, crem. Ø25		
22X066	VOK	25,00			TRW Fiat 131 distributore Ø40		
22X067	VOK	25,00			TRW - Marea U.Tipo con un paraolio dis. 7 e un paraolio dis. 6, crem. Ø25		
22X068	VOK	25,00			TRW - Multipla, crem. Ø25		
22X069	VOK	23,00			TRW - Bravo, Brava, crem. Ø23		



Kit idroguida

Kits for power steering

Ремкомплекты для рулевого управления

Codice Code Код	Ref. Приме- нение	Ø crem. rack Ø	Ø distr. pinion Ø	Ø albero shaft Ø	Descrizione per utilizzo Use remarks Примечания	Cod. originale IDROGUIDA Оригинальный номер агрегата	Cod. originale KIT Оригинальный номер ремкомплекта
22X070	VOK	25,00			TRW - Marea U.T paraoli dis.7, Libra "95, crem. Ø25	15001049/115- 15000 987/827/998/930/932/ 991/940/938	
22X071	VOK	28,00			TRW -Jampy, Scudo, Tempra, Lancia Zeta, Sinergy "94/02, crem. Ø28		
22X072	VOK	30,00			Ducato "98, crem. Ø30		
22X073		25,00			Fiat Doblò, crem. Ø25		
• 22X074	VOK	32,00			TRW Iveco C13, C15, anno 2007/08, crem Ø32	EN AC 46000 011 A0005149	
• 22X075	VOK	32,00			Kit idro Fiat Ducato dal 2006, crem. Ø32		
• 22X076	VOK	25,00			Kit idro Fiat Qubo, crem. Ø25		
22X600	VOP			19,05	kit pompa (Saginaw), albero Ø19,05		
22X601	VOP				kit pompa Saginaw con albero nuovo		
22X602	VOP				kit pompa Saginaw con albero standard		
22X603	VOP			19,05	kit pompa Saginaw serie P/N 88/132/235		
• 22X603 Light	VOP			19,05	pompa allegg. Saginaw serie P/N 88/132/235,albero Ø 19,05		
22X604	VOP			19,05	pompa Saginaw serie TC 40/60/88, albero Ø19,05		
• 22X604 Light	VOP			19,05	pompa allegg. Saginaw serie TC 40/60/88, albero Ø19,05		
22X605	VOP			19,05	kit pompa (Saginaw) Tipo CB alta temperatura, albero Ø19,05		
• 22X605 Light				19,05	pompa Saginaw allegg. Tipo CB alta temperatura, albero Ø19,05		
22X606	VOP			19,05	kit pompa (Saginaw) Tipo CB Ø19 DS 1985/1990, albero Ø19,05		
22X607	VOP			19,05	kit pompa Saginaw Tipo CB Ø19 sn 1985/1990, albero Ø19,05		
22X608	VOP			19,05	kit pompa (Saginaw) Tipo CB DS alta temperatura, albero Ø19,05		
22X609	VOP			19,05	kit pompa ZF Croma, albero Ø19,05		7681/005 7681/003
22X610	VOP				kit pompa ZF Ducato	7684955124- 7683955114/126	7683/001 7683/006
22X611	VOP			17,00	kit pompa Daily, albero Ø17	7673955116	7673/1
22X612	VOP			19,00	Kit pompa ZF Ducato, albero Ø19		
22X613	VOP			19,05	kit pompa Saginaw alta temperatura modelli vari, albero Ø19,05		
22X614	VOP			18,00	kit pompa Brava-Bravo, 1.9 D., albero Ø18		
22X615	VOP			17,00	kit pompa con paraolio alta temp. righe sx con rotazione dx, albero Ø17		
22X616	VOP				kit pompa con paraolio Ø19X33,3 righe sx rotazione dx e boccola L.42,5		
22X617	VOP				kit pompa Tipo CB alta temperatura con boccola		
22X701	OCD				Cuffia crem. Idro dx Croma 85/93		
22X702	OCS				Cuffia crem. idrosx Croma 85/93		
22X703	OCS				Cuffia crem. idro(TRW) sx Regata 1/84-3/89 (tutte escluso 1800/2000)		
22X705	OCD				Cuffia crem. idro(TRW) dx Regata 1/84-3/89 (tutte escluso 1800/200)		
22X707	OCX				Cuffia crem. idro(TRW) sx/dx Tipo 1988> - TEMPRA 1990>		

VOK Kit idroguida *Power steering kit* Ремкомплект рулевого управления
VOC Kit cremagliera *Rack kit* Ремкомплект гидроцилиндра
VOD Kit distributore *Pignon kit* Ремкомплект распределителя
VOP Kit pompa *Pump kit* Ремкомплект насоса
OCD Cuffia destra *Rack boot (right)* Правый сайлентблок
OCS Cuffia sinistra *Rack boot (left)* Левый сайлентблок
OCX Cuffie sinistra+destra *Rack boot (left+right)* Набор сайлентблоков
OCC Kit cuffie *Rack boot kit* Ремкомплект сайлентблоков



Codice Code Код	Ref. Приме- нение	Ø crem. rack Ø	Ø distr. pinion Ø	Ø albero shaft Ø	Descrizione per utilizzo Use remarks Примечания	Cod. originale IDROGUIDA Оригинальный номер агрегата	Cod. originale KIT Оригинальный номер ремкомплекта
22X708	OCX				Cuffia crem. idro(TRW) sx/dx Tipo 1993>		
22X709	OCX				Cuffia crem. idro(TRW) sx/dx Punto 1993>		
22X710	OCX				Cuffia crem. idroman. Bravo-Brava		
22X711	OCD				Cuffia crem. idro(TRW) dx Croma 1994 in poi		
22X712	OCX				cuffia crem. Daily 1978		
22X713	OCX				cuffia crem. Ducato 1981,Talento 1981 > dx/sx		
22X714	OCS				Cuffia crem. idro(TRW) sx Croma 1994 in poi		
22X715	OCX				Cuffia crem. idro(TRW) sx/dx Bravo/Brava 1995 >(idro)		
22X716	OCC				kit cuffie crem. idro Croma 85/93		
22X717	OCC				kit cuffie crem. idro (TRW) Croma 1994 in poi (completo)		
22X718	OCC				kit cuffie crem. idro (TRW) Regata 1800-2000 (completo)		
• 22X719					Cuffia idro termoplastico SX/DX, Fiat Barchetta, Bravo, coupe, Marea, Palio		
• 22X720					Cuffia idro termoplastico SX/DX, Fiat Doblò, Cargo 2001-'05		
• 22X721					Cuffia idro termoplastico SX/DX, Fiat Stilo, Stilo Multivagon 2001-'07		
22X726	OCD				cuffia crem. dx Ducato		
22X727	OCS				cuffia crem. sx Ducato		
• 22X728	OCX				cuffia idro termoplastico SX/DX, Fiat Multipla		
• 22X729	OCX				cuffia idro termoplastico SX/DX, Fiat Ulysse 2002-'07		
• 22X730	OCX				cuffia idro termoplastico SX/DX, Fiat Strada dal 2000 in poi		
• 22X731	OCX				cuffia idro termoplastico SX/DX, Fiat Croma dal 2005		
• 22X732	OCX				cuffia idro termoplastico SX/DX, Fiat Nuova 500 dal 2007, Fiat Panda/Panda Van dal 2003		
• 22X733	OCX				cuffia idro termoplastico SX/DX, Fiat Doblò/Doblò Cargo dal 2005		
• 22X734	OCX				cuffia crem. termoplastico SX/DX Fiat Grande Punto / Grande Punto Van dal 2005		
• 22X735	OCX				cuffia crem. termoplastico SX/DX Fiat Scudo 2003-'04		
• 22X736	OCX				cuffia crem. termoplastico SX/DX Fiat Bravo dal 2007		
• 22X737	OCX				cuffia crem. termoplastico SX/DX Fiat Sedici dal 2006		
• 22X738	OCX				cuffia crem. termoplastico SX/DX Fiat Idea dal 2004		
• 22X739	OCX				cuffia crem. termoplastico SX/DX Fiat Ulysse 2006-'07		
• 22X740	OCX				cuffia crem. termoplastico SX/DX Fiat Scudo Furgone/Combi dal 2006		
• 22X741	OCX				cuffia crem. termoplastico SX/DX Fiat Tipo 1988-'94, Bravo/Brava 1995-'01, Bravo 2007		
• 22X742	OCX				cuffia crem. SX/DX Fiat 600 1999-'07		
22X762	OCC				kit cuffie man. 131-132		
22X763	OCC				kit cuffie man. Regata		
22X764	OCC				kit cuffie man. UNO 83-		
22X765	OCC				kit cuffie man. Ducato,Talento		
22X766	OCX				cuffia idro sx/dx Ulysse		



Kit idroguida

Kits for power steering

Ремкомплекты для рулевого управления

Codice Code Код	Ref. Приме- нение	Ø crem.	Ø distr.	Ø albero	Descrizione per utilizzo Use remarks Примечания	Cod. originale IDROGUIDA Оригинальный номер агрегата	Cod. originale KIT Оригинальный номер ремкомплекта
		rack Ø	pinion Ø	shaft Ø			
		Размеры					
22X767	OCX				cuffia idro sx/dx Scudo		
22X768	OCD				cuffia dx per crem. idro Ducato 1800/2000		
22X769	OCS				cuffia idro sx Fiat Ducato 1.8-2.0, 4x4		
22X770	OCD				cuffia idro dx Ducato TD		
22X771	OCS				cuffia idro sx Ducato TD		
22X772	OCC				kit cuffie idro Ducato		
22X773	OCC				kit cuffie idro Ducato TD		
22X774	OCC				kit cuffie idro Regata		
22X775	OCC				kit cuffie idro Ducato		
22X776	OCD				cuffia man. dx Fiorino, Panorama		
22X777	OCS				cuffia man. sx Fiorino, Panorama		
22X778	OCC				kit cuffie man. Fiorino, Panorama		
22X779	OCD				cuffia man. dx Marengo		
22X780	OCS				cuffia man. sx Marengo		
22X781	OCC				kit cuffie man. Marengo		
• 22X782	OCX				Cuffia Fiat 500/600 DX-SX		
• 22X783	OCX				Cuffia idro SX/DX Fiat Tipo, Tempa		
• 22X808					Pompa elettroidraulica Fiat Scudo U.T. anno 2007, Jampy, Ulisse		
• 22X809					Pompa elettroidraulica nuova Fiat Croma e Ducato I° serie		
• 22X810					Pompa elettroidraulica nuova Fiat Croma e Ducato II° serie		
22X900					Scatola guida meccanica Fiat-Iveco Veicoli commerciali OM 40 (L 400)		
22X901					Scatola guida meccanica Fiat-Iveco Veicoli commerciali OM 50 7340 955 134 (L 500)		
• 22XE900					Idroguida elettrica Fiat Punto 188, fisso		
• 22XE900R					Idroguida elettrica Fiat Punto 188, piantone sterzo regolabile		
• 22XE901					Idroguida elettrica Fiat Grande Punto		
• 22XE902					Idroguida elettrica Fiat Panda, solo piantone sterzo		
• 22XE903					Idroguida elettrica Fiat Stilo 2003		
• 22XE904					Idroguida elettrica Fiat Idea 2006		
• 22XE905					Idroguida elettrica Fiat Seicento		
• 22XE906					Idroguida elettrica Fiat Panda 2004		
• 22XE907					Idroguida elettrica Fiat Bravo 2007		
• 22XE908					Idroguida elettrica Fiat 500 2008 senza ESP		
• 22XE909					Idroguida elettrica Fiat 500 2008 con ESP		
• 22XE910					Idroguida elettrica Fiat Stilo Van 2007		

Ford - Mazda

23X

Codice Code Код	Ref. Приме- нение	Ø crem.	Ø distr.	Ø albero	Descrizione per utilizzo Use remarks Примечания	Cod. originale IDROGUIDA Оригинальный номер агрегата	Cod. originale KIT Оригинальный номер ремкомплекта
		rack Ø	pinion Ø	shaft Ø			
		Размеры					
23X001	VOK	26,00			Kit idro ZF Ford Scorpio 1995, crem. Ø26	7832974107/108	7832/13
23X002	VOK	24,00			kit idro ZF Ford Sierra '82/84, LHD, crem. Ø24	7831955102	7831/2

VOK Kit idroguida Power steering kit Ремкомплект рулевого управления
VOC Kit cremagliera Rack kit Ремкомплект гидроцилиндра
VOD Kit distributore Pignon kit Ремкомплект распределителя
VOP Kit pompa Pump kit Ремкомплект насоса
 OCD Cuffia destra Rack boot (right) Правый сайлентблок
 OCS Cuffia sinistra Rack boot (left) Левый сайлентблок
 OCX Cuffie sinistra+destra Rack boot (left+right) Набор сайлентблоков
 OCC Kit cuffie Rack boot kit Ремкомплект сайлентблоков



Codice Code Код	Ref. Приме- нение	Ø crem. rack Ø	Ø distr. pinion Ø	Ø albero shaft Ø	Descrizione per utilizzo Use remarks Примечания	Cod. originale IDROGUIDA Оригинальный номер агрегата	Cod. originale KIT Оригинальный номер ремкомплекта
23X003	VOK	24,00			Kit idro ZF Ford Sierra '84,Scorpio '85, Ford Sierra 4x4, crem. Ø24	7831 955 104/7831 955 108/7831 955 113/7831 955 116/7831 955 107/7831 955 117/7831 955 111/7831 955 118	7831/3
23X004	VOK	30,00			Kit idro ZF Ford Transit '86-96, crem. Ø30	7852974203/204/208	7852/4
23X004 Light					allegg. Ford transit '86-96		
23X005	VOK				kit idro ZF Ford Sierra,Granada '8185	7832955105	7832/2
23X006	VOK	24,00			kit idro ZF Ford Sierra 4x4, Ford Sierra '89, Ford Sierra, Scorpio, crem. Ø24	7831 974 113/7831 974 102/7831 974 114/7831 974 119/7831 974 120 7831974127/7831974 130/7831974126/783 1974128/7831974123	7831/6
23X007	VOK				Kit idro ZF Ford Scorpio'85,Sierra '89/93		7831/8 7831/7
23X008	VOK	26,00			Kit idro ZF Ford Scorpio servotronic,Granada, crem. Ø26	7832991102/103	7832/15
23X009	VOK	30,00			kit idro ZF Ford Transit 1986-96, Iveco, crem. Ø30	7852974247	7852/15
23X010	VOK	30,00			Kit idro ZF Ford Transit (VE83) Rack 97-(85-00), crem. Ø30	97VB3N503AA	7852/50
23X011	VOK				F.Granada MK2 '75/81, Capri, Cortina MK3 '70/80		
23X012	VOK	25,00			TRW Ford Escord, Orion, Sierra "80-90", crem. Ø25		
23X012 Light		25,00			TRW allegg. F.Escord, Orion, Sierra "80-90", crem. Ø25		
23X013	VOK	25,00			Ford Probe senza turbo, Mazda 626 88/92, crem. Ø25		
23X014	VOK	25,00			Sierra 82/84 Cam, Ford Sierra '90 Coswort, crem. Ø25	34006 267LH	
23X015	VOK	28,00			TRW Ford Galaxy, crem. Ø28		
23X016	VOK				Kit idro Ford Granada MK1 72/75, Lotus Elite		
23X017	VOK				Kit idro Ford Explorer '95/99		F5TZ3E501A
23X018	VOK				Kit idro Ford Probe con turbo Mazda 626 MX6 '88/93		
23X019	VOK				Kit idro Ford Taurus, Mercury Sable '96/98		
23X020	VOK				Ford truck, Expedition serie E '92/98		
23X021	VOK	25,00			kit idro Ford truck Windstar, crem. Ø25		
23X022	VOK	23,00			Kit idro Mazda 323 MX3 '89/94, Ford Escort 1,8, crem. Ø23		
23X023	VOK				Kit idro Ford 74/76, Mustang grande 71/76, Mustang Mercury 86/95, Thunderbird-aerostar		
23X024	VOK	25,00			Kit idro TRW Ford Probe, Mazda 626, MX6 '93/97, crem. Ø25		
23X025	VOK				Kit idro Mazda 929 '88/89		
23X026	VOK	28,00			Mazda MPV '89/94, Kia Carnival, crem. Ø28		
23X027	VOK				Kit idro Mazda 323,Miata MX5 1990-95, crem. Ø23		



Kit idroguida

Kits for power steering

Ремкомплекты для рулевого управления

Codice Code Код	Ref. Приме- нение	Ø crem. rack Ø	Ø distr. pinion Ø	Ø albero shaft Ø	Descrizione per utilizzo Use remarks Примечания	Cod. originale IDROGUIDA Оригинальный номер агрегата	Cod. originale KIT Оригинальный номер ремкомплекта
23X028	VOK				Kit idro Mazda RX7 '86/92		
23X029	VOK				Kit idro TRW Mazda 626 '83/88 no turbo, MX6 83/87		
23X030	VOK	23,00			Tracer 1.9cc '91/93, Escort 97-01, crem.Ø23		
23X031	VOK				Kit idro a crem.Ford Probe 88/93, Mazda 626, MX6 88/92 TRW		
23X032	VOK			32,00	Ford Transit tipo A Ø32 Bendix rotore a sfere, albero Ø32		
23X033	VOK			40,00	Ford Transit tipo B Ø40 Bendix rotore a sfere, albero Ø40		
23X034	VOK				Kit idro TRW Ford Lincoln, Mercury '78/92 (Ford camion 80/92)		
23X035	VOK				Kit idro TRW Ford Mercury 80/86, Mustang '79/85		
23X036	VOK	25,00			TRW Ford Mondeo, Fiesta '96, crem. 25		
23X036 Light		25,00			allegg. Ford Mondeo, crem.Ø25		
23X037	VOK	25,00			Kit idro F.Fiesta saginaw 92/01,KA 90/96, Contur 95/97, crem. Ø25		
23X038	VOK				Kit idro ZF Ford	7816974105	7816/102
23X039	VOK				kit molle a tazza per Bendix a sfere (n.6 pz.)		
23X039A	VOK				kit mollea tazza per Bendix a sfere (N.6 Pezzi) tipo basso		
23X040	VOK	25,00			TRW Ford Focus '95 1° e 2° serie, crem. Ø25		
23X041	VOK	25,00			Kit idro Saginaw Ford Courier, crem. Ø25		
23X042	VOC	25,00			Kit idro Saginaw Ford KA, crem. Ø25		
23X043	VOK				kit settore Ford, Ford truck F100 250-350 '67/74 Mercury Explorer		
23X044	VOK	23,00			Kit idro Ford Mazda Protege '95/98, Mazda 323 '96, crem. Ø23		
23X045	VOK	25,00			Kit idro Ford Mazda 626, crem. Ø25		
23X046	VOK	25,00			kit idro Mazda '99, crem. Ø25		
23X047	VOK				Kit idro F Mercury '78/89, LTD, Lincoln Continental '82/88		
23X048	VOK				Kit idro F.Thunderbird '89/91,Truck, Aerostar '86/01, Mercury Cougar '89/91		
23X049	VOK	23,00			TRW Ford Mercury 1984-91,Tempo 1987-94, crem. Ø23		
23X050	VOK				kit idro Ford Mercury 77/79		
23X051	VOK	23,00			TRW Ford Mercury '87/91,Tempo '87/94		
23X052	VOK				kit idro Ford Lincoln, Mercury '75/77, Ford Truck '75/79		
23X053	VOK				kit idro Ford, Ford Gear ' 65/74, Ford Truck, F100, 250, 350, '67/74, Lincoln, continental, Mark III /IV '65/74 Mercury '65/74		
23X054	VOK				kit idro Ford Lincoln, Mercury '75/77, Ford camion '75/79		
23X055	VOK				kit idro Ford Truck Expedition serie E '92/98 Lincoln truck Navigator '98		
23X056	VOK				Kit idro Ford Ranger, Mazda serie B 98, Explorer '98/02		
23X057	VOK				Kit idro Mazda 929 Dohc '92/95		
23X058	VOK				Kit idro Mazda RX-7 '93/95		
23X059	VOK				Kit idro Mazda 929 DOHC '90/91		

VOK Kit idroguida Power steering kit Ремкомплект рулевого управления
VOC Kit cremagliera Rack kit Ремкомплект гидроцилиндра
VOD Kit distributore Pignon kit Ремкомплект распределителя
VOP Kit pompa Pump kit Ремкомплект насоса
OCD Cuffia destra Rack boot (right) Правый сайлентблок
OCS Cuffia sinistra Rack boot (left) Левый сайлентблок
OCX Cuffie sinistra+destra Rack boot (left+right) Набор сайлентблоков
OCC Kit cuffie Rack boot kit Ремкомплект сайлентблоков



Codice Code Код	Ref. Приме- нение	Ø crem. rack Ø	Ø distr. pinion Ø	Ø albero shaft Ø	Descrizione per utilizzo Use remarks Примечания	Cod. originale IDROGUIDA Оригинальный номер агрегата	Cod. originale KIT Оригинальный номер ремкомплекта
23X060	VOK				Kit idro M. Protege & MX3 1.6cc '92/94, Mazda 323 '89/94		
23X061	VOK				kit idro Ford Transit modifica speciale crem. (si riduce il Ø30 a mm. 29)		
23X062	VOK				Mazda MX5, Miata '1996-97, crem. Ø23		
23X063	VOK				kit idro Ford Playmouth, Mercury, Ford Truck		
23X064	VOK				kit idro Ford Mazda Pitman, Bronco, Ranger, Explorer		
23X065	VOK				kit idro Ford XR50, Expedition 97/99, Navigator '98/99, Mod. Ford F1 100/350 2WD 97/99		
23X066	VOK				Kit idro Ford Taurus, Sable '90/92		
23X067	VOK				kit idro Mazda B2.3.0, B3.0, B4.0 '94/97		
23X068	VOK				Kit idro Mazda 323 '88/89, Capri '91/94		
23X069	VOK				Kit idro Mazda 929 OHC '90/91		
23X070	VOK				kit idro Ford vari modelli		
23X071	VOC	30,00			kit idro TRW Ford Transit 2,0> crem. Ø30		
23X072	VOK				kit idro ZF Ford Scorpio, Sierra LHD, Granada	7831974106	7831/6
23X073	VOK				Kit idro Ford Windstar '98/00, Taurus '98/99		
23X074	VOK				Kit idro Mazda Millenia '95/97		
23X075	VOK	25,00			kit idro Ford Windstar Van, truck '95/97, crem. Ø25		
23X076	VOK				kit idro Ford Mustang '96/02 sedi rigate, grande		
23X077	VOK				kit idro Mazda Courier/B 2.0 Pickup 86/91-B2200-2600 91/95 RX7 84/85		
23X078	VOK				kit idro Dodge, Plymouth 62/72		
23X079	VOK				kit idro TRW Dodge Dakota '97/02		
23X080	VOK				kit idro Dodge, Monaco '90/91, Eagle, Premier '88/91		
23X081	VOK				kit idro Ford N40 Saginaw		
23X082	VOK				kit idro GMC		
23X083	VOK				Kit idro Lincoln '93/97, Mercury Cougar '96/97		
23X084	VOK				Kit idro F.Lincoln Continental '88/95		
23X085	VOK				Kit idro Ford vecchio modello AMC, Corvette '55 circa		
23X086	VOD				kit distributore Ford, XR50, Navigator, Ford F1 Model.100-350/2WD 97/99		
23X087	VOK				kit idro Ford E250, E350E, furgone		
23X088	VOK	31,00			kit idro Ford Explorer '98/02, Ranger 6CYL '01/02, crem. Ø31		
23X089	VOK				Kit idro Ford Cougar '99/02, Contour '98/00		
23X090	VOK				Kit idro Lincoln Continental '96/02		
23X091	VOK				kit idro Ford Taurus '00/02, Windstar '01/03		
23X092	VOK	22,00			Kit idro Ford Fiesta, Fusion dal 02, Mazda 2 '03, crem. Ø22		MCL
23X093	VOK	25,00			Kit idro Ford Focus '98/04, corp.crem. Ø25 Kit idro		
23X094	VOK	25,00			TRW Ford Mondeo U.T. 2.0, crem. Ø25		
23X095	VOK				kit idro Ford E250, 350 '96		
23X096	VOK				Kit idro Mazda MX3 1.8cc '92/95		
23X097	VOK				kit idro Lincoln SL '00/03		
23X098	VOK				Kit idro TRW Mazda 626 '98-99		
23X099	VOK				kit idro ZF Ford Taurus SHO '96/99		
23X100	VOK	25,00			Kit idro Mazda Protege '99, Mazda 323 '98, crem. Ø25		



Kit idroguida

Kits for power steering

Ремкомплекты для рулевого управления

Codice Code Код	Ref. Приме- нение	Ø crem.	Ø distr.	Ø albero	Descrizione per utilizzo Use remarks Примечания	Cod. originale IDROGUIDA Оригинальный номер агрегата	Cod. originale KIT Оригинальный номер ремкомплекта
		rack Ø	pinion Ø	shaft Ø			
		Размеры					
23X101	VOK				Kit idro Mazda MX5, Miata '99-00, crem. Ø23		
23X102	VOK				kit idro Ford Aspire 1994-'97		
23X103	VOD				kit pignone Ford Lincoln, Mercury		
23X104	VOK				Kit idro Mazda MPV '00/04,		
23X105	VOK				Kit idro Mazda Tribute '01/04, Ford Escape		
23X106	VOK				Kit idro Ford Expedition, Lincoln Navigator		
23X107	VOK				kit idro Mazda 6/626		
23X108	VOK	25,00			Kit idro Ford-Mazda 6, '03-04 crem. Ø25		
23X109	VOK	25,00			Kit idro Ford Mazda Protege 5 '02/03 crem. Ø25		
23X110	VOK	28,00			Kit idro Mazda MPV, 2wd E 4wd '96/98, crem. Ø28		
23X111	VOK	25,00			kit idro Ford Escape 2/4 door/porte '01/03 crem. Ø25		
23X112	VOD				Kit completo Distributore Ford Mod. "E"		
23X113	VOD				kit distributore Ford Mod. "E"		
23X114	VOK	26,00			Kit idro Mazda MPV Van 2000-'04, crem. Ø26		
23X115	VOK				Kit idro scatola mecc., F. Excursion '03/05 (11 splines)		
23X116	SCA				Kit idro scatola mecc., Excursion '03/05, (9 splines)		
23X117	VOK	25,00			Ford Lincoln, 2003-'07, crem. Ø25		
23X118	VOK	24,00			Ford Mazda 3 '06/07, crem. Ø24		
23X119	VOK	25,00			Ford Taurus 2003-'04, crem Ø25		
23X120	VOK	28,00			Ford Mustang 2005-'07, crem. Ø28		
• 23X121	VOK	25,00			Ford Cortina '80, Granada 1981-'85, crem Ø25		271547-2
• 23X122	VOK	28,00			Kit idro ford S-Max anno 2006, crem. Ø28		
• 23X123	VOK	25,00			TRW Ford Focus C-Max, crem. Ø25		
• 23X124	VOK	25,00			Ford Focus C-Max, Visteon, crem. Ø25		
• 23X125	VOK	25,00			Ford 500, Mercury Montego 2005-'07		
• 23X126		23,00			Kit idro Ford, anno 1998, crem. Ø23		
• 23X127		23,00			Kit idro Ford, anno 1988-'91, crem. Ø23		
• 23X128		23,00			Kit idro Ford, anno 1991-'98, crem. Ø23		
• 23X129	VOK				Kit idro Ford vari modelli, con paraolio dis. 0M Ø33,5		
• 23X130	VOK				Kit idro Ford vari modelli, 1980-'96		
• 23X131	VOK	30,00			kit idro TRW Ford Transit U.T, crem. Ø30		
23X601	VOP				kit Pompa Ford Granada		
23X602	VOP				kit Pompa Ford Lincon, Mercury e camion (truck)		
23X603	VOP				kit Pompa Ford Mercury, Topaz '91/94		
23X604	VOP			16,00	kit Pompa Ford Transit (Saginaw), albero Ø16		
23X605	VOP				kit Pompa Ford truck Expedition '77/78		
23X606	VOP				kit Pompa Ford Lincoln, Mercury e camion (truck)		
23X607	VOP				kit Pompa Mazda 323 '86/89		
23X608	VOP				kit Pompa Mazda 929 1988-89		
23X609	VOP				kit Pompa Mazda RX4		
23X610	VOP				kit Pompa Mazda RX7 '84/85		
23X611	VOP				kit Pompa Ford-Austin 1.8/2.2		
23X612	VOP				Kit pompa Ford Mondeo, KA, F.FiestaC III		
23X613	VOP				Kit pompa Mazda B2.0 '90/93, sunny '95		
23X614	VOP				kit Pompa Mazda 929 DOHC '90/91		
23X615	VOP				kit Pompa Ford camion, Mercury		
23X616	VOP				kit Pompa Ford Aspire '94/97, Escort '91/96, Mod. USA		

VOK Kit idroguida Power steering kit Ремкомплект рулевого управления
VOC Kit cremagliera Rack kit Ремкомплект гидроцилиндра
VOD Kit distributore Pignon kit Ремкомплект распределителя
VOP Kit pompa Pump kit Ремкомплект насоса
OCD Cuffia destra Rack boot (right) Правый сайлентблок
OCS Cuffia sinistra Rack boot (left) Левый сайлентблок
OCX Cuffie sinistra+destra Rack boot (left+right) Набор сайлентблоков
OCC Kit cuffie Rack boot kit Ремкомплект сайлентблоков



Codice Code Код	Ref. Приме- нение	Ø crem. rack Ø	Ø distr. pinion Ø	Ø albero shaft Ø	Descrizione per utilizzo Use remarks Примечания	Cod. originale IDROGUIDA Оригинальный номер агрегата	Cod. originale KIT Оригинальный номер ремкомплекта
23X617	VOP				kit Pompa Mazda 323 '86/89		
23X618	VOP				kit Pompa Mazda 626, MX6 '90/92		
23X619	VOP				kit Pompa Mazda 626 2.0, 2.51 '93/96		
23X620	VOP				kit Pompa Mazda RX7 '89/92		
23X621	VOP				kit Pompa Mazda B2600 '93/96		
23X622	VOP				kit Pompa Mazda 323 '89/95, Protege '90/95, MX3 '90/97		
23X623	VOP				kit Pompa Mazda Protege '99		
23X624	VOP				kit Pompa Mazda 626 4cyl '90/00, Protege' (01)		
23X625	VOP				Mercury Topaz 3.01 '92/94, Ford Taurus 3.01 (93-95)		
23X626	VOP				kit Pompa Mazda 929 Saloon OHC (90-91)		
23X627	VOP				kit Pompa Mazda, Miata, MX5 '96/97/99		
23X628	VOP				kit Pompa Mazda RX7 '84/85		
23X629	VOP			20,00	kit Pompa Ford Transit Hoborn Eaton '86/91, albero Ø20		
23X630	VOP				kit Pompa Ford		
• 23X631	VOP			18,00	kit Pompa Ford Taurus 2001-07, albero Ø18		
• 23X632	VOP			17,00	kit Pompa Ford Fusion 2.3L, 2006-'08, albero Ø17		
• 23X633	VOP			17,00	kit Pompa Ford Fusion 3.0L, 2006-'08, albero Ø17		
• 23X634	VOP			15,00	kit Pompa Ford Transit dal 2000 in poi, Hobbourn Eaton, doppio attacco, albero Ø15		
• 23X635	VOP			15,00	Kit pompa Kayaba Ford Transit 2.2 TDCi, doppio attacco		
23X701	OCS				cuffia crem. (TRW) manuale sx Ford Capri MKI '68/73 (burman), Escort '68/80		
23X702	OCD				cuffia crem. (TRW) manuale dx Ford Capri MKI 68-73 (burman), Escort '68/80		
23X703	OCD				cuffia crem. (TRW) manuale dx Ford Capri MKI 68-87 (cam), Cortina '70/82		
23X704	OCS				cuffia crem. (TRW) manuale sx Ford Capri MKI '68/87 (cam), Cortina 70/82		
23X705	OCS				cuffia crem. (TRW) manuale sx consul '72/77, Granada '72/79, Granada 2,5D, 2,8, 3.0, '77/85		
23X706	OCD				cuffia crem. (TRW) manuale dx consul 72/77, Granada '72/79, Granada 2.5D, 2,8, 3.0 '77/85		
23X707	OCD				cuffia crem. (TRW) manuale dx Escort '80/83, '86/88, Fiesta '76/89 Sapphire '87/93		
23X708	OCD				cuffia crem. (TRW) manuale dx Escort '80/83, '86/88, Fiesta '76/89		
23X709	OCX				cuffia crem. (TRW) manuale Escort '83/86/92, Fiesta '89/92		
23X710	OCX				cuffia crem. (TRW) idro Sierra 84/89, 1.6, 1.8, 2.0, 2.3		
23X711	OCX				cuffia crem.(TRW) idro Escort 92, Sapphire 85/93		
23X712	OCD				cuffia crem. (TRW) idro dx Granada 2.0, 2.1, 2,3 '79, Granada 2.5D, 2,8, 3.0 '77/85		
23X713	OCS				cuffia crem. Idro TRW sx Granada 2.0, 2.1, 2.3 '79, Granada 2.5D, 2,8, 3.0 '77/85		
23X714	OCX				cuffia crem. (TRW) idro Mondeo 1.6, 1,8, 2.0, 2.5 '93-		
23X715	OCX				cuffia crem. (TRW) idro Orion 83		
23X716	OCS				cuffia crem. (TRW) manuale sx Escort '70/80		
23X717	OCD				cuffia crem. (TRW) manuale dx Escort 70/80		



Kit idroguida

Kits for power steering

Ремкомплекты для рулевого управления

Codice Code Код	Ref. Приме- нение	Ø crem. rack Ø	Ø distr. pinion Ø	Ø albero shaft Ø	Descrizione per utilizzo Use remarks Примечания	Cod. originale IDROGUIDA Оригинальный номер агрегата	Cod. originale KIT Оригинальный номер ремкомплекта
23X718	OCD				cuffia crem. (TRW) manuale dx Escort '80/83		
23X719	OCS				cuffia crem. (TRW) manuale sx Escort '80/83		
23X720	OCX				cuffia crem. (TRW) manuale Escort '83/90		
23X721	OCX				cuffia crem. (TRW) manuale P100 '82/87		
23X722	OCX				cuffia crem. (TRW) manuale Transit '74-		
23X723	OCX				cuffia crem. idro Ford consul 2.0, 2.5, 3.0 '72/77 - Cortina - Taunus 72/82 - Granada '2/79		
23X724	OCX				cuffia crem. idro Ford Granada 3.0 V6 '72/79		
23X725	OCX				cuffia crem. idro Ford Granada 2/81 in poi - Mondeo		
23X726	OCX				cuffia crem. idro Ford Sapphire '94 in poi - Sierra 2,000/2800/2900 4X4 88/93		
23X727	OCX				cuffia crem. idro Ford Galxy '95>		
23X728	OCX				cuffia crem. idro Ford Escort '88 > (commerciale)		
23X729	OCX				cuffia crem. idro Ford Transit 86/00 (commerciale)		
23X730	OCX				cuffia crem. idro Ford Fiesta 8/95>		
23X731	OCX				cuffia crem. idro Ford Sierra 2.0, 2.8, 2.9, 4X4		
23X732	OCX				cuffia crem. idro Ford Escort 12/88 '91		
23X733	OCX				cuffia crem. idro Ford '95> Fiesta, Mondeo, KA		
23X734	OCX				cuffia crem. idro Mazda 626, 929 '82/87		
23X735	OCX				cuffia crem. idro Mazda 626, 929 '87> - Cronos - MS6 - MS8 -Eunos - Clef 10/89		
23X736	OCX				cuffia crem. idro Mazda 626, 929, Cronos, MS6, MS8, Eunos, Clef		
23X737	OCX				cuffia crem. idro Mazda 323 Familia 4WD 87>		
23X738	OCX				cuffia crem. idro Mazda 323 Familia		
23X739	OCX				cuffia crem. idro Mazda 323 Familia		
23X740	OCX				cuffia crem. idro Mazda 323		
23X741	OCX				kit cuffie crem. Idro TRW idro Granada 2,0, 2.1, 2.3 79 - Granada 2.5D, 2.8, 3.0, '77/85		
• 23X742	OCD				Cuffia idro termoplastico DX Transit 2.0 TDI dal 2000 in poi		
• 23X743	OCX				Cuffia idro termoplastico SX/DX Mazda MPV I 1996- '99		
• 23X744	OCX				Cuffia idro SX/DX termoplastico, Berlina Wagon 2002- '06		
• 23X745	OCX				Cuffia idro termoplastico SX/DX Mazda 121 II 1994- '95, Demio 1998-'99, SR1, SR2		
• 23X746	OCX				Cuffia idro termoplastico SX/DX Ford Mondeo Berlina 2000-'07, Maverik II		
• 23X747	OCX				Cuffia idro termoplastico SX/DX Ford Fiesta Berlina 1999-'01, Streetka dal 2003		
• 23X748	OCX				Cuffia idro termoplastico SX/DX Ford Transit Connect, Tourneo dal 2002 in poi		
• 23X749	OCX				Cuffia idro termoplastico SX/DX Ford Mazda 323 Berlina F/S DAL 1998-'00, 2001, F.Premacy 1999-'01		
• 23X750	OCX				Cuffia idro termoplastico SX/DX Ford Focus C-Max 2003-'07, F. Kuga dal 2008		
23X754	OCX				Cuffia idro SX/DX Ford Escort IV, Sierra, P100		
23X756	OCX				Cuffia idro SX/DX, Mazda 323, 626		
23X757	OCX				Cuffia idro SX/DX Mazda 626 1.8 '83-'87, Telstar		
• 23X762	OCX				Cuffia idro termoplastico SX/DX MAZDA 626 1.8 '83- '87, Telstar		

VOK Kit idroguida	Power steering kit	Ремкомплект рулевого управления	OCD Cuffia destra	Rack boot (right)	Правый сайлентблок
VOC Kit cremagliera	Rack kit	Ремкомплект гидроцилиндра	OCS Cuffia sinistra	Rack boot (left)	Левый сайлентблок
VOD Kit distributore	Pignon kit	Ремкомплект распределителя	OCX Cuffie sinistra+destra	Rack boot (left+right)	Набор сайлентблоков
VOP Kit pompa	Pump kit	Ремкомплект насоса	OCC Kit cuffie	Rack boot kit	Ремкомплект сайлентблоков



Codice Code Код	Ref. Применение	Ø crem. rack Ø	Ø distr. pinion Ø	Ø albero shaft Ø	Descrizione per utilizzo Use remarks Примечания	Cod. originale IDROGUIDA Оригинальный номер агрегата	Cod. originale KIT Оригинальный номер ремкомплекта
		Dimensioni					
23X763	OCC				cuffia Ford - Mazda		
23X764	OCC				cuffia Ford - Mazda		
23X765	OCC				cuffia Ford - Mazda		
23X766	OCC				cuffia Ford - Mazda		
23X767	OCC				cuffia Ford - Mazda		
23X768	OCC				cuffia Ford - Mazda		
23X769	OCC				cuffia Ford - Mazda		
23X770	OCC				cuffia Ford - Mazda		
23X771	OCC				cuffia Ford - Mazda		
23X773	OCX				cuffia idro termoplastico SX/DX Ford , Scorpio II		
23X777	OCX				cuffia idro termoplastico SX/DX Fiesta Berlina, Ford Fusion, dal 2002 in poi		
23X778	OCX				cuffia idro termoplastico SX/DX Ford Focus 1998-'05, Sierra 1990-'93		
• 23X779	OCX				Cuffia idro termoplastico SX/DX Ford S-Max dal 2006		
• 23X810					Pompa elettrica TRW Ford Focus-C Max 2003, Focus II	OE 4M513K514CC	
• 23X811					Pompa elettrica TRW Ford Galaxy 2006 2,0 tdc, Ford C Max 2,0 tdc	OE 6G913K514AL	
• 23X812					Pompa elettrica HPI Ford Fiesta, Fiesta IV, Courier	OE YS613K514BF	
• 23X813					Pompa elettrica TRW Ford	OE 5N513K514CB-31280369	
• 23X814					Pompa elettrica TRW Ford Focus II, 2.5 ST	OE 6M5Y3K514CC 1475137-1430017-1370305	
• 23X815					Pompa elettrica TRW Ford Focus C-Max / Focus 2 TDCI	4M513K514DA	
23X902					Scatola meccanica Ford Transit tipo corto (40 mm)		
23X903					Scatola meccanica Ford Transit tipo medio (230 mm)		
23X904					Scatola meccanica Ford Transit tipo lungo (1.050 mm)		
• 23X907					Kit di riparazione scatola Ford Transit		

Aste di ricambio

Spare rods
Рабочие детали



ATTENZIONE! Per effettuare una corretta revisione, è necessario sostituire anche il cuscinetto (cod. **H-07505**, pag. 126).

WARNING! In order to perform a correct overhaul, you should also substitute the bearing (code **H-07505**, page 126).

Codice Code Код	L	Versione Version Вариант исполнения	Descrizione per utilizzo Use remarks Примечания
	Размер		
23X906	100,00	Corta Short	Ford Transit ultimo tipo
23X901	230,00	Intermedia Intermediate	Ford Transit - in acciaio
23X900	1050,00	Lunga Long	Ford Transit con cuscinetto - in acciaio



Kit idroguida

Kits for power steering

Ремкомплекты для рулевого управления

Holden

59X

Codice Code Код	Ref. Приме- нение	Ø crem. rack Ø	Ø distr. pinion Ø	Ø albero shaft Ø	Descrizione per utilizzo Use remarks Примечания	Cod. originale IDROGUIDA Оригинальный номер агрегата	Cod. originale KIT Оригинальный номер ремкомплекта
		Размеры					
59X001	VOK				Kit idro Holden Commodore '88/89		VS18202
59X002	VOK				Kit idro Holden Commodore '86/88		VS17274
59X003	VOK				Kit idro Holden Commodore '89/91		
59X004	VOK				Kit idro Holden V '93		
59X005	VOK				Kit idro Holden Commodore (variomatic)		
59X006	VOK				Kit idro Holden Commodore (variatic)		
59X007	VOK				Kit idro Holden VP '91/93		
59X008	VOK	28,00			Kit idro Holden Commodor, Statesman '97/99		
59X009	VOK				Kit idro scatola a settore Holden		
59X701	OCX				cuffie cremagliera idro Astra		
59X702	OCX				cuffie cremagliera idro Commodore		
59X703	OCX				cuffie cremagliera idro Commodore VL, VN		
59X704	OCD				cuffie cremagliera idro dx Torana		
59X705	OCS				cuffie cremagliera idro sx Torana		
59X706	OCX				cuffie cremagliera idro Camira JB, JE		
59X710	OCC				cuffie crem. idro Astra idro dx/sx Torana (completo)		
59X752	OCX				cuffia man sx/dx Commodore		
59X753	OCD				cuffia man dx Torana		
59X754	OCS				cuffia man sx Torana		
59X755	OCD				cuffia man dx Camira JB, JE		
59X756	OCS				cuffia man sx Camira JB, JE		
59X757	OCC				Kit cuffie cremagliera idro Astraman Torana		
59X758	OCC				Kit cuffie cremagliera idro Astraman Camira JB-JE		

Honda

25X

Codice Code Код	Ref. Приме- нение	Ø crem. rack Ø	Ø distr. pinion Ø	Ø albero shaft Ø	Descrizione per utilizzo Use remarks Примечания	Cod. originale IDROGUIDA Оригинальный номер агрегата	Cod. originale KIT Оригинальный номер ремкомплекта
		Размеры					
25X001	VOK				Kit idro Honda Civic '84-87, CRX 86-87		065A3SB3415
25X002	VOK				Kit idro Honda accord '90		065A3SM4425
25X003	VOK				Kit idro Honda Civic, Integra-Concerto '88-91		065A3SH3425
25X004	VOK				Kit idro Honda Prelude '83-87, Accord '82-85		53016SA5670
25X005	VOK				Kit idro Honda Accord '84-85, Prelude '83-87		
25X006	VOK				Kit idro Honda Accord-Ballade '86-87		065A3SE0415
25X007	VOK				Kit idro Honda accord '88/89		065A3SE0515
25X008	VOD				Kit distrib. Honda Integra '86-90, Civic 84-87, CRX 86-87		065B3SD2405
25X009	VOD				Kit distrib. Honda Prelude '87-90, Legend '86-90		
25X010	VOD				Kit distrib. Honda accord, Prelude Legend '86/90		065B3SE0405
25X011	VOD				Kit distrib. Honda Accord '84-85, Prelude '83-87		
25X012	VOD				Honda Civic '88-90, Integra '90, Concerto '88-90		065B3SH3405
25X013	VOD				Kit distrib. Honda Accord '90-93-99		
25X014	VOK				Kit idro Honda Legend '88/91		XHM5921
25X015	VOK				Kit idro Honda Civic 88-91, Prelude 88-90, Acura, Legend '86-90		
25X016	VOK				Kit idro Honda Prelude '92-96, Accord '90-93		
25X017	VOK				Kit idro Honda Accord 86-89, Civic 84-87, Integra 86-89		

VOK Kit idroguida *Power steering kit Ремкомплект рулевого управления* **OCD** Cuffia destra *Rack boot (right) Правый сайлентблок*
VOC Kit cremagliera *Rack kit Ремкомплект гидроцилиндра* **OCS** Cuffia sinistra *Rack boot (left) Левый сайлентблок*
VOD Kit distributore *Pignon kit Ремкомплект распределителя* **OCX** Cuffie sinistra+destra *Rack boot (left+right) Набор сайлентблоков*
VOP Kit pompa *Pump kit Ремкомплект насоса* **OCC** Kit cuffie *Rack boot kit Ремкомплект сайлентблоков*



Codice Code Код	Ref. Приме- нение	Ø crem. rack Ø	Ø distr. pinion Ø	Ø albero shaft Ø	Descrizione per utilizzo Use remarks Примечания	Cod. originale IDROGUIDA Оригинальный номер агрегата	Cod. originale KIT Оригинальный номер ремкомплекта
25X018	VOK				Kit idro Honda Legend '91-94, Acura		
25X019	VOK				Kit idro Honda Prelude 4 ruote motrici '89-99		
25X020	VOK				Kit idro Honda Prelude 81-82, Accord 78-81		
25X021	VOK	24,00			Kit idro Honda Civic '92-95, del sol '93-95, crem. Ø24		06532SR3A50
25X022	VOK				Kit idro Honda CRV '97, Accord 95-97, Odyssey 95-97		
25X023	VOK				Kit idro Honda Prelude '97-98		
25X024	VOK				Kit idro Honda Acura Vigor '92-94		
25X025	VOK	24,00			Kit idro TRW Honda Civic tutti i modelli dal '98-00		
25X026	VOK				Kit idro Honda Accord '90-93		
25X027	VOK	24,00			Kit idro Honda Acura Integra 94-97, Honda del sol 96-97, Civic 2/4 dr 96-97		
25X028	VOK				Kit idro Honda Prelude '99-01		
25X029	VOK				Kit idro Honda Acura Integra 3d/4d '90-93		
25X030	VOK				kit idro Honda Acura RL 3.5-TL 3.2 96/98		
25X031	VOK	24,00			Honda Acura TZ 5.5i '95-98, crem. Ø24		
25X032	VOK	27,00			Honda Passport '98-99, crem. Ø27		
25X033	VOK	24,00			Kit idro CRV '02/06, Acura RSX-S 02/03 Element		
25X034	VOK				Kit idro Honda Acura RSX/RXS, L '02/03		
25X035	VOK	26,00			Honda Accord V6 '98/02, crem. Ø26		
25X036	VOK				Kit idro Honda Odyssey '99-04		
25X037	VOK	24,00			Kit idro Honda Civic '01/05		
25X038	VOK				Honda Acura TL '99-02		
25X039	VOK				Honda Acura C '01-02, TL '02		
25X040	VOK	26,00			Acura MDX 5DR 801, Pilot '03/05, crem. Ø26		
25X041	VOK	23,00			Kit idro Honda Civic Es8 '91/9, crem. Ø23		
25X042	VOK	24,00			Kit idro Honda CR-V-V6 '98/00, Accord 98-01, Odyssey 98 - crem. Ø24		
25X043	VOK	24,00			Kit idro Honda Acura TSX '04, crem. Ø24		
25X044	VOK	25,00			Kit idro Honda Accord 1° serie '96-99, crem. Ø25		
25X045	VOK	24,00			Kit idro Honda Civic 2006/07, crem. Ø24		
25X046	VOK	24,00			Honda Accord V6 '03/05, crem. Ø24		
25X601	VOP				kit pompa Honda Accord '90-'94		
25X602	VOP				kit pompa Honda Accord '90-92		
25X603	VOP				kit pompa Honda Accord Prelude '79-'81		
25X604	VOP				kit pompa Honda Accord '82/83 Prelude '82-'88		
25X605	VOP				kit pompa Honda Acura Legend		
25X606	VOP				kit pompa Honda Civic '84-'87 (pompa immersa)		
25X607	VOP				kit pompa Honda Civic '89-'91		
25X608	VOP				kit pompa Honda Legend 86/90-Accord '86-'89		
25X609	VOP				kit pompa Honda Concerto		
25X610	VOP				kit pompa Acura RL (96-02)		
25X611	VOP				kit pompa Honda Passport (99)		
25X612	VOP				kit pompa Acura CL (00-02)/TL (99-02)/Honda ODISSEY (99-02)/Accord 2dr V6 (98)		
25X613	VOP				kit pompa Honda Civic 4dr (98-00)/CR-V (97-01)		
25X614	VOP				kit pompa Honda Civic 2/4 DOOR ('01-'02)		
25X615	VOP				Kit pompa Honda Acura MDX V6 2005-06		
25X616	VOP				Kit pompa Honda Civic 2003-05		



Kit idroguida

Kits for power steering

Ремкомплекты для рулевого управления

Codice Code Код	Ref. Приме- нение	Ø crem. rack Ø	Ø distr. pinion Ø	Ø albero shaft Ø	Descrizione per utilizzo Use remarks Примечания	Cod. originale IDROGUIDA Оригинальный номер агрегата	Cod. originale KIT Оригинальный номер ремкомплекта
		Размеры					
25X701	OCX				cuffia Cremagliera (TRW) idro Honda Accord 81- 89/ BALLADE 83-87 / Civic 83-91 / INTEGRA 89- / Legend 85- / Prelude 82-87/VIGOR 81-Quint Integra 85/89 - Concerto 6/88 - City 11/96		
25X702	OCX				cuffia crem. idro Honda Accord 76/78- Prelude 78/81- Quint 80/85-Ballade 80/83-Civic 80/83		
25X703	OCX				cuffia Cremagliera idro Honda Accord 9/93 - NEW		
• 25X704	OCX				Cuffia idro termoplastico SX Honda Logo 1999 in poi		
• 25X705	OCX				Cuffia idro termoplastico DX Honda Logo 1999 in poi		
• 25X706	OCD				Cuffia idro termoplastico DX Honda HR-V 1999-'05, in poi		
• 25X707	OCS				Cuffia idro termoplastico SX Honda HR-V 1999-'05, in poi		
• 25X708	OCX				Cuffia idro termoplastico SX/DX Honda City dal 2005		
• 25X709	OCD				Cuffia idro termoplastico DX Honda Civic berlina 3/5 pt,dal 2005		
• 25X710	OCS				Cuffia idro termoplastico SX Honda Civic berlina 3/5 pt,dal 2005		
25X752	OCX				cuffia manuale Sx/Dx Honda Accord		
25X753	OCX				cuffia manuale Sx/Dx Honda Accord		
25X754	OCX				cuffia Sx/Dx Honda Prelud		
25X755	OCX				Honda		
25X756	OCX				Honda		
25X757	OCX				Cuffia idro Honda Acty 1979-'86		
25X758	OCX				Cuffia idro SX/DX Honda Civic, Ballade,1983-'90		
• 25X759	OCX				cuffia idro SX/DX Honda Accord, Vigor		
• 25X760	OCS				cuffia idro SX Honda CR-V e Integra, Shuttle DX		
• 25X761	OCS				cuffia idro SX Honda Ballade, Civic		
• 25X762	OCX				cuffia idro termoplastico SX/DX Honda Accord, Vigor		

Hyundai

26X

Codice Code Код	Ref. Приме- нение	Ø crem. rack Ø	Ø distr. pinion Ø	Ø albero shaft Ø	Descrizione per utilizzo Use remarks Примечания	Cod. originale IDROGUIDA Оригинальный номер агрегата	Cod. originale KIT Оригинальный номер ремкомплекта
		Размеры					
26X001	VOK	24,00			kit idro Lantra Mod. Mando cil.1,8, crem.Ø24		
26X002	VOK	24,00			kit idro Accent '95/04, crem. Ø24		
26X003	VOK	24,00			kit idro Pony '86/89 - Lantra, crem. Ø24		
26X004	VOK				kit idro Sonata '86/91		
26X005	VOK				kit idro Pony 1.5CC TRW		
26X006	VOK	22,00			kit idro Atos, crem. Ø22		
26X007	VOK	24,00			kit idro Elantra '96/00,Tiburon 97-01, crem. Ø24		
26X008	VOK				kit idro Sonata '94/98		
26X009	VOK	27,70			kit idro Smi-Koyo Sonata '99/03, XG350 '02-04		
26X010	VOK	26,00			kit idro Lantra, Elantra '01/04, crem. Ø26 Mando		
26X011	VOK	24,00			kit idro Lantra '93/95 1.6, L.'91/95 1.8L. crem. Ø24		
26X012	VOK	22,00			kit idro Atos '01, crem Ø22		
26X013	VOK	27,70			kit idro KOYO/SMI - alleggerito Santa Fe		
26X014	VOK	27,70			Kit idro KOYO/SMI - Sonata '06/07		KOYO
• 26X015		27,70			Hyundai Santa Fe, crem. Ø27,7		
• 26X016	VOK	26,00			Hyundai Tiburon 2003-07, crem. Ø26 U.T.		

VOK Kit idroguida Power steering kit Ремкомплект рулевого управления
VOC Kit cremagliera Rack kit Ремкомплект гидроцилиндра
VOD Kit distributore Pignon kit Ремкомплект распределителя
VOP Kit pompa Pump kit Ремкомплект насоса
 OCD Cuffia destra Rack boot (right) Правый сайлентблок
 OCS Cuffia sinistra Rack boot (left) Левый сайлентблок
 OCX Cuffie sinistra+destra Rack boot (left+right) Набор сайлентблоков
 OCC Kit cuffie Rack boot kit Ремкомплект сайлентблоков



Codice Code Код	Ref. Приме- нение	Ø crem. rack Ø	Ø distr. pinion Ø	Ø albero shaft Ø	Descrizione per utilizzo Use remarks Примечания	Cod. originale IDROGUIDA Оригинальный номер агрегата	Cod. originale KIT Оригинальный номер ремкомплекта
		Размеры					
26X601	VOP				kit pompa accent'95/02, Alantra '95/03, Sonata '94/98		
26X602	VOP				pompa Excel '90/93		
26X603	VOP			17,00	kit pompa Hyundai Tucson, albero Ø17		
26X701	OCX				cuffia crem. idro Dx/Sx Excel Pony		
• 26X702	OCX				cuffia idro termoplastico DX/SX Hyundai H100-H150-H200, Satellite		
• 26X703	OCX				cuffia idro termoplastico DX/SX Hyundai Coupè		
• 26X704	OCX				cuffia idro termoplastico DX/SX Hyundai Getz 2002, Accent 2006, Matrix 2007		
• 26X705	OCX				cuffia idro termoplastico DX/SX Hyundai Matrix 2001-'07		
• 26X706	OCX				cuffia idro termoplastico DX/SX Hyundai Tucson dal 2004		
• 26X707	OCX				cuffia idro termoplastico DX/SX Hyundai Sonata V dal 2004, Sonica dal 2005		

Isuzu

27X

Codice Code Код	Ref. Приме- нение	Ø crem. rack Ø	Ø distr. pinion Ø	Ø albero shaft Ø	Descrizione per utilizzo Use remarks Примечания	Cod. originale IDROGUIDA Оригинальный номер агрегата	Cod. originale KIT Оригинальный номер ремкомплекта
		Размеры					
27X001	VOK				Kit idro Isuzu Piazza turbo '85/89, Impulse, I Mark 83- 90		
27X002	VOK				Kit idro Isuzu Trooper		
27X003	VOK	27,00			Kit idro Isuzu Rodeo, Passport '98/99, crem. Ø27		
27X004	VOK				Kit idro Isuzu Trooper '00/01, Vvehicross '99/01		
27X005	VOK				Kit idro Isuzu Trooper '86/95, Amigo '89/95, Rodeo '91/97, Pickup '88-95		
27X006	VOK				Kit idro Isuzu Impulse '90/92		
• 27X007	VOK	27,00			Isuzu Rodeo '01-'03, Rodeo Sport , Axiom '02-'04, crem. Ø27		
• 27X008	VOK	27,00			Isuzu Rodeo '00, Isuzu Amigo1998-'00, crem. Ø27		
• 27X009	VOD				Kit idro Isuzu 4.8 L		
27X601	VOP				kit pompa Isuzu NPR '87-91		
27X602	VOP				kit pompa Isuzu Impulse '90/92		
27X603	VOP				kit pompa Isuzu Rodeo, Amigo, Sport '98/00		
27X604	VOP				kit pompa Isuzu Rodeo '91/97, Amigo '89/94		
27X605	VOP				kit pompa Isuzu Trooper		
27X606	VOP				kit pompa Isuzu Trooper 2,8 TD 1987-1991		
27X701	OCX				cuffia cremagliera idro Aska 6/90>		

Jaguar

28X

Codice Code Код	Ref. Приме- нение	Ø crem. rack Ø	Ø distr. pinion Ø	Ø albero shaft Ø	Descrizione per utilizzo Use remarks Примечания	Cod. originale IDROGUIDA Оригинальный номер агрегата	Cod. originale KIT Оригинальный номер ремкомплекта
		Размеры					
28X001	VOK	28,00			ZF - Jaguar XJ40 , '86-90, crem. Ø28	7852974288	7852/009
28X002	VOK	28,00			ZF - Jaguar XJS , crem. Ø28	7852955272	7852/011
28X003	VOK	28,00			Kit idro ZF Jaguar JX40 93, crem. Ø28	7852974230, 233	7852/019
28X004	VOK	28,00			Kit idro ZF Jaguar JX40 93-95, crem. Ø28	7852991135	7852/024
28X005	VOK	28,50			Kit idro Jaguar XJ6 & J12 '78/83, crem. Ø28,5		



Kit idroguida

Kits for power steering

Ремкомплекты для рулевого управления

Codice Code Код	Ref. Приме- нение	Ø crem. rack Ø	Ø distr. pinion Ø	Ø albero shaft Ø	Descrizione per utilizzo Use remarks Примечания	Cod. originale IDROGUIDA Оригинальный номер агрегата	Cod. originale KIT Оригинальный номер ремкомплекта
28X006	VOK	28,50			Jaguar XJ6 3°serie pign. corto Ø28,5, crem. Ø28,5		
28X007	VOK	28,50			Kit idro Jaguar XJ6 1°serie (Adwest)pign.lungo Ø28,5, crem. Ø28,5		
28X008	VOK				Kit idro Jaguar XJ6 serie3, XJ12 serie 2 (Adwest) 1983,pignone corto Ø28		
28X009	VOK	29,00			Kit idro XJ6-XJ12 1978 serie 1e2, (pig.lungo Ø29), crem. Ø29,00		
28X010	VOK	28,50			Kit idro tipo E '68/74 Ø29,5 cil.4200, crem. Ø28,5		
28X011	VOK	28,00			Kit idro Jaguar XJ6 83 & XJ12 81-87 1,2,3 ser,con ptfе Ø28,5XJ5, crem. Ø28		
28X012	VOK	30,00			Kit idro J.XJ40 86 con P.T.FE Ø20-Ø23/ Ø30-Ø32,5,XJ6 88-94		
• 28X012 Light					allegg. Jaguar XJ40		
28X013	VOK				Kit idro ZF Jaguar	8052955150 8052955170	8052/013
28X014	VOK	30,00			Kit idro Jaguar XJ40 Late, crem. Ø30		
28X015	VOK				Jaguar XK8 "99-02	7852993151, 7852993442	7852/043
28X016	VOK	28,00			ZF - Jaguar servotronic, crem. Ø28		7852/046
28X017	VOK				Z F- JaguarCS TYPE "00-02, Lincoln LS "00-03		
28X018	VOK				ZF - Jaguar servoitronic "00,X TYPE "01	7831993106, 7831993112	7831/502
28X019	VOK				ZF - Jaguar S Type X201	7852991135	7852/522
28X020	VOK	28,00			ZF - Jaguar XK8 "99-02, XJ 97, crem. Ø28	7852993151, 7852993442	7852/52
28X021	VOK				ZF - Jaguar S Type X202, "99-02, XJ 97	7852993575	7852/534
28X601	VOP				Jaguar XJ40		
28X602	VOP				Jaguar XJ6-XJ12-XJ5 "85-88, XJS		
28X603	VOP				Jaguar SMK II		
28X604	VOP				Jaguar	8052955150	
28X605	VOP			19,05	Jaguar XJ6 3,2/4,0 "94-97, albero Ø19,05		
28X701	OCX				cuffie Jaguar XJ40		
28X702	OCX				cuffie Jaguar ZF XJ40		
28X703	OCX				cuffia SX/DX Jaguar XJ40 9/85		
• 28X704	OCX				cuffia idro termoplastico SX/DX, S-Type 2002-'05, XJ 2003-'04		
• 28X705	OCX				cuffia idro termoplastico SX/DX, S-Type 2001-'02		
• 28X706	OCX				cuffia idro termoplastico SX/DX, S-Type 1999-'00		
• 28X707	OCX				cuffia idro termoplastico SX/DX, X-Type Berlina/Wagon/ Estate 2001-'04		

Jeep - Pontiac - Chevrolet

15X

Codice Code Код	Ref. Приме- нение	Ø crem. rack Ø	Ø distr. pinion Ø	Ø albero shaft Ø	Descrizione per utilizzo Use remarks Примечания	Cod. originale IDROGUIDA Оригинальный номер агрегата	Cod. originale KIT Оригинальный номер ремкомплекта
15X001	VOD			32,00	a settore - Chevrolet, Oldsmobile, Pontiac "82/84, albero Ø32		
15X002	VOK	25,00			Chevrolet, Corvette "84/87, crem. Ø25		
15X003	VOK				BOX Chrysler, Dodge"78/92, Truck, Dodge 58/90, Playmount camion "74/87		
15X004	VOD			32,00	a settore - Jeep AMC, Chevrolet, Ford "78/92, Jeep 79/92, Gran Cherokee, albero Ø32		

VOK Kit idroguida Power steering kit Ремкомплект рулевого управления
VOC Kit cremagliera Rack kit Ремкомплект гидроцилиндра
VOD Kit distributore Pignon kit Ремкомплект распределителя
VOP Kit pompa Pump kit Ремкомплект насоса
 OCD Cuffia destra Rack boot (right) Правый сайлентблок
 OCS Cuffia sinistra Rack boot (left) Левый сайлентблок
 OCX Cuffie sinistra+destra Rack boot (left+right) Набор сайлентблоков
 OCC Kit cuffie Rack boot kit Ремкомплект сайлентблоков



Codice Code Код	Ref. Приме- нение	Ø crem. rack Ø	Ø distr. pinion Ø	Ø albero shaft Ø	Descrizione per utilizzo Use remarks Примечания	Cod. originale IDROGUIDA Оригинальный номер агрегата	Cod. originale KIT Оригинальный номер ремкомплекта
15X005	VOK	23,00			AMC, Renault Alliance "83/88, crem. Ø23		
15X006	VOK	25,00			TRW - Chrysler "86/95, Dodge, Caravelle, Truck, camion"84/91, crem.Ø25		
15X007	VOK	25,00			Buick, Chevrolet, Pontiac "84-90, crem. Ø25		
15X008	VOD			32,00	Chevrolet, Camarro, Pontiac, Firebird "88/92, albero Ø32		
15X009	VOK	25,00			TRW - Chrysler, Dodge, Plymouth " 84/91, 300M, Neon, crem. Ø25		
15X010	VOK	25,00			Saginaw - Jeep AMC, Chevrolet, Camarro, Pontiac-Firebird, crem. Ø25		
15X011	VOK	25,00			Chevrolet Buick, Electra"85/91, Citatio, Cadillac, Celebrity, crem. Ø25		
15X012	VOK	25,00			Chevrolet "81/84, Cadillac, Oldsmobile"82/91, crem. Ø25		
15X013	VOK	25,00			Chevrolet, Celebrity, Cadillac Allante "87/92, Pontiac 83/85, crem. Ø25		
15X014	VOK	25,00			Chevrolet, Corvette "89/91, "84/96, crem. Ø25		
15X015	VOK			14,00	Chevrolet, Cadillac, Oldsmobile, Pontiac, Beretta 87/89, Daewo Espero"91/95, Saab 900 "98/02, albero Ø14		
15X016	VOK	25,00			Chevrolet Truck, Electra "92/96, Venture, crem.25, crem. Ø25		
15X017	VOK				Buick, Chevrolet, Oldsmobile, Pontiac "84		
15X018	VOK				Saginaw - Jeep, Chrysler type II large" 79/85/Cherokee		
15X019	VOK				Saginaw - Jeep, Chrysler large Gear "61/77, Cherokee		
15X020	VOK				Saginaw - Jeep, Chrysler Arcsmallgear"60-75-Cherokee a settore - Jeep Truck "97/99, Cherokee cc 4200, Gran Cherokee, albero Ø32		
15X021	VOK			32,00	Chrysler Voyager, Dodge Caravan "00/02		
15X022	VOK	25,00			Dodge, Plymouth		
15X023	VOK				Chrysler, Dodge, Truck		
15X024	VOK				Chevrolet Camaro, Lumina, Van "93/97, Omega		
15X025	VOK				Chrysler Concord, Dodge, Intrepid,"93/97, LHS		
15X026	VOK				Saginaw - Chrysler classe E83-86, Dodge, Caravelle, Plymouth.		
15X027	VOK				Cadillac, Alente, Eldorado, Deville, Fleetwood "94/98, Seville 91/97		
15X028	VOK				ChryslerL 300M, Hbody 98/00 , Concord, LHS		
15X029	VOK				Buick, Cadillac, Chevrolet, Pontiac "82/84		
15X030	VOK				Chevrolet, Pontiac, Chevette "84/87, T1000 "81/83		
15X031	VOK				Buick 77/81, Chevrolet, Oldsmobile "77/84, GMC, Truck "77/84, Pontiac "77/83		
15X032	VOK				Chevrolet, GMC, Truck, Aerodesign "88/92		
15X033	VOK				Cadillac, Allante "93, Eldorado, Seville "93/95		
15X034	VOK				Chevrolet, Silverado "99/00		
15X035	VOD			32,00	Jeep vari modelli, albero Ø32		
15X036	VOK				Chevrolet 605 Saginaw, Pontiac		
15X037	VOD			32,00	Saginaw - Kit Idro completo distributore Jeep "88/92, albero Ø32		
15X038	VOD			41,00	Saginaw - mod.710 doppio pistone' 83on		
15X039	VOK				Buick Skylark "94/98, Achieva		
15X040	VOD			32,00	Saginaw - Jeep, biella inf., albero Ø32		



Kit idroguida

Kits for power steering

Ремкомплекты для рулевого управления

Codice Code Код	Ref. Приме- нение	Ø crem. rack Ø	Ø distr. pinion Ø	Ø albero shaft Ø	Descrizione per utilizzo Use remarks Примечания	Cod. originale IDROGUIDA Оригинальный номер агрегата	Cod. originale KIT Оригинальный номер ремкомплекта
15X042	VOK	25,00			Pontiac grandprix "01/07, crem. Ø25		
15X043	VOK				Dodge D50		
15X044	VOK				Chevrolet Camaro 38mm, Pontiac Firebird "00/03		
15X045	VOK	32,00			Dodge RAM "02/05 serie1500, crem.Ø32		
15X046	VOK	24,00			Pontiac Vibe '03, crem. Ø24		
15X048	VOK	32,00			Dodge Durango 4WD '00/02, Dakota, crem.Ø32		
15X049	VOK				Chrysler neon (00)PT, Cruiser '00/03		
15X050	VOK				Pontiac Grand Ami '92/98		
15X051	VOD			32,00	Chevrolet, GMC, Silverado, GranCherokee		
15X052	VOD				Saginaw - Jeep "88/92, Cherokee		
15X053	VOD			32,00	Cherokee, pignone Ø32		
15X054	VOD		20,00		Saginaw - serie 700/800		
15X055	VOK				a settore - Chevrolet/Chimera '97		
15X056	VOD			32,00	Saginaw - 708, Gran Cherokee, Dodge Ram2005-3500, albero Ø32		
15X057	VOK	32,00			Jeep Cherokee, Liberty, Voyager, '02/05		
15X058	VOK	30,00			Jeep Grand Cherokee "05/06, crem.Ø30		
15X059	VOK	25,00			Chevrolet "04/05, Pontiac, Oldsmobile, crem. Ø25		
15X060	VOK	28,00			Pontiac GTO "04, crem. Ø28		
15X061	VOK	28,00			Chrysler 300C, Dodge "05/07, crem. Ø28		
15X062	VOD				a settore - Chevrolet, GMC" 99/06		
15X063	VOK				a settore - Jeep Wrangler "03/05		
15X064	VOK	30,00			Chevrolet Silverado, GMC Sierra 99/06, crem.Ø30		
15X065	VOK	27,00			Chevrolet Colorado 2WD "04/05, crem. Ø27		
15X066	VOD			32,00	Jeep GMC, '99/06, albero Ø32		
15X067	VOK	30,00			Jeep Liberty V63, 7L2006, crem.Ø30		
15X068	VOK	25,00			Chevrolet Malibu, Pontiac, Saturn, 2006-'07		
15X069	VOK	28,00			Cadillac Ccts "03/04, crem. Ø28		
15X070	VOK	32,00			Dodge, RAM "04-05, (30mm rackbar), crem.Ø32		
15X071	VOD				Saginaw - Chevrolet, modello 710 (diregolazione)		
15X072	VOK	25,00			Dodge Neon '04, crem. Ø25		
15X073	VOK	26,00			Chrysler Sebring 2.4L, '01/04, crem. Ø26		
15X074	VOK	25,00			Cadillac SRX "04/07, crem. Ø25		
15X075	VOK	25,00			Chrysler Town & Country, Dodge Caravan "08		
• 15X076	VOD				Kit idro a settore Jeep Wrangler fino al 2003, un paraolio dis. 1PM Øi 21 e l'altro Øi 32		
• 15X077	VOK	32,00			Dodge Dakota 2005-07, crem. Ø32		
• 15X078	VOK	25,00			Dodge Caliber, Jeep Patriot-Compass, 2007-'08, crem. Ø25		
• 15X079	VOK	25,00			Chrysler Pacifica, anno 2004/06, crem. Ø25		
• 15X080	VOK			32,00	Kit idro a settore GMC & Chevrolet, 4 BOLT,albero Ø32		
15X601	VOP				Buick, Cadillac, Chevrolet (vane type large)		
15X602	VOP				Buick, Cadillac, Chevrolet '94/96		
15X603	VOP				Buick, Cadillac, Plymouth		
15X604	VOP				Buick, Chevrolet, Oldsmobile, Pontiac		
15X605	VOP			18,00	Buick, Chevrolet, Oldsmobile, Pontiac, alberoØ18		
15X606	VOP				Buick, Oldsmobile "92/98		
15X607	VOP			19,05	Pontiac "00/05, Buick "00/03, albero Ø19,5		
15X608	VOP				Chevrolet, Corvette		
15X609	VOP			19,05	Jeep, Chrysler, Cherokee, albero Ø19,5		
15X610	VOP				Chevrolet, Pontiac, Transam "93/97		

VOK Kit idroguida Power steering kit Ремкомплект рулевого управления
VOC Kit cremagliera Rack kit Ремкомплект гидроцилиндра
VOD Kit distributore Pignon kit Ремкомплект распределителя
VOP Kit pompa Pump kit Ремкомплект насоса
OCD Cuffia destra Rack boot (right) Правый сайлентблок
OCS Cuffia sinistra Rack boot (left) Левый сайлентблок
OCX Cuffie sinistra+destra Rack boot (left+right) Набор сайлентблоков
OCC Kit cuffie Rack boot kit Ремкомплект сайлентблоков



Codice Code Код	Ref. Приме- нение	Ø crem. rack Ø	Ø distr. pinion Ø	Ø albero shaft Ø	Descrizione per utilizzo Use remarks Примечания	Cod. originale IDROGUIDA Оригинальный номер агрегата	Cod. originale KIT Оригинальный номер ремкомплекта
		Размеры					
15X611	VOP			19,05	Chrysler Concord "93/97, Dodge, albero Ø19,5		
15X612	VOP				Chrysler, Dodge, Truck, Plimount, (federalroller)		
15X613	VOP				Daimler V.8		
15X614	VOP				Dodge, Chrysler (Thompson slipper large)		
15X615	VOP				Dodge, Plymouth		
15X616	VOP				AMC, Lincoln Ford, Truck, Mercury (eatonroller)		
15X617	VOP				Saginaw - AMC, Jeep Cherokee "81/86		
15X618	VOP				Jeep Cherokee		
15X619	VOP				Chrysler, Voyager motore VM		
15X620	VOP			19,05	Corvette 5, 71TC		
15X621	VOP				Chrysler Crown Imperial		
15X622	VOP				Dodge Neon "97/99, Toyota Solara		
15X623	VOP				Chrysler Sebring "97/99		
15X624	VOP				Chrysler LHS "95-97, Dodge Intrepid "95/97, Eagle Vision "95-97		
15X625	VOP				Dodge Dakota, Durango "00-03		
15X626	VOP				Cadillac CTS2003		
15X627	VOP				Buick Skylark, Pontiacgrand AM "95/98		
15X628	VOP				Dodge Ram Pickup 2, 4;3, "90/94		
15X629	VOP				Kit pompa Dodge Challenger, Colt 1980-83-Dodge RAM 50 1980, Plymouth Sadorro 1980-83, Plymouth Arron Truck 1980		
15X630	VOP				Chrysler, Jeep 2, 5TD, Alfa		
15X631	VOP				Oldsmobile Aurora "01/03, Cadillac Deville, STS, SLS2000/03		
15X632	VOP				Buick Roadmaster		
15X633	VOP				Oldsmobile Intrigue3, 5V6Dohc "98"03		
15X634	VOP			17,00	Chrysler, albero Ø17		
15X635	VOP			17,00	Pontiac Bonneville "04/06, albero Ø17		
15X636	VOP			19,05	Pontiac Bonneville "00/05, GMC, Chevrolet "02/06, albero Ø19,05		
15X637	VOP			17,00	Dodge Dakota "05/07 Lexus LX470, Toyota L., albero Ø17		
• 15X638	VOD				Chrysler, Voyager, paraolio DIS. 1PM Øi 20, DIS. 0M Øi 11,75		
• 15X639	VOP			15,00	Chrysler Sebring 2.4L 2001-04, albero Ø15		
• 15X640	VOP			17,00	pompa Dodge Caliber, Jeep Patriot, anno 2007-08, albero Ø17		
• 15X641	VOP			18,00	Kit pompa Dodge Dakota anno 2004, albero Ø18		
• 15X642	VOP			17,00	Kit pompa Dodge Dakota 2005-07 Lexus LX470, Toyota L., albero Ø17, II serie		
15X811	VOP				Saginaw - Jeep Cherokee 2, 5TD/WM		

Kia

12X

Codice Code Код	Ref. Приме- нение	Ø crem. rack Ø	Ø distr. pinion Ø	Ø albero shaft Ø	Descrizione per utilizzo Use remarks Примечания	Cod. originale IDROGUIDA Оригинальный номер агрегата	Cod. originale KIT Оригинальный номер ремкомплекта
		Размеры					
12X001	VOK	25,00			Kia Sephia "94-96, Shuma "97, crem. Ø25		
12X002	VOK				Kia Sportage, Daihatsu		
12X003	VOK	28,00			Kia Carnival crem. Ø28, paraoli dis.7V2		
12X004	VOK	28,00			Kia Sedona 2005, paraoli dis. 7V1, crem. Ø28		



Kit idroguida

Kits for power steering

Ремкомплекты для рулевого управления

Codice Code Код	Ref. Приме- нение	Ø crem. rack Ø	Ø distr. pinion Ø	Ø albero shaft Ø	Descrizione per utilizzo Use remarks Примечания	Cod. originale IDROGUIDA Оригинальный номер агрегата	Cod. originale KIT Оригинальный номер ремкомплекта
		Размеры					
12X005	VOK	28,00			Kia Sorrento Ex "03/06, crem. Ø28		
12X006	VOK	25,00			Kia Spectra L4 1.8 L,"02/04, crem.25		
12X007	VOK	25,00			Kia Sephia, "97-01, crem. Ø25		
12X008	VOK	23,00			Kia Rio "01-04, crem. Ø23		
• 12X009	VOK	27,70			Kit idro Kia Sedoma, Hyundai Entrouge, crem. Ø27,7		
12X601	VOP				Kit pompa Kia Sportage 2005-06, Hyundai Tucson		
12X602	VOP			20,00	pompa Kia Optima & Magentis 2001-06		
• 12X701	OCX				Cuffia crem.idro termoplastico SX/DX, Kia Carnival 1998		
• 12X702	OCX				Cuffia crem.idro termoplastico SX/DX, Kia Shepia 1993 '97, Schuma 1997-'04		
• 12X703	OCS				Cuffia crem.idro termoplastico SX, Kia Rio 2000-'04		
• 12X704	OCX				Cuffia crem.idro termoplastico SX/DX, Kia Picanto dal 2004		
• 12X705	OCD				Cuffia crem.idro termoplastico DX, Kia Rio 2000-'04		

Lada

30X

Codice Code Код	Ref. Приме- нение	Ø crem. rack Ø	Ø distr. pinion Ø	Ø albero shaft Ø	Descrizione per utilizzo Use remarks Примечания	Cod. originale IDROGUIDA Оригинальный номер агрегата	Cod. originale KIT Оригинальный номер ремкомплекта
		Размеры					
30X001	VOK				Lada Niva GMB		
• 30X002	VOK				Kit idro a settore completo Lada Niva		
30X701	OCX				cuffia cremagliera(TRW) manuale Lada Samara (centrale)		

Lancia - Autobianchi

32X

Codice Code Код	Ref. Приме- нение	Ø crem. rack Ø	Ø distr. pinion Ø	Ø albero shaft Ø	Descrizione per utilizzo Use remarks Примечания	Cod. originale IDROGUIDA Оригинальный номер агрегата	Cod. originale KIT Оригинальный номер ремкомплекта
		Размеры					
32X001	VOK	23,00			TRW -Lancia Dedra 1.6, 1.8, 2 IE,T.D. 1.9 S - FL 2,0 IE 16V SW, niova Delta 1.6,1.8 IE 2,0 16V HPE,Autobianchi 3,2-1,4 1S. - LX 5"89,crem. Ø23		
32X002	VOK	25,00			TRW -Lancia Delta HF turbo GT TD, Prisma 1.6ie Ds/TDS "86, Thema "84.94, crem. Ø25	15000786/ 15000789	
32X003	VOK	25,00			TRW- Lancia K,crem. Ø25		
32X004	VOK				TRW Autobianchi/Z 2,0 IE , turbo LS , LX ,TD 2,1 12V		
32X005	VOK				ZF- Lancia Beta "74 ,Trevi 2.0 ,Volumex	7844955101	7844/1
32X006	VOK				ZF- Lancia Gamma 1981	7844955102	7844/2
32X007	VOK				ZF -Lancia Beta	7844955106/ 7844955110/ 7844955114/ 7844955104/ 7844955105/ 7844955108	7844/3
32X008	VOK	24,00			kit idro ZF Lancia Thema -86/kit idro ZF Lancia Thema V6, crem. Ø24	7840991101/ 7840991103/ 7840991105	7840/50
32X009	VOK				kit idro ZF Lancia Thema 8,32		
32X010	VOK	25,00			Kit idro TRW Thema 1 S. crem.Ø25 - 2 paraoli disegno 7		

VOK Kit idroguida Power steering kit Ремкомплект рулевого управления
VOC Kit cremagliera Rack kit Ремкомплект гидроцилиндра
VOD Kit distributore Pignon kit Ремкомплект распределителя
VOP Kit pompa Pump kit Ремкомплект насоса
OCD Cuffia destra Rack boot (right) Правый сайлентблок
OCS Cuffia sinistra Rack boot (left) Левый сайлентблок
OCX Cuffie sinistra+destra Rack boot (left+right) Набор сайлентблоков
OCC Kit cuffie Rack boot kit Ремкомплект сайлентблоков



Codice Code Код	Ref. Приме- нение	Ø crem. rack Ø	Ø distr. pinion Ø	Ø albero shaft Ø	Descrizione per utilizzo Use remarks Примечания	Cod. originale IDROGUIDA Оригинальный номер агрегата	Cod. originale KIT Оригинальный номер ремкомплекта
32X011	VOK	25,00			kit idro TRW Thema 2 S. cremag.Ø25-1 paraolio disegno 6/1 paraolio disegno 7		
32X012	VOK	25,00			kit idro TRW Thema 3 S. cremag.Ø25-2 paraoli disegno 6		
32X013	VOD				kit idro TRW distributore Lancia		
32X014	VOK	24,00			ZF completo, Lancia K servotronic, crem. Ø24	7831991106 7831991105 7831993103	7831/014-15
32X015	VOK	28,00			kit idro TRW Lancia Z crem.Ø28 - paraolio disegno 7 CC 2000 ANNO 95		
32X016	VOK	23,00			kit idro TRW Lancia Y crem. Ø 23		
32X017	VOK	23,00			kit idro TRW Lancia Y crem. 23		
32X018	VOK	25,00			kit idro TRW completo Lancia Evoluzione, crem. Ø25	15000786/ 15000789	
32X019	VOK	24,00			kit idro Lancia Thema ZF (88-95), crem. Ø24		7840/051
32X020	VOK	24,00			kit idro ZF Lancia Kappa KHD, crem. Ø24		
32X021	VOK	25,00			kit idro TRW Lancia Kappa 1994-01, crem. Ø25	15000833,15000871	
32X022	VOK	25,00			kit idro TRW Lancia Libra, crem. Ø25		
32X600	VOP			19,05	kit pompa ZF Lancia Thema, albero Ø19,05		7681/5
32X601	VOP				kit pompa ZF Lancia Dedra		7681/5
32X602	VOP			20,00	kit pompa ZF Lancia Delta Integrale, 1979-'92, albero Ø20		7671/7
32X603	VOP			16,00	kit pompa ZF Lancia Thema autolivellante	8691955141	8691/3
32X604	VOP				kit pompa ZF Lancia Prisma/Delta		7671/9
32X701	OCD				kit cuffia cremaglieraidro (TRW) Thema-Ferrari (completo)		
32X702	OCS				cuffia cremagliera idro (TRW) SX Thema 1985>		
32X703	OCS				cuffia cremagliera idro (TRW) DX Thema 1985>		
32X704	OCX				cuffia cremagliera (TRW) SX/DX Lancia Dedra 10/1990>		
32X705	OCX				cuffia cremagliera (TRW) SX/DX - nuova Delta 94>		
32X706	OCX				cuffia cremagliera (TRW) SX/DX Delta tutte - Prisma 6/1988>		
32X707	OCX				cuffia cremagliera (TRW) Beta 9/72 -1984 MANUALE		
32X708	OCX				kit cuffia cremagliera Thema 1985 in poi		
32X709	OCX				cuffia cremagliera DX/SX Lancia Thema c/servotronic		
• 32X710	OCX				Cuffia idro termoplastico SX/DX Lancia Lybra		
• 32X711					Cuffia idro termoplastico SX/DX, Lancia Delta 1993-'96, Ypsilon 1995-'03, Punto 1997-'99		
• 32X712					Cuffia idro termoplastico SX/DX, Lancia Phedra 2002-'03		
• 32X713	OCX				cuffia crem. termoplastico SX/DX Lancia Delta dal 2008		
• 32X714	OCX				cuffia crem. termoplastico SX/DX Lancia Musa dal 2004		
• 32X715	OCX				cuffia crem. termoplastico SX/DX Lancia Phedra 2003-'07		
• 32X716	OCX				cuffia crem. termoplastico SX/DX Lancia Ypsilon dal 2003		
32X760	OCC				kit cuffie man. Lancia Thema		
32X761	OCC				kit cuffie man. Lancia Delta		
32X762	OCC				kit cuffie man. Lancia Delta		



Kit idroguida

Kits for power steering

Ремкомплекты для рулевого управления

Codice Code Код	Ref. Приме- нение	Ø crem. rack Ø	Ø distr. pinion Ø	Ø albero shaft Ø	Descrizione per utilizzo Use remarks Примечания	Cod. originale IDROGUIDA Оригинальный номер агрегата	Cod. originale KIT Оригинальный номер ремкомплекта
32X763	OCC				kit cuffie man. Lancia Dedra		
• 32XE900					Idroguida elettrica-Lancia Y 2003		
• 32XE901					Idroguida elettrica-Lancia Delta 2009		
• 32XE902					Idroguida elettrica-Lancia Musa		

Maserati

36X

Codice Code Код	Ref. Приме- нение	Ø crem. rack Ø	Ø distr. pinion Ø	Ø albero shaft Ø	Descrizione per utilizzo Use remarks Примечания	Cod. originale IDROGUIDA Оригинальный номер агрегата	Cod. originale KIT Оригинальный номер ремкомплекта
36X001	VOK				Kit idro TRW Maserati Biturbo 2.24V - 4.24V 4/1988-8/1984		
36X002	VOK				Kit idro TRW Maserati 4porte 2.0i 2.8 Biturbo V6 24V/Ghibli 2.0i, 2.8i V6 - Shamal 3,2i/turbo V8 32V 7/1995-		
36X003	VOK	26,00			Kit idro ZF Maserati 1978-81, crem. Ø26	7842955116	7852/3

Mercedes-Benz

38X

Codice Code Код	Ref. Приме- нение	Ø crem. rack Ø	Ø distr. pinion Ø	Ø albero shaft Ø	Descrizione per utilizzo Use remarks Примечания	Cod. originale IDROGUIDA Оригинальный номер агрегата	Cod. originale KIT Оригинальный номер ремкомплекта
38X001	VOK				Mercedes SL W107, 280, 350, 450, "72-88, a settore		
38X002	VOK				Mercedes W109 "62-69, W110 "60-68, W111 "60-68, a settore		
38X003	VOK				Mercedes classe E, W123 "76-85, W124 "85-95, a settore		
38X004	VOK				Merceds Classe E W124 "85-96, a settore	2014600061	2014602302
38X005	VOK				Mercedes Classe E W124, 320CE	1244610161/ 52088993	1244610401/801
38X006	VOK	28,00			ZF - Mercedes Classe E, E300 "96-98, W210 servotronic turbo diesel, crem. Ø28		
38X007	VOK	32,00			kit idro TRW Mercedes Sprinter crem. Ø32, pignone piccolo, paraolio dis. 0M Ø23,3		
38X008	VOK	32,00			kit idro TRW Mercedes Vito pignone grande		
38X009	VOK	32,00			kit idro TRW Mercedes Vito pignone piccolo		
38X010	VOK	28,00			kit idro ZF Merc. Classe E 2000 serv, E320, E420 96-97, crem. Ø28	8401991101- 8401955102	8401/2
38X010 Light		28,00			allegg. ZF Merc. Classe E, crem. Ø28		
38X011	VOK				kit idro ZF Mercedes Classe E Proton	7831974132	7831/10
38X012	VOK	32,00			kit idro TRW Mercedes Vito/Sprinter crem. Ø32 pignone grande, paraolio dis. 0M Ø27		
38X013	VOK				kit idro TRW Mercedes 308 pignone piccolo		
38X014	VOK	32,00			kit idro TRW Mercedes 308, pignone grande		
38X015	VOK	32,00			kit idro TRW Mercedes 308, crem. Ø32, pignone medio paraolio DIS. 0M Ø25		
38X016	VOK	32,00			kit idro TRW Mercedes Vito, crem. Ø32, pignone medio paraolio DIS. 0M Ø25		
38X017	VOK	32,00			kit idro TRW Mercedes Sprinter , crem. Ø32, pignone medio, paraolio dis. 0M Ø25		
38X018	VOK	32,00			kit idro TRW Mercedes Vito A416, crem. Ø32 pignone Ø25, paraolio DIS. 0M		

VOK Kit idroguida Power steering kit Ремкомплект рулевого управления
VOC Kit cremagliera Rack kit Ремкомплект гидроцилиндра
VOD Kit distributore Pignon kit Ремкомплект распределителя
VOP Kit pompa Pump kit Ремкомплект насоса
OCD Cuffia destra Rack boot (right) Правый сайлентблок
OCS Cuffia sinistra Rack boot (left) Левый сайлентблок
OCX Cuffie sinistra+destra Rack boot (left+right) Набор сайлентблоков
OCC Kit cuffie Rack boot kit Ремкомплект сайлентблоков



Codice Code Код	Ref. Приме- нение	Ø crem. rack Ø	Ø distr. pinion Ø	Ø albero shaft Ø	Descrizione per utilizzo Use remarks Примечания	Cod. originale IDROGUIDA Оригинальный номер агрегата	Cod. originale KIT Оригинальный номер ремкомплекта
38X018A	VOK	24,00			kit idro Mercedes classe A, crem. Ø24		
38X019	VOK	26,00			kit idro ZF-Mercedes CL.C W203, crem. Ø26		
38X019A	VOK	25,00			kit idro TRW Mercedes Classe A 1997-04		
38X020	VOK	28,00			kit idro ZF Mercedes Classe M, crem.Ø28		7852/34
38X020A	VOK	25,00			kit idro Mercedes Classe A U.T, crem.Ø25		
38X021	VOK	28,00			kit idro Mercedes 250 4 fari Classe E "96	8401955102	8401/2
38X022	VOK	32,00			ZF Mercedes CL W220 2001, Classe S 1998-06		
38X023	VOK				kit idro Mercedes benz. 100 Minibus		
38X024	VOK				Mercedes Classe S W140 "91-98, 300SE, 400SEC, a settore		
38X025	VOK	32,00			Mercedes Sprinter, pignone grande Ø27		
38X026	VOK	32,00			Mercedes Vito crem. Ø32, pignone grande Ø27		
38X027	VOK	28,00			ZF - ML320, ML270, crem. Ø28	7852974338/L	7852501372
38X028	VOD				Mercedes 500SL W129 "92/01, benzina, a settore		
38X029	VOK	26,00			kit idro Mercedes benz. Classe E W211, crem. Ø26		
38X030	VOK	30,00			Kit idro Mercedes Vito (Pistone sigillato Ø48) crem.Ø30		
38X031	VOK	30,00			kit idro Mercedes Vito/Sprinter mod.originale(pistone sigil. Ø54) crem Ø30	A 906 460 0200 05 264 0020 R-0-906 1101 1 005	
38X032	VOD			32,00	kit idro Mercedes BM 124/202 genuine		1244600161
38X033	VOK	30,00			Kit idro Mercedes Vito/Sprinter, pistone sigil. Ø54, crem. Ø30		
38X034	VOK	26,00			Kit idro Mercedes, crem.Ø26 ,pistone sigillato da Ø45	20411011017	
38X035	VOK	28,00			kit idro ZF Mercedes classe M servotronic 2000 , crem Ø28	7852993238	7852/546
38X036	VOK	28,00			kit idro ZF Mercedes classe M 1998, non servotr, crem. Ø28	7852974596	7852/544
38X037	VOK	26,00			Kit idro Mercedes benz. VitoTD dal 2004, crem.Ø26		
38X038	VOK	28,00			Kit idro Mercedes Benz classe A servotronic, crem. Ø28		
38X601	VOP			19,05	Mercedes, albero Ø19,05		
38X602	VOP			19,05	Kit pompa Mercedes Luker - Viker, albero Ø19,05		
38X603	VOP				LUK - Mercedes, un paraolio dis. 0M Ø17 e un paraolio dis. 0M Ø15		
38X604	VOP			19,05	Mercedes Classe E, E420, albero 19,05		7683/5
38X605	VOP				Kit pompa ZF - Mercedes		7691/1
38X606	VOP			16,00	Kit pompa Luk Mercedes Sprinter, albero Ø16		
38X607	VOP			19,05	Kit pompa Luk Mercedes, albero Ø19,05		
38X608	VOP				kit pompa ZF Mercedes	7682900109	
38X609	VOP				kit pompa ZF autolivellante Mercedes	8692900512	
38X610	VOP				kit pompa ZF Mercedes M/B S class Tandem		8692/4
38X611	VOP			19,05	Mercedes M/B 190 E, albero Ø19,05		7682/1 7682/3
38X612	VOP				ZF - Mercedes Classe C, 230, 320E, CLK M/B W202, Tandem		8692/1
38X613	VOP				Kit pompa ZF - Mercedes M/B Classe S Vane		8692/3
38X614	VOP				kit pompa Mercedes Benz		
38X615	VOP				Kit pompa Mercedes Benz, un paraolio Ø15 e un paraolio Ø30		
38X616	VOP			19,05	Mercedes, albero Ø19,05		
38X617	VOP			19,05	Kit pompa LUK - Mercedes Vickers VT66, albero Ø19,05		



Kit idroguida

Kits for power steering

Ремкомплекты для рулевого управления

Codice Code Код	Ref. Приме- нение	Ø crem. rack Ø	Ø distr. pinion Ø	Ø albero shaft Ø	Descrizione per utilizzo Use remarks Примечания	Cod. originale IDROGUIDA Оригинальный номер агрегата	Cod. originale KIT Оригинальный номер ремкомплекта
38X618	VOP			16,00	Kit pompa LUK - Mercedes Sprinter, albero Ø16		
38X619	VOP				Kit idro ZF- Mercedes		
• 38X620	VOP			28,00	Kit pompa pistoni LUK, Mercedes S500, S600, SL55, CL AMG autolivellante		
• 38X621	VOP			16,00	pompa LUK - Mercedes CLK 320-430, albero Ø16		OE 0024662401 Ref. 541007310
• 38X622					pompa LUK Mercedes, doppio attacco		
• 38X623	VOP			28,00	Kit completo pompa pistoni LUK, Mercedes S500, S600, SL55, CL AMG autoliv. II° REV.		
• 38X624	VOP			28,00	Kit pompa Mercedes S Class CL 600 C215		
• 38X625	VOP			16,00	Kit pompa Luk Mercedes Classe E W211 veicoli con controllo automatico del livello		
• 38X701					Cuffia idro SX/DX Mercedes Vito, Classe A, W168		
• 38X702					Cuffia idro SX/DX Mercedes Classe A, W168		
• 38X703					Cuffia idro termoplastico SX/DX Mercedes Classe S W220, Classe S COUPE C215, SL R230		
• 38X704	OCX				Cuffia idro termoplastico SX/DX Mercedes Classe E W211, Classe E T211, C SPORT COUPE C203		
• 38X705	OCX				Cuffia idro termoplastico SX/DX Mercedes Classe A 1997-'04, Vaneo Compact Van 2001-'05		
• 38X706	OCX				Cuffia idro termoplastico SX/DX Mercedes Sprinter 2-t/3-t/4-t 1995-'05		
• 38X707	OCX				Cuffia idro termoplastico SX/DX Mercedes benz.		
• 38X708	OCS				Cuffia idro termoplastico SX/DX Mercedes Classe E ,Berlina/Wagon, dal 2003-'07		
• 38X709	OCS				Cuffia idro termoplastico SX Mercedes Classe A dal 2004, Classe B dal 2005		
• 38X710	OCD				Cuffia idro termoplastico DX Mercedes Classe A dal 2004, Classe B dal 2005		
• 38X711	OCS				Cuffia idro termoplastico SX Smart Coupè/Cabrio dal 1998		
• 38X712	OCD				Cuffia idro termoplastico DX Smart Coupè/Cabrio dal 1998		
• 38X713	OCD				Cuffia idro termoplastico Smart Coupè/Cabrio dal 1998		
38X800					Pompa elettrica Mercedes Classe A	290500113	
• 38X802	TRW				Pompa elettrica Mercedes	OE A2214600780	
• 38X803	TRW				Pompa elettrica Mercedes	OE A2044600580	

Mitsubishi

39X

Codice Code Код	Ref. Приме- нение	Ø crem. rack Ø	Ø distr. pinion Ø	Ø albero shaft Ø	Descrizione per utilizzo Use remarks Примечания	Cod. originale IDROGUIDA Оригинальный номер агрегата	Cod. originale KIT Оригинальный номер ремкомплекта
39X001	VOK	24,00			KOYO - SpaceWagon, Cordia, Tredia "84-87, crem. Ø24		
39X002	VOK				Kit idro Mitsubishi Colt Mirage, Space Wagon, 85-87		
39X003	VOK				Kit idro Mitsubishi VanWagon "87-90, L300 Van		
39X004	VOK	24,00			Mitsubishi Colt x2 "92-93, Mirage "88, Elantra, crem. Ø24		
39X005	VOK				Mitsubishi Galant "85		
39X006	VOK				Mitsubishi Galant "86-87, Sigma "87-89		
39X007	VOK				Mitsubishi Eclipse "88-90, Galant 4WD "89-92		
39X008	VOK				Mitsubishi Galant turbo DOHC, 4WD, 4WS "90-92		

VOK Kit idroguida Power steering kit Ремкомплект рулевого управления
VOC Kit cremagliera Rack kit Ремкомплект гидроцилиндра
VOD Kit distributore Pignon kit Ремкомплект распределителя
VOP Kit pompa Pump kit Ремкомплект насоса
OCD Cuffia destra Rack boot (right) Правый сайлентблок
OCS Cuffia sinistra Rack boot (left) Левый сайлентблок
OCX Cuffie sinistra+destra Rack boot (left+right) Набор сайлентблоков
OCC Kit cuffie Rack boot kit Ремкомплект сайлентблоков



Codice Code Код	Ref. Приме- нение	Ø crem. rack Ø	Ø distr. pinion Ø	Ø albero shaft Ø	Descrizione per utilizzo Use remarks Примечания	Cod. originale IDROGUIDA Оригинальный номер агрегата	Cod. originale KIT Оригинальный номер ремкомплекта
39X009	VOK				Kit idro Mitsubishi Galant DOHC "88-91, Sapporo		
39X010	VOK				Mitsubishi Galant, Sigma "89, Sonata "89-93		MB682002
39X011	VOK				Mitsubishi Eclipse, Laser "90-92		
39X012	VOK	30,00			Kit idro Mitsubishi Pajero, Shogun, Sigma		
39X013	VOK			32,00	a settore Mitsubishi Pajero, L200, albero Ø32		
39X014	VOK			35,00	a settore Mitsubishi Pajero, L200, albero Ø35		
39X015	VOK				Mitsubishi Pajero, Shogun U.T. V6 3500cc	10777/MB151061	
39X016	VOK				Kit idro Mitsubishi Pajero, Montero "94-97		
39X017	VOK				Kit idro Mitsubishi Galant "92, Eclipse "95-99		
39X018	VOK	27,70			Mitsubishi 3000 GT "90-98, Diamante "91-95, Dohc Wagon "93-94, crem. Ø27,7		MB891603
39X019	VOK				Mitsubishi Explorer, LRV "91-95, Summit "95		
39X020	VOK				Mitsubishi Mirage "86-89		
39X021	VOK	24,00			Mitsubishi Super Lancer "92, crem. Ø24, con un paraolio Øe 36,6 e un paraolio con Øe 41,2		
39X022	VOK	24,00			Mitsubishi Super Lancer "92, crem. Ø24, con due paraoli Øe 41,2		MB910971
39X023	VOK				Kit idro Mitsubishi Truck 4WD "83-86		
39X024	VOK	24,00			KOYO SMI - Mitsubishi Karisma 16 Val.		
39X025	VOK	26,00			Mitsubishi Space Wagon, crem. Ø26		
39X026	VOK				Mitsubishi Lancer CLX		
39X027	VOK	24,00			Kit idro Mitsubishi Space Wagon, 4WD, crem. Ø24		
39X028	VOK				Kit idro Mitsubishi Galant "98-99, Eclipse "00-04		
39X029	VOK	24,00			Mitsubishi Mirage "99, crem. Ø24		
39X030	VOK				Mitsubishi Magna		
39X031	VOK	24,00			Kit idro Mitsubishi Super Lancer, crem. Ø24		
39X032	VOK				Mitsubishi Galant 2.0 L "97, SpaceWagon "99		
39X033	VOK	28,00			Kit idro Mitsubishi Diamante "97-99, crem. Ø28		
39X034	VOK				Kit idro Mitsubishi Galant "93-94		
39X035	VOK				Kit idro Mitsubishi Mirage "92-94, Colt "93-95		
39X036	VOK				Kit idro Magnasteer, Century "96-99, Aurora, Grand Prix "97-00		
39X037	VOD				Mitsubishi, pignone Ø32		
39X038	VOK				Kit idro Mitsubishi 4WD Pickup "87-91		
39X039	VOK	32,00			Mitsubishi Montero "01-03, Pajero "01-02		
39X040	VOK	28,00			Mitsubishi Diamante "00-02, crem. Ø28		
39X041	VOK	24,00			Mitsubishi Karisma, crem. Ø24		
39X042	VOK	32,00			Mitsubishi Shogun 3, 2D V6 2000, crem Ø32		
39X043	VOK	24,00			Kit idro Mitsubishi Lancer"92/96, crem Ø24		
39X044	VOK	26,00			Mitsubishi Eclipse Koyo "05,Galant 2004-05		
39X045	VOK	27,70			Mitsubishi Delica "94-00, crem. Ø27,7		
39X046	VOK	27,70			Kit idro KOYO/SMI - Mitsubishi Lancer evolution "03-06, crem Ø27,7		
• 39X047	VOK	32,00			Kit idro Mitsubishi, crem. Ø32 (2 paraoli DIS.7V2 Ø32x50)		
39X601	VOP				kit pompa Mitsubishi		
39X602	VOP			20,00	kit pompa Mitsubishi, albero Ø20		
39X603	VOP				kit pompa Mitsubishi		
39X604	VOP				kit pompa Mitsubishi		
39X605	VOP				kit pompa Mitsubishi 3000GT 1991-95		
39X606	VOP				kit pompa Mitsubishi 4WD Truck (Saginaw)		
39X607	VOP				kit pompa Mitsubishi Mirage 1985-88		



Kit idroguida

Kits for power steering

Ремкомплекты для рулевого управления

Codice Code Код	Ref. Приме- нение	Ø crem. rack Ø	Ø distr. pinion Ø	Ø albero shaft Ø	Descrizione per utilizzo Use remarks Примечания	Cod. originale IDROGUIDA Оригинальный номер агрегата	Cod. originale KIT Оригинальный номер ремкомплекта
39X608	VOP				kit pompa Mitsubishi Mirage 1985-88		
39X609	VOP				kit pompa Mitsubishi Strion (83)		
39X610	VOP				kit pompa Mitsubishi Mirage (99-00)		
39X611	VOP				kit pompa Mitsubishi Precis 890-939		
39X612	VOP				kit pompa Mitsubishi Shogun Pajero 2,5 TD 1990/93		
39X613	VOP			17,00	kit pompa Mitsubishi Space Wagon 1,8 "97		
39X614	VOP				kit pompa Mitsubishi Pajero		
39X701	OCX				cuffia cremagliera idro Mitsubishi Debonair,Diamante, Sigma,Gto,Eclipse "89,Galant esterna "83,Tredia,Cordia "82,Lacer,Fiore"83- Mirage 83> - LIBERO 92>		
39X702	OCX				cuffia cremagliera idro Mitsubishi Charlot "83,Lacer,Fiore"82-83 - Mirage 78/83		
39X762	OCC				kit cuffie man. Mitsubishi		
• 39X763	OCS				Cuffie idro SX Mitsubishi Pajero, Montero		
• 39X764	OCD				Cuffie idro DX Mitsubishi Pajero, Montero		
• 39X765	OCX				Cuffie idro SX/DX Mitsubishi Carisma, Space Star		
• 39X766	OCX				Cuffie idro SX/DX Mitsubishi Space Runner/Wagon 1998-'03		

Nissan

41X

Codice Code Код	Ref. Приме- нение	Ø crem. rack Ø	Ø distr. pinion Ø	Ø albero shaft Ø	Descrizione per utilizzo Use remarks Примечания	Cod. originale IDROGUIDA Оригинальный номер агрегата	Cod. originale KIT Оригинальный номер ремкомплекта
41X001	VOK	25,00			TRW - Nissan Sylvia turbo 1984,c rem. Ø25		
41X002	VOD			32,00	Kit idro Nissan Patrol 160/260 1989,albero Ø32		
41X003	VOK			32,00	ZF- Nissan Terrano major II serie, albero Ø32,pign.Ø18	8054974210	8054/18
41X004	VOK				ZF-Nissan Terrano minor kit II serie	8054974210	8054/19
41X005	VOK				Kit idro Nissan 200SX,Bluebird 1989		
41X006	VOK	24,00			Kit idro TRW N. Maxima 1986/88,Bluebird,Stanza "86/88,200XS, crem. Ø24		
41X007	VOK	24,00			Kit idro Nissan Sunny "86-88,Sentra "86- 90,Pulsar,crem. Ø24		
41X008	VOK	22,00			Kit idro Nissan Sentra 1983-85,Pulsar,crem. Ø22		
41X009	VOK				Kit idro Nissan Stanza,Prairie"83-89,Sentra,Pulsar		
41X010	VOK				Kit idro Nissan Maxima 1981-84,Sentra 1986-90		
41X011	VOK	24,00			Kit idro Nissan Sentra 4WD 1986-90,crem. Ø24		
41X012	VOK	26,00			Kit idro N.Maxima 88-93,Prairie,Stanza 90-92,M30 89- 91,crem. Ø26		
41X013	VOK				Kit idro Nissan 240SX 1988-94,200SX turbo 90-92		
41X014	VOK	26,00			Kit idro Nissan 300ZX 1989-94,Axxes 4ws 89-91		
41X015	VOK	24,00			Kit idro Nissan 300ZX 1986-89,crem. Ø24		
41X016	VOK	24,00			Kit idro Nissan Maxima 1985-86,crem.Ø24		
41X017	VOK	24,00			Kit idro Nissan Maxima 1981-84,300ZX 1984-86		
41X018	VOK	25,00			Kit idro Nissan 280ZX 1981-83,crem. Ø25		
41X019	VOK	25,00			Kit idro Nissan Primera,Micra,crem. Ø25		
41X020	VOK	28,00			Kit idro TRW Nissan Quest "93-94,crem. Ø28		
41X021	VOK				Kit idro Nissan Sentra 292/96,Infinity"99		
41X022	VOK	25,00			Kit idro TRW Nissan Primera 1990,crem. Ø25		12-9R-9725
41X023	VOK				Kit idro Nissan Pulsar DOHC 286-89		

VOK Kit idroguida Power steering kit Ремкомплект рулевого управления
VOC Kit cremagliera Rack kit Ремкомплект гидроцилиндра
VOD Kit distributore Pignon kit Ремкомплект распределителя
VOP Kit pompa Pump kit Ремкомплект насоса
 OCD Cuffia destra Rack boot (right) Правый сайлентблок
 OCS Cuffia sinistra Rack boot (left) Левый сайлентблок
 OCX Cuffie sinistra+destra Rack boot (left+right) Набор сайлентблоков
 OCC Kit cuffie Rack boot kit Ремкомплект сайлентблоков



Codice Code Код	Ref. Приме- нение	Ø crem. rack Ø	Ø distr. pinion Ø	Ø albero shaft Ø	Descrizione per utilizzo Use remarks Примечания	Cod. originale IDROGUIDA Оригинальный номер агрегата	Cod. originale KIT Оригинальный номер ремкомплекта
41X024	VOK				kit idro Nissan autocarro L35 "92- TRW		
41X025	VOK				kit idro Nissan autocarro L35 motore 2800 428/2		
41X026	VOK	26,00			kit idro Nissan Primera crem. Ø26		
41X027	VOK				kit idro Nissan KING-KAB / Pick up		
41X028	VOK			32,00	ZF Nissan Terrano II, albero Ø32, pign.Ø20	8074974603	8074/02-8074/06
41X029	VOK			32,00	Kit idro ZF Nissan Terrano (Paraolio in viton)		8054/018
41X030	VOK	25,00			Kit idro Nissan Vanette crem. Ø25		
41X031	VOK	24,00			Kit idro Nissan Almera,Sunny 1995 crem.Ø24,Micra 1997		
41X032	VOK				Kit idro Nissan Patrol GR Ø28		
41X033	VOK			32,00	Kit idro Nissan Patrol GR Ø32		
41X034	VOK			38,00	Kit idro Nissan Patrol GR U.tipo Ø38		
41X035	VOK	25,00			kit idro TRW Nissan largo crem.Ø 25		
41X036	VOK	25,00			Kit idro Nissan Skyline 2,01/3,1 1987-92,crem.Ø25		
41X037	VOK				Kit idro Nissan Maxima 1994/98,Infinity I30 1995/97		
41X038	VOK				Kit idro TRW USA Nissan Sentra 1991-98,200SX 1995-98		
41X039	VOK	32,00			Nissan Pathfinder 95-97,Infinity QX4 96-98		
41X040	VOK	24,00			Kit idro Nissan 240SX coupè 1994-98,crem. Ø24		
41X041	VOK	26,00			Kit idro Infinity Q45, J30 1992-97,crem. Ø26		
41X042	VOK	26,00			Kit idro Infinity G20 1991-96,crem. Ø26		
41X043	VOK				kit idro Nissan Pathfinder (91-92)/furgone 6 CYL 4WD (91-93)		
41X044	VOK	26,00			Kit idro Nissan Maxima 1999-01,3.5 L 2007		
41X045	VOK			38,00	Kit idro a settore Nissan Patrol GQ,albero Ø38		
41X046	VOK	25,00			Kit idro TRW Nissan Primera 1990-96,Ldv Cub 1998,crem. Ø25		
41X047	VOK	26,00			Kit idro Nissan Altima 4 CYL.2002-04,crem. Ø26		
41X048	VOK	25,00			kit idro Nissan Almera Brasil,crem. Ø25		
41X049/A	VOK	24,00			Nissan Sentra Moderno, crem.Ø24		
41X050	VOK			35,00	Kit idro Nissan Patrol GR U.T.N. King Cab		
41X051	VOK	25,00			TRW - Nissan Almera 1995, Nissan Perfect		
41X052	VOK	26,00			Kit idro Nissan Altima 1993-98, crem.Ø26		
41X053	VOD				Kit idro Nissan Frontera 4WD 6CYL "91-93		
41X054	VOK	26,00			Kit idro Nissan Altima 2002, crem. Ø26		
41X055	VOK	25,00			Kit idro TRW N. Primera 1990-96,Micra 1983-03		
41X056	VOK	26,00			Nissan Murano "03-04, crem.26		
41X057	VOK	32,00			Nissan Infiniti QX56 "04-05, crem. Ø32		
41X058	VOK	30,00			Nissan Urvan "99-01, crem. Ø30		
41X059	VOK	24,00			Kit idro Nissan X-Trail, crem. Ø24		
• 41X060	VOK	32,00			Nissan Exterra, Frontier 2005-07, crem. Ø32		
• 41X061	VOK	26,00			Nissan Infiniti G35,2005-'07, crem. Ø26		
• 41X062	VOK	26,00			Nissan Infiniti FX 2003-05, crem. Ø26		
41X601	VOP				Nissan 200SX "78-83, 280ZX "80-83, Stanza "82-85, Pulsar "83-86		
41X602	VOP				Nissan 200SX 1983-86		
41X603	VOP				Nissan 240ZX 4WS "91-94, 200SX "83-86		
41X604	VOP				Nissan 240SX "88-90,300ZX "87-89,Stanza "86-89		
41X605	VOP				Nissan 240SX "91		
41X606	VOP				Nissan 280 ZX-Pulsar "83-86		
41X607	VOP				Nissan 300 ZX V6 TwinTurbo-Infiniti Q45 (both 4ws)		



Kit idroguida

Kits for power steering

Ремкомплекты для рулевого управления

Codice Code Код	Ref. Приме- нение	Ø crem. rack Ø	Ø distr. pinion Ø	Ø albero shaft Ø	Descrizione per utilizzo Use remarks Примечания	Cod. originale IDROGUIDA Оригинальный номер агрегата	Cod. originale KIT Оригинальный номер ремкомплекта
41X608	VOP			18,00	Nissan 300ZX (4WS) "89-93,albero Ø18		
41X609	VOP				Nissan 300ZX V6 Twin turbo (4WS) "89		
41X610	VOP				Nissan 720 Pick-up "83-86		
41X611	VOP				Nissan Maxima "81-84, 280ZX "77-80		
41X612	VOP				Nissan Pick-up "82-85		
41X613	VOP			18,00	kit pompa Nissan Sentra (4WD) "86-88, Pulsar "87-88, albero Ø18		
41X614	VOP				Nissan Sentra "86-88		
41X615	VOP				SAGINAW Nissan 1975-86	8052955150	
41X616	VOP			18,00	Nissan Patrol 2800GR, albero Ø18		
41X617	VOP				Infinity Q45 "91-95		
41X618	VOP				Nissan vari mod. "95-98		
41X619	VOP				Nissan Sentra "91-96		
41X620	VOP				Nissan Maxima "94-98		
41X621	VOP				Infinity Q45 2ws "90-96		
41X622	VOP				Nissan Primera		
41X623	VOP				Nissan Manima J30 3,0 V6 "88-94		
41X701	OCS				cuffia cremagliera (TRW) idro SX Laurel 2000 8486 / Bluebird 1,6 85/87 - 1800 man.-1800 83/87/2000 85-87 - Maxima 84/88 - Prairie 85/88 - Stanza 85/91		
41X702	OCD				cuffia cremagliera (TRW) idro DX Laurel 2000 8486 / Bluebird 1,6 85/87 - 1800 man.-1800 83/87/2000 85-87 - Maxima 84/88 - Prairie 85/88 - Stanza 85/91		
41X703	OCS				cuffia cremagliera (TRW) manuale SX 1800 AUTO 87-91 / 2000 83-85		
41X704	OCS				cuffia cremagliera (TRW) idro SX Micra 85 - VIOLET - AUSTER - STANZA / 1600-1800 81/83 Sunny - LAURET SPIRIT 81/84 - PRAIRIE 1800 82/88 - LIVERTA Villa 1500/170082/84 - MARCH 1000 80/92 - FIGARO fino al 1991 - DATSUN 84/90 -		
41X705	OCD				cuffia cremagliera (TRW) idro Nissan DX Micra 85 - VIOLET - AUSTER - STANZA / 1600-1800 81/83 Sunny - LAURET SPRINT 81/84 - PRAIRIE 1800 82/88 - LIVERTA Villa 1500/170082/84 - MARCH 1000 80/92 - FIGARO fino al 1991 - DATSUN 84/90 -		
41X706	OCD				cuffia cremagliera idro Nissan DX Crew 1994>		
41X707	OCS				cuffia cremagliera idro Nissan SX Crew 1994>		
41X708	OCX				cuffia cremagliera idro Nissan Laurel 1800 88> - Laurel 2000 88/91 - Laurel 2800 88> - Cefiro 2000 88/94 - Bluebird 87> - Bluebird 1800 87/91 - Bluebird 2000 87/91 - MAXIMA 88/90 - SKYLINE 89/91 - Primera 90/95 - SILVIA 89/94 - AVENIR 93> - PRAIRIE 88> -		
41X709	OCX				cuffia cremagliera idro Nissan Laurel 2000 86/88 - Laurel 2000/2500 91 - Cefiro 2500 92/94 - SKYLINE 85/89		
41X710	OCX				cuffia cremagliera idro Nissan Cefiro 94> - Bluebird 1600/1800/2000 91> - Primera - VANETTE 91> - LARGO 93> -		

VOK Kit idroguida Power steering kit Ремкомплект рулевого управления
VOC Kit cremagliera Rack kit Ремкомплект гидроцилиндра
VOD Kit distributore Pignon kit Ремкомплект распределителя
VOP Kit pompa Pump kit Ремкомплект насоса
 OCD Cuffia destra Rack boot (right) Правый сайлентблок
 OCS Cuffia sinistra Rack boot (left) Левый сайлентблок
 OCX Cuffie sinistra+destra Rack boot (left+right) Набор сайлентблоков
 OCC Kit cuffie Rack boot kit Ремкомплект сайлентблоков



Codice Code Код	Ref. Приме- нение	Ø crem. rack Ø	Ø distr. pinion Ø	Ø albero shaft Ø	Descrizione per utilizzo Use remarks Примечания	Cod. originale IDROGUIDA Оригинальный номер агрегата	Cod. originale KIT Оригинальный номер ремкомплекта
41X711	OCD				cuffia cremagliera idro Nissan DX Bluebird 1600/1800 AUT - 2000 83/8 - Sunny 84/85 - Villa 84/86 - EXA 86		
41X712	OCS				cuffia cremagliera idro Nissan SX Bluebird 1600/1800 AUT - 2000 83/8 - Sunny 84/85 - Villa 84/86 - EXA 86		
41X713	OCD				cuffia cremagliera idro Nissan DX Presea 90/94 - Sunny 1300/1500/1600/1800 90/93 - Sunny 1500/2000 4WD 94> - Sunny CALIFORNIA 90> - Pulsar 90> - AD 1300/1500 90>		
41X714	OCS				cuffia cremagliera idro Nissan SX Presea 90/94 - Sunny 1300/1500/1600/1800 90/93 - Sunny 1500/2000 4WD 91> - Sunny CALIFORNIA 90> - Pulsar 90> - AD 1300/1500 90>		
41X715	OCD				cuffia cremagliera idro Nissan DX Presea 95> - Sunny 1300/1500/1600/1800/2000 94> - Pulsar 95> -		
41X716	OCS				cuffia cremagliera idro Nissan SX Presea 95> - Sunny 1300/1500/1600/1800/2000 94> - Pulsar 95> -		
41X717	OCX				cuffia cremagliera idro Nissan Primera 91/95		
41X718	OCX				cuffia cremagliera idro Nissan Primera 95>		
41X719	OCD				cuffia cremagliera idro Nissan DX Sunny 1500 4WD fino al 94 - Sunny 2000 94/95		
41X720	OCS				cuffia cremagliera idro Nissan SX Sunny 1500 4WD fino al 94 - Sunny 2000 94/95		
41X721	OCD				cuffia crem. idro Nissan DX Villa 86/88-Pulsar 86/90		
41X722	OCS				cuffia crem. idro Nissan SX Villa 86/88-Pulsar 86/90		
41X723	OCD				cuffia crem. idro Nissan DX Sunny Pulsar 81/84		
41X724	OCS				cuffia crem. idro Nissan SX Sunny Pulsar 81/84		
41X725	OCX				cuffia cremagliera idro Nissan Cherry		
41X726	OCD				cuffia cremagliera idro Nissan DX Crew		
41X727	OCS				cuffia cremagliera idro Nissan SX Crew		
• 41X728	OCS				cuffia crem. idro termoplastico, SX/DX Nissan Micra 1.0 16V-1.3 16V 1992,1.5D 1998		
41X730	OCX				kit cuffie cremagliera (TRW) idro Laurel 2000 8486 / Bluebird 1,6 85/87 - 1800 man.-1800 83/87/2000 85-87 - MAXIMA 84/88 - PRAIRIE 85/88 - STANZA 85/91 kit cuffie cremagliera (TRW) idro Micra 85 - Violet-Auster-Stanza/1600-1800 81/83 Sunny - Lauret Sprint 81/84 - Prairie 1800 82/88 - Liverta Villa 1500/170082/84 - March 1000 80/92 - Figaro fino al 1991 - DATSUN 84/90 -		
41X731	OCX				kit cuffie cremagliera idro Nissan Crew 1994>		
41X732	OCX				kit cuffie cremagliera idro Nissan Bluebird 1600/1800 AUT - 2000 83/8 - Sunny 84/85 - Villa 84/86 - EXA 86		
41X733	OCX				kit cuffia cremagliera idro Nissan Presea 90/94 - Sunny 1300/1500/1600/1800 90/93 - Sunny 1500/2000 4WD 91> - Sunny CALIFORNIA 90> - Pulsar 90> - AD 1300/1500 90>		
41X734	OCX				kit cuffie cremagliera idro Nissan Presea 95>-Sunny 1300/1500/1600/1800/2000 94>-Pulsar 95>		
41X735	OCX				kit cuffie cremagliera idro Nissan Sunny 1500 4WD fino al 94 - Sunny 2000 94/95		
41X736	OCX						



Kit idroguida

Kits for power steering

Ремкомплекты для рулевого управления

Codice Code Код	Ref. Приме- нение	Ø crem. rack Ø	Ø distr. pinion Ø	Ø albero shaft Ø	Descrizione per utilizzo Use remarks Примечания	Cod. originale IDROGUIDA Оригинальный номер агрегата	Cod. originale KIT Оригинальный номер ремкомплекта
41X737	OCX				kit cuffie cremagliera idro Nissan Villa 86/88 – Pulsar 86/90 -		
41X738	OCX				kit cuffie cremagliera idro Nissan Sunny Pulsar 81/84		
41X739	OCX				kit cuffie cremagliera idro Nissan Crew		
• 41X740	OCX				Cuffia idro termoplastico SX/DX, Nissan Murano 2005, Maxima QX		
• 41X741	OCX				Cuffia idro termoplastico SX/DX, Nissan Almera dal 2000, Primera Berlina/Wagon dal 2001 in poi		
• 41X742	OCX				Cuffia idro termoplastico SX/DX, Nissan Micra dal 2002-'07, Micra C+C 2005		
• 41X743	OCS				Cuffia idro termoplastico SX, Nissan X-TRAIL dal 2003 in poi		
• 41X744	OCD				Cuffia idro termoplastico DX, Nissan X-TRAIL dal 2003 in poi		
• 41X745	OCX				Cuffia idro termoplastico DX/SX, Nissan Almera Tino 2000-'04, X-Trail dal 2003		
• 41X746	OCX				Cuffia idro termoplastico DX/SX, Nissan Pathfinder dal 2005, Navara Pick-up 2005-'07		
• 41X747	OCX				Cuffia idro termoplastico DX/SX, Nissan Qashqai dal 2007		
41X769	OCC				kit cuffie man. Nissan Bluebir		
41X770	OCC				kit cuffie man. Nissan Bluebir		
• 41XE900					Idroguida elettrica Nissan Micra 2003		
• 41XE901					Idroguida elettrica Nissan Sentra 2007 (USA)		

Opel - Vauxhall

42X

Codice Code Код	Ref. Приме- нение	Ø crem. rack Ø	Ø distr. pinion Ø	Ø albero shaft Ø	Descrizione per utilizzo Use remarks Примечания	Cod. originale IDROGUIDA Оригинальный номер агрегата	Cod. originale KIT Оригинальный номер ремкомплекта
42X001	VOK				ZF Opel Caddet, Calibra "90-91, Ascona "82-89 pignone 18mm, Cavalier	7836955103-7836974122	7836/1
42X002	VOK	24,00			ZF- Opel Vectra "94-95, crem. Ø24	7891955109/111	7891/1
• 42X002 Light		24,00			ZF - allegg. Opel Vectra '94-95, crem. Ø24		
42X003	VOK				ZF Opel Kaddet, Ascona "87-88-90 pignone Ø20, Calibra, Ascona "81-88, Kaddet"91, Vectra "00	7836955129/ 122/119/117/121/ 126/128/124/127/141/ 143/145/147/140/142/ 136/138	7836/6
42X003 Light					ZF- ALLEGGERITO Opel Kaddet, Ascona, Calibra 1981-91, Vectra '00, Cavalier		
42X004	VOK	28,00			Kit idro ZF Kadett, Ascona "88, Astra, Calibra"91-98, Vectra CDI "91-93, Astra GSI, crem Ø28	7836974160/ 162/173/132/154/ 163/144/158/ 169/179/189	7836/7
• 42X004 Light		28,00			ZF - allegg. Opel Astra, Cavalier, crem. Ø28		
42X005	VOK				ZF - Opel Vauxhall, Carlton	8052991111	8052/11
42X006	VOK				ZF- Opel Commodore, Monza, Record "77-78	8052955197/ 8052955201/ 8052955210	8052/24
42X007	VOK				ZF- Opel Omega "87-88, Omega 3000 "86-88	8052955243/ 236/245/249/ 251/252	8052/26
42X008	VOK				ZF- Opel Commodore, Monza, Record "84-86	8052955220/ 8052955221	8052/29

VOK Kit idroguida Power steering kit Ремкомплект рулевого управления
VOC Kit cremagliera Rack kit Ремкомплект гидроцилиндра
VOD Kit distributore Pignon kit Ремкомплект распределителя
VOP Kit pompa Pump kit Ремкомплект насоса
 OCD Cuffia destra Rack boot (right) Правый сайлентблок
 OCS Cuffia sinistra Rack boot (left) Левый сайлентблок
 OCX Cuffie sinistra+destra Rack boot (left+right) Набор сайлентблоков
 OCC Kit cuffie Rack boot kit Ремкомплект сайлентблоков



Codice Code Код	Ref. Приме- нение	Ø crem. rack Ø	Ø distr. pinion Ø	Ø albero shaft Ø	Descrizione per utilizzo Use remarks Примечания	Cod. originale IDROGUIDA Оригинальный номер агрегата	Cod. originale KIT Оригинальный номер ремкомплекта
42X009	VOK				ZF -Opel Senator"76-86 L262	8052955201	8052/35
42X010	VOK				ZF- Opel Omega "86	8052955234/ 8052955236	8052/39
42X011	VOK				ZF- Opel Omega Vauxhall- Carlton	8052955244	8052/40
42X012	VOK				Kit idro ZF- Opel Senator B "87-88/91	8052991107/ 8052991112/ 8052991116	8052/44
42X013	VOD				ZF -Opel Omega servotronic, Vauxhall	8052974118 8052974111	8052/50
42X014	VOK			32,00	Opel Frontera, Ø32		8970299450
42X015	VOK				Saginaw Opel Astra , Vectra, Calibra "89		
42X016	VOK	22,00			Opel Corsa Saginaw, crem. Ø22		8361
42X016 Light		22,00			allegg. Opel Corsa Saginaw, crem. Ø22		
42X017	VOK	25,00			Saginaw Opel Astra, Vectra "92, crem. Ø25		
42X018	VOK	25,00			Saginaw Opel Vectra B "96-02, crem. Ø25		
42X019	VOK	25,00			Kit idro Saginaw Opel Astra, Vectra "92, con paraoli alta temp., crem. Ø25		
42X020	VOK	25,00			Saginaw - Opel Sintra, Daewoo Leganza "97-02, Nexus, crem. Ø25		
42X021	VOK	28,00			ZF -Opel Astra 95, crem. Ø28	7836974160	7836/7
42X022	VOK				Opel Victor Fe		
42X023	VOK	24,00			ZF -Opel Vectra B , Octavia "96, crem. Ø24	1J1422105DEADB	7891/3
42X024	VOK	27,00			Opel Frontera U.T."99, crem.Ø27		
42X025	VOK	22,00			Saginaw-Opel Tigra, Combo, Corsa "93, crem. Ø22		
42X026	VOK	25,00			TRW -Opel Astra G 1998,Zafira, crem. Ø25,(electric pump)		
42X027	VOK				ZF- Opel Omega "95		8073/001
42X028	VOK	25,00			Saginaw- Opel Zafira, "98, crem. Ø25		
42X029	VOK				ZF- Opel Omega con servotronic	8052991121	8052/049
42X030	VOK				a settore Opel Omega TIPO B		
42X031	VOK				Saturn "91-97		
42X032	VOK				Kit idro Saturn L, LS1, LS2, LW1, LW2 "00-02		
42X033	VOK	30,00			GMC Envoy, Chevy Trailb., "02-03 , crem.Ø30		
42X034	VOK				Opel Omega, Vauxhall		
42X035	VOK	27,00			Koyo Opel Movano Van, Frontera , fino al "99, crem Ø27		
42X036	VOK	25,00			kit idro TRW -Opel Zafira, crem. Ø25		0250080018001
42X037	VOK	27,70			Opel Astra, Vectra , Calibra "91 crem. Ø27,7, Koyo kit idro KOYO Opel Vivaro 1.9D, 1.9DTI, 2.1, 2.5 DTI "08-01, crem Ø27,7		
42X038	VOK	27,70			TRW- Opel Astra "98-02, Zafira, crem.Ø28		
42X039	VOK	28,00			TRW- Opel Astra "98-02, Zafira, crem.Ø28		
42X040	VOK	32,00			Chevy Colorado 4WD,GMC Canyon , crem. Ø32		
42X041	VOK	25,00			TRW Opel Vectra C, crem. Ø25		
42X042	VOK	25,00			Opel Vectra C Delphi, crem. Ø25		
42X043	VOK	25,00			TRW -Opel Vectra C, crem.Ø25		
• 42X044	VOK	24,00			Opel Astra H, crem. Ø24		
• 42X045					Kit riparazione piantone Opel Corsa C/D,(sfere acciaio + spina cilindrica)		
42X600	VOP				Opel Astra,un paraolio dis. 1PM Øi 20 e un paraolio dis. 1PM Ø11,75		
42X601	VOP				Opel Frontera, un paraolio dis. 1PM Øi 20 e un paraolio dis. 1PM Øi 11,75		
42X602	VOP				Chevy Cavalier "95-03, Saturn "00-02		



Kit idroguida

Kits for power steering

Ремкомплекты для рулевого управления

Codice Code Код	Ref. Приме- нение	Ø crem. rack Ø	Ø distr. pinion Ø	Ø albero shaft Ø	Descrizione per utilizzo Use remarks Примечания	Cod. originale IDROGUIDA Оригинальный номер агрегата	Cod. originale KIT Оригинальный номер ремкомплекта
42X603	VOP			19,05	Chevy Camarro '93-97, albero Ø19,05		
42X604	VOP				Chevy Impala, Caprice '94-96		
42X605	VOP			15,00	ZF - Opel Vectra B DI 16V D. '95, albero Ø15		7612/002
42X606	VOP				Vauxall Monterey		
42X607	VOP				Opel Vectra B , Kayaba		
42X608	VOP			16,00	Saginaw Opel Vectra 2.2 dal 2002, albero Ø16		
• 42X609	POM			17,00	pompa Opel Frontera B 1998-'04, Kayaba cuffie cremagliera (TRW) manuale Ascona 66-73 / KADETT 73-79/MANTA 66-73 / Cavalier 75-81 / CHEVETTE 75-84		
42X701	OCX				cuffie cremagliera (TRW) manuale Ascona 79- / KADETT 79- / MANTA 79-/Cavalier 81-		
42X702	OCX				cuffie cremagliera (TRW) idro Astra 82- Calibra 91- Cavalier 89/96		
42X703	OCX				cuffie cremagliera ZF manuale Calibra 91-		
42X704	OCX				cuffie cremagliera (TRW) idro Vectra B 96>		
42X706	OCX				cuffie cremagliera (TRW) idro Vectra B 96>		
42X707	OCX				cuffie cremagliera (TRW) idro Astra 79/92 – Vectra 88> - Cavalier 83/96		
42X708	OCX				cuffie cremagliera idro ZF Astra 79/92 - Vectra 88/91> GENIO		
42X709	OCX				cuffie cremagliera idro Saginaw Astra 79/92 - Vectra A 88/96 - Cavalier 89 - Vauxall		
42X710	OCX				cuffie cremagliera idro Saginaw Astra 79/92 – Calibra 91>		
42X711	OCX				cuffie cremagliera idro Tigrà 95>		
42X712	OCX				cuffie cremagliera idro Astra 92>		
42X713	OCX				cuffie cremagliera idro Astra (centrale)		
42X714	OCX				cuffie cremagliera idro Astra - Cavalier		
42X715	OCX				cuffie cremagliera (TRW) idro Astra 92- / Cavalier 89-		
42X716	OCX				cuffie cremagliera (TRW) manuale cam Victor 71-81 / VIVA HB / HC 71-81 Vauxall		
42X717	OCX				cuffie cremagliera (TRW) manuale SX (burman) VIVA HB Vauxall		
42X718	OCS				cuffie cremagliera (TRW) manuale DX (burman) VIVA HB Vauxall		
• 42X719	OCD				cuffia SX OPEL VECTRA		
• 42X720	OCS				cuffia DX Opel Vectra		
• 42X721	OCD				cuffia idro termoplastico SX/DX, Opel Frontera B		
• 42X722	OCX				cuffia idro termoplastico SX/DX, Opel Astra H '05, Astra Coupe G 1998-'05, Zafira A 1999-'04, Vauxhall, Zafira B dal 2005		
• 42X723	OCX				cuffia idro termoplastico SX/DX, Opel Corsa 2000-'05, Tigra Twin top 2004 in poi		
• 42X724	OCX				cuffia idro termoplastico SX/DX, Opel Meriva dal 2003 in poi		
• 42X725	OCX				cuffia idro termoplastico SX/DX, Opel Agila 2003-'06		
• 42X726	OCX				cuffia idro termoplastico SX/DX, Opel Astra H Berlina dal 2004, Astra H Wagon dal 2004-'06		
• 42X727	OCX				cuffia idro termoplastico SX/DX, Opel Signum dal 2003		
• 42X728	OCX				cuffia crem. termoplastico SX/DX Opel Corsa D dal 2006 in poi		
• 42X729	OCX						

VOK Kit idroguida Power steering kit Ремкомплект рулевого управления
VOC Kit cremagliera Rack kit Ремкомплект гидроцилиндра
VOD Kit distributore Pignon kit Ремкомплект распределителя
VOP Kit pompa Pump kit Ремкомплект насоса
OCD Cuffia destra Rack boot (right) Правый сайлентблок
OCS Cuffia sinistra Rack boot (left) Левый сайлентблок
OCX Cuffie sinistra+destra Rack boot (left+right) Набор сайлентблоков
OCC Kit cuffie Rack boot kit Ремкомплект сайлентблоков



Codice Code Код	Ref. Приме- нение	Ø crem.	Ø distr.	Ø albero	Descrizione per utilizzo Use remarks Примечания	Cod. originale IDROGUIDA Оригинальный номер агрегата	Cod. originale KIT Оригинальный номер ремкомплекта
		rack Ø	pinion Ø	shaft Ø			
Размеры							
• 42X730	OCS				cuffia crem. termoplastico SX Opel Agila B dal 2008		
42X800					Pompa Genuine Opel Vectra GM		
• 42X807	TRW				Pompa elettrica Opel Astra G/Zafira, + kit cremag.	OE 93172042- 93172043 1609125- 1609126	
• 42X808	TRW				Pompa elettrica Opel Astra G/Zafira	OE 5948001-594009	
• 42X809	TRW				Pompa elettrica TRW Opel Signum/Vectra C	OE 93172789- 93183550 5948007- 5948073	
• 42X810	TRW				Pompa elettrica TRW Opel Signum/Vectra C	OE 93183575- 5948074	
• 42X811	TRW				Pompa elettrica Opel Astra H/Zafira, 1.6,1.8 '05	OE 93179568- 5948067	
• 42X812	TRW				Pompa elettrica Opel Astra G 1.7 DTI,2.0 16V, Zafira 2.2 16V, + kit cremag.	OE 93172042- 1609125	
• 42X813	TRW				Pompa elettrica Opel Astra G, 2.0 16V,2.0 OPC, Zafira 2.0 OPC 01 >06.05, + kit cremag.	OE 93172044- 1609127	
• 42X814	TRW				Pompa elettrica Opel/GM, Opel Insigna	AD13273784	
• 42X815					Pompa elettrica Opel/GM	AB13273782/4	
• 42X816	ZF				pompa elettrica Astra H ZF	OE 5948070	
• 42X817	TRW				Pompa elettrica TRW Opel Signum/Vectra C completa di idroguida	OE 93183575- 5948074	
• 42XE900					Idroguida elettrica Opel Corsa		
• 42XE901					Idroguida elettrica Opel Corsa 1998		
• 42XE902					Idroguida elettrica Opel Agila 2002		
• 42XE903					Idroguida elettrica Opel Corsa 2006		
• 42XE904					Idroguida elettrica Opel Meriva 2004		
• 42XE905					Idroguida elettrica Opel Corsa D 2009 senza ESP		
• 42XE906					Idroguida elettrica Opel Corsa D 2009 con ESP		

Peugeot - Citroën

16X

Codice Code Код	Ref. Приме- нение	Ø crem.	Ø distr.	Ø albero	Descrizione per utilizzo Use remarks Примечания	Cod. originale IDROGUIDA Оригинальный номер агрегата	Cod. originale KIT Оригинальный номер ремкомплекта
		rack Ø	pinion Ø	shaft Ø			
Размеры							
16X001	VOD				Peugeot 205, 309, 405 1S, con un paraolio dis. 1 PM Øi 22,2 e un paraolio dis. 1PM Øi 29,4		
16X002	VOD				TRW - Peugeot 106, 306, 406, 205 U.T dal '96, R.Megane, ClioKit distributore Peugeot 205, 309, 405 1S, con un paraolio dis. 1 Øi 19,05 e un paraolio dis.9 Øi 28		
16X003	VOD				Citroen, Peugeot con un paraolio dis. 1PM Øi 29,4 e un paraolio dis.1PM Øi 20		
16X004	VOD				ZF - Peugeot 505 '79/84, 504, 604, 605 '89-99 con un paraolio dis. 1PM Øi 27,8 e un paraolio dis.1PM Øi 22,2		
16X005	VOD				Peugeot 405 con un paraolio dis. 1PM Øi 29,4 e un paraolio dis.1PM Øi 20		
16X006	VOK	28,00			TRW - Peugeot 806, crem. Ø28		
16X007	VOK	26,00			ZF - Peugeot 406 Servotronic, '95, crem. Ø26	7832993106/107	7832/16
16X008	VOK				Citroen Pallas DS e FG '73		
16X009	VOK	24,00			Peugeot 206 2° serie, crem. Ø24		



Kit idroguida

Kits for power steering

Ремкомплекты для рулевого управления

Codice Code Код	Ref. Приме- нение	Ø crem. rack Ø	Ø distr. pinion Ø	Ø albero shaft Ø	Descrizione per utilizzo Use remarks Примечания	Cod. originale IDROGUIDA Оригинальный номер агрегата	Cod. originale KIT Оригинальный номер ремкомплекта
16X010	VOK	24,00			Saxo U.T, Peugeot 206, crem. Ø24		
16X011	VOD				C. Berlingo con due paraoli Øi 29,4 e un paraolio dis.1PM Øi 22		
16X012	VOK				Citroen CX		
16X013	VOD				Citroen Xara Citroen Berlingo con due paraoli Øi 20 e un paraolio dis.0M Øi 29		
16X014	VOK	28,00			ZF - Jumper, crem. Ø28	7852974431	7852/507
16X015	VOK	30,00			TRW - Jumper, crem. Ø30		
16X016	VOK	28,00			Citroen Jampy, crem. Ø28		
16X017A	VOK	24,00			Peugeot 307, crem. Ø24		
16X018	VOK	26,00			ZF - Peugeot 406 dal '95, crem. Ø26		
16X019	VOK	24,00			ZF - Peugeot 206, crem. Ø24		
16X020	VOK	24,00			TRW - Peugeot 206 '98, crem. Ø24		
16X021	VOD				TRW - Peugeot 106 , Citroen Saxo '96 con un paraolio dis.1PM Øi 19,05 e un paraolio dis.0M Øi 23,35	34008941	
16X022	VOK	26,00			ZF - Peugeot 607, Citroen C5 '01, crem. Ø26		
16X023	VOK	24,00			TRW - Peugeot 206 '98, Peugeot 307 dal 2001 crem. Ø24		
16X024	VOK	24,00			ZF - Peugeot 206, crem. Ø24		
16X025	VOK	26,00			TRW - Peugeot 406, crem. Ø26		8951F88
16X026	VOD				ZF - Citroen XM '96-00, BX '83, Xantia '93 con un paraolio dis.1PM Øi 29,4 e un paraolio dis.1PM Øi 20 ZF - P.306, P.309, Picasso 99, C15, Xsara 96-03, R11 con un paraolio dis.1PM Øi 29,4 e un paraolio dis.1PM Øi 22,2	2895	
16X027	VOD						
16X028	VOK	27,70			Peugeot 407, crem. Ø27,7		
16X029	VOK	26,00			ZF - Peugeot 607 2.0/2.21 Hd '00, crem. Ø26		
16X601	VOP			15,00	Kit pompa Citroen Tandem, Xantia 3 uscite		
16X602	VOP				Citroen		
16X603	VOP			15,00	Peugeot 406 '99-04, Citroen Sinergy, albero Ø15		
16X604	VOD			15,00	Xantia 2 uscite, albero Ø15		
16X701	OCX				Cuffia idro termoplastico SX/DX Peugeot 107 dal 2005		
16X702	OCS				Cuffia idro SX termoplastico Peugeot 405		
16X703	OCX				Cuffia idro manuale termoplastico SX/DX Peugeot 206 1998/08		
16X704	OCD				cuffia crem. manuale diam.20 c/plastica 106 MOTORE 1300 91-		
16X705	OCS				cuffia idro manuale SX termoplastico Peugeot 106 dal 1996		
16X706	OCX				cuffia crem. Manuale SX/DX Peugeot 104 1972-'88, P.305 1981-'83, P. 504 1968-83, P.604 1977-'87		
16X707	OCX				cuffia crem. idro 405 / Citroen Bx		
16X708	OCD				cuffia crem. manuale SX Peugeot 504		
16X709	OCS				cuffia crem. manuale DX Peugeot 504		
16X710	OCD				cuffia crem. idro DX 505 1993-		
16X711	OCX				cuffia crem. idro 505 1993- c/rinforzo metallo		
16X712	OCD				cuffia crem. idro DX - AX 900/1100 1986-		
16X713	OCD				cuffia crem. idro DX - AX 1300cc 1986		
16X714	OCD				cuffia crem. idro DX Peugeot 205 1983>-305 1982>-306-309 1985>		

VOK Kit idroguida Power steering kit Ремкомплект рулевого управления
VOC Kit cremagliera Rack kit Ремкомплект гидроцилиндра
VOD Kit distributore Pignon kit Ремкомплект распределителя
VOP Kit pompa Pump kit Ремкомплект насоса
OCD Cuffia destra Rack boot (right) Правый сайлентблок
OCS Cuffia sinistra Rack boot (left) Левый сайлентблок
OCX Cuffie sinistra+destra Rack boot (left+right) Набор сайлентблоков
OCC Kit cuffie Rack boot kit Ремкомплект сайлентблоков



Codice Code Код	Ref. Приме- нение	Ø crem. rack Ø	Ø distr. pinion Ø	Ø albero shaft Ø	Descrizione per utilizzo Use remarks Примечания	Cod. originale IDROGUIDA Оригинальный номер агрегата	Cod. originale KIT Оригинальный номер ремкомплекта
16X715	OCS				cuffia crem. idro SX Peugeot 205 1983>-3051982 >-306-309 1985>		
16X716	OCD				cuffia crem. idro DX 405 fino al 1992		
16X717	OCS				cuffia crem. idro DX 405 fino al 1992		
16X718	OCX				cuffia crem. idro 405		
16X719	OCD				cuffia crem. idro DX Peugeot 405 1993>		
16X720	OCS				cuffia crem. idro SX Peugeot 405 1993>		
16X721	OCD				cuffia crem. idro DX Peugeot 405		
16X722	OCS				cuffia crem. idro SX Peugeot 405		
16X723	OCX				cuffia crem. idro Peugeot 406 1993>		
16X724	OCS				cuffia crem. idro SX Peugeot 505 1993 >		
16X725	OCD				cuffia crem. idro DX Peugeot 605 fino al 1994		
16X726	OCS				cuffia crem. idro SX Peugeot 605 fino al 1994		
16X727	OCX				cuffia crem. idro SX Peugeot 605 /95 >		
16X728	OCX				cuffia crem. idro Peugeot 806 fino al 1994 > (Y605commerciale)		
16X729	OCD				cuffia crem. idro DX Peugeot Boxer (commerciale)		
16X730	OCS				cuffia crem. idro SX Peugeot Boxer (commerciale)		
16X731	OCD				cuffia crem. idro DX Peugeot 405		
16X732	OCS				cuffia crem. idro SX Peugeot 405		
16X733	OCX				cuffia crem. idro Peugeot 106		
16X734	OCX				cuffia crem. idro Peugeot Partner		
16X735	OCX				Cuffia crem. Peugeot 206		
16X736	OCX				cuffia crem. idro Peugeot 106		
16X737	OCX				cuffia crem. idro Peugeot 406		
16X738	OCX				Cuffia idro termoplastico SX/DX Citroen C8, Peugeot 807dal 2002		
16X739	OCS				cuffia crem. idro SX Citroen AX 1300		
16X740	OCD				cuffia crem. idro DX Citroen Saxo 1995 >		
16X741	OCS				cuffia crem. idro SX Citroen AX 900/1100 1986, Saxo 1995		
16X742	OCD				cuffia crem. idro DX Citroen Saxo		
16X743	OCS				cuffia crem. idro SX Citroen Saxo		
16X744	OCD				cuffia crem. idro SX Citroen Bx 1580/1905/DIESEL fino a 11/83-BX 1600/1800/1900 dal 1982 in poi		
16X745	OCS				cuffia crem. idro DX Citroen Bx 1580/1905/DIESEL fino a 11/83-BX 1600/1800/1900 dal 1982 in poi		
16X746	OCX				cuffia crem. idro DX/SX Citroen CX 1974 in poi		
16X747	OCD				cuffia crem. idro DX Citroen XM 1989 in poi		
16X748	OCS				cuffia crem. idro SX Citroen XM 1989 in poi		
16X749	OCD				cuffia crem. idro DX Citroen Xantia CH 6778 1993 in poi		
16X750	OCS				cuffia crem. idro SX Citroen Xantia CH 6778 1993 in poi		
16X751	OCX				cuffia crem. idro SX/DX Citroen Xantia CH 6778 1993 in poi		
16X752	OCX				cuffia crem. idro SX/DX Citroen Xantia		
16X753	OCD				cuffia crem. idro DX Citroen ZX 1991 in poi		
16X754	OCS				cuffia crem. idro SX Citroen ZX 1991 in poi		
16X755	OCD				cuffia crem. idro DX Citroen C 25		
16X756	OCS				cuffia crem. idro SX Citroen C 25		
16X757	OCX				cuffia crem. idro DX/SX Citroen Saxo		
16X758	OCX				cuffia crem. idro Citroen Xara		



Kit idroguida

Kits for power steering

Ремкомплекты для рулевого управления

Codice Code Код	Ref. Примечание	Ø crem. rack Ø	Ø distr. pinion Ø	Ø albero shaft Ø	Descrizione per utilizzo Use remarks Примечания	Cod. originale IDROGUIDA Оригинальный номер агрегата	Cod. originale KIT Оригинальный номер ремкомплекта
16X759	OCX				Cuffia idro manuale SX/DX Peugeot 104 1972-'88		
16X760	OCC				Kit cuffie crem. idro AX 900/1100 1986, Citroen Saxo 1995		
16X761	OCC				Kit cuffie crem. idro Citroen AX 1300		
16X762	OCC				Kit cuffie crem. idro 505 1993>Y639		
16X763	OCC				Kit cuffie crem. idro Peugeot 605 fino al 1994		
16X764	OCC				Kit cuffie crem. idro Peugeot Boxer (commerciale)		
16X765	OCC				Kit cuffie crem. idro Peugeot 405		
16X766	OCC				Kit cuffie crem. idro Peugeot 205 1983>-305 1982 >- 306-309 1985>		
16X767	OCC				Kit cuffie crem. idro 405 fino al 1992		
16X768	OCC				Kit cuffie crem. idro Peugeot 405 1993>		
16X769	OCC				Kit cuffie crem. idro Peugeot 405		
• 16X770	OCX				cuffia crem. idro termoplastico SX/DX Citroen C5 Berlina dal 2004		
16X771	OCC				Kit cuffie crem. idro Citroen Saxo		
16X772	OCC				Kit cuffie crem. idro Citroen Bx 1580/1905/DIESEL fino a 11/83-BX 1600/1800/1900 dal 1982 in poi		
16X773	OCC				Kit cuffie crem. idro Citroen XM 1989 in poi		
16X774	OCC				Kit cuffie crem. idro Citroen Xantia CH 6778 1993 in poi		
16X775	OCC				Kit cuffie crem. idro Citroen ZX 1991 in poi		
16X776	OCC				Kit cuffie crem. idro Citroen C 25		
16X784	OCS				Cuffia idro termoplastico SX Peugeot 407/407 SW, dal 2004		
16X785	OCX				Cuffia idro termoplastico SX/DX Peugeot 406 Coupè dal 1998-'04		
• 16X794	OCX				Cuffia idro manuale SX/DX, Peugeot 206		
• 16X795	OCX				Cuffia idro termoplastico SX/DX, Peugeot 206/206SW, 1998-'08		
• 16X796	OCX				Cuffia crem. idro termoplastico Peugeot 407		
• 16X797	OCD				cuffia crem. idro SX Peugeot I-II serie		
• 16X798	OCD				Cuffia idro SX Peugeot 306, Patner, Xara Picasso		
• 16X799	OCD				Cuffia idro DX termoplastico Peugeot 405		
• 16X821					Pompa elettrica TRW Citroen C4 2004, C4 Picasso 2006	OE 9684040180-9684252580	
• 16X822					Pompa elettrica HPI Peugeot 106, con serbatoio doppio attacco orizz.	OE 40079C	
• 16X823					Pompa elettrica HPI Citroen Saxo, con serbatoio doppio attacco vert.	OE 4007CC	
• 16X824					Pompa elettrica HPI Peugeot 307, Citroen C4	OE 4007ST	
• 16X825					Pompa elettrica HPI Peugeot Patner, Citroen Jumpy, Fiat Scudo	OE 4007KM	
• 16X826					Pompa elettrica HPI Peugeot 407	OE 4007GC - 4007GE - 4007GH	
• 16X827					Pompa elettrica HPI Citroen Saxo	OE 40071E J5090192	
• 16X828					Pompa elettrica TRW Citroen, Picasso U.T.	OE 9686207180	
• 16X829					Pompa elettrica TRW Peugeot	T7-65C OE 9686207080	
• 16X830					Pompa elettrica TRW, Peugeot	GEP71C OE 9685418680	
• 16X831					Pompa elettrica TRW, PSA Peugeot, Citroen, Picasso U.T.	OE 9686207180 GEP58C	

VOK Kit idroguida	Power steering kit	Ремкомплект рулевого управления	OCD Cuffia destra	Rack boot (right)	Правый сайлентблок
VOC Kit cremagliera	Rack kit	Ремкомплект гидроцилиндра	OCS Cuffia sinistra	Rack boot (left)	Левый сайлентблок
VOD Kit distributore	Pignon kit	Ремкомплект распределителя	OCX Cuffie sinistra+destra	Rack boot (left+right)	Набор сайлентблоков
VOP Kit pompa	Pump kit	Ремкомплект насоса	OCC Kit cuffie	Rack boot kit	Ремкомплект сайлентблоков



Codice Code Код	Ref. Приме- нение	Ø crem. rack Ø	Ø distr. pinion Ø	Ø albero shaft Ø	Descrizione per utilizzo Use remarks Примечания	Cod. originale IDROGUIDA Оригинальный номер агрегата	Cod. originale KIT Оригинальный номер ремкомплекта
		Размеры					
• 16X832					Pompa elettrica TRW , PSA Peugeot	OE 9688005080 GEP71C	
• 16X833					Pompa elettrica HPI Citroen C15 Berlingo, con serb. a beccuccio	OE 400753 J5088439+A - 906265480	
• 16X834					Pompa elettrica TRW	GEP65C 9685418780	
• 16X835					Pompa elettrica HPI Peugeot 205 II		J5083585 - 4007R2
• 16X836					Pompa elettrica HPI Peugeot 206 SW 1,6 HDI	OE 4007NX	
• 16XE900					Idroguida elettrica Citroen C1 (2006)		
• 16XE901					Idroguida elettrica Citroen C3 2 3/4 giri (2006)		
• 16XE902					Idroguida elettrica Citroen C2 3 giri (2003)		

Martinetti idraulici

Hydraulic jacks
Гидроцилиндры к рулевым рейкам



11132

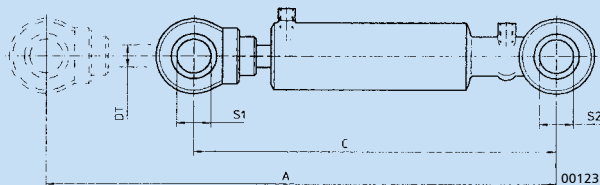

MARTINETTO CON ATTACCHI EQUIDISTANTI

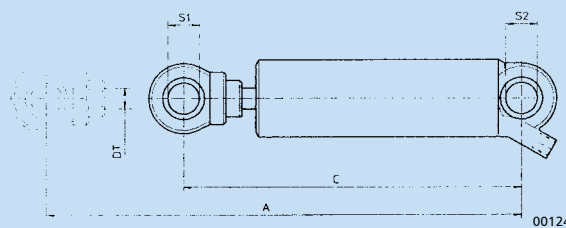

MARTINETTO CON ATTACCHI POSTERIORI

Codice Code Код	Min Ord Мин. количе- ство заказа	Dis. Тип	S1	S2	DT	C	A	Descrizione per utilizzo Use remarks Примечания
			Размеры					
16X901	2	2	12,00	12,00	12,00	265,00	405,00	Citroën ZX-Berlingo/ZX16V TD-Xsara
16X902	2	2	12,00	12,00	12,00	265,00	405,00	Peugeot 205-306-309 - lungh. 213 mm
16X904	2	2	12,00	12,00	12,00	270,00	400,00	Peugeot 205 GTI TD/309 GTI 16V
16X910	2	1	12,00	12,00	12,00	275,00	410,00	Peugeot 106 / Ciotren Saxo (attacco olio equidistanti)
16X912	2	2	12,00	12,00	12,00	280,00	440,00	Peugeot 405 Diesel/TD/MI16
16X908	2		12,00	12,00	12,00	305,00	470,00	Peugeot 605 (universale)
16X911	2		12,00	12,00	12,00	305,00	470,00	Peugeot 406 lungh. 245 mm
16X906	2	2	12,00	12,00	12,00	320,00	510,00	Peugeot 504-505-604 distributore in ghisa
16X913	2	1	12,00	12,00	12,00	330,00	470,00	Citroën Saxo
16X905	2	2	12,00	12,00	17,70	280,00	435,00	Citroën BX distributore ghisa (universale) (DIST. G)
16X903	2	2	12,00	12,00	18,00	280,00	435,00	Citroën BX distributore alluminio/Peugeot 405 - lungh. 227 mm (DISTR. A)
16X907	2	2	12,00	12,00	23,00	300,00	450,00	Citroën Xantia lungh. 253 mm
16X909	2	2	12,00	12,00	23,20	305,00	470,00	Citroën XM (universale) lungh. 258 mm



Kit idroguida

Kits for power steering

Ремкомплекты для рулевого управления

Porsche

45X

Codice Code Код	Ref. Приме- нение	Ø crem. rack Ø	Ø distr. pinion Ø	Ø albero shaft Ø	Descrizione per utilizzo Use remarks Примечания	Cod. originale IDROGUIDA Оригинальный номер агрегата	Cod. originale KIT Оригинальный номер ремкомплекта
45X001	VOK				ZF - Porsche 928S,928 '80-94	7840955112,3,4	7840/3
45X002	VOK	22,00			ZF - Porsche 944 1986-90,924S 1986-88, crem. Ø22	7840955200/ 7840974201/ 7840955201/ 7840955202	7840/4 7840/5
45X003	VOK				Kit ZF - Porsche 924S '86-88, 945 '83 (con par. Ø22x31)	7830974113	7830/6
45X004	VOK	26,00			Kit idro ZF - Porsche 911, 964 turbo '88-94, crem. Ø26	7840955119	7840/7
45X005	VOK	26,00			ZF - Porsche 911, 924, 993 turbo, Carrera '93, crem. Ø26	7832955169	7832/10
45X006	VOK				ZF - Porsche	7820955114	7820/101
45X007	VOK				ZF - Porsche 911 '89	7810955112	7810/105
45X008	VOK				ZF - Porsche 944 '83, 945	7830955101	7830/1
45X009	VOK				ZF - Porsche 924S, 944 '86-88	7830974106	7830/4
45X010	VOK				ZF - Porsche 911, 964 '89-97		
45X011	VOK	25,00			TRW - Porsche 911 '96-98/99, crem Ø25		
45X012	VOK				ZF - Porsche 944S '86-88		7830/4
45X013	VOK	25,00			TRW - Porsche, Carrera 911 '96,Boxster 986 '96, crem Ø25		
45X600	VOP			19,05	Porsche, albero Ø19,05		
• 45X701	OCX				Cuffia idro termoplastico SX/DX, Porsche Cayenne dal 2002 in poi		

Renault

46X

Codice Code Код	Ref. Приме- нение	Ø crem. rack Ø	Ø distr. pinion Ø	Ø albero shaft Ø	Descrizione per utilizzo Use remarks Примечания	Cod. originale IDROGUIDA Оригинальный номер агрегата	Cod. originale KIT Оригинальный номер ремкомплекта
46X001	VOC	24,00			R18, Espace , paraolio disegno 4 acciaio, crem.Ø24		
46X002	VOC	25,00			SMI, R19 '88-96, R11 '83-89, R21, Clio, Espace, Express, crem. Ø25		
46X003	VOC	25,00			R19, Clio, R21, GTS, Espace III Serie, crem. Ø25		
46X004	VOD				R20, R25, R30, '84		
46X005	VOD				Clio, Bendix , Trafic		
46X006	VOD				R18 Ghisa		
46X007	VOD				Espace, con paraolio Ø29, 4 dis.9		
46X008	VOD				Clio, R21, GTS, '90-93		
46X009	VOD				Clio, con un paraolio dis. 0M Øi 28, 5 e un paraolio dis.1PM Øi 18		
46X010	VOD				Kit distr. R21 '86/94, R.Clio '90/98, con un paraolio dis. 0M Øi 28 e un paraolio dis.1PM Øi 18		
46X011	VOD				Kit distr.R11, R19, R21, R25, Traffic, Super 5, con un paraolio dis.0M Øi 28, 5 e un paraolio dis.1PM Øi 19		
46X012	VOK				R21 TXE , Nevada , cilindrata 2000, con un paraolio dis.7V2 Øi 23 e un paraolio dis. 1PM Øi18		
46X013	VOK				R19 1995, R21, con un paraolio dis.7V2 Øi 23 e un paraolio dis. 1PM Øi18		
46X014	VOK	25,00			R Clio, R21 GTS 1986/90 , Espace 2000 1992/93, crem. Ø25		
46X015	VOK	25,00			R Clio, R21 GTS 1988/93, crem. Ø25		

VOK Kit idroguida Power steering kit Ремкомплект рулевого управления
VOC Kit cremagliera Rack kit Ремкомплект гидроцилиндра
VOD Kit distributore Pignon kit Ремкомплект распределителя
VOP Kit pompa Pump kit Ремкомплект насоса
 OCD Cuffia destra Rack boot (right) Правый сайлентблок
 OCS Cuffia sinistra Rack boot (left) Левый сайлентблок
 OCX Cuffie sinistra+destra Rack boot (left+right) Набор сайлентблоков
 OCC Kit cuffie Rack boot kit Ремкомплект сайлентблоков



Codice Code Код	Ref. Приме- нение	Ø crem. rack Ø	Ø distr. pinion Ø	Ø albero shaft Ø	Descrizione per utilizzo Use remarks Примечания	Cod. originale IDROGUIDA Оригинальный номер агрегата	Cod. originale KIT Оригинальный номер ремкомплекта
46X016	VOK				R21 Diesel 1986/94, con un paraolio dis.7V2 Øi 23 e un paraolio dis. 1PM Øi18		
46X017	VOK	25,00			Sml-Koyo R. Laguna, crem. Ø25		
46X018	VOK	25,00			Sml R. Safrane 1993, crem. Ø25		
46X019	VOK	25,00			Kit idro Sml R.Megane crem.Ø25, un paraolio dis. 6 e uno dis. 7		
46X020	VOK	25,00			Sml R25 1988, crem. Ø25		
46X021	VOK	30,00			Kit idro TRW Renault Master, Transporter (boccole acciaio), crem. Ø30		
46X022	VOK	30,00			TRW R.Master, Jampy, (boccole plastica), crem.Ø30	15000652/673/779/ 15001067/068/210/ 950/801	
46X023	VOK	25,00			Renault Traffic 1°serie, crem.25		
46X024	VOK	24,00			R. Megane 1°serie, crem. Ø24, con un paraolio H7, 5 e uno H 8, 5		
46X024A	VOK	24,00			R. Megane 1 ° serie, crem. Ø24, due paraoli dis.7 H8, 5		
46X025	VOK	24,00			R. Megane 2°serie, Scenic, crem. Ø24, due paraoli dis.7 H7, 5		
46X026	VOK	24,00			R. Megane III° serie, crem. Ø24		
46X027	VOK	23,00			TRW R.Megane Coupè, crem. Ø23		
46X028	VOD				R. Espace, con un paraolio dis.9 Øi 28 e un paraolio dis.1PM Øi 22, 2		
46X029	VOK	25,00			R. Espace, crem. Ø25, con paraolio disegno 7 Øe 37		
46X030	VOK	25,00			R. Espace, crem. Ø25, con paraolio dis. 7 Øe 38,2		
46X031	VOK				Renault 18 distributore ghisa		
46X032	VOK	25,00			Renault Trafic II° serie, crem. Ø 25		
46X033	VOD				Kit distributore R19, con un paraolio dis.1PM Øi 29, 4 e un paraolio dis.1PM Øi 18		
46X034	VOK	25,00			Renault Kango I°serie, paraolio distributore superiore Øe 32, crem.25		
46X035	VOK	25,00			Renault Kango II°serie, paraolio distributore inferiore Ø28, crem. Ø25		
46X036	VOK	25,00			Renault Kango III°serie, paraolio distributore superiore Øe 30, crem.25		
46X037	VOK	25,00			Renault Kango IIII°serie, crem. Ø25		
46X038	VOK	25,00			Renault Trafic III° serie, crem. Ø25		
46X039	VOK	24,00			Renault Clio U.tipo, crem. Ø24		
46X040	VOK	27,70			Sml Renault Master, 2 paraoli dis. 7, crem.Ø27, 7		
46X041	VOK	24,00			Koyo Renault 19, crem. Ø24		
46X042	VOK	24,00			Koyo Renault Clio, crem. Ø24		
46X043	VOK	24,00			Koyo Renault Scenic, crem. Ø24		
46X044	VOK	27,70			Koyo Renault Espace, R.Master 1997/02, crem. 27, 7		
46X045	VOK	25,00			Sml R.19, Clio 1994, crem. Ø25		
46X046	VOK	24,00			Kit idro SMI, R. Scenic, R.Megane 1999,R.Clio,Kangoo, crem. Ø24		
46X047	VOD				Kit distr Koyo R Clio 1991/94, pignone Renault Traffic		
46X048	VOK	25,00			TRW Renault Chamade 1989, crem. Ø25		
46X049	VOK				Sml/Bendix, R. Espace, R25 pignone ZF		
46X050	VOK	25,00			Sml-Koyo Renault Espace, crem. Ø25		
46X051	VOK				Koyo Renault Traffic 1989		



Kit idroguida

Kits for power steering

Ремкомплекты для рулевого управления

Codice Code Код	Ref. Приме- нение	Ø crem. rack Ø	Ø distr. pinion Ø	Ø albero shaft Ø	Descrizione per utilizzo Use remarks Примечания	Cod. originale IDROGUIDA Оригинальный номер агрегата	Cod. originale KIT Оригинальный номер ремкомплекта
46X052	VOK				Sml-Koyo R. Master1998/03		
46X053	VOK	30,00			TRW R.Master 1998, crem. Ø30		
46X054	VOK	25,00			Sml Renault Clio, crem. Ø25		
46X055	VOK	24,00			Renault Megane 4ªserie, con paraolio distributore superiore Øi 19, crem. Ø24		
46X056	VOK	24,00			Sml/Koyo Renault Clio 1998, crem. Ø24		
46X057	VOK	23,00			TRW R.Megane coupe, Scenic '96/02, crem.Ø23		
46X058	VOC	25,00			Sml/Koyo Renault Laguna, 1993/01, Traffic 81/01, crem. Ø25		
46X059	VOC	25,00			Sml R.19, R.21, Clio, Espace, Express, crem. Ø25		
46X060	VOC	24,00			Sml R.18 1978/86, R.20, R.25 1988/93, crem. Ø24		
46X061	VOK	27,70			Sml-Koyo R.Master 1998/03, O. Movano 1998, crem.27, 7		
46X062	VOD				Distributore ZF R.20 1978/86, R.25 1984/88		
46X063	VOC	24,00			Kit idro Sml-Koyo R.Laguna, R. Megane, Scenic crem. Ø24, senza filetto		
46X064	VOC	24,00			Kit idro Sml-Koyo R.Laguna, R. Megane, Scenic crem. Ø24, con filetto		
46X065	VOD				Distributore Sml 1993/01, con paraolio dis. 0M Øi 28,5 e paraolio dis. 1PM Øi 19		
46X066	VOC	23,00			Kit idro TRW R. Megane, Scenic 1996/02, crem. Ø23		
46X067	VOK	23,00			Sml Renault 21 Nevada 4x4 crem.Ø23		
46X068	VOK	27,70			Kit idro KOYO, Renault Master 2, Trafic 2, crem. Ø27, 7		
• 46X069	VOK	24,00			Koyo Renault Clio II 1.0L & 1.6L 1999, crem. Ø24, con parti metalliche		
46X601	VOP				Renault		
46X602	VOP			19,05	Renault Saginaw, albero Ø19,05		
46X603	VOP			19,05	Renault 21, albero Ø19,05		
46X604	VOP			19,05	R21 U.tipo, albero Ø19,05		
46X605	VOP			18,00	Renault, albero Ø18		
46X606	VOP				kit pompa elettrica R19, R21, Clio, Hyposi parte idraulica		
• 46X607	VOP				pompa elettrica R. Clio, R. Kangoo		
46X701	OCX				cuffia crem. Manuale R4/R5/R6 75/79		
46X702	OCX				cuffia crem. manuale R4/R5/R6 1979-		
46X703	OCX				cuffia crem. manuale R5 ultimo tipo		
46X704	OCX				cuffia crem. manuale Clio		
46X705	OCX				cuffia crem. idro Clio 1984-R5 superFIVE 1984 in poi		
46X706	OCX				cuffia crem. manuale R14 1979-		
46X707	OCX				cuffia crem. idro R11 1984-		
46X708	OCX				cuffia crem. manuale R11		
46X709	OCX				cuffia crem. idro R18 1983-		
46X710	OCX				cuffia crem. idro R19 1976-		
46X711	OCX				cuffia crem. manuale R19		
46X712	OCX				cuffia crem. idro R20 diesel 1979>		
46X713	OCX				cuffia crem. idro R21 1976-		
46X714	OCX				cuffia crem. idro R21TXE 1983-		
46X715	OCX				cuffia crem. manuale R21		
46X716	OCD				cuffia crem. DX manuale R25/R30/Fuego 1982-		

VOK Kit idroguida Power steering kit Ремкомплект рулевого управления
VOC Kit cremagliera Rack kit Ремкомплект гидроцилиндра
VOD Kit distributore Pignon kit Ремкомплект распределителя
VOP Kit pompa Pump kit Ремкомплект насоса
OCD Cuffia destra Rack boot (right) Правый сайлентблок
OCS Cuffia sinistra Rack boot (left) Левый сайлентблок
OCX Cuffie sinistra+destra Rack boot (left+right) Набор сайлентблоков
OCC Kit cuffie Rack boot kit Ремкомплект сайлентблоков



Codice Code Код	Ref. Приме- нение	Ø crem. rack Ø	Ø distr. pinion Ø	Ø albero shaft Ø	Descrizione per utilizzo Use remarks Примечания	Cod. originale IDROGUIDA Оригинальный номер агрегата	Cod. originale KIT Оригинальный номер ремкомплекта
46X717	OCS				cuffia crem. SX manuale R25/R30/Fuego 1982-		
46X718	OCX				cuffia crem. idro R25-R30-Fuego 82 in poi		
46X719	OCX				cuffia crem. idro Espace 1984-		
46X720	OCX				cuffia crem. manuale Twingo		
46X721	OCD				cuffia crem. DX idro Express 1985-		
46X722	OCS				cuffia crem. SX idro Express 1985-		
46X723	OCX				cuffia crem. manuale Express		
46X724	OCS				cuffia crem. SX manuale Trafic 1989-		
46X725	OCD				cuffia crem. DX manuale Trafic 1989-		
46X726	OCX				cuffia crem. idro R19-Clio		
46X727	OCD				cuffia crem. idro DX R20 benzina 1976 >		
46X728	OCS				cuffia crem. idro SX R20 benzina 1976 >		
46X729	OCX				cuffia crem. idro Megane1400/1600/2000 1996 in poi		
46X730	OCX				cuffia crem. idro Megane2000 16 V. 1996 in poi		
46X731	OCX				cuffia crem. idro Laguna 12/93 >		
46X732	OCX				cuffia crem. idro Trafic 3/89 in poi		
46X733	OCD				cuffia crem. idro SX Safrane		
46X734	OCX				cuffia crem. idro DX Safrane I		
46X735	OCX				cuffia crem. idro Espace III S.		
46X736	OCX				cuffia crem. idro Kangoo 3/98 in poi		
46X737	OCX				cuffia crem. idro Safrane		
46X738	OCS				cuffia crem. idro SX Trafic 3/89		
46X739	OCD				cuffia crem. idro DX Safrane I, Clio II, Kangoo		
46X740	OCS				cuffia crem. idro SX Safrane I, Clio II, Kangoo		
46X741	OCS				cuffia crem. idro SX Safrane II, 7/96 in poi		
46X742	OCD				cuffia crem. idro DX Safrane II, 7/96 in poi		
46X743	OCC				kit cuffie crem. idro Express 1985 (commerciale)		
46X744	OCC				kit cuffie crem. idro Safrane 3/94 in poi		
46X745	OCC				kit cuffie crem. idro Safrane 7/96 in poi		
• 46X746	OCX				Cuffia idro termoplastico SX/DX Renault Trafic dal 2001		
• 46X747	OCX				Cuffia idro termoplastico SX/DX Renault Megane III dal 2008		
• 46X748	OCX				Cuffia idro SX/DX Renault Clio II, Phase II 2001-'05		
46X763	OCC				kit cuffie idro Kangoo tutti		
46X764	OCC				kit cuffie idro R20 benzina		
46X765	OCC				kit cuffie idro Safrane		
• 46X766	OCS				kit cuffie idro SX Renault CLIO II		
• 46X767	OCX				Cuffia idro termoplastico SX/DX Renault Modus , R.Clio III dal 2005 in poi		
• 46X768	OCX				Cuffia idro termoplastico SX/DX Renault Laguna II, Grandtour,2001-'07		
• 46X769	OCX				Cuffia idro termoplastico SX/DX R. Vel Satis, R.Espace V dal 2002 in poi		
• 46X806	HPI				Pompa elettrica Renault Clio II e Kangoo/Nissan Almera II	OE 7701470783 - 7700421259 - K5084975+C	
• 46X807	HPI				Pompa elettrica Renault Clio 1	OE 7701466770	
• 46X808	HPI				Pompa elettrica Renault Kangoo 2005, Volvo S40	OE 8200718096- 8200520790	
• 46XE900					Idroguida elettrica Renault Scenic 2004		



Kit idroguida

Kits for power steering

Ремкомплекты для рулевого управления

Codice Code Код	Ref. Приме- нение	Ø crem. rack Ø	Ø distr. pinion Ø	Ø albero shaft Ø	Descrizione per utilizzo Use remarks Примечания	Cod. originale IDROGUIDA Оригинальный номер агрегата	Cod. originale KIT Оригинальный номер ремкомплекта
• 46XE901					Idroguida elettrica Renault Twingo 2002		
• 46XE902					Idroguida elettrica Renault Megane 2006		
• 46XE903					Idroguida elettrica Renault Clio 2002		
• 46XE904					Idroguida elettrica Renault Clio 2006		
• 46XE905					Idroguida elettrica Renault Modus		
• 46XE906					Idroguida elettrica Renault Clio III 2007		

Rolls-Royce

47X

Codice Code Код	Ref. Приме- нение	Ø crem. rack Ø	Ø distr. pinion Ø	Ø albero shaft Ø	Descrizione per utilizzo Use remarks Примечания	Cod. originale IDROGUIDA Оригинальный номер агрегата	Cod. originale KIT Оригинальный номер ремкомплекта
47X001	VOK				Kit idro R.Royce Bentley1984 uscita pign.P.T.F.E.Ø19 - Ø 22 (Ø25)		
47X002	VOK				Kit idro R.Royce, Bentley 1984 uscita pignone par.27,5x37x6,9 Ø25		
47X003	VOK				Rolls Royce, Bentley		
47X601	VOP				Rolls Royce1988 6,5 benzina		
47X701	OCX				cuffia cremagliera idro SX/DX Rolls Royce tutti i modello 1955>		TRW

Rover - Land Rover

48X

Codice Code Код	Ref. Приме- нение	Ø crem. rack Ø	Ø distr. pinion Ø	Ø albero shaft Ø	Descrizione per utilizzo Use remarks Примечания	Cod. originale IDROGUIDA Оригинальный номер агрегата	Cod. originale KIT Оригинальный номер ремкомплекта
48X001	VOK				Kit idro Land Rover, R. Rover 3 Bolt	55303	
48X002	VOK				Rover 4 bolt, Defender, Discovery		
48X003	VOK				Kit idro L.Rover 4 bolt U.T. originale,Defender,Discovery		
48X004	VOK				Kit idro Land Rover 6 Bolt,Discovery	7-J-05563	56900
48X005	VOK				Defender 3 & 4 bolt		
48X006	VOK				Defender, Land, Range Rover 4 bolt (Hallite)		
48X007	VOK				Rover P5 coupé		
48X008	VOK	24,00			Kit idro Rover 827 1986,Rover 620 SI 2000 benzina mod. Showa '94,crem.Ø24		
48X009	VOK	28,50			Austin Princess Wedge A&A, crem. Ø28,5		
48X010	VOK	25,00			Rover SDI, Reliant Scimitar 1976(burman), crem. Ø25		
48X011	VOK	25,00			Rover SDI (CAM) corpo un solo pezzo in alluminio, crem. Ø25		
48X012	VOK				Rover SDI-MK2 A & A 1980/82		
48X013	VOK				Austin 1800,1964/75 , Wolsley 2200		
48X014	VOK				SDI 1976 , Princess 1975/82		
48X015	VOK	25,00			TRW Montego 1984/95, Rover 200 CAM, Escort, Fiesta XR2i, crem. Ø25		
48X016	VOK	25,00			Kit idro TRW Rover 820, crem. Ø25		
48X017	VOK	25,00			Kit idro TRW Rover SDI 76-86con esterno in alluminio,crem.Ø25		
48X018	VOK	25,00			TRW Rover 416/420/214/216/220, crem. Ø25		
48X019	VOK				Kit idro Tryumph Stag 2.0-2.5 1963/77		
48X020	VOK				Kit idro Triumph Stag 2.0-2.05 1963/77 Adwest Aston Martin		

VOK Kit idroguida Power steering kit Ремкомплект рулевого управления
VOC Kit cremagliera Rack kit Ремкомплект гидроцилиндра
VOD Kit distributore Pignon kit Ремкомплект распределителя
VOP Kit pompa Pump kit Ремкомплект насоса
OCD Cuffia destra Rack boot (right) Правый сайлентблок
OCS Cuffia sinistra Rack boot (left) Левый сайлентблок
OCX Cuffie sinistra+destra Rack boot (left+right) Набор сайлентблоков
OCC Kit cuffie Rack boot kit Ремкомплект сайлентблоков



Codice Code Код	Ref. Приме- нение	Ø crem. rack Ø	Ø distr. pinion Ø	Ø albero shaft Ø	Descrizione per utilizzo Use remarks Примечания	Cod. originale IDROGUIDA Оригинальный номер агрегата	Cod. originale KIT Оригинальный номер ремкомплекта
48X021	VOK	25,00			Kit idro Lotus ADWEST, crem. Ø25		
48X022	VOK				TRW a crem. Rover 825 2500 D 1987/92		
48X023	VOD				kit idro manuale Land Rover defender 90		
48X024	VOK	25,00			Kit idro TRW Rover serie 600/400 1995, crem. Ø25		
48X025	VOK	28,00			Kit idro TRW Land Rover Freelander 1997 - 36.5 mm, crem. Ø28		
48X026	VOK				Kit idro ZF R. Rover	8055974107	8055/2
48X027	VOK	25,00			Kit idro TRW Rover serie 200/400 1995, crem. Ø25		
48X028	VOK	25,00			Kit idro TRW Rover 75 1999, crem. Ø25		
48X029	VOK				Kit idro Land Rover TD5 Discovery U.T. 1999		
48X030	VOD				R.Rover 4 bolti 1ªserie,Discovery 2, Defender 1990/98, a settore		
48X031	VOD				Kit albero entrata Rover 4 bolt, Ø22		
48X032	VOK	25,00			TRW Rover 400,1995/00, con due paraoli dis. 6, crem. Ø25		
48X033	VOK				Kit idro ZF Range Rover, Land Rover		
48X034	VOK				ZF - Range Rover LHD, 1994-02, doppio albero Ø28 e Ø32		8076/1
48X035	VOK	25,00			Kit idro TRW Rover 25,2000 con due paraoli dis. 7, crem. Ø25		
48X036	VOK	28,00			Kit idro TRW Land Rover Freelander 1997 - 40 mm, crem. Ø28		
48X037	VOK				Land Rover, Discovery II		
48X038	VOK			32,00	taxi,Defender 4 bolt, albero Ø32		
48X039	VOD			38,00	Land Rover Discovery MK2, albero Ø38		
48X040	VOD				Land Rover Discovery II, con paraolio dis. 1PM Øi 20,6		
48X041	VOK	32,00			ZF Land Rover L30 MK3, BMW X5, crem.Ø32	7852993236- 7852993235	7852/529
48X042	VOD			38,00	Kit idro LTI Taxi Cab, T5 , LandRover albero Ø38		
48X601	VOP				Land Rover 90/110, Range Rover 1973/86		
48X602	VOP			20,00	Land Rover 90/110, Range Rover-Discovery, albero Ø20		
48X603	VOP			15,00	Land Rover 620 - Discovery U.tipo con guarn., albero Ø15		
48X604	VOP			15,00	Land Rover 600/620 - Discovery U.T. doppio attacco, albero Ø15		
48X605	VOP			19,05	Hobourn Eaton Rover 8250, albero Ø19,05		
48X606	VOP				Rover 200 QVB 10080		
48X607	VOP				kit pompa Rover 200/400/45-Hobourn Eaton, doppio attacco, albero Ø15		
48X608	VOP			19,05	Range Rover 2.51 Diesel 1993 VANE		7681/013
48X701	OCX				cuffia cremaglieraidro (TRW) SX/DX Austin-MONTEGO 200-400/(CAM) 1987-1992		
48X702	OCX				cuffia cremagliera(TRW) SX/DX Rover 414i-418TD-214i-216i 16V		
48X703	OCX				cuffia cremaglieraRover 820-825-827 Sterling 10/1986>		
48X704	OCX				cuffia cremagliera Rover 600 1996 in poi		
48X705	OCD				cuffia cremaglieraidro DX Triumph 2300/3500SC/3500TC 68/86		
48X706	OCS				cuffia cremaglieraidro SX Triumph 2300/3500SC/3500TC 68/86		



Kit idroguida

Kits for power steering

Ремкомплекты для рулевого управления

Codice Code Код	Ref. Приме- нение	Ø crem. rack Ø	Ø distr. pinion Ø	Ø albero shaft Ø	Descrizione per utilizzo Use remarks Примечания	Cod. originale IDROGUIDA Оригинальный номер агрегата	Cod. originale KIT Оригинальный номер ремкомплекта
48X707	OCX				cuffia cremaglieraidro Princess 75/82		
48X708	OCS				cuffia cremagliera(TRW) manuale SX. Rover 213/216 84-89		
48X709	OCX				cuffia cremagliera(TRW) manuale Allegro 73-82 / MAXI / MARINA/MG RILEY		
48X710	OCX				cuffia cremagliera(TRW) manuale Ambassador/MGB		
48X711	OCS				cuffia cremagliera(TRW) manuale SX. metro 80-82		
48X712	OCX				cuffia cremagliera(TRW) manuale Maestro 84- / metro / MONTEGO		
48X713	OCX				cuffia cremagliera(TRW) manuale Mini 63-		
48X714	OCS				cuffia cremagliera(TRW) manuale SX. Princess 75-82 / 2300/3500SC-3500TC 68-86 / Triumph		
48X715	OCD				cuffia cremagliera(TRW) manuale DX. Princess 75-82 / 2000/2300-2600-3500 SD1 68-86 / 3500SC-3500TC		
48X716	OCD				cuffia cremagliera(TRW) manuale DX. MG-MIDGET-Triumph 62-81		
48X717	OCS				cuffia cremagliera(TRW) manuale SX. MG-MIDGET-Triumph 62-81		
48X718	OCD				cuffia cremagliera(TRW) manuale DX. Triumph Dolomite 1300-1500/1850 72-81		
48X719	OCS				cuffia cremagliera(TRW) manuale SX. Triumph Dolomite 1300-1500/1850 72-81		
48X720	OCD				cuffia cremagliera(TRW) manuale DX. Triumph HERALD 59-82		
48X721	OCD				cuffia cremagliera(TRW) manuale DX. Triumph Spitfire 59-82		
48X722	OCD				cuffia cremagliera(TRW) manuale DX. Triumph 1300-1300TC-2000/2500 65-77		
48X723	OCS				cuffia cremagliera(TRW) manuale SX. Triumph HERALD 59-82		
48X724	OCS				cuffia cremagliera(TRW) manuale SX. Triumph Spitfire 59-82		
48X725	OCS				cuffia cremagliera(TRW) manuale SX. Triumph 1300-1300TC-1500TC/2000-2500 65-77		
48X726	OCX				cuffia cremagliera sx/dx (TRW) manuale Triumph TR7 75-81 - / 2300-3500SC/3500TC 68-86		
48X727	OCX				cuffia cremagliera(TRW) manuale 2000-2300-2600/3500 SD1 68-86 / Triumph (air transfer hole)		
• 48X728	OCS				Cuffia idro SX LandRover, Freelander		
• 48X729	OCX				Cuffia idro termoplastico SX/DX LandRover Discovery III dal 2004		
48X762	OCC				Rover - LAND/Range Rover		
48X777	OCC				kit cuffie cremagliera idro Triumph 2300/3500SC/3500TC 68/86		
48X801	PSP				pompa idro Saginaw Rover Taxi 83-86 / Princess 1700		

SAAB

49X

Codice Code Код	Ref. Приме- нение	Ø crem. rack Ø	Ø distr. pinion Ø	Ø albero shaft Ø	Descrizione per utilizzo Use remarks Примечания	Cod. originale IDROGUIDA Оригинальный номер агрегата	Cod. originale KIT Оригинальный номер ремкомплекта
49X001	VOK				Kit idro Saginaw Saab 9000 1984/98		
49X002	VOK				Saab 9000 1992		

VOK Kit idroguida Power steering kit Ремкомплект рулевого управления
VOC Kit cremagliera Rack kit Ремкомплект гидроцилиндра
VOD Kit distributore Pignon kit Ремкомплект распределителя
VOP Kit pompa Pump kit Ремкомплект насоса
 OCD Cuffia destra Rack boot (right) Правый сайлентблок
 OCS Cuffia sinistra Rack boot (left) Левый сайлентблок
 OCX Cuffie sinistra+destra Rack boot (left+right) Набор сайлентблоков
 OCC Kit cuffie Rack boot kit Ремкомплект сайлентблоков



Codice Code Код	Ref. Приме- нение	Ø crem. rack Ø	Ø distr. pinion Ø	Ø albero shaft Ø	Descrizione per utilizzo Use remarks Примечания	Cod. originale IDROGUIDA Оригинальный номер агрегата	Cod. originale KIT Оригинальный номер ремкомплекта
49X003	VOK	25,00			Saab 900 1979/93, crem. Ø25		
49X004	VOK	28,00			Kit idro ZF Saab 900 1993, crem. Ø28	7836974196	7836/010 7836/007
49X005	VOK				G.M., Saab		
49X006	VOK	24,00			Kit idro ZF Saab 95 1999-05, crem.Ø24		7831/018
49X007	VOK	24,00			kit idro Saab 9.35, Pistone sigillato Ø39, crem. Ø24		
49X008	VOK	24,00			kit idro Saab 9.35, con paraoli ORIG.,pistone sigillato Ø39, crem.Ø24		
49X601	VOP			17,00	Saab 2000 benz. Saginaw 1995, albero Ø17		
49X701	OCX				rockwBerlina/ Coupè/ Cabrio 1993-'97		
49X702	OCS				cuffia idro SX Saab 9000 CS 1990-'92, Saab 9000 CD 1988-'92/1993-'97		
49X703	OCD				cuffia idro DX Saab 9000 CS 1990-'92, Saab 9000 CD 1988-'92/1993-'97		
49X704	OCS				cuffia idro manuale SX Saab 99, 1968-'71		
49X705	OCD				cuffia idro manuale DX Saab 99, 1971-'74		
• 49X706	OCX				Cuffia idro SX/DX Saab 9000, 9.5		
49X707	OCC				kit cuffie cremagliera (TRW) idro DX/SX Saab 9000 85/89 (completo)		
49X708	OCC				kit cuffie cremagliera (TRW) idro DX/SX Saab 99 1700/1900/2000 (completo)		
• 49X709	OCX				cuffia idro termoplastico SX/DX, Saab 9-3 Berlina dal 2002-'07, Saab 9-3 Cabrio 2006-'07, Wagon 05-'07		
• 49X710	OCX				cuffia idro termoplastico SX/DX, Saab 9-3 Berlina 2006-'07, Saab 9-3 Cabrio 2006-'07, 9-3 Wagon 06-'07		
• 49X711	OCX				cuffia idro termoplastico SX/DX, Saab 9-3 Berlina 2002-'05, Saab 9-3 Cabrio 2003-'05, 9-3 Wagon 2005		

Seat

57X

Codice Code Код	Ref. Приме- нение	Ø crem. rack Ø	Ø distr. pinion Ø	Ø albero shaft Ø	Descrizione per utilizzo Use remarks Примечания	Cod. originale IDROGUIDA Оригинальный номер агрегата	Cod. originale KIT Оригинальный номер ремкомплекта
57X001	VOK	28,00			TRW- Seat Alhambra 1995, Galaxy, crem. Ø28		TRW
• 57X001 Light	VOK	28,00			TRW -Seat Alhambra 1995, Galaxy, crem. Ø28		TRW
57X002	VOK	23,00			Kit idro Seat Ibiza, crem. Ø23		
57X003	VOK	23,00			Kit idro Seat Cordoba, crem. Ø23		
57X004	VOK	23,00			Kit idro Seat Ibiza, con due paraoli dis.6, crem. Ø23		
57X719	OCX				cuffie cremagliera (TRW) man Cordoba 94- / Ibiza 93- Malaga 91-Marbella 91-Toledo 91-		TRW
57X720	OCX				cuffie cremagliera (TRW) idro Cordoba 94-		TRW
57X721	OCD				cuffia cremagliera idro Dx Seat Ibiza 131/132		
57X722	OCS				cuffia cremagliera idro SX Seat Ibiza 131/132		
• 57X723	OCX				cuffia idro termoplastico SX/DX Seat Ibiza 2002-'08, Cordoba 2002-'04		
• 57X724	OCX				cuffia idro termoplastico SX/DX Seat Leon 2005-'06, Toledo 2004-'05, Altea 2004-'08		



Kit idroguida

Kits for power steering

Ремкомплекты для рулевого управления

Codice Code Код	Ref. Примечание	Ø crem. rack Ø	Ø distr. pinion Ø	Ø albero shaft Ø	Descrizione per utilizzo Use remarks Примечания	Cod. originale IDROGUIDA Оригинальный номер агрегата	Cod. originale KIT Оригинальный номер ремкомплекта
57X725	OCX				kit cuffie cremagliera idro DX/SX Seat Ibiza 131/132 (completo)		
• 57X726	OCX				Cuffia idro SX/DX termoplastico Seat Leon 2001-05		
57X751	OCD				cuffia man. Dx Seat Cordoba		
57X752	OCS				cuffia man. SX Seat Cordoba		
57X753	OCC				kit cuffie man. Seat Cordoba		

Ssangyong

60X

Codice Code Код	Ref. Примечание	Ø crem. rack Ø	Ø distr. pinion Ø	Ø albero shaft Ø	Descrizione per utilizzo Use remarks Примечания	Cod. originale IDROGUIDA Оригинальный номер агрегата	Cod. originale KIT Оригинальный номер ремкомплекта
60X001	VOK	27,70			Korando Ssangyong/90, crem. Ø27,7		

Subaru

51X

Codice Code Код	Ref. Примечание	Ø crem. rack Ø	Ø distr. pinion Ø	Ø albero shaft Ø	Descrizione per utilizzo Use remarks Примечания	Cod. originale IDROGUIDA Оригинальный номер агрегата	Cod. originale KIT Оригинальный номер ремкомплекта
51X001	VOK				Kit idro Subaru Estate 1989, Loyale 1990/94		
51X002	VOK				Kit idro Subaru 3D,4D, Estate, Wagon 1985-86		
51X003	VOK				Kit idro Subaru 4DR 1981-84		
51X004	VOK	23,00			Kit idro Subaru XT, Legacy, I-Mark 1985-89, crem. Ø23		
51X005	VOK	24,00			kit idro Subaru Impreza 4WD turbo crem. Ø24, Prizm 1993/97		
51X006	VOK	24,00			kit idro Subaru Legacy crem. Ø24		
51X007	VOK				kit idro Subaru Salom 1987		
51X008	VOK				Kit idro Subaru Justy, Swift		
51X009	VOK				Kit idro Subaru Impreza		
51X010	VOK				Kit idro Subaru Impreza 1992-95		
51X011	VOK				kit idro Subaru Legacy (90 on)		
51X012	VOK				Kit idro Subaru Liberty		
51X013	VOK				Kit idro Subaru Mail Truck RHD 1994-96		
51X014	VOK				Kit idro Subaru Mail Truck RHD 1997		
51X015	VOK				Kit idro Subaru SVX, LS, 4WD 1992-95		
51X016	VOK	24,00			kit idro Subaru Legacy 2000-01, crem. Ø24		
51X017	VOK	24,00			Kit idro Subaru Forester 1998-00, Impreza 1998-01, crem. Ø24		
51X018	VOK	24,00			Kit idro Subaru Impreza 2004/06, crem. Ø24		
• 51X019	VOK	23,00			Subaru Forester 2005-07, crem. Ø23		
• 51X020	VOK	24,00			Kit idro Subaru Forester, crem. Ø24		
51X601	VOP				Subaru Impreza 1993-98		
51X602	VOP				Subaru SVX 1992-96		
51X603	VOP				Subaru Impreza 2002		
51X604	VOP				Subaru XT 1987-91		
51X605	VOP				Subaru Impreza 1999/01		
51X606	VOP				Subaru Legacy 2,5 L SOHC 2000/01		
• 51X607	VOP			18,00	Subaru Forester (no turbo) 2003-07 e Impreza & Outback 2006-07, albero Ø18		8748

VOK Kit idroguida Power steering kit Ремкомплект рулевого управления
VOC Kit cremagliera Rack kit Ремкомплект гидроцилиндра
VOD Kit distributore Pignon kit Ремкомплект распределителя
VOP Kit pompa Pump kit Ремкомплект насоса
OCD Cuffia destra Rack boot (right) Правый сайлентблок
OCS Cuffia sinistra Rack boot (left) Левый сайлентблок
OCX Cuffie sinistra+destra Rack boot (left+right) Набор сайлентблоков
OCC Kit cuffie Rack boot kit Ремкомплект сайлентблоков



Codice Code Код	Ref. Приме- нение	Ø crem. rack Ø	Ø distr. pinion Ø	Ø albero shaft Ø	Descrizione per utilizzo Use remarks Примечания	Cod. originale IDROGUIDA Оригинальный номер агрегата	Cod. originale KIT Оригинальный номер ремкомплекта
51X701	OCX				cuffia cremagliera idro Leone 1800 10/85> - Alcyone LEGACY FINO AL 1985		
51X702	OCD				cuffia cremagliera idro DX Leone		
51X703	OCS				cuffia cremagliera idro SX Leone		
51X704	OCX				cuffia cremagliera idro Alcyone Agency 85>		
51X705	OCX				cuffia cremagliera idro Subaru Justi 1200 4WD 88>		
51X706	OCX				cuffia cremagliera idro Subaru Justi 1200 4WD 85>		
51X707	OCX				cuffia cremagliera idro Subaru Justi		
51X708	OCC				kit cuffie cremagliera idro DX/SX Leone (completo)		
51X751	OCX				cuffia man. SX/DX Subaru Leone		
51X752	OCX				cuffia man. SX/DX Subaru Leone		
51X753	OCD				cuffia man. DX Subaru Domingo		
51X754	OCS				cuffia man. SX Subaru Domingo		
51X755	OCX				cuffia man. SX/DX Subaru Domingo		
51X756	OCC				kit cuffie man Subaru Domingo		
• 51X757	OCX				Cuffia idro SX/DX S.Impreza G11 2000/02, Legacy 1998-'02, Forester S10 97-'01		
• 51X758	OCX				Cuffia idro termoplastico SX/DX, Subaru Impreza G11, Forester S11 dal 2002/08		
• 51X759	OCX				cuffia idro termoplastico SX/DX, Subaru Justy J12, 2003-'06		

Suzuki

52X

Codice Code Код	Ref. Приме- нение	Ø crem. rack Ø	Ø distr. pinion Ø	Ø albero shaft Ø	Descrizione per utilizzo Use remarks Примечания	Cod. originale IDROGUIDA Оригинальный номер агрегата	Cod. originale KIT Оригинальный номер ремкомплекта
52X001	VOD			30,00	kit idro Suzuki Vitara,pignone grande,paraolio DIS.0M Ø30		
52X002	VOK	22,00		28,00	kit idro Suzuki Swift,pignone grande,paraolio DIS.0M Ø28,crem.Ø22		
52X003	VOK				Kit idro Suzuki Baleno 1996		
52X004	VOK	25,00			Kit idro Suzuki Gran Vitara 1998-03,XL7 2001-03 crem. Ø25		
52X005	VOK	22,00			kit idro Suzuki Swift crem. Ø22,pignone Ø28		
52X006	VOK				Kit idro Suzuki Esteem 1995-97		
52X007	VOK	25,00			Kit idro Suzuki Forenza, Reno 2005/07, crem.25		
52X008	VOK	23,00			Kit idro Suzuki Aerio 2003/04, crem Ø23		
52X600	VOP				kit pompa Suzuki Sidekick 1990-93		
52X601	VOP				Suzuki Esteem 1996-02		
52X602	VOP				Suzuki Esteem 1995-96		
52X603	VOP				Suzuki Esteem 1998		
52X604	VOP			17,00	Suzuki Vitara 1988,albero Ø17		
52X605	VOP				Suzuki Sidekick 1996-98		
52X606	VOP			17,00	Suzuki Vitara,albero Ø17		
52X751	OCD				cuffia man. DX Suzuki Cultus		
52X752	OCS				cuffia man. sx Suzuki Cultus		
52X753	OCX				cuffia ma. sx/dx Suzuki Carry		
52X754	OCX				cuffia ma. sx/dx Suzuki Carry		
52X755	OCC				kit cuffie idro Suzuki Cultus		



Kit idroguida

Kits for power steering

Ремкомплекты для рулевого управления

Codice Code Код	Ref. Применение	Ø crem. rack Ø	Ø distr. pinion Ø	Ø albero shaft Ø	Descrizione per utilizzo Use remarks Примечания	Cod. originale IDROGUIDA Оригинальный номер агрегата	Cod. originale KIT Оригинальный номер ремкомплекта
		Dimensioni					
• 52X756	OCS				Cuffia idro termoplastico SX, Suzuki Baleno 1995-'00		
• 52X757	OCX				Cuffia idro termoplastico SX/DX, Suzuki Swift Berlina RS dal 2005		
• 52X758	OCX				cuffia crem. termoplastico SX/DX Suzuki SR4 RW, dal 2006		

Talbot

53X

Codice Code Код	Ref. Применение	Ø crem. rack Ø	Ø distr. pinion Ø	Ø albero shaft Ø	Descrizione per utilizzo Use remarks Примечания	Cod. originale IDROGUIDA Оригинальный номер агрегата	Cod. originale KIT Оригинальный номер ремкомплекта
		Dimensioni					
53X001	VOK				Kit idro Talbot Alpine 1975, Solara 1980-86		
53X002	VOK				Kit idro ZF Talbot Horizon 1978-86	7832955121	7832/003
53X701	OCS				cuffia cremagliera idro Dx TagorA 80/83		
53X702	OCS				cuffia cremagliera idro Sx TagorA 80/83		
53X751	OCX				cuffia man. Sx/Dx Talbot F1100		
53X752	OCX				cuffia man. Sx/Dx Talbot F1307		
53X753	OCX				cuffia man. Sx/Dx Talbot SAMBA		
53X754	OCX				cuffia man. Sx/Dx Talbot Tagor		
53X755	OCX				cuffia man. Dx Talbot Avenger		
53X756	OCS				cuffia man. Sx Talbot Avenger		
53X757	OCX				cuffia man. Sx/Dx Talbot Simca		
53X758	OCX				cuffia man. Sx/Dx Talbot Sunbe		
53X759	OCX				cuffia man. Dx Talbot Epress		
53X760	OCS				cuffia man. Sx Talbot Epress		
53X761	OCC				kit cuffie man. Talbot Avenger		
53X762	OCC				kit cuffie man. Talbot Epress		
53X763	OCC				kit cuffie idro Talbot TagorA		

Tata

54X

Codice Code Код	Ref. Применение	Ø crem. rack Ø	Ø distr. pinion Ø	Ø albero shaft Ø	Descrizione per utilizzo Use remarks Примечания	Cod. originale IDROGUIDA Оригинальный номер агрегата	Cod. originale KIT Оригинальный номер ремкомплекта
		Dimensioni					
54X001	VOK				Kit idro Tata		
54X002	VOK				Kit idro a settore Tata		
54X003	VOK				Kit idro a settore Tata, guida ZF india		

Toyota

55X

Codice Code Код	Ref. Применение	Ø crem. rack Ø	Ø distr. pinion Ø	Ø albero shaft Ø	Descrizione per utilizzo Use remarks Примечания	Cod. originale IDROGUIDA Оригинальный номер агрегата	Cod. originale KIT Оригинальный номер ремкомплекта
		Dimensioni					
55X001	VOK	22,00			Kit idro Toyota Corolla '85, Pulsar, crem Ø22		
55X002	VOK	24,00			Kit idro Toyota Corolla 4DR '84-87, Tercel '83-88, crem. Ø24		
55X003	VOK	25,50			Kit idro Toyota Cressida '85/88, crem. Ø25,5		
55X004	VOK	25,50			Kit idro Toyota Celica, T. Supra '82/85, crem. Ø25,5		
55X005	VOK	24,00			Kit idro Toyota Corolla 2porte 1986/87 RWD, crem. Ø24		

VOK Kit idroguida Power steering kit Ремкомплект рулевого управления
VOC Kit cremagliera Rack kit Ремкомплект гидроцилиндра
VOD Kit distributore Pignon kit Ремкомплект распределителя
VOP Kit pompa Pump kit Ремкомплект насоса
 OCD Cuffia destra Rack boot (right) Правый сайлентблок
 OCS Cuffia sinistra Rack boot (left) Левый сайлентблок
 OCX Cuffie sinistra+destra Rack boot (left+right) Набор сайлентблоков
 OCC Kit cuffie Rack boot kit Ремкомплект сайлентблоков



Codice Code Код	Ref. Приме- нение	Ø crem. rack Ø	Ø distr. pinion Ø	Ø albero shaft Ø	Descrizione per utilizzo Use remarks Примечания	Cod. originale IDROGUIDA Оригинальный номер агрегата	Cod. originale KIT Оригинальный номер ремкомплекта
55X006	VOK	24,00			Kit idro Toyota Corolla "84/86 4porte Diesel, crem. Ø24		
55X007	VOK	25,50			Kit idro Toyota Camry 1983-86, crem. Ø25,5		
55X008	VOK	26,50			Kit idro Toyota Supra e Celica "86/88, crem. Ø26,5		
55X009	VOK				Kit idro Toyota Van "86/88, Space Cruiser		
55X010	VOK	25,50			Kit idro Toyota Camry "87/90, Celica "88/89, Primera, crem. Ø25,5		
55X011	VOK	24,00			Kit idro Toyota Corolla '88/92, Nova '85/88, Wagon, Sedan '87/92, crem. Ø24		
55X012	VOK	26,50			Kit idro Toyota Celica "86/89, Coupe ST "86/93, crem. Ø26,5	4425020488, 4425020500	04445-20040
55X013	VOK	22,00			Kit idro Toyota Tercel 88/90, Daihatsu Applause 89/97, crem. Ø22		
55X014	VOK	27,00			Kit idro Toyota Camry 1990, T000 "93/98, crem. Ø27		
55X015	VOK	26,50			Kit idro T. Celica Coupe GT, GTS "90/92, Turbo 4 WD, Lufback 4WD "89/90, crem. Ø26,5		
55X016	VOK				Kit idro T. Tercel "95/98, T.Paseo "90-97		
55X017	VOK				Kit idro Toyota Corolla DX, SR5 287/90-AE92		
55X018	VOK				Kit idro Toyota Previa "90/97, T.Van "89 2WD-4WD		
55X019	VOK				Kit idro T. Supra Turbo "89/93, Lexus LS400 89/00, SC300		
55X020	VOK				Kit idro Toyota Cressidra "88/92		
55X021	VOK	25,50			Kit idro Toyota Carina, crem. Ø25,5		
55X022	VOK	22,00			Kit idro Koyo Toyota MR2 90/94, crem. Ø22		
55X023	VOK	27,00			Kit idro T. Camry 2000, Lexus ES300 97-00, RX300, crem. Ø27		
55X024	VOK	27,00			Kit idro Toyota Camry, Lexus ES300 "95, crem. Ø27		
55X025	VOK				Kit idro Toyota Lexus LS400		
55X026	VOK				Kit idro Toyota Lexus ES250 "89-90		
55X027	VOK				Kit idro Toyota Landcruiser		
55X028	VOD				Kit idro Toyota Landcruiser 1984/90 cc3800, con un paraolio dis. 0M Øi 32 e un paraolio dis. 1PM Øi 19		
55X029	VOK				Kit idro TRW Celica "90/91		
55X030	VOK				Kit idro TRW Toyota Carina II "92/98		
55X031	VOK				Kit idro Toyota Truck Landcruiser "90/97 P.T.F.E. Ø36 e Ø38 paraolio dis. 0+ paraolio dis. 0, Lexus LS450		
55X032	VOD				Kit idro Toyota Landcruiser "79/87, con un paraolio dis. 2 Øi 32 e un paraolio dis. 1PM Øi 19		
55X033	VOK				Kit idro Toyota 4 Runner 4WD "84/85		
55X034	VOK	24,00			Kit idro Toyota PAW 4, RAV 4, con due paraoli dis. 7, crem. Ø24		
55X035	VOK				Kit idro ZF Toyota Truck Landcruiser, "90/97 con P.T.F.E. Ø36/38,5	ZF	
55X036	VOK	26,00			Kit idro ZF Toyota Carina "92/97, crem. Ø26	ZF-7832974114 7832974116 7835974126	7832/14
55X036 Light	VOK	26,00			Kit idro ZF -Toyota Carina '92/97, crem. Ø26	ZF	



Kit idroguida

Kits for power steering

Ремкомплекты для рулевого управления

Codice Code Код	Ref. Приме- нение	Ø crem. rack Ø	Ø distr. pinion Ø	Ø albero shaft Ø	Descrizione per utilizzo Use remarks Примечания	Cod. originale IDROGUIDA Оригинальный номер агрегата	Cod. originale KIT Оригинальный номер ремкомплекта
55X037	VOK	27,00			Kit idro Celica 4WD 1994,T000 1993/98, crem. Ø27	28064525	
55X038	VOK			36,00	Kit idro a settore Toyota Huluk Ø36		
55X039	VOK				Kit idro T. Foran 2400,Pickup 4WD,4 Runner 86/89 4 Cyl.89/90, 6Cyl		
55X040	VOK			32,00	Kit idro Toyota 4 Runner 4WD "84/85,albero Ø32		
55X041	VOK	27,00			Kit idro Toyota Celica 2000CC,ST 1982 L 1994, crem. Ø27		
55X042A	VOK	35,00			Kit idro Toyota Landcruiser 1996-02,Tacoma 1998-03, crem.35		
55X043	VOK				Kit idro Toyota Celica "94/99		
55X044	VOK	24,00			Kit idro ZF Toyota Avensis 1998, crem. Ø24	ZF-7891974111/ 115/213	7891/4
55X045	VOK	22,00			Kit idro Toyota Yaris "99,crem.Ø22		
55X046	VOK	25,50			Kit idro Toyota Corona "94,crem.Ø25,5		
55X047	VOK				Kit idro Toyota Landcruiser,Lexus LX470 "98-02		
55X048	VOK				Kit idro Toyota Supra "94/97		
55X049	VOK				Kit idro Toyota Corolla "97/98,Geo Prisma "98/00		
55X050	VOK				Kit idro Toyota Pickup 4WD,4 Runner "90/95,		
55X051	VOK				Kit idro Toyota Pickup 2WD "86/90,4 cilindri,no turbo		
55X052	VOK				Kit idro Toyota Pickup 2WD "84/90,4 CYL,no turbo HD SUSP.		
55X053	VOK				Kit idro Toyota Pickup 4WD,4 Runner "89/90		
55X054	VOK				Kit idro Toyota truck Hilux 1979/80, Landcruiser, con un paraolio dis.0M Øi 32 e un paraolio dis. 1PM Øi 19		
55X055	VOK				Kit idro Toyota 4X4 Pickup,4 Runner		
55X056	VOK				Kit idro Toyota Celica 2000/05,4 CYL.,crem. Ø26		
55X057	VOK				Kit idro Toyota Sequoia 2WD,4WD 2001/03		
55X058	VOK				Kit idro Toyota Corolla "82/83		
55X059	VOK				Kit idro Toyota Tacoma 2WD "95/97		
55X060	VOK				Kit idro Geo Metro,Swift "95-97		
55X061	VOK				Kit idro Toyota Camry,Lexus ES300 "90-94		
55X062	VOK				Kit idro Lexus GS300/400 "98-00,GS430 98-03,SC430		
55X063	VOK				Kit idro T.Pickup 2WD "84/89 no turbo,"86/89 turbo		
55X064	VOK				Kit idro T.Corolla "80/82,VAN "83/85,Cressidra "80/84		
55X065	VOK	26,70			Kit idro Kojo Lexus LS430 2000-03/2004-06,crem. Ø26,7		
55X066	VOK	27,00			Kit idro Lexus ES300 2000-ES330 04,Toyota Camry 02, crem. Ø27		
55X067	VOK	24,00			Kit idro Toyota Corolla Matrix 2002/03,crem. Ø24		
55X068	VOK				Kit idro Geo,Metro "98/00		
55X069	VOK				Kit idro Toyota MR2 2000-01		
55X070	VOK	23,00			Kit idro Geo Storm "92-93,crem.Ø23		
55X071	VOK				Kit idro Toyota Geo Storm "90-90		
55X072	VOK				Kit idro Toyota Carina II "92-98		
55X073	VOK				Kit idro Lexus IS300 2001-05		
55X074	VOK				Kit idro Toyota Geo Tracker "99-03		

VOK Kit idroguida Power steering kit Ремкомплект рулевого управления
VOC Kit cremagliera Rack kit Ремкомплект гидроцилиндра
VOD Kit distributore Pignon kit Ремкомплект распределителя
VOP Kit pompa Pump kit Ремкомплект насоса
OCD Cuffia destra Rack boot (right) Правый сайлентблок
OCS Cuffia sinistra Rack boot (left) Левый сайлентблок
OCX Cuffie sinistra+destra Rack boot (left+right) Набор сайлентблоков
OCC Kit cuffie Rack boot kit Ремкомплект сайлентблоков



Codice Code Код	Ref. Приме- нение	Ø crem. rack Ø	Ø distr. pinion Ø	Ø albero shaft Ø	Descrizione per utilizzo Use remarks Примечания	Cod. originale IDROGUIDA Оригинальный номер агрегата	Cod. originale KIT Оригинальный номер ремкомплекта
55X075	VOK				Kit idro Toyota Landcruiser 03,Lexus LX470 2003-05		
55X076	VOK	27,00			Kit idro Toyota,Lexus GS300 "93-95 crem. Ø27		
55X077	VOK	27,00			Kit idro Toyota,Lexus IS300 2001 crem. Ø27		
55X078	VOK	27,00			Kit idro Lexus RX330 2003-05,Toyota Sienna 2003-04, crem. Ø27		
55X079	VOK	30,00			Kit idro Lexus GX470 2003,Toyota 4 runner "03, crem. Ø30		
55X080	VOD				Kit idro Toyota Truck Pickup 2WD "89/95		
55X081	VOK	22,00			Kit idro Toyota Yaris, crem. Ø22		
55X082	VOK	22,00			Kit idro Toyota Echo 2000/04,T.Scion,Yaris, crem. Ø22		
55X083	VOK	30,00			Kit idro Toyota Hi-Ace,crem. Ø30		
55X084	VOK	30,00			Kit idro Toyota Tacoma 4WD,2WD 2005/07,crem.Ø30		
55X085	VOK	26,00			Kit idro T.Rav4 2004/05,Scion TC 2005/06,crem.Ø26		
55X086	VOK	27,00			Kit idro Toyota Avalon 2005/07 ,crem.Ø27		
55X087	VOK	27,00			Kit idro Toyota Camry 2007,crem. Ø27		
55X088	VOK	27,00			Kit idro Toyota Highlander 2005/07,RX350 2007 crem.27		
55X089	VOK	27,00			Kit idro Toyota Tacoma 4/6 Cyl.2005,crem. Ø27		
55X090	VOK	26,70			Kit idro Toyota Avensis Verso crem. Ø26,7,anno 2001		
• 55X091	VOK	24,00			Kit idro Toyota Avensis, crem. Ø24, dal 2006		
55X601	VOP				Kit pompa T. Camry "83-86,T. Corolla DX,Tercel "82-88		
55X602	VOP				Kit pompa Toyota Camry "83-86		
55X603	VOP				Kit pompa Toyota Camry 83-86,Celica,Corolla 87-92		
55X604	VOP				Kit pompa Toyota Celica "82-89,Corolla		
55X605	VOP				Kit pompa Toyota Cressida "88-89,Supra "88-93		
55X606	VOP				Kit pompa Toyota Landcruiser "70-87,Crown		
55X607	VOP			18,00	Kit pompa Toyota Landcruiser "90-92, albero Ø18		
55X608	VOP				Kit pompa Toyota Lexus LS400 "89-93		
55X609	VOP				Kit pompa Toyota T100 6CYL "94-96		
55X610	VOP			17,00	Kit pompa Toyota Landcruiser 1992, albero Ø17		
55X611	VOP				Kit pompa Toyota Previa "90-95		
55X612	VOP				Kit pompa Toyota Solara 2002		
55X613	VOP				Kit pompa Toyota Geo Tracker "99-03		
55X614	VOP			18,00	Kit pompa Toyota Carina 1.6, albero Ø18		
55X615	VOP			17,00	Kit pompa Lexus LS 430,Rav 4,Toyota Avalon2005/07,Dodge Dakota, albero Ø17		
55X616	VOP				Kit pompa Toyota Landcruiser "88-99		
55X617	VOP				Kit pompa Geo Storm "90/93		
55X618	VOP				Kit pompa Lexus SC300/GS300		
55X619	VOP				Kit pompa Lexus GS300 "98-01		
55X620	VOP				Kit pompa Toyota Carina 2000		
• 55X621					Kit Pompa Toyota Land Cruiser 100 (J10) 4.2 TD '01/'98		
55X701	OCD				cuffia cremagliera idro DX Toyota Corona EXIV 2000 "89-/Camry "86- / Celica 4WD "86-"87		



Kit idroguida

Kits for power steering

Ремкомплекты для рулевого управления

Codice Code Код	Ref. Приме- нение	Ø crem. rack Ø	Ø distr. pinion Ø	Ø albero shaft Ø	Descrizione per utilizzo Use remarks Примечания	Cod. originale IDROGUIDA Оригинальный номер агрегата	Cod. originale KIT Оригинальный номер ремкомплекта
		Размеры					
55X702	OCD				cuffia cremagliera idro DX Toyota Corolla II /TERCEL CORSA - STARLET "86-"90		
55X703	OCS				cuffia cremagliera idro SX Toyota Corona EXIV 2000 "89-/Camry "86- / Celica 4WD "86-"87		
55X704	OCS				cuffia cremagliera idro SX Toyota Corolla II /TERCEL CORSA - STARLET "86-"90		
55X705	OCX				cuffia cremagliera idro SX/DX Toyota CARINA 5/84- 5/90/Corolla SPRINTER 1300-1500 83/87 1600 5/83 1800 00/83- LEVIN TRUENO 83/87		
55X706	OCX				cuffia cremagliera idro SX/DX Toyota Corona "83- / CARINA "90-"92		
55X707	OCX				cuffia cremagliera idro SX/DX Toyota Corolla Sprinter 1800 87/90 2000 89/90 -Levin - Trueno"87-"90 - Sprinter Carib 90/93		
55X708	OCX				cuffia cremagliera idro SX/DX Toyota Camry 00/92		
55X709	OCX				cuffia cremagliera idro SX/DX Toyota Corolla		
55X710	OCX				cuffia cremagliera idro SX/DX Toyota Celica "89-"90		
55X711	OCX				cuffia cremagliera idro SX/DX Toyota Mark II "84-"88		
55X712	OCX				cuffia cremagliera idro SX/DX Toyota Camry-VISTA - "86		
55X713	OCX				cuffia cremagliera idro SX/DX Toyota Mark II "88- / Corolla 1300-1500 90/95 Corolla 1600 87/2000 90- 94-LEVIN 1500 95 -1600 90/95 / Marino "90> - SPRINTER CARIB 95>		
55X714	OCX				cuffia cremagliera idro SX/DX Toyota Corona COUPE' 85-/CARINA 92> - Celica 85/87 - Corona EXIV 89>		
55X715	OCX				cuffia cremagliera idro SX/DX Toyota Corolla II 90> - MR2 - 2000cc "89>-TERCEL 90/92 - CYNOS 90 -		
55X716	OCX				cuffia cremagliera idro SX/DX Toyota Corolla /SPRINTER 0,5-0,6 82/90 - TERCEL - STARLET "82/89 - Corolla II 82/86		
55X717	OCX				cuffia cremagliera idro SX/DX Toyota Corolla-CYNOS 0,5		
55X718	OCD				cuffia cremagliera idro DX Toyota Corolla II - TERCEL CORSA STARLET		
55X719	OCS				cuffia cremagliera idro SX Toyota Corolla II - TERCEL CORSA STARLET		
55X720	OCC				kit cuffie cremagliera idro DX/SX Toyota Corona EXIV 2000 "89-Camry "86- / Celica 4WD "86-"87 (completo)		
55X721	OCC				kit cuffie cremagliera idro DX/SX Toyota Corolla II / TERCEL CORSA - STARLET "86-"90 (completo)		
55X722	OCC				kit cuffie cremagliera idro DX/SX Toyota Corolla II - TERCEL CORSA STARLET (completo)		
55X723	OCX				Cuffia idro termoplastico SX/DX, Toyota Landcruiser 1989 in poi		
• 55X724	OCX				Cuffia idro termoplastico SX/DX Toyota Carina E		
• 55X725	OCX				Cuffia idro termoplastico SX/DX Toyota Land Cruiser '2003		
• 55X726	OCX				Cuffia idro termoplastico SX/DX Toyota Carina, Berlina- Wagon 1994-'95		

VOK Kit idroguida Power steering kit Ремкомплект рулевого управления
VOC Kit cremagliera Rack kit Ремкомплект гидроцилиндра
VOD Kit distributore Pignon kit Ремкомплект распределителя
VOP Kit pompa Pump kit Ремкомплект насоса
OCD Cuffia destra Rack boot (right) Правый сайлентблок
OCS Cuffia sinistra Rack boot (left) Левый сайлентблок
OCX Cuffie sinistra+destra Rack boot (left+right) Набор сайлентблоков
OCC Kit cuffie Rack boot kit Ремкомплект сайлентблоков



Codice Code Код	Ref. Приме- нение	Ø crem. rack Ø	Ø distr. pinion Ø	Ø albero shaft Ø	Descrizione per utilizzo Use remarks Примечания	Cod. originale IDROGUIDA Оригинальный номер агрегата	Cod. originale KIT Оригинальный номер ремкомплекта
● 55X727	OCX				Cuffia idro termoplastico SX/DX Toyota Corolla Verso dal 2004, Avensis Wagon 1997-'03		
● 55X728	OCX				Cuffia idro termoplastico SX/DX Toyota Corolla E12 dal 2003 in poi		
● 55X729	OCX				Cuffia idro termoplastico SX/DX Toyota Corolla E12 dal 2001 al 2003, RAV 4 2003-'05		
● 55X730	OCX				Cuffia idro termoplastico SX/DX Toyota Previa 2001-'03		
● 55X731	OCX				Cuffia idro termoplastico SX/DX Toyota Prius 2000-'02		
55X751	OCD				cuffia man. DX Toyota Corona		
55X752	OCS				cuffia man. SX Toyota Corona		
55X753	OCD				cuffia man. DX Toyota Camry		
55X754	OCS				cuffia man. SX Toyota Camry		
55X755	OCX				cuffia man. SX/DX Toyota Carin		
55X756	OCD				cuffia man. DX Toyota MR2		
55X757	OCS				cuffia man. SX Toyota MR2		
55X758	OCD				cuffia man. DX Toyota Corolla		
55X759	OCS				cuffia man. SX Toyota Corolla		
55X760	OCX				cuffia man. SX/DX Toyota Terce		
55X761	OCD				cuffia man. DX Toyota Cressidr		
55X762	OCS				cuffia man. SX Toyota Cressidr		
55X763	OCC				kit cuffie man. Toyota Corona		
55X764	OCC				kit cuffie man. Toyota Camry		
55X765	OCC				kit cuffie man. MR2		
55X766	OCC				kit cuffie man. Toyota Corolla		
55X767	OCC				kit cuffie man. Toyota Cressidr		
● 55XE900					Idroguida elettrica Toyota Yaris 1° serie		
● 55XE901					Idroguida elettrica Toyota Auris volante regolabile		
● 55XE902					Idroguida elettrica Toyota Auris volante fisso		

Volvo

58X

Codice Code Код	Ref. Приме- нение	Ø crem. rack Ø	Ø distr. pinion Ø	Ø albero shaft Ø	Descrizione per utilizzo Use remarks Примечания	Cod. originale IDROGUIDA Оригинальный номер агрегата	Cod. originale KIT Оригинальный номер ремкомплекта
58X001	VOK				Kit idro Volvo 240, 260 CAM		
58X002	VOK				Kit idro Volvo 240, 260 CAM '82/88		
58X003	VOK				Kit idro Volvo 240,260 CAM 1979/82		
58X004	VOK	25,00			Kit idro Volvo 240/260 1982-89, crem. Ø25		271547-2
58X005	VOK	25,00			Kit idroTRW Volvo 360, 660, 440, 740, 760, 850, con due paraoli dis.6, crem. Ø25		
58X006	VOK				Kit idro Koyo Volvo 740,760		
58X007	VOK				Kit idro TRW Volvo 740, 760 '83/88, F.		
58X008	VOK	26,00			Kit idro ZF Volvo 240, 260 '79/88, II serie, crem. Ø26	7832955101/ 7832955108/ 7832955108	7832/1
58X009	VOK				Kit idro ZF Volvo 240, 260 '79/88 I°serie	7840955103	7840/2
58X010	VOK	26,00			Kit idro ZF Volvo 240, 260 III serie, crem. Ø26	7832955106/ 7832985101	7832/4
58X011	VOK				Kit idro Volvo ZF	7820955123	7820/109
58X012	VOK				Kit idro Volvo ZF	7820955127	7820/111
58X013	VOK				Kit idro Volvo CAM 240, 260 '74/79		



Kit idroguida

Kits for power steering

Ремкомплекты для рулевого управления

Codice Code Код	Ref. Приме- нение	Ø crem. rack Ø	Ø distr. pinion Ø	Ø albero shaft Ø	Descrizione per utilizzo Use remarks Примечания	Cod. originale IDROGUIDA Оригинальный номер агрегата	Cod. originale KIT Оригинальный номер ремкомплекта
58X014	VOK	24,00			Kit idro ZF Volvo 740, 760 '83/88, Scorpio'88/90		7831/3
58X015	VOK	24,00			Kit idro Koyo - Volvo S40,V40 '95/03, V70 crem. Ø24, Carisma '96		
58X016	VOK	25,00			Kit idro TRW Volvo S70,V70, crem. Ø25		
58X017	VOK	25,00			Kit idro TRW Volvo 740, 940, crem. Ø25		
58X018	VOK	27,70			Kit idro Koyo/Smi Volvo, crem 27,7		
58X019	VOK	25,00			Kit idro SMI Volvo 850 '91/96, V70, S70 '98/00		
58X020	VOK	25,00			Kit idro TRW Volvo, con due paraoli dis. 6		
58X021	VOK	27,70			Kit idro ZF Volvo S80, non servotronic		
58X022	VOK	24,00			Kit idro SMI Volvo V70, S70, V40, S40, crem. Ø24		
58X023	VOK	28,00			Kit idro Volvo 60, C70, S70, V70, XC90, crem. Ø28		
• 58X024	VOK	24,00			Kit idro Koyo Volvo V40, anno 2000 in poi		
58X600	VOP			17,00	kit pompa ZF Volvo, albero Ø17		7673/2
58X601	VOP			19,05	kit pompa Volvo, albero Ø19,05		
58X701	OCD				cuffie cremagliera (TRW) idro Dx Volvo 240/260 1900-2000 82-93/Volvo 100-154 82-85 / 2300-2400 82- 93 - 740 - 760 /92		
58X702	OCS				cuffie cremagliera (TRW) idro Sx Volvo 240, 260 1.9, 2.0, '82/93, Volvo 100, 154 '82/85, 2.3, 2.4 ' 82/93, 740, 760 '92		
58X703	OCX				cuffie cremagliera (ZF) manuale Volvo 440, 460, 480 '89		
58X704	OCX				cuffie cremagliera (TRW) idro Volvo 240, 260 1.9, 2.0 ' 74/81 - Volvo 240, 260 2.1, 3.0, 2.4D '76/81		
58X705	OCX				cuffie cremagliera idro Volvo 440, 460, 480, '88		
• 58X706	OCX				cuffia idro termoplastico SX/DX Volvo C70/S60-S70-S80-S90/V70-V90		
• 58X707	OCX				cuffia idro termoplastico SX/DX Volvo 850, S60-S70-S80-S90 Berlina, V70-V90 Wagon		
• 58X708	OCX				cuffia idro termoplastico SX/DX Volvo S80 Berlina 3.0 1998-'04		
• 58X709	OCX				Cuffia idro termoplastico SX/DX Volvo 480 1986-'94, S40 1995-'03, C70 Cabrio 1999-'03		
58X710	OCC				kit cuffie cremagliera (TRW) idro Dx/Sx Volvo 240, 260 1.9, 2.0 '82/93, Volvo 100, 154 '82/85, 2,3, 2,4, '82/93 (completo)		
• 58X711	OCX				Cuffia idro termoplastico SX/DX Volvo V70 Wagon 2004, S80 Berlina 2004		
58X751	OCD				cuffie manuale Dx Volvo 240, 260		
58X752	OCS				cuffie manuale Sx Volvo 240, 260		
58X753	OCX				cuffie manuale Sx/Dx Volvo 240, 260		
58X754	OCD				cuffie manuale Dx Volvo 240, 260		
58X755	OCS				cuffie manuale Sx Volvo 240, 260		
58X756	OCD				cuffie manuale Dx Volvo 340		
58X757	OCS				cuffie manuale Sx Volvo 340		
58X759	OCX				cuffie manuale Sx/Dx Volvo 740		
58X760	OCC				kit cuffie manuali Volvo 240, 260		
58X761	OCC				kit cuffie manuale Volvo 240, 260		
58X762	OCC				cuffia Volvo		

VOK Kit idroguida	Power steering kit	Ремкомплект рулевого управления	 OCD Cuffia destra	Rack boot (right)	Правый сайлентблок
VOC Kit cremagliera	Rack kit	Ремкомплект гидроцилиндра	 OCS Cuffia sinistra	Rack boot (left)	Левый сайлентблок
VOD Kit distributore	Pignon kit	Ремкомплект распределителя	 OCX Cuffie sinistra+destra	Rack boot (left+right)	Набор сайлентблоков
VOP Kit pompa	Pump kit	Ремкомплект насоса	 OCC Kit cuffie	Rack boot kit	Ремкомплект сайлентблоков



Trattori e macchine agricole

Tractors and agricultural machines Тракторы и сельскохозяйственная техника

Codice Code Код	Descrizione per utilizzo Use remarks Примечания	Versione Version Версия	Marca Brand Марка	Cod. scatola Box code Код редуктора	Rif. kit Kit reference Ремкомплект применяется
80X001	kit idro TRW Ø23 Ø30,7 SAM/1, Man Magirus	Trattore	TRW		
80X002	Kit idro ZF trattore macchine agricole	Trattore	ZF	8450 633 332	

Camion e veicoli pesanti

Trucks and heavy vehicles Грузовые транспортные средства

Codice Code Код	Descrizione per utilizzo Use remarks Примечания	Versione Version Версия	Marca Brand Марка	Cod. scatola Box code Код редуктора	Rif. kit Kit reference Ремкомплект применяется
81X001	kit idro compl.TAS30-124740 Iveco, M.Magirus-R. Mascotte	Genuine	TRW	TAS30-4834721	
81X001E	kit guarnizioni alleg. Albero entrata TAS30-124740	Light		TAS30	
81X001M	kit idro a settore TAS 30 Iveco,Man Magirus	Modificato	TRW	TAS30-4834721	
81X002	kit idro a settore completo TAS 55,Iveco, Man Magirus	Genuine	TRW	TAS55-4834724	
81X002E	kit guarnizioni alleg.albero entrante TAS 55	Light		TAS55	
81X002M	kit idro a settore TAS 55 Iveco,Man Magirus modif.	Modificato	TRW	TAS55-4834724	
81X003	kit idro a settore comp. TAS 75,Iveco,Scania,Volvo,Daf	Genuine	TRW	TAS75-75621/75611	
81X003E	kit guarnizioni alleg. albero entrante TAS 75	Light		TAS75	
81X003M	kit idro a settore TAS 75 Scania,Volvo,Daf modif.	Modificato	TRW	TAS75621/75611	
• 81X003X	kit idro a settore comp. TAS 75,Iveco,Scania,Volvo,Daf	Genuine	TRW	TAS75-75621/75611	
81X004	kit idro compl.TAS 85,Scania, Volvo,Daf TRW	Genuine	Scania	TAS85-85605/10 1317734	
81X004E	kit guarnizioni alleg. albero entrante TAS 85	Light		TAS85	
81X004M	kit idro a settore TAS 85, Scania,Volvo,Daf modif.	Modificato	TRW Scania	TAS85-85625 1353442	
• 81X004X	kit idro compl.TAS 85, Scania, Volvo,Daf TRW	Genuine	Scania	TAS85-85605/10 1317734	
81X005	kit idro a settore TAS 86-87 Renault	Genuine	TRW Scania	TAS86-87-/601/609 387885	
81X006	kit idro completo HFB52, Daf, Scania, Astra,Iveco + Guida Torfinasa	Genuine	TRW	HFB52	
81X006E	kit guarnizioni HFB52 Alleggerito - Albero entr. Astra Iveco	Light		HFB52	
81X006M	kit idro a settore completo HFB52 Scania-Daf-Astra-Iveco	Modificato		HFB52	
81X006U	kit guarnizioni alleggerito HFB52 albero uscita.Astra,Iveco	Light		HFB52	
81X007	kit idro a settore completo HFB70, Scania, Daf, Astra	Genuine	TRW DAF	HFB70-19000053 550949	
81X007E	kit guarnizioni HFB70 alleggerito albero entrata	Light		HFB70	
81X007M	kit idro completo HFB70, Daf, Scania, Astra	Modificato	TRW	HFB70-19000053	
81X007U	kit guarnizioni HFB70 alleggerito, albero uscita	Light		HFB70	
81X008	kit idro a settore completo HFB70,HFB64 Scania,Daf,Astra,Peugeot, Ford Cargo	Genuine		HFB64-HFB70	1645618 & 79HB3L548AC
81X009	kit idro a settore completo Nissan Ebro	Genuine			8033/1
81X010	kit idro a settore completo Nissan Trade,albero Ø35	Genuine			



Kit idroguida

Kits for power steering

Ремкомплекты для рулевого управления

Codice Code Код	Descrizione per utilizzo Use remarks Примечания	Versione Version	Marca Brand	Cod. scatola Box code	Rif. kit Kit reference
81X011	kit idro a settore completo 585 HDS-HDS 450-HDS Riva Calzoni	Genuine	Riva Calzoni	HDS585/HDS450	
81X012	kit idro a settore completo Iveco 115, HFB52 + Guida Torfinasa	Genuine	TRW	HFB52	
81X012M	kit idro a settore completo Iveco 115	Modificato	TRW	HFB52	
81X013	kit idro a settore completo Iveco 135, HFB52 + Guida Torfinasa	Genuine	TRW	HFB52	
81X013M	kit idro a settore completo Iveco 135, HFB52 Modificato	Modificato	TRW	HFB52	
81X014	kit idro a settore completo TRW Iveco 145, HFB52 + Guida Torfinasa	Genuine	TRW	HFB52	
81X014M	kit idro a settore completo Iveco 145 - modificato	Modificato	TRW	HFB52	
81X015	kit idro a settore completo - Nissan L70 4000	Genuine		L70 4000	
81X015M	kit idro a settore completo - Nissan L70 4000	Modificato		L70 4000	
81X016	kit idro ZF a settore completo Iveco, Scania K113	Genuine	ZF	8044955120/116/119	8044633010
81X017	kit idro ZF a settore completo Iveco, Volvo	Genuine	ZF	8037955129	8037633005
81X018	kit idro completo a settore ZF Eurocargo 8043-Iveco 190SX	Genuine	ZF	8043955112	8043633009
81X018M	kit idro completo a settore Eurocargo ZF 8043- Modificato	Modificato	ZF	8043955187	8043633009
81X019	kit idro completo Riva Calzoni HDS 260	Genuine	Riva Calzoni		
81X019M	kit idro a settore completo Riva Calzoni HDS 260	Modificato	Riva Calzoni		
81X020M	kit idro a settore completo Bendix Ford Cargo	Modificato	Bendix		
81X021	kit idro a settore completo per Spazzatrice HFB54	Genuine		HFB54	
81X021M	kit idro a settore per Spazzatrice HFB54	Modificato		HFB54	
81X022M	kit idro a settore completo Bedford, Bendix Ford Cargo, Volvo, Burman	Modificato			
81X023	kit idro a settore completo TAS 15	Genuine	TRW	TAS15M603	
81X023M	kit idro a settore completo TAS 15	Modificato	TRW	TAS15M603	
81X024	kit idro a settore completo Riva Calzoni HDA 45,13	Genuine	Riva Calzoni	HDA45/13	
81X024M	kit idro a settore completo Riva Calzoni HDA 45,13	Modificato	Riva Calzoni	HDA45/13	
81X025	kit completo ZF 8043 Iveco 330-190 Originale	Genuine	ZF	8043955118/112	8043633009
81X025M	kit completo ZF 8043 Iveco 330	Modificato	ZF	8043955118/112	8043633009
81X026	kit idro completo a settore Riva Calzoni HS 50	Genuine	Riva Calzoni		
81X027M	kit idro a settore completo Mercedes LS8 (doppio distributore)	Modificato	Mercedes	LS8	
81X028	kit idro Mercedes LS4	Genuine		LS4	
81X028M	kit idro completo a settore Mercedes LS4	Modificato		LS4	
81X029M	kit idro a settore completo Mercedes LS6 U.T.	Modificato	Mercedes	LS6 -A974	
81X030M	kit idro a settore completo Mercedes LS6 OLD	Modificato	Mercedes	LS6 -A616	
81X031M	kit idro a settore completo Mercedes LS8 U.T.	Modificato	Mercedes	LS8 -940 461 1801	9400001
81X032A	kit completo Mercedes LS8 OLD (1°revisione)	modificato	Mercedes	LS8	
81X032M	kit idro a settore completo Mercedes LS8(2°Revisione)	Modificato	Mercedes	LS8-646 460 0300 (arriva fino a 2002 ca.)	9400002
81X033	kit completo Mercedes LS2 Jeep	Genuine	Mercedes	LS2	
81X034	kit completo Mercedes LS3 Ø40	Genuine	Mercedes	LS3 Ø40	
81X035	kit idro completo Mercedes LS3,Ø47 genuine	Genuine	Mercedes	LS3 Ø47	
81X036	kit completo Mercedes LS3 Ø52 A 674	Genuine	Mercedes	LS3 Ø52	
81X037	kit completo Mercedes LS5	Genuine	Mercedes	LS5-3854610401	
81X038	kit completo Mercedes LS7	Genuine	Mercedes	LS7	
81X039	kit riparazione ZF Iveco Man , Eurotech 440, Renault Magnum, Volvo 629	Genuine	ZF	8098955105/ 183/102/113/370/629	8098/3

VOK Kit idroguida *Power steering kit Ремкомплект рулевого управления*
 OCD Cuffia destra *Rack boot (right) Правый сайлентблок*
VOC Kit cremagliera *Rack kit Ремкомплект гидроцилиндра*
 OCS Cuffia sinistra *Rack boot (left) Левый сайлентблок*
VOD Kit distributore *Pignon kit Ремкомплект распределителя*
 OCX Cuffie sinistra+destra *Rack boot (left+right) Набор сайлентблоков*
VOP Kit pompa *Pump kit Ремкомплект насоса*
 OCC Kit cuffie *Rack boot kit Ремкомплект сайлентблоков*



Codice Code Код	Descrizione per utilizzo Use remarks Примечания	Versione Version	Marca Brand	Cod. scatola Box code	Rif. kit Kit reference
81X040	kit completo Riva Calzoni HS18, HS24	Genuine	Riva calzoni	HS18/HS24	
81X041	kit completo Riva Calzoni HS25,35	Genuine	Riva calzoni	HS25/35	
81X042	kit completo Riva Calzoni HS36	Genuine	Riva calzoni	HS36	
81X043	kit guarnizioni idrostatiche GI-GIVI OLD V	Genuine			
81X044	kit guide idrostatiche GI- GIVI-U.	Genuine			
81X045	kit guarnizioni viton (motore 6.0 6,0 Alghi)	Genuine			
81X046	kit guarnizioni viton Termoregolatore	Genuine			
81X047	kit completo Genuine Iveco,Eurocargo,Ford	Genuine	ZF	8090955117 8090955133 8090955115	8090/10
81X048	kit idro completo Volvo ZF	Genuine	ZF	8045955138 - 8045955131	8045/14
81X049	kit completo ZF Scania 112,82M	Genuine	ZF	8044955114/118/9 8097955103/130	8044/7
81X050	kit completo ZF Eurocargo,Bus	Genuine	ZF		8065/35
81X051	kit idro Eurocargo 150 ZF	Genuine	ZF	8095955117	8095633005/006
81X052	kit completo Falcon - Bremach		Falcon - Bremach		
81X053	kit idro completo ZF Scania 113,Daf	Genuine	ZF	8097955103/115/130 8097955143	8097/5
81X054	kit completo ZF ERF serie C	Genuine	ZF	8043955120	8043/34
81X055	kit idro completo Iveco, Man ZF	Genuine	ZF	8096955101	8096/3
81X056	kit idro ZF Volvo FL7,F10	Genuine	ZF	043955103/142 & 8043955101	8043/39
81X057	kit idro completo TAS 20 606 TRW,albero Ø35		TRW	TAS20 606	
81X058	kit idro TAS 20 M616-617,(genuine-originale)	Completo	TRW	TAS20 M616-617	49210F3904
• 81X058M	kit idro TAS 20 M616-617, (modificato)	Completo	TRW	TAS20 M616-617	49210F3904
81X059	kit revisione parte pistone OM 40 T35,27R	Completo	OM	OM40	
81X060	kit idro ZF Iveco 100-14 109-14	Genuine	ZF	8036955119	8036/11
81X061	kit idro ZF MAN	Genuine	ZF	046955111 8046955230	8046/6
81X062	kit idro a settore TAS 55 & 65			TAS55-65	
81X063	kit idro Sheppard serie M		Sheppard		
81X064	kit idro Saginaw doppio pistone-veicolo pesante		Saginaw		
81X065	kit idro a settore Sheppard M100, M90		Sheppard	M100-M90	
81X066	kit idro Leyland Cruiser		ZF	8097955145	8097/014
81X067	kit idro Ross HF64			HF64	
81X068	kit idro Leyland road runner	Genuine	ZF	8097955145	8037/3
81X069	kit idro Ross HF54			HF54	
81X070	kit idro Airport Tug	Genuine	ZF		8055/14
81X071	kit idro veicoli pesanti (vari modelli)	Genuine	ZF	8055955121	8043/35
81X072	kit idro Volvo FL6			FL6	
81X073	kit idro ZF	Genuine	ZF		7860/1
81X074	kit idro Leyland constr.24-26	Genuine	ZF	8043955220	8043/9
81X075	kit idro veicoli pesanti Saginaw		Saginaw		
81X076	kit idro mod. 800 albero Piccolo (79)		Saginaw		
81X077	kit idro N40 1990-95, doppio pistone-Veicoli pesanti		Saginaw	26013044	
81X078	kit idro TAS 40, completo di teflon, o-ring-Veicoli pesanti			TAS40	
81X079	kit idro Dennis Javelin & Lancer		ZF	8095955127/140	8095/10



Kit idroguida

Kits for power steering

Ремкомплекты для рулевого управления

Codice Code Код	Descrizione per utilizzo Use remarks Примечания	Versione Version	Marca Brand	Cod. scatola Box code	Rif. kit Kit reference
81X080	kit idro Ford cargo, BedFord TL 750 1986-87, HFB52			HFB52-1645621 & 6081656 & 91101900 & 81DB3L548AC & 81DB3L548BA	
81X081	kit idro Bristol			114VRG/4	
81X082	kit idro veicoli pesanti Saginaw		Saginaw		
81X083	kit idro Sheppard 492 3;4;5 serie		Sheppard		
81X084	kit idro camion (vari modelli)	Genuine	ZF		8043/17
81X085	kit idro Leyland	Genuine	ZF		8045/15
81X086	kit idro veicoli pesanti (vari modelli)	Genuine	ZF		8090/14
81X087	kit idro veicoli pesanti (vari modelli)	Genuine	ZF	8098955108	8098/7
81X088	kit idro Nissan D21 4WD 1993-97				
81X089	kit idro Saginaw 605, anno 1979-90		Saginaw		
81X090	kit idro ZF Trattore Daf , R. Magnum	Genuine	ZF	8098955102 8098955326 8098955113 8098955183	8098/3
81X091	kit idro veicoli pesanti mod.710 doppio albero Saginaw		Saginaw		
81X092	kit idro veicoli pesanti (vari modelli)	Genuine	ZF		8043/28
81X093	kit idro ERF serie "E"	Genuine	ZF	8097955110	8097/7
81X094	kit idro Sheppard 592 3;4;5 serie		Sheppard		
81X095	kit idro veicoli pesanti (vari modelli)	Genuine	ZF		8046/6
81X096	kit idro MCW	Genuine	ZF	8095955119	8095/4
81X097	kit idro Scania 112	Genuine	ZF	8066995104	8066/1
81X098	kit idro Volvo NL10-12,man. misc.	Genuine	ZF	8045955155 & 8043955154	8043/13
81X099	kit idro Sheppard 392 6 serie		Sheppard		
81X100	kit idro veicoli pesanti (vari modelli)	Genuine	ZF		8033/1
81X101	kit idro camion (vari modelli)	Genuine	ZF		8037/13
81X102	kit idro Metrobus,MCW	Genuine	ZF	8065955282	8065/37
81X103	kit idro veicoli pesanti (vari modelli)	Genuine	ZF		8043/19
81X104	kit idro Leyland road runner	Genuine	ZF	8090955110	8090/6
81X105	kit idro ERF serie "C"	Genuine	ZF	8098955234	8098/11
81X106	kit idro ZF veicoli pesanti,mini bus	Genuine	ZF	8090955116	8090/8
81X107	kit idro BedFord TM, Leyland costrutor, HFB70			HFB70-GM91062405	
81X108	kit idro veicoli pesanti (vari modelli)	Genuine	ZF		8046/21
81X109	kit idro Sheppard 292 3;4;5 serie		Sheppard		
81X110	kit idro veicoli pesanti (vari modelli)	Genuine	ZF		8046/17
81X111	kit idro veicoli pesanti (vari modelli)	Genuine	ZF		8037/7
81X112	kit idro Saginaw mod.800 albero grande, anno 1979		Saginaw		
81X113	kit idro Sheppard 392 (95)		Sheppard		
81X114	kit idro TRW TAS 65, senza parte metallica		TRW	TAS65	
81X115	kit idro Leyland Freighter 13,14	Genuine	ZF	8043955220	8043/6
81X116	kit idro Renault 290	Genuine	ZF	8044100026	8044633007+2 del 8046040113
81X117	kit idro R. linea II. ,R. Magnum	Genuine	ZF	8098955112 8098955326 8298955113	8098/3
81X118	kit idro Renault linea 40 C.h	Genuine	ZF	8095955108	8095633005/006
81X119	kit idro Renault linea 40 D.	Genuine	ZF	8095955109	8095633005/006

VOK Kit idroguida *Power steering kit Ремкомплект рулевого управления* **OCD** Cuffia destra *Rack boot (right) Правый сайлентблок*
VOC Kit cremagliera *Rack kit Ремкомплект гидроцилиндра* **OCS** Cuffia sinistra *Rack boot (left) Левый сайлентблок*
VOD Kit distributore *Pignon kit Ремкомплект распределителя* **OCX** Cuffie sinistra+destra *Rack boot (left+right) Набор сайлентблоков*
VOP Kit pompa *Pump kit Ремкомплект насоса* **OCC** Kit cuffie *Rack boot kit Ремкомплект сайлентблоков*



Codice Code Код	Descrizione per utilizzo Use remarks Примечания	Versione Version	Marca Brand	Cod. scatola Box code	Rif. kit Kit reference
81X120	kit idro Renault linea I.	Genuine	ZF	8098965114	8098/17
81X121	kit idro Renault H 100 4x2; 6x2	Genuine	ZF	098965134/ 8098965118	8098/62 8098/33
81X122	kit idro Renault H.300 4x2;6X2	Genuine	ZF	8098955322	8098/42
81X123	kit riparazione ZF cilindro III° Asse I° serie Iveco		ZF	8347955161	8137827
81X124	kit riparazione ZF cilindro post. III° Asse II° serie Impianto Ras Scania - Iveco	Genuine	ZF	346955165 8346955183	41032945-1371321
81X125	kit riparazione ZF cilindro ant. III° Asse II° serie impianto ras Scania-Iveco		ZF	8346955168 - 8346955182 - 8346955163	41032671
81X126	kit idro ZF Volvo	Genuine	ZF	8046955179	8046/37
81X127	kit idro ZF 4 assi Volvo	Genuine	ZF	8099955608	8099/503
81X128	kit idro veicolo commerciale ML 320		ZF	7852501372	
81X129	kit idro Renault M. S 180			S180	
81X130	kit idro Sheppard M100-Veicolo pesante		Sheppard	M100	
81X131	kit idro Sheppard M90		Sheppard	M90	
81X132	kit idro TAS 40,55,65,85 - Veicolo commerciale			TAS40/55/65/85	
81X133	kit idro Leyland Daf 45-veicoli pesanti		ZF	8090955151	8090/16
81X134	kit idro Sheppard 292 serie 6-veicoli pesanti		Sheppard		
81X135	kit idro Sheppard 39 2serie 6-veicoli pesanti		Sheppard		
81X136	kit idro TAS 75-Daf 75,85-Scania 4°serie-Volvo FL6			TAS75-3091793	
81X137	kit idro di bloccaggio albero Ø27 Sheppard-veicoli pesanti				
81X138	kit idro Sheppard M80-veicoli pesanti		Sheppard	M80	
81X139	kit idro Ldv Van 200-400,albero Ø36,distrib.Ø20				
81X140	kit idro ZF Autocarro		ZF		8066/6 8066/8
81X141	kit idro ZF Volvo-veicoli pesanti		ZF	8046965111	8046/27
81X142	kit idro Mercedes a settore-veicoli pesanti				
81X143	kit idro Tas 80 TRW-veicoli pesanti		TRW	TAS80-1363882 / 1363860	80605 / 80601
81X144	kit idro TAS 75,85,86,87			TAS75-85-86-87	
81X145M	kit idro THP 80 X Daf			THP80	
81X146	kit idro ZF Magirus		ZF		8060633004
81X147	kit idro ZF Iveco Eurotruk,Astra 1° serie(doppio circuito)		ZF		8099/9
81X148	kit idro TAS 60 (paraoli albero entrata)			TAS60	
81X149	kit idro TAS 60 (paraoli albero uscita)			TAS60	
81X150	kit idro TAS 80 (paraoli albero entrata)			TAS80	
81X151	kit idro TAS 80 (paraoli albero uscita)			TAS80	
81X152	kit idro TAS 80 (valvola decompressione)			TAS80	
81X153	kit viti regolazione tubolare				
81X154	kit vite registro coperchio dell'albero TAS30,55			TAS30/55	
81X155	kit vite registro coperchio dell'albero TAS75,85			TAS75/85	
81X156	kit idro TAS 85 602,605-THP80			TAS85 602- 605,THP80	
81X157	kit idro completo veicoli commerciali THP90			THP90	
81X158	kit idro completo THP91-92			THP91-92	
81X159	kit idro alleggerito Sheppard M80 2000,07			M80	
81X160	kit idro MAN TGA RBL 463 (CLS)			RBL463	
81X161	kit idro Omai Falcon J9 TRW AP 8		TRW		
81X162	kit idro pignone LDV VAN,con P.T.FE X stelo Ø20	LDV			
81X163	kit idro scatola ZF,veicoli pesanti -Veicoli pesanti		ZF		8095633008
81X164	kit idro ZF veicoli pesanti MAN,Volvo-Veicoli pesanti		ZF		8098/64



Kit idroguida

Kits for power steering

Ремкомплекты для рулевого управления

Codice Code Код	Descrizione per utilizzo Use remarks Примечания	Versione Version	Marca Brand	Cod. scatola Box code	Rif. kit Kit reference
81X165	kit scatola veicolo pesante		ZF		8046/4
● 81X166	kit idro TAS 40, solo paraoli + guarnizione in ferro- Veicoli pesanti		TRW	TAS40	
● 81X167	kit idro Sheppard M90, U.T.-Veicoli pesanti		Sheppard	M90	
● 81X168	kit idro-HF64, (paraoli albero entrata)Veicolo commerciale		TRW	HF64	
● 81X169	kit idro-HF52, (paraoli albero entrata)Veicolo commerciale		TRW	HF52	
● 81X170	kit idro-HFB70, (paraoli albero entrata)Veicolo commerciale		TRW	HFB70	
● 81X171	kit idro-HFB70,Trunion-Veicolo commerciale		TRW	HFB70	
● 81X172	kit idro Sheppard M100,solo con dado su albero a settore Veicolo commerciale		Sheppard	M100	
● 81X173	kit idro- HF54, (paraoli albero entrata)-Veicolo commerciale		TRW	HF54	
● 81X174	kit idro-HFB54, Trunion-Veicolo commerciale		TRW	HFB54	
● 81X175	kit idro TRW TAS 65, con parte metallica-Veicolo commerciale		TRW	TAS65	
● 81X176	kit distributore THP 200 VR,(PTFE+o-ring)-Veicoli pesanti			THP200	
● 81X177	kit distributore THP 100 VR, (PTFE+o-ring)-Veicoli pesanti			THP100	
● 81X178	kit idro veicoli commerciali TRW THP 60-		TRW	THP600001	
● 81X179	kit idro veicoli commerciali TRW THP 45-Veicoli pesanti		TRW	THP450001	
● 81X180	kit idro Falcon-Daf cod. Scatola ZF 8090955154		ZF		8090/501
● 81X181	kit idro Tas 80 TRW, doppio teflon		TRW	TAS80	
● 81X182	kit idro Renault Sheppard M83P2, piccola-Veicoli pesanti		Sheppard	M83P2	
81X601	kit pompa ZF Iveco 190,330 6-8 cil.	Genuine	ZF	7673955322 6CIL. 7674955232 8CIL 7674955298	7673/21
81X602	kit pompa Vickers Daf 80 - VT77V VT 59-16-16-135- (completo)			DAF80	
81X603	kit pompa ZF Iveco 100-14 109-14	Genuine	ZF		7677/3
81X604	kit pompa Vikers TYPE 02690				
81X605	kit pompa GM Haevy			5688233	
81X606	kit pompa LUK VT73 Haevy		LUK		
81X607	kit pompa Ford Haevy				
81X608	kit pompa Haevy -TRW-	Genuine	TRW	2501044C21	
81X609	kit pompa ZF Daf	Genuine	ZF		7673/10
81X610	kit pompa Volvo			1610367	
81X611	kit pompa ZF veicoli pesanti - (vari modelli)-	Genuine	ZF		7672/19 7672/10
81X612	kit pompa ZF Scania 113	Genuine	ZF	7677955129	7677/3
81X613	kit pompa ZF Scania	Genuine	ZF	7677955106	7677/2
81X614	kit pompa ZF Ford	Genuine	ZF	7677955137	7677/1
81X615	kit pompa ZF Iveco 300 - 30,24,34	Genuine	ZF	7677955137	7677/1
81X616	kit pompa ZF Scania 113	Genuine	ZF	7677955137	7677/1
81X617	kit pompa ZF MCW,optaire metrorider	Genuine	ZF		7636/2
81X618	kit pompa ZF Volvo F10,F12,N7,N10,N12,NL10,NL12,B6	Genuine	ZF	7673955209/ 12/13/19/202	7673/5
81X619	kit idro ZF -veicoli pesanti (vari modelli)	Genuine	ZF		7672/16 7672/7
81X620	kit pompa Fiat MKI				
81X621	kit pompa ZF Volvo Ailsa,F84,F85,F86,F6,F7,B55,B57	Genuine	ZF	673955131/141	7673/9

VOK Kit idroguida	<i>Power steering kit</i>	<i>Ремкомплект рулевого управления</i>	 OCD Cuffia destra	<i>Rack boot (right)</i>	<i>Правый сайлентблок</i>
VOC Kit cremagliera	<i>Rack kit</i>	<i>Ремкомплект гидроцилиндра</i>	 OCS Cuffia sinistra	<i>Rack boot (left)</i>	<i>Левый сайлентблок</i>
VOD Kit distributore	<i>Pignon kit</i>	<i>Ремкомплект распределителя</i>	 OCX Cuffie sinistra+destra	<i>Rack boot (left+right)</i>	<i>Набор сайлентблоков</i>
VOP Kit pompa	<i>Pump kit</i>	<i>Ремкомплект насоса</i>	 OCC Kit cuffie	<i>Rack boot kit</i>	<i>Ремкомплект сайлентблоков</i>



Codice Code Код	Descrizione per utilizzo Use remarks Примечания	Versione Version	Marca Brand	Cod. scatola Box code	Rif. kit Kit reference
81X622	kit pompa ZF MCW,optaire metrorider	Genuine	ZF	7673955571	7673/3
81X623	kit pompa Vickers		Vickers		
81X624	kit idro ZF - veicoli pesanti (vari modelli)	Genuine	ZF	7673955116	7673/1
81X625	kit pompa ZF Scania 92M,K39 Coach,112,113	Genuine	ZF	7674955217	7674/6
81X626	kit pompa Ford cargo, doppio albero Ø20 Veicolo commerciale				
81X627	kit pompa Vickers V10		Vickers	V10	
81X628	kit pompa Vickers V20		Vickers	V20	
81X629	kit pompa Bedford,Atkinson,Bristol,Leyland NT,			5321/104	
81X630	kit pompa SP20			SP20	
81X631	kit pompa Eaton tipo U				
81X632	kit pompa veicolo commerciale		ABU 7668	550/1/08894	
81X633	kit pompa Eaton serie "B" (vari modelli)				
81X634	kit pompa Navistar,Hobourn			596241C91	
81X635	kit pompa Fiat MKII				
81X636	kit pompa ZF veicoli pesanti (vari modelli)- Genuine	Genuine	ZF	7674974909	7674/16
81X637	kit pompa ZF F59	Genuine	ZF	7673900112/114	7673/38
81X638	kit pompa ZF veicoli pesanti (vari modelli)	Genuine	ZF	7677955180	7677/6
81X639	kit Pompa ZF Iveco EuroTracker 1993	Genuine	ZF	7673955266	7673/17
● 81X640	kit pompa veicolo industriale Renault 240, albero Ø17 (2 paraoli, 1 dis. 1PM e 1 dis. 0M2)-Veicolo commerciale				
● 81X641	kit pompa veicolo industriale Renault 240,albero Ø17 (un solo paraolio)-Veicolo commerciale		Renault 240		
81X900	Scatola inclinata TAS 80 (parte esterna di 1 scatola completa)		TRW		
81X901	Scatola inclinata TAS 80 ,completa di viti		TRW		
81X902	kit di riparazione Valvola a doppio circuito TAS87 (veicoli pesanti)		TRW		

Attrezzature usa e getta per montaggio paraoli "SOS Oil Seals"

Universal disposable assembling tools for seals "SOS Oil Seals"

Эластичная одноразовая плёнка для монтажа штока рулевой рейки

Z-09330

Questo tipo di attrezzatura è usata quando lo spazio tra l'albero e il paraolio è minimo: per esempio quando si deve montare un paraolio o una tenuta in teflon. Il teflon non si allarga come la gomma quindi, se si tenta di allargarlo ulteriormente, si deforma in modo permanente, rovinandosi.

L'attrezzatura si può usare per proteggere il labbro di tenuta del paraolio, quando quest'ultimo deve passare su una superficie ruvida o dentata: per esempio quella di un'asta o di un pignone con ruggine o rigature.

This kind of tool is used when the space between shaft and seal is small: for example, when you have to set a seal or a P.T.F.E. ring. The P.T.F.E. ring doesn't widen out as the rubber, so, if you try to enlarge it further, it loses its shape forever, and gets unusable. The equipment can be used to shelter the keeping lip of the seal, when the seal has to pass on a rough or toothed surface: for example the surface of a bar or a pinion with rust or scratches.

Используется для предотвращения повреждений рабочей части сальника, когда рабочий диаметр штока и диаметр штока в месте нарезки зубьев отличаются незначительно, либо совпадают. Используется однократно.



11064

in plastica cartacea speciale
made with special plastic paper

Codice Code Код	Min Ord Мин. количество заказа	A		B	
		Размеры			
Z-09330	10	100,00	80,00		
Z-09331	10	150,00	100,00		
Z-09332	10	200,00	100,00		

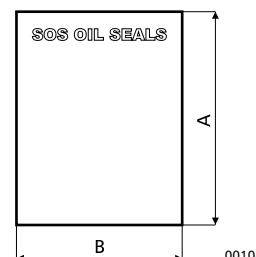

00108

Immettitori paraoli pignone in acciaio inox

Injectors in stainless steel for pinion seals

Металлический защитный наконечник

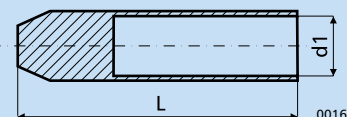

00166

Questa attrezzatura è la versione più semplice per l'inserimento del paraolio nella sua posizione di lavoro senza che esso venga danneggiato. E' formata da una parte conica con un foro centrale non passante che permette di scavalcare, senza danni, la parte dentata dell'albero del distributore, che sappiamo essere pericolosa per l'incolumità del paraolio.

This tool is the easiest version to insert the seal in its working position avoiding damages. It's made up of a conical part which has a no-passing hole. This part permits to overpass, without damages, the toothed part of the distributor shaft, which is dangerous for the seal safety.

Изготовлен из стали. Используется для предотвращения повреждений рабочей части сальника, когда рабочий диаметр штока и диаметр штока в месте нарезки зубьев отличаются незначительно, либо совпадают. Может использоваться многократно.



11136

Codice Code Код	Min Ord Мин. количество заказа	d1	L
		Размеры	
Z-09400	1	18,65	73,00
Z-09401	1	21,40	73,00
Z-09403	1	21,87	41,00

Codice Code Код	Min Ord Мин. количество заказа	d1	L
		Размеры	
Z-09405	1	24,00	51,00
Z-09404	1	25,00	45,00
Z-09402	1	28,50	44,00

Immettitori paraoli cremagliera in plastica

Injectors in plastic for rack seals

Пластиковый защитный наконечник

IMMETTITORE TRADIZIONALE

Standard injector

Стандартный наконечник

Z-09510

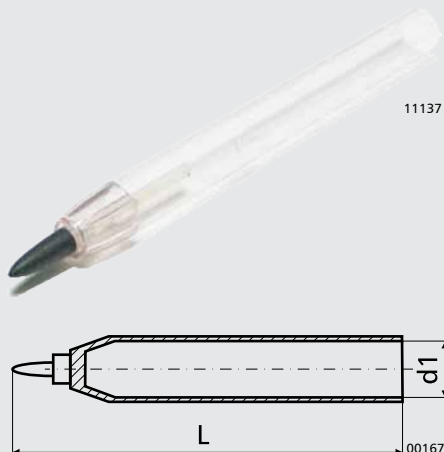

Questa attrezzatura è indispensabile per far passare il paraolio sulla dentatura delle aste cremagliera. Essendo di plastica, è molto delicata, ma il suo sistema di applicazione è rapido ed efficace. E' uno strumento tecnico ed universale e si ordina per dimensione esterna dell'albero o per modello di marca idroguida.

This tool is essential to make the seal passing over the toothing of the rack bars. Being made in plastic, it's very delicate but its application system is quick and effective. It's a technical and universal instrument and can be ordered by ext.Ø of the shaft or by power steering brand.

Изготовлен из пластика. Используется для предотвращения повреждений рабочей части сальника, когда рабочий диаметр штока и диаметр штока в месте нарезки зубьев отличаются незначительно, либо совпадают.

Codice Code Код	d1	L
	Размеры	
Z-09500	22,00	250,00
Z-09501	23,00	300,00
Z-09502	24,00	250,00
Z-09504	24,00	260,00
Z-09503	24,00	280,00
Z-09505	25,00	245,00
Z-09506	25,00	

Z-09510	Set completo Complete set
---------	------------------------------

NUOVO SISTEMA «SENSITIVE»

New injector «Sensitive»

Новый наконечник «Чувствительный»

Z-09560

ORPAV ha lanciato una gamma di immettitori di nuova generazione per il montaggio dei paraoli. Il modello tradizionale era studiato per l'utilizzo su paraoli con backing esterno (varianti V2 e V3 visibili sulla tabella dei paraoli): questo permetteva al tecnico di dividere in due pezzi il paraolio e rimontarlo dopo averlo fatto passare sopra la cremagliera. Oggi non è più possibile adottare questo sistema perché il backing del paraolio è interno e limita così lo spessore disponibile tra l'albero e la sede dello stesso backing; questa nuova linea di prodotti è chiamata "Sensitive".

ORPAV Srl introduces a new line of tools for seal assembling. The model used till today was a seal with external back ring (look at drawing variants V2 and V3 on the seals schema): this let the technician separate the seal in two parts and put it together again after having passed it on the rack. Today this system cannot be used anymore, because the backing of the seal is internal and the available space between the shaft and the backing place decreases; this new product line is called "Sensitive".

Может использоваться многократно. Преимуществами пластиковых наконечников являются: эластичность, меньшая стоимость по сравнению с металлическими аналогами, многоразовое использование в отличие от пленки и широкий выбор рабочих диаметров.



Codice Код	Albero Размер	Codice Код	Albero Размер	Codice Код	Albero Размер
Z-09521	12,00	Z-09532	25,50	Z-09544	30,00
Z-09523	14,00	Z-09534	26,00	Z-09546	31,00
Z-09520	20,00	Z-09535	26,50	Z-09548	32,00
Z-09522	21,00	Z-09536	27,00	Z-09550	33,00
Z-09524	22,00	Z-09538	27,70	Z-09552	34,00
Z-09526	23,00	Z-09540	28,00	Z-09554	35,00
Z-09528	24,00	Z-09542	29,00	Z-09556	36,00

Z-09560	Set completo Complete set
---------	------------------------------

NUOVI IMMETTITORI SPECIALI IN P.A. per paraolio F-00739

New special P.A. injectors for seal F-00739

Новые специальные наконечники для сальников

Z-09700

Questo immettitore speciale è pensato per aiutare il tecnico durante l'inserimento del paraolio all'interno dell'idroguida; essendovi una piccola differenza tra il diametro del paraolio e quello del tubo, la sua collocazione risulta poco pratica. L'attrezzo consente invece di fissare il paraolio nella posizione corretta, e di portarlo esattamente nel punto di inserimento, grazie all'asta realizzata su misura.

This special injector has been developed to help technicians while inserting the seal in the power steering; as there is a small difference between seal and tube diameters, placing the seal may result uncomfortable. Thus, the tool allows to fasten seal in the proper position, and bring it to the exact point of insertion with the appropriate rack.

Эти специальные наконечники были разработаны, чтобы помочь механикам при монтаже сальника в корпус рулевой рейки, где есть очень маленький зазор между сальником и диаметром трубы, либо если размещение сальника может быть неудобно. Этот инструмент позволяет установить сальники в правильном положении в корпусе рулевой рейки.

Attrezzature montaggio paraoli in acciaio inox

Universal assembling tools in stainless steel for seals
Комплект приспособлений для монтажа сальников

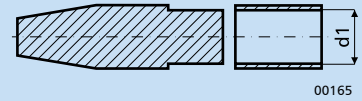

00165



A: Allargatore

Counterborer
Наконечник



B: Trascinatore

Conveyor
Конвейер

11066

Set completo Complete set Комплект	Pezzo singolo Single item Один элемент	d1 Диаметр
Z-09319	Z-09300	20,00
	Z-09301	22,00
	Z-09302	23,00
	Z-09303	24,00
	Z-09304	25,00
	Z-09305	25,50
	Z-09306	26,00
	Z-09307	26,50
	Z-09308	27,00
	Z-09309	27,70
	Z-09310	28,00
	Z-09311	29,00
	Z-09312	30,00
	Z-09312A	31,00
	Z-09313	32,00
	Z-09314	34,00
	Z-09315	35,00
Z-09316	36,00	
Z-09318	38,00	
Z-09317	40,00	

Questa attrezzatura è indispensabile per inserire qualsiasi tipo di paraolio (guarnizione o anello in PTFE) su quella parte dello stelo dove la lunghezza della filettatura metterebbe a rischio il paraolio stesso. L'attrezzatura è composta da un allargatore «A» sul quale viene infilato il trascinatore «B». Utilizzo: il paraolio viene inserito sulla parte «A», fatto scivolare fino alla parte «B», che a sua volta viene inserita sullo stelo portandola fino alla posizione desiderata. Una volta posizionata, si fa scivolare, dalla parte «B», il paraolio. Con questo sistema abbiamo oltrepassato la filettatura fino a portare il paraolio o la guarnizione nel suo alloggiamento senza tagliarlo o rovinarlo con la filettatura.

This kind of tool is used when the space between the shaft and the seal is small: for example, when you have to set a seal or a P.T.F.E. ring. The P.T.F.E. ring doesn't widen out as the rubber, so, if you try to enlarge it further, it'll lose its shape forever, ruining itself. The equipment can be used to shelter the keeping lip of the seal, when the seal has to pass on a rough or toothed surface: for example the surface of a bar or a pinion with rust or scratches.

Приспособления используются, когда необходимо установить сальник на шток до монтажа в корпус рулевой рейки при условии, что рабочий диаметр штока и диаметр штока в месте нарезки зубьев отличаются незначительно, либо совпадают.

Maschi d'acciaio super-rapido

Quick steel screw-taps
Режущий инструмент

I maschi sono formati da un attacco conico che può essere usato sia con il trapano sia manualmente. Con il trapano si ha una base conica di tipo "cono morse 2" che può essere montato con qualsiasi tipo d'ampliatore. Manualmente, può essere montato un centratore che viene avvitato nel foro anteriore. Questo centratore ha le stesse dimensioni del filetto da riprendere. I maschi si usano per riprendere i filetti rovinati dalla fuoriuscita della ghiera o del tappo posto sotto l'idroguida, di solito punzonati, che in caso di revisione sarebbero pericolosi per l'avvitamento della ghiera nuova.

These tools to thread are made up of a conical connection which can be used both on the drill and manually. With the drill you have a conical base type "Morse cone 2" which can be set with every kind of reducing cone. Manually, a centering device can be screwed in the front hole. This centering device has the same dimensions as the thread to pick up. These tools to thread are used to pick up the threads ruined by the exit of the iron ring or by the plug set under the power steering, usually punched, which would be dangerous for the screwing of the new iron ring at the overhauling.

Используется для восстановления поврежденной резьбы в месте крепления поджимной гайки, а также для обработки поврежденных поверхностей трения.

Centratori Centering devices Приспособление для центрирования

Codice Code Код	D Диаметр	Utilizzo Use remarks Примечания
Z-09152	28,00	
Z-09150	36,00	Ford Mondeo
Z-09151	38,00	Rover

Alesatori manuali Manual reamers
Развертки

Codice Code Код	d1	D	L
	Размеры		
• Z-09157A	14,00	40,00	140,00
• Z-09157B	14,10	40,00	140,00
• Z-09157C	14,20	40,00	140,00
Z-09153A	16,10	40,00	140,00
Z-09153B	16,20	40,00	140,00
Z-09153C	16,30	40,00	140,00
Z-09154A	17,10	40,00	140,00
Z-09154B	17,20	40,00	140,00
Z-09154C	17,30	40,00	140,00

Centratori per alesatori manuali Centering devices for manual
Приспособление для центрирования развертки

Codice Code Код	D Диаметр	Abbinare a Use with
• Z-09155	16,00	Z-09153A, Z-09153B, Z-09153C
• Z-09156	17,00	Z-09154B, Z-09154C, Z-09154A

Attrezzatura montaggio anelli in P.T.F.E.

Assembling tools for rings in P.T.F.E.
Приспособление для монтажа тефлоновых колец

	Codice Code Код	d1 min	d1 MAX	H
	Размеры			
	Z-09080	63,50	127,00	38,10
	Z-09081	38,10	76,20	50,80
	Z-09082	53,97	127,00	63,50
	Z-09083	76,20	127,00	

Questa attrezzatura è stata ideata per risolvere in maniera definitiva l'utilizzo di decine di inseritori diversi. Essendo regolabili si può utilizzare un singolo attrezzo per innumerevoli cilindri.

This tool has been created to solve definitively the problem of using dozens of different assembling kits. It's adjustable so you will use only one tool for lots of cylinders.

Это приспособление используется для монтажа тефлоновых колец на распределитель рулевой рейки.

Attrezzature universali montaggio anelli P.T.F.E.

Assembling tools for rings in P.T.F.E.

Приспособление для монтажа тефлоновых колец

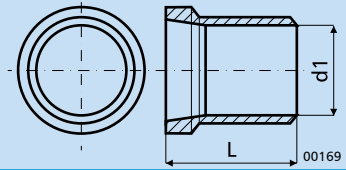

È un inseritore universale per il montaggio di tutti i segmenti in PTFE. Sappiamo che i segmenti in PTFE possono perdere la loro forma nel montaggio, con il rischio che perdano la loro tenuta e che l'olio fuoriesca dalla parte dell'anello deformato. Se il P.T.F.E. alloggia sul distributore, la deformazione non crea problemi in quanto si la pressione fa passare l'olio, ma quest'ultimo ritorna nel serbatoio senza entrare nel circuito idraulico dove, per effetto della spinta, si determina l'effetto dell'apparato, vale a dire quello di rendere il volante più morbido. Se l'anello in P.T.F.E. alloggia sulla cremagliera o sul pignone dell'idroguida, il sistema di lavoro è il medesimo descritto sopra con la sola differenza che il pistone in sito non è sollecitato a spostarsi dalla pressione come dovrebbe, perché l'olio passa dal segmento deformato diminuendo od annullando completamente la pressione in quanto la spinta idraulica non trova l'ostacolo; in altre parole, l'olio passa da una parte all'altra, non adempiendo al suo lavoro e rendendo conseguentemente il volante del veicolo rigido.



11138

Being a universal instrument, it's an essential tool for the setting of all kind of P.T.F.E. rings. We know that the P.T.F.E. rings lose their keeping once misshaped and oil passes through the ruined part. If the P.T.F.E. ring is on the distributor, pressures can pass and come back in the tank without entering the hydraulic circuit, where they carry out their aim because of the trust: making soft the car / lorry wheel. If the P.T.F.E. ring is on the rack or the pinion of the vehicle, it's the same as above with the addition that the piston has no input to move and you get the opposite effect: you feel the power steering hard in moving because the oil passes from one side to the other finding no obstacles.

Этот универсальный инструмент используется для восстановления исходного наружного диаметра тефлоновых колец на распределителе рулевой рейки.

Set completo Complete set Комплект	Pezzo singolo Single item Один элемент	d1	L	Materiale Material Материал	Descrizione per utilizzo Use remarks Примечания
		Размеры			
Z-09064	Z-09060	8,00	45,00	acciaio inox stainless steel	
	Z-09062	10,00	45,00	acciaio inox stainless steel	
	Z-09061	12,00	45,00	acciaio inox stainless steel	
	Z-09059	25,02	26,00	acciaio inox stainless steel	
	Z-09058	28,57	25,70	acciaio inox stainless steel	
	Z-09057	29,97	50,80	acciaio inox stainless steel	Pignone piccolo TRW
	Z-09056	37,34	51,70	acciaio inox stainless steel	
	Z-09050	37,97	51,00	acciaio inox stainless steel	TRW
	Z-09052	38,40	51,60	acciaio inox stainless steel	Ford
	Z-09055	39,88	58,00	acciaio inox stainless steel	saginaw
	Z-09053	41,25	88,30	acciaio inox stainless steel	TRW-Ford
	Z-09051	41,27	85,62	acciaio inox stainless steel	Ford
	Z-09054	42,72	55,70	acciaio inox stainless steel	
Z-09063	50,00	108,00	acciaio inox stainless steel		



Ganci per pannelli inox

Hooks for panels in stainless steel
Крючки для инструмента

Questi ganci sono stati creati per appendere ai pannelli in dotazione alla ns. clientela, le piccole attrezzature come chiavi, cacciaviti o utensili in qualunque posizione che devono essere comodi e in vista per lavorare in modo tecnico e veloce. Si prestano bene a contenere e sorreggere anche pesi notevoli, se correttamente inseriti nei pannelli montati sui ns. banchi da lavoro d'acciaio inox.

These hooks have been created to hang on the panels, issued to our customers, the little tools, such as spanners or screwdrivers in every position to be handy and in view to work technically and quickly. They are fit for containing and prop up also considerable weights, if correctly set in the panels placed on our stainless steel working benches.

Эти крючки используются для крепления инструмента на рабочем месте механика (Z-14000).

	Codice Code Код	Tipo Type Тип	Forma Shape Форма
 11592	Z-09111	0	Dritto Straight
 11593	Z-09112		Dritto Straight
 11594	Z-09113	B2	Dritto Straight
 11595	Z-09114	2	Curvo Curved

	Codice Code Код	Tipo Type Тип	Forma Shape Форма
 11596	Z-09115	3	Dritto doppio Double/Straight
 11597	Z-09116	7	Dritto doppio Double/Straight
 11598	Z-09117		Dritto doppio con anello Double/Straight with small ring

Estrattori per paraoli cremagliera

Rack removers for seals

Приспособление для демонтажа внутренних сальников гидроцилиндра рулевой рейки **Z-09003**

Questi ganci sono stati creati per appendere ai pannelli in dotazione alla ns. clientela, le piccole attrezzature come chiavi, cacciaviti o utensili in qualunque posizione che devono essere comodi e in vista per lavorare in modo tecnico e veloce. Si prestano bene a contenere e sorreggere anche pesi notevoli, se correttamente inseriti nei pannelli montati sui ns. banchi da lavoro d'acciaio inox.

These hooks have been created to hang on the panels, issued to our customers, the little tools, such as spanners or screwdrivers in every position to be handy and in view to work technically and quickly. They are fit for containing and prop up also considerable weights, if correctly set in the panels placed on our stainless steel working benches.

Используется для демонтажа внутренних сальников гидроцилиндра рулевой рейки без повреждения рабочей части агрегата. Представлен в трех размерах.

Modello "Tirel Fora"

Model "Tirel Fora"



11139

Set completo Complete set Комплект	Prodotto Product code Код продукта	Ricambio Spare code Код ремкомплекта	Ø min	Ø MAX
			Размеры	
Z-09003	Z-09000	Z-09000A	20,00	30,00
	Z-09001	Z-09001A	30,00	40,00
	Z-09002	Z-09002A	40,00	50,00

Estrattori per paraoli distributore

Seal removers for pignon

Приспособление для демонтажа внутренних сальников распределителя рулевой рейки **Z-09004**

Costruito in base centrale in acciai speciali e asta filettata forata interamente. Centraggio e regolazione in lega leggera con pomelli in avional. L'attrezzatura è stata studiata per poter agganciare qualsiasi tipo di paraolio, anche in serbatoi di diverse lunghezze, in modo semplice e rapido senza rovinarne la sede. È fondamentale non rovinare la sede del paraolio perché, se segnata, può provocare una minore durata dell'idroguida.

Questo strumento si utilizza per estrarre anche cuscinetti e boccole per ogni tipo di distributore, e si distingue per la praticità d'uso per le dimensioni ridotte.

Built on a central base in special steels and with a threaded, completely bored rod. Centering and adjustments in light alloy with avional knobs. This tool was designed to hook and extract any kind of oil seal, even in tanks of varying length, removing them rapidly and simply without damaging the exterior of the oil seal housing. Damage to the oil seal housing must be avoided at all cost because a scratched housing will limit life of power steering.

This tool is also used to remove bearings and bushings for any kind of pignon, and it's particularly comfortable due to its small dimensions.

Используется для демонтажа внутренних сальников распределительной части рулевой рейки без повреждения рабочей поверхности агрегата.



11578

Code prodotto Product code Код продукта	Cod. ricambio Spare code Код ремкомплекта
Z-09004	Z-09004A

Estrattori per pulegge pompa

Remover for pump pulleys

Комплект приспособлений для монтажа и демонтажа приводных шкивов и ступиц насосов гидросилителя

Z-09200

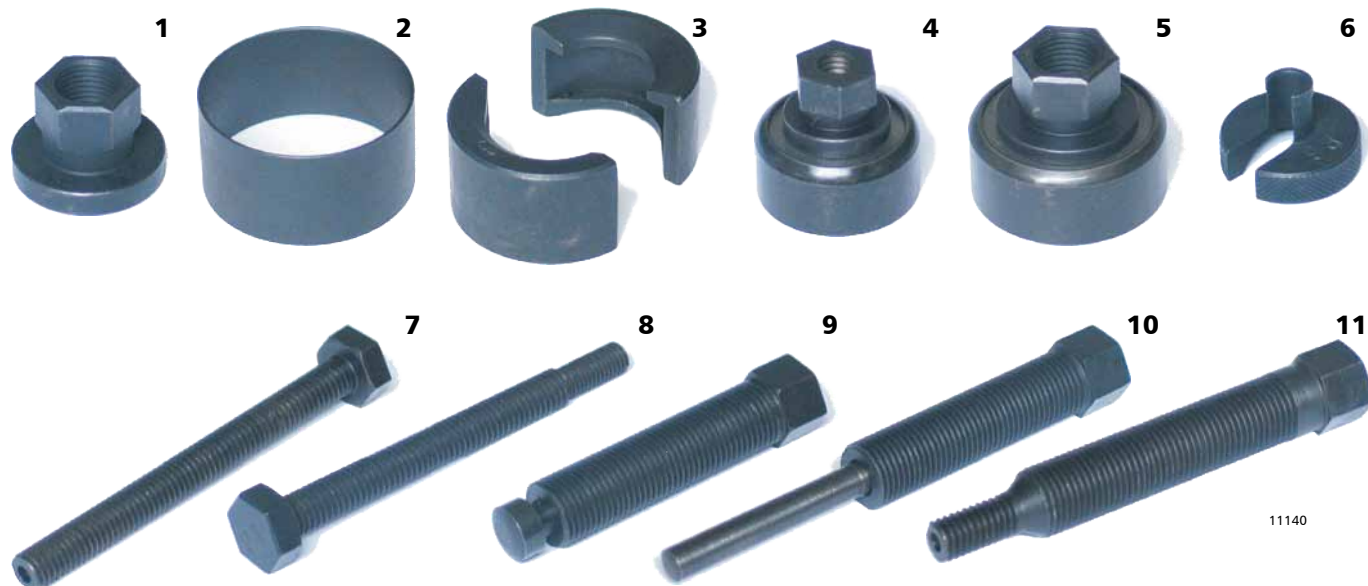

Sono attrezzature speciali ed indispensabili per estrarre e montare le pulegge delle pompe. Sono state studiate per evitare di danneggiare o rompere la puleggia. Ogni attrezzo è contrassegnato da un numero identificativo che rispecchia quello delle foto e, in caso di rottura, può essere ordinato con il codice su di esso stampato.

These are special and essential tools to pull out and set the pump pulley. They have been studied to avoid damages and the breaking of the pulley. Every tool is marked with a code which corresponds to the one of the photos and it can be ordered with this code in case of breaking.

Комплект используется для быстрого демонтажа/монтажа любого типа шкива или ступицы насоса гидросилителя без разборки самого агрегата.

Codice Code Код	Descrizione Remarks Примечания
Z-09200	Kit estrattore per pulegge pompa
Z-09200/01	Ricambio parte 1
Z-09200/02	Ricambio parte 2
Z-09200/03	Ricambio parte 3
Z-09200/04	Ricambio parte 4
Z-09200/05	Ricambio parte 5

Codice Code Код	Descrizione Remarks Примечания
Z-09200/06	Ricambio parte 6
Z-09200/07	Ricambio parte 7
Z-09200/08	Ricambio parte 8
Z-09200/09	Ricambio parte 9
Z-09200/10	Ricambio parte 10
Z-09200/11	Ricambio parte 11

Misuratori conici per o-ring e segmenti in P.T.F.E.

Conical measurers for o-rings and piston rings in P.T.F.E.
Набор мерильных конусов

Z-11000

Quante volte si tenta di rilevare una dimensione interna di un o-ring o di un P.T.F.E. e non si è mai sicuri di quanto è stato misurato? Ecco risolto il vs. problema: il ns. misuratore rigido e preciso vi mette in condizione di ovviare questo inconveniente. Voi dovete solo controllare il Ø della corda e leggere visivamente la dimensione stampata sul "gradino" tra i centinaia presenti su cui il vs. o-ring o segmento si ferma. E' indispensabile e funzionale: costruito in lega leggera si adatta a tutte le vs. necessità operative.

How many times you try to measure the internal dimension of an o-ring or a P.T.F.E. segment and you are not sure about the result? We have solved yr. problem: our stiff and precise gauge enables you to get round this inconvenience. You have only to check the thickness Ø and read the dimension printed on the "step" among the hundreds on which yr. o-ring or P.T.F.E. segment stops. It's essential and practical: manufactured in light alloy, it's suitable for all yr. operating needs.

Набор используется для определения внутренних диаметров резиновых и тефлоновых колец.



11079

Codice kit Kit code Код	Ricambio Spare code Код ремкомплекта	Descrizione Description Описание
Z-11000	Z-11000A	misuratori o-ring Ø5-Ø35
	Z-11000B	misuratori o-ring Ø36-Ø66
	Z-11000C	misuratori o-ring Ø67-Ø97
	Z-11000D	misuratori o-ring Ø98-Ø128
	Z-11000E	base per misuratori conici o-ring

Attrezzature a valigetta per prova pressione

Portable carrying cases for pressure test

Приспособление для диагностики системы гидроусилителя руля на автомобиле

Z-13000

Il BY-PASS rappresenta uno strumento indispensabile per verificare e diagnosticare tutte le problematiche inerenti gli impianti idraulici (pompa e idroguida) a bordo dell'autovettura e prima dello smontaggio. Evidenziamo la particolarissima semplicità d'uso del prodotto, tanto da poter essere maneggiato anche da meccanici con scarsa esperienza nel settore. Questo è reso possibile grazie alle tecnologie d'avanguardia adottate nello sviluppo del modello. Solo dopo la diagnosi, si smonta il particolare mandandolo in riparazione. Il modello BY-PASS è uno strumento rapido e funzionale; noi ne consigliamo l'adozione a tutta la clientela. Con questo sistema la selezione è svolta dal meccanico, per cui i particolari da revisionare arrivano già diagnosticati sulla base dei difetti riscontrati sulla macchina. Questo sistema migliora il rendimento dell'utente; esso consente inoltre di provare le idroguidate prima di smontarle e di risolvere i problemi evidenziati in fase di pre-collaudo. Preparate un questionario personalizzato e pubblicizzate BY-PASS, ne otterrete un risparmio e al tempo stesso fornirete un servizio tecnico di supporto alla vostra rete commerciale. Si può controllare il carico in Bar di pressione di qualsiasi idroguida e pompa. L'attrezzatura è corredata di:

- valigetta con manometro 250 bar;
- 2 tubi ad alta pressione con attacchi rapidi;
- kit valvole universali intercettatrici.

This test device has been developed in order to check and diagnose hydraulic system problems on-board and before disassembling. BY-PASS model, due to its cutting-edge technology, can be easily used also by unskilled mechanics without particular experience. Defective components are disassembled and repaired only after diagnosis. BY-PASS model is fast and useful; we recommend it to all our customers. Adopting this system, the mechanic makes the appropriate selection, so that the parts to be overhauled arrive after an earlier diagnosis. This system improves user productivity; moreover, it allows to test power steerings before disassembling them and solving problems highlighted during pre-test step. Advertising BY-PASS will give you the chance to save money and to supply a value-added service to your customers. BY-PASS can check pressure (in bars) of any kind of power steerings and pumps. The equipment is delivered with:

- a handy-carrying case with a 250-bar manometer;
- 2 high-pressure pipes with quick attachment couplings;
- a kit including universal interceptor valves.

Приспособление служит для диагностики агрегатов гидроусилителя руля на автомобиле без их демонтажа. Максимальное измеряемое давление 250 бар, что позволяет использовать его на любом автомобиле.



11141

Morse pneumatiche universali

Universal pneumatic vices

Универсальные пневматические тиски (пневмозахват)

Z-12000

Quante volte al giorno o al mese o all'anno voi bloccate un pezzo in una morsa? Quante volte voi dovete ruotare intorno all'idroguida per avere il pezzo nella giusta posizione per lavorare al meglio? Questa morsa ruota su se stessa di 360°. In più si può traslare di fianco al tavolo e ruotare su se stessa di 360°. La ns. morsa è girevole snodabile e regolabile nello sforzo. E' uno strumento costruito per lavorare in modo completamente diverso da com'è stato fatto fino ad oggi. Potete fare ruotare il pezzo mettendolo nella posizione per voi più comoda per vedere quello che state facendo, per smontare e rimontare senza arrecare danni. Lavorerete meglio e con meno fatica con risultati tecnici sorprendenti. La sera sarete più freschi perché grazie alla morsa risparmierete tempo e fatica!

How many times in a day or in a month or in a year you lock a piece in a vice? How many times you have to turn around the power steering to be in the right position to work in the best way? This vice rotates on itself for 360°. Moreover, you can move it sideways the bench and make it rotate for 360°. This vice is articulated and adjustable in the effort. It's a tool manufactured to work in a completely different way from how we have worked till today. You can make the piece rotating till it reaches the position more comfortable for you to see what you are doing to assemble and disassemble, causing no damages. You'll work better and with less exertion and unexpected technical remarks. In the evening you'll feel fresh because you'll save time and effort thanks to this vice!

Используются для разборки/сборки рулевых реек. Шарниры пневмозахвата позволяют разворачивать ремонтируемый агрегат в любом удобном для механика положении.



11080

Codice Code Код	Descrizione per utilizzo Use remarks Примечания
Z-12000	Morsa pneumatica universale
• Z-12000A	Guarnizione cilindro pistone per morsa pneumatica Z-12000 / 99-012

Tavoli inox

Work bench in stainless steel

Рабочий стол механика

Z-14000

Per un chirurgo il tavolo operatorio è la base del suo lavoro. Per voi tecnici e revisionatori il tavolo di lavoro è il pane quotidiano. Siamo convinti che per raggiungere un prodotto tecnico e migliorativo si debba cominciare dal rendere il lavoro più piacevole e funzionale. La comodità nel lavoro, commisurata alla produttività di un tavolo dalle prestazioni avveniristiche, porta il tecnico a risparmiare tempo ed avere un posto di lavoro sempre in ordine. Costruito interamente in acciaio inox, ha la parte centrale che riceve su di un'apposita griglia tutti i liquidi delle lavorazioni, grazie alla parte superiore inclinata verso il centro. Le sfere ed i piccoli particolari non cadranno più e l'olio non andrà più per terra ma sarà raccolto nelle apposite vasche poste sotto le griglie che saranno svuotate volta per volta.

The surgical table for a surgeon is the base of his work. The working table for you, technicians and overhaul-teams is the daily bread. We are convinced that you need to start from making the work more pleasant and practical to reach a technical and ameliorative product. The comfort while working, compared with the productivity of a bench offering futuristic performances, enables the technician to save time and to have always a tidied up working place. Completely manufactured in stainless steel, it has the central area which receives all the working fluids on a specific grate, thanks to the upper part which leans to the centre. Balls and little items will no more follow and oil will no more follow to the ground but it will be collected in the foreseen tanks under the grates, which will be emptied when needed.

Верстак является рабочим местом механика. Многолетний опыт производства специализированного инструмента для ремонта агрегатов рулевого управления позволил создать верстак, отвечающий всем требованиям самого требовательного специалиста.



11081

Chiavi di montaggio e smontaggio

Assembling and disassembling keys
Ключи и приспособления для монтажа и демонтажа

Per queste chiavi sono stati costruiti decine di modelli con impugnature comode e intercambiabili. Sono valide per il montaggio e lo smontaggio di ghiera, tappi, cuscinetti ecc. di qualunque tipo di idroguida.

We have manufactured dozens of models with different handles, comfortable and interchangeable. They can be use for to assemble and disassemble iron rings, plugs, bearings, etc. for every power steering model.

Каждое приспособление специализировано. Используются для регулировки, монтажа и демонтажа рулевых агрегатов.

Pinze e portapinze *Pincers and pincer keepers* *Клещи и хранители*

	Kit completo <i>Complete kit</i> <i>Комплект</i>	Pezzo singolo <i>Single item</i> <i>Один элемент</i>	Ø <i>Диаметр</i>
 11854	Z-09040 (comprende anche Z-09041)	Z-09042	16,00
		Z-09043	17,00
		Z-09044	18,00
		Z-09045	19,00
		Z-09046	20,00
		Z-09047	21,00
		Z-09048	22,00
		Z-09049	23,00

	Portapinza <i>Spare code</i> <i>Номер артикула</i>	Descrizione <i>Remarks</i> <i>Примечания</i>
 11853	Z-09041	attrezzatura porta pinze (parte del kit Z-09040)
	Z-09065	attrezzatura porta pinze con gambo cilindrico

Chiavi di montaggio e smontaggio *Assembling and disassembling keys* *Ключи для монтажа и демонтажа*

	Codice <i>Code</i> <i>Код</i>	Utilizzo <i>Use remarks</i> <i>Примечания</i>
 11559	Z-20014	volante di manovra per prova universale idroguida a settore Jeep e camion
 11560	Z-20015	chiave universale per montaggio e smontaggio bracci idroguida ZF
 11561	Z-20016	chiave universale per montaggio e smontaggio idroguida ZF camion 8043/44/46
 11562	Z-20017	chiave universale per smontaggio bracci idroguida a cremagliera
 11563	Z-20018	base porta attrezzatura in teflon per codice Z-02025/24/15/17/19/21/22/23
 11564	Z-20019	attrezzatura per aprire distributore Golf-Octavia- ZF/ Kojo
 11571	Z-20020	Volante universale di manovra sensibilità- idro a settore ed a cremagliera min17/mass30
 11572	Z-20021	chiave per tappo regolatore Ford Mondeo

	Codice <i>Code</i> <i>Код</i>	Utilizzo <i>Use remarks</i> <i>Примечания</i>
 11567	Z-20022	chiave per ghiera regolatore cremagliera-Rover 600-Nissan Primera-Honda civic
 11568	Z-20023	chiave per tappo cuscinetto distributore Ø27x4,9-Rover 600-Honda civic-Nissan Primera
 11569	Z-20024	braccio di leva universale per tutte le attrezzature
 11570	Z-20025	chiave per contrasto moltiplicatore di forza per attrezzature speciali
	Z-20026	chiave per tappo regolatore Ford Ka
	Z-20027	adattatore universale X chiave tappo regolatore
	Z-20028	bussola esagonale maschio da 14,3 per Ford Mondeo
	Z-20029	bussola esagonale maschio da Ø14
	Z-20030	bussola esagonale femmina da Ø18,5 per Ford Mondeo
	Z-20031	bussola esagonale femmina da Ø16,5

Cassettiere modello "Stand-by"

"Stand-by" storage system

Контейнеры для хранения комплектующих

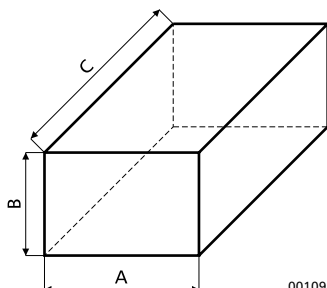

00109

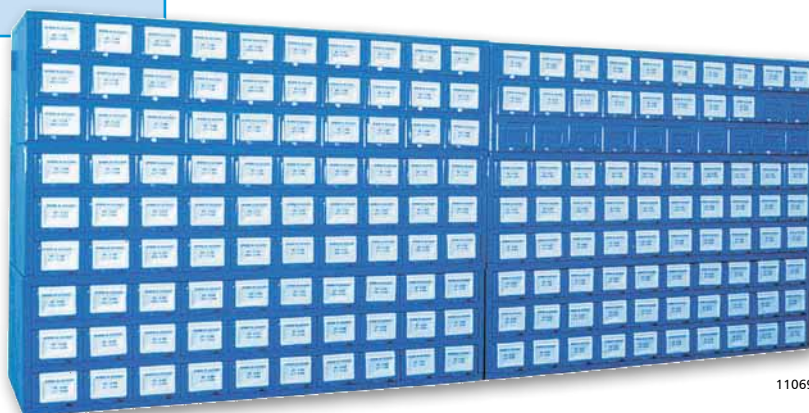

11069

Sistema composto da moduli-cassettiera componibili con elementi in acciaio antiribaltamento, come da tabella. Vengono forniti con etichettatura autoadesiva con codifica e dimensioni degli articoli ivi inseriti.

Permette sempre di avere a disposizione lo stock di materiale di consumo utile per preparare, con sistema fai da te, tutti i kit e le applicazioni più disparate. Inoltre, è possibile richiedere direttamente:

- Kit di paraoli, già ordinati per codice;
- Kit di o-ring in ordine di misura e corda;
- Kit di segmenti ordinati per codice;
- Kit di sfere in ordine di misura.

The system consists of modular components with steel elements designed not to tip over (as shown in the table above). They are equipped with self-adhesive labels already filled out with names and quantities of the articles contained within.

The system provides a constant stock of consumer materials which can be used by do-it-yourself enthusiasts to prepare all types of kits for any kind of application. In addition to what explained above, it is possible to order:

- Oil seal kits sorted by code;
- O-ring kits sorted by size or thickness;
- Segment kits sorted by code;
- Ball bearing kits sorted by size.

Конструкция состоит из модульных ячеек, что позволяет создавать как стандартные складские системы, так и индивидуальные. Система позволяет поддерживать постоянный запас комплектующих. Поставляются стандартные наборы комплектующих:

- Набор сальников, отсортированных по коду;
- Комплект резиновых колец, отсортированных по диаметру и толщине;
- Комплект тефлоновых колец, отсортированных по коду;
- Комплект стальных шаров, отсортированных по размеру.

Codice Code Код	Min Ord Мин. количество заказа	Composizione Technical detail Состав	Misure (mm)			Cod. Articolo (H=altezza totale) Код артикула
			A	B	C	
			Размеры			
Z-21000	1	30 cassetti slots	70,00	48,00	250,00	A30 / 250 (H185)
Z-21001	1	15 cassetti slots	138,00	48,00	250,00	B15 / 250 (H185)
Z-21002	1	15 cassetti slots	138,00	74,00	250,00	C15 / 250 (H255)
Z-21003	1	12 cassetti aperti open slots	172,00	93,00	250,00	D12 / 250 (H315)
Z-21004	1	12 cassetti slots	172,00	93,00	250,00	D12 / 250 (H315)
Z-21005	1	15 cassetti slots	138,00	93,00	250,00	G15 / 250 (H315)
Z-21006	1	8 cassetti slots	173,00	145,00	250,00	E8 / 250 (H315)
Z-21007	1	4 cassetti grandi big slots	342,00	145,00	250,00	F4 / 250 (H315)
Z-21008	1	10 cassetti piccoli little slots	70,00	48,00	250,00	ABC / 250 (H210)
		5 cassetti medi medium slots	138,00	48,00	250,00	
		5 cassetti grandi big slots	138,00	74,00	250,00	
Z-21009	1	Base per cassettiera "Stand-by" basement				

Calamite

Magnets
Магниты

Sono state ideate a forma di barretta telescopica e di penna per dare un aiuto al tecnico che molte volte deve intervenire prelevare, in uno spazio ristretto, sfere o piccolissimi particolari d'acciaio oppure per evitare lo "svolazzamento" di appunti o foglietti che sarebbero sempre a terra, sparsi per l'officina. In questo modo possono essere attaccati a qualsiasi pannello in acciaio e salvati dal mischiarsi o dall'essere smarriti. Mazzi altissimi di appunti che si mescolano oggi non sono più un problema.

These have been designed with the shape of a small telescope and a pen to enable the technicians to pick up spheres or miniscule steel particles in a reduced space. They are also useful to stop notes and papers from flying around and ending up on the factory floor. These magnets can be used for sticking notes to any steel panel, saving them from getting mixed up or getting lost. You no longer have the problem of having thick layers of notes getting mixed up.

Магниты представлены двумя типами: цветными и телескопическими. Цветные позволяют, благодаря своей окраске, распределить задачи сотрудников по типам важности. Телескопические магниты позволяют извлекать мелкие металлические предметы из труднодоступных мест.

	Codice Code Код	Colore Colour Цвет
	Z-22002	blu blue
	Z-22003	rossa red
	Z-22000	verde green

	Codice Code Код	Colore Colour Цвет
	Z-22001	nera black

Torsimetri

Torquemeters
Измеритель крутящего момента **Z-10000**

Il torsimetro è uno strumento indispensabile per riparare e revisionare ogni tipo d'idroguida a cremagliera e a settore. La sensibilità centesimale vi consentirà di scegliere la sfera maggiorata prima di smontare il tutto e di regolare la giusta pressione di contrasto di regolazione lungo tutta l'escursione dell'asta. Il nostro torsimetro vi permetterà di bilanciare e tarare in modo omogeneo la vostra idroguida, ottenendo un prodotto altamente tecnico. L'esperienza dei nostri tecnici ha permesso di realizzare un prodotto che vi aiuterà nella messa a punto di idroguida meccanicamente perfette (bilanciate e prive di giochi e tensioni).



The torquemeter is an essential tool to revise and overhaul every kind of rack and sector power steering. The centesimal sensibility will let you choose the correct raised ball before disassembling all and settle the right contrast pressure of regulation along the bar travel. Our torquemeter will enable you to balance and calibrate yr. power steering in a homogeneous way, obtaining a highly technical product. Our technicians' experience let us realize this product which will help you to set up perfect power steering from a mechanical point of view (balanced and with no clearances and tensions).

Используется для измерения крутящего момента при затяжке резьбовых соединений.

Codice Code Код	Ø Диаметр	Descrizione per utilizzo Use remarks Примечания
Z-10000		Torsimetro completo con comparatore centesimale
• Z-10011		Ricambio: Volantino
• Z-10012		Ricambio: Impugnatura
• Z-10013		Ricambio: Porta blocchetto millerighe
• Z-10014		Ricambio: Comparatore
• Z-10015	10,00	Ricambio: Blocchetto per millerighe grezzo

Codice Code Код	Ø Диаметр	Descrizione per utilizzo Use remarks Примечания
Z-10016	14,50	Ricambio: Blocchetto per millerighe
Z-10017	16,80	Ricambio: Blocchetto per millerighe
Z-10018	17,50	Ricambio: Blocchetto per millerighe
Z-10019	18,60	Ricambio: Blocchetto per millerighe
Z-10020	24,00	Ricambio: Blocchetto per millerighe
Z-10021	25,50	Ricambio: Blocchetto per millerighe

Attrezzature prova di tenute

Equipments for keeping test

Прибор для тестирования рулевых реек при помощи воздуха **Z-15000**



Molti tecnici pensano che, per avere la sicurezza che il loro lavoro sia stato eseguito bene, le idroguidie debbano essere testate alle alte pressioni. In certi casi questa teoria è esatta, ma in altri è un errore. Quando la pressione dell'olio colpisce lo spigolo di tenuta del paraolio, quest'ultimo cambia la posizione di lavoro e non è detto che questa posizione sia perfetta. In posizione di riposo, quando il motore è fermo, il paraolio torna nella sua posizione iniziale e questa posizione non viene mai controllata, sebbene il paraolio, quando viene montato il momento più delicato di tutto il lavoro è nella posizione di riposo. Se nella posizione di riposo il labbro di tenuta del paraolio è rovinato, l'olio fuoriesce goccia a goccia riempiendo le cuffie. Per evitare questo inconveniente e darvi la certezza che i pezzi siano stati controllati e supereranno il test finale sul banco idraulico, si esegue la prova di tenuta. Questa prova consiste nel simulare, con un dispositivo elettronico, una certa pressione -bassa- con manometri digitali centesimali sensibilissimi e verificare se ci sono delle perdite. La prova può durare 10, 20 o 30 secondi in base al grado di sicurezza che si vuole ottenere. I colori del display, in caso d'emergenza, diventano rossi lampeggianti e ciò significa che ci sono perdite. Se le luci diventano di colore verde, tutto è OK e l'idroguida o la pompa hanno superato il test di tenuta. Superato questo test si passa al test idraulico. Questo passaggio è importante perché nel caso in cui il ns. test dovesse rivelare che il pezzo non è idoneo, permette di smontarlo prima dell'immissione dell'olio evitando il rischio di rovinare paraoli e o-ring nuovi. Vi assicuriamo che qualsiasi ditta, prima di vendere un prodotto tecnico, deve avere la certezza matematica che il suo prodotto sia privo di difetti e di perdita d'olio.

Many technicians think that power steering has to be tested at high pressures to be sure that their work has been done correctly. Sometime it's true but sometime is a mistake. When the oil pressure hits the oil seal tightness edge, the seal changes its work position which is not always correct. At rest, when the engine is stopped, the oil seal come back in its starting position and this position is never checked although when the oil seal is set the most delicate moment all the work is at rest. If the oil seal tightness edge is damaged at rest, oil will exit little by little, filling the gaiters. To avoid this inconvenience and to give you the certainty that pieces have been checked and that they'll pass the final test on the hydraulic test bench, you do the tightness test. By doing this test, you simulate, through an electronic device, a low pressure thanks to the centesimal digital manometers, very sensitive, and you can verify if there are leaks. The test can last for 10, 20 or 30 seconds depending on the security level you want. The colors on the display became flashing red in case of emergency (if there are leaks) while they become green if everything is fine and the power steering or the pump has passed the tightness test. Then you pass to the hydraulic test. This passage is important because it enables you, in case of no conformity of the part, to disassemble it before inserting the oil, avoiding in this way the risk of ruining new oil seals and o-rings. We grant you that every factory has to be absolutely sure that its product has no faults and oil loss before selling it.

Прибор используется для определения герметичности гидроцилиндров рулевых реек с помощью давления воздуха.

Проведение теста на герметичность: после сборки рейки с помощью штуцеров к ней подключается магистраль высокого давления данного прибора. В проверяемом гидроцилиндре создается давление, после чего компрессор отключается. По истечении 10, 20, 30 секунд (в зависимости от заданного теста) прибор отразит ситуацию о наличии утечки воздуха, т.е. о герметичности гидроцилиндра. В случае недопустимой утечки воздуха загорится красная лампочка.

Codice Code Код	Descrizione per utilizzo Use remarks Примечания
Z-15000	Attrezzatura prova di tenute
• Z-15001	Attrezzatura prova di tenute - 110V



Attrezzature prova di sforzo

Equipments for effort test

Пневмоцилиндр со станиной

Questa attrezzatura è stata ideata per testare, sotto sforzo, le condizioni di bilanciamento ideali dell'idroguida a cremagliera e la costanza nei suoi movimenti. Si simula il montaggio sull'attrezzatura e nello stesso tempo si provano le pressioni di mandata e ritorno, prima dello smontaggio e della revisione per una diagnosi completa. Solo dopo avere rilevato i difetti ed avere eseguito questo passaggio obbligato, si può effettuare la prova idraulica. L'attrezzatura è composta da un pistone pneumatico ed un manometro con regolatore di pressione ed attacchi rapidi universali per l'aggancio della cremagliera.

This equipment has been planned to test under stress the excellent balancing conditions of the rack power steering and the constancy in movement. You simulate the assembling on the equipment and, at the same time, you test the delivery and return pressures, before the disassembling and the revision to get a complete analysis. Only after having found the damages and carried out this fixed operation, you can proceed with the hydraulic test. The equipment is made up of a pneumatic piston and a manometer with a pressure governor and a universal quick connection for the rack hooking.

Оборудование состоит из пневматического цилиндра, специальных захватов рулевой рейки и станины. Используется вместе с гидравлическим стендом для диагностики рулевых реек. Позволяет создать осевую нагрузку, аналогичную нагрузке на автомобиле.

	Codice Code Код	Descrizione per utilizzo Use remarks Примечания
	Z-16000	Attrezzatura prova di sforzo Пневмоцилиндр со станиной
	Z-16001	Attrezzatura prova di sforzo e attrezzatura montaggio/smontaggio Alfa 159 Специальная станина для рулевой рейки Alfa 159

Codice Code Код	d1	d2	D	h1	H	Descrizione per utilizzo Use remarks Примечания
	Размеры					
• Z-16000/07	20,00	45,00	60,00	4,50	25,00	boccola in P.A. per Z-16000
• Z-16000/08	25,00	45,00	60,00	4,50	25,00	boccola in P.A. per Z-16000
• Z-16000/09	28,00	45,00	60,00	4,50	25,00	boccola in P.A. per Z-16000
• Z-16000/10	21,00	45,00	60,00	4,50	25,00	boccola in P.A. per Z-16000
• Z-16000/11	22,00	45,00	60,00	4,50	25,00	boccola in P.A. per Z-16000
• Z-16000/12	23,00	45,00	60,00	4,50	25,00	boccola in P.A. per Z-16000
• Z-16000/13	24,00	45,00	60,00	4,50	25,00	boccola in P.A. per Z-16000
• Z-16000/14	26,00	45,00	60,00	4,50	25,00	boccola in P.A. per Z-16000
• Z-16000/15	27,00	45,00	60,00	4,50	25,00	boccola in P.A. per Z-16000
• Z-16000/16	29,00	45,00	60,00	4,50	25,00	boccola in P.A. per Z-16000
• Z-16000/17	30,00	45,00	60,00	4,50	25,00	boccola in P.A. per Z-16000



Manicotti per inserimento seger

Assembling tools for segers

Комплект для монтажа стопорных колец

Z-09620

Questa attrezzatura è stata realizzata per poter trasferire i seger nella loro sede naturale senza recare danno alla parte cromata della cremagliera. Tale attrezzo è composto da un inseritore (mod. A) e da un trascinatore (mod. B).

This tool has been developed in order to allocate segers into their natural seats without risking to cause problems to the chromate part of the rod. Such instrument is formed by an inserter (mod. A) and a conveyor (mod. B).

Предназначен для монтажа стопорных колец поршней, штоков рулевых реек, имеющих V-образный поджим.



Mod. B: Trascinatore

Conveyor
Конвейер



Mod. A: Inseritore

Inserter
Наконечник

11424

Set completo Complete set Номер комплекта	Prodotto Product code Код продукта	Ø Диаметр
Z-09620	Z-09600	20,00
	Z-09601	22,00
	Z-09602	23,00
	Z-09603	24,00
	Z-09604	25,00
	Z-09605	25,70
	Z-09606	26,00
	Z-09607	26,70
	Z-09608	27,00
	Z-09609	27,70
	Z-09610	28,00
	Z-09611	29,00
	Z-09612	30,00
	Z-09612A	31,00
	Z-09613	32,00
	Z-09614	34,00
	Z-09615	35,00
	Z-09616	36,00
Z-09617	38,00	
Z-09618	40,00	

Kit di attrezzi per la riparazione "Seal Toolkit"

Kit for reparation and overhauling

Комплект для монтажа и демонтажа резиновых и тефлоновых колец

Z-20001

Il SEAL TOOL KIT è un valido aiuto per i tecnici montatori a riparatori di attrezzature oleodinamiche, pneumatiche o micromeccanica di precisione. L'uso degli utensili diventerà presto familiare e la sua praticità lo renderà per voi insostituibile e vi eviterà di impiegare utensili non adatti o improvvisati.

(A) UTENSILE CON LEVA A FACCIA PIATTA: è utilizzabile per rimuovere guarnizioni e o-ring, o per installarli nella cava.

(B) UTENSILE CON LEVA AD ANGOLO: è utilizzabile per rimuovere guarnizioni e o-ring da cavità o punti recessi facendo leva dal fondo della cava.

(C) UTENSILE PERFORANTE: è utilizzabile per rimuovere **guarnizioni** e **o-ring** da cavità o punti recessi. Questo utensile va impiegato quando la guarnizione da togliere può essere distrutta.

(D) UTENSILE A PUNTA DRITTA: adatto alla rimozione ed installazione di guarnizioni ed o-ring collocati vicino alla superficie, è utilizzabile anche come utensile di appoggio agli altri quando si lavora con due utensili contemporaneamente.

(E) UTENSILE PREMENTE/TIRANTE: è l'utensile "jolly" del kit. La particolare conformazione della punta permette molti impieghi: può infatti agganciare, posizionare, spingere o tirare la guarnizione, oppure premerla per portarla in sede senza rovinarla spingendo con il "tallone".

SEAL TOOLKIT is a great help for engineers who assemble or repair hydraulic, pneumatic equipment or precision micro-mechanic products. The use of such tools will soon become familiar, their practicality will make them irreplaceable and will avoid to use inadequate or adapted tools.

(A) TOOL WITH FLAT FACE LEVER: This tool can be used to remove or install seals and o-rings.

(B) TOOL WITH ANGLED LEVER: can be used to remove seals and o-rings from cavities or from recessed positions by prying from the bottom of the groove inserting the tip.

(C) PIERCING TOOL: can be used to remove seals and o-rings from cavities or from recessed positions when the seal can be destroyed and discarded.

(D) FLAT TIP TOOL: Can be used for the installation or removal of seals and o-rings near the surface, is also usable as "back-up" tool in combination with other tools.

(E) PUSHING/PULLING TOOL: This is the "jolly" tool of the kit, the particular tip configuration allows many uses: can hook up, positioning, push or pull seals or pressing them into their seats pushing with the tool heel.

Комплект специальных приспособлений для быстрого монтажа/демонтажа стопорных, резиновых и тефлоновых колец. Комплект изготовлен из высокопрочного материала.

(A) ИНСТРУМЕНТ С ПЛОСКИМ РЫЧАГОМ: Этот инструмент может быть использован для удаления или установки сальников и уплотнительных колец.

(B) ИНСТРУМЕНТ С УГЛОВЫМ РЫЧАГОМ: Может быть использован для удаления сальников и уплотнительных колец из полостей.

(C) ИНСТРУМЕНТ: Может быть использован для удаления сальников и уплотнительных колец из труднодоступных полостей. После использования он может быть поврежден.

(D) Может быть использован для установки или удаления сальников и уплотнительных колец вблизи поверхности, также может быть использован, как "запасной" инструмент в сочетании с другими инструментами.

(E) Этот инструмент имеет конфигурацию наконечника, который имеет много применений: он может толкать и тянуть сальник.

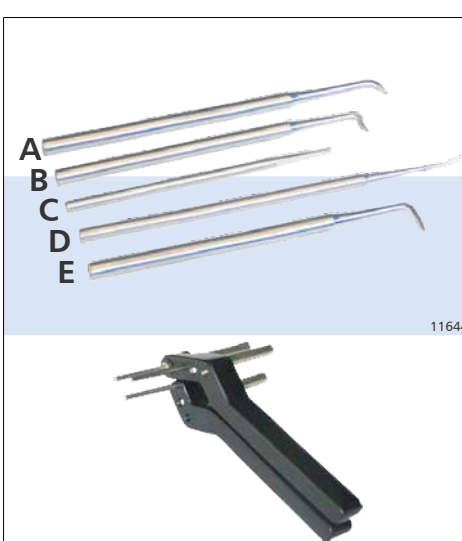
	Codice kit Kit code Код	Ricambio Spare part Код ремкомплекта	Parte Part	Modello Version Модель	Descrizione per utilizzo Use remarks Примечания
	Z-20001	Z-20002	A	Grande <i>Big</i>	Utensile con leva a faccia piatta
		Z-20003	E	Grande <i>Big</i>	Utensile con leva ad angolo
		Z-20004	D	Grande <i>Big</i>	Utensile perforante
		Z-20005	C	Grande <i>Big</i>	Utensile a punta piatta dritta
		Z-20006	B	Grande <i>Big</i>	Utensile premente/tirante
		Z-20007	Z-20008	A	Piccolo <i>Small</i>
	Z-20009		E	Piccolo <i>Small</i>	Utensile con leva ad angolo
	Z-20010		D	Piccolo <i>Small</i>	Utensile perforante
	Z-20011		C	Piccolo <i>Small</i>	Utensile a punta piatta dritta/pinzetta
	Z-20012		B	Piccolo <i>Small</i>	Utensile premente/tirante
	Z-20013				

Bordatori per pistoni

Flanging discs for piston mounting

Приспособление для монтажа поршня гидроцилиндра



Z-17000

11292

Rappresenta un attrezzo indispensabile per ribordare i pistoni centrali di qualsivoglia diametro. Esso è indispensabile per tutte le idroguida che presentano la parte di dentatura più grande, nelle quali il paraolio laterale non può essere sostituito se non si rimuove il pistone centrale. Oltre a questo, le rotelle-bordatore possono essere utilizzate per ribordare i pistoni centrali delle autovetture (come le Ford), nei casi in cui questi iniziano a muoversi, causando rumori (il gioco sulle dentature, ad esempio, provoca il classico suono di "battito").

It's a very important tool to re-flange central pistons of any diameter. A must-have instrument for steerings with a bigger toothed part, where lateral seal cannot be substituted without removing central piston. Moreover, flanging discs can be used on cars (such as Ford), in case pistons begin moving from their seat, causing noises (the movement on the toothed part, for example, causes the classic "blink" sound).

Инструмент используется для завальцовки боковой кромки поршней рулевых реек, имеющих V-образный поджим.

Attrezzature piega-tubi

Tube-folding equipment

Приспособление для изготовления трубок высокого давления

Z-26000

Attrezzatura speciale per piegare, modellare e riprodurre ogni tipo di tubo in acciaio per idroguida, sia esso di andata o di ritorno.

Special equipment to fold, mould and reproduce any kind of power steering tube in steel, both outward or return.

Используется для изготовления наконечников трубок высокого давления.



11846

Lampade e ricambi

Lamps and spare parts
Фонарик

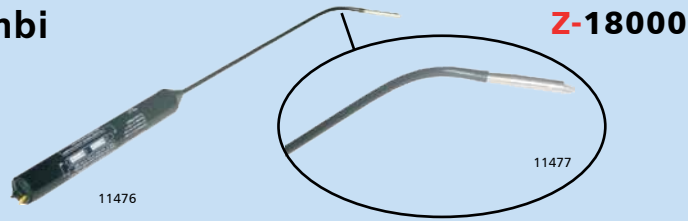

Questa attrezzatura è stata concepita per illuminare e visionare le zone più interne dell'idroguida; in questo modo è possibile intervenire sulle diverse parti in tutta sicurezza e senza correre il rischio di cagionare danni. Può accadere infatti che, senza una corretta illuminazione, il tecnico commetta errori di valutazione danneggiando, ad esempio, le pareti di tenuta.

This tool has been studied to lighten the darkest and most remote sites into power steering; this way it's much easier to safely plan reparations, without risking to cause damages. Without a proper light, it may happen that technicians make mistakes on steering body damaging, for example, areas devoted to oil keeping.

Служит для освещения труднодоступных частей рулевой рейки.

	Codice Code Код	Descrizione per utilizzo Use remarks Примечания
	Z-18000	lampada flessibile con prolunga e custodia <i>лампа с гибким удлинителем</i>
	Z-18000A	ricambio per lampada <i>запасная лампа</i>
	Z-18001	penna con luce, tipo stilo <i>световое перо</i>
	Z-18001A	ricambio batteria xcod. Z-18001 <i>запасной аккумулятор код Z-18001</i>
	Z-18002	lampadina con gancio <i>шарик с крюком</i>

Attrezzatura a cannocchiale

Spyglass tool
Оптическое оборудование



Trattasi di un'attrezzatura a cannocchiale con luce snodata, che permette di entrare nei tubi e nelle cavità più remote ed anguste. Dispone di apposita batteria per l'illuminazione autonoma; lunghezza operativa: 600 mm; diametro esterno del tubo snodabile: 8 mm. Grazie alle speciali ottiche di cui è dotata, è possibile vedere facilmente anche le più piccole soffiature; inoltre può equipaggiare un deflettore a 90°. È uno strumento indispensabile per l'estrazione e l'inserimento dei paraoli in sede.

It's a spyglass with supple light, that allows to get into tubes and most remote hollows. It is equipped with a special battery for independent lightning; operative length: 600 mm; tube exterior diameter: 8 mm. Specific opticals allow to easily see even very small blisters; moreover, it can install a 90° deflector for lateral sight. This is a must-have tool for seal extraction and installation into their seats.

Данное оборудование позволяет рассмотреть недоступные глазу части рулевой рейки.

	Codice Code Код	Descrizione per utilizzo Use remarks Примечания
	Z-19000	Attrezzatura a cannocchiale <i>Оптическое оборудование</i>
●	Z-19000A	Occhiali tecnici per attrezzatura a cannocchiale <i>Очки для телескопа</i>
●	Z-19000B	Lente a 90° per attrezzatura a cannocchiale <i>Линзы для объектива телескопа</i>

Attrezzatura a cannocchiale con telecamera Z-19001

Spyglass tool with camera
Видеозонд с камерой



11651

Questa attrezzatura presenta caratteristiche analoghe alla precedente Z-19000, con in più il fatto di avere una telecamera ad alta definizione per un livello ancora superiore di qualità dell'immagine. Tramite l'apposito kit, è anche possibile effettuare registrazioni e trasferire i file su computer. È uno strumento indispensabile per l'estrazione e l'inserimento dei paraoli in sede.

This tool has similar features to the previous product presented (Z-19000), but enhanced with a high-definition monitor for an even better image quality. Using the add-in kit, you can also perform recordings and transfer video files to a computer. This is a must-have tool for seal extraction and installation into their seats.

Данное оборудование позволяет увидеть недоступные глазу части рулевой рейки.

Codice Code Код	Descrizione per utilizzo Use remarks Примечания
Z-19001	Cannocchiale con telecamera
● Z-19001A	Cannocchiale con telecamera, possibilità di zoom e trasferimento dati su PC - 1h di registrazione

Kit di registrazione e monitoraggio senza fili Z-19002

Wireless recording and monitoring tool
Беспроводная камера с возможностью видеозаписи

Strumento rivoluzionario composto da una telecamera digitale di ridottissime dimensioni, luce incorporata e tecnologia di trasmissione immagini "senza fili" su un monitor a distanza.

Consente di registrare a colori tutte le fasi di una ispezione interna da svolgersi, ad esempio, su un ammortizzatore o un'idroguida, e trasferire a distanza su un computer tutti i contributi realizzati su computer.

This revolutionary tool is formed by a very compact digital camcorder, with internal light and a wireless transfer protocol; this allows users to recorder a variety of technical processes, including shock absorber or power steering inspection, and then download videos into a PC.

Данное устройство позволяет создать видеозапись о диагностике и ремонте рулевой рейки и предоставить клиенту полный видеоотчет о проделанной работе.



11650

Penne elettriche per marcatura su metallo

Electric pens to engrave metals

Электрические ручки для маркировки на металле

Z-19003

11855



Penna elettrica potenziata a regolazione elettronica per incidere materiali metallici ferrosi conduttori. È uno strumento molto utile in quanto consente di marcare il vostro prodotto e di incidere date certe onde evitare, ad esempio, l'erogazione di servizi di garanzia non dovuti. Il pezzo da marcare va appoggiato sulla base superiore della carcassa permettendo così l'incisione per resistenza elettrica; una regolazione elettronica permette di ottenere la potenza di incisione desiderata. Pennino in tungsteno.

Electric pen with electronic tuning to engrave conductor metallic metals based on iron. It is a very useful equipment because it allows to leave permanent tracks on your product and put certain dates, in order to avoid, just to make an example, to supply services that should not be covered by guarantee. The item to engrave must be placed on the upper surface so that engraving may be done through electric resistance; an electronic regulation allows to obtain the proper engraving power. Pen in tungsten.

Электрическая ручка - это очень полезное оборудование, которое позволяет оставлять следы на агрегате. Например, дату покупки или ремонта, чтобы избежать оказания услуг, которые не должны быть выполнены по истечении гарантии.

Codice Code Код	Descrizione per utilizzo Use remarks Примечания
● Z-19003	penna elettrica per marcatura su metallo
● Z-19004	attrezzatura per marchiare metalli con tampone in plastica, composta da box metallico ad alimentazione elettrica + tampone in plastica porta marchietti

Strumenti di diagnosi per automezzi

Diagnosis tools for vehicles

Диагностические инструменты для автомобиля

Codice Code Код	Descrizione per utilizzo Use remarks Примечания
● Z-24000	strumento di diagnosi AXONE 3 + OBD + access point Wi-Fi
● Z-24001	strumento di diagnosi DIRECT + OBD + access point Wi-Fi + docking station
● Z-24001A	ricambio: access point Wi-Fi per Z-24001
● Z-24001B	ricambio: testa AXONE DIRECT
● Z-24001C	ricambio: docking station per Z-24001
● Z-24001D	ricambio: Z-24001B+Z-24001C ricambio composto dalla testa AXONE DIRECT+docking station
● Z-24003	adattore per cavi Europa per Z-24000
● Z-24004	adattore per cavi Europa per Z-24001
● Z-24005	cavi Europa per Z-24000 e 24001

Centratori universali per sensori di coppia

Universal centring devices for torque sensors

Приспособление для центрирования датчика положения руля



11784

Nella costante ricerca delle migliori soluzioni per i nostri clienti, abbiamo il piacere di introdurre questo nuovo strumento professionale che si aggiunge al già nutrito gruppo di attrezzatura la diagnostica.

Il nostro centratore per sensori è pratico e semplice da usare, funziona con tutti gli sterzi elettrici di produzione Delphi a 6 e 7 fili, e con le guide Mitsubishi montate sulle vetture Opel; non sarà quindi più necessario svolgere lunghe ed imprecise sessioni di test al volante per identificare il punto zero, ma occorrerà semplicemente applicare lo strumento al sensore per effettuare le rilevazioni in maniera rapida e precisa.

Il centratore viene consegnato con i cavi di connessione specifici per ciascun tipo di sensore, ed è disponibile sia con alimentazione europea, sia a 110V per gli standard americani.

In the constant research of the best solutions for our customers, we are pleased to introduce this new professional instrumentation, that is the latest among a wide group of tools for diagnostics.

Our brand-new portable centering device is efficient and easy to use, it works on all Delphi 6- and 7-pin EPS, and also with Mitsubishi steering assembled on Opel cars.

With this important tool there is no more need to make long and inaccurate test sessions in front of the steering wheel to find point zero: now technician just has to apply the tool to the torque sensor to perform the whole operation quickly and precisely.

The sensor balancer is delivered fully equipped with custom cables to connect all sensors, and is available with both European and American power connection.

В постоянном поиске лучших решений для наших клиентов мы рады представить новый профессиональный прибор для центрирования датчика положения руля. Наше новое портативное устройство является эффективным и простым в использовании. Работает со всеми Delphi 6 и 7 поколения, а также с Mitsubishi, собранными на Opel. С этим инструментом больше нет необходимости совершать длительные и точные тесты рулевой колонки для поиска нулевой точки: теперь механик просто должен подсоединить датчик крутящего момента для выполнения всей операции быстро и точно. Данное приспособление поставляется вместе с набором кабелей для подключения к датчикам и может быть подключено в сеть, как с европейским, так и с американским типом разъема.

Codice Code Код	Descrizione per utilizzo Use remarks Примечания
● Z-24100	attrezzatura centraggio sensori universale elettronica con 3 display per Opel Corsa B, C, D, Meriva, Fiat Punto, Grande Punto, 500, Panda, Lancia Y
● Z-24100C	cavo per connessione sensore Delphi 8 poli
● Z-24100D	cavo per connessione sensore Delphi 6 poli
● Z-24100E	cavo per connessione sensore Mitsubishi
● Z-24100F	cavo per connessione sensore Fiat 600 4 poli
● Z-24100G	cavo per connessione sensore Opel Agila, Suzuki Ignis
● Z-24101	attrezzatura centraggio sensori universale elettronica con 2 display (110V, 60Hz)
● Z-24200	pinza per crimpare (contatti, capocorda, ecc.)
● Z-24201	valigetta completa di pinza per crimpare i contatti (inserti esclusi)
● Z-24202	inserti per pinza Z-24200
● Z-24500	Strumento diagnosi SOCIO 310 con 1 anno di abbonamento incluso

Codice Code Код	Descrizione per utilizzo Use remarks Примечания
 ● Z-24102	Attrezzatura per centraggio sensori "Economy" per Fiat Punto II serie

11847

Banchi prova per sterzi elettrici a colonna «Vinci»

Test bench for EPS columns «Vinci»

Диагностические стенды для рулевых колонок с электроприводом

Questo innovativo e brevettato banco prova, controllato da un computer, è creato per controllare e testare la colonne elettriche prima e dopo la revisione/riparazione. Si può controllare facilmente il sistema di sterzaggio simulando condizioni di guida con varie velocità e carichi. Tutti i test possono essere salvati e stampati. Opzionalmente è possibile avviare una sequenza di test completamente motorizzata.

Il banco prova viene fornito con i dati di una vasta gamma di modelli di auto e un kit di cavi per la connessione. Quando nuovi modelli vengono introdotti nel mercato, viene aggiornato il database dei modelli e, se necessario, si provvede all'invio del relativo connettore. È possibile ordinare il banco prova con un computer di diagnosi Texa oppure connettere il vostro sistema utilizzando la presa OBD montata sul banco.

Il banco è necessario per ogni compagnia che lavora seriamente nel settore della revisione idroguida. Notate che nei prossimi 5/8 anni quasi tutte le piccole e medie auto utilizzeranno un sistema EPS!

Vinci is a universal, patented, multiple-brand test bench for electric power steering columns (EPS) with CAN-BUS simulation. This brand new system, controlled by a computer, is made to check and test electric power steering columns before and after revision or repair. You can easily check the steering system under driving conditions with various speeds and load simulations. All your tests and results can be saved and printed. Optionally you can run a completely automated test sequence.

The test bench comes with a wide range of car model data and a connection cable kit. As new models appear in the market your database will be updated and you'll receive the suitable connector. You can order the test bench with a TEXA diagnose computer or connect your device by using the OBD socket mounted on the test bench.

This bench is a "must have" for every company which works seriously in the sector of steering revision. Please note that during the next 5 up to 8 years nearly all small and medium cars will use an EPS system!

Стенд является универсальным, запатентованным. Это совершенно новая система, управляемая компьютером, сделана для проверки и испытания рулевых колонок с электроприводом до и после ремонта.

Вы можете легко проверить агрегат при условиях движения с различной скоростью и нагрузкой моделирования. Все тесты и результаты могут быть сохранены и распечатаны. При желании вы можете запустить полностью автоматический тест.

Этот стенд должна иметь каждая компания, которая работает серьезно в секторе ремонта рулевых агрегатов. Пожалуйста, обратите внимание, что в течение следующих 5-8 лет почти все малые и средние автомобили будут использовать системы электрического рулевого управления.



11852

Codice Code Код	Descrizione per utilizzo Use remarks Примечания
• Z-25000	VINCI: Banco prova per servosterzi elettrici composto da 2 computer: il primo contiene i dati di tutte le auto del mondo (europee/americane/giapponesi), il secondo fornisce il software gestionale per effettuare il test. Nell'offerta è compreso il corso.
• Z-25001	VINCI: Banco prova per servosterzi elettrici VERSIONE AUTOMATICA composto da 2 computer: il primo contiene i dati di tutte le auto del mondo (europee/americane/giapponesi), il secondo fornisce il software gestionale per effettuare il test. Nell'offerta è compreso il corso.
• Z-25100	Kit automazione per banco prova servosterzi elettrici VINCI

Guida al corretto assemblaggio delle pompe elettriche

How to properly assemble electric pumps
Правила сборки насосов гидроусилителя с электроприводом

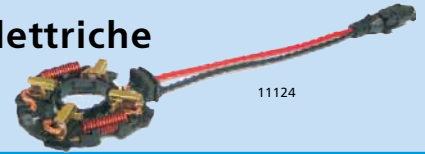

Codice Code Код	Utilizzo Use remarks Примечания	Seguire la guida nei passaggi Read and follow steps... Читать и следовать пошагово
V-04020 V-04021 V-04022	Peugeot 106/Saxo/Renault	1 2 3
V-04023 V-04024 V-04025	Mercedes Classe A	3 4

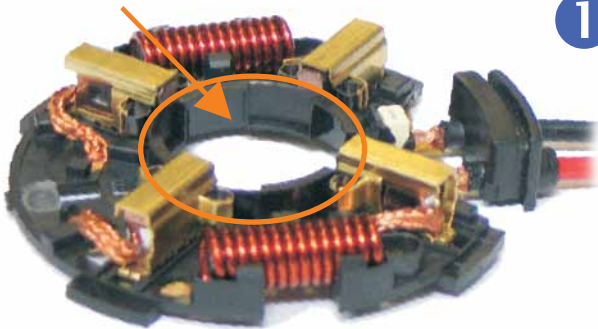

V (pag. 182/42)

1

La piastra dispone di un anello di plastica che tiene le quattro spazzole in posizione di lavoro. Esso va tolto solo quando si inserisce l'albero, **e in nessun caso prima di tale operazione.**

The plate has a plastic ring which keeps the 4 brushes in the working position and has to be taken away only when the shaft is inserted. Please never take it out before.

Щеточный узел. При его монтаже ограничивающее пластиковое кольцо необходимо извлекать только лишь после установки узла в рабочее положение.

ATTENZIONE!

WARNING!

ВНИМАНИЕ!

2

Se non viene osservato questo procedimento, le spazzole e le relative mollette poste nella pompa elettrica fuoriescono dalla loro sede, come mostrato nella figura a sinistra.

If you do not strictly follow these steps, the brushes situated inside the pump will go out of their working place, as shown in the figure on the left.

Если пластиковое кольцо извлечено ранее установки узла в рабочее положение, щеточный узел может быть поврежден.



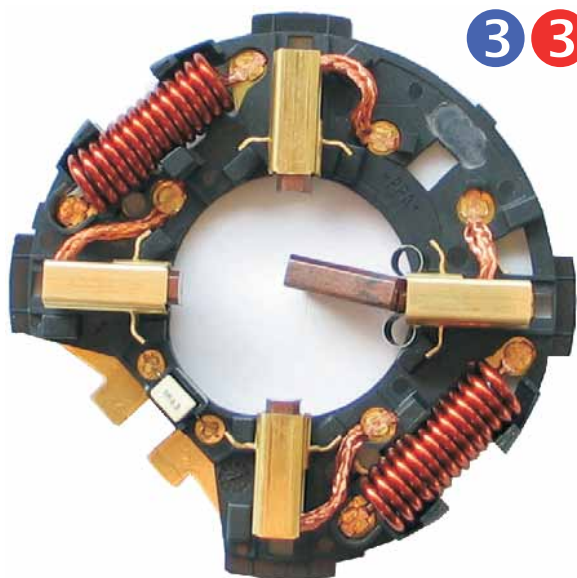

3 3

La piastra principale della pompa elettrica è composta da 4 spazzole con molla in acciaio inox; esse vanno inserite nelle apposite sedi, nelle quali la molletta spinge la spazzola verso il rotore. **ATTENZIONE: è possibile montare la molla per UN SOLO verso**, come indicato nello schema sotto.

*The electric pump main plate is composed by 4 brushes with springs in stainless steel; such brushes shall be placed into their seats, where spring pushes the brush towards the rotor. **WARNING! These springs have a unique assembling side**, as shown below.*

Щетки в щеточный узел необходимо вставлять в определенном положении, как показано на рисунке.

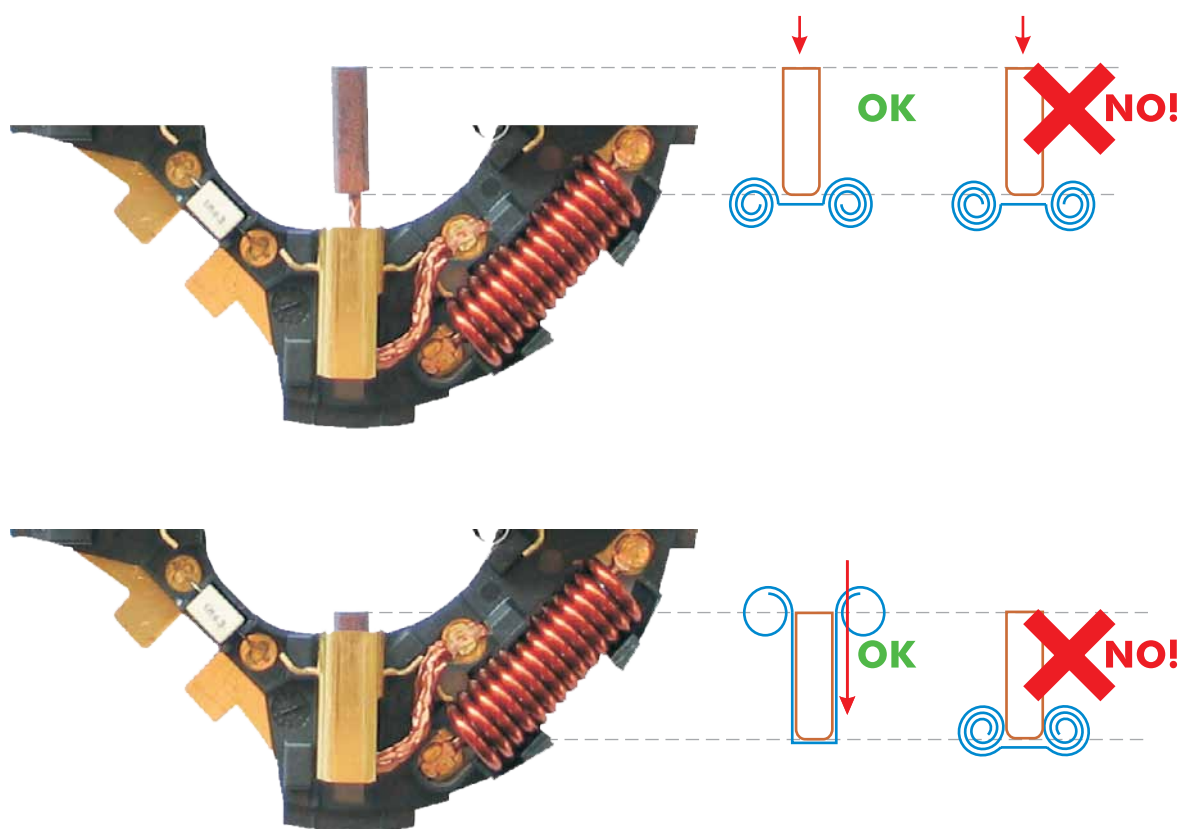

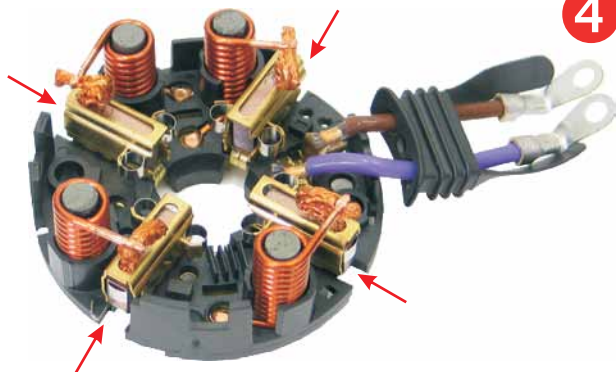

4

Le spazzole sono tenute a pressione all'interno della loro sede. Per completare la revisione, dopo il montaggio è sufficiente premere leggermente verso il centro della piastra, consentendo così l'allineamento delle spazzole.

Brushes are held in pressure into their seats. To complete the overhaul, after installation process you just need to push slightly to the center of the plate (as shown in the figure on the left), so that brushes can align.

Для установки щеток в рабочее положение необходимо нажать на точки, указанные на рисунке.

Sistema di smontaggio e montaggio idroguidate con parte dentatura cremagliera più grande della parte cromata

Assembling and disassembling system for power steering units which have the toothed part of the rack with a diameter bigger than the chromium-plated part

Инструкция монтажа и демонтажа поршней рулевых реек, у которых диаметр зубчатой части превышает посадочный диаметр сальника



1

Si mette la cremagliera sul tornio e si taglia con l'utensile il bordo in acciaio del pistone sigillato.

You put the rack on the lathe and you cut the steel edge of the sealed piston by using the tool.

Первая операция, которую необходимо выполнить - это срезать отбортовочную кромку поршня и удалить поршень.



Appendici

Appendix
Приложение

- 2** Una volta che si è tolto il pistone dalla cremagliera, si taglia il seger senza farlo passare sulla parte cromata altrimenti l'acciaio del seger, che è molto duro, può rigare la cremagliera. Poi si può togliere il paraolio vecchio.

Once you have taken off the piston from the rack you cut the seger avoiding to let it pass on the chromium-plated part otherwise the stainless steel part of the seger, which is very hard, may furrow the rack. You can take away the old oil seal.

Далее необходимо удалить стопорные кольца со штока.



- 3** Si prende il preservativo con il \varnothing della cremagliera e si monta il paraolio sul ferro che farà scorrere il paraolio senza che questo si rovini sugli spigoli delle gole del seger.

You use the "condom" with the same rack diameter and you assemble the seal on the iron which will let the seal slide without damages caused by the seger grooves edges.

Произвести монтаж нового сальника на шток.



Appendici

Appendix
Приложение

- 4** Una volta che il paraolio è in posizione di riposo, si usa un preservativo speciale per il seger nuovo che si porta nella sua posizione naturale senza che questo danneggi la parte cromata dell'asta. Attenzione non far scorrere il seger sull'asta perché la righerebbe.

Once the seal is in its position, there is a special "condom" for the new seger which will be taken in its natural position avoiding it to damage the bar chromium-plated part. Pay attention not to let the seger slide on the bar otherwise the seger will furrow it.

Установить новые стопорные кольца на рабочие места.





K (pag. **170** /42)

5

Una volta che il seger è in questa posizione si monta il pistone nuovo e, con l'apposita rotella-bordatore per pistoni (Z-17000, pag. 287), si procede alla bordatura sul tornio. **ATTENZIONE:** tale operazione deve essere svolta in modo preciso, **altrimenti si rischia il passaggio di olio sotto il pistone.**

*Once the seger is in its proper seat, you can install the new piston and, using a specific flanging disc (Z-17000, page 287), perform the flanging process on lathe. **WARNING:** such procedure must be completed very precisely, otherwise **you may risk to generate an oil flow under the piston.***

Установить новый поршень на рабочее место и отбортовать с помощью инструмента Z-17000.



Z-17000 (pag. **287** /42)



Kit di modifica schede elettroniche Mercedes Classe A

Kit to overhaul electronic device of Mercedes Class A
Комплект для ремонта электронных устройств от Mercedes класса A

Questo kit è stato predisposto per by-passare la scheda bruciata (o comunque non funzionante), in modo tale da consentire alla pompa di riprendere la propria funzionalità. Per una corretta riparazione è sempre importante che tutti gli altri componenti siano stati testati prima.

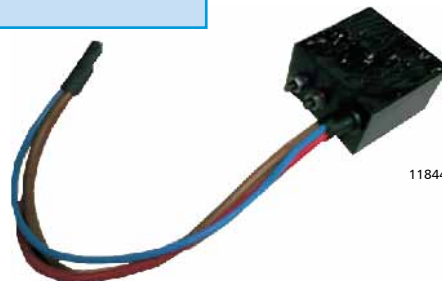

ATTENZIONE! Questo kit consente di intervenire in modifica sulle schede elettroniche, ma non costituisce un pezzo unico già pronto all'uso. ORPAV S.r.l. declina dunque ogni responsabilità, incluso, ma non limitato, ad un utilizzo improprio del prodotto che può comportare una errata riparazione o comportamenti errati della pompa.

This kit has been manufactured to by-pass the burned (or anyway not working properly) electronic device, in order to allow pump to recover functionality. For a correct overhaul it is always necessary that all other components have been properly tested before.

ATTENTION! This kit allows technicians to intervene on electronic devices, but it is not sold as unique, ready-to-use item. Therefore, ORPAV S.r.l. disclaims all responsibility, including, but not limited to, an improper use of the product that may entail a wrong repair or improper behaviours of the pump.

Этот комплект был изготовлен для ремонта насосов с электроприводом Mercedes класса A. Необходимо помнить, что для правильного ремонта данных изделий нужно проверять все без исключения части насоса, в противном случае ORPAV не несет ответственности за ремонт.



Estintori istantanei Fire Antigen

Instant extinguishers Fire Antigen
Мгновенный огнетушитель

ORPAV è sempre alla ricerca di tecnologie innovative e soluzioni all'avanguardia. In anteprima mondiale, siamo veramente orgogliosi di presentare Fire Antigen, l'estintore istantaneo che apre una nuova era nella prevenzione e nel contrasto agli incendi.

Le caratteristiche di questi estintori sono assolutamente straordinarie:

- funzionano efficacemente in tutte le condizioni climatiche, anche nelle più avverse;
- sono leggeri, facili da trasportare e non richiedono alcuna precauzione per lo stoccaggio;
- non sono sensibili ai colpi, né a materiali nelle vicinanze, e non si innescano a catena;
- le dimensioni compatte li rendono utilizzabili anche in ambienti particolarmente angusti;
- l'installazione può essere svolta da chiunque, non è necessaria alcuna preparazione specifica;
- una volta installati non richiedono l'intervento umano;
- agiscono in pochi attimi, limitando drasticamente i danni materiali alle cose;
- e non meno importante, contrariamente a tutti i prodotti precedentemente concepiti, non contengono parti o componenti tossici.

Mettete subito al sicuro la vostra officina e la vostra abitazione con Fire Antigen!

ORPAV is constantly focused in finding innovative technologies and state-of-art solutions. In a first-ever, world-wide preview, we are really proud to introduce Fire Antigen, the instant extinguisher that opens a new era in prevention and fire fighting.

The features of such extinguishers are definitely outstanding:

- *they work in all weather conditions, even in the most adverse;*
- *they are light, easy to transport and do not require any specific care for stocking;*
- *they are not susceptible to shocks or materials in proximity, and do not chain reacts;*
- *their compact sizes make them usable also into particularly narrow places;*
- *installation can be performed by anyone, no specific knowledge is required;*
- *once installed, they do not require any other human intervention;*
- *since they act in a few seconds, they limit most consequential damages to the environment;*
- *and last but not least, unlike all previously conceived products, they do not contain toxic parts or components.*





Secure now your machine shop and your home with Fire Antigen!

ORPAV всегда в поиске инновационных технологий и современных решений. Впервые на мировом рынке мы представляем мгновенный огнетушитель Fire Antigen. Он предназначен, как для тушения пожара, так и его предотвращения.

Особенности огнетушителей Fire Antigen:

- *работают в любых погодных условиях, даже в самых неблагоприятных;*
- *имеют малый вес, легко переносятся, не требуют особых условий хранения;*
- *не чувствительны к удару и окружающим материалам;*
- *компактный размер делает их пригодными для использования даже в очень узких пространствах;*
- *установка может быть выполнена любым человеком, и не требует специальной подготовки;*
- *после установки не требуют вмешательства человека;*
- *срабатывает в течение нескольких секунд и, что немаловажно, в отличие от всех ранее разработанных продуктов, не содержит токсичных частей и компонентов.*



	Codice Code Код	Taglio Size Вес	Classi incendio Fire classes Классы пожара		Descrizione per utilizzo Use remarks Примечания
			Europee	Americane	
 11789	Z-90001	1 kg	ABC	A	Estintore polivalente, adatto al trattamento delle principali tipologie d'incendio <i>Polyvalent extinguisher, suitable to treat most fire types</i> Многоцелевой огнетушитель, подходящий для тушения основных типов возгорания
 11790	Z-90003	1 kg	E	C	Estintore specifico per incendi da materiale elettrico <i>Extinguisher specific for fires involving electric parts</i> Специальный огнетушитель для тушения электрического оборудования
 11791	Z-90201	5 kg	ABC	A	Estintore polivalente (linea professionale) <i>Polyvalent extinguisher (professional line)</i> Многоцелевой огнетушитель (профессиональная линия)
 11792	Z-90202	5 kg	BC	B	Estintore specifico per idrocarburi (linea professionale) <i>Hydrocarbon-specific extinguisher (professional line)</i> Для огня от конкретных углеводородов (профессиональная линия)